

ETSI TS 136 523-1 V11.4.0 (2013-10)



Technical Specification

**LTE;
Evolved Universal Terrestrial Radio Access (E-UTRA) and
Evolved Packet Core (EPC);
User Equipment (UE) conformance specification;
Part 1: Protocol conformance specification
(3GPP TS 36.523-1 version 11.4.0 Release 11)**



ReferenceRTS/TSGR-0536523-1vb40

Keywords

LTE

ETSI

650 Route des Lucioles
F-06921 Sophia Antipolis Cedex - FRANCE

Tel.: +33 4 92 94 42 00 Fax: +33 4 93 65 47 16

Siret N° 348 623 562 00017 - NAF 742 C
Association à but non lucratif enregistrée à la
Sous-Préfecture de Grasse (06) N° 7803/88

Important notice

Individual copies of the present document can be downloaded from:

<http://www.etsi.org>

The present document may be made available in more than one electronic version or in print. In any case of existing or perceived difference in contents between such versions, the reference version is the Portable Document Format (PDF). In case of dispute, the reference shall be the printing on ETSI printers of the PDF version kept on a specific network drive within ETSI Secretariat.

Users of the present document should be aware that the document may be subject to revision or change of status. Information on the current status of this and other ETSI documents is available at

<http://portal.etsi.org/tb/status/status.asp>

If you find errors in the present document, please send your comment to one of the following services:

http://portal.etsi.org/chaicor/ETSI_support.asp

Copyright Notification

No part may be reproduced except as authorized by written permission.
The copyright and the foregoing restriction extend to reproduction in all media.

© European Telecommunications Standards Institute 2013.
All rights reserved.

DECT™, **PLUGTESTS™**, **UMTS™** and the ETSI logo are Trade Marks of ETSI registered for the benefit of its Members.
3GPP™ and **LTE™** are Trade Marks of ETSI registered for the benefit of its Members and
of the 3GPP Organizational Partners.
GSM® and the GSM logo are Trade Marks registered and owned by the GSM Association.

Intellectual Property Rights

IPRs essential or potentially essential to the present document may have been declared to ETSI. The information pertaining to these essential IPRs, if any, is publicly available for **ETSI members and non-members**, and can be found in ETSI SR 000 314: "*Intellectual Property Rights (IPRs); Essential, or potentially Essential, IPRs notified to ETSI in respect of ETSI standards*", which is available from the ETSI Secretariat. Latest updates are available on the ETSI Web server (<http://ipr.etsi.org>).

Pursuant to the ETSI IPR Policy, no investigation, including IPR searches, has been carried out by ETSI. No guarantee can be given as to the existence of other IPRs not referenced in ETSI SR 000 314 (or the updates on the ETSI Web server) which are, or may be, or may become, essential to the present document.

Foreword

This Technical Specification (TS) has been produced by the ETSI 3rd Generation Partnership Project (3GPP).

The present document may refer to technical specifications or reports using their 3GPP identities, UMTS identities or GSM identities. These should be interpreted as being references to the corresponding ETSI deliverables.

The cross reference between GSM, UMTS, 3GPP and ETSI identities can be found under <http://webapp.etsi.org/key/queryform.asp>.

Contents

Intellectual Property Rights	2
Foreword.....	2
Foreword.....	24
Introduction	24
1 Scope	25
2 References	25
3 Definitions, symbols and abbreviations	27
3.1 Definitions	27
3.2 Abbreviations	28
4 Overview	28
4.1 Test methodology	28
4.1.1 Testing of optional functions and procedures	28
4.1.2 Test interfaces and facilities.....	28
4.2 Implicit testing.....	28
4.3 Repetition of tests.....	28
4.4 Handling of differences between conformance requirements in different releases of cores specifications.....	28
5 Reference conditions	29
5.1 Generic setup procedures	29
6 Idle mode operations	29
6.0 Introduction	29
6.0.1 PLMN and TAC	29
6.0.2 Other	30
6.0.2.1 Values of parameters calculated by the UE.....	30
6.1 In a pure E-UTRAN environment	30
6.1.1 PLMN selection	30
6.1.1.1 PLMN selection of RPLMN, HPLMN/EHPLMN, UPLMN and OPLMN / Automatic mode	30
6.1.1.1a PLMN selection / Automatic mode/between FDD and TDD.....	34
6.1.1.1b PLMN selection of RPLMN, HPLMN/EHPLMN, UPLMN and OPLMN / Automatic mode / Single Frequency operation.....	38
6.1.1.2 PLMN selection of "Other PLMN/access technology combinations" / Automatic mode.....	41
6.1.1.2a PLMN selection of "Other PLMN/access technology combinations" / Automatic mode / Single Frequency operation.....	45
6.1.1.3 Cell reselection of ePLMN in manual mode	47
6.1.1.3a Cell reselection of ePLMN in manual mode / between FDD and TDD.....	49
6.1.1.3b Cell reselection of ePLMN in manual mode / Single Frequency operation	52
6.1.1.4 PLMN selection in shared network environment / Automatic mode	53
6.1.1.4a PLMN selection in shared network environment / Automatic mode / Between FDD and TDD	56
6.1.1.5 Void.....	60
6.1.1.6 PLMN selection of RPLMN, HPLMN/EHPLMN, UPLMN and OPLMN / Automatic mode / User reselection	60
6.1.1.6a PLMN selection of RPLMN, HPLMN/EHPLMN, UPLMN and OPLMN / Automatic mode / User reselection / Single Frequency operation.....	64
6.1.1.7 PLMN selection / Periodic reselection / MinimumPeriodicSearchTimer	67
6.1.2 Cell selection and reselection.....	70
6.1.2.1 Void.....	70
6.1.2.2 Cell selection / Qrxlevmin	70
6.1.2.2a Cell selection / Qqualmin.....	73
6.1.2.3 Cell selection / Intra E-UTRAN / Serving cell becomes non-suitable (S<0 or barred).....	77
6.1.2.3a Cell selection / Intra E-UTRAN / Serving cell becomes non-suitable (Srxlev > 0 and Squal < 0).....	81
6.1.2.4 Cell reselection.....	85
6.1.2.5 Cell reselection for interband operation	87

6.1.2.6	Cell reselection using Q_{hyst} , Q_{offset} and $T_{\text{reselection}}$	90
6.1.2.7	Cell reselection / Equivalent PLMN	95
6.1.2.7a	Cell reselection / Equivalent PLMN / Single Frequency operation	99
6.1.2.8	Cell reselection using cell status and cell reservations / Access control class 0 to 9	102
6.1.2.8a	Cell reselection using cell status and cell reservations / Access control class 0 to 9 / Single Frequency operation.....	106
6.1.2.9	Cell reselection using cell status and cell reservations / Access control class 11 to 15	110
6.1.2.9a	Cell reselection using cell status and cell reservations / Access control class 11 to 15 / Single Frequency operation.....	115
6.1.2.10	Cell reselection in shared network environment	119
6.1.2.11	Inter-frequency cell reselection.....	122
6.1.2.12	Cell reselection / Cell-specific reselection parameters provided by the network in a neighbouring cell list.....	124
6.1.2.13	Cell reselection, $S_{\text{intrasearch}}$, $S_{\text{nonintrasearch}}$	127
6.1.2.14	Speed-dependent cell reselection	132
6.1.2.15	Inter-frequency cell reselection according to cell reselection priority provided by SIBs.....	136
6.1.2.15a	Inter-frequency cell reselection according to cell reselection priority provided by SIBs / Between FDD and TDD.....	141
6.1.2.15b	Inter-band cell reselection according to cell reselection priority provided by SIBs.....	146
6.1.2.16	Cell reselection / interband operation / Between FDD and TDD	148
6.1.2.17	Cell reselection for Squal to check against $S_{\text{IntraSearchQ}}$ and $S_{\text{nonIntraSearchQ}}$	153
6.1.2.18	Inter-frequency cell reselection based on common priority information with parameters $\text{Thresh}_{X, \text{HighQ}}$, $\text{Thresh}_{X, \text{LowQ}}$ and $\text{Thresh}_{\text{Serving, LowQ}}$	160
6.1.2.19	Intra-frequency cell reselection / MFBI	164
6.1.2.20	Inter-frequency cell reselection / MFBI	168
6.1.2.21	Inter-band cell reselection / MFBI	170
6.2	Multi-mode environment (E-UTRAN, UTRAN, GERAN, CDMA2000).....	174
6.2.1	Inter-RAT PLMN selection	174
6.2.1.1	Inter-RAT PLMN Selection / Selection of correct RAT for OPLMN / Automatic mode.....	174
6.2.1.2	Inter-RAT PLMN Selection / Selection of correct RAT for UPLMN / Automatic mode.....	179
6.2.1.3	Inter-RAT PLMN Selection / Selection of correct PLMN and RAT in shared network environment / Automatic mode.....	181
6.2.1.4	Inter-RAT PLMN Selection / Selection of correct RAT from the OPLMN list / Manual mode.....	185
6.2.1.5	187
6.2.1.6	Inter-RAT Background HPLMN Search / Search for correct RAT for HPLMN / Automatic Mode	187
6.2.2	Inter-RAT cell selection.....	189
6.2.2.1	Inter-RAT cell selection / From E-UTRA RRC_IDLE to UTRA_Idle / Serving cell becomes non-suitable	189
6.2.2.2	Inter-RAT cell selection / From E-UTRA RRC_IDLE to GSM_Idle/GPRS Packet_idle / Serving cell becomes non-suitable	194
6.2.2.3	Inter-RAT Cell selection / From E-UTRA RRC_IDLE to HRPD Idle / Serving cell becomes non-suitable	200
6.2.2.4	Inter-RAT Cell selection / From E-UTRAN RRC_IDLE to 1xRTT idle / Serving cell becomes non-suitable	203
6.2.2.5	Cell selection / No USIM.....	206
6.2.2.6	Inter-RAT Cell selection / From GSM_Idle/GPRS Packet_idle to E-UTRA_RRC_IDLE / Serving cell becomes non-suitable.....	208
6.2.2.7	Inter-RAT Cell selection / From GSM_Idle/GPRS Packet_idle to E-UTRA_RRC_IDLE ,when the serving cell is barred.	209
6.2.2.8	Inter-RAT cell selection / From UTRA_Idle to E-UTRA RRC_IDLE / Serving cell becomes non-suitable.....	211
6.2.3	Inter-RAT cell reselection	217
6.2.3.1	Inter-RAT cell reselection / From E-UTRA RRC_IDLE to GSM_Idle/GPRS Packet_Idle.....	217
6.2.3.1a	Inter-RAT cell reselection / From E-UTRA RRC_IDLE to GSM_Idle/GPRS Packet_Idle (Squal < $\text{Thresh}_{\text{Serving, LowQ}}$, Srxlev > $\text{Thresh}_{X, \text{LowP}}$ and Srxlev > $\text{Thresh}_{X, \text{HighP}}$)	222
6.2.3.2	Void.....	227
6.2.3.3	Inter-RAT cell reselection / From UTRA_Idle to E-UTRA RRC_IDLE.....	227
6.2.3.3a	Inter-RAT cell reselection / From UTRA_Idle to E-UTRA RRC_IDLE (QualminEUTRA, Squal _{ServingCell} < $\text{Thresh}_{\text{Serving, low2}}$, Squal _{nonServingCell,x} > $\text{Thresh}_{X, \text{low2}}$ and Squal _{nonServingCell,x} > $\text{Thresh}_{X, \text{high2}}$)	232
6.2.3.4	Inter-RAT cell reselection / From UTRA_CELL_PCH state to E-UTRA RRC_IDLE.....	239

6.2.3.4a	Inter-RAT cell reselection / From UTRA_CELL_PCH state to E-UTRA RRC_IDLE based on RSRQ+RSRP evaluation.....	243
6.2.3.5	Inter-RAT cell reselection / From E-UTRA RRC_IDLE to UTRA_Idle.....	250
6.2.3.5a	Inter-RAT cell reselection / From E-UTRA RRC_IDLE to UTRA_Idle (Squal > Thresh _{X, HighQ} , Squal < Thresh _{Serving, LowQ} , Squal > Thresh _{X, LowQ} and S _{nonIntraSearchQ})	253
6.2.3.6	Inter-RAT cell reselection / From E-UTRA RRC_IDLE to UTRA_Idle according to RAT priority provided by dedicated signalling.....	261
6.2.3.7	Inter-RAT cell reselection / From E-UTRA RRC_IDLE to HRPD Idle / HRPD cell is higher reselection priority than E-UTRA	270
6.2.3.7a	Inter-RAT cell reselection / From E-UTRA RRC_IDLE to HRPD Idle / HRPD cell is higher reselection priority than E-UTRA (Srxlev > Thresh _{HRPD, HighP}).....	275
6.2.3.8	Inter-RAT cell reselection / From E-UTRA RRC_IDLE to HRPD Idle / HRPD is lower reselection priority than E-UTRA	280
6.2.3.8a	Inter-RAT cell reselection / From E-UTRA RRC_IDLE to HRPD Idle / HRPD cell is lower reselection priority than E-UTRA (Squal < Thresh _{Serving, LowQ} and Srxlev > Thresh _{HRPD, LowP}	285
6.2.3.9	Inter-RAT Cell Reselection: from E-UTRA RRC_IDLE to CDMA2000 1xRTT Dormant– When CDMA2000 1xRTT cell is higher reselection priority than E-UTRA	290
6.2.3.9a	Inter-RAT cell reselection / From E-UTRA RRC_IDLE to 1xRTT Dormant / 1xRTT cell is higher reselection priority than E-UTRA (Srxlev > Thresh _{1xRTT, HighP})	295
6.2.3.10	Inter-RAT Cell Reselection: from E-UTRA RRC_IDLE to CDMA2000 1xRTT Idle – When CDMA2000 1xRTT is lower reselection priority than E-UTRA	300
6.2.3.10a	Inter-RAT cell reselection / From E-UTRA RRC_IDLE to 1xRTT Dormant / 1xRTT cell is lower reselection priority than E-UTRA (Squal < Thresh _{Serving, LowQ} and Srxlev > Thresh _{1xRTT, LowP}).....	305
6.2.3.11	Void.....	311
6.2.3.12	Void.....	311
6.2.3.13	Inter-RAT cell reselection / From UTRA_Idle to E-UTRA RRC_IDLE according to RAT priority provided by dedicated signalling.....	311
6.2.3.14	Inter-RAT Cell Reselection / from GSM_Idle/GPRS Packet_Idle to E-UTRA (priority of E-UTRA cells are higher than the serving cell)	318
6.2.3.15	Inter-RAT Cell Reselection / from GSM_Idle/GPRS Packet_Idle to E-UTRA (priority of E-UTRA cells are lower than the serving cell)	321
6.2.3.16	Inter-RAT Cell Reselection / from GSM_Idle to E-UTRAN /based on H_Prio criteria	323
6.2.3.17	Inter-RAT Cell Reselection / from GSM_Idle/GPRS Packet_Idle to E-UTRA (priority E-UTRA cells).....	326
6.2.3.18	Inter-RAT Cell Reselection / from GSM_Idle/GPRS Packet_Idle to E-UTRA (blacklisted E-UTRA cells)	328
6.2.3.19	Redirection to E-UTRA upon the release of the CS connection	330
6.2.3.20	Void.....	333
6.2.3.21	Inter-RAT cell reselection / From GPRS Packet_Transfer (NC0 mode) to E-UTRA.....	333
6.2.3.22	Void.....	335
6.2.3.23	Inter-RAT Cell Reselection from GPRS Packet transfer to E-UTRA in CCN Mode(PACKET CELL CHANGE CONTINUE)	335
6.2.3.24	Inter-RAT Cell Reselection from GPRS Packet transfer to E-UTRA in CCN Mode (PACKET CELL CHANGE ORDER)	338
6.2.3.25	Void.....	341
6.2.3.26	Inter-RAT Autonomous Cell Reselection GPRS Packet_transfer to E-UTRA (NC1 mode).....	341
6.2.3.27	Inter-RAT Cell selection from GPRS Packet_transfer to E-UTRA (NC2 Mode).....	344
6.2.3.28	Inter-RAT Cell Reselection from GPRS Packet_transfer to E-UTRA (Network Assisted Cell Change)	348
6.2.3.29	Inter-RAT cell Reselection from GPRS packet_transfer to E-UTRA in CCN mode (PACKET MEASUREMENT ORDER).....	352
6.2.3.30	Inter-RAT Cell Reselection failure from GPRS Packet transfer to E-UTRA (Network Assisted Cell Change)	356
6.2.3.31	Inter-RAT cell reselection / From UTRA_Idle (low priority) to E-UTRA RRC_IDLE (high priority) according to RAT priority provided by dedicated signalling.....	361
6.2.3.32	Inter-RAT cell reselection / From E-UTRA RRC_IDLE to UTRA_Idle, S _{nonintraSearch}	367
6.2.3.33	Inter-RAT cell reselection / From E-UTRA RRC_IDLE to UTRA_Idle / Squal based cell reselection parameters are broadcasted in E-UTRAN / UE does not support Squal based cell reselection in UTRAN.....	371
6.3	Closed Subscriber Group cells	374

6.3.1	Inter-frequency cell reselection / From E-UTRA RRC_IDLE non-CSG cell to E-UTRA RRC_IDLE CSG cell.....	374
6.3.2	Inter-RAT cell reselection / From GSM_Idle/GPRS Packet_Idle to E-UTRA idle CSG cell	378
6.3.3	Inter-RAT cell reselection / From UTRA_Idle to E-UTRA RRC_IDLE CSG cell.....	383
6.3.4	Inter-RAT cell reselection / From UTRA CELL_PCH state to E-UTRA RRC_IDLE CSG cell	390
6.3.5	Manual support for CSG ID selection.....	396
6.3.6	Ignoring CSG cells in cell selection/reselection when allowed CSG list is empty or not supported	401
6.3.7	Inter-RAT Cell reselection from E-UTRA idle non-CSG cell to a UTRA CSG cell.....	405
6.3.8	Inter-RAT CSG Cell Reselection from E-UTRA CSG cell to UTRA CSG cell.....	411
6.3.9	Manual CSG ID selection across PLMNs.....	418
6.3.10	Intra-Frequency cell selection / From E-UTRA_Idle to E-UTRA RRC_IDLE / CSG cell on same PLMN as previously visited CSG cell	421
6.3.11	Inter-RAT cell reselection / From UTRA_Idle to E-UTRA RRC_IDLE / CSG cell on same PLMN as previously visited CSG cell	426
6.3.12	Inter-RAT cell selection / From E-UTRA RRC_IDLE to UTRA_Idle / CSG cell on same PLMN as previously visited CSG cell	432
6.4	Hybrid cells	436
6.4.1	Manual CSG ID selection / Hybrid cell whose CSG ID is not in the Allowed CSG list nor Operator's list	436
6.4.2	Inter-frequency cell reselection / From E-UTRA RRC_IDLE non-CSG cell to E-UTRA RRC_IDLE member hybrid cell	440
6.4.3	Inter-RAT cell reselection / From E-UTRA RRC_IDLE non-CSG cell to UTRA_Idle member hybrid cell	445
6.4.4	Inter-RAT cell reselection / From E-UTRA RRC_IDLE non-member hybrid cell to UTRA_Idle member hybrid cell	450
6.4.5	Inter-RAT cell reselection / From UTRA_Idle to E-UTRA RRC_IDLE member hybrid cell	457
6.4.6	Inter-RAT cell reselection / From UTRA CELL_PCH to E-UTRA RRC_IDLE member hybrid cell.....	463
6.4.7	Inter-RAT cell reselection / From GSM_Idle/GPRS Packet_Idle to E-UTRA RRC_IDLE member hybrid cell	469
7	Layer 2.....	475
7.1	MAC.....	475
7.1.1	Mapping between logical channels and transport channels	475
7.1.1.1	CCCH mapped to UL SCH/ DL-SCH / Reserved Logical Channel ID	475
7.1.1.2	DTCH or DCCH mapped to UL SCH/ DL-SCH / Reserved Logical Channel ID	478
7.1.2	RACH	482
7.1.2.1	Correct selection of RACH parameters / Random access preamble and PRACH resource explicitly signalled to the UE by RRC / Non-contention based random access procedure	482
7.1.2.2	Correct selection of RACH parameters / Random access preamble and PRACH resource explicitly signalled to the UE in PDCCH Order / Non-contention based random access procedure ..	485
7.1.2.3	Correct selection of RACH parameters / Preamble selected by MAC itself / Contention based random access procedure	487
7.1.2.4	Random access procedure / Successful.....	492
7.1.2.5	Random access procedure / MAC PDU containing multiple RARs	498
7.1.2.6	Maintenance of uplink time alignment.....	501
7.1.2.7	MAC contention resolution / Temporary C-RNTI.....	505
7.1.2.8	MAC contention resolution / C-RNTI.....	508
7.1.2.9	MAC back off indicator	511
7.1.3	DL-SCH data transfer	515
7.1.3.1	Correct handling of DL assignment / Dynamic case.....	515
7.1.3.2	Correct handling of DL assignment / Semi-persistent case.....	516
7.1.3.3	MAC PDU header handling	524
7.1.3.4	Correct HARQ process handling / DCCH and DTCH.....	529
7.1.3.5	Correct HARQ process handling / CCCH.....	533
7.1.3.6	Correct HARQ process handling / BCCH.....	537
7.1.3.7	MAC padding.....	542
7.1.3.8	Void.....	544
7.1.3.9	MAC reset / DL.....	544
7.1.3.10	547
7.1.3.11	CA / Correct HARQ process handling / DCCH and DTCH / Pcell and Scell.....	547
7.1.3.11.1	CA / Correct HARQ process handling / DCCH and DTCH / Pcell and Scell / Intra-band Contiguous CA	547

7.1.3.11.2	CA / Correct HARQ process handling / DCCH and DTCH / Pcell and Scell / Inter-band CA.....	552
7.1.3.12	TDD additional special subframe configuration / Special subframe pattern 9/7 / CRS based transmission scheme.....	552
7.1.3.13	TDD additional special subframe configuration / Special subframe pattern 9/7 / UE-specific reference signals based transmission scheme.....	558
7.1.3.14	Correct handling of DL assignment / Dynamic case / EPDCCH.....	569
7.1.3.15	Correct handling of DL assignment / Semi-persistent case / EPDCCH.....	573
7.1.4	UL-SCH data transfer.....	584
7.1.4.1	Correct handling of UL assignment / Dynamic case.....	584
7.1.4.2	Correct handling of UL assignment / Semi-persistent case.....	587
7.1.4.3	Logical channel prioritization handling.....	595
7.1.4.4	Correct handling of MAC control information / Scheduling requests and PUCCH.....	598
7.1.4.5	Correct handling of MAC control information / Scheduling requests and random access procedure.....	600
7.1.4.6	Correct handling of MAC control information / Buffer status / UL data arrive in the UE Tx buffer and retransmission of BSR / Regular BSR.....	605
7.1.4.7	Correct handling of MAC control information / Buffer Status / UL resources are allocated / Padding BSR.....	612
7.1.4.7a	Correct handling of MAC control information / Buffer Status / UL resources are allocated / Cancellation of Padding BSR.....	617
7.1.4.8	Correct handling of MAC control information / Buffer status / Periodic BSR timer expires.....	623
7.1.4.9	Void.....	628
7.1.4.10	MAC padding.....	628
7.1.4.11	Correct HARQ process handling.....	631
7.1.4.12	MAC reset / UL.....	638
7.1.4.13	MAC PDU header handling.....	642
7.1.4.14	Correct HARQ process handling / TTI bundling.....	647
7.1.4.15	UE power headroom reporting / Periodic reporting.....	654
7.1.4.16	UE power headroom reporting / DL pathloss change reporting.....	657
7.1.4.17	661
7.1.4.18	CA / Correct handling of MAC control information / Buffer Status / UL data arrive in the UE Tx buffer / Extended buffer size.....	661
7.1.4.18.1	Test Purpose (TP).....	661
7.1.4.18.3	Test description.....	663
7.1.4.18.3.1	Pre-test conditions.....	663
7.1.4.18.3.2	Definition of system information messages.....	664
7.1.4.18.3.3	Specific message contents.....	664
7.1.4.19	CA / UE power headroom reporting / SCell activation and DL pathloss change reporting / Extended PHR.....	664
7.1.4.19.1	CA / UE power headroom reporting / SCell activation and DL pathloss change reporting / Extended PHR / Intra-band Contiguous CA.....	664
7.1.4.19.2	CA / UE power headroom reporting / SCell activation and DL pathloss change reporting / Extended PHR / Inter-band CA.....	669
7.1.4.20	CA / Correct handling of MAC control information / Buffer status.....	670
7.1.4.20.1	CA / Correct handling of MAC control information / Buffer status / Intra-band Contiguous CA.....	670
7.1.4.20.2	CA / Correct handling of MAC control information / Buffer status / Inter-band CA.....	675
7.1.4.21	CA / UE power headroom reporting / Extended PHR.....	675
7.1.4.22	Correct HARQ process handling / UL MIMO.....	679
7.1.5	PUSCH Hopping.....	686
7.1.5.1	Inter-TTI PUSCH hopping by uplink grant.....	686
7.1.5.2	Predefined intra-TTI PUSCH hopping ($N_{sb}=1$).....	689
7.1.5.3	Predefined intra-TTI PUSCH hopping ($N_{sb}=2/3/4$).....	693
7.1.5.4	Predefined inter-TTI PUSCH hopping ($N_{sb}=1$).....	695
7.1.5.5	Predefined inter-TTI PUSCH hopping ($N_{sb}=2/3/4$).....	696
7.1.6	DRX operation.....	697
7.1.6.1	DRX operation / Short cycle not configured / Parameters configured by RRC.....	697
7.1.6.2	DRX Operation / Short cycle not configured / DRX command MAC control element reception.....	704
7.1.7	Transport block size selection.....	709
7.1.7.0	Specific configurations.....	709
7.1.7.1	DL-SCH transport block size selection.....	710
7.1.7.1.1	DL-SCH transport block size selection / DCI format 1 / RA type 0.....	710

7.1.7.1.2	DL-SCH transport block size selection / DCI format 1 / RA type 1.....	722
7.1.7.1.3	DL-SCH transport block size selection / DCI format 1A / RA type 2 / Localised VRB	735
7.1.7.1.4	DL-SCH transport block size selection / DCI format 1A / RA type 2 / Distributed VRB.....	749
7.1.7.1.5	DL-SCH transport block size selection / DCI format 2A / RA type 0 / Two transport blocks enabled / Transport block to codeword swap flag value set to '0'	763
7.1.7.1.6	DL-SCH Transport Block Size selection / DCI format 2A / RA type 1 / Two transport blocks enabled / Transport block to codeword swap flag value set to '1'	778
7.1.7.2	UL-SCH transport block size support	793
7.1.7.2.1	UL-SCH transport block size selection / DCI format 0	793
7.1.8	Reporting of Rank Indicator (RI).....	805
7.1.8.1	Periodic RI reporting using PUCCH / Category 1 UE / Transmission mode 3/4.....	805
7.1.9	Activation/Deactivation of SCells	809
7.1.9.1	CA / Activation/Deactivation of SCells / Activation/Deactivation MAC control element reception / sCellDeactivationTimer	809
7.1.9.1.1	CA / Activation/Deactivation of SCells / Activation/Deactivation MAC control element reception / sCellDeactivationTimer / Intra-band Contiguous CA	809
7.1.9.1.2	CA / Activation/Deactivation of SCells / Activation/Deactivation MAC control element reception / sCellDeactivationTimer / Inter-band CA.....	813
7.2	RLC.....	814
7.2.1	General.....	814
7.2.2	Unacknowledged mode.....	814
7.2.2.1	UM RLC / Segmentation and reassembly / 5-bit SN / Framing info field	814
7.2.2.2	UM RLC / Segmentation and reassembly / 10-bit SN / Framing info field	816
7.2.2.3	UM RLC / Reassembly / 5-bit SN / LI value > PDU size.....	818
7.2.2.4	UM RLC / Reassembly / 10-bit SN / LI value > PDU size.....	819
7.2.2.5	UM RLC / Correct use of sequence numbering	820
7.2.2.5.1	UM RLC / 5-bit SN / Correct use of sequence numbering.....	820
7.2.2.5.2	UM RLC / 10-bit SN / Correct use of Sequence numbering	824
7.2.2.6	UM RLC / Concatenation, segmentation and reassembly.....	827
7.2.2.7	UM RLC / In sequence delivery of upper layer PDUs without residual loss of RLC PDUs / Maximum re-ordering delay below <i>t-Reordering</i>	832
7.2.2.8	UM RLC / In sequence delivery of upper layer PDUs without residual loss of RLC PDUs / Maximum re-ordering delay exceeds <i>t-Reordering</i>	835
7.2.2.9	UM RLC / In sequence delivery of upper layer PDUs with residual loss of RLC PDUs / Maximum re-ordering delay exceeds <i>t-Reordering</i>	837
7.2.2.10	UM RLC / Duplicate detection of RLC PDUs.....	839
7.2.2.11	UM RLC / RLC re-establishment procedure	841
7.2.3	Acknowledged mode	844
7.2.3.1	AM RLC / Concatenation and reassembly.....	844
7.2.3.2	AM RLC / Segmentation and reassembly / No PDU segmentation.....	847
7.2.3.3	AM RLC / Segmentation and reassembly / Framing info field.....	849
7.2.3.4	AM RLC / Segmentation and reassembly / Different numbers of length indicators.....	851
7.2.3.5	AM RLC / Reassembly / LI value > PDU size	854
7.2.3.6	AM RLC / Correct use of sequence numbering	855
7.2.3.7	AM RLC / Control of transmit window	859
7.2.3.8	AM RLC / Control of receive window.....	862
7.2.3.9	AM RLC / Polling for status	863
7.2.3.10	AM RLC / Receiver status triggers	868
7.2.3.11	Void.....	873
7.2.3.12	Void.....	873
7.2.3.13	AM RLC / Reconfiguration of RLC parameters by upper layers.....	873
7.2.3.14	AM RLC / In sequence delivery of upper layers PDUs	879
7.2.3.15	AM RLC / Re-ordering of RLC PDU segments	882
7.2.3.16	AM RLC / Re-transmission of RLC PDU without re-segmentation.....	887
7.2.3.17	AM RLC / Re-segmentation RLC PDU / SO, FI, LSF	890
7.2.3.18	AM RLC / Reassembly / AMD PDU reassembly from AMD PDU segments, Segmentation Offset and Last Segment Flag fields	894
7.2.3.19	Void.....	899
7.2.3.20	AM RLC / Duplicate detection of RLC PDUs.....	899
7.2.3.21	AM RLC / RLC re-establishment at RRC connection reconfiguration including <i>mobilityControlInfo</i> IE.....	901
7.3	PDCP.....	903

7.3.1	Maintenance of PDCP sequence numbers for radio bearers	903
7.3.1.1	Maintenance of PDCP sequence numbers / User plane / RLC AM	903
7.3.1.2	Maintenance of PDCP sequence numbers / User plane / RLC UM / Short PDCP SN (7 bits)	906
7.3.1.3	Maintenance of PDCP sequence numbers / User plane / RLC UM / Long PDCP SN (12 bits)	908
7.3.2	Void	910
7.3.3	PDCP ciphering and deciphering	910
7.3.3.1	Ciphering and deciphering / Correct functionality of EPS AS encryption algorithms / SNOW 3G ...	910
7.3.3.2	Ciphering and deciphering / Correct functionality of EPS UP encryption algorithms / SNOW 3G ...	913
7.3.3.3	Ciphering and deciphering / Correct functionality of EPS AS encryption algorithms / AES	915
7.3.3.4	Ciphering and deciphering / Correct functionality of EPS UP encryption algorithms / AES	917
7.3.3.5	Ciphering and deciphering / Correct functionality of EPS AS encryption algorithms / ZUC	918
7.3.3.6	Ciphering and deciphering / Correct functionality of EPS UP encryption algorithms / ZUC	920
7.3.4	PDCP integrity protection	922
7.3.4.1	Integrity protection / Correct functionality of EPS AS integrity algorithms / SNOW3G	922
7.3.4.2	Integrity protection / Correct functionality of EPS AS integrity algorithms / AES	927
7.3.4.3	Integrity protection / Correct functionality of EPS AS integrity algorithms / ZUC	930
7.3.5	PDCP handover	933
7.3.5.1	Void	933
7.3.5.2	PDCP handover / Lossless handover / PDCP sequence number maintenance	933
7.3.5.3	PDCP handover / Non-lossless handover PDCP sequence number maintenance	936
7.3.5.4	PDCP handover / Lossless handover / PDCP status report to convey the information on missing or acknowledged PDCP SDUs at handover	939
7.3.5.5	PDCP handover / In-order delivery and duplicate elimination in the downlink	943
7.3.6	PDCP Others	947
7.3.6.1	PDCP Discard	947
8	RRC	949
8.1	RRC connection management procedures	949
8.1.1	Paging	949
8.1.1.1	RRC / Paging for connection in idle mode	949
8.1.1.2	RRC / Paging for notification of BCCH modification in idle mode	952
8.1.1.3	RRC / Paging for connection in idle mode / Multiple paging records	956
8.1.1.4	RRC / Paging for connection in idle mode / Shared network environment	960
8.1.1.5	Void	964
8.1.1.6	RRC / BCCH modification in connected mode	964
8.1.2	RRC connection establishment	966
8.1.2.1	RRC connection establishment / $K_s=1.25$ / Success	966
8.1.2.2	RRC connection establishment / Reject with wait time	970
8.1.2.3	RRC connection establishment / Return to idle state after T300 timeout	974
8.1.2.4	Void	975
8.1.2.5	RRC connection establishment / 0% access probability for MO calls, no restriction for MO signalling	975
8.1.2.6	RRC connection establishment / Non-zero percent access probability for MO calls, no restriction for MO signalling	980
8.1.2.7	RRC connection establishment / 0% access probability for AC 0 to 9, AC 10 is barred, AC 11 to 15 are not barred, access for UE with access class in the range 11 to 15 is allowed	985
8.1.2.8	RRC connection establishment / Range of access barring time	989
8.1.2.9	RRC Connection Establishment / 0% access probability for MO calls, non-zero percent access probability for MO signalling	994
8.1.2.10	Void	1000
8.1.2.11	RRC connection establishment of emergency call	1000
8.1.2.12	RRC connection establishment of emergency call / Limited Service	1002
8.1.2.13	RRC connection establishment / 0% access probability for MO calls, 0% access probability for MO signalling	1005
8.1.2.14	RRC connection establishment / High speed flag	1010
8.1.3	RRC connection release	1011
8.1.3.1	RRC connection release / Success	1011
8.1.3.2	Void	1013
8.1.3.3	Void	1013
8.1.3.4	RRC connection release / Redirection to another E-UTRAN frequency	1013
8.1.3.5	RRC connection release / Success / With priority information	1015
8.1.3.6	RRC connection release / Redirection from E-UTRAN to UTRAN	1020

8.1.3.6a	RRC connection release / Redirection from E-UTRAN to UTRAN / Pre-redirection info	1023
8.1.3.7	RRC connection release / Redirection from UTRAN to E-UTRAN.....	1026
8.1.3.8	RRC connection release / Redirection from E-UTRAN to GERAN.....	1033
8.1.3.9	RRC connection release / Redirection from E-UTRAN to CDMA2000-HRPD.....	1036
8.1.3.10	RRC connection release / Redirection from E-UTRAN to CDMA2000-1xRTT.....	1038
8.1.3.11	RRC connection release / Redirection to another E-UTRAN band	1040
8.1.3.11a	RRC connection release / Redirection to another E-UTRAN band / Between FDD and TDD.....	1043
8.1.3.12	RRC connection release / Success / With priority information / Inter-band	1046
8.1.3.12a	RRC connection release / Success / With priority information / Inter- band / Between FDD and TDD	1051
8.2	RRC connection reconfiguration.....	1057
8.2.1	Radio bearer establishment.....	1057
8.2.1.1	RRC connection reconfiguration / Radio bearer establishment for transition from RRC_IDLE to RRC_CONNECTED / Success / Default bearer / Early bearer establishment.....	1057
8.2.1.2	Void.....	1059
8.2.1.3	RRC connection reconfiguration / Radio bearer establishment / Success / Dedicated bearer.....	1059
8.2.1.4	Void.....	1061
8.2.1.5	RRC connection reconfiguration / Radio bearer establishment for transition from RRC_Idle to RRC CONNECTED / Success / Latency check.....	1061
8.2.1.6	RRC connection reconfiguration / Radio bearer establishment for transition from RRC_Idle to RRC CONNECTED / Success / Latency check / SecurityModeCommand and RRCConnectionReconfiguration transmitted in the same TTI	1067
8.2.1.7	RRC connection reconfiguration / Radio bearer establishment / Success / SRB2	1071
8.2.1.8	RRC connection reconfiguration / Radio bearer establishment / Success / Dedicated bearer / ROHC configured	1073
8.2.2	Radio resource reconfiguration.....	1077
8.2.2.1	RRC connection reconfiguration / Radio resource reconfiguration / Success.....	1077
8.2.2.2	RRC connection reconfiguration / SRB/DRB reconfiguration / Success.....	1080
8.2.2.3	CA / RRC connection reconfiguration / SCell addition/modification/release / Success	1083
8.2.2.3.1	CA / RRC connection reconfiguration / SCell addition/modification/release / Success / Intra- band Contiguous CA	1083
8.2.2.3.2	CA / RRC connection reconfiguration / SCell addition/modification/release / Success / Inter- Band CA	1093
8.2.2.4	CA / RRC connection reconfiguration / SCell SI change / Success.....	1094
8.2.2.4.1	CA / RRC connection reconfiguration / SCell SI change / Success / Intra-band Contiguous CA	1094
8.2.2.4.2	CA / RRC connection reconfiguration / SCell SI change / Success / Inter-Band CA	1099
8.2.2.5	CA / RRC connection reconfiguration / SCell addition without UL / Success	1100
8.2.2.5.1	CA / RRC connection reconfiguration / SCell addition without UL / Success / Intra-band Contiguous CA	1100
8.2.2.5.2	CA / RRC connection reconfiguration / SCell addition without UL / Success / Inter-band CA	1102
8.2.2.6	RRC connection reconfiguration/ UE Assistance Information	1103
8.2.2.6.1	RRC connection reconfiguration/ UE Assistance Information/power preference indication setup and release	1103
8.2.2.6.2	RRC connection reconfiguration/ UE Assistance Information/power preference indication release on connection re-establishment.....	1106
8.2.2.6.3	RRC connection reconfiguration/ UE Assistance Information/T340 running	1113
8.2.3	Radio bearer release.....	1116
8.2.3.1	RRC connection reconfiguration / Radio bearer release / Success.....	1116
8.2.4	Handover	1119
8.2.4.1	RRC connection reconfiguration / Handover / Success / Dedicated preamble	1119
8.2.4.2	RRC connection reconfiguration / Handover / Success / Common preamble.....	1128
8.2.4.3	RRC connection reconfiguration / Handover / Success / Intra-cell / Security reconfiguration	1132
8.2.4.4	RRC connection reconfiguration / Handover / Failure / Intra-cell / Security reconfiguration	1136
8.2.4.5	RRC connection reconfiguration / Handover / All parameters included.....	1141
8.2.4.6	RRC connection reconfiguration / Handover / Success / Inter-frequency.....	1147
8.2.4.7	RRC connection reconfiguration / Handover / Failure / Re-establishment successful.....	1151
8.2.4.8	RRC connection reconfiguration / Handover / Failure / Re-establishment failure.....	1165
8.2.4.9	RRC connection reconfiguration / Handover / Inter-band blind handover / Success.....	1172
8.2.4.10	RRC connection reconfiguration / Handover (between FDD and TDD)	1175
8.2.4.11	Void.....	1180
8.2.4.12	RRC connection reconfiguration / Handover / Setup and release of MIMO.....	1180

8.2.4.13	RRC connection reconfiguration / Handover / Success (with measurement) / Inter-band	1184
8.2.4.13a	RRC connection reconfiguration / Handover / Success (with measurement) / Inter-band / Between FDD and TDD	1189
8.2.4.14	RRC connection reconfiguration / Handover / Failure / Re-establishment successful / Inter-band ..	1197
8.2.4.14a	RRC connection reconfiguration / Handover / Failure / Re-establishment successful / Inter-band / Between FDD and TDD	1207
8.2.4.15	RRC connection reconfiguration / Handover / Failure / Re-establishment failure / Inter-band	1220
8.2.4.15a	RRC connection reconfiguration / Handover / Failure / Re-establishment failure / Inter-band / Between FDD and TDD	1227
8.2.4.16	CA / RRC connection reconfiguration / Setup and Change of MIMO	1239
8.2.4.16.1	CA / RRC connection reconfiguration / Setup and Change of MIMO / Intra-band Contiguous CA	1239
8.2.4.16.2	CA / RRC connection reconfiguration / Setup and Change of MIMO / Inter-band CA	1243
8.2.4.17	CA / RRC connection reconfiguration / Handover / Success / PCell Change and SCell addition ...	1243
8.2.4.17.1	CA / RRC connection reconfiguration / Handover / Success / PCell Change and SCell addition / Intra-band Contiguous CA	1243
8.2.4.17.2	CA / RRC connection reconfiguration / Handover / Success / PCell Change and SCell addition / Inter-band CA	1251
8.2.4.18	CA / RRC connection reconfiguration / Handover / Success / SCell release	1251
8.2.4.18.1	CA / RRC connection reconfiguration / Handover / Success / SCell release / Intra-band Contiguous CA	1251
8.2.4.18.2	CA / RRC connection reconfiguration / Handover / Success / SCell release / Inter-band CA	1258
8.2.4.19 CA / RRC connection reconfiguration / Handover / Success / PCell Change / SCell no Change	1258
8.2.4.19.1	CA / RRC connection reconfiguration / Handover / Success / PCell Change / SCell no Change / Intra-band Contiguous CA	1258
8.2.4.19.2	CA / RRC connection reconfiguration / Handover / Success / PCell Change / SCell no Change / Inter-band CA	1264
8.2.4.20	CA / RRC connection reconfiguration / Handover / Success / SCell Change	1265
8.2.4.20.1	CA / RRC connection reconfiguration / Handover / Success / SCell Change / Intra-band Contiguous CA	1265
8.2.4.20.2	CA / RRC connection reconfiguration / Handover / Success / SCell Change / Inter-band CA ...	1270
8.2.4.21	CA / RRC connection reconfiguration / Handover / Success / SCell release	1270
8.2.4.21.1	CA / RRC connection reconfiguration / Handover / Success / SCell release / Intra-band Contiguous CA	1270
8.2.4.21.2	CA / RRC connection reconfiguration / Handover / Success / SCell release / Inter-band CA	1277
8.2.4.22	RRC connection reconfiguration / Handover / MFBI / Target cell broadcasting information disregarded by the UE	1278
8.3	Measurement configuration control and reporting	1283
8.3.1	Intra E-UTRAN measurements	1283
8.3.1.1	Measurement configuration control and reporting / Intra E-UTRAN measurements / Event A1	1283
8.3.1.2	Measurement configuration control and reporting / Intra E-UTRAN measurements / Event A2	1288
8.3.1.3	Measurement configuration control and reporting / Intra E-UTRAN measurements / Two simultaneous events A3 (intra and inter-frequency measurements)	1293
8.3.1.3a	Measurement configuration control and reporting / Intra E-UTRAN measurements / Two simultaneous events A3 (intra and inter-frequency measurements) / RSRQ based measurements ...	1301
8.3.1.4	Measurement configuration control and reporting / Intra E-UTRAN measurements / Periodic reporting (intra and inter-frequency measurements)	1310
8.3.1.5	Measurement configuration control and reporting / Intra E-UTRAN measurements / Two simultaneous event A3 (intra-frequency measurements)	1320
8.3.1.6	Measurement configuration control and reporting / Intra E-UTRAN measurements / Two simultaneous events A2 and A3 (inter-frequency measurements)	1329
8.3.1.7	Measurement configuration control and reporting / Intra E-UTRAN measurements / Blacklisting ..	1336
8.3.1.8	Measurement configuration control and reporting / Intra E-UTRAN measurements / Handover / IE measurement configuration present	1345
8.3.1.9	Measurement configuration control and reporting / Intra E-UTRAN measurements / Intra- frequency handover / IE measurement configuration not present	1351
8.3.1.9a	Measurement configuration control and reporting / Intra Frequency measurements / Intra- frequency handover / IE measurement configuration not present / Single Frequency operation	1358
8.3.1.10	Measurement configuration control and reporting / Intra E-UTRAN measurements / Inter- frequency handover / IE measurement configuration not present	1362
8.3.1.11	Measurement configuration control and reporting / Intra E-UTRAN measurements / Continuation of the measurements after RRC connection re-establishment	1369

8.3.1.11a	Measurement configuration control and reporting / Intra Frequency measurements / Continuation of the measurements after RRC connection re-establishment / Single Frequency operation.....	1380
8.3.1.12	Measurement configuration control and reporting / Intra E-UTRAN measurements / Two simultaneous events A3 (inter-band measurements).....	1388
8.3.1.12a	Measurement configuration control and reporting / Intra E-UTRAN measurements / Two simultaneous events A3 (inter-band measurements) / Between FDD and TDD	1396
8.3.1.13	Measurement configuration control and reporting / Intra E-UTRAN measurements / Periodic reporting (intra-frequency and inter-band measurements)	1410
8.3.1.13a	Measurement configuration control and reporting / Intra E-UTRAN measurements / Periodic reporting (intra-frequency and inter-band measurements) / Between FDD and TDD	1418
8.3.1.14	Measurement configuration control and reporting / Intra E-UTRAN measurements / Two simultaneous events A2 and A3 (inter-band measurements)	1433
8.3.1.14a	Measurement configuration control and reporting / Intra E-UTRAN measurements / Two simultaneous events A2 and A3 (inter-band measurements) / Between FDD and TDD.....	1441
8.3.1.15	Measurement configuration control and reporting / Intra E-UTRAN measurements / Inter-band handover / IE measurement configuration not present.....	1453
8.3.1.15a	Measurement configuration control and reporting / Intra E-UTRAN measurements / Inter-band handover / IE measurement configuration not present / Between FDD and TDD	1460
8.3.1.16	Measurement configuration control and reporting / Intra E-UTRAN measurements / Continuation of the measurements after RRC connection re-establishment / Inter-band.....	1469
8.3.1.16a	Measurement configuration control and reporting / Intra E-UTRAN measurements / Continuation of the measurements after RRC connection re-establishment / Inter-band / Between FDD and TDD.....	1479
8.3.1.17	CA / Measurement configuration control and reporting / Intra E-UTRAN measurements / Event A6.....	1493
8.3.1.17.1	CA / Measurement configuration control and reporting / Intra E-UTRAN measurements / Event A6 / Intra-band Contiguous CA	1493
8.3.1.17.2	CA / Measurement configuration control and reporting / Intra E-UTRAN measurements / Event A6 / Inter-band CA.....	1504
8.3.1.18	CA / Measurement configuration control and reporting / Intra E-UTRAN measurements / Additional measurement reporting.....	1505
8.3.1.18.1	CA / Measurement configuration control and reporting / Intra E-UTRAN measurements / Additional measurement reporting / Intra-band Contiguous CA.....	1505
8.3.1.18.2	CA / Measurement configuration control and reporting / Intra E-UTRAN measurements / Additional measurement reporting / Inter-band CA	1515
8.3.1.19	eICIC/ Measurement configuration control and reporting / CSI change.....	1516
8.3.1.20	eICIC / Measurement configuration control and reporting / Event A3 / RSRP and RSRQ measurement / Neighbour ABS.....	1522
8.3.1.21	eICIC / Measurement configuration control and reporting / Event A3 Handover / Neighbour RSRP measurement configuration change	1527
8.3.1.22	CA / Measurement configuration control and reporting / Intra E-UTRAN measurements / Event A1 / Event A2	1534
8.3.1.22.1	CA / Measurement configuration control and reporting / Intra E-UTRAN measurements / Event A1 / Event A2 / Intra-band Contiguous CA	1534
8.3.1.22.2	CA / Measurement configuration control and reporting / Intra E-UTRAN measurements / Event A1 / Event A2 / Inter-band CA	1542
8.3.1.23	Measurement configuration control and reporting / Intra E-UTRAN measurements / Event A4	1544
8.3.1.24	Measurement configuration control and reporting / Intra E-UTRAN measurements / Event A5	1550
8.3.1.25	Measurement configuration control and reporting / Intra E-UTRAN measurements / Event A5 / RSRQ based measurements	1557
8.3.1.26	Measurement configuration control and reporting / Intra E-UTRAN measurements / Event A5 (Inter-frequency measurements)	1564
8.3.1.27	Measurement configuration control and reporting / Intra E-UTRAN measurements / Event A5 (Inter-frequency measurements) / RSRQ based measurements	1571
8.3.1.28	eICIC / Measurement configuration control and reporting / Event A3 / RSRP and RSRQ measurement / Serving ABS	1578
8.3.2	Inter-RAT measurements.....	1582
8.3.2.1	Measurement configuration control and reporting / Inter-RAT measurements / Event B2 / Measurement of GERAN cells.....	1582
8.3.2.2	Measurement configuration control and reporting / Inter-RAT measurements / Periodic reporting / Measurement of GERAN cells.....	1588

8.3.2.3	Measurement configuration control and reporting / Inter-RAT measurements / Event B2 / Measurement of UTRAN cells.....	1595
8.3.2.3a	Measurement configuration control and reporting / Inter-RAT measurements / Event B2 / Measurement of UTRAN cells / RSRQ based measurements	1604
8.3.2.4	Measurement configuration control and reporting / Inter-RAT measurements / Periodic reporting / Measurement of UTRAN cells.....	1613
8.3.2.5	Measurement configuration control and reporting / Inter-RAT measurements / Periodic reporting / Measurements of E-UTRAN, UTRAN and GERAN cells	1623
8.3.2.6	Measurement configuration control and reporting / Inter-RAT measurements / Simultaneous A2 and two B2 / Measurements of E-UTRAN, UTRAN and GERAN cells.....	1633
8.3.2.7	Measurement configuration control and reporting / Inter-RAT measurements / Event B2 (measurement HRPD cells).....	1641
8.3.2.8	Measurement configuration control and reporting / Inter-RAT measurements / Periodic reporting / Measurement of HRPD cells)	1648
8.3.2.9	Measurement configuration control and reporting / Inter-RAT measurements / Event B2 / Measurement of 1xRTT cells).....	1658
8.3.2.10	Measurement configuration control and reporting / Inter-RAT measurements / Periodic reporting / Measurement of 1xRTT cells.....	1666
8.3.2.11	Measurement configuration control and reporting / Inter-RAT Measurements / Event B1 / Measurement of UTRAN cells.....	1678
8.3.3	Measurements for self optimized networks	1685
8.3.3.1	Measurement configuration control and reporting / SON / ANR / CGI reporting of E-UTRAN cell.....	1685
8.3.3.2	Measurement configuration control and reporting / SON / ANR / CGI reporting of UTRAN cell ..	1697
8.3.3.3	Measurement configuration control and reporting / SON / ANR / CGI reporting of GERAN cell ..	1709
8.3.3.4	Measurement configuration control and reporting / SON / ANR / CGI reporting of HRPD cell	1719
8.3.3.5	Void.....	1731
8.3.4	Measurement for CSG, Hybrid and Open cells	1731
8.3.4.1	Intra-frequency SI acquisition / CSG cell and non-CSG cell.....	1731
8.3.4.2	Inter-frequency SI acquisition / Non-member hybrid cell.....	1744
8.3.4.3	Inter-frequency SI acquisition / Member hybrid cell	1752
8.3.4.4	Inter-RAT SI acquisition / RRC_CONNECTED / UMTS member CSG cell	1760
8.3.4.5	Inter-frequency E-UTRAN FDD – FDD / CSG Proximity Indication.....	1767
8.4	Inter-RAT handover	1778
8.4.1	Inter-RAT handover E-UTRA to UTRA	1778
8.4.1.1	Void.....	1778
8.4.1.2	Inter-RAT handover / From E-UTRA to UTRA PS / Data	1778
8.4.1.3	Void.....	1780
8.4.1.4	Inter-RAT handover / From E-UTRA to UTRA HSDPA / Data	1780
8.4.1.5	Inter-RAT Handover / from E-UTRA to UTRA(HSUPA/HSDPA) / Data	1783
8.4.2	Inter-RAT handover UTRA to E-UTRA	1786
8.4.2.1	Void.....	1786
8.4.2.2	Inter-RAT handover / From UTRA PS to E-UTRA / Data	1786
8.4.2.3	Void.....	1793
8.4.2.4	Inter-RAT handover / From UTRA HSPA to E-UTRA / Data	1793
8.4.2.5	Void.....	1799
8.4.2.6	Void.....	1799
8.4.2.7	CA / RRC connection reconfiguration / Handover UTRAN to E-UTRAN/ Success / SCell addition	1799
8.4.2.7.1	CA / RRC connection reconfiguration / Handover UTRAN to E-UTRAN/ Success / SCell addition / Intra-band Contiguous CA	1799
8.4.2.7.2	CA / RRC connection reconfiguration / Handover UTRAN to E-UTRAN/ Success / SCell addition / Inter-band CA.....	1807
8.4.3	Inter-RAT mobility E-UTRA to GERAN.....	1807
8.4.3.1	Inter-RAT handover / From E-UTRA to GPRS / PS HO.....	1807
8.4.3.2	Inter-RAT cell change order / From E-UTRA data RRC_CONNECTED to GPRS / Without NACC	1809
8.4.3.3	Inter-RAT cell change order / From E-UTRA data to GPRS / With NACC.....	1814
8.4.4	Void	1819
8.4.5	Inter-RAT handover E-UTRA to HRPD	1819
8.4.5.1	Void.....	1819
8.4.5.2	Void.....	1819

8.4.5.3	Void.....	1819
8.4.5.4	Pre-registration at HRPD and inter-RAT handover / From E-UTRA to HRPD Active / Data	1819
8.4.6	Inter-RAT handover HRPD to E-UTRA	1832
8.4.7	Inter-RAT mobility E-UTRA to 1xRTT	1832
8.4.7.1	Inter-RAT handover / SRVCC from E-UTRA to 1xRTT(CS) / Speech.....	1832
8.4.7.2	Void.....	1845
8.4.7.3	Pre-registration at 1xRTT and inter-RAT Redirection / CS fallback from E-UTRA RRC_IDLE to 1xRTT / MT call	1845
8.4.7.4	Pre-registration at 1xRTT and inter-RAT Redirection / CS fallback from E-UTRA RRC_CONNECTED to 1xRTT / MO call.....	1853
8.4.7.5	Pre-registration at 1xRTT and inter-RAT Handover / Enhanced CS fallback from E-UTRA RRC_IDLE to 1xRTT/MT call	1860
8.4.7.6	Pre-registration at 1xRTT and inter-RAT handover / Enhanced CS fallback from E-UTRA RRC_CONNECTED to 1xRTT/MO call.....	1872
8.4.7.7	Pre-registration at 1xRTT and inter-RAT handover / Enhanced CS fallback from E-UTRA RRC_CONNECTED to e1XCSFB ECAM-based 1xRTT / MO call.....	1883
8.4.7.8	Pre-registration at 1xRTT and inter-RAT Handover / Enhanced CS fallback from E-UTRA RRC_CONNECTED to 1xRTT / ECAM-based MT call	1896
8.4.7.9	Pre-registration at 1xRTT and inter-RAT Handover / Enhanced CS fallback from E-UTRA RRC_CONNECTED to 1xRTT / Extended Service Reject / MO call.....	1908
8.4.7.10	Pre-registration at 1xRTT and inter-RAT Handover / Enhanced CS fallback from E-UTRA call failure – GCSNA with Release Order	1915
8.5	RRC others	1924
8.5.1	Radio link failure	1924
8.5.1.1	Radio link failure / RRC connection re-establishment success	1924
8.5.1.2	Radio link failure / T301 expiry	1928
8.5.1.3	Radio link failure / T311 expiry	1931
8.5.1.4	Radio link failure / RRC connection re-establishment reject	1932
8.5.1.5	Radio link failure / Radio link recovery while T310 is running	1934
8.5.1.6	Radio link failure / T311 expiry / Dedicated RLF timer	1936
8.5.1.7	CA / No Radio Link Failure on SCell / RRC Connection Continues on PCell	1941
8.5.1.7.1	CA / No Radio Link Failure on SCell / RRC Connection Continues on PCell / Intra-band Contiguous CA	1941
8.5.1.7.2	CA / No Radio Link Failure on SCell / RRC Connection Continues on PCell / Inter-band CA ..	1945
8.5.2	Redirection to E-UTRAN	1945
8.5.2.1	Redirection to E-UTRAN / From UTRAN upon reception of RRC CONNECTION REJECT	1945
8.5.3	Void	1948
8.5.4	UE capability transfer	1948
8.5.4.1	UE capability transfer / Success	1948
8.6	Minimization of Drive Test Specific Procedures	1964
8.6.1	Immediate MDT	1964
8.6.1.1	Immediate MDT / Reporting / Location information.....	1964
8.6.1.2	Immediate MDT / Reporting / Location information / Request from eNB / Event A2.....	1969
8.6.2	Logged MDT	1974
8.6.2.1	Logged MDT / Intra-frequency measurement, logging and reporting	1974
8.6.2.2	Logged MDT / Inter-frequency measurement, logging and reporting	1983
8.6.2.3	Logged MDT / Logging and reporting / Limiting area scope	1988
8.6.2.3a	Logged MDT / Logging and reporting / Limiting area scope / TAC list with PLMN identity	2000
8.6.2.4	Logged MDT / logging and reporting / Indication of logged measurements at E-UTRA handover ..	2007
8.6.2.5	Logged MDT / Logging and reporting / Indication of logged measurements at E-UTRA re-establishment.....	2012
8.6.2.6	Logged MDT / Release of logged MDT measurement configuration / Expire of duration timer	2017
8.6.2.7	Logged MDT / Release of logged MDT measurement configuration / Reception of new logged measurement configuration, Detach or UE power off.....	2023
8.6.2.8	Logged MDT / Maintaining logged measurement configuration / UE state transitions and mobility	2030
8.6.2.9	Logged MDT / Location information.....	2039
8.6.2.10	Logged MDT / Logging and reporting / Reporting at RRC connection establishment / PLMN list ..	2045
8.6.2.11	Logged MDT / Logging and reporting / Reporting at intra LTE handover / PLMN list.....	2051
8.6.2.12	Logged MDT / Logging and reporting / Reporting at RRC connection re-establishment / PLMN list.....	2058
8.6.2.13	Logged MDT / Logging and reporting / PLMN list / PLMN change	2065

8.6.3	Inter-RAT Logged MDT	2069
8.6.3.1	Logged MDT / UTRAN Inter-RAT measurement, logging and reporting.....	2069
8.6.3.2	Logged MDT / GERAN Inter-RAT measurement, logging and reporting.....	2078
8.6.3.3	Logged MDT / CDMA2000 Inter-RAT measurement, logging and reporting	2086
8.6.3.4	Logged MDT / Logging and reporting / Reporting at UTRAN Inter-RAT handover / PLMN list...	2092
8.6.4	Logged Radio Link Failure.....	2102
8.6.4.1	Radio Link Failure logging / Reporting of Intra-frequency measurements.....	2102
8.6.4.2	Radio Link Failure logging / Reporting of Inter-frequency measurements.....	2110
8.6.4.3	Radio Link Failure logging / Reporting at RRC connection establishment and reestablishment.....	2118
8.6.4.4	Radio Link Failure logging / Reporting at E-UTRA handover	2127
8.6.4.5	Radio Link Failure logging / Reporting of ECGI of the PCell.....	2142
8.6.4.6	Radio Link Failure logging / Reporting of RLF report availability / PLMN change	2151
8.6.4.7	Radio Link Failure logging / Location information	2155
8.6.4.8	Radio Link Failure logging / Logging and reporting / Reporting at RRC connection establishment / PLMN list.....	2159
8.6.4.9	Radio Link Failure logging / Logging and reporting / Reporting at intra LTE handover / PLMN list.....	2165
8.6.4.10	Radio Link Failure logging / Logging and reporting / Reporting at RRC connection re- establishment / PLMN list.....	2173
8.6.5	Inter-RAT Logged Radio Link Failure	2179
8.6.5.1	Radio Link Failure logging / Reporting at UTRAN Inter-RAT handover	2179
8.6.5.2	Radio Link Failure logging / Reporting at GERAN Inter-RAT handover	2190
8.6.5.3	Radio Link Failure logging / Reporting CDMA2000 neighbour cell information.....	2201
8.6.6	Logged Handover Failure	2210
8.6.6.1	Handover Failure logging / Reporting of Intra-frequency measurements.....	2210
8.6.6.2	Handover Failure logging / Reporting of Inter-frequency measurements.....	2218
8.6.6.3	Handover Failure logging / Reporting of HOF report availability / PLMN change.....	2226
8.6.6.4	Handover Failure logging / Location information.....	2233
8.6.6.5	Handover Failure logging / Logging and reporting / Reporting at RRC connection establishment / PLMN list.....	2237
8.6.6.6	Handover Failure logging / Logging and reporting / Reporting at intra LTE handover / PLMN list.....	2247
8.6.6.7	Handover Failure logging / Logging and reporting / Reporting at RRC connection re- establishment / PLMN list.....	2258
8.6.7	Inter-RAT Logged Handover Failure	2267
8.6.7.1	Handover Failure logging / Reporting of UTRAN Inter-RAT measurements	2267
8.6.7.2	Handover Failure logging / Reporting of GERAN Inter-RAT measurements	2279
8.6.7.3	Handover Failure logging / Reporting of CDMA2000 Inter-RAT measurements	2291
8.6.7.4	Handover Failure logging / Reporting at UTRAN Inter-RAT handover / PLMN list.....	2303
8.6.8	Connection Establishment Failure	2316
8.6.8.1	Connection Establishment Failure logging / Logging and reporting / T300 expiry	2316
8.6.8.2	Connection Establishment Failure logging / Logging and reporting / Reporting at intra-LTE handover.....	2319
8.6.8.3	Connection Establishment Failure logging / Logging and reporting / Reporting at RRC connection re-establishment	2325
8.6.8.4	Connection Establishment Failure logging / Logging and reporting / Location Information	2329
8.6.8.5	Connection Establishment Failure logging / Logging and reporting / Reporting of Intra- frequency measurements	2333
8.6.8.6	Connection Establishment Failure logging / Logging and reporting / Reporting of Inter- frequency measurements	2338
8.6.9	Inter-RAT Connection Establishment Failure	2342
8.6.9.1	Connection Establishment Failure logging / Logging and reporting / Reporting at UTRAN Inter- RAT handover.....	2342
8.6.9.2	Connection Establishment Failure logging / Logging and reporting / Reporting of UTRAN Inter- RAT measurements	2348
8.6.9.3	Connection Establishment Failure logging / Logging and reporting / Reporting of GERAN Inter- RAT measurements	2353
8.6.9.4	Connection Establishment Failure logging / Logging and reporting / Reporting of CDMA2000 Inter-RAT measurements	2357
8.6.10	Inter-RAT Immediate MDT.....	2362
8.6.10.1	Inter-RAT Immediate MDT / Reporting / Location information / Event B2	2362
8.6.11	RACH Optimisation	2366

8.6.11.1	RACH Optimisation.....	2366
8.7	Automatic Neighbour Relation (ANR) for UTRAN Specific Procedures.....	2368
8.7.1	Inter-RAT / UTRAN ANR measurement, logging and reporting / E-UTRAN cell.....	2368
9	EPS mobility management	2373
9.1	EMM common procedures	2373
9.1.1	Void.....	2373
9.1.1.1	Void.....	2373
9.1.1.2	Void.....	2373
9.1.2	Authentication procedure.....	2373
9.1.2.1	Authentication accepted.....	2373
9.1.2.2	Void.....	2376
9.1.2.3	Authentication not accepted by the network / GUTI used / Authentication reject and re-authentication.....	2376
9.1.2.4	Authentication not accepted by the UE / MAC code failure.....	2378
9.1.2.5	Authentication not accepted by the UE / SQN failure.....	2381
9.1.2.6	Abnormal cases / Network failing the authentication check	2384
9.1.3	Security mode control procedure	2386
9.1.3.1	NAS security mode command accepted by the UE.....	2386
9.1.3.2	NAS security mode command not accepted by the UE.....	2390
9.1.3.3	No emergency bearer service / NAS security mode command with EIA0 not accepted by the UE	2393
9.1.4	Identification procedure	2397
9.1.4.1	Void.....	2397
9.1.4.2	Identification procedure / IMEI / IMEISV requested.....	2397
9.1.5	EMM information procedure	2398
9.1.5.1	EMM information procedure	2398
9.1.5.2	EMM information procedure not supported by the UE.....	2401
9.2	EMM specific procedures	2402
9.2.1	Attach procedure.....	2402
9.2.1.1	Attach procedure for EPS services.....	2402
9.2.1.1.0	General	2402
9.2.1.1.1	Attach / Success / Valid GUTI.....	2402
9.2.1.1.1a	Attach Procedure / Success / Last visited TAI, TAI list and equivalent PLMN list handling	2410
9.2.1.1.1b	Attach Procedure / Success / Last visited TAI, TAI list and equivalent PLMN list handling / Single Frequency operation.....	2418
9.2.1.1.2	Attach Procedure / Success / With IMSI / GUTI reallocation.....	2419
9.2.1.1.2a	Attach Procedure / AttachWithIMSI configured / Selected PLMN is neither the registered PLMN nor in the list of equivalent PLMNs / Success.....	2422
9.2.1.1.3	Attach Procedure / Success / Request for obtaining the IPv6 address of the home agent	2424
9.2.1.1.4	Attach Procedure / Success / Request for obtaining the IPv4 address of the home agent	2430
9.2.1.1.5	Void.....	2435
9.2.1.1.6	Void.....	2435
9.2.1.1.7	Attach Procedure / Success / List of equivalent PLMNs in the ATTACH ACCEPT message ...	2435
9.2.1.1.7a	Attach Procedure / Success / List of equivalent PLMNs in the ATTACH ACCEPT message / Single Frequency operation.....	2439
9.2.1.1.8	Void.....	2443
9.2.1.1.9	Attach / Rejected / IMSI invalid.....	2443
9.2.1.1.10	Attach / Rejected / Illegal ME	2446
9.2.1.1.11	Attach / Rejected / EPS services and non-EPS services not allowed	2447
9.2.1.1.12	Attach / Rejected / EPS services not allowed.....	2453
9.2.1.1.13	Attach / Rejected / PLMN not allowed.....	2457
9.2.1.1.13a	Attach / Rejected / PLMN not allowed / Single Frequency operation.....	2461
9.2.1.1.14	Attach / Rejected / Tracking area not allowed.....	2464
9.2.1.1.15	Attach / Rejected / Roaming not allowed in this tracking area.....	2469
9.2.1.1.15a	Attach / Rejected / Roaming not allowed in this tracking area / Single Frequency operation.....	2473
9.2.1.1.16	Attach / Rejected / EPS services not allowed in this PLMN	2476
9.2.1.1.16a	Attach / Rejected / EPS services not allowed in this PLMN / Single Frequency operation	2481
9.2.1.1.17	Attach / Rejected / No suitable cells in tracking area	2483
9.2.1.1.18	Attach / Rejected / Not authorized for this CSG	2488
9.2.1.1.19	Attach / Abnormal case / Failure due to non integrity protection.....	2491
9.2.1.1.20	Attach / Abnormal case / Access barred because of access class barring or NAS signalling connection establishment rejected by the network	2496

9.2.1.1.21	Attach / Abnormal case / Success after several attempts due to no network response	2501
9.2.1.1.22	Attach / Abnormal case / Unsuccessful attach after 5 attempts	2503
9.2.1.1.23	Attach / Abnormal case / Repeated rejects for network failures.....	2506
9.2.1.1.24	Attach / Abnormal case / Change of cell into a new tracking area	2510
9.2.1.1.25	Attach / Abnormal case / Mobile originated detach required	2514
9.2.1.1.26	Attach / Abnormal case / Detach procedure collision	2515
9.2.1.1.27	Attach / Abnormal case / Network reject with Extended Wait Timer	2518
9.2.1.1.28	Attach / Success / IMS	2521
9.2.1.2	Combined attach procedure for EPS services and non-EPS services.....	2524
9.2.1.2.1	Combined attach procedure / Success / EPS and non-EPS services	2524
9.2.1.2.1b	Combined attach procedure / Success / SMS only	2529
9.2.1.2.1c	Combined attach procedure / Success / EPS and CS Fallback not preferred.....	2538
9.2.1.2.1d	Combined attach procedure / Success / EPS and CS Fallback not preferred/data centric UE.....	2544
9.2.1.2.2	Combined attach procedure / Success / EPS services only / IMSI unknown in HSS	2549
9.2.1.2.3	Successful combined attach procedure / EPS service only / MSC temporarily not reachable	2556
9.2.1.2.4	Successful combined attach procedure / EPS service only / CS domain not available.....	2565
9.2.1.2.5	Combined attach / Rejected / IMSI invalid	2572
9.2.1.2.6	Combined attach / Rejected / Illegal ME.....	2576
9.2.1.2.7	Combined attach / Rejected / EPS services and non-EPS services not allowed	2577
9.2.1.2.8	Combined attach / Rejected / EPS services not allowed.....	2578
9.2.1.2.9	Combined attach / Rejected / PLMN not allowed	2581
9.2.1.2.10	Combined attach / Rejected / Tracking area not allowed	2585
9.2.1.2.11	Combined attach / Rejected / Roaming not allowed in this tracking area	2588
9.2.1.2.12	Combined attach / Rejected / EPS services not allowed in this PLMN.....	2595
9.2.1.2.13	Combined attach / Rejected / No suitable cells in tracking area.....	2599
9.2.1.2.14	Combined attach / Rejected / Not authorized for this CSG	2606
9.2.1.2.15	Combined attach / Abnormal case / Handling of the EPS attach attempt counter.....	2609
9.2.2	Detach procedure	2614
9.2.2.1	UE initiated detach procedure	2614
9.2.2.1.1	UE initiated detach / UE switched off	2614
9.2.2.1.2	UE initiated detach / USIM removed from the UE.....	2616
9.2.2.1.3	UE initiated detach / EPS capability of the UE is disabled	2618
9.2.2.1.4	UE initiated detach / detach for non-EPS services	2622
9.2.2.1.5	Void.....	2624
9.2.2.1.6	UE initiated detach / Abnormal case / Local detach after 5 attempts due to no network response	2624
9.2.2.1.7	UE initiated detach / Abnormal case / Detach procedure collision	2627
9.2.2.1.8	UE initiated detach / Abnormal case / Detach and EMM common procedure collision	2629
9.2.2.1.9	UE initiated detach / Abnormal case / Change of cell into a new tracking area.....	2632
9.2.2.1.10	UE initiated detach / Mapped security context.....	2635
9.2.2.2	Network initiated detach procedure	2638
9.2.2.2.1	NW initiated detach / Re-attach required	2638
9.2.2.2.2	NW initiated detach / IMSI detach	2640
9.2.2.2.3 to 9.2.2.2.13	Void.....	2643
9.2.2.2.14	NW initiated detach / Abnormal case / EMM cause not included.....	2643
9.2.3	Tracking area updating procedure (S1 mode only).....	2645
9.2.3.1	Normal and periodic tracking area updating	2645
9.2.3.1.1	Normal tracking area update / Accepted	2645
9.2.3.1.2	Void.....	2648
9.2.3.1.3	Void.....	2648
9.2.3.1.4	Normal tracking area update / List of equivalent PLMNs in the TRACKING AREA UPDATE ACCEPT message.....	2648
9.2.3.1.5	Periodic tracking area update / Accepted	2651
9.2.3.1.5a	Periodic tracking area update / Accepted / Per-device timer.....	2656
9.2.3.1.6	Normal tracking area update / UE with ISR active moves to E-UTRAN.....	2661
9.2.3.1.7	Void.....	2668
9.2.3.1.8	UE receives an indication that the RRC connection was released with cause "load balancing TAU required"	2668
9.2.3.1.9	Normal tracking area update / Correct handling of CSG list	2672
9.2.3.1.9a	Normal tracking area update / NAS signalling connection recovery.....	2676
9.2.3.1.10	Normal tracking area update / Rejected / IMSI invalid	2678
9.2.3.1.11	Normal tracking area update / Rejected / Illegal ME	2681

9.2.3.1.12	Normal tracking area update / Rejected / EPS service not allowed.....	2682
9.2.3.1.13	Normal tracking area update / Rejected / UE identity cannot be derived by the network	2683
9.2.3.1.14	Normal tracking area update / Rejected / UE implicitly detached.....	2686
9.2.3.1.15	Normal tracking area update / Rejected / PLMN not allowed.....	2687
9.2.3.1.15a	Normal tracking area update / Rejected / PLMN not allowed / Single Frequency operation.....	2692
9.2.3.1.16	Normal tracking area update / Rejected / Tracking area not allowed.....	2696
9.2.3.1.17	Normal tracking area update / Rejected / Roaming not allowed in this tracking area.....	2700
9.2.3.1.18	Normal tracking area update / Rejected / EPS services not allowed in this PLMN	2704
9.2.3.1.18a	Normal tracking area update / Rejected / EPS services not allowed in this PLMN / Single Frequency operation	2709
9.2.3.1.19	Normal tracking area update / Rejected / No suitable cells in tracking Area	2712
9.2.3.1.20	Normal tracking area update / Rejected / Not authorized for this CSG.....	2714
9.2.3.1.21	Void.....	2717
9.2.3.1.22	Normal tracking area update / Abnormal case / access barred due to access class control or NAS signalling connection establishment rejected by the network.....	2717
9.2.3.1.23	Normal tracking area update / Abnormal case / Success after several attempts due to no network response / TA belongs to TAI list and status is UPDATED / TA does not belong to TAI list or status is not UPDATED.....	2722
9.2.3.1.24	Void.....	2728
9.2.3.1.25	Normal tracking area update / Abnormal case / Failure after 5 attempts due to no network response	2728
9.2.3.1.26	Normal tracking area update / Abnormal case / TRACKING AREA UPDATE REJECT	2734
9.2.3.1.27	Normal tracking area update / Abnormal case / Change of cell into a new tracking area	2738
9.2.3.1.28	Normal tracking area update / Abnormal case / Tracking area updating and detach procedure collision	2741
9.2.3.2	Combined tracking area updating	2743
9.2.3.2.1	Combined tracking area update / Successful.....	2743
9.2.3.2.1a	Combined tracking area update / Successful / Check of last visited TAI and handling of TAI list, LAI and TMSI	2748
9.2.3.2.1b	Combined tracking area update / Success / SMS only	2758
9.2.3.2.1c	Combined tracking area update / Success / CS Fallback not preferred	2765
9.2.3.2.2	Combined tracking area update / Successful for EPS services only / IMSI unknown in HSS	2769
9.2.3.2.3	Combined tracking area update / Successful for EPS services only / MSC temporarily not reachable.....	2772
9.2.3.2.4	Combined tracking area update / Successful for EPS services only / CS domain not available..	2779
9.2.3.2.5	Combined tracking area update / Rejected / IMSI invalid.....	2781
9.2.3.2.6	Combined tracking area update / Rejected / Illegal ME	2784
9.2.3.2.7	Combined tracking area update / Rejected / EPS services and non-EPS services not allowed ...	2785
9.2.3.2.8	Combined tracking area update / Rejected / EPS services not allowed.....	2785
9.2.3.2.9	Combined tracking area update / Rejected / UE identity cannot be derived by the network.....	2789
9.2.3.2.10	Combined tracking area update / Rejected / UE implicitly detached	2794
9.2.3.2.11	Combined tracking area update / Rejected / PLMN not allowed	2796
9.2.3.2.12	Combined tracking area update / Rejected / Tracking area not allowed.....	2801
9.2.3.2.13	Combined tracking area update / Rejected / Roaming not allowed in this tracking area.....	2805
9.2.3.2.14	Combined tracking area update / Rejected / EPS services not allowed in the PLMN	2809
9.2.3.2.15	Combined tracking area update / Rejected / No suitable cells in tracking area.....	2813
9.2.3.2.16	Combined tracking area update / Rejected / Not authorized for this CSG	2815
9.2.3.2.17	Combined tracking area update / Abnormal case / handling of the EPS tracking area updating attempt counter.....	2818
9.2.3.3	Iu mode to S1 mode inter-system change in idle mode.....	2822
9.2.3.3.1	First Iu mode to S1 mode inter-system change after attach.....	2822
9.2.3.3.2	Iu mode to S1 mode intersystem change / ISR is active / Expiry of T3312 in E-UTRAN or T3412 in UTRAN and further intersystem change.....	2833
9.2.3.3.3	Iu mode to S1 mode intersystem change / Periodic TAU and RAU/ ISR activated, T3423 expired	2842
9.2.3.3.4	First S1 mode to Iu mode inter-system change after attach.....	2848
9.2.3.3.5	Periodic routing area update	2864
9.2.3.3.5a	Periodic Location Update	2872
9.2.3.3.6	E-UTRAN RRC connection failure / Reselection of UTRAN cell / NAS signalling to release old S1 interface connection	2876
9.2.3.4	A/Gb mode to S1 mode inter-system change	2878
9.2.3.4.1	TAU/RAU procedure for inter-system cell reselection between A/Gb and S1 modes	2878

9.3	EMM connection management procedures (S1 mode only)	2891
9.3.1	Service request procedure	2891
9.3.1.1	Service request initiated by UE for user data	2891
9.3.1.2	Void.....	2894
9.3.1.3	Service request / Mobile originating CS fallback.....	2894
9.3.1.4	Service request / Rejected / IMSI invalid.....	2897
9.3.1.5	Service request / Rejected / Illegal ME.....	2903
9.3.1.6	Service request / Rejected / EPS services not allowed.....	2905
9.3.1.7	Service request / Rejected / UE identity cannot be derived by the network.....	2910
9.3.1.7a	Service request / Rejected / UE implicitly detached	2912
9.3.1.8 to 9.3.1.12	Void.....	2914
9.3.1.12a	Extended service request / Rejected / CS domain temporarily not available	2914
9.3.1.13	Void.....	2916
9.3.1.14	Void.....	2916
9.3.1.15	Void.....	2916
9.3.1.16	Service request / Abnormal case / Switch off	2916
9.3.1.17	Service request / Abnormal case / Procedure collision	2917
9.3.1.18	Service Request / Rejected / Not authorized for this CSG	2920
9.3.2	Paging procedure	2923
9.3.2.1	Paging procedure.....	2923
9.3.2.2	Paging for CS fallback / Idle mode	2924
9.3.2.2a	Paging for CS fallback / Connected mode	2927
9.4	NAS Security.....	2930
9.4.1	Integrity protection / Correct functionality of EPS NAS integrity algorithm / SNOW3G.....	2930
9.4.2	Integrity protection / Correct functionality of EPS NAS integrity algorithm / AES.....	2933
9.4.3	Ciphering and deciphering / Correct functionality of EPS NAS encryption algorithm / SNOW3G	2933
9.4.4	Ciphering and deciphering / Correct functionality of EPS NAS encryption algorithm / AES.....	2937
9.4.5	Integrity protection / Correct functionality of EPS NAS integrity algorithm / ZUC	2937
9.4.6	Ciphering and deciphering / Correct functionality of EPS NAS encryption algorithm / ZUC	2938
10	EPS session management	2939
10.1	Void.....	2939
10.2	Dedicated EPS bearer context activation.....	2939
10.2.1	Dedicated EPS bearer context activation / Success	2939
10.3	EPS bearer context modification	2941
10.3.1	EPS bearer context modification / Success.....	2941
10.4	EPS bearer context deactivation	2945
10.4.1	EPS bearer context deactivation / Success.....	2945
10.4.2	EPS bearer context deactivation / Re-establishment.....	2958
10.5	UE requested PDN connectivity.....	2961
10.5.1	UE requested PDN connectivity accepted by the network	2961
10.5.2	Void	2968
10.5.3	UE requested PDN connectivity not accepted	2968
10.5.4	UE requested PDN connectivity not accepted / Network reject with Extended Wait Timer	2973
10.6	UE requested PDN disconnect	2977
10.6.1	UE requested PDN disconnect procedure accepted by the network	2977
10.6.2	Void	2980
10.7	UE requested bearer resource allocation	2980
10.7.1	UE requested bearer resource allocation accepted by the network / New EPS bearer context	2980
10.7.2	UE requested bearer resource allocation accepted by the network / Existing EPS bearer context	2982
10.7.3	UE requested bearer resource allocation not accepted by the network	2984
10.7.4	UE requested bearer resource allocation / Expiry of timer T3480.....	2987
10.7.5	UE requested bearer resource allocation / BEARER RESOURCE ALLOCATION REJECT message including cause #43 "invalid EPS bearer identity"	2989
10.8	UE requested bearer resource modification.....	2992
10.8.1	UE requested bearer resource modification accepted by the network / New EPS bearer context	2992
10.8.2	UE requested bearer resource modification accepted by the network / Existing EPS bearer context.....	2994
10.8.3	UE requested bearer resource modification not accepted by the network	2996
10.8.4	UE requested bearer resource modification / Cause #36 "regular deactivation"	2999
10.8.5	UE requested bearer resource modification / BEARER RESOURCE MODIFICATION REJECT message including cause #43 "invalid EPS bearer identity"	3002

10.8.6	UE requested bearer resource modification / Collision of a UE requested bearer resource modification procedure and EPS bearer context deactivation procedure.....	3005
10.8.7	UE requested bearer resource modification / Expiry of timer T3481	3007
10.9	UE routing of uplink packets.....	3010
10.9.1	UE routing of uplinks packets.....	3010
11	General tests	3033
11.1	SMS over SGs	3033
11.1.1	MT-SMS over SGs / Idle mode	3033
11.1.2	MT-SMS over SGs / Active mode.....	3035
11.1.3	MO-SMS over SGs / Idle mode.....	3038
11.1.4	MO-SMS over SGs / Active mode	3041
11.1.5	Multiple MO-SMS over SGs / Idle mode	3044
11.1.6	Multiple MO-SMS over SGs / Active mode.....	3049
11.2	Emergency calls over IMS	3053
11.2.0	General.....	3053
11.2.1	Emergency bearer services / Normal cell / NORMAL-SERVICE / Local Emergency Numbers List sent in the Attach / PDN connect new emergency EPS bearer context / Service request / Emergency PDN disconnect	3053
11.2.2	Emergency bearer services / Normal cell / LIMITED-SERVICE / Attach / PDN connect	3058
11.2.3	Emergency bearer services / CSG cell / LIMITED-SERVICE / Attach / Security mode control procedure without prior authentication / PDN connect / Service request / PDN disconnect / Detach upon UE switched off / Temporary storage of EMM information.....	3060
11.2.4	Emergency bearer services / Normal cell / NO-IMSI / Attach / No EPS security context / PDN connect / Service request / Timer T3412 expires.....	3066
11.2.5	Emergency bearer services / Normal cell / NORMAL-SERVICE / Local Emergency Numbers List NOT sent in the Attach / PDN connect new emergency EPS bearer context / Authentication SQN code failure - MME aborts authentication continues using current security context / Service request...	3071
11.2.6	Handling of Local Emergency Numbers List provided during Attach and Normal tracking area update procedures	3075
11.2.7	UE has PDN connection for emergency bearer services / Normal tracking area update / Accepted / Local Emergency Numbers List is not sent by the network / Handling of the lists of forbidden tracking areas	3081
11.2.8	Attach for emergency bearer services / Rejected / No suitable cells in tracking area / Emergency call using the CS domain / UTRA or GERAN	3088
11.2.8a	Attach for emergency bearer services / Rejected / No suitable cells in tracking area / Emergency call using the CS domain / CDMA 2000 1xRTT.....	3092
11.2.9	Void	3094
11.2.10	LIMITED-SERVICE / EPS does not support IMS Emergency / Emergency call using the CS domain	3094
11.2.11	LIMITED-SERVICE / Inter-system mobility / E-UTRA to UTRA CS / SRVCC Emergency Call Handover to UTRAN.....	3098
12	E-UTRA radio bearer tests	3108
12.1	General	3108
12.1.0	Definition of radio bearer combinations	3108
12.1.1	Generic E-UTRA radio bearer test procedure / MIMO not configured	3108
12.1.2	Generic E-UTRA radio bearer test procedure / MIMO configured	3110
12.2	MIMO not configured	3111
12.2.1	Data transfer of E-UTRA radio bearer combinations 1, 3, 6 and 9.....	3111
12.2.2	Data transfer of E-UTRA radio bearer combinations 2,4,7 and 10.....	3112
12.2.3	Data transfer of E-UTRA radio bearer combinations 5,8,11 and 12.....	3113
12.2.4	Data transfer of E-UTRA radio bearer combination 13.....	3114
12.3	MIMO configured	3115
12.3.1	Data transfer of E-UTRA radio bearer combinations 1,3,6 and 9 / MIMO	3115
12.3.2	Data transfer of E-UTRA radio bearer combinations 2,4,7 and 10 / MIMO	3116
12.3.3	Data transfer of E-UTRA radio bearer combinations 5,8,11 and 12 / MIMO	3117
12.3.4	Data transfer of E-UTRA radio bearer combination 13 / MIMO.....	3118
13	Multi layer Procedures	3119
13.1	Call setup.....	3119
13.1.1	Activation and deactivation of additional data radio bearer in E-UTRA.....	3119
13.1.2	Call setup from E-UTRAN RRC_IDLE / CS fallback to UTRAN with redirection / MO call	3123

13.1.2a	Call setup from E-UTRAN RRC_IDLE / CS fallback to UTRAN with redirection including System Information / MO call	3126
13.1.3	Call setup from E-UTRAN RRC_CONNECTED / CS fallback to UTRAN with Redirection / MT call	3133
13.1.4	Call setup from E-UTRAN RRC_IDLE / CS fallback to UTRAN with Handover / MT call	3142
13.1.5	Call setup from E-UTRAN RRC_CONNECTED / CS fallback to UTRAN with handover / MO call..	3153
13.1.6	Void	3157
13.1.7	Call setup from E-UTRA RRC_IDLE / CS fallback to GSM with redirection / MT call.....	3157
13.1.8	Call setup from E-UTRA RRC_CONNECTED/ CS fallback to GSM with Redirection / MO call.....	3168
13.1.9	Call setup from E-UTRA RRC_IDLE / CS fallback to GSM with CCO without NACC / MO call.....	3174
13.1.10	Call setup from E-UTRA RRC_CONNECTED / CS fallback to GSM with CCO without NACC / MT call	3178
13.1.11	Call setup from E-UTRA RRC_IDLE / CS fallback to GSM with PSHO / EDTM not supported / MT call	3186
13.1.12	Call setup from E-UTRA RRC_CONNECTED / CS fallback to GSM with PSHO / EDTM not supported / MO call	3196
13.1.13	Call setup from E-UTRA RRC_IDLE / CS fallback to GSM with PSHO / EDTM supported / MT call	3202
13.1.14	3213
13.1.15	Call setup from E-UTRAN RRC_IDLE / CS fallback to UTRAN with redirection / MT call / UTRAN cell is barred.....	3213
13.1.16	Emergency call setup from E-UTRAN RRC_IDLE / CS fallback to UTRAN with handover.....	3217
13.1.17	Call setup from E-UTRAN RRC_IDLE / mobile originating 1xCS fallback emergency call to 1xRTT	3221
13.1.18	Call setup from E-UTRAN RRC_IDLE / mobile originating enhanced 1xCS fallback emergency call to 1xRTT	3226
13.2	RRC connection reconfiguration.....	3238
13.2.1	RRC connection reconfiguration / E-UTRA to E-UTRA	3238
13.3	Connection re-establishment	3242
13.3.1	Intra-system connection re-establishment.....	3242
13.3.1.1	Intra-system connection re-establishment / Radio link recovery while T310 is running	3242
13.3.1.2	Intra-system connection re-establishment / Re-establishment of a new connection when further data is to be transferred	3244
13.3.1.3	RRC connection reconfiguration / Full configuration / DRB establishment.....	3246
13.3.2	Inter-system connection re-establishment.....	3251
13.3.2.1	Inter-system connection re-establishment / E-UTRAN to UTRAN / Further data are to be transferred	3251
13.3.2.2	Inter-system connection re-establishment / E-UTRAN to GPRS / Further data are to be transferred	3254
13.4	Mobility.....	3256
13.4.1	Intra-system mobility.....	3256
13.4.1.1	3256
13.4.1.2	Inter-frequency mobility / E-UTRA to E-UTRA packet.....	3256
13.4.1.3	Intra-system mobility / E-UTRA FDD to E-UTRA TDD to E-UTRA FDD packet	3260
13.4.1.4	Inter-band mobility / E-UTRA to E-UTRA packet.....	3267
13.4.1.5	RRC connection reconfiguration / Handover/ Full configuration / DRB establishment	3271
13.4.2	Inter-system mobility packet.....	3276
13.4.2.1	Inter-system mobility / E-UTRA to UTRA packet	3276
13.4.2.2	Inter-system mobility / E-UTRAN to GPRS packet	3286
13.4.2.3	3298
13.4.2.4	Inter-system mobility / Service based redirection from UTRA to E-UTRA	3298
13.4.2.5	Inter-system mobility/Service based redirection from GSM/GPRS to E-UTRA	3302
13.4.2.6	Inter-RAT PS Handover / from GPRS Packet_transfer to E-UTRA cell	3305
13.4.2.7	Inter-RAT PS Handover / Synchronised / From GPRS Packet_transfer to E-UTRA cell (CCN mode)	3309
13.4.2.8	Inter-RAT PS Handover / Synchronised / From GPRS Packet_transfer to E-UTRA cell (NC2 mode)	3314
13.4.3	Inter-system mobility voice	3320
13.4.3.0	General	3320
13.4.3.1	Inter-system mobility / E-UTRA voice to UTRA CS voice / SRVCC.....	3320
13.4.3.2	Inter-system mobility / E-UTRA PS voice + PS data to UTRA CS voice + PS data / SRVCC.....	3328
13.4.3.3	Inter-system mobility / E-UTRA voice to GSM CS voice / SRVCC.....	3339

13.4.3.4	Inter-system mobility / E-UTRA voice to UTRA CS voice / Unsuccessful case / Retry on old cell / SRVCC	3346
13.4.3.5	Inter-system mobility / E-UTRA voice to GSM CS voice / Unsuccessful case / Retry on old cell / SRVCC	3356
13.4.3.6	Inter-system mobility / E-UTRA PS voice + PS Data / HO cancelled / Notification procedure / SRVCC	3367
13.4.3.7	Inter-system mobility / E-UTRA voice to UTRA CS voice / aSRVCC / MO call.....	3372
13.4.3.8	Inter-system mobility / E-UTRA voice to UTRA CS voice / aSRVCC / MO call / Forked responses	3382
13.4.3.9	Inter-system mobility / E-UTRA voice to UTRA CS voice / aSRVCC / MO call / SRVCC HO failure	3394
13.4.3.10	Inter-system mobility / E-UTRA voice to UTRA CS voice / aSRVCC / MT call	3404
13.4.3.11	Inter-system mobility / E-UTRA voice to UTRA CS voice / aSRVCC / MT call / SRVCC HO failure	3415
13.4.3.12	Inter-system mobility / E-UTRA voice to UTRA CS voice / aSRVCC / MT call / User answers in PS domain	3424
13.4.3.13	Inter-system mobility / E-UTRA voice to UTRA CS voice / aSRVCC / MT call / User answers in PS domain / SRVCC HO cancelled	3435
13.4.3.14	Inter-system mobility / E-UTRA PS voice + PS data to UTRA CS voice + PS data / aSRVCC / MO call	3442
13.4.3.15	Inter-system mobility / E-UTRA PS voice + PS data to UTRA CS voice + PS data / aSRVCC / MO call / SRVCC HO cancelled.....	3448
13.4.3.16	Inter-system mobility / E-UTRA PS voice + PS data to UTRA CS voice + PS data / aSRVCC / MT call.....	3455
13.4.3.17	Inter-system mobility / E-UTRA PS voice + PS data to UTRA CS voice + PS data / aSRVCC / MT call / SRVCC HO cancelled	3461
13.4.4	Inter-system session management.....	3469
13.4.4.1	Pre-registration at 1xRTT and Cell reselection / 1x Zone Registration	3469
13.4.4.2	Pre-registration at 1xRTT and Cell reselection / 1x Ordered Registration.....	3476
13.4.4.3	Inter-system session management / Multiple PDN connection establishment in eHRPD pre-registration state	3480
13.4.4.4	Inter-system session management / Pre-registration at HRPD and Cell reselection / HRPD Zone Registration	3487
13.4.4.5	Pre-Registration at 1xRTT / Power Down Registration.....	3495
14	ETWS	3501
14.1	ETWS reception in RRC_IDLE state / Duplicate detection.....	3501
14.2	ETWS reception in RRC_CONNECTED state / Duplicate detection.....	3505
14.3	Void.....	3510
15	Mobility management based on DSMIPv6 (Dual-Stack Mobile IPv6).....	3510
15.1	Discovery of the home agent via DNS	3510
15.2	Discovery of the Home Agent via DHCP	3512
15.3	Void.....	3515
15.4	Security association establishment with Home Agent reallocation procedure	3515
15.5	Security association establishment without home agent reallocation procedure	3526
15.6	Registration of a new IPv6 CoA (Binding Update/Acknowledgment procedure in IPv6 network)	3540
15.7	Registration of a new IPv4 CoA (Binding Update/Acknowledgment procedure in IPv4 network)	3543
15.8	Re-registration of IPv6 CoA.....	3546
15.9	Re-registration of IPv4 CoA.....	3547
15.10	Return to home link	3548
15.11	Dual-Stack Mobile IPv6 detach in IPv6 network	3550
15.12	Dual-Stack Mobile IPv6 detach in IPv4 network	3552
16	Home (e)NB related	3555
16.1	UE Idle Mode Operations.....	3555
16.1.1	Cell Selection and Reselection.....	3555
16.1.1.1	Void.....	3555
16.1.1.2	Void.....	3555
17	MBMS in LTE	3555
17.1	MCCH Information Acquisition.....	3555
17.1.1	MCCH information acquisition/ UE is switched on	3555

17.1.2	MCCH information acquisition/ cell reselection to a cell in a new MBSFN area	3557
17.1.3	MCCH information acquisition/ UE handover to a cell in a new MBSFN area	3560
17.1.4	MCCH information acquisition/ UE is receiving an MBMS service.....	3564
17.1.5	MCCH information acquisition/ UE is not receiving MBMS data	3566
17.2	MBMS Data Reception	3570
17.2.1	UE Acquire the MBMS data based on the SIB13 and MCCH message /MCCH and MTCH are on the same MCH	3570
17.2.2	UE Acquire the MBMS data based on the SIB13 and MCCH message /MCCH and MTCH are on different MCHs	3575
17.2.3	UE receives the MBMS data when this data is in the beginning of the MSP	3580
17.2.4	Reception of PDCCH DCI format 0 and PHICH in MBSFN subframes.....	3585
17.3	MBMS Counting Procedure	3588
17.3.1	MBMS Counting / UE not receiving MBMS service	3588
17.3.2	MBMS Counting / UE receiving MBMS service.....	3592
17.4	MBMS Service Continuity	3596
17.4.1	Cell reselection to intra-frequency cell to continue MBMS service reception.....	3596
17.4.2	Cell reselection to inter- frequency cell to start MBMS service reception	3600
17.4.3	3603
17.4.4	Handover to intra-frequency cell to continue MBMS service reception.....	3603
17.4.5	3607
17.4.6	MBMS Interest Indication retransmission after returning from cell not broadcasting SIB15	3607
17.4.7	MBMS Interest Indication after Radio Link Failure.....	3612
17.4.8	Continued MBMS service reception after E-UTRAN release of unicast bearer.....	3616
18	PWS.....	3618
18.1	CMAS on LTE	3618
18.1.1	PWS reception in RRC_IDLE state / Duplicate detection	3618
18.1.2	PWS reception in RRC_CONNECTED state / Duplicate detection.....	3624
18.1.3	PWS reception in RRC_CONNECTED State/Power On	3629
Annex A (informative): Change history		3635
History		3705

Foreword

This Technical Specification has been produced by the 3rd Generation Partnership Project (3GPP).

The contents of the present document are subject to continuing work within the TSG and may change following formal TSG approval. Should the TSG modify the contents of the present document, it will be re-released by the TSG with an identifying change of release date and an increase in version number as follows:

Version x.y.z

where:

- x the first digit:
 - 1 presented to TSG for information;
 - 2 presented to TSG for approval;
 - 3 or greater indicates TSG approved document under change control.
- y the second digit is incremented for all changes of substance, i.e. technical enhancements, corrections, updates, etc.
- z the third digit is incremented when editorial only changes have been incorporated in the document.

Introduction

The present document is the first part of a multi-part conformance specification. 3GPP TS 36.523-2 [18] contains a proforma for the Implementation Conformance Statement (ICS) and an applicability table, indicating the release from which each test case is applicable. 3GPP TS 36.523-3 [19] contains a TTCN-3 design frame work, test model and Test Suites (the detailed test specifications in TTCN-3).

For at least a minimum set of services, the prose descriptions of test cases will have a matching detailed test case implemented in TTCN [19].

The present document may contain descriptions of tests for additional services, but these tests may not have matching TTCN test cases.

The present document will not contain any tests on the USIM, or the interface between the UE and the USIM. These tests are documented elsewhere.

1 Scope

The present document specifies the protocol conformance testing for the 3rd Generation E-UTRAN User Equipment (UE).

This is the first part of a multi-part test specification. The following information can be found in this part:

- the overall test structure;
- the test configurations;
- the conformance requirement and reference to the core specifications;
- the test purposes; and
- a brief description of the test procedure, the specific test requirements and short message exchange table.

The following information relevant to testing could be found in accompanying specifications:

- the default setting of the test parameters [18];
- the applicability of each test case [19].

A detailed description of the expected sequence of messages could be found in the 3rd part of this test specification.

The Implementation Conformance Statement (ICS) pro-forma could be found in the 2nd part of the present document.

The present document is valid for UE implemented according to 3GPP releases starting from Release 8 up to the Release indicated on the cover page of the present document.

2 References

The following documents contain provisions which, through reference in this text, constitute provisions of the present document.

- References are either specific (identified by date of publication, edition number, version number, etc.) or non-specific.
- For a specific reference, subsequent revisions do not apply.
- For a non-specific reference, the latest version applies. In the case of a reference to a 3GPP document (including a GSM document), a non-specific reference implicitly refers to the latest version of that document in the same Release as the present document.

- [1] 3GPP TR 21.905: "Vocabulary for 3GPP Specifications".
- [2] 3GPP TS 23.003: "Numbering, Addressing and Identification".
- [3] 3GPP TS 23.122: "Non-Access-Stratum functions related to Mobile Station (MS) in idle mode".
- [4] 3GPP TS 24.008: "Mobile Radio Interface Layer 3 specification; Core Network Protocols; Stage 3".
- [5] 3GPP TS 34.108: "Common Test Environments for User Equipment (UE) Conformance Testing".
- [6] 3GPP TS 34.109: "Terminal logical test interface; Special conformance testing functions".
- [7] 3GPP TS 34.123-1: "User Equipment (UE) conformance specification; Part 1: Protocol conformance specification".
- [8] 3GPP TS 34.123-2: "User Equipment (UE) conformance specification; Part 2: Implementation Conformance Statement (ICS) proforma specification".

- [9] 3GPP TS 34.123-3: "User Equipment (UE) conformance specification; Part 3: Abstract Test Suites (ATS)".
- [10] 3GPP TS 36.300: "Evolved Universal Terrestrial Radio Access (E-UTRA) and Evolved Universal Terrestrial Radio Access Network (E-UTRAN); Overall description; Stage 2".
- [11] 3GPP TS 36.302: "Services provided by the physical layer for E-UTRA".
- [12] 3GPP TS 36.304: "Evolved Universal Terrestrial Radio Access (E-UTRA) User Equipment (UE) Procedures in idle mode".
- [13] 3GPP TS 36.306: "Evolved Universal Terrestrial Radio Access (E-UTRA) User Equipment (UE) Radio Access capabilities".
- [14] 3GPP TS 36.321: "Evolved Universal Terrestrial Radio Access (E-UTRA) Medium Access Control (MAC) protocol specification".
- [15] 3GPP TS 36.322: "Evolved Universal Terrestrial Radio Access (E-UTRA) Radio Link Control (RLC) protocol specification".
- [16] 3GPP TS 36.323: "Evolved Universal Terrestrial Radio Access (E-UTRA) Packet Data Convergence Protocol (PDCP) specification".
- [17] 3GPP TS 36.331: "Evolved Universal Terrestrial Radio Access (E-UTRA) Radio Resource Control (RRC) Protocol Specification".
- [18] 3GPP TS 36.508: "Evolved Universal Terrestrial Radio Access (E-UTRA) and Evolved Universal Terrestrial Radio Access (E-UTRAN); Common Test Environments for User Equipment (UE) Conformance Testing".
- [19] 3GPP TS 36.523-2: "Evolved Universal Terrestrial Radio Access (E-UTRA) and Evolved Universal Terrestrial Radio Access (E-UTRAN); User Equipment (UE) conformance specification; Part 2: Implementation Conformance Statement (ICS) proforma specification".
- [20] 3GPP TS 36.523-3: "Evolved Universal Terrestrial Radio Access (E-UTRA) and Evolved Universal Terrestrial Radio Access (E-UTRAN); User Equipment (UE) conformance specification; Part 3: Abstract Test Suites (ATS)".
- [21] 3GPP TR 24.801: "3GPP System Architecture Evolution; CT WG1 Aspects".
- [22] 3GPP TS 23.401: "3GPP System Architecture Evolution; GPRS enhancements for E-UTRAN access".
- [23] 3GPP TS 51.010-1: "Mobile Station (MS) conformance specification; Part 1: Conformance specification".
- [24] ISO/IEC 9646 (all parts): "Information technology - Open Systems Interconnection - Conformance testing methodology and framework".
- [25] 3GPP TS 36.509: "Evolved Universal Terrestrial Radio Access (E-UTRA) and Evolved Universal Terrestrial Radio Access Network (E-UTRAN); Special conformance testing functions for User Equipment (UE)".
- [26] 3GPP TS 33.102: "3G Security; Security architecture"
- [27] 3GPP TS 33.401: "3GPP System Architecture Evolution (SAE); Security architecture".
- [28] 3GPP TS 24.301: "Non-Access-Stratum (NAS) protocol for Evolved Packet System (EPS); Stage 3".
- [29] 3GPP TS 36.212: "Evolved Universal Terrestrial Radio Access (E-UTRA); Multiplexing and channel coding".
- [30] 3GPP TS 36.213: "Evolved Universal Terrestrial Radio Access (E-UTRA); Physical layer procedures"

- [31] 3GPP TS 36.101: "Evolved Universal Terrestrial Radio Access (E-UTRA); User Equipment (UE) radio transmission and reception"
- [32] 3GPP TS 24.008: "Mobile radio interface layer 3 specification; Core network protocols; Stage 3".
- [33] 3GPP2 A.S0008-C v4.0: "Interoperability Specification (IOS) for High Rate Packet Data (HRPD) Radio Access Network Interfaces with Session Control in the Access Network"
- [34] 3GPP TS 36.133: "Evolved Universal Terrestrial Radio Access (E-UTRA); Requirements for support of radio resource management"
- [35] 3GPP TS 34.229-1: "Internet Protocol (IP) multimedia call control protocol based on Session Initiation Protocol (SIP) and Session Description Protocol (SDP); User Equipment (UE) conformance specification; Part 1: Protocol conformance specification".
- [36] 3GPP TS 45.008: "Technical Specification Group GSM/EDGE Radio Access Network; Radio subsystem link control"
- [37] 3GPP TS 44.060: "General Packet Radio Service (GPRS); Mobile Station (MS) - Base Station System (BSS) interface; Radio Link Control (RLC) / Medium Access Control (MAC) protocol"
- [38] 3GPP TS 44.018: "Technical Specification Group GSM/EDGE Radio Access Network; Mobile radio interface layer 3 specification; Radio Resource Control Protocol"
- [39] 3GPP TS 43.022: "Functions related to Mobile Station (MS) in idle mode and group receive mode"
- [40] 3GPP TS 25.133: "Requirements for support of Radio Resource Management (FDD)"
- [41] 3GPP TS 25.123: "Requirements for support of Radio Resource Management (TDD)"
- [42] 3GPP TS 25.304: "UE Procedures in Idle Mode and Procedures for Cell Reselection in Connected Mode"
- [43] 3GPP TS 25.367: "Mobility Procedures for Home NodeB; Overall Description; Stage 2"
- [44] 3GPP TS 36.211: "Evolved Universal Terrestrial Radio Access (E-UTRA); Physical Channels and Modulation"
- [45] 3GPP TS 23.041: "Technical realization of Cell Broadcast Service (CBS)"
- [46] 3GPP TS 24.303: "Mobility management based on Dual-Stack Mobile IPv6; Stage 3"
- [47] 3GPP TS 23.272: "Circuit Switched (CS) fallback in Evolved Packet System (EPS); Stage 2".
- [48] 3GPP2 C.S0005- Fv1.0: "Upper Layer (Layer 3) Signaling Standard for cdma2000 Spread Spectrum Systems - Release F".

3 Definitions, symbols and abbreviations

3.1 Definitions

For the purposes of the present document, the terms and definitions given in TR 21.905 [1] and the following apply. A term defined in the present document takes precedence over the definition of the same term, if any, in TR 21.905 [1].

example: text used to clarify abstract rules by applying them literally.

Floor: Floor(x) is the largest integer smaller than or equal to x.

Ceil: Ceil (x) is the smallest integer larger than or equal to x.

3.2 Abbreviations

For the purposes of the present document, the abbreviations given in TR 21.905 [1] and the following apply. An abbreviation defined in the present document takes precedence over the definition of the same abbreviation, if any, in TR 21.905 [1].

ENB	Evolved Node B
FDD	Frequency Division Duplex
FFS	For Further Study
ICS	Implementation Conformance Statement
ROHC	RObust Header Compression

4 Overview

4.1 Test methodology

4.1.1 Testing of optional functions and procedures

Any function or procedure which is optional, as indicated in the present document, may be subject to a conformance test if it is implemented in the UE.

A declaration by the apparatus supplier (ICS) is used to determine whether an optional function/procedure has been implemented.

4.1.2 Test interfaces and facilities

Detailed descriptions of the UE test interfaces and special facilities for testing is provided in 3GPP TS 36.509 [25].

4.2 Implicit testing

For some 3GPP signalling and protocol features conformance is not verified explicitly in the present document. This does not imply that correct functioning of these features is not essential, but that these are implicitly tested to a sufficient degree in other tests.

4.3 Repetition of tests

As a general rule, the test cases specified in the present document are highly reproducible and don't need to be repeated unless otherwise stated. However, the rate of correct UE behaviour such as cell re-selection, measurement and handover is specified statistically, e.g. "at least 90%" [34]. Additionally, in some of the test cases, presented in TS 36.523-3 clause 7.3.2, HARQ retransmissions are not tolerated, because of characteristics of the test case [20]. It is the case that for those tests expecting such UE behaviour (stated above) are not 100% reproducible, therefore if a UE does not pass the test after its first trial and the tester suspects the reason is due to the statistical nature of the test, then the UE should be re-tested one or more times. For non-HARQ retransmission tolerant test cases re-testing applies, when test case does not pass, which is caused by unspecified HARQ retransmission.

4.4 Handling of differences between conformance requirements in different releases of cores specifications

The conformance requirements which determine the scope of each test case are explicitly copy-pasted from relevant core specifications in the especially dedicated for this section of each test with the title '[Conformance requirements](#)'.

[When](#) differences between conformance requirements in different releases of the cores specifications have impact on the Pre-test conditions, Test procedure sequence or/and the Specific message contents, the Conformance requirements related to different releases are specified separately with clear indication of the Release of the spec from which they were copied.

When there is no Release indicated for a conformance requirement text, this should be understood either as the Conformance requirements in the latest version of the spec with release = the TC Applicability release (which can be found in 36.523-2, Table 4-1: Applicability of tests and additional information for testing, column 'Release'), or, as the

Conformance requirements in the latest version of the spec of the release when the feature was introduced to the core specs.

5 Reference conditions

The reference environments used by all signalling and protocol tests will be specified in TS 36.508 [18]. Where a test requires an environment that is different, this will be specified in the test itself.

5.1 Generic setup procedures

A set of basic generic procedures for radio resource signalling, and generic setup procedures for layer 3 NAS signalling will be described in TS 36.508 [18]. These procedures will be used in numerous test cases throughout the present document.

6 Idle mode operations

6.0 Introduction

6.0.1 PLMN and TAC

The PLMN numbers indicated in Table 6.0.1-1 are used in test cases to associate a cell with an MCC and MNC for that cell. If no PLMN is explicitly specified, the default value is PLMN 1.

Table 6.0.1-1: Tracking Area Identity (TAI) in System Information Block Type 1 broadcast on the BCCH (E-UTRAN)

PLMN	MCC1	MCC2	MCC3	MNC1	MNC2	MNC3	TAC
1	0	0	1	0	1	Not present	See Table 6.0.1-2
2	0	0	2	1	1	Not present	
3	0	0	3	2	1	Not present	
4	0	0	4	3	1	Not present	
5	0	0	5	4	1	Not present	
6	0	0	6	5	1	Not present	
7	0	0	7	6	1	Not present	
8	0	0	8	7	1	Not present	
9	0	0	9	0	2	Not present	
10	0	1	0	1	2	Not present	
11	0	1	1	2	2	Not present	
12	0	1	2	3	2	Not present	
13	0	0	2	8	1	Not present	
14	0	0	2	9	1	Not present	
15	0	0	1	1	1	Not present	
16	0	0	1	2	1	Not present	
17	0	0	1	3	1	Not present	
18	0	0	1	4	1	Not present	

NOTE: The Location Area Information (LAI) for UTRA and GSM could be re-used from TS 34.123-1 clause 6.

If no TAC for E-UTRAN cell is explicitly specified in the test case description, the TACs for E-UTRAN cells indicated in Table 6.0.1-2 are used in the test case.

Table 6.0.1-2: Tracking Area Code (TAC) for E-UTRAN cells

cell ID	TAC
Cell 1	1
Cell 2	2
Cell 3	3
Cell 4	4
Cell 6	6
Cell 10	10
Cell 11	11
Cell 12	12
Cell 13	13
Cell 14	14
Cell 23	23
Cell 28	28
Cell 29	29
Cell 30	30

If no RAI for UTRAN cell is explicitly specified in the test case description, the RAI for UTRAN cells indicated in Table 4.4.4-2 in [18] are used in the test case.

6.0.2 Other

6.0.2.1 Values of parameters calculated by the UE

Values of some parameters calculated by the UE, such as *Srxlev*, are provided in the test case description without explicitly taking into account SS signal generation and UE measurement uncertainties. These values are for information purpose only and therefore shall not be directly used to determine the UE behaviour; instead a range of values resulting from uncertainties specific for given test case conditions shall be considered.

6.1 In a pure E-UTRAN environment

6.1.1 PLMN selection

6.1.1.1 PLMN selection of RPLMN, HPLMN/EHPLMN, UPLMN and OPLMN / Automatic mode

6.1.1.1.1 Test Purpose (TP)

(1)

```
with { UE in Automatic network selection mode and RPLMN, HPLMN, UPLMN and OPLMN E-UTRAN cells
available and UE is fitted with a USIM indicating RPLMN should be selected }
ensure that {
  when { UE is switched on or return to coverage }
  then { UE selects a cell of the RPLMN and UE attempts a location registration on the selected
cell and when successfully registered indicates the selected PLMN to the user. }
}
```

(2)

```
with { UE camped on an E-UTRAN VPLMN cell and cells of a higher priority E-UTRAN PLMN available }
ensure that {
  when { higher priority PLMN search timer T expires }
  then { UE selects and camps on a cell of the highest priority PLMN and UE attempts a location
registration on the selected cell and when successfully registered indicates the selected PLMN to
the user. }
}
```

(3)

```
with { UE in Automatic network selection mode and HPLMN, UPLMN and OPLMN E-UTRAN cells available and
UE is fitted with a USIM with Access Technology data files for each PLMN and there are no equivalent
HPLMNs defined}
ensure that {
  when { UE is switched on or return to coverage }
}
```

```
    then { UE selects a cell of the highest priority PLMN and UE attempts a location registration on
the selected cell and when successfully registered indicates the selected PLMN to the user. }
}
```

6.1.1.1.2 Conformance requirements

References: The conformance requirements covered in the present TC are specified in: TS 23.122 clauses 4.4.3.1, 4.4.3.1.1 and 4.4.3.3.

[TS 23.122, clause 4.4.3.1]

At switch on, or following recovery from lack of coverage, the MS selects the registered PLMN or equivalent PLMN (if it is available) using all access technologies that the MS is capable of and if necessary (in the case of recovery from lack of coverage, see clause 4.5.2) attempts to perform a Location Registration.

...

If successful registration is achieved, the MS indicates the selected PLMN.

If there is no registered PLMN, or if registration is not possible due to the PLMN being unavailable or registration failure, the MS follows one of the following two procedures depending on its PLMN selection operating mode. At switch on, if the MS provides the optional feature of user preferred PLMN selection operating mode at switch on then this operating mode shall be used.

...

NOTE 1: If successful registration is achieved, then the current serving PLMN becomes the registered PLMN and the MS does not store the previous registered PLMN for later use.

[TS 23.122, clause 4.4.3.1.1]

The MS selects and attempts registration on other PLMN/access technology combinations, if available and allowable, in the following order:

- i) either the HPLMN (if the EHPLMN list is not present or is empty) or the highest priority EHPLMN that is available (if the EHPLMN list is present) ;
- ii) each PLMN/access technology combination in the "User Controlled PLMN Selector with Access Technology" data file in the SIM (in priority order);
- iii) each PLMN/access technology combination in the "Operator Controlled PLMN Selector with Access Technology" data file in the SIM (in priority order);
- iv) ...
- v) ...

When following the above procedure the following requirements apply:

- a) ...
- b) ...
- c) In ii and iii, the MS should limit its search for the PLMN to the access technology or access technologies associated with the PLMN in the appropriate PLMN Selector with Access Technology list (User Controlled or Operator Controlled selector list). An MS using a SIM without access technology information storage (i.e. the "User Controlled PLMN Selector with Access Technology" and the "Operator Controlled PLMN Selector with Access Technology" data files are not present) shall instead use the "PLMN Selector" data file, for each PLMN in the "PLMN Selector" data file, the MS shall search for all access technologies it is capable of and shall assume GSM access technology as the highest priority radio access technology.
- d) ...
- e) ...

f) In i, the MS shall search for all access technologies it is capable of. No priority is defined for the preferred access technology and the priority is an implementation issue, but "HPLMN Selector with Access Technology" data file on the SIM may be used to optimise the procedure.

g) ...

h) ...

NOTE 1: ...

NOTE 2: ...

NOTE 3: High quality signal is defined in the appropriate AS specification.

If successful registration is achieved, the MS indicates the selected PLMN.

[TS 23.122, clause 4.4.3.3]

If the MS is in a VPLMN, the MS shall periodically attempt to obtain service on its HPLMN (if the EHPLMN list is not present or is empty) or one of its EHPLMNs (if the EHPLMN list is present) or a higher priority PLMN/access technology combinations listed in "user controlled PLMN selector" or "operator controlled PLMN selector" by scanning in accordance with the requirements that are applicable to i), ii) and iii) as defined in the Automatic Network Selection Mode in clause 4.4.3.1.1. In the case that the mobile has a stored "Equivalent PLMNs" list the mobile shall only select a PLMN if it is of a higher priority than those of the same country as the current serving PLMN which are stored in the "Equivalent PLMNs" list. For this purpose, a value T minutes may be stored in the SIM, T is either in the range 6 minutes to 8 hours in 6 minute steps or it indicates that no periodic attempts shall be made. If no value is stored in the SIM, a default value of 60 minutes is used.

The attempts to access the HPLMN or an EHPLMN or higher priority PLMN shall be as specified below:

- a) The periodic attempts shall only be performed in automatic mode when the MS is roaming;
- b) After switch on a period of at least 2 minutes and at most T minutes shall elapse before the first attempt is made;
- c) The MS shall make the following attempts if the MS is on the VPLMN at time T after the last attempt;
- d) Periodic attempts shall only be performed by the MS while in idle mode;
- e) If the HPLMN (if the EHPLMN list is not present or is empty) or a EHPLMN (if the list is present) or a higher priority PLMN is not found, the MS shall remain on the VPLMN.
- f) In steps i), ii) and iii) of subclause 4.4.3.1.1 the MS shall limit its attempts to access higher priority PLMN/access technology combinations to PLMN/access technology combinations of the same country as the current serving VPLMN, as defined in Annex B.
- g) ...
- h) If the PLMN of the highest priority PLMN/access technology combination available is the current VPLMN, or one of the PLMNs in the "Equivalent PLMNs" list, the MS shall remain on the current PLMN/access technology combination.

6.1.1.1.3 Test description

6.1.1.1.3.1 Pre-test conditions

System Simulator:

- Four inter-frequency multi-PLMN cells as specified in TS36.508 clause 4.4.1.2 are configured broadcasting PLMNs as indicated in Table 6.1.1.1.3.1-1.
- The PLMNs are identified in the test by the identifiers in Table 6.1.1.1.3.1-1.

Table 6.1.1.1.3.1–1: PLMN identifiers

Cell	PLMN name	MCC	MNC
1	PLMN4	001	01
12	PLMN1	001	11
13	PLMN2	001	21
14	PLMN3	001	31

UE:

- The UE is in Automatic PLMN selection mode.
- The UE is registered to PLMN1 before it is switched off.
- The UE is equipped with a USIM containing default values (as per TS 36.508) except for those listed in Table 6.1.1.1.3.1-2.

Table 6.1.1.1.3.1–2: USIM configuration

USIM field	Priority	Value	Access Technology Identifier
EF _{LOCI}		PLMN1 (See preamble)	
EF _{IMSI}		The HPLMN (MCC+MNC) of the IMSI is set to PLMN4.	
EF _{PLMNwAct}	1 2 3	Default PLMN3 PLMN2 Remaining mandatory entries use default values	Default All specified E-UTRAN
EF _{OPLMNwAct}	1	PLMN1 Remaining defined entries use default values	All specified
EF _{HPLMNwAct}	1	PLMN4	E-UTRAN
EF _{UST}		Services 20, 42, 43 and 74 are supported. Service 71 is not supported (there is no EHPLMN list).	
EF _{HPPLMN}		1 (6 minutes)	

Preamble:

- The UE is in state Switched OFF (State 1).

6.1.1.1.3.2 Test procedure sequence

Table 6.1.1.1.3.2 – 1 shows the cell configurations used during the test. The configuration T0 indicates the initial conditions. Subsequent configurations marked “T1”, “T2” etc are applied at the points indicated in the Main behaviour description in Table 6.1.1.1.3.2-2. Cell powers are chosen for a serving cell and a non-suitable “Off” cell as defined in TS36.508 Table 6.2.2.1-1.

Table 6.1.1.1.3.2-1: Cell configuration changes over time

	Parameter	Unit	Cell 1	Cell 12	Cell 13	Cell 14	Remarks
T0	RS EPRE	dBm/15kHz	“Off”	-85	“Off”	“Off”	Power level “Off” is defined in TS36.508 Table 6.2.2.1-1
T1	RS EPRE	dBm/15kHz	-85	-85	-85	“Off”	Power level “Off” is defined in TS36.508 Table 6.2.2.1-1
T2	RS EPRE	dBm/15kHz	“Off”	-85	-85	“Off”	Power level “Off” is defined in TS36.508 Table 6.2.2.1-1
T3	RS EPRE	dBm/15kHz	“Off”	-85	-85	-85	Power level “Off” is defined in TS36.508 Table 6.2.2.1-1

Table 6.1.1.1.3.2-2: Main behaviour

St	Procedure	Message Sequence		TP	Verdict
		U - S	Message		
1	SS adjusts cell levels according to row T1 of table 6.1.1.1.3.2-1	-	-	-	-
2	Power on the UE.	-	-	-	-
3	Check: Does the UE send an <i>RRCCONNECTIONREQUEST</i> on Cell 12?	-->	<i>RRCCONNECTIONREQUEST</i>	1	P
4-18	Steps 3 to 17 of the registration procedure described in TS 36.508 subclause 4.5.2.3 are performed on Cell 12. NOTE: The UE performs registration and the RRC connection is released.	-	-	-	-
19	Check: Is PLMN1 indicated by the UE?	-	-	1	P
20	Check: Does the UE send an <i>RRCCONNECTIONREQUEST</i> on Cell 1 after 120 seconds, but before 720 seconds from power on?	-->	<i>RRCCONNECTIONREQUEST</i>	2	P
21-25	Steps 2 to 6 of the generic test procedure in TS 36.508 subclause 6.4.2.7 are performed on Cell 1. NOTE: The UE performs a TAU procedure and the RRC connection is released.	-	-	-	-
26	Check: Is PLMN4 indicated by the UE?	-	-	2	P
27	Check: Does the UE send an <i>RRCCONNECTIONREQUEST</i> within 720 seconds?	-->	<i>RRCCONNECTIONREQUEST</i>	2	F
28	SS adjusts cell levels according to row T2 of table 6.1.1.1.3.2-1	-	-	-	-
29	Check: Does the test result of generic test procedure in TS 36.508 subclause 6.4.2.7 indicate that the UE is camped on E-UTRAN Cell 13? NOTE: The UE performs a TAU procedure and the RRC connection is released.	-	-	3	-
30	Check: Is PLMN2 indicated by the UE?	-	-	3	P
31	SS adjusts cell levels according to row T3 of table 6.1.1.1.3.2-1	-	-	-	-
32	Check: Does the UE send an <i>RRCCONNECTIONREQUEST</i> on Cell 14 after 120 seconds after step 28?	-->	<i>RRCCONNECTIONREQUEST</i>	2	P
33-37	Steps 2 to 6 of the generic test procedure in TS 36.508 subclause 6.4.2.7 are performed. NOTE: The UE performs a TAU procedure and the RRC connection is released.	-	-	-	-
38	Check: Is PLMN3 indicated by the UE?	-	-	2	P
39	Check: Does the UE send an <i>RRCCONNECTIONREQUEST</i> within 720 seconds?	-->	<i>RRCCONNECTIONREQUEST</i>	2	F
Note 1: Timers in Steps 20, 27, 32 and 39 are derived from the high priority PLMN search timer T defined by EF_{HPPLMN}					

6.1.1.1.3.3 Specific message contents

None

6.1.1.1a PLMN selection / Automatic mode/between FDD and TDD

6.1.1.1a.1 Test Purpose (TP)

(1)

```

with { UE in Automatic network selection mode and camp on a cell of a PLMN with FDD mode }
ensure that {
  when { UE is switched on or return to coverage }
  then { UE selects a cell of a PLMN with TDD mode and UE attempts registration on the selected
cell and when successfully registered indicates the selected PLMN to the user. }
}

```

(2)

```

with { UE in Automatic network selection mode and camp on a cell of a PLMN with TDD mode}
ensure that {
  when { UE is switched on or return to coverage }
  then { UE selects a cell of a PLMN with FDD mode and UE attempts registration on the selected
cell and when successfully registered indicates the selected PLMN to the user. }
}

```

6.1.1.1a.2 Conformance requirements

References: The conformance requirements covered in the present TC are specified in: TS 23.122 clauses 4.4.3.1, 4.4.3.1.1 and 4.4.3.3.

[TS 23.122, clause 4.4.3.1]

At switch on, or following recovery from lack of coverage, the MS selects the registered PLMN or equivalent PLMN (if it is available) using all access technologies that the MS is capable of and if necessary (in the case of recovery from lack of coverage, see clause 4.5.2) attempts to perform a Location Registration.

...

If successful registration is achieved, the MS indicates the selected PLMN.

If there is no registered PLMN, or if registration is not possible due to the PLMN being unavailable or registration failure, the MS follows one of the following two procedures depending on its PLMN selection operating mode. At switch on, if the MS provides the optional feature of user preferred PLMN selection operating mode at switch on then this operating mode shall be used.

...

NOTE 1: If successful registration is achieved, then the current serving PLMN becomes the registered PLMN and the MS does not store the previous registered PLMN for later use.

...

NOTE2: ...

[TS 23.122, clause 4.4.3.1.1]

The MS selects and attempts registration on other PLMN/access technology combinations, if available and allowable, in the following order:

- i) either the HPLMN (if the EHPLMN list is not present or is empty) or the highest priority EHPLMN that is available (if the EHPLMN list is present) ;
- ii) each PLMN/access technology combination in the "User Controlled PLMN Selector with Access Technology" data file in the SIM (in priority order);
- iii) each PLMN/access technology combination in the "Operator Controlled PLMN Selector with Access Technology" data file in the SIM (in priority order);
- iv) ...
- v) ...

When following the above procedure the following requirements apply:

- a) ...
- b) ...

- c) In ii and iii, the MS should limit its search for the PLMN to the access technology or access technologies associated with the PLMN in the appropriate PLMN Selector with Access Technology list (User Controlled or Operator Controlled selector list). An MS using a SIM without access technology information storage (i.e. the "User Controlled PLMN Selector with Access Technology" and the "Operator Controlled PLMN Selector with Access Technology" data files are not present) shall instead use the "PLMN Selector" data file, for each PLMN in the "PLMN Selector" data file, the MS shall search for all access technologies it is capable of and shall assume GSM access technology as the highest priority radio access technology.
- d) ...
- e) ...
- f) In i, the MS shall search for all access technologies it is capable of. No priority is defined for the preferred access technology and the priority is an implementation issue, but "HPLMN Selector with Access Technology" data file on the SIM may be used to optimise the procedure.
- g) ...
- h) ...

NOTE 1: ...

NOTE 2: ...

NOTE 3: High quality signal is defined in the appropriate AS specification.

If successful registration is achieved, the MS indicates the selected PLMN.

...

- 6.1.1.1a.3 Test description
- 6.1.1.1a.3.1 Pre-test conditions

System Simulator

- Two FDD and TDD inter-frequency multi-PLMN cells as specified in TS36.508 clause 4.4.1.2 are configured broadcasting default PLMNs as indicated in TS 36.508 Table 4.4.2-2.
- The PLMNs are identified in the test by the identifiers in Table 6.1.1.1a.3.1-1.

Table 6.1.1.1a.3.1-1: PLMN identifiers

Cell	PLMN name	MODE
1	PLMN1	FDD
28	PLMN2	TDD

UE

- The UE is in Automatic PLMN selection mode.
- The UE is equipped with a USIM containing default values (as per TS 36.508) except for those listed in Table 6.1.1.1a.3.1-2.

Table 6.1.1.1a.3.1-2: USIM configuration

USIM field	Priority	Value	Access Technology Identifier
EF _{LOCI}		PLMN1 (See preamble)	E-UTRAN
EF _{IMSI}		The HPLMN (MCC+MNC) of the IMSI is set to PLMN2.	E-UTRAN
EF _{PLMNwAcT}	1 2	Default PLMN2 Remaining mandatory entries use default values	Default E-UTRAN
EF _{OPLMNwAcT}	1	PLMN1 Remaining defined entries use default values	E-UTRAN

Preamble

- The UE is in state Switched OFF (State 1).

6.1.1.1a.3.2 Test procedure sequence

Table 6.1.1.1a.3.2 – 1 shows the cell configurations used during the test. The configuration T0 indicates the initial conditions. Subsequent configurations marked “T1”, “T2” etc are applied at the points indicated in the Main behaviour description in Table 6.1.1.1a.3.2-2. Cell powers are chosen for a serving cell and a non-suitable “Off” cell as defined in TS36.508 Table 6.2.2.1-1.

Table 6.1.1.1a.3.2-1: Cell configuration changes over time

	Parameter	Unit	Cell 1	Cell 28	Remarks
T0	RS EPRE	dBm/15kHz	-85	“Off”	Power level “Off” is defined in TS36.508 Table 6.2.2.1-1
T1	RS EPRE	dBm/15kHz	“Off”	-85	Power level “Off” is defined in TS36.508 Table 6.2.2.1-1
T2	RS EPRE	dBm/15kHz	-85	“Off”	Power level “Off” is defined in TS36.508 Table 6.2.2.1-1

Table 6.1.1.1a.3.2-2: Main behaviour

St	Procedure	Message Sequence		TP	Verdict
		U - S	Message		
1	Power on the UE.	-	-	-	-
2-17	Steps 2 to 17 of the registration procedure described in TS 36.508 subclause 4.5.2.3 are performed on Cell 1. NOTE: The UE performs registration and the RRC connection is released.	-	-	-	-
18	PLMN1 is indicated by the UE.	-	-	-	-
19	Power off the UE, and wait [15 seconds].	-	-	-	-
20	SS adjusts cell levels according to row T1 of table 6.1.1.1a.3.2-1	-	-	-	-
21	Power on the UE	-	-	-	-
22	Check: Does the UE send an <i>RRCConnectionRequest</i> on Cell 28?	-	-	1	P
23-37	Steps 3 to 17 of the registration procedure described in TS 36.508 subclause 4.5.2.3 are performed on Cell 28. NOTE: The UE performs registration and the RRC connection is released.	-	-	-	-
38	Check: Is PLMN2 indicated by the UE?	-	-	1	P
39	Power off the UE, and wait [15 seconds].	-	-	-	-
40	SS adjusts cell levels according to row T2 of table 6.1.1.1a.3.2-1	-	-	-	-
41	Power on the UE	-	-	-	-
42	Check: Does the UE send an <i>RRCConnectionRequest</i> on Cell 1?	-	-	2	P
43-47	Steps 3 to 17 of the registration procedure described in TS 36.508 subclause 4.5.2.3 are performed on Cell1. NOTE: The UE performs registration and the RRC connection is released.	-	-	-	-
48	Check: Is PLMN1 indicated by the UE?	-	-	2	P

6.1.1.1a.3.3 Specific message contents

None

6.1.1.1b PLMN selection of RPLMN, HPLMN/EHPLMN, UPLMN and OPLMN / Automatic mode / Single Frequency operation

6.1.1.1b.1 Test Purpose (TP)

Same Test Purpose as in clause 6.1.1.1.1

6.1.1.1b.2 Conformance requirements

Same Conformance requirements as in clause 6.1.1.1.2

6.1.1.1b.3 Test description

6.1.1.1b.3.1 Pre-test conditions

System Simulator:

- Four intra-frequency multi-PLMN cells.
- The PLMNs are identified in the test by the identifiers in Table 6.1.1.1b.3.1-1.

Table 6.1.1.1b.3.1-1: PLMN identifiers

Cell	PLMN name	MCC	MNC
1	PLMN4	001	01
2	PLMN1	001	11
4	PLMN2	001	21
11	PLMN3	001	31

UE:

- The UE is in Automatic PLMN selection mode.
- The UE is registered to PLMN1 before it is switched off.
- The UE is equipped with a USIM containing default values (as per TS 36.508) except for those listed in Table 6.1.1.1b.3.1-2.

Table 6.1.1.1b.3.1-2: USIM configuration

USIM field	Priority	Value	Access Technology Identifier
EF _{LOCI}		PLMN1 (See preamble)	
EF _{IMSI}		The HPLMN (MCC+MNC) of the IMSI is set to PLMN4.	
EF _{PLMNwAcT}	1 2 3	Default PLMN3 PLMN2 Remaining mandatory entries use default values	Default All specified E-UTRAN
EF _{OPLMNwAcT}	1	PLMN1 Remaining defined entries use default values	All specified
EF _{HPLMNwAcT}	1	PLMN4	E-UTRAN
EF _{UST}		Services 20, 42, 43 and 74 are supported. Service 71 is not supported (there is no EHPLMN list).	
EF _{HPPLMN}		1 (6 minutes)	

Preamble:

- The UE is in state Switched OFF (State 1).

6.1.1.1b.3.2 Test procedure sequence

Table 6.1.1.1b.3.2 – 1 shows the cell configurations used during the test. The configuration T0 indicates the initial conditions. Subsequent configurations marked “T1”, “T2” etc are applied at the points indicated in the Main behaviour description in Table 6.1.1.1b.3.2-2. Cell powers are chosen for a serving cell and a non-suitable “Off” cell as defined in TS36.508 Table 6.2.2.1-1.

Table 6.1.1.1b.3.2-1: Cell configuration changes over time

	Parameter	Unit	Cell 1	Cell 2	Cell 4	Cell 11	Remarks
T0	RS EPRE	dBm/15kHz	“Off”	-85	“Off”	“Off”	Power level “Off” is defined in TS36.508 Table 6.2.2.1-1
T1	RS EPRE	dBm/15kHz	-85	-79	-85	”Off”	Power level “Off” is defined in TS36.508 Table 6.2.2.1-1
T2	RS EPRE	dBm/15kHz	-79	-85	-85	”Off”	Power level “Off” is defined in TS36.508 Table 6.2.2.1-1
T3	RS EPRE	dBm/15kHz	“Off”	-85	-79	“Off”	Power level “Off” is defined in TS36.508 Table 6.2.2.1-1
T4	RS EPRE	dBm/15kHz	“Off”	-85	-85	-79	Power level “Off” is defined in TS36.508 Table 6.2.2.1-1

Table 6.1.1.1b.3.2-2: Main behaviour

St	Procedure	Message Sequence		TP	Verdict
		U - S	Message		
1	SS adjusts cell levels according to row T1 of table 6.1.1.1b.3.2-1	-	-	-	-
2	Power on the UE.	-	-	-	-
3	Check: Does the UE send an <i>RRCCONNECTIONREQUEST</i> on Cell 2?	-->	<i>RRCCONNECTIONREQUEST</i>	1	P
4-18	Steps 3 to 17 of the registration procedure described in TS 36.508 subclause 4.5.2.3 are performed on Cell 2. NOTE: The UE performs registration and the RRC connection is released.	-	-	-	-
19	Check: Is PLMN1 indicated by the UE?	-	-	1	P
20	SS adjusts cell levels according to row T2 of table 6.1.1.1b.3.2-1	-	-	-	-
20	Check: Does the UE send an <i>RRCCONNECTIONREQUEST</i> on Cell 1 after 120 seconds, but before 720 seconds from power on?	-->	<i>RRCCONNECTIONREQUEST</i>	2	P
21-25	Steps 2 to 6 of the generic test procedure in TS 36.508 subclause 6.4.2.7 are performed on Cell 1. NOTE: The UE performs a TAU procedure and the RRC connection is released.	-	-	-	-
26	Check: Is PLMN4 indicated by the UE?	-	-	2	P
27	Check: Does the UE send an <i>RRCCONNECTIONREQUEST</i> within 720 seconds?	-->	<i>RRCCONNECTIONREQUEST</i>	2	F
28	SS adjusts cell levels according to row T3 of table 6.1.1.1b.3.2-1	-	-	-	-
29	Check: Does the test result of generic test procedure in TS 36.508 subclause 6.4.2.7 indicate that the UE is camped on E-UTRAN Cell 4? NOTE: The UE performs a TAU procedure and the RRC connection is released.	-	-	3	-
30	Check: Is PLMN2 indicated by the UE?	-	-	3	P
31	SS adjusts cell levels according to row T4 of table 6.1.1.1b.3.2-1	-	-	-	-
32	Check: Does the UE send an <i>RRCCONNECTIONREQUEST</i> on Cell 11 after 120 seconds after step 28?	-->	<i>RRCCONNECTIONREQUEST</i>	2	P
33-37	Steps 2 to 6 of the generic test procedure in TS 36.508 subclause 6.4.2.7 are performed. NOTE: The UE performs a TAU procedure and the RRC connection is released.	-	-	-	-
38	Check: Is PLMN3 indicated by the UE?	-	-	2	P
39	Check: Does the UE send an <i>RRCCONNECTIONREQUEST</i> within 720 seconds?	-->	<i>RRCCONNECTIONREQUEST</i>	2	F
Note 1: Timers in Steps 20, 27, 32 and 39 are derived from the high priority PLMN search timer T defined by EF _{HPPLMN}					

6.1.1.1b.3.3 Specific message contents

Table 6.1.1.1b.3.3-1: *SystemInformationBlockType3* for cells 2 and 4 (preamble and all steps, table 6.1.1.1b.3.2-2)

Derivation Path: 36.508 table 4.4.3.3-2		
Information Element	Value/remark	Comment
<i>SystemInformationBlockType3</i> ::= SEQUENCE {		
<i>cellReselectionInfoCommon</i> SEQUENCE {		
q-Hyst	dB24	
}		
}		

6.1.1.2 PLMN selection of "Other PLMN/access technology combinations" / Automatic mode

6.1.1.2.1 Test Purpose (TP)

(1)

```
with { UE in Automatic network selection mode and EHPLMN, UPLMN, OPLMN and other PLMN/access
technology combinations cells available and UE is fitted with a USIM with Access Technology data
files for each PLMN }
ensure that {
  when { UE is switched on or return to coverage }
  then { UE selects a cell of the EPLMN and UE attempts a location registration on the selected
cell and when successfully registered indicates the selected PLMN to the user. }
}
```

(2)

```
with { UE in Automatic network selection mode and UPLMN, OPLMN and other PLMN/access technology
combinations cells available and UE is fitted with a USIM with Access Technology data files for each
PLMN }
ensure that {
  when { UE is switched on or return to coverage }
  then { UE selects a cell of the UPLMN and UE attempts a location registration on the selected
cell and when successfully registered indicates the selected PLMN to the user. }
}
```

(3)

```
with { UE in Automatic network selection mode and OPLMN and other PLMN/access technology
combinations cells available and UE is fitted with a USIM with Access Technology data files for each
PLMN }
ensure that {
  when { UE is switched on or return to coverage }
  then { UE selects a cell of the OPLMN and UE attempts a location registration on the selected
cell and when successfully registered indicates the selected PLMN to the user. }
}
```

(4)

```
with { UE in Automatic network selection mode and other PLMN/access technology combinations cells
not belonging to any of EHPLMN, UHPLMN or OPLMN available }
ensure that {
  when { UE is switched on or return to coverage }
  then { UE selects a cell of other PLMN/access technology combinations and UE attempts a location
registration on the selected cell and when successfully registered indicates the selected PLMN to
the user. }
}
```

6.1.1.2.2 Conformance requirements

References: The conformance requirements covered in the present TC are specified in: TS 23.122 clauses 4.4.3.1.1.

[TS 23.122, clause 4.4.3.1.1]

4.4.3.1.1 Automatic Network Selection Mode Procedure

The MS selects and attempts registration on other PLMN/access technology combinations, if available and allowable, in the following order:

- i) either the HPLMN (if the EHPLMN list is not present or is empty) or the highest priority EHPLMN that is available (if the EHPLMN list is present);
- ii) each PLMN/access technology combination in the "User Controlled PLMN Selector with Access Technology" data file in the SIM (in priority order);
- iii) each PLMN/access technology combination in the "Operator Controlled PLMN Selector with Access Technology" data file in the SIM (in priority order);
- iv) other PLMN/access technology combinations with received high quality signal in random order;

- v) other PLMN/access technology combinations in order of decreasing signal quality.

When following the above procedure the following requirements apply:

- a) An MS with voice capability shall ignore PLMNs for which the MS has identified at least one GSM COMPACT.
- b) In A/Gb mode or GSM COMPACT, an MS with voice capability, or an MS not supporting packet services shall not search for CPBCCCH carriers.
- c) In ii and iii, the MS should limit its search for the PLMN to the access technology or access technologies associated with the PLMN in the appropriate PLMN Selector with Access Technology list (User Controlled or Operator Controlled selector list).

An MS using a SIM without access technology information storage (i.e. the "User Controlled PLMN Selector with Access Technology" and the "Operator Controlled PLMN Selector with Access Technology" data files are not present) shall instead use the "PLMN Selector" data file, for each PLMN in the "PLMN Selector" data file, the MS shall search for all access technologies it is capable of. The priority ordering amongst the access technologies is implementation dependent.

- d) In iv and v, the MS shall search for all access technologies it is capable of, before deciding which PLMN to select.
- e) In ii, and iii, a packet only MS which supports GSM COMPACT, but using a SIM without access technology information storage (i.e. the "User Controlled PLMN Selector with Access Technology" and the "Operator Controlled PLMN Selector with Access Technology" data files are not present) shall instead use the "PLMN Selector" data file, for each PLMN in the "PLMN Selector" data file, the MS shall search for all access technologies it is capable of and shall assume GSM COMPACT access technology as the lowest priority radio access technology.
- f) In i, the MS shall search for all access technologies it is capable of. No priority is defined for the preferred access technology and the priority is an implementation issue, but "HPLMN Selector with Access Technology" data file on the SIM may be used to optimise the procedure.
- g) In i, an MS using a SIM without access technology information storage (i.e. the "HPLMN Selector with Access Technology" data file is not present) shall search for all access technologies it is capable of. The priority ordering amongst the access technologies is implementation dependent. A packet only MS which supports GSM COMPACT using a SIM without access technology information storage shall also assume GSM COMPACT access technology as the lowest priority radio access technology.
- h) In v, the MS shall order the PLMN/access technology combinations in order of decreasing signal quality within each access technology. The order between PLMN/access technology combinations with different access technologies is an MS implementation issue.

NOTE 1: Requirements a) and b) apply also to requirement d), so a GSM voice capable MS should not search for GSM COMPACT PLMNs, even if capable of GSM COMPACT.

NOTE 2: Requirements a) and b) apply also to requirement f), so a GSM voice capable MS should not search for GSM COMPACT PLMNs, even if this is the only access technology on the "HPLMN Selector with Access Technology" data file on the SIM.

NOTE 3: High quality signal is defined in the appropriate AS specification.

If successful registration is achieved, the MS indicates the selected PLMN.

If registration cannot be achieved because no PLMNs are available and allowable, the MS indicates "no service" to the user, waits until a new PLMN is available and allowable and then repeats the procedure.

If there were one or more PLMNs which were available and allowable, but an LR failure made registration on those PLMNs unsuccessful or an entry in any of the lists "forbidden LAs for roaming", "forbidden TAs for roaming", "forbidden LAs for regional provision of service" or "forbidden TAs for regional provision of service" prevented a registration attempt, the MS selects the first such PLMN again and enters a limited service state.

6.1.1.2.3 Test description

6.1.1.2.3.1 Pre-test conditions

System Simulator:

- Four inter-frequency multi-PLMN cells as specified in TS36.508 clause 4.4.1.2 are configured broadcasting default PLMNs as indicated in TS 36.508 Table 4.4.2-2.
- The PLMNs are identified in the test by the identifiers in Table 6.1.1.2.3.1-1.

Table 6.1.1.2.3.1–1: PLMN identifiers

Cell	PLMN name
1	PLMN1
12	PLMN2
13	PLMN3
14	PLMN4

UE:

- The UE is in Automatic PLMN selection mode.
- The UE is equipped with a USIM containing default values (as per TS 36.508) except for those listed in Table 6.1.1.2.3.1-2.

Table 6.1.1.2.3.1–2: USIM configuration

USIM field	Priority	Value	Access Technology Identifier
EF _{EHPLMN}	1	PLMN1 Remaining mandatory entries use default values	E-UTRAN
EF _{PLMNwAcT}	1	PLMN2 Remaining mandatory entries use default values	E-UTRAN
EF _{OPLMNwACT}	1	PLMN3 Remaining defined entries use default values	E-UTRAN
EF _{UST}		Services 20, 42 and 71 are supported.	

Preamble:

- The UE is in state Switched OFF (State 1).

6.1.1.2.3.2 Test procedure sequence

Table 6.1.1.2.3.2 – 1 shows the cell configurations used during the test. The configuration T0 indicates the initial conditions. Subsequent configurations marked “T1”, “T2” “T3” “T4”etc are applied at the points indicated in the Main behaviour description in Table 6.1.1.2.3.2-2. Cell powers are chosen for a serving cell and a non-suitable “Off” cell as defined in TS36.508 Table 6.2.2.1-1.

Table 6.1.1.2.3.2-1: Cell configuration changes over time

	Parameter	Unit	Cell 1	Cell 12	Cell 13	Cell 14	Remarks
T1	RS EPRE	dBm/15kHz	-85	-85	-85	"Off"	
T2	RS EPRE	dBm/15kHz	"Off"	-85	-85	-85	Power level "Off" is defined in TS36.508 Table 6.2.2.1-1
T3	RS EPRE	dBm/15kHz	"Off"	"Off"	-85	-85	Power level "Off" is defined in TS36.508 Table 6.2.2.1-1
T4	RS EPRE	dBm/15kHz	"Off"	"Off"	"Off"	-85	Power level "Off" is defined in TS36.508 Table 6.2.2.1-1

Table 6.1.1.2.3.2-2: Main behaviour

St	Procedure	Message Sequence		TP	Verdict
		U - S	Message		
1	SS adjusts cell levels according to row T1 of table 6.1.1.2.3.2-1	-	-	-	-
2	Power on the UE.	-	-	-	-
3	Check: Does the UE send an <i>RRCCONNECTIONREQUEST</i> on Cell 1?	-->	<i>RRCCONNECTIONREQUEST</i>	1	P
4-18	Steps 3 to 17 of the registration procedure described in TS 36.508 subclause 4.5.2.3 are performed on Cell 1. NOTE: The UE performs registration and the RRC connection is released.	-	-	-	-
19	Check: Is PLMN1 indicated by the UE?	-	-	1	P
20	SS adjusts cell levels according to row T2 of table 6.1.1.2.3.2-1	-	-	-	-
21	Check: Does the UE send an <i>RRCCONNECTIONREQUEST</i> on Cell 12?	-->	<i>RRCCONNECTIONREQUEST</i>	2	P
22-26	Steps 2 to 6 of the generic test procedure in TS 36.508 subclause 6.4.2.7 are performed on Cell 12. NOTE: The UE performs a TAU procedure and the RRC connection is released.	-	-	-	-
27	Check: Is PLMN2 indicated by the UE?	-	-	2	P
28	SS adjusts cell levels according to row T3 of table 6.1.1.2.3.2-1	-	-	-	-
29	Check: Does the UE send an <i>RRCCONNECTIONREQUEST</i> on Cell 13?	-->	<i>RRCCONNECTIONREQUEST</i>	3	P
30-34	Steps 2 to 6 of the generic test procedure in TS 36.508 subclause 6.4.2.7 are performed on Cell 13. NOTE: The UE performs a TAU procedure and the RRC connection is released.	-	-	-	-
35	Check: Is PLMN3 indicated by the UE?	-	-	3	P
36	SS adjusts cell levels according to row T4 of table 6.1.1.2.3.2-1	-	-	-	-
37	Check: Does the UE send an <i>RRCCONNECTIONREQUEST</i> on Cell 14?	-->	<i>RRCCONNECTIONREQUEST</i>	4	P
38-41	Steps 2 to 6 of the generic test procedure in TS 36.508 subclause 6.4.2.7 are performed on Cell 14. NOTE: The UE performs a TAU procedure and the RRC connection is released.	-	-	-	-
42	Check: Is PLMN4 indicated by the UE?	-	-	4	P

6.1.1.2.3.3 Specific message contents

None

6.1.1.2a PLMN selection of "Other PLMN/access technology combinations" / Automatic mode / Single Frequency operation

6.1.1.2a.1 Test Purpose (TP)

Same Test Purpose as in clause 6.1.1.2.1

6.1.1.2a.2 Conformance requirements

Same Conformance requirements as in clause 6.1.1.2.2

6.1.1.2a.3 Test description

6.1.1.2a.3.1 Pre-test conditions

System Simulator:

- Four intra-frequency multi-PLMN cells.
- The PLMNs are identified in the test by the identifiers in Table 6.1.1.2a.3.1-1.

Table 6.1.1.2a.3.1–1: PLMN identifiers

Cell	PLMN name
1	PLMN1
2	PLMN2
4	PLMN3
11	PLMN4

UE:

- The UE is in Automatic PLMN selection mode.
- The UE is equipped with a USIM containing default values (as per TS 36.508) except for those listed in Table 6.1.1.2a.3.1-2.

Table 6.1.1.2a.3.1–2: USIM configuration

USIM field	Priority	Value	Access Technology Identifier
EF _{EHPLMN}	1	PLMN1 Remaining mandatory entries use default values	E-UTRAN
EF _{PLMNwAcT}	1	PLMN2 Remaining mandatory entries use default values	E-UTRAN
EF _{OPLMNwAcT}	1	PLMN3 Remaining defined entries use default values	E-UTRAN
EF _{UST}		Services 20, 42 and 71 are supported.	

Preamble:

- The UE is in state Switched OFF (State 1).

6.1.1.2a.3.2 Test procedure sequence

Table 6.1.1.2a.3.2 – 1 shows the cell configurations used during the test. The configuration T0 indicates the initial conditions. Subsequent configurations marked "T1", "T2" "T3" "T4" etc are applied at the points indicated in the Main behaviour description in Table 6.1.1.2a.3.2-2. Cell powers are chosen for a serving cell and a non-suitable "Off" cell as defined in TS36.508 Table 6.2.2.1-1.

Table 6.1.1.2a.3.2-1: Cell configuration changes over time

	Parameter	Unit	Cell 1	Cell 2	Cell 4	Cell 11	Remarks
T1	RS EPRE	dBm/15kHz	-79	-85	-85	"Off"	
T2	RS EPRE	dBm/15kHz	"Off"	-79	-85	-85	Power level "Off" is defined in TS36.508 Table 6.2.2.1-1
T3	RS EPRE	dBm/15kHz	"Off"	"Off"	-79	-85	Power level "Off" is defined in TS36.508 Table 6.2.2.1-1
T4	RS EPRE	dBm/15kHz	"Off"	"Off"	"Off"	-85	Power level "Off" is defined in TS36.508 Table 6.2.2.1-1

Table 6.1.1.2a.3.2-2: Main behaviour

St	Procedure	Message Sequence		TP	Verdict
		U - S	Message		
1	SS adjusts cell levels according to row T1 of table 6.1.1.2a.3.2-1	-	-	-	-
2	Power on the UE.	-	-	-	-
3	Check: Does the UE send an <i>RRCCONNECTIONREQUEST</i> on Cell 1?	-->	<i>RRCCONNECTIONREQUEST</i>	1	P
4-18	Steps 3 to 17 of the registration procedure described in TS 36.508 subclause 4.5.2.3 are performed on Cell 1. NOTE: The UE performs registration and the RRC connection is released.	-	-	-	-
19	Check: Is PLMN1 indicated by the UE?	-	-	1	P
20	SS adjusts cell levels according to row T2 of table 6.1.1.2a.3.2-1	-	-	-	-
21	Check: Does the UE send an <i>RRCCONNECTIONREQUEST</i> on Cell 2?	-->	<i>RRCCONNECTIONREQUEST</i>	2	P
22-26	Steps 2 to 6 of the generic test procedure in TS 36.508 subclause 6.4.2.7 are performed on Cell 2. NOTE: The UE performs a TAU procedure and the RRC connection is released.	-	-	-	-
27	Check: Is PLMN2 indicated by the UE?	-	-	2	P
28	SS adjusts cell levels according to row T3 of table 6.1.1.2a.3.2-1	-	-	-	-
29	Check: Does the UE send an <i>RRCCONNECTIONREQUEST</i> on Cell 4?	-->	<i>RRCCONNECTIONREQUEST</i>	3	P
30-34	Steps 2 to 6 of the generic test procedure in TS 36.508 subclause 6.4.2.7 are performed on Cell 4. NOTE: The UE performs a TAU procedure and the RRC connection is released.	-	-	-	-
35	Check: Is PLMN3 indicated by the UE?	-	-	3	P
36	SS adjusts cell levels according to row T4 of table 6.1.1.2a.3.2-1	-	-	-	-
37	Check: Does the UE send an <i>RRCCONNECTIONREQUEST</i> on Cell 11?	-->	<i>RRCCONNECTIONREQUEST</i>	4	P
38-41	Steps 2 to 6 of the generic test procedure in TS 36.508 subclause 6.4.2.7 are performed on Cell 11. NOTE: The UE performs a TAU procedure and the RRC connection is released.	-	-	-	-
42	Check: Is PLMN4 indicated by the UE?	-	-	4	P

6.1.1.2a.3.3 Specific message contents

None

6.1.1.3 Cell reselection of ePLMN in manual mode

6.1.1.3.1 Test Purpose (TP)

(1)

```
with { UE camped normally on a cell and network has downloaded a list of equivalent PLMNs during the
Location Registration procedure }
ensure that {
  when { higher ranked cell is a cell of a PLMN in the downloaded equivalent PLMN list }
  then { UE reselects to the equivalent PLMN cell. }
}
```

(2)

```
with { UE camped normally on a cell and network has downloaded a list of equivalent PLMNs during the
Location Registration procedure }
ensure that {
  when { highest ranked cell is a cell of a PLMN not in the downloaded equivalent PLMN list }
  then { UE does not reselect to the cell. }
}
```

6.1.1.3.2 Conformance requirements

References: The conformance requirements covered in the present TC are specified in: TS 23.122 clause 4.4.3.1.2.

[TS 23.122, clause 4.4.3.1.2]

...

Once the UE has registered on a PLMN selected by the user, the UE shall not automatically register on a different PLMN unless:

- i) the new PLMN is declared as an equivalent PLMN by the registered PLMN; or
- ii) the user selects automatic mode.

...

6.1.1.3.3 Test description

6.1.1.3.3.1 Pre-test conditions

System Simulator

- Three inter-frequency multi-PLMN cells.
- Each cell has only a single PLMN identity. The PLMNs are identified in the test by the identifiers in Table 6.1.1.3.3.1-1.

Table 6.1.1.3.3.1-1: PLMN identifiers

Cell	PLMN name
1	PLMN1
12	PLMN2
13	PLMN3

- System information combination 3 as defined in TS 36.508 [18] clause 4.4.3.1 is used in E-UTRA cells.

UE

- The UE is in Manual PLMN selection mode.

-

Preamble

- The UE is registered on PLMN1 (Cell 1) using the procedure described in TS 36.508[18] clause 4.5.2.3 except that the ATTACH ACCEPT message indicates PLMN2 in the Equivalent PLMN list as described in Table 6.1.1.3.3.3-2.
- The UE is in state Registered, Idle Mode (State 2) on Cell 1 according to TS 36.508[18];

6.1.1.3.3.2 Test procedure sequence

Table 6.1.1.3.3.2-1: Time instances of cell power level changes

	Parameter	Unit	Cell 1	Cell 12	Cell 13	Remarks
T1	RS EPRE	dBm/15kHz	-97	-82	-67	

Table 6.1.1.3.3.2-2: Main behaviour

St	Procedure	Message Sequence		TP	Verdict
		U - S	Message		
1	SS adjusts cell levels according to row T1 of table 6.1.1.3.3.2-1	-	-	-	-
2	Check: Does the test result of generic test procedure in TS 36.508 subclause 6.4.2.7 indicate that the UE is camped on E-UTRAN Cell 12? NOTE: The TAU is accepted with PLMN1 listed as an Equivalent PLMN	-	-	1,2	P
3	Check: Is PLMN2 indicated by the UE?	-	-	1,2	P
4	Check: Does the UE send an <i>RRCConnectionRequest</i> on Cell 1 and 13 within 60s?	-	-	2	F

Note 1: In Step 4 no further cell reselections are expected.
Note 2: Cell 13 is the highest ranked cell, but never appears in the ePLMN list.

6.1.1.3.3.3 Specific message contents

Table 6.1.1.3.3.3-1: SystemInformationBlockType5 for Cell 1 (preamble and all steps, Table 6.1.1.3.3.2-2)

Derivation path: 36.508 Table 4.4.3.3-4			
Information Element	Value/Remark	Comment	Condition
SystemInformationBlockType5 ::= SEQUENCE {			
interFreqCarrierFreqList SEQUENCE (SIZE (1..maxFreq)) OF SEQUENCE {			
dl-CarrierFreq[1]	Same downlink EARFCN as used for Cell 12		
cellReselectionPriority[1]	4		
dl-CarrierFreq[2]	Same downlink EARFCN as used for Cell 13		
cellReselectionPriority[2]	4		
}			
}			

Table 6.1.1.3.3.3-2: SystemInformationBlockType5 for Cell 12 (preamble and all steps, Table 6.1.1.3.3.2-2)

Derivation path: 36.508 Table 4.4.3.3-4			
Information Element	Value/Remark	Comment	Condition
SystemInformationBlockType5 ::= SEQUENCE {			
interFreqCarrierFreqList SEQUENCE (SIZE (1..maxFreq)) OF SEQUENCE {			
dl-CarrierFreq[1]	Same downlink EARFCN as used for Cell 1		
cellReselectionPriority[1]	4		
dl-CarrierFreq[2]	Same downlink EARFCN as used for Cell 13		
cellReselectionPriority[2]	4		
}			
}			

Table 6.1.1.3.3.3-3: ATTACH ACCEPT for Cell 1 (preamble)

Derivation path: 36.508 Table 4.7.2-1			
Information Element	Value/Remark	Comment	Condition
Equivalent PLMNs	PLMN2		Cell 1

Table 6.1.1.3.3.3-4: TRACKING AREA UPDATE ACCEPT for Cell 12 (step 2, Table 6.1.1.3.3.2-2)

Derivation path: 36.508 Table 4.7.2-24			
Information Element	Value/Remark	Comment	Condition
Equivalent PLMNs	PLMN1		Cell 12

6.1.1.3a Cell reselection of ePLMN in manual mode / between FDD and TDD

6.1.1.3a.1 Test Purpose (TP)

(1)

```
with { UE camped normally on a cell and network has downloaded a list of equivalent PLMNs during the
Location Registration procedure }
ensure that {
  when { higher ranked cell is a cell of a PLMN in the downloaded equivalent PLMN list }
  then { UE reselects to the equivalent PLMN cell. }
}
```

(2)

```
with { UE camped normally on a cell and network has downloaded a list of equivalent PLMNs during the
Location Registration procedure }
ensure that {
  when { highest ranked cell is a cell of a PLMN not in the downloaded equivalent PLMN list }
  then { UE does not reselect to the cell. }
}
```

6.1.1.3a.2 Conformance requirements

References: The conformance requirements covered in the present TC are specified in: TS 23.122 clause 4.4.3.1.2.

[TS 23.122, clause 4.4.3.1.2]

...

Once the UE has registered on a PLMN selected by the user, the UE shall not automatically register on a different PLMN unless:

- i) the new PLMN is declared as an equivalent PLMN by the registered PLMN; or

ii) the user selects automatic mode.

...

6.1.1.3a.3 Test description

6.1.1.3a.3.1 Pre-test conditions

System Simulator

- Four multi-PLMN cells. Cell 1 and Cell 2 are set to LTE-FDD mode while Cell 28 and Cell 29 are set to LTE-TDD mode.
- Each cell has only a single PLMN identity. The PLMNs are identified in the test by the identifiers in Table 6.1.1.3a.3.1-1. Note Cell 2 is in a different PLMN to Cell 1.

Table 6.1.1.3a.3.1-1: PLMN identifiers

Cell	PLMN name
1	PLMN1
28	PLMN2
2	PLMN3
29	PLMN3

- System information combination 3 as defined in TS 36.508 [18] clause 4.4.3.1 and Table 6.3.1.2-2 is used in E-UTRA cells.

UE

- The UE is in Manual PLMN selection mode.
- The UE is equipped with a USIM containing default values (as per TS 36.508) except for those shown in Table 6.1.1.3a.3.1-2.

Table 6.1.1.3a.3.1-2: USIM configuration

USIM field	Priority	Value	Access Technology Identifier
EF _{LOCI}		PLMN1 (See pre-amble)	

Preamble

- The UE is registered on PLMN1 (Cell 1) using the procedure described in TS 36.508[18] clause 4.5.2.3 except that the ATTACH ACCEPT message indicates PLMN2 in the Equivalent PLMN list as described in Table 6.1.1.3a.3.3-1.
- The UE is in state Registered, Idle Mode (State 2) on Cell 1 according to TS 36.508[18];

6.1.1.3a.3.2 Test procedure sequence

Table 6.1.1.3a.3.2-1: Time instances of cell power level changes

	Parameter	Unit	Cell 1	Cell 28	Cell 2	Cell 29	Remarks
T1	RS EPRE	dBm/15 kHz	-97	-82	-67	OFF	
T2	RS EPRE	dBm/15 kHz	-82	-97	OFF	-67	

Table 6.1.1.3a.3.2-2: Main behaviour

St	Procedure	Message Sequence		TP	Verdict
		U - S	Message		
1	SS adjusts cell levels according to row T1 of table 6.1.1.3a.3.2-1	-	-	-	-
2	Check: Does the test result of generic test procedure in TS 36.508 subclause 6.4.2.7 indicate that the UE is camped on E-UTRAN Cell 28? NOTE: The TAU is accepted with PLMN1 listed as an Equivalent PLMN	-	-	1,2	P
3	Check: Is PLMN2 indicated by the UE?	-	-	1,2	P
4	Check: Does the UE send an <i>RRCCConnectionRequest</i> on Cell 2 within 60s?	-	-	2	F
5	SS adjusts cell levels according to row T2 of table 6.1.1.3a.3.2-1	-	-	-	-
6	Check: Does the test result of generic test procedure in TS 36.508 subclause 6.4.2.7 indicate that the UE is camped on E-UTRAN Cell 1? NOTE: The TAU is accepted with PLMN2 listed as an Equivalent PLMN	-	-	1,2	P
7	Check: Does the UE send an <i>RRCCConnectionRequest</i> on Cell 29 within 60s?	-	-	2	F

Note 1: In Step 4 no further cell reselections are expected.
Note 2: Cell 3 and Cell 29 are the highest ranked cell, but never appears in the ePLMN list.

6.1.1.3a.3.3 Specific message contents

Table 6.1.1.3a.3.3-1: *SystemInformationBlockType5* for Cell 1 (preamble and all steps, Table 6.1.1.3a.3.2-2)

Derivation path: 36.508 Table 4.4.3.3-4			
Information Element	Value/Remark	Comment	Condition
<i>SystemInformationBlockType5</i> ::= SEQUENCE {			
interFreqCarrierFreqList SEQUENCE (SIZE (1..maxFreq)) OF SEQUENCE {			
dl-CarrierFreq[1]	Same downlink EARFCN as used for Cell 28		
cellReselectionPriority[1]	4		
}			
}			

Table 6.1.1.3a.3.3-2: *SystemInformationBlockType5* for Cell 28 (preamble and all steps, Table 6.1.1.3a.3.2-2)

Derivation path: 36.508 Table 4.4.3.3-4			
Information Element	Value/Remark	Comment	Condition
<i>SystemInformationBlockType5</i> ::= SEQUENCE {			
interFreqCarrierFreqList SEQUENCE (SIZE (1..maxFreq)) OF SEQUENCE {			
dl-CarrierFreq[1]	Same downlink EARFCN as used for Cell 1		
cellReselectionPriority[1]	4		
}			
}			

Table 6.1.1.3a.3.3-3: ATTACH ACCEPT for Cell 1 (preamble)

Derivation path: 36.508 Table 4.7.2-1			
Information Element	Value/Remark	Comment	Condition
Equivalent PLMNs	PLMN2		

Table 6.1.1.3a.3.3-4: TRACKING AREA UPDATE ACCEPT for Cell 28 (step 2, Table 6.1.1.3a.3.2-2)

Derivation path: 36.508 Table 4.7.2-24			
Information Element	Value/Remark	Comment	Condition
Equivalent PLMNs	PLMN1		

Table 6.1.1.3a.3.3-5: TRACKING AREA UPDATE ACCEPT for Cell 1 (step 6, Table 6.1.1.3a.3.2-2)

Derivation path: 36.508 Table 4.7.2-24			
Information Element	Value/Remark	Comment	Condition
Equivalent PLMNs	PLMN2		

6.1.1.3b Cell reselection of ePLMN in manual mode / Single Frequency operation

6.1.1.3b.1 Test Purpose (TP)

Same Test Purpose as in clause 6.1.1.3.1

6.1.1.3b.2 Conformance requirements

Same Conformance requirements as in clause 6.1.1.3.2

6.1.1.3b.3 Test description

6.1.1.3b.3.1 Pre-test conditions

System Simulator

- Two intra-frequency multi-PLMN cells.
- Each cell has only a single PLMN identity. The PLMNs are identified in the test by the identifiers in Table 6.1.1.3b.3.1-1.

Table 6.1.1.3b.3.1-1: PLMN identifiers

Cell	PLMN name
1	PLMN1
2	PLMN2

UE

- The UE is in Manual PLMN selection mode.

Preamble

- The UE is registered on PLMN1 (Cell 1) using the procedure described in TS 36.508[18] clause 4.5.2.3 except that the ATTACH ACCEPT message indicates PLMN2 in the Equivalent PLMN list as described in Table 6.1.1.3b.3.3-2.
- The UE is in state Registered, Idle Mode (State 2) on Cell 1 according to TS 36.508[18];

6.1.1.3b.3.2 Test procedure sequence

Table 6.1.1.3b.3.2-1: Time instances of cell power level changes

	Parameter	Unit	Cell 1	Cell 2	Remarks
T1	RS EPRE	dBm/15kHz	-88	-82	

Table 6.1.1.3b.3.2-2: Main behaviour

St	Procedure	Message Sequence		TP	Verdict
		U - S	Message		
1	SS adjusts cell levels according to row T1 of table 6.1.1.3b.3.2-1	-	-	-	-
2	Check: Does the test result of generic test procedure in TS 36.508 subclause 6.4.2.7 indicate that the UE is camped on E-UTRAN Cell 2? NOTE: The TAU is accepted with PLMN1 listed as an Equivalent PLMN	-	-	1,2	P
3	Check: Is PLMN2 indicated by the UE?	-	-	1,2	P
4	Check: Does the UE send an <i>RRCConnectionRequest</i> on Cell 1 within 60s?	-	-	2	F

Note 1: In Step 4 no further cell reselections are expected.

6.1.1.3b.3.3 Specific message contents

Table 6.1.1.3b.3.3-1: ATTACH ACCEPT for Cell 1 (preamble)

Derivation path: 36.508 Table 4.7.2-1			
Information Element	Value/Remark	Comment	Condition
Equivalent PLMNs	PLMN2		Cell 1

Table 6.1.1.3b.3.3-2: TRACKING AREA UPDATE ACCEPT for Cell 2 (step 2, Table 6.1.1.3b.3.2-2)

Derivation path: 36.508 Table 4.7.2-24			
Information Element	Value/Remark	Comment	Condition
Equivalent PLMNs	PLMN1		Cell 2

6.1.1.4 PLMN selection in shared network environment / Automatic mode

6.1.1.4.1 Test Purpose (TP)

(1)

```
with { the UE is in automatic network selection mode and there is a suitable cell with multiple PLMN
identities among which the HPLMN but not the registered PLMN }
ensure that {
  when { the UE is switched on }
  then { the UE attaches to the HPLMN on the shared cell }
}
```

(2)

```
with { the UE in automatic network selection mode and there is a suitable cell with multiple PLMN
identities among which the registered PLMN }
ensure that {
  when { the UE returns to coverage }
  then { the UE performs a location registration to the registered PLMN on the shared cell }
}
```

6.1.1.4.2 Conformance requirements

References: The conformance requirements covered in the present TC are specified in: TS 36.304 clause 5.1.2.2, TS 23.122 clauses 4.4.3 and 4.4.3.1.1, TS 24.301 clauses 5.5.1.1 and 5.5.3.1, and TS 36.331 clause 5.3.3.4.

[TS 36.304 clause 5.1.2.2]

The UE shall scan all RF channels in the E-UTRA bands according to its capabilities to find available PLMNs. On each carrier, the UE shall search for the strongest cell and read its system information, in order to find out which PLMN(s) the cell belongs to. If the UE can read one or several PLMN identities in the strongest cell, each found PLMN (see the PLMN reading in [3]) shall be reported to the NAS as a high quality PLMN (but without the RSRP value),

...

Once the UE has selected a PLMN, the cell selection procedure shall be performed in order to select a suitable cell of that PLMN to camp on.

[TS 23.122 clause 4.4.3]

When the MS reselects to a cell in a shared network, the AS may indicate multiple PLMN identities to the NAS according to 3GPP TS 25.304 [32]. The MS shall choose one of these PLMNs. If the registered PLMN is available among these PLMNs, the MS shall not choose a different PLMN.

[TS 23.122 clause 4.4.3.1.1]

The MS selects and attempts registration on other PLMN/access technology combinations, if available and allowable, in the following order:

- i) either the HPLMN (if the EHPLMN list is not present or is empty) or the highest priority EHPLMN that is available (if the EHPLMN list is present) ;
- ii) each PLMN/access technology combination in the "User Controlled PLMN Selector with Access Technology" data file in the SIM (in priority order);
- iii) each PLMN/access technology combination in the "Operator Controlled PLMN Selector with Access Technology" data file in the SIM (in priority order);
- iv) other PLMN/access technology combinations with received high quality signal in random order;
- v) other PLMN/access technology combinations in order of decreasing signal quality.

[TS 24.301 clause 5.5.1.1]

...

In a shared network, the UE shall choose one of the PLMN identities as specified in 3GPP TS 23.122 [6]. The UE shall construct the TAI of the cell from this chosen PLMN identity and the TAC received as part of the broadcast system information. The chosen PLMN identity shall be indicated to the E-UTRAN (see 3GPP TS 36.331 [22]).

...

[TS 24.301 clause 5.5.3.1]

...

In a shared network, the UE shall choose one of the PLMN identities as specified in 3GPP TS 23.122 [6]. The UE shall construct the TAI of the cell from this chosen PLMN identity and the TAC received on the broadcast system information. The chosen PLMN identity shall be indicated to the E-UTRAN (see 3GPP TS 36.331 [22]).

...

[TS 36.331 clause 5.3.3.4]

The UE shall:

...

1> set the content of *RRCConnectionSetupComplete* message as follows:

2> set the *selectedPLMN-Identity* to the PLMN selected by upper layers (see TS 23.122 [11], TS 24.301 [35]) from the PLMN(s) included in the *plmn-IdentityList* in *SystemInformationBlockType1*;

...

2> submit the *RRCConnectionSetupComplete* message to lower layers for transmission, upon which the procedure ends;

6.1.1.4.3 Test description

6.1.1.4.3.1 Pre-test conditions

System Simulator:

- Cells 1 and 2, as specified in TS36.508 clause 4.4.1.2 are configured according to Table 4.4.2-2 in [18] except for multiple broadcasted PLMN identities as shown in Table 6.1.1.4.3.1–1: PLMN identifiers broadcasted by cells in shared network.

Table 6.1.1.4.3.1-1: PLMN identifiers

Cell	PLMN names
1	PLMN15, PLMN1
2	PLMN15, PLMN1, PLMN16

UE:

- The UE is in Automatic PLMN selection mode.
- The UE is equipped with a USIM containing default values (as per TS 36.508) except for those listed in Table 6.1.1.4.3.1-2.

Table 6.1.1.4.3.1–2: USIM configuration

USIM field	Priority	Value	Access Technology Identifier
EF _{LOCI}		PLMN4	
EF _{PLMNwAcT}		Empty	
EF _{IMSI}		The HPLMN (MCC+MNC) of the IMSI is set to PLMN1.	
EF _{UST}		Service 74 is supported.	
EF _{LRPLMNSI}		00	

Preamble:

- The UE is in state Switched OFF (state 1) according to [18].

6.1.1.4.3.2 Test procedure sequence

Table 6.1.1.4.3.2–1 shows the cell configurations used during the test. The configuration T0 indicates the initial conditions. Subsequent configuration marked “T1” is applied at the points indicated in the Main behaviour description in Table 6.1.1.4.3.2-2. Cell powers are chosen for a serving cell and a non-suitable cell as defined in TS36.508 Table 6.2.2.1-1.

Table 6.1.1.4.3.2-1: Cell configuration changes over time

	Parameter	Unit	Cell 1	Cell 2	Remarks
T0	RS EPRE	dBm/15kHz	-85	Off	The power level values are assigned to such that camping on Cell 1 is guaranteed. Cell 2 is “off”.
T1	RS EPRE	dBm/15kHz	Off	-85	Cell 1 becomes “off”. UE shall select Cell 2.

Table 6.1.1.4.3.2-2: Main behaviour

St	Procedure	Message Sequence		TP	Verdict
		U - S	Message		
1	The SS adjusts cell levels according to row T0 of table 6.1.1.4.3.2-1	-	-	-	-
2	Power on the UE.	-	-	-	-
3	Check: Does the UE transmits an <i>RRCCoNNECTIONRequest</i> on Cell 1?	-->	<i>RRCCoNNECTIONRequest</i>	1	P
4	The SS transmits an <i>RRCCoNNECTIONSetup</i>	<--	<i>RRCCoNNECTIONSetup</i>	-	-
5	Check; Does the UE transmit an <i>RRCCoNNECTIONSetupComplete</i> message indicating the HPLMN (second PLMN in the list)? Note: this message contains an ATTACH REQUEST and a PDN CONNECTIVITY REQUEST message according to default message contents.	-->	<i>RRCCoNNECTIONSetupComplete</i>	1	P
6 - 18	Steps 5 to 17 of the registration procedure described in TS 36.508 subclause 4.5.2.3 are performed on Cell 1. NOTE: The UE performs registration and the RRC connection is released.	-	-	-	-
19	Check: Is PLMN1 indicated by the UE?	-	-	1	P
20	The SS adjusts cell levels according to row T1 of table 6.1.1.4.3.2-1	-	-	-	-
21	Check: Does the UE transmit an <i>RRCCoNNECTIONRequest</i> on Cell 2?	-->	<i>RRCCoNNECTIONRequest</i>	2	P
22 - 26	Steps 2 to 6 of the generic test procedure in TS 36.508 subclause 6.4.2.7 are performed. NOTE: The UE performs a TAU procedure and the RRC connection is released.	-	-	-	-
27	Check: Is the same PLMN as indicated by UE in step 19 again indicated by the UE?	-	-	2	P

6.1.1.4.3.3 Specific message contents

Table 6.1.1.4.3.3-1: *RRCCoNNECTIONSetupComplete* (step 5 and 23, Table 6.1.1.4.3.2-2)

Derivation Path: 36.508, Table 4.6.1-18			
Information Element	Value/remark	Comment	Condition
<i>RRCCoNNECTIONSetupComplete</i> ::= SEQUENCE {			
criticalExtensions CHOICE {			
c1 CHOICE{			
<i>rrcCoNNECTIONSetupComplete-r8</i> SEQUENCE {			
selectedPLMN-Identity	2	PLMN1	
}			
}			
}			
}			

6.1.1.4a PLMN selection in shared network environment / Automatic mode / Between FDD and TDD

6.1.1.4a.1 Test Purpose (TP)

(1)

```

with { the UE is in automatic network selection mode and there is a suitable cell with multiple PLMN
identities among which the EHPLMN list is present }
ensure that {
  when { the UE returns to coverage }
  then { the UE performs a location registration to the highest priority EHPLMN that is
available with FDD mode on the shared cell }
}

```

(2)

```

with { the UE in automatic network selection mode and there is a suitable cell with multiple PLMN
identities among which the EHPLMN list is present }
ensure that {
  when { the UE is switched on }
  then { the UE performs a location registration to the highest priority EHPLMN that is
available with TDD mode on the shared cell }
}

```

6.1.1.4a.2 Conformance requirements

References: The conformance requirements covered in the present TC are specified in: TS 36.304 clause 5.1.2.2, TS 23.122 clauses 4.4.3 and 4.4.3.1.1, TS 24.301 clauses 5.5.1.1 and 5.5.3.1, and TS 36.331 clause 5.3.3.4.

[TS 36.304 clause 5.1.2.2]

The UE shall scan all RF channels in the E-UTRA bands according to its capabilities to find available PLMNs. On each carrier, the UE shall search for the strongest cell and read its system information, in order to find out which PLMN(s) the cell belongs to. If the UE can read one or several PLMN identities in the strongest cell, each found PLMN (see the PLMN reading in [3]) shall be reported to the NAS as a high quality PLMN (but without the RSRP value),

...

Once the UE has selected a PLMN, the cell selection procedure shall be performed in order to select a suitable cell of that PLMN to camp on.

[TS 23.122 clause 4.4.3]

When the MS reselects to a cell in a shared network, the AS may indicate multiple PLMN identities to the NAS according to 3GPP TS 25.304 [32]. The MS shall choose one of these PLMNs. If the registered PLMN is available among these PLMNs, the MS shall not choose a different PLMN.

[TS 23.122 clause 4.4.3.1.1]

The MS selects and attempts registration on other PLMN/access technology combinations, if available and allowable, in the following order:

- i) either the HPLMN (if the EHPLMN list is not present or is empty) or the highest priority EHPLMN that is available (if the EHPLMN list is present) ;
- ii) each PLMN/access technology combination in the "User Controlled PLMN Selector with Access Technology" data file in the SIM (in priority order);
- iii) each PLMN/access technology combination in the "Operator Controlled PLMN Selector with Access Technology" data file in the SIM (in priority order);
- iv) other PLMN/access technology combinations with received high quality signal in random order;
- v) other PLMN/access technology combinations in order of decreasing signal quality.

[TS 24.301 clause 5.5.1.1]

...

In a shared network, the UE shall choose one of the PLMN identities as specified in 3GPP TS 23.122 [6]. The UE shall construct the TAI of the cell from this chosen PLMN identity and the TAC received as part of the broadcast system information. The chosen PLMN identity shall be indicated to the E-UTRAN (see 3GPP TS 36.331 [22]).

...

[TS 24.301 clause 5.5.3.1]

...

In a shared network, the UE shall choose one of the PLMN identities as specified in 3GPP TS 23.122 [6]. The UE shall construct the TAI of the cell from this chosen PLMN identity and the TAC received on the broadcast system information. The chosen PLMN identity shall be indicated to the E-UTRAN (see 3GPP TS 36.331 [22]).

...

[TS 36.331 clause 5.3.3.4]

The UE shall:

...

1> set the content of *RRCCConnectionSetupComplete* message as follows:

2> set the *selectedPLMN-Identity* to the PLMN selected by upper layers (see TS 23.122 [11], TS 24.301 [35]) from the PLMN(s) included in the *plmn-IdentityList* in *SystemInformationBlockType1*;

...

2> submit the *RRCCConnectionSetupComplete* message to lower layers for transmission, upon which the procedure ends;

6.1.1.4a.3 Test description

6.1.1.4a.3.1 Pre-test conditions

System Simulator:

- Cell 1, Cell 2, Cell 28 and Cell 30 as specified in TS36.508 clause 4.4.1.2 are configured according to Table 4.4.2-2 in [18] except for multiple broadcasted PLMN identities as shown in Table 6.1.1.4a.3.1-1.

Table 6.1.1.4a.3.1-1: PLMN identifiers

Cell	PLMN names	MODE
1	PLMN2,PLMN15	FDD
28	PLMN4,PLMN16	TDD
30	PLMN3,PLMN17	TDD
2	PLMN1,PLMN18	FDD

UE:

- The UE is in Automatic PLMN selection mode.
- The UE is equipped with a USIM containing default values (as per TS 36.508) except for those listed in Table 6.1.1.4a.3.1-2.

Table 6.1.1.4a.3.1-2: USIM configuration

USIM field	Priority	Value	Access Technology Identifier
EF _{LOCI}		PLMN4	
EF _{PLMNwAct}		Empty	
EF _{IMSI}		The HPLMN (MCC+MNC) of the IMSI is set to PLMN4.	E-UTRAN
EF _{UST}		Service 71 and 74 are supported.	
EF _{LRPLMNSI}		00	
EF _{EHPLMN}	1 2 3	PLMN2 PLMN1 PLMN4 Remaining mandatory entries use default values	E-UTRAN E-UTRAN E-UTRAN

Preamble:

- The UE is in state Registered, Idle mode (state 2) on Cell 28 (serving cell) according to [18].

6.1.1.4a.3.2 Test procedure sequence

Table 6.1.1.4a.3.2-1 shows the cell configurations used during the test. The configuration T0 indicates the initial conditions. Subsequent configuration marked “T1” is applied at the points indicated in the Main behaviour description in

Table 6.1.1.4a.3.2-2. Cell powers are chosen for a serving cell and a non-suitable cell as defined in TS36.508 Table 6.2.2.1-1.

Table 6.1.1.4a.3.2-1: Cell configuration changes over time

	Parameter	Unit	Cell 1	Cell 28	Cell 30	Cell 2	Remarks
T1	RS EPRE	dBm/15kHz	-79	"Off"	"Off"	-85	Power level "Off" is defined in TS36.508 Table 6.2.2.1-1
T2	RS EPRE	dBm/15kHz	"Off"	-85	-73	"Off"	Power level "Off" is defined in TS36.508 Table 6.2.2.1-1

Table 6.1.1.4a.3.2-2: Main behaviour

St	Procedure	Message Sequence		TP	Verdict
		U - S	Message		
1	The SS adjusts cell levels according to row T1 of table 6.1.1.4a.3.2-1	-	-	-	-
2	Check: Does the UE transmit an <i>RRCCoNNECTIONRequest</i> on Cell 1?	-->	<i>RRCCoNNECTIONRequest</i>	1	P
3 – 7	Steps 3 to 7 of the generic test procedure in TS 36.508 subclause 4.5A.2.1-1 are performed on Cell 1. NOTE: The UE performs TAU procedure and the RRC connection is released.	-	-	-	-
8 – 17	VOID	-	-	-	-
18	Check: Is PLMN2 indicated by the UE?	-	-	1	P
19	Power off the UE.				
20	The SS adjusts cell levels according to row T2 of table 6.1.1.4a.3.2-1	-	-	-	-
21	Power on the UE.				
22	Check: Does the UE transmit an <i>RRCCoNNECTIONRequest</i> on Cell 28?	-->	<i>RRCCoNNECTIONRequest</i>	2	P
23 – 37	Steps 3 to 17 of the generic test procedure in TS 36.508 subclause 4.5.2.3 are performed. NOTE: The UE performs registration and the RRC connection is released.	-	-	-	-
38	Check: Is PLMN4 indicated by the UE?	-	-	2	P

6.1.1.4a.3.3 Specific message contents

Table 6.1.1.4a.3.3-1: *RRCCoNNECTIONSetupComplete* (step 4, Table 6.1.1.4a.3.2-2)

Derivation Path: 36.508, Table 4.6.1-18			
Information Element	Value/remark	Comment	Condition
<i>RRCCoNNECTIONSetupComplete</i> ::= SEQUENCE {			
criticalExtensions CHOICE {			
c1 CHOICE {			
<i>rrcCoNNECTIONSetupComplete-r8</i> SEQUENCE {			
selectedPLMN-Identity	1	PLMN2	
}			
}			
}			
}			

6.1.1.5 Void

6.1.1.6 PLMN selection of RPLMN, HPLMN/EHPLMN, UPLMN and OPLMN / Automatic mode / User reselection

6.1.1.6.1 Test Purpose (TP)

(1)

```
with { UE in Automatic network selection mode registered to UPLMN and RPLMN, UPLMN and OPLMN E-UTRAN
cells available }
ensure that {
  when { UE is requested to initiate reselection and registration onto an available PLMN }
  then { UE reselects to the cell which belongs to higher priority OPLMN }
}
```

(2)

```
with { UE in Automatic network selection mode registered to OPLMN and only RPLMN E-UTRAN cell
available }
ensure that {
  when { UE is requested to initiate reselection and registration onto an available PLMN }
  then { UE remains on the current cell which belongs to RPLMN. }
}
```

(3)

```
with { UE in Automatic network selection mode registered to OPLMN and RPLMN, UPLMN and OPLMN E-UTRAN
cells available }
ensure that {
  when { UE is requested to initiate reselection and registration onto an available PLMN }
  then { UE reselects to the cell which belongs to UPLMN }
}
```

(4)

```
with { UE in Automatic network selection mode registered to UPLMN and RPLMN, UPLMN, OPLMN and HPLMN
E-UTRAN cells available }
ensure that {
  when { UE is requested to initiate reselection and registration onto an available PLMN }
  then { UE reselects to the cell which belongs to HPLMN }
}
```

6.1.1.6.2 Conformance requirements

References: The conformance requirements covered in the present TC are specified in: TS 23.122, clause 4.4.3.2 and 4.4.3.2.1.

[TS 23.122, clause 4.4.3.2]

At any time the user may request the MS to initiate reselection and registration onto an available PLMN, according to the following procedures, dependent upon the operating mode.

[TS 23.122, clause 4.4.3.2.1]

The MS selects and attempts registration on PLMNs, if available and allowable, in all of its bands of operation in accordance with the following order:

- i) the HPLMN (if the EHPLMN list is not present or is empty) or the highest priority EHPLMN that is available (if the EHPLMN list is present);
- ii) PLMN/access technology combinations contained in the "User Controlled PLMN Selector with Access Technology" data file in the SIM (in priority order) excluding the previously selected PLMN/access technology combination;
- iii) PLMN/access technology combinations contained in the "Operator Controlled PLMN Selector with Access Technology" data file in the SIM (in priority order) excluding the previously selected PLMN/access technology combination;

- iv) other PLMN/access technology combinations with the received high quality signal in random order excluding the previously selected PLMN/access technology combination;
- v) other PLMN/access technology combinations, excluding the previously selected PLMN/access technology combination in order of decreasing signal quality or, alternatively, the previously selected PLMN/access technology combination may be chosen ignoring its signal quality;
- vi) The previously selected PLMN/access technology combination.

The previously selected PLMN/access technology combination is the PLMN/access technology combination which the MS has selected prior to the start of the user reselection procedure.

NOTE 1: If the previously selected PLMN is chosen, and registration has not been attempted on any other PLMNs, then the MS is already registered on the PLMN, and so registration is not necessary.

The equivalent PLMNs list shall not be applied to the user reselection in Automatic Network Selection Mode.

6.1.1.6.3 Test description

6.1.1.6.3.1 Pre-test conditions

System Simulator:

- Four inter-frequency multi-PLMN cells as specified in TS36.508 clause 4.4.1.2 are configured broadcasting default NAS parameters as indicated in TS 36.508 Table 4.4.2-2.
- The PLMNs are identified in the test by the identifiers in Table 6.1.1.6.3.1-1.

Table 6.1.1.6.3.1-1: PLMN identifiers

• Cell	• PLMN name
• 1	• PLMN1
• 12	• PLMN2
• 13	• PLMN3
• 14	• PLMN4

UE:

- The UE is in Automatic PLMN selection mode.
- The UE is equipped with a USIM containing default values (as per TS 36.508) except for those listed in Table 6.1.1.6.3.1-2.

Table 6.1.1.6.3.1-2: USIM configuration

USIM field	Priority	Value	Access Technology Identifier
EF _{LOCI}		PLMN1	
EF _{IMSI}		The HPLMN (MCC+MNC) of the IMSI is set to PLMN3.	
EF _{PLMNwAcT}	1	PLMN1 Remaining mandatory entries use default values	E-UTRAN
EF _{OPLMNwACT}	1 2	PLMN2 PLMN4 Remaining defined entries use default values	E-UTRAN E-UTRAN
EF _{HPLMNwAcT}	1	PLMN3	E-UTRAN
EF _{UST}		Service 71 is not supported	

Preamble:

- The UE is in state Registered, Idle Mode (State 2) on Cell 1 according to [18].

6.1.1.6.3.2 Test procedure sequence

Table 6.1.1.6.3.2-1: Time instances of cell power level and parameter changes

	Parameter	Unit	Cell 1	Cell 12	Cell 13	Cell 14	Remark
T1	Cell-specific RS EPRE	dBm/15 kHz	-85	-85	"Off"	-85	The power level values are assigned to satisfy $R_{\text{Cell 1}} = R_{\text{Cell 12}} = R_{\text{Cell 14}}$. (NOTE 1).
T2	Cell-specific RS EPRE	dBm/15 kHz	"Off"	-85	"Off"	"Off"	Only Cell 12 is available. (NOTE 1).
T3	Cell-specific RS EPRE	dBm/15 kHz	-85	"Off"	-85	-85	The power level values are assigned to satisfy $R_{\text{Cell 1}} = R_{\text{Cell 13}} = R_{\text{Cell 14}}$. (NOTE 1).
NOTE 1: Power level "Off" is defined in TS36.508 Table 6.2.2.1-1.							

Table 6.1.1.6.3.2-2: Main behaviour

St	Procedure	Message Sequence		TP	Verdict
		U - S	Message		
1	The SS changes the power level setting according to the row "T1" in table 6.1.1.6.3.2-1	-	-	-	-
2	Cause the UE in Automatic network selection mode to initiate user reselection and registration onto an available PLMN. (see Note)	-	-	-	-
3	Check: Does the UE send an <i>RRCCConnectionRequest</i> on Cell 12?	-->	<i>RRCCConnectionRequest</i>	1	P
4-8	Steps 2 to 6 of the generic test procedure in TS 36.508 subclause 6.4.2.7 are performed on Cell 12. NOTE: The UE performs a TAU procedure and the RRC connection is released.	-	-	-	-
9	Check: Is PLMN 2 indicated by the UE?	-	-	1	P
10	The SS changes the power level setting according to the row "T2" in table 6.1.1.6.3.2-1.	-	-	-	-
11	Cause the UE in Automatic network selection mode to initiate user reselection and registration onto an available PLMN. (see Note)	-	-	-	-
12	Check: Does the UE send an <i>RRCCConnectionRequest</i> on Cell 12 within 90 s?	-->	<i>RRCCConnectionRequest</i>	2	F
13	Check: Is PLMN 2 indicated by the UE?	-	-	2	P
14	The SS changes the power level setting according to the row "T1" in table 6.1.1.6.3.2-1.	-	-	-	-
15	Cause the UE in Automatic network selection mode to initiate user reselection and registration onto an available PLMN. (see Note)	-	-	-	-
16	Check: Does the UE send an <i>RRCCConnectionRequest</i> on Cell 1?	-->	<i>RRCCConnectionRequest</i>	3	P
17-21	Steps 2 to 6 of the generic test procedure in TS 36.508 subclause 6.4.2.7 are performed on Cell 1. NOTE: The UE performs a TAU procedure and the RRC connection is released.	-	-	-	-
22	Check: Is PLMN 1 indicated by the UE?	-	-	3	P
23	The SS changes the power level setting according to the row "T3" in table 6.1.1.6.3.2-1.	-	-	-	-
24	Cause the UE in Automatic network selection mode to initiate user reselection and registration onto an available PLMN. (see Note)	-	-	-	-
25	Check: Does the UE send an <i>RRCCConnectionRequest</i> on Cell 13?	-->	<i>RRCCConnectionRequest</i>	4	P
26-30	Steps 2 to 6 of the generic test procedure in TS 36.508 subclause 6.4.2.7 are performed on Cell 13. NOTE: The UE performs a TAU procedure and the RRC connection is released.	-	-	-	-
31	Check: Is PLMN 3 indicated by the UE?	-	-	4	P
Note: MMI command "TRIGGER_USER_RESELECTION" to be used. AT command AT+COPS is not suitable to achieve the test purpose.					

6.1.1.6.3.3 Specific message contents

None

6.1.1.6a PLMN selection of RPLMN, HPLMN/EHPLMN, UPLMN and OPLMN / Automatic mode / User reselection / Single Frequency operation

6.1.1.6a.1 Test Purpose (TP)

Same Test Purpose as in clause 6.1.1.6.1

6.1.1.6a.2 Conformance requirements

Same Conformance requirements as in clause 6.1.1.6.2

6.1.1.6a.3 Test description

6.1.1.6a.3.1 Pre-test conditions

System Simulator:

- Four intra-frequency multi-PLMN cells as specified in TS36.508 clause 4.4.1.2 are configured broadcasting default NAS parameters as indicated in TS 36.508 Table 4.4.2-2.

System information combination 1 as defined in TS 36.508 [18] clause 4.4.3.1 is used in E-UTRA cells.

- The PLMNs are identified in the test by the identifiers in Table 6.1.1.6a.3.1-1.

Table 6.1.1.6a.3.1-1: PLMN identifiers

Cell	PLMN name
1	PLMN1
2	PLMN2
4	PLMN3
11	PLMN4

UE:

- The UE is in Automatic PLMN selection mode.
- The UE is equipped with a USIM containing default values (as per TS 36.508) except for those listed in Table 6.1.1.6a.3.1-2.

Table 6.1.1.6a.3.1-2: USIM configuration

USIM field	Priority	Value	Access Technology Identifier
EF _{LOCI}		PLMN1	
EF _{IMSI}		The HPLMN (MCC+MNC) of the IMSI is set to PLMN3.	
EF _{PLMNwACT}	1	PLMN1 Remaining mandatory entries use default values	E-UTRAN
EF _{OPLMNwACT}	1 2	PLMN2 PLMN4 Remaining defined entries use default values	E-UTRAN E-UTRAN
EF _{HPLMNwACT}	1	PLMN3	E-UTRAN
EF _{UST}		Service 71 is not supported	

Preamble:

- The UE is in state Registered, Idle Mode (State 2) on Cell 1 according to [18].

6.1.1.6a.3.2 Test procedure sequence

Table 6.1.1.6a.3.2-1: Time instances of cell power level and parameter changes

	Parameter	Unit	Cell 1	Cell 2	Cell 4	Cell 11	Remark
T1	Cell-specific RS EPRE	dBm/15 kHz	-85	-79	"Off"	-85	(NOTE 1)
T2	Cell-specific RS EPRE	dBm/15 kHz	"Off"	-85	"Off"	"Off"	Only Cell 2 is available. (NOTE 1)
T3	Cell-specific RS EPRE	dBm/15 kHz	-79	-85	"Off"	-85	(NOTE 1).
T4	Cell-specific RS EPRE	dBm/15 kHz	-85	"Off"	-79	-85	(NOTE 1)

NOTE 1: Power level "Off" is defined in TS36.508 Table 6.2.2.1-1.

Table 6.1.1.6a.3.2-2: Main behaviour

St	Procedure	Message Sequence		TP	Verdict
		U - S	Message		
1	The SS changes the power level setting according to the row "T1" in table 6.1.1.6a.3.2-1	-	-	-	-
2	Cause the UE in Automatic network selection mode to initiate user reselection and registration onto an available PLMN. (see Note)	-	-	-	-
3	Check: Does the UE send an <i>RRCCConnectionRequest</i> on Cell 2?	-->	<i>RRCCConnectionRequest</i>	1	P
4-8	Steps 2 to 6 of the generic test procedure in TS 36.508 subclause 6.4.2.7 are performed on Cell 2. NOTE: The UE performs a TAU procedure and the RRC connection is released.	-	-	-	-
9	Check: Is PLMN 2 indicated by the UE?	-	-	1	P
10	The SS changes the power level setting according to the row "T2" in table 6.1.1.6a.3.2-1.	-	-	-	-
11	Cause the UE in Automatic network selection mode to initiate user reselection and registration onto an available PLMN. (see Note)	-	-	-	-
12	Check: Does the UE send an <i>RRCCConnectionRequest</i> on Cell 2 within 90 s?	-->	<i>RRCCConnectionRequest</i>	2	F
13	Check: Is PLMN 2 indicated by the UE?	-	-	2	P
14	The SS changes the power level setting according to the row "T3" in table 6.1.1.6a.3.2-1.	-	-	-	-
15	Cause the UE in Automatic network selection mode to initiate user reselection and registration onto an available PLMN. (see Note)	-	-	-	-
16	Check: Does the UE send an <i>RRCCConnectionRequest</i> on Cell 1?	-->	<i>RRCCConnectionRequest</i>	3	P
17-21	Steps 2 to 6 of the generic test procedure in TS 36.508 subclause 6.4.2.7 are performed on Cell 1. NOTE: The UE performs a TAU procedure and the RRC connection is released.	-	-	-	-
22	Check: Is PLMN 1 indicated by the UE?	-	-	3	P
23	The SS changes the power level setting according to the row "T4" in table 6.1.1.6a.3.2-1.	-	-	-	-
24	Cause the UE in Automatic network selection mode to initiate user reselection and registration onto an available PLMN. (see Note)	-	-	-	-
25	Check: Does the UE send an <i>RRCCConnectionRequest</i> on Cell 4?	-->	<i>RRCCConnectionRequest</i>	4	P
26-30	Steps 2 to 6 of the generic test procedure in TS 36.508 subclause 6.4.2.7 are performed on Cell 4. NOTE: The UE performs a TAU procedure and the RRC connection is released.	-	-	-	-
31	Check: Is PLMN 3 indicated by the UE?	-	-	4	P
Note:	MMI command "TRIGGER_USER_RESELECTION" to be used. AT command AT+COPS is not suitable to achieve the test purpose..				

6.1.1.6a.3.3 Specific message contents

Table 6.1.1.6a.3.3-1: SystemInformationBlockType3 for cells 1 and 2 (preamble and all steps, table 6.1.1.6a.3.2-2)

Derivation Path: 36.508 table 4.4.3.3-2		
Information Element	Value/remark	Comment
SystemInformationBlockType3 ::= SEQUENCE {		
cellReselectionInfoCommon SEQUENCE {		
q-Hyst	dB24	
}		
}		

6.1.1.7 PLMN selection / Periodic reselection / MinimumPeriodicSearchTimer

6.1.1.7.1 Test Purpose (TP)

(1)

```

with { UE configured with "MinimumPeriodicSearchTimer" and camped on an E-UTRAN VPLMN cell and cells
of a higher priority E-UTRAN PLMN available }
ensure that {
  when { the higher priority PLMN search timer T is less than the MinimumPeriodicSearchTimer }
  then { the UE shall not use a value for T that is less than the MinimumPeriodicSearchTimer. When
the T expires the UE selects and camps on a cell of the highest priority PLMN and UE attempts a
location registration on the selected cell and when successfully registered indicates the selected
PLMN to the user. }
}

```

6.1.1.7.2 Conformance requirements

References: The conformance requirements covered in the present TC are specified in: TS 23.122 clauses 4.4.3.1 and 4.4.3.3.1.

[TS 23.122, clause 4.4.3.1]

At switch on, or following recovery from lack of coverage, the MS selects the registered PLMN or equivalent PLMN (if it is available) using all access technologies that the MS is capable of and if necessary (in the case of recovery from lack of coverage, see clause 4.5.2) attempts to perform a Location Registration.

...

If successful registration is achieved, the MS indicates the selected PLMN.

If there is no registered PLMN, or if registration is not possible due to the PLMN being unavailable or registration failure, the MS follows one of the following two procedures depending on its PLMN selection operating mode. At switch on, if the MS provides the optional feature of user preferred PLMN selection operating mode at switch on then this operating mode shall be used.

...

NOTE 1: If successful registration is achieved, then the current serving PLMN becomes the registered PLMN and the MS does not store the previous registered PLMN for later use.

[TS 23.122, clause 4.4.3.3.1]

If the MS is in a VPLMN, the MS shall periodically attempt to obtain service on its HPLMN (if the EHPLMN list is not present or is empty) or one of its EHPLMNs (if the EHPLMN list is present) or a higher priority PLMN/access technology combinations listed in "user controlled PLMN selector" or "operator controlled PLMN selector" by scanning in accordance with the requirements that are applicable to i), ii) and iii) as defined in the Automatic Network Selection Mode in subclause 4.4.3.1.1. In the case that the mobile has a stored "Equivalent PLMNs" list the mobile shall only select a PLMN if it is of a higher priority than those of the same country as the current serving PLMN which are stored in the "Equivalent PLMNs" list. For this purpose, a value T minutes may be stored in the SIM, T is either in the range 6 minutes to 8 hours in 6 minute steps or it indicates that no periodic attempts shall be made. If no value is stored in the SIM, a default value of 60 minutes is used for T.

If the MS is configured with the MinimumPeriodicSearchTimer as specified in 3GPP TS 24.368 [50] or 3GPP TS 31.102 [40], the MS shall not use a value for T that is less than the MinimumPeriodicSearchTimer. If the value stored in the SIM, or the default value for T (when no value is stored in the SIM), is less than the MinimumPeriodicSearchTimer, then T shall be set to the MinimumPeriodicSearchTimer.

The attempts to access the HPLMN or an EHPLMN or higher priority PLMN shall be as specified below:

- a) The periodic attempts shall only be performed in automatic mode when the MS is roaming, and not while the MS is attached for emergency bearer services or has a PDN connection for emergency bearer services;
- b) After switch on a period of at least 2 minutes and at most T minutes shall elapse before the first attempt is made;

....

6.1.1.7.3 Test description

6.1.1.7.3.1 Pre-test conditions

System Simulator:

- Three multi-PLMN cells as specified in TS36.508 clause 4.4.1.2 are configured broadcasting PLMNs as indicated in Table 6.1.1.7.3.1-1.
- The PLMNs are identified in the test by the identifiers in Table 6.1.1.7.3.1-1.

Table 6.1.1.7.3.1-1: PLMN identifiers

Cell	PLMN name	MCC	MNC
1	PLMN4	001	01
12	PLMN1	001	11
13	PLMN2	001	21

UE:

- The UE is in Automatic PLMN selection mode.
- The UE is registered to PLMN1 before it is switched off.
- The UE is configured with a value of MinimumPeriodicSearchTimer set to 7 minutes
- The UE is equipped with a USIM containing default values (as per TS 36.508) except for those listed in Table 6.1.1.7.3.1-2.

Table 6.1.1.7.3.1-2: USIM configuration

USIM field	Priority	Value	Access Technology Identifier
EF _{LOCI}		PLMN1 (See preamble)	
EF _{IMSI}		The HPLMN (MCC+MNC) of the IMSI is set to PLMN4.	
EF _{PLMNwAcT}	1 2	Default PLMN2 Remaining mandatory entries use default values	Default E-UTRAN
EF _{OPLMNwAcT}	1	PLMN1 Remaining defined entries use default values	All specified
EF _{HPLMNwAcT}	1	PLMN4	E-UTRAN
EF _{UST}		Services 20, 42, 43 and 74 are supported. Service 71 is not supported (there is no EHPLMN list).	
EF _{HPPLMN}		1 (6 minutes)	

Preamble:

- The UE is in state Switched OFF (State 1).

6.1.1.7.3.2 Test procedure sequence

Table 6.1.1.7.3.2 – 1 shows the cell configurations used during the test. The configuration T0 indicates the initial conditions. Subsequent configurations marked “T1” is applied at the point indicated in the Main behaviour description in Table 6.1.1.7.3.2-2. Cell powers are chosen for a serving cell and a non-suitable “Off” cell as defined in TS36.508 Table 6.2.2.1-1.

Table 6.1.1.7.3.2-1: Cell configuration changes over time

	Parameter	Unit	Cell 1	Cell 12	Cell 13	Remarks
T0	RS EPRE	dBm/15kHz	“Off”	-85	“Off”	Power level “Off” is defined in TS36.508 Table 6.2.2.1-1
T1	RS EPRE	dBm/15kHz	“Off”	-85	-85	Power level “Off” is defined in TS36.508 Table 6.2.2.1-1
T2	RS EPRE	dBm/15kHz	-85	-85	-85	Power level “Off” is defined in TS36.508 Table 6.2.2.1-1

Table 6.1.1.7.3.2-2: Main behaviour

St	Procedure	Message Sequence		TP	Verdict
		U - S	Message		
1	SS adjusts cell levels according to row T1 of table 6.1.1.7.3.2-1	-	-	-	-
2	Power on the UE.	-	-	-	-
3-18	Steps 2 to 17 of the registration procedure described in TS 36.508 subclause 4.5.2.3 are performed on Cell 13. NOTE: The UE performs registration and the RRC connection is released.	-	-	-	-
19	UE selects PLMN1	-	-	-	-
20	Check: Does the UE send an <i>RRCCConnectionRequest</i> on Cell 1 after 120 seconds, but before 420 seconds from power on?	-->	<i>RRCCConnectionRequest</i>	1	P
21-25	Steps 2 to 6 of the generic test procedure in TS 36.508 subclause 6.4.2.7 are performed on Cell 1. NOTE: The UE performs a TAU procedure and the RRC connection is released.	-	-	-	-
26	Check: Is PLMN2 indicated by the UE?	-	-	1	P
27	SS adjusts cell levels according to row T2 of table 6.1.1.7.3.2-1	-	-	-	-
28	Check: Does the UE send an <i>RRCCConnectionRequest</i> after 420 seconds from step 23?	-->	<i>RRCCConnectionRequest</i>	1	P
29-33	Steps 2 to 6 of the generic test procedure in TS 36.508 subclause 6.4.2.7 are performed on Cell 1. NOTE: The UE performs a TAU procedure and the RRC connection is released.	-	-	-	-
34	Check: Is PLMN4 indicated by the UE?	-	-	1	P

Note 1: Timers in Steps 20 and 28 are derived from the value defined by the *MinimumPeriodicSearchTimer*

6.1.1.7.3.3 Specific message contents

None

6.1.2 Cell selection and reselection

6.1.2.1 Void

6.1.2.2 Cell selection / Qrxlevmin

6.1.2.2.1 Test Purpose (TP)

(1)

```
with { UE in E-UTRA RRC_IDLE state }
ensure that {
  when { a cell fulfils all requirements for a suitable cell except the cell selection criteria
which are not fulfilled (S<0) }
  then { the UE does not consider the cell suitable and no camping on this cell can take place }
}
```

(2)

```
with { UE in E-UTRA RRC_IDLE state }
ensure that {
  when { a cell fulfils all requirements for a suitable cell including the cell selection criteria
for a cell which are also fulfilled (S>0) }
  then { the UE considers the cell suitable and camps on it }
}
```

6.1.2.2.2 Conformance requirements

References: The conformance requirements covered in the current TC are specified in: TS36.300, clause 10.1.1.1 and TS 36.304, clause 4.1, 5.1.2.2, 5.2.3.1, 5.2.3.2 and 5.2.8.

[TS 36.300, clause 10.1.1.1]

Cell selection:

- The UE NAS identifies a selected PLMN and equivalent PLMNs;
- The UE searches the E-UTRA frequency bands and for each carrier frequency identifies the strongest cell. It reads cell system information broadcast to identify its PLMN(s):
 - The UE may search each carrier in turn ("initial cell selection") or make use of stored information to shorten the search ("stored information cell selection").
- The UE seeks to identify a suitable cell; if it is not able to identify a suitable cell it seeks to identify an acceptable cell. When a suitable cell is found or if only an acceptable cell is found it camps on that cell and commence the cell reselection procedure:
 - A suitable cell is one for which the measured cell attributes satisfy the cell selection criteria; the cell PLMN is the selected PLMN, registered or an equivalent PLMN; the cell is not barred or reserved and the cell is not part of a tracking area which is in the list of "forbidden tracking areas for roaming";
 - An acceptable cell is one for which the measured cell attributes satisfy the cell selection criteria and the cell is not barred;

[TS 36.304, clause 4.1]

When a UE is switched on, a public land mobile network (PLMN) is selected by NAS. For the selected PLMN, associated RAT(s) may be set [5]. The NAS shall provide a list of equivalent PLMNs, if available, that the AS shall use for cell selection and cell reselection.

With the cell selection, the UE searches for a suitable cell of the selected PLMN and chooses that cell to provide available services, further the UE shall tune to its control channel. This choosing is known as "camping on the cell".

The UE will, if necessary, then register its presence, by means of a NAS registration procedure, in the tracking area of the chosen cell and as outcome of a successful Location Registration the selected PLMN becomes the registered PLMN [5].

[TS 36.304, clause 5.1.2.2]

The UE shall scan all RF channels in the E-UTRA bands according to its capabilities to find available PLMNs. On each carrier, the UE shall search for the strongest cell and read its system information, in order to find out which PLMN(s) the cell belongs to. If the UE can read one or several PLMN identities in the strongest cell, each found PLMN (see the PLMN reading in [3]) shall be reported to the NAS as a high quality PLMN (but without the RSRP value), provided that the following high quality criterion is fulfilled:

1. For an E-UTRAN cell, the measured RSRP value shall be greater than or equal to -110 dBm.

Found PLMNs that do not satisfy the high quality criterion, but for which the UE has been able to read the PLMN identities are reported to the NAS together with the RSRP value. The quality measure reported by the UE to NAS shall be the same for each PLMN found in one cell.

...

Once the UE has selected a PLMN, the cell selection procedure shall be performed in order to select a suitable cell of that PLMN to camp on.

[TS 36.304, clause 5.2.3.1]

The UE shall use one of the following two cell selection procedures:

- a) Initial Cell Selection

This procedure requires no prior knowledge of which RF channels are E-UTRA carriers. The UE shall scan all RF channels in the E-UTRA bands according to its capabilities to find a suitable cell. On each carrier frequency, the UE need only search for the strongest cell. Once a suitable cell is found this cell shall be selected.

[TS 36.304, clause 5.2.3.2]

The cell selection criterion S is fulfilled when:

$$S_{rxlev} > 0$$

Where:

$$S_{rxlev} = Q_{rxlevmeas} - (Q_{rxlevmin} + Q_{rxlevminoffset}) - P_{compensation}$$

Where:

the signalled value $Q_{rxlevminOffset}$ is only applied when a cell is evaluated for cell selection as a result of a periodic search for a higher priority PLMN while camped normally in a VPLMN [5]. During this periodic search for higher priority PLMN the UE may check the S criteria of a cell using parameter values stored from a different cell of this higher priority PLMN.

S_{rxlev}	Cell Selection RX level value (dB)
$Q_{rxlevmeas}$	Measured cell RX level value (RSRP).
$Q_{rxlevmin}$	Minimum required RX level in the cell (dBm)
$Q_{rxlevminoffset}$	Offset to the signalled $Q_{rxlevmin}$ taken into account in the S_{rxlev} evaluation as a result of a periodic search for a higher priority PLMN while camped normally in a VPLMN [5]
$P_{compensation}$	$\max(P_{EMAX} - P_{UMAX}, 0)$ (dB)
P_{EMAX}	Maximum TX power level an UE may use when transmitting on the uplink in the cell (dBm) defined as P_{EMAX} in [TS 36.101]
P_{UMAX}	Maximum RF output power of the UE (dBm) according to the UE power class as defined in [TS 36.101]

[TS 36.304, clause 5.2.8]

In this state, the UE shall attempt to find an acceptable cell of any PLMN to camp on, trying all RATs that are supported by the UE and searching first for a high quality cell, as defined in subclause 5.1.2.2.

The UE, which is not camped on any cell, shall stay in this state until an acceptable cell is found.

6.1.2.2.3 Test description

6.1.2.2.3.1 Pre-test conditions

System Simulator:

- Cell 1

UE:

- None.

Preamble:

- The UE is in state Switched OFF (state 1) according to [18].

6.1.2.2.3.2 Test procedure sequence

Table 6.1.2.2.3.2-1 illustrates the downlink power levels and other changing parameters to be applied for the cell at various time instants of the test execution. The exact instants on which these values shall be applied are described in the texts in this clause. Configurations marked "T1" and "T2" are applied at the points indicated in the Main behaviour description in Table 6.1.2.2.3.2-2

Table 6.1.2.2.3.2-1: Time instances of cell power level and parameter changes

	Parameter	Unit	Cell 1	Remark
T1	Cell-specific RS EPRE	dBm/15kHz	-95	The power level value is such to satisfy $S_{rxlevCell\ 1} < 0$ but the UE is able to read the PLMN identity
	Qrxlevmin	dBm	-84	
	Qrxlevminoffset	dB	0	
	Pcompensation	dB	0	
T2	Cell-specific RS EPRE	dBm/15kHz	-75	The power level is such that $S_{rxlevCell\ 1} > 0$
Note: The downlink signal level uncertainty is specified in TS 36.508 section 4.3.4.1				

Table 6.1.2.2.3.2-2: Main behaviour

St	Procedure	Message Sequence		TP	Verdict
		U - S	Message		
0A	SS re-adjusts the cell-specific reference signal level of Cell 1 according to row "T1" in table 6.1.2.2.3.2-1.	-	-	-	-
0B	Wait for 1.1* modification period to allow the new system information to take effect.	-	-	-	-
1	The UE is switched on.	-	-	-	-
2	Check: Does the UE send an <i>RRCCoNNECTIONRequest</i> on Cell 1 within the next 60 s?	-->	<i>RRCCoNNECTIONRequest</i>	1	F
3	SS re-adjusts the cell-specific reference signal level of Cell 1 level according to row "T2" in table 6.1.2.2.3.2-1.	-	-	-	-
4	Check: Does the UE send an <i>RRCCoNNECTIONRequest</i> on Cell 1?	-->	<i>RRCCoNNECTIONRequest</i>	2	P
5-19	Steps 3 to 17 of the registration procedure described in TS 36.508 subclause 4.5.2.3 are performed on Cell 1. NOTE: The UE performs registration and the RRC connection is released.	-	-	-	-

6.1.2.2.3.3 Specific message contents

Table 6.1.2.2.3.3-1: SystemInformationBlockType1 for cell 1 (all steps)

Derivation Path: 36.508 clause 4.4.3.2			
Information Element	Value/Remark	Comment	Condition
SystemInformationBlockType1 ::= SEQUENCE {			
cellSelectionInfo SEQUENCE {			
q-RxLevMin	-42 (-84 dBm)		
}			
}			

6.1.2.2a Cell selection / Qqualmin

6.1.2.2a.1 Test Purpose (TP)

(1)

```

with { UE in E-UTRA RRC_IDLE state }
ensure that {
  when { a cell fulfils all requirements for a suitable cell except the cell selection criteria
which are not fulfilled ( $S_{rxlev} > 0$  AND  $S_{qual} < 0$ ) }
  then { the UE does not consider the cell suitable and no camping on this cell can take place }
}
    
```

(2)

```

with { UE in E-UTRA RRC_IDLE state }
ensure that {
  when { a cell fulfils all requirements for a suitable cell including the cell selection criteria
for a cell which are also fulfilled (Srxlev>0 AND Squal>0) }
  then { the UE considers the cell suitable and camps on it }
}

```

6.1.2.2a.2 Conformance requirements

References: The conformance requirements covered in the current TC are specified in: TS36.300, clause 10.1.1.1 and TS 36.304, clause 4.1, 5.1.2.2, 5.2.3.1, 5.2.3.2 and 5.2.8.

[TS 36.300, clause 10.1.1.1]

Cell selection:

- The UE NAS identifies a selected PLMN and equivalent PLMNs;
- The UE searches the E-UTRA frequency bands and for each carrier frequency identifies the strongest cell. It reads cell system information broadcast to identify its PLMN(s):
 - The UE may search each carrier in turn (“initial cell selection”) or make use of stored information to shorten the search (“stored information cell selection”).
- The UE seeks to identify a suitable cell; if it is not able to identify a suitable cell it seeks to identify an acceptable cell. When a suitable cell is found or if only an acceptable cell is found it camps on that cell and commence the cell reselection procedure:
 - A suitable cell is one for which the measured cell attributes satisfy the cell selection criteria; the cell PLMN is the selected PLMN, registered or an equivalent PLMN; the cell is not barred or reserved and the cell is not part of a tracking area which is in the list of “forbidden tracking areas for roaming”;
 - An acceptable cell is one for which the measured cell attributes satisfy the cell selection criteria and the cell is not barred;

[TS 36.304, clause 4.1]

When a UE is switched on, a public land mobile network (PLMN) is selected by NAS. For the selected PLMN, associated RAT(s) may be set [5]. The NAS shall provide a list of equivalent PLMNs, if available, that the AS shall use for cell selection and cell reselection.

With the cell selection, the UE searches for a suitable cell of the selected PLMN and chooses that cell to provide available services, further the UE shall tune to its control channel. This choosing is known as "camping on the cell".

The UE shall, if necessary, then register its presence, by means of a NAS registration procedure, in the tracking area of the chosen cell and as outcome of a successful Location Registration the selected PLMN becomes the registered PLMN [5].

[TS 36.304, clause 5.1.2.2]

The UE shall scan all RF channels in the E-UTRA bands according to its capabilities to find available PLMNs. On each carrier, the UE shall search for the strongest cell and read its system information, in order to find out which PLMN(s) the cell belongs to. If the UE can read one or several PLMN identities in the strongest cell, each found PLMN (see the PLMN reading in [3]) shall be reported to the NAS as a high quality PLMN (but without the RSRP value), provided that the following high quality criterion is fulfilled:

1. For an E-UTRAN cell, the measured RSRP value shall be greater than or equal to -110 dBm.

Found PLMNs that do not satisfy the high quality criterion, but for which the UE has been able to read the PLMN identities are reported to the NAS together with the RSRP value. The quality measure reported by the UE to NAS shall be the same for each PLMN found in one cell.

...

Once the UE has selected a PLMN, the cell selection procedure shall be performed in order to select a suitable cell of that PLMN to camp on.

[TS 36.304, clause 5.2.3.1]

The UE shall use one of the following two cell selection procedures:

a) Initial Cell Selection

This procedure requires no prior knowledge of which RF channels are E-UTRA carriers. The UE shall scan all RF channels in the E-UTRA bands according to its capabilities to find a suitable cell. On each carrier frequency, the UE need only search for the strongest cell. Once a suitable cell is found this cell shall be selected.

[TS 36.304, clause 5.2.3.2]

The cell selection criterion S is fulfilled when:

$$S_{rxlev} > 0 \text{ AND } S_{qual} > 0$$

where:

$$S_{rxlev} = Q_{rxlevmeas} - (Q_{rxlevmin} + Q_{rxlevminoffset}) - P_{compensation}$$

$$S_{qual} = Q_{qualmeas} - (Q_{qualmin} + Q_{qualminoffset})$$

where:

S_{rxlev}	Cell selection RX level value (dB)
S_{qual}	Cell selection quality value (dB)
$Q_{rxlevmeas}$	Measured cell RX level value (RSRP)
$Q_{qualmeas}$	Measured cell quality value (RSRQ)
$Q_{rxlevmin}$	Minimum required RX level in the cell (dBm)
$Q_{qualmin}$	Minimum required quality level in the cell (dB)
$Q_{rxlevminoffset}$	Offset to the signalled $Q_{rxlevmin}$ taken into account in the S_{rxlev} evaluation as a result of a periodic search for a higher priority PLMN while camped normally in a VPLMN [5]
$Q_{qualminoffset}$	Offset to the signalled $Q_{qualmin}$ taken into account in the S_{qual} evaluation as a result of a periodic search for a higher priority PLMN while camped normally in a VPLMN [5]
$P_{compensation}$	$\max(P_{EMAX} - P_{PowerClass}, 0)$ (dB)
P_{EMAX}	Maximum TX power level an UE may use when transmitting on the uplink in the cell (dBm) defined as P_{EMAX} in [TS 36.101]
$P_{PowerClass}$	Maximum RF output power of the UE (dBm) according to the UE power class as defined in [TS 36.101]

[TS 36.304, clause 5.2.8]

In this state, the UE shall attempt to find an acceptable cell of any PLMN to camp on, trying all RATs that are supported by the UE and searching first for a high quality cell, as defined in subclause 5.1.2.2.

The UE, which is not camped on any cell, shall stay in this state until an acceptable cell is found.

6.1.2.2a.3 Test description

6.1.2.2a.3.1 Pre-test conditions

System Simulator:

- Cell 1

UE:

- None.

Preamble:

- The UE is in state Switched OFF (state 1) according to [18].

6.1.2.2a.3.2 Test procedure sequence

Table 6.1.2.2a.3.2-1 illustrates the downlink power levels and other changing parameters to be applied for the cell at various time instants of the test execution. The exact instants on which these values shall be applied are described in the texts in this clause. Configurations marked "T1" and "T2" are applied at the points indicated in the Main behaviour description in Table 6.1.2.2a.3.2-2

Table 6.1.2.2a.3.2-1: Time instances of cell power level and parameter changes

	Parameter	Unit	Cell 1	Remark
T1	Cell-specific RS EPRE	dBm/ 15kHz z	-95	The power level value is such to satisfy $S_{rxlev}Cell\ 1 > 0$ and $S_{qual}Cell\ 1 < 0$ but the UE is able to read the PLMN identity
	RSRQ	dB	-32	
	Noc	dBm/ 15kHz z	-75	
	Qrxlevmin	dBm	-106	(default value in 36.508 Table 4.4.3.2-3)
	Qrxlevminoffset	dB	0	
	Qqualmin	dB	-18	
	Qqualminoffset	dB	0	
	Pcompensation	dB	0	
T2	Cell-specific RS EPRE	dBm/ 15kHz z	-65	The power level is such that $S_{rxlev}Cell\ 1 > 0$ and $S_{qual}Cell\ 1 > 0$
	RSRQ	dB	-5	
	Noc	dBm/ 15kHz z	-75	
Note: The downlink signal level uncertainty is specified in TS 36.508 section 4.3.4.1				

Table 6.1.2.2a.3.2-2: Main behaviour

St	Procedure	Message Sequence		TP	Verdict
		U - S	Message		
1	SS re-adjusts the cell-specific reference signal level of Cell 1 according to row "T1" in table 6.1.2.2a.3.2-1.	-	-	-	-
2	Wait for 1.1* modification period to allow the new system information to take effect.	-	-	-	-
3	The UE is switched on.	-	-	-	-
4	Check: Does the UE send an <i>RRCConectionRequest</i> on Cell 1 within the next 60 s?	-->	<i>RRCConectionRequest</i>	1	F
5	SS re-adjusts the cell-specific reference signal level of Cell 1 level according to row "T2" in table 6.1.2.2a.3.2-1.	-	-	-	-
6	Check: Does the UE send an <i>RRCConectionRequest</i> on Cell 1?	-->	<i>RRCConectionRequest</i>	2	P
7-21	Steps 3 to 17 of the registration procedure described in TS 36.508 subclause 4.5.2.3 are performed on Cell 1. NOTE: The UE performs registration and the RRC connection is released.	-	-	-	-

6.1.2.2a.3.3 Specific message contents

Table 6.1.2.2a.3.3-1: SystemInformationBlockType1 for Cell 1 (all steps)

Derivation Path: 36.508 clause 4.4.3.2			
Information Element	Value/Remark	Comment	Condition
SystemInformationBlockType1 ::= SEQUENCE {			
nonCriticalExtension SEQUENCE {			
lateNonCriticalExtension	Not present		
nonCriticalExtension SEQUENCE {			
ims-EmergencySupport-r9	Not present		
cellSelectionInfo-v920 SEQUENCE {			
q-QualMin-r9	-18 dB		
q-QualMinOffset-r9	Not present		
}			
}			
}			

6.1.2.3 Cell selection / Intra E-UTRAN / Serving cell becomes non-suitable (S<0 or barred)

6.1.2.3.1 Test Purpose (TP)

(1)

```

with { UE in E-UTRA RRC_IDLE state }
ensure that {
  when { the serving cell becomes non-suitable (S<0) and there is a suitable neighbour cell (S>0) }
  then { UE selects the suitable neighbour cell }
}

```

(2)

```

with { UE in E-UTRA RRC_IDLE state }
ensure that {
  when { the serving cell becomes barred and there is a suitable neighbour cell }
  then { UE selects the suitable neighbour cell }
}

```

6.1.2.3.2 Conformance requirements

References: The conformance requirements covered in the current TC are specified in: TS36.300, clause 10.1.1.1 and TS 36.304, clause 4.1, 5.2.1, 5.2.3.2, 5.2.4.6 and 5.3.1.

[TS 36.300, clause 10.1.1.1]

Cell selection:

- The UE NAS identifies a selected PLMN and equivalent PLMNs;
- The UE searches the E-UTRA frequency bands and for each carrier frequency identifies the strongest cell. It reads cell system information broadcast to identify its PLMN(s):
 - The UE may search each carrier in turn ("initial cell selection") or make use of stored information to shorten the search ("stored information cell selection").
- The UE seeks to identify a suitable cell; if it is not able to identify a suitable cell it seeks to identify an acceptable cell. When a suitable cell is found or if only an acceptable cell is found it camps on that cell and commence the cell reselection procedure:
- A suitable cell is one for which the measured cell attributes satisfy the cell selection criteria; the cell PLMN is the selected PLMN, registered or an equivalent PLMN; the cell is not barred or reserved and the cell is not part of a tracking area which is in the list of "forbidden tracking areas for roaming";

- An acceptable cell is one for which the measured cell attributes satisfy the cell selection criteria and the cell is not barred;

[TS 36.304, clause 4.1]

With the cell selection, the UE searches for a suitable cell of the selected PLMN and chooses that cell to provide available services, further the UE shall tune to its control channel. This choosing is known as "camping on the cell".

The UE will, if necessary, then register its presence, by means of a NAS registration procedure, in the tracking area of the chosen cell and as outcome of a successful Location Registration the selected PLMN becomes the registered PLMN [5].

If the UE finds a more suitable cell, according to the cell reselection criteria, it reselects onto that cell and camps on it. If the new cell does not belong to at least one tracking area to which the UE is registered, location registration is performed.

[TS 36.304, clause 5.2.1]

When camped on a cell, the UE shall regularly search for a better cell according to the cell reselection criteria. If a better cell is found, that cell is selected.

[TS 36.304, clause 5.2.3.2]

The cell selection criterion S is fulfilled when:

$$S_{rxlev} > 0$$

Where:

$$S_{rxlev} = Q_{rxlevmeas} - (Q_{rxlevmin} - Q_{rxlevminoffset}) - P_{compensation}$$

Where:

the signalled value $Q_{rxlevminOffset}$ is only applied when a cell is evaluated for cell selection as a result of a periodic search for a higher priority PLMN while camped normally in a VPLMN [5]. During this periodic search for higher priority PLMN the UE may check the S criteria of a cell using parameter values stored from a different cell of this higher priority PLMN.

S_{rxlev}	Cell Selection RX level value (dB)
$Q_{rxlevmeas}$	Measured cell RX level value (RSRP).
$Q_{rxlevmin}$	Minimum required RX level in the cell (dBm)
$Q_{rxlevminoffset}$	Offset to the signalled $Q_{rxlevmin}$ taken into account in the S_{rxlev} evaluation as a result of a periodic search for a higher priority PLMN while camped normally in a VPLMN [5]
$P_{compensation}$	$\max(P_{EMAX} - P_{UMAX}, 0)$ (dB)
P_{EMAX}	Maximum TX power level an UE may use when transmitting on the uplink in the cell (dBm) defined as P_{EMAX} in [TS 36.101]
P_{UMAX}	Maximum RF output power of the UE (dBm) according to the UE power class as defined in [TS 36.101]

[TS 36.304, clause 5.2.4.6]

In all cases, the UE shall reselect the new cell, only if the following conditions are met:

- the new cell is better ranked than the serving cell during a time interval $T_{reselection_{RAT}}$;
- more than 1 second has elapsed since the UE camped on the current serving cell.

[TS 36.304, clause 5.3.1]

Cell status and cell reservations are indicated in the *SystemInformationBlockType1* [3] by means of two Information Elements:

- cellBarred (IE type: "barred" or "not barred")
In case of multiple PLMNs indicated in SIB1 sharing, this IE is common for all PLMNs

...

When cell status is indicated as "not barred" and "not reserved" for operator use,

- All UEs shall treat this cell as candidate during the cell selection and cell re-selection procedures.

...

When cell status "barred" is indicated or to be treated as if the cell status is "barred",

- The UE is not permitted to select/re-select this cell, not even for emergency calls.
- The UE shall select another cell according to the following rule:
 - If the cell is a CSG cell:
 - the UE may select another cell on the same frequency if the selection/reselection criteria are fulfilled.
 - else
 - If the IE *intraFreqReselection* in IE *cellAccessRelatedInfo* in *SystemInformationBlockType1* is set to "allowed", the UE may select another cell on the same frequency if re-selection criteria are fulfilled.
 - The UE shall exclude the barred cell as a candidate for cell selection/reselection for 300 seconds.
 - If the IE *intraFreqReselection* in IE *cellAccessRelatedInfo* in *SystemInformationBlockType1* is set to "not allowed" the UE shall not re-select a cell on the same frequency as the barred cell.
 - The UE shall exclude the barred cell and the cells on the same frequency as a candidate for cell selection/reselection for 300 seconds.

6.1.2.3.3 Test description

6.1.2.3.3.1 Pre-test conditions

System Simulator:

- Cell 1 and Cell 2 have different tracking areas according to table 6.0.1-2.

UE:

None.

Preamble:

- UE is in state Registered, Idle Mode (state 2) on Cell 1(serving cell) according to [18].

6.1.2.3.3.2 Test procedure sequence

Table 6.1.2.3.3.2-1 illustrates the downlink power levels and other changing parameters to be applied for the cells at various time instants of the test execution. The exact instants on which these values shall be applied are described in the texts in this clause. Configurations marked "T1" and "T2" are applied at the points indicated in the Main behaviour description in Table 6.1.2.3.3.2-2.

Table 6.1.2.3.3.2-1: Time instances of cell power level and parameter changes

	Parameter	Unit	Cell 1	Cell 2	Remark
T1	Cell-specific RS EPRE	dBm/ 15kHz z	"Off"	-85	$Srxlev_{Cell\ 1} < 0$ (NOTE 1)
	Srxlev*	dB	-	25	Cell 2 becomes the strongest cell
T2	Cell-specific RS EPRE	dBm/ 15kHz z	-91	-85	$Srxlev_{Cell\ 2} > 0, Srxlev_{Cell\ 1} > 0, R_{Cell\ 1} < R_{Cell\ 2}$
	Srxlev*	dB	19	25	Cell 1 becomes suitable
	cellBarred	-	notBarred	barred	Serving cell becomes barred
NOTE 1: Power level "Off" is defined in TS36.508 Table 6.2.2.1-1.					

Table 6.1.2.3.3.2-2: Main behaviour

St	Procedure	Message Sequence		TP	Verdict
		U - S	Message		
1	SS re-adjusts the cell-specific reference signal level of Cell 1 and Cell 2 according to row "T1" in table 6.1.2.3.3.2-1.	-	-	-	-
2	Check: Does the test result of generic test procedure in TS 36.508 subclause 6.4.2.7 indicate that the UE is camped on E-UTRAN Cell 2? NOTE: The UE performs a TAU procedure and the RRC connection is released.	-	-	1	-
3	SS changes Cell 1 signal level and SIB1 IE <i>cellBarred</i> according to row "T2" in table 6.1.2.3.3.2-1 and transmits a <i>Paging</i> message including <i>systemInfoModification</i> . The <i>systemInfoValueTag</i> in the <i>SystemInformationBlockType1</i> is increased.	<--	<i>Paging</i>	-	-
4	Check: Does the test result of generic test procedure in TS 36.508 subclause 6.4.2.7 indicate that the UE is camped on E-UTRAN Cell 1? NOTE: The UE performs a TAU procedure and the RRC connection is released.	-	-	2	-

6.1.2.3.3.3 Specific message contents

Table 6.1.2.3.3.3-1: Void**Table 6.1.2.3.3.3-2: *SystemInformationBlockType1* for cells 1 and 2 (preamble and all steps, Table 6.1.2.3.3.2-2)**

Derivation Path: 36.508 clause 4.4.3.2			
Information Element	Value/remark	Comment	Condition
SystemInformationBlockType1 ::= SEQUENCE {			
cellSelectionInfo SEQUENCE {			
q-RxLevMin	-55 (-110 dBm)		
}			
systemInfoValueTag	The value is increased in step 3		
}			

Table 6.1.2.3.3.3-3: SystemInformationBlockType3 for cells 1 and 2 (Preamble and all steps, table 6.1.2.3.3.2-2)

Derivation Path: 36.508 clause 4.4.3.3, Table 4.4.3.3-2			
Information Element	Value/remark	Comment	Condition
SystemInformationBlockType3 ::= SEQUENCE {			
cellReselectionInfoCommon SEQUENCE {			
q-Hyst	dB0		
}			
intraFreqCellReselectionInfo SEQUENCE {			
q-RxLevMin	-55 (-110 dBm)		
t-ReselectionEUTRA	7		
}			
}			

Table 6.1.2.3.3.3-4: SystemInformationBlockType1 for cell 2 (step 3, Table 6.1.2.3.3.2-2)

Derivation Path: 36.508 clause 4.4.3.2			
Information Element	Value/remark	Comment	Condition
SystemInformationBlockType1 ::= SEQUENCE {			
cellAccessRelatedInfo SEQUENCE {			
cellBarred	barred		
intraFreqReselection	allowed		
}			
systemInfoValueTag	1	Previous value is 0	
}			

Table 6.1.2.3.3.3-5: Paging (step 3, Table 6.1.2.3.3.2-2)

Derivation path: 36.508 Table 4.6.1-7			
Information Element	Value/Remark	Comment	Condition
Paging ::= SEQUENCE {			
pagingRecordList	Not present		
systemInfoModification	True		
etws-PrimaryNotificationIndication	Not present		
nonCriticalExtension SEQUENCE {}	Not present		
}			

6.1.2.3a Cell selection / Intra E-UTRAN / Serving cell becomes non-suitable (Srxlev > 0 and Squal < 0)

6.1.2.3a.1 Test Purpose (TP)

(1)

```
with { UE in E-UTRA RRC_IDLE state }
ensure that {
  when { the serving cell becomes non-suitable (Srxlev > 0 and Squal < 0) and there is a suitable
neighbour cell (Srxlev > 0 and Squal > 0) }
  then { UE selects the suitable neighbour cell }
}
```

6.1.2.3a.2 Conformance requirements

References: The conformance requirements covered in the current TC are specified in: TS36.300, clause 10.1.1.1 and TS 36.304, clause 4.1, 5.2.1, 5.2.3.2 and 5.2.4.6.

[TS 36.300, clause 10.1.1.1]

Cell selection:

- The UE NAS identifies a selected PLMN and equivalent PLMNs;

- The UE searches the E-UTRA frequency bands and for each carrier frequency identifies the strongest cell. It reads cell system information broadcast to identify its PLMN(s):
 - The UE may search each carrier in turn (“initial cell selection”) or make use of stored information to shorten the search (“stored information cell selection”).
- The UE seeks to identify a suitable cell; if it is not able to identify a suitable cell it seeks to identify an acceptable cell. When a suitable cell is found or if only an acceptable cell is found it camps on that cell and commence the cell reselection procedure:
 - A suitable cell is one for which the measured cell attributes satisfy the cell selection criteria; the cell PLMN is the selected PLMN, registered or an equivalent PLMN; the cell is not barred or reserved and the cell is not part of a tracking area which is in the list of “forbidden tracking areas for roaming”;
 - An acceptable cell is one for which the measured cell attributes satisfy the cell selection criteria and the cell is not barred;

[TS 36.304, clause 4.1]

With the cell selection, the UE searches for a suitable cell of the selected PLMN and chooses that cell to provide available services, further the UE shall tune to its control channel. This choosing is known as "camping on the cell".

The UE shall, if necessary, then register its presence, by means of a NAS registration procedure, in the tracking area of the chosen cell and as outcome of a successful Location Registration the selected PLMN becomes the registered PLMN [5].

If the UE finds a more suitable cell, according to the cell reselection criteria, it reselects onto that cell and camps on it. If the new cell does not belong to at least one tracking area to which the UE is registered, location registration is performed.

[TS 36.304, clause 5.2.1]

When camped on a cell, the UE shall regularly search for a better cell according to the cell reselection criteria. If a better cell is found, that cell is selected. The change of cell may imply a change of RAT. Details on performance requirements for cell reselection can be found in [10].

[TS 36.304, clause 5.2.3.2]

The cell selection criterion S is fulfilled when:

$$S_{rxlev} > 0 \text{ AND } S_{qual} > 0$$

where:

$$S_{rxlev} = Q_{rxlevmeas} - (Q_{rxlevmin} + Q_{rxlevminoffset}) - P_{compensation}$$

$$S_{qual} = Q_{qualmeas} - (Q_{qualmin} + Q_{qualminoffset})$$

where:

Srxlev	Cell selection RX level value (dB)
Squal	Cell selection quality value (dB)
Qrxlevmeas	Measured cell RX level value (RSRP)
Qqualmeas	Measured cell quality value (RSRQ)
Qrxlevmin	Minimum required RX level in the cell (dBm)
Qqualmin	Minimum required quality level in the cell (dB)
Qrxlevminoffset	Offset to the signalled $Q_{rxlevmin}$ taken into account in the Srxlev evaluation as a result of a periodic search for a higher priority PLMN while camped normally in a VPLMN [5]
Qqualminoffset	Offset to the signalled $Q_{qualmin}$ taken into account in the Squal evaluation as a result of a periodic search for a higher priority PLMN while camped normally in a VPLMN [5]
Pcompensation	$\max(P_{EMAX} - P_{PowerClass}, 0)$ (dB)
P _{EMAX}	Maximum TX power level an UE may use when transmitting on the uplink in the cell (dBm) defined as P _{EMAX} in [TS 36.101]
P _{PowerClass}	Maximum RF output power of the UE (dBm) according to the UE power class as defined in [TS 36.101]

[TS 36.304, clause 5.2.4.6]

In all cases, the UE shall reselect the new cell, only if the following conditions are met:

- the new cell is better ranked than the serving cell during a time interval $T_{reselection_{RAT}}$;
- more than 1 second has elapsed since the UE camped on the current serving cell.

6.1.2.3a.3 Test description

6.1.2.3a.3.1 Pre-test conditions

System Simulator:

- Cell 1 and Cell 2 have different tracking areas according to table 6.0.1-2.

UE:

None.

Preamble:

- UE is in state Registered, Idle Mode (state 2) on Cell 1(serving cell) according to [18].

6.1.2.3a.3.2 Test procedure sequence

Table 6.1.2.3a.3.2-1 illustrates the downlink power levels and other changing parameters to be applied for the cells at various time instants of the test execution. The exact instants on which these values shall be applied are described in the texts in this clause. Configurations marked "T1" is applied at the points indicated in the Main behaviour description in Table 6.1.2.3a.3.2-2.

Table 6.1.2.3a.3.2-1: Time instances of cell power level and parameter changes

	Parameter	Unit	Cell 1	Cell 2	Remark
T1	Cell-specific RS EPRE	dBm/1 5kHz	-97	-85	$S_{rxlev_{Cell\ 1}} > 0$ and $S_{qual_{Cell\ 1}} < 0$
	RSRQ	dB	-15.28	-3.28	
	Qrxlevmin	dBm	-106	-92	
	Qrxlevminoffset	dB	0	0	
	Qqualmin	dB	-5	-20	
	Qqualminoffset	dB	0	0	
	Pcompensation	dB	0	0	
Srxlev*	dB	9	7	Cell 2 is suitable cell	
Squal*	dB	-10.28	16.72	$S_{qual} = Q_{qualmeas} - (Q_{qualmin} + Q_{qualminoffset})$	
	Noc	dBm/1 5kHz	Off	Off	

Table 6.1.2.3a.3.2-2: Main behaviour

St	Procedure	Message Sequence		TP	Verdict
		U - S	Message		
1	SS re-adjusts the cell-specific reference signal level of Cell 1 and Cell 2 according to row "T1" in table 6.1.2.3a.3.2-1.	-	-	-	-
2	Check: Does the test result of generic test procedure in TS 36.508 subclause 6.4.2.7 indicate that the UE is camped on E-UTRAN Cell 2? NOTE: The UE performs a TAU procedure and the RRC connection is released.	-	-	1	-

6.1.2.3a.3.3 Specific message contents

Table 6.1.2.3a.3.3-0: Conditions for table 6.1.2.3a.3.3-1, 6.1.2.3a.3.3-2

Condition descriptions
Cell 1 This condition applies to system information transmitted on Cell 1.
Cell 2 This condition applies to system information transmitted on Cell 2.

Table 6.1.2.3a.3.3-1: SystemInformationBlockType1 for Cell 1 and 2 (all steps, Table 6.1.2.3a.3.2-2)

Derivation Path: 36.508 clause 4.4.3.2, Table 4.4.3.2-3			
Information Element	Value/remark	Comment	Condition
SystemInformationBlockType1 ::= SEQUENCE {			
cellSelectionInfo SEQUENCE {			
q-RxLevMin	-53 (-106 dBm)		Cell 1
q-RxLevMin	-46 (-92 dBm)		Cell 2
}			
nonCriticalExtension SEQUENCE {			
lateNonCriticalExtension	Not present		
nonCriticalExtension SEQUENCE {			
ims-EmergencySupport-r9	Not present		
cellSelectionInfo-v920 SEQUENCE {			
q-QualMin-r9	-5 dB		Cell 1
q-QualMin-r9	-20 dB		Cell 2
q-QualMinOffset-r9	Not present		
}			
}			
}			
}			
}			

Table 6.1.2.3a.3.3-2: SystemInformationBlockType3 for Cell 1 and 2 (all steps, table 6.1.2.3a.3.2-2)

Derivation Path: 36.508 clause 4.4.3.3, Table 4.4.3.3-2			
Information Element	Value/remark	Comment	Condition
SystemInformationBlockType3 ::= SEQUENCE {			
cellReselectionInfoCommon SEQUENCE {			
q-Hyst	dB0		
}			
intraFreqCellReselectionInfo SEQUENCE {			
q-RxLevMin	-53 (-106 dBm)		Cell 1
q-RxLevMin	-46 (-92 dBm)		Cell 2
t-ReselectionEUTRA	7		
}			
lateNonCriticalExtension {			
s-IntraSearch-v920 SEQUENCE {}	Not present		
s-NonIntraSearch-v920 SEQUENCE {}	Not present		
q-QualMin-r9	-5 dB		Cell 1
q-QualMin-r9	-20 dB		Cell 2
threshServingLowQ-r9	Not present		
}			
}			

6.1.2.4 Cell reselection

6.1.2.4.1 Test Purpose (TP)

(1)

```
with { UE in E-UTRA RRC_IDLE state }
ensure that {
  when { UE detects the cell ranked as the best cell }
  then { UE reselects the new cell }
}
```

6.1.2.4.2 Conformance requirements

References: The conformance requirements covered in the present TC are specified in: TS 36.304, clause 5.2.4.2 and 5.2.4.6.

[TS 36.304, clause 5.2.4.2]

When evaluating for reselection purposes cell selection criterion or $S_{\text{nonServingCell},x}$, the UE shall use parameters provided by the serving cell.

Following rules are used by the UE to limit needed measurements:

- If $S_{\text{intraSearch}}$ is sent in the serving cell and $S_{\text{ServingCell}} > S_{\text{intraSearch}}$, UE may choose to not perform intra-frequency measurements.
- If $S_{\text{ServingCell}} \leq S_{\text{intraSearch}}$, or $S_{\text{intraSearch}}$ is not sent in the serving cell UE shall perform intra-frequency measurements.
- The UE shall apply the following rules for E-UTRAN inter-frequencies and inter-RAT frequencies which are indicated in system information and for which the UE has priority provided as defined in 5.2.4.1:
 - For an E-UTRAN inter-frequency or inter-RAT frequency with a reselection priority higher than the reselection priority of the current E-UTRA frequency the UE shall perform measurements of higher priority E-UTRAN inter-frequency inter-RAT frequencies according to [10].
 - For an E-UTRAN inter-frequency with an equal or lower reselection priority than the reselection priority of the current E-UTRA frequency and for inter-RAT frequency with lower reselection priority than the reselection priority of the current E-UTRAN frequency:
 - If $S_{\text{nonintraSearch}}$ is sent in the serving cell and $S_{\text{ServingCell}} > S_{\text{nonintraSearch}}$ UE may choose not to perform measurements of E-UTRAN inter-frequencies or inter-RAT frequency cells of equal or lower priority.

- If $S_{\text{ServingCell}} \leq S_{\text{nonintrasearch}}$ or $S_{\text{nonintrasearch}}$ is not sent in the serving cell the UE shall perform measurements of E-UTRAN inter-frequencies or inter-RAT frequency cells of equal or lower priority according to [10].

Where $S_{\text{ServingCell}}$ is the S_{rxlev} -value of the serving cell.

[TS 36.304, clause 5.2.4.6]

The cell-ranking criterion R_s for serving cell and R_n for neighbouring cells is defined by:

$$R_s = Q_{\text{meas},s} + Q_{\text{hyst}_s}$$

$$R_n = Q_{\text{meas},n} - Q_{\text{offset}}$$

where:

Q_{meas}	RSRP measurement quantity used in cell reselections.
Q_{offset}	For intra-frequency: Equals to $Q_{\text{offset}_{s,n}}$, if $Q_{\text{offset}_{s,n}}$ is valid, otherwise this equals to zero. For inter-frequency: Equals to $Q_{\text{offset}_{s,n}}$ plus $Q_{\text{offset}_{\text{frequency}}}$, if $Q_{\text{offset}_{s,n}}$ is valid, otherwise this equals to $Q_{\text{offset}_{\text{frequency}}}$.

The UE shall perform ranking of all cells that fulfil the cell selection criterion S , which is defined in 5.2.3.2, but may exclude all CSG cells that are known by the UE to be not allowed.

The cells shall be ranked according to the R criteria specified above, deriving $Q_{\text{meas},n}$ and $Q_{\text{meas},s}$ and calculating the R values using averaged RSRP results.

If a cell is ranked as the best cell the UE shall perform cell re-selection to that cell. If this cell is found to be not-suitable, the UE shall behave according to subclause 5.2.4.4.

In all cases, the UE shall reselect the new cell, only if the following conditions are met:

- the new cell is better ranked than the serving cell during a time interval $T_{\text{reselection}_{\text{RAT}}}$
- more than 1 second has elapsed since the UE camped on the current serving cell.

6.1.2.4.3 Test description

6.1.2.4.3.1 Pre-test conditions

System Simulator:

- Cell 1 and Cell 2.

UE:

None.

Preamble:

- The UE is in state Registered, Idle mode (state 2) on Cell 1(serving cell) according to [18].

6.1.2.4.3.2 Test procedure sequence

Table 6.1.2.4.3.2-1 illustrates the downlink power levels and other changing parameters to be applied for the cells at various time instants of the test execution. The configuration marked "T1" is applied at the point indicated in the Main behaviour description in Table 6.1.2.4.3.2-2.

Table 6.1.2.4.3.2-1: Time instances of cell power level and parameter changes

	Parameter	Unit	Cell 1	Cell 2	Remark
T1	Cell-specific RS EPRE	dBm/ 15kHz z	-85	-79	The power level values are assigned to satisfy $R_{Cell\ 1} < R_{Cell\ 2}$.

Table 6.1.2.4.3.2-2: Main behaviour

St	Procedure	Message Sequence		TP	Verdict
		U - S	Message		
1	The SS changes Cell 2 level according to the row "T1" in table 6.1.2.4.3.2-1.	-	-	-	-
2	Check: Does the test result of generic test procedure in TS 36.508 subclause 6.4.2.7 indicate that the UE is camped on E-UTRAN Cell 2?	-	-	1	-

6.1.2.4.3.3 Specific message contents

Table 6.1.2.4.3.3-1: Void

6.1.2.5 Cell reselection for interband operation

6.1.2.5.1 Test Purpose (TP)

(1)

```

with { UE in E-UTRA RRC_IDLE state }
ensure that {
  when { UE detects the cell re-selection criteria are met for the cell on the different frequency band }
  then { UE reselects the new cell }
}

```

6.1.2.5.2 Conformance requirements

References: The conformance requirements covered in the present TC are specified in: TS 36.304, clause 5.2.4.1, 5.2.4.2 and 5.2.4.5.

[TS 36.304, clause 5.2.4.1]

Absolute priorities of different E-UTRAN frequencies or inter-RAT frequencies may be provided to the UE in the system information, in the *RRCConnectionRelease* message, or by inheriting from another RAT at inter-RAT cell (re)selection. In the case of system information, an E-UTRAN frequency or inter-RAT frequency may be listed without providing a priority (i.e. the field *cellReselectionPriority* is absent for that frequency). If priorities are provided in dedicated signalling, the UE shall ignore all the priorities provided in system information. If UE is in *camped on any cell* state, UE shall only apply the priorities provided by system information from current cell, and the UE preserves priorities provided by dedicated signalling unless specified otherwise. When the UE in *camped normally* state, has only dedicated priorities other than for the current frequency, the UE shall consider the current frequency to be the lowest priority frequency (i.e. lower than the eight network configured values). While the UE is camped on a suitable CSG cell, the UE shall always consider the current frequency to be the highest priority frequency (i.e. higher than the eight network configured values), irrespective of any other priority value allocated to this frequency. The UE shall delete priorities provided by dedicated signalling when:

- the UE enters RRC_CONNECTED state; or
- the optional validity time of dedicated priorities (T320) expires; or
- a PLMN selection is performed on request by NAS [5].

NOTE: Equal priorities between RATs are not supported.

The UE shall only perform cell reselection evaluation for E-UTRAN frequencies and inter-RAT frequencies that are given in system information and for which the UE has a priority provided.

The UE shall not consider any black listed cells as candidate for cell reselection.

The UE shall inherit the priorities provided by dedicated signalling and the remaining validity time (i.e., T320 in E-UTRA, T322 in UTRA and T3230 in GERAN), if configured, at inter-RAT cell (re)selection.

NOTE: The network may assign dedicated cell reselection priorities for frequencies not configured by system information.

[TS 36.304, clause 5.2.4.2]

When evaluating for reselection purposes cell selection criterion or $S_{\text{nonServingCell},x}$, the UE shall use parameters provided by the serving cell.

Following rules are used by the UE to limit needed measurements:

- If $S_{\text{intrasearch}}$ is sent in the serving cell and $S_{\text{ServingCell}} > S_{\text{intrasearch}}$, UE may choose to not perform intra-frequency measurements.
- If $S_{\text{ServingCell}} \leq S_{\text{intrasearch}}$, or $S_{\text{intrasearch}}$ is not sent in the serving cell UE shall perform intra-frequency measurements.
- The UE shall apply the following rules for E-UTRAN inter-frequencies and inter-RAT frequencies which are indicated in system information and for which the UE has priority provided as defined in 5.2.4.1:
 - For an E-UTRAN inter-frequency or inter-RAT frequency with a reselection priority higher than the reselection priority of the current E-UTRA frequency the UE shall perform measurements of higher priority E-UTRAN inter-frequency or inter-RAT frequencies according to [10].
 - For an E-UTRAN inter-frequency with an equal or lower reselection priority than the reselection priority of the current E-UTRA frequency and for inter-RAT frequency with lower reselection priority than the reselection priority of the current E-UTRAN frequency:
 - If $S_{\text{nonintrasearch}}$ is sent in the serving cell and $S_{\text{ServingCell}} > S_{\text{nonintrasearch}}$ UE may choose not to perform measurements of E-UTRAN inter-frequencies or inter-RAT frequency cells of equal or lower priority.
 - If $S_{\text{ServingCell}} \leq S_{\text{nonintrasearch}}$ or $S_{\text{nonintrasearch}}$ is not sent in the serving cell the UE shall perform measurements of E-UTRAN inter-frequencies or inter-RAT frequency cells of equal or lower priority according to [10].

Where $S_{\text{ServingCell}}$ is the S_{rxlev} -value of the serving cell.

[TS 36.304, clause 5.2.4.5]

Criteria 1: the $S_{\text{nonServingCell},x}$ of a cell on evaluated frequency is greater than $\text{Thresh}_{x, \text{high}}$ during a time interval $\text{T}_{\text{reselection}_{\text{RAT}}}$;

Cell reselection to a cell on a higher priority E-UTRAN frequency or inter-RAT frequency than serving frequency shall be performed if:

- A cell of a higher priority E-UTRAN frequency or inter-RAT frequency fulfils criteria 1; and
- more than 1 second has elapsed since the UE camped on the current serving cell.

Cell reselection to a cell on an equal priority E-UTRAN frequency shall be based on ranking for Intra-frequency cell reselection as defined in sub-clause 5.2.4.6.

Cell reselection to a cell on a lower priority E-UTRAN frequency or inter-RAT frequency than serving frequency shall be performed if:

- No cell on a higher priority E-UTRAN frequency or inter-RAT frequency than serving frequency fulfils the criteria 1; and
- No cell on serving frequency or on an equal priority E-UTRAN frequency fulfils the criteria in 5.2.4.6; and
- $S_{\text{ServingCell}} < \text{Thresh}_{\text{Serving}, \text{low}}$ and the $S_{\text{nonServingCell},x}$ of a cell of a lower priority E-UTRAN frequency or inter-RAT frequency is greater than $\text{Thresh}_{x, \text{low}}$ during a time interval $\text{T}_{\text{reselection}_{\text{RAT}}}$; and

- more than 1 second has elapsed since the UE camped on the current serving cell.

For GERAN, UTRAN, and E-UTRAN, $S_{\text{nonServingCell},x}$ is the S_{rxlev} -value of an evaluated cell. For UTRAN FDD, S_{qual} is higher than 0, as defined in [8]. For cdma2000 RATs, $S_{\text{nonServingCell},x}$ is equal to $\text{FLOOR}(-2 \times 10 \times \log_{10} E_c/I_o)$ in units of 0.5 dB, as defined in [18], with E_c/I_o referring to the value measured from the evaluated cell.

For cdma2000 RATs, $\text{Thresh}_{x, \text{high}}$ and $\text{Thresh}_{x, \text{low}}$ are equal to -1 times the values signalled for the corresponding parameters in the system information.

In all the above criteria the value of $T_{\text{reselection}_{\text{RAT}}}$ is scaled when the UE is in the medium or high mobility state as defined in subclause 5.2.4.3.1. If more than one cell meets the above criteria, the UE shall reselect a cell ranked as the best cell among the cells meeting the criteria on the highest priority frequencies or the highest priority RAT if the highest priority RAT is E-UTRA according to criteria defined in 5.2.4.6.

6.1.2.5.3 Test description

6.1.2.5.3.1 Pre-test conditions

System Simulator:

- Cell 1, cell 10.
- System information combination 3 as defined in TS 36.508 [18] clause 4.4.3.1 is used in E-UTRA cells.

UE:

None.

Preamble:

- The UE is in state Registered, Idle mode (state 2) on Cell 1 (serving cell) according to [18].

6.1.2.5.3.2 Test procedure sequence

Table 6.1.2.5.3.2-1 illustrates the downlink power levels and other changing parameters to be applied for the cells at various time instants of the test execution. The configuration marked "T1" is applied at the point indicated in the Main behaviour description in Table 6.1.2.5.3.2-2.

Table 6.1.2.5.3.2-1: Time instances of cell power level and parameter changes

	Parameter	Unit	Cell 1	Cell 10	Remark
T1	Cell-specific RS EPRE	dBm/15kHz	-85	-73	Cell 10 become stronger than $\text{Thresh}_{x, \text{high}}$.

Table 6.1.2.5.3.2-2: Main behaviour

St	Procedure	Message Sequence		TP	Verdict
		U - S	Message		
1	The SS changes Cell 10 power level according to the row "T1" in table 6.1.2.5.3.2-1.	-	-	-	-
2	Check: Does the test result of generic test procedure in TS 36.508 subclause 6.4.2.7 indicate that the UE is camped on E-UTRAN Cell 10?	-	-	1	-

6.1.2.5.3.3 Specific message contents

Table 6.1.2.5.3.3-0: Conditions for specific message contents in Tables 6.1.2.5.3.3-1 and 6.1.2.5.3.3-2

Condition	Explanation
Cell 1	This condition applies to system information transmitted on Cell 1.
Cell 10	This condition applies to system information transmitted on Cell 10.

Table 6.1.2.5.3.3-1: SystemInformationBlockType3 for Cell 1 and Cell 10 (preamble and all steps, Table 6.1.2.5.3.2-2)

Derivation path: 36.508 table 4.4.3.3-2			
Information Element	Value/Remark	Comment	Condition
SystemInformationBlockType3 ::= SEQUENCE {			
cellReselectionServingFreqInfo SEQUENCE {			
cellReselectionPriority	1		Cell 1
	5		Cell 10
}			
}			

Table 6.1.2.5.3.3-2: SystemInformationBlockType5 for Cell 1 and Cell 10 (preamble and all steps, Table 6.1.2.5.3.2-2)

Derivation path: 36.508 table 4.4.3.3-4			
Information Element	Value/Remark	Comment	Condition
SystemInformationBlockType5 ::= SEQUENCE {			
interFreqCarrierFreqList SEQUENCE (SIZE (1..maxFreq)) OF SEQUENCE {			
dl-CarrierFreq	Same downlink EARFCN as used for Cell 10		Cell 1
	Same downlink EARFCN as used for Cell 1		Cell 10
t-ReselectionEUTRA	7		
threshX-High	10	20dB	
cellReselectionPriority	5		Cell 1
	1		Cell 10
}			
}			

6.1.2.6 Cell reselection using Q_{hyst} , Q_{offset} and $T_{\text{reselection}}$

6.1.2.6.1 Test Purpose (TP)

(1)

```
with { UE in E-UTRA RRC_IDLE state, and the UE is not in high mobility state }
ensure that {
  when {  $Q_{\text{hyst}}$  is non-zero or its value changes in system information }
  then { UE reselects the highest ranked cell taking the actual  $Q_{\text{hyst}}$  value into account }
}
```

(2)

```
with { UE in E-UTRA RRC_IDLE state, and the UE is not in high mobility state }
ensure that {
  when { cell reselection criteria are fulfilled during a time interval  $T_{\text{reselection}}$  }
  then { UE reselects the highest ranked cell }
}
```

(3)

```
with { UE in E-UTRA RRC_IDLE state, and the UE is not in high mobility state }
ensure that {
  when {  $Q_{\text{offset}}$  is non-zero or its value changes in system information }
  then { UE reselects the highest ranked cell taking the actual  $Q_{\text{offset}}$  value into account }
}
```

6.1.2.6.2 Conformance requirements

References: The conformance requirements covered in the current TC are specified in: TS36.300, clause 10.1.1.2 and TS 36.304, clauses 5.2.1 and 5.2.4.6 and TS 36.331 clause 6.3.1.

[TS 36.300, clause 10.1.1.2]

UE in RRC_IDLE performs cell reselection. The principles of the procedure are the following:

- The UE makes measurements of attributes of the serving and neighbour cells to enable the reselection process:
 - There is no need to indicate neighbouring cell in the serving cell system information to enable the UE to search and measure a cell i.e. E-UTRAN relies on the UE to detect the neighbouring cells;
 - For the search and measurement of inter-frequency neighbouring cells, only the carrier frequencies need to be indicated;
 - Measurements may be omitted if the serving cell attribute fulfils particular search or measurement criteria.
- Cell reselection identifies the cell that the UE should camp on. It is based on cell reselection criteria which involves measurements of the serving and neighbour cells:
 - Intra-frequency reselection is based on ranking of cells;
- ...
- Cell reselection parameters are applicable for all UEs in a cell, ...

[TS 36.304, clause 5.2.1]

When camped on a cell, the UE shall regularly search for a better cell according to the cell reselection criteria. If a better cell is found, that cell is selected.

[TS 36.304, clause 5.2.4.6]

The cell-ranking criterion R_s for serving cell and R_n for neighbouring cells is defined by:

$R_s = Q_{meas,s} + Q_{Hyst}$ $R_n = Q_{meas,n} - Q_{offset}$

where:

Q_{meas}	RSRP measurement quantity used in cell reselections.
Qoffset	For intra-frequency: Equals to $Q_{offset_{s,n}}$, if $Q_{offset_{s,n}}$ is valid, otherwise this equals to zero. For inter-frequency: Equals to $Q_{offset_{s,n}}$ plus $Q_{offset_{frequency}}$, if $Q_{offset_{s,n}}$ is valid, otherwise this equals to $Q_{offset_{frequency}}$.

The UE shall perform ranking of all cells that fulfil the cell selection criterion S, which is defined in 5.2.3.2, but may exclude all CSG cells that are known by the UE to be not allowed.

The cells shall be ranked according to the R criteria specified above, deriving $Q_{meas,n}$ and $Q_{meas,s}$ and calculating the R values using averaged RSRP results.

If a cell is ranked as the best cell the UE shall perform cell re-selection to that cell.

...

In all cases, the UE shall reselect the new cell, only if the following conditions are met:

- the new cell is better ranked than the serving cell during a time interval $T_{reselection_{RAT}}$,
- more than 1 second has elapsed since the UE camped on the current serving cell.

[TS 36.331, clause 6.3.1]

The IE *SystemInformationBlockType4* contains neighbouring cell related information relevant only for intra-frequency cell re-selection. The IE includes cells with specific re-selection parameters as well as blacklisted cells.

6.1.2.6.3 Test description

6.1.2.6.3.1 Pre-test conditions

System Simulator:

- Cell 1 and Cell 2 have different tracking areas according to table 6.0.1-2.
- System information combination 2 as defined in TS 36.508 [18] clause 4.4.3.1 is used in E-UTRA cells.

UE:

None.

Preamble:

- The UE is in state Registered, Idle mode (state 2) on Cell 1 according to [18].

6.1.2.6.3.2 Test procedure sequence

Table 6.1.2.6.3.2-1 illustrates the downlink power levels and other changing parameters to be applied for the cells at various time instants of the test execution. The exact instants on which these values shall be applied are described in the texts in this clause. Configurations marked "T1", "T2", "T3", "T4", "T5", "T6" and "T7" are applied at the points indicated in the Main behaviour description in Table 6.1.2.6.3.2-2.

Table 6.1.2.6.3.2-1: Time instances of cell power level and parameter change

Ti	Parameter	Unit	Cell 1	Cell 2	Remark
T1	Cell-specific RS EPRE	dBm/ 15kHz z	-91	-85	Cell 2 becomes stronger than Cell 1 but Cell 1 remains the highest ranked one due to $Q_{\text{hyst}_{\text{sCell1}}}$
T2	$Q_{\text{hyst}_{\text{s}}}$	dB	0	0	$Q_{\text{hyst}_{\text{sCell1}}}$ change causes Cell 2 to become highest ranked cell
T3	Cell-specific RS EPRE	dBm/ 15kHz z	-85	-91	Cell 1 becomes the strongest and highest ranked one due to
	$Q_{\text{offset}_{\text{s,n}}}$	dB	24	0	$Q_{\text{offset}_{\text{s,nCell2}}}$ remains zero
T4	Cell-specific RS EPRE	dBm/ 15kHz z	-91	-85	Cell 1 becomes weaker but it remains the highest ranked one due to $Q_{\text{offset}_{\text{s,nCell1}}}$
T5	$Q_{\text{offset}_{\text{s,n}}}$	dB	0	0	Cell 2 becomes the highest ranked one due to $Q_{\text{offset}_{\text{s,nCell1}}}$ change
T6	Cell-specific RS EPRE	dBm/ 15kHz z	-85	-91	Cell 1 becomes the highest ranked one
	TreselectionEUTRAN	s	7	0	
T7	Cell-specific RS EPRE	dBm/ 15kHz z	-91	-85	Cell 2 becomes the highest ranked cell
Note:	The total test tolerance used is the sum of downlink signal level uncertainty (TS 36.508 clause 6.2.2.1) and relative UE measurement accuracy of RSRP (TS 36.133 clause 9.1.2.2).				

Table 6.1.2.6.3.2-2: Main behaviour

St	Procedure	Message Sequence		TP	Verdict
		U - S	Message		
0	Wait for 1 second to allow UE to enter RRC_IDLE state on cell 1.	-	-	-	-
1	SS re-adjusts the cell-specific reference signal levels according to row "T1" in table 6.1.2.6.3.2-1.	-	-	-	-
2	Check: Does the UE send an <i>RRCConectionRequest</i> on Cell 2 within the next 10s?	-->	<i>RRCConectionRequest</i>	1	F
3	SS resets $Q_{hyst_{s,Cell1}}$ according to row "T2" in table 6.1.2.6.3.2-1 and notifies UE of the system information change. The <i>systemInfoValueTag</i> in the <i>SystemInformationBlockType1</i> is increased.	<--	<i>Paging</i>	-	-
4	Check: Does the test result of generic test procedure in TS 36.508 subclause 6.4.2.7 indicate that the UE is camped on E-UTRAN Cell 2? (Note 1) NOTE: The UE performs a TAU procedure and the RRC connection is released.	-	-	1	-
5	Void	-	-	-	-
5A	SS changes $Q_{offset_{s,nCell1}}$ according to rows "T3" in table 6.1.2.6.3.2-1 and sends notification of the system information change. The <i>systemInfoValueTag</i> in the <i>SystemInformationBlockType1</i> is increased.	<--	<i>Paging</i>	-	-
5B	Wait for 2.1* modification period (Note 2) to allow the new system information to take effect.	-	-	-	-
5C	SS re-adjusts cell-specific reference signal levels according to rows "T3" in table 6.1.2.6.3.2-1.	-	-	-	-
6	Wait until there is any <i>RRCConectionRequest</i> send from the UE on Cell 1.	-->	<i>RRCConectionRequest</i>	-	-
7-11	Steps 2 to 6 of the generic test procedure in TS 36.508 subclause 6.4.2.7 are performed on Cell 1. NOTE: The UE performs a TAU procedure and the RRC connection is released.	-	-	-	-
11A	Wait for 1 second to allow UE to enter RRC_IDLE state on cell 1.	-	-	-	-
12	SS re-adjusts cell-specific reference signal levels according to row "T4" in table 6.1.2.6.3.2-1.	-	-	-	-
13	Check: Does the UE send an <i>RRCConectionRequest</i> on Cell 2 within the next 10s?	-->	<i>RRCConectionRequest</i>	3	F
14	SS resets $Q_{offset_{s,nCell1}}$ according to row "T5" in table 6.1.2.6.3.2-1 and notifies UE of the system information change. The <i>systemInfoValueTag</i> in the <i>SystemInformationBlockType1</i> is increased.	<--	<i>Paging</i>	-	-
15	Check: Does the test result of generic test procedure in TS 36.508 subclause 6.4.2.7 indicate that the UE is camped on E-UTRAN Cell 2? (Note 1) NOTE: The UE performs a TAU procedure and the RRC connection is released.	-	-	3	-
16	Void	-	-	-	-
16A	SS changes $T_{reselectionEUTRAN_{Cell1}}$ according to rows "T6" in table 6.1.2.6.3.2-1 and sends notification of the system information change. The <i>systemInfoValueTag</i> in the <i>SystemInformationBlockType1</i> is increased.	<--	<i>Paging</i>	-	-

16 B	Wait for 2.1* modification period (Note 2) to allow the new system information to take effect.	-	-	-	-
16 C	SS re-adjusts cell-specific reference signal levels according to rows "T6" in table 6.1.2.6.3.2-1.	-	-	-	-
17	Wait until there is any <i>RRCCONNECTIONREQUEST</i> send from the UE on Cell 1	-->	<i>RRCCONNECTIONREQUEST</i>	-	-
18-22	Steps 2 to 6 of the generic test procedure in TS 36.508 subclause 6.4.2.7 are performed on Cell 1. NOTE: The UE performs a TAU procedure and the RRC connection is released.	-	-	-	-
22 A	Wait for 1 second to allow UE to enter RRC_IDLE state on cell 1.	-	-	-	-
23	SS re-adjusts cell-specific reference signal levels according to rows "T7" in table 6.1.2.6.3.2-1.	-	-	-	-
24	Check: Does the UE send an <i>RRCCONNECTIONREQUEST</i> on Cell 2 within the next 6s?	-->	<i>RRCCONNECTIONREQUEST</i>	2	F
25	Check: Does the UE send an <i>RRCCONNECTIONREQUEST</i> on Cell 2 within the next 12s?	-->	<i>RRCCONNECTIONREQUEST</i>	2	P
26-29	Steps 2 to 5 of the generic test procedure in TS 36.508 subclause 6.4.2.7 are performed on Cell 2. NOTE: The UE performs a TAU procedure.	-	-	-	-

NOTE 1: The time interval in step 4 and 15 is set to cover TevaluateFDD,intra (TS 36.133 clause 4.2.2.3) + 1280 ms for DRX cycle + 1280 ms for system information block type scheduling. The timer tolerances are taken into account according to [18].

NOTE 2: The wait time of 2.1* modification period in step 5B and 16B is to allow for the network to paging the system information change during the next modification period, and update the system information at the subsequent modification period. UE should acquire the updated system information within 100ms of the start of modification period.

6.1.2.6.3.3 Specific message contents

Table 6.1.2.6.3.3-1: Void

Table 6.1.2.6.3.3-2: *SystemInformationBlockType1* for cells 1 (preamble and all steps, Table 6.1.2.6.3.2-2)

Derivation Path: 36.508 table 4.4.3.2-3		
Information Element	Value/remark	Comment
<i>SystemInformationBlockType1</i> ::= SEQUENCE { <i>schedulingInformation</i> ::= SEQUENCE (SIZE (1..maxSI-Message)) OF SEQUENCE { <i>systemInfoValueTag</i>	The value is increased by 1 in step 3, step 5A, step 14 and step 16A	
}		

Table 6.1.2.6.3.3-3: *SystemInformationBlockType3* for cell 1 (preamble, table 6.1.2.6.3.2-2)

Derivation Path: 36.508 table 4.4.3.3-2		
Information Element	Value/remark	Comment
<i>SystemInformationBlockType3</i> ::= SEQUENCE { <i>cellReselectionInfoCommon</i> SEQUENCE { q-Hyst	dB24	Qhyst _{sCell1}
}		
}		

Table 6.1.2.6.3.3-4: SystemInformationBlockType3 for cell 1 (step 3, table 6.1.2.6.3.2-2)

Derivation Path: 36.508 table 4.4.3.3-2		
Information Element	Value/remark	Comment
SystemInformationBlockType3 ::= SEQUENCE {		
cellReselectionInfoCommon SEQUENCE {		
q-Hyst	dB0	Qhyst _{sCell1}
}		
}		

Table 6.1.2.6.3.3-5: SystemInformationBlockType3 for cell 1 (step 16A, table 6.1.2.6.3.2-2)

Derivation Path: 36.508 table 4.4.3.3-2		
Information Element	Value/remark	Comment
SystemInformationBlockType3 ::= SEQUENCE {		
cellReselectionInfoCommon SEQUENCE {		
q-Hyst	dB0	Qhyst _{sCell1}
}		
intraFreqCellReselectionInfo SEQUENCE {		
t-ReselectionEUTRA	7	seconds
}		
}		

Table 6.1.2.6.3.3-6: SystemInformationBlockType4 for cell 1 (step 5A, table 6.1.2.6.3.2-2)

Derivation Path: 36.508 table 4.4.3.3-3		
Information Element	Value/remark	Comment
SystemInformationBlockType4 ::= SEQUENCE {		
intraFreqNeighCellList SEQUENCE (SIZE (1..maxCellIntra)) OF SEQUENCE {		
physCellId [1]	Physical cell identity of Cell 2	
q-OffsetCell [1]	dB24	Qoffset _{s,nCell 1}
}		
}		

Table 6.1.2.6.3.3-7: SystemInformationBlockType4 for cell 1 (step 14, table 6.1.2.6.3.2-2)

Derivation Path: 36.508 table 4.4.3.3-3		
Information Element	Value/remark	Comment
SystemInformationBlockType4 ::= SEQUENCE {		
intraFreqNeighCellList SEQUENCE (SIZE (1..maxCellIntra)) OF SEQUENCE {		
physCellId [1]	Physical cell identity of Cell 2	
q-OffsetCell [1]	dB0	Qoffset _{s,nCell 1}
}		
}		

6.1.2.7 Cell reselection / Equivalent PLMN

6.1.2.7.1 Test Purpose (TP)

(1)

```

with { UE camped normally on a cell and network has downloaded a list of equivalent PLMNs during the
Location Registration procedure }
ensure that {
  when { a suitable neighbour cell on an equivalent PLMN becomes better ranked than the suitable
Serving cell }
  then { UE reselects to this equivalent PLMN cell. }
}

```

(2)

```

with { UE camped normally on a cell and network has downloaded a list of equivalent PLMNs during the
Location Registration procedure }
ensure that {
  when { the Serving cell becomes unsuitable due to S<0 and a suitable cell exists on an equivalent
PLMN }
  then { UE reselects to this equivalent PLMN cell. }
}

```

(3)

```

with { UE camped normally on a cell and network has downloaded a list of equivalent PLMNs during the
Location Registration procedure }
ensure that {
  when { the UE evaluates cells for reselection }
  then { UE ignores suitable cells for which the UE has no reselection priority provided. }
}

```

6.1.2.7.2 Conformance requirements

References: The conformance requirements covered in the present TC are specified in: TS 36.304 clause 5.2.4.1, TS 23.122 clause 4.4.3.

[TS 36.304, clause 5.2.4.1]

UE shall only perform reselection evaluation for E-UTRAN frequencies and inter-RAT frequencies that are given in system information and for which the UE has a priority provided.

[TS 23.122, clause 4.4.3]

The Mobile Equipment stores a list of "equivalent PLMNs". This list is replaced or deleted at the end of each location update procedure, routing area update procedure and GPRS attach procedure. The stored list consists of a list of equivalent PLMNs as downloaded by the network plus the PLMN code of the registered PLMN that downloaded the list. All PLMNs in the stored list, in all access technologies supported by the PLMN, are regarded as equivalent to each other for PLMN selection, cell selection/re-selection and handover.

6.1.2.7.3 Test description

6.1.2.7.3.1 Pre-test conditions

System Simulator:

- Three inter-frequency multi-PLMN cells as specified in TS36.508 clause 4.4.1.2 are configured broadcasting default NAS parameters as indicated in TS 36.508 Table 4.4.2-2.
- The PLMNs are identified in the test by the identifiers in Table 6.1.2.7.3.1-1.

Table 6.1.2.7.3.1-1: PLMN identifiers

Cell	PLMN name
1	PLMN1
12	PLMN2
13	PLMN3

- All cells are high quality.
- All cells are suitable cells.
- System information combination 3 as defined in TS 36.508 [18] clause 4.4.3.1 is used in E-UTRA cells.

UE:

- The UE is in Automatic PLMN selection mode.
- The UE is equipped with a USIM containing default values (as per TS 36.508) except for those listed in Table 6.1.2.7.3.1-2.

Table 6.1.2.7.3.1-2: USIM configuration

USIM field	Priority	Value	Access Technology Identifier
EF _{LocI}		PLMN1 (See pre-amble)	

Preamble:

- The UE is registered on PLMN1 (Cell 1) using the procedure described in TS 36.508 clause 4.5.2.3 except that the ATTACH ACCEPT message indicates PLMN3 in the Equivalent PLMN list as described in Table 6.1.2.7.3.3-1.
- The UE is in state Registered, Idle Mode (State 2) on Cell 1 according to [18].

6.1.2.7.3.2 Test procedure sequence

Table 6.1.2.7.3.2-1 shows the cell configurations used during the test. The configuration T0 indicates the initial conditions. Subsequent configurations marked "T1" and "T2" are applied at the points indicated in the Main behaviour description in Table 6.1.2.7.3.2-2.

Table 6.1.2.7.3.2-1: Cell configuration changes over time

	Parameter	Unit	Cell 1	Cell 12	Cell 13	Remarks
T0	RS EPRE	dBm/15kHz	-67	-82	-97	All cells S>0
T1	RS EPRE	dBm/15kHz	-115	-82	-97	Cell 1 S < 0 as described in TS 36.508 clause 6.2.2.1
T2	RS EPRE	dBm/15kHz	-67	-97	-82	All cells S>0

Note 1: The default values (including "not present") for all other parameters influencing cell reselection are suitable for this test. The values are defined in TS 36.508 clauses 4.4.3.2 and 4.4.3.3.

Table 6.1.2.7.3.2-2: Main behaviour

St	Procedure	Message Sequence		TP	Verdict
		U - S	Message		
1	Check: Does the UE send an <i>RRConnectionRequest</i> within the next 100 seconds?	-->	<i>RRConnectionRequest</i>	1	F
2	SS adjusts cell levels according to row T1 of table 6.1.2.7.3.2-1.	-	-	-	-
3	Check: Does the test result of generic test procedure in TS 36.508 subclause 6.4.2.7 indicate that the UE is camped on E-UTRAN Cell 13? NOTE: The UE performs a TAU procedure with PLMN1 and PLMN2 listed as an Equivalent PLMN in the TRACKING AREA UPDATE ACCEPT message, and the RRC connection is released.	-	-	2	P
4	Void	-	-	-	-
5	Check: Does the test result of generic test procedure in TS 36.508 subclause 6.4.2.7 indicate that the UE is camped on E-UTRAN Cell 12? NOTE: The UE performs a TAU procedure with PLMN1 and PLMN3 listed as an Equivalent PLMN in the TRACKING AREA UPDATE ACCEPT message, and the RRC connection is released.	-	-	1	P
6	Void	-	-	-	-
7	SS adjusts cell levels according to row T0 of table 6.1.2.7.3.2-1.	-	-	-	-
8	Check: Does the UE send an <i>RRConnectionRequest</i> within the next 100 seconds?	-->	<i>RRConnectionRequest</i>	1,3	F
9	SS adjusts cell levels according to row T2 of table 6.1.2.7.3.2-1.	-	-	-	-
10	Void	-	-	-	-
11	Check: Does the test result of generic test procedure in TS 36.508 subclause 6.4.2.7 indicate that the UE is camped on E-UTRAN Cell 13? NOTE: The UE performs a TAU procedure with PLMN1 and PLMN2 listed as an Equivalent PLMN in the TRACKING AREA UPDATE ACCEPT message, and the RRC connection is released.	-	-	3	P
<p>Note 1: In Steps 1 and 8, a wait time long enough to ensure that the UE has detected, measured and evaluated the neighbour inter-frequency cells is provided, see 36.133 clause 4.2.2.4.</p> <p>Note 2: In Step 11, the UE moves to Cell 13 because no reselection priority is defined for Cell 1, see Table 6.1.2.7.3.3-6.</p>					

6.1.2.7.3.3 Specific message contents

Table 6.1.2.7.3.3-1: ATTACH ACCEPT for Cell 1 (preamble)

Derivation path: 36.508 Table 4.7.2-1			
Information Element	Value/Remark	Comment	Condition
Equivalent PLMNs	PLMN3		

Table 6.1.2.7.3.3-2: TRACKING AREA UPDATE ACCEPT for Cell 13 (steps 3 & 11 , Table 6.1.2.7.3.2-2)

Derivation path: 36.508 Table 4.7.2-24			
Information Element	Value/Remark	Comment	Condition
Equivalent PLMNs	PLMN1, 2		

Table 6.1.2.7.3.3-3: TRACKING AREA UPDATE ACCEPT for Cell 12 (step 5, Table 6.1.2.7.3.2-2)

Derivation path: 36.508 Table 4.7.2-24			
Information Element	Value/Remark	Comment	Condition
Equivalent PLMNs	PLMN1, 3		

Table 6.1.2.7.3.3-4: Void**Table 6.1.2.7.3.3-5: Void****Table 6.1.2.7.3.3-6: SystemInformationBlockType5 for Cell 12 (preamble and all steps, Table 6.1.2.7.3.2-2)**

Derivation path: 36.508 Table 4.4.3.3-4			
Information Element	Value/Remark	Comment	Condition
SystemInformationBlockType5 ::= SEQUENCE {			
interFreqCarrierFreqList SEQUENCE (SIZE (1..maxFreq)) OF SEQUENCE {	2 entries		
dl-CarrierFreq[1]	Same downlink EARFCN as used for Cell 1		
cellReselectionPriority[1]	Not present	UE does not have a priority for frequency of Cell 1	
dl-CarrierFreq[2]	Same downlink EARFCN as used for Cell 13		
}			
}			

Table 6.1.2.7.3.3-7: SystemInformationBlockType5 for Cell 13 (preamble and all steps, Table 6.1.2.7.3.2-2)

Derivation path: 36.508 Table 4.4.3.3-4			
Information Element	Value/Remark	Comment	Condition
SystemInformationBlockType5 ::= SEQUENCE {			
interFreqCarrierFreqList SEQUENCE (SIZE (1..maxFreq)) OF SEQUENCE {	2 entries		
dl-CarrierFreq[1]	Same downlink EARFCN as used for Cell 1		
cellReselectionPriority[1]	Not present	UE does not have a priority for frequency of Cell 1	
dl-CarrierFreq[2]	Same downlink EARFCN as used for Cell 12		
}			
}			

6.1.2.7a Cell reselection / Equivalent PLMN / Single Frequency operation

6.1.2.7a.1 Test Purpose (TP)

(1)

```

with { UE camped normally on a cell and network has downloaded a list of equivalent PLMNs during the
Location Registration procedure }
ensure that {
  when { a suitable neighbour cell on an equivalent PLMN becomes better ranked than the suitable
Serving cell }
  then { UE reselects to this equivalent PLMN cell. }
}

```

(2)

```

with { UE camped normally on a cell and network has downloaded a list of equivalent PLMNs during the
Location Registration procedure }
ensure that {
  when { the Serving cell becomes unsuitable due to S<0 and a suitable cell exists on an equivalent
PLMN }
  then { UE reselects to this equivalent PLMN cell. }
}

```

6.1.2.7a.2 Conformance requirements

Same Conformance requirements as in clause 6.1.2.7.2

6.1.2.7a.3 Test description

6.1.2.7a.3.1 Pre-test conditions

System Simulator:

- Three intra-frequency multi-PLMN cells.
- The PLMNs are identified in the test by the identifiers in Table 6.1.2.7a.3.1-1.

Table 6.1.2.7a.3.1-1: PLMN identifiers

Cell	PLMN name
1	PLMN1
2	PLMN2
4	PLMN3

- All cells are high quality.
- All cells are suitable cells.

UE:

- The UE is in Automatic PLMN selection mode.
- The UE is equipped with a USIM containing default values (as per TS 36.508) except for those listed in Table 6.1.2.7a.3.1-2.

Table 6.1.2.7a.3.1-2: USIM configuration

USIM field	Priority	Value	Access Technology Identifier
EF _{LOCI}		PLMN1 (See pre-amble)	

Preamble:

- The UE is registered on PLMN1 (Cell 1) using the procedure described in TS 36.508 clause 4.5.2.3 except that the ATTACH ACCEPT message indicates PLMN3 in the Equivalent PLMN list as described in Table 6.1.2.7a.3.3-1.
- The UE is in state Registered, Idle Mode (State 2) on Cell 1 according to [18].

6.1.2.7a.3.2 Test procedure sequence

Table 6.1.2.7a.3.2-1 shows the cell configurations used during the test. The configuration T0 indicates the initial conditions. Subsequent configurations marked “T1” and “T2” are applied at the points indicated in the Main behaviour description in Table 6.1.2.7a.3.2-2.

Table 6.1.2.7a.3.2-1: Cell configuration changes over time

	Parameter	Unit	Cell 1	Cell 2	Cell 4	Remarks
T0	RS EPRE	dBm/15kHz	-67	-73	-79	All cells S>0
T1	RS EPRE	dBm/15kHz	-115	-88	-82	Cell 1 S < 0 as described in TS 36.508 clause 6.2.2.1
T2	RS EPRE	dBm/15kHz	-115	-82	-88	

Note 1: The default values (including "not present") for all other parameters influencing cell reselection are suitable for this test. The values are defined in TS 36.508 clauses 4.4.3.2 and 4.4.3.3.

Table 6.1.2.7a.3.2-2: Main behaviour

St	Procedure	Message Sequence		TP	Verdict
		U - S	Message		
1	Check: Does the UE send an <i>RRCConectionRequest</i> within the next 100 seconds?	-->	<i>RRCConectionRequest</i>	1	F
2	SS adjusts cell levels according to row T1 of table 6.1.2.7a.3.2-1.	-	-	-	-
3	Check: Does the test result of generic test procedure in TS 36.508 subclause 6.4.2.7 indicate that the UE is camped on E-UTRAN Cell 4? NOTE: The UE performs a TAU procedure with PLMN1 and PLMN2 listed as an Equivalent PLMN in the TRACKING AREA UPDATE ACCEPT message, and the RRC connection is released.	-	-	2	P
4	SS adjusts cell levels according to row T2 of table 6.1.2.7a.3.2-1.	-	-	-	-
5	Check: Does the test result of generic test procedure in TS 36.508 subclause 6.4.2.7 indicate that the UE is camped on E-UTRAN Cell 2? NOTE: The UE performs a TAU procedure with PLMN1 and PLMN3 listed as an Equivalent PLMN in the TRACKING AREA UPDATE ACCEPT message, and the RRC connection is released.	-	-	1	P
6	SS adjusts cell levels according to row T1 of table 6.1.2.7a.3.2-1.	-	-	-	-
7	Check: Does the test result of generic test procedure in TS 36.508 subclause 6.4.2.7 indicate that the UE is camped on E-UTRAN Cell 4? NOTE: The UE performs a TAU procedure with PLMN1 and PLMN2 listed as an Equivalent PLMN in the TRACKING AREA UPDATE ACCEPT message, and the RRC connection is released.	-	-	1	P

Note 1: In Step 1, a wait time long enough to ensure that the UE has detected, measured and evaluated the neighbour intra-frequency cells is provided, see 36.133 clause 4.2.2.3.

6.1.2.7a.3.3 Specific message contents

Table 6.1.2.7a.3.3-1: ATTACH ACCEPT for Cell 1 (preamble)

Derivation path: 36.508 Table 4.7.2-1			
Information Element	Value/Remark	Comment	Condition
Equivalent PLMNs	PLMN3		

Table 6.1.2.7a.3.3-2: TRACKING AREA UPDATE ACCEPT for Cell 4 (steps 3 & 7 , Table 6.1.2.7a.3.2-2)

Derivation path: 36.508 Table 4.7.2-24			
Information Element	Value/Remark	Comment	Condition
Equivalent PLMNs	PLMN1, 2		

Table 6.1.2.7a.3.3-3: TRACKING AREA UPDATE ACCEPT for Cell 2 (step 5, Table 6.1.2.7a.3.2-2)

Derivation path: 36.508 Table 4.7.2-24			
Information Element	Value/Remark	Comment	Condition
Equivalent PLMNs	PLMN1, 3		

6.1.2.8 Cell reselection using cell status and cell reservations / Access control class 0 to 9

6.1.2.8.1 Test Purpose (TP)

(1)

```
with { UE camped normally in state E-UTRA RRC_IDLE and UE fitted with a USIM with access class 0..9}
ensure that {
  when { a higher ranked cell is found with cell status "barred" }
  then { UE does not attempt to reselect to the higher ranked cell }
}
```

(2)

```
with { UE camped normally in state E-UTRA RRC_IDLE and UE fitted with a USIM with access class 0..9}
ensure that {
  when { a higher ranked cell is found "reserved" for Operator use }
  then { UE does not attempt to reselect to the higher ranked cell }
}
```

6.1.2.8.2 Conformance requirements

References: The conformance requirements covered in the present TC are specified in: TS 36.304, clauses 5.2.4.4 and 5.3.1.

[TS 36.304, clause 5.2.4.4]

For the highest ranked cell (including serving cell) according to cell reselection criteria specified in subclause 5.2.4.6, the UE shall check if the access is restricted according to the rules in subclause 5.3.1.

If that cell and other cells have to be excluded from the candidate list, as stated in subclause 5.3.1, the UE shall not consider these as candidates for cell reselection. This limitation shall be removed when the highest ranked cell changes.

[TS 36.304, clause 5.3.1]

Cell status and cell reservations are indicated in the *SystemInformationBlockType1* [3] by means of two Information Elements:

- *cellBarred* (IE type: "barred" or "not barred")
- ...
- *cellReservedForOperatorUse* (IE type: "reserved" or "not reserved")
- ...

When cell status is indicated as "not barred" and "not reserved" for operator use,

- All UEs shall treat this cell as candidate during the cell selection and cell re-selection procedures.

When cell status is indicated as "not barred" and "reserved" for operator use for any PLMN,

- ...

- UEs assigned to an Access Class in the range of 0 to 9, 12 to 14 and UEs with AC 11 or 15 not operating in their HPLMN/EHPLMN shall behave as if the cell status is “barred” in case the cell is “reserved for operator use” for the PLMN the UE is currently registered with.

NOTE 1: ...

When cell status "barred" is indicated or to be treated as if the cell status is "barred",

- The UE is not permitted to select/re-select this cell, not even for emergency calls.
- The UE shall select another cell according to the following rule:
 - If the cell is a CSG cell:
 - ...
 - else
 - If the IE *intraFrequencyReselection* in IE *cellAccessRelatedInfo* in *SystemInformationBlockType1* is set to "allowed", the UE may select another cell on the same frequency if re-selection criteria are fulfilled.
 - The UE shall exclude the barred cell as a candidate for cell selection/reselection for 300 seconds.
 - If the IE *intraFreqReselection* in IE *cellAccessRelatedInfo* in *SystemInformationBlockType1* is set to "not allowed" the UE shall not re-select a cell on the same frequency as the barred cell.
 - The UE shall exclude the barred cell as a candidate for cell selection/reselection for 300 seconds.

6.1.2.8.3 Test description

6.1.2.8.3.1 Pre-test conditions

System Simulator:

- Three inter-frequency cells as specified in TS36.508 clause 4.4.1.2 are configured broadcasting default NAS parameters as indicated in TS 36.508 Table 4.4.2-2, except that TAC values use the codes in Table 6.0.1-2.
- SIB 1 of Cell 3 and Cell 6 indicate cellBarred=barred.
- Each cell has only a single PLMN identity.
- All cells are high quality.
- The cell power levels are configured as shown in Table 6.1.2.8.3.1-1.
- System information combination 3 as defined in TS 36.508 [18] clause 4.4.3.1 is used in E-UTRA cells.

Table 6.1.2.8.3.1-1: Cell power configuration

Parameter	Unit	Cell 1	Cell 3	Cell 6 (min UL)	Remarks
RS EPRE	dBm/15kHz	-97	-82	-67	S>0 for all cells
Note 1: The default values (including “not present”) for all other parameters influencing cell reselection are suitable for this test. The values are defined in TS36.508 clauses 4.4.3.2 and 4.4.3.3					

UE:

- The UE is in Automatic PLMN selection mode.
- The UE is equipped with a USIM containing default values (as per TS 36.508) except for those shown in Table 6.1.2.8.3.1-2.

Table 6.1.2.8.3.1–2: USIM Configuration

USIM field	Value
EF _{ACC}	Type "A" as defined in TS34.108 clause 8.3.2.15

Preamble:

- The UE is in state Registered, Idle Mode (State 2) on Cell 1 according to [18].

6.1.2.8.3.2 Test procedure sequence

Table 6.1.2.8.3.2-1: Main behaviour

St	Procedure	Message Sequence		TP	Verdict
		U - S	Message		
1	SS adjusts SIB1 of Cell 3 to indicate cellBarred=notBarred	-	-	-	-
2	Check: Does the test result of generic test procedure in TS 36.508 subclause 6.4.2.7 indicate that the UE is camped on E-UTRAN Cell 3? NOTE: The UE performs a TAU procedure and the RRC connection is released.	-	-	1	-
3	The SS notifies the UE of change of System Information. SS adjusts SIB1 of Cell 3 to indicate cellBarred=barred. (Cell 3 and Cell 6 are now both barred).	<--	<i>Paging</i>	-	-
4	Void	-	-	-	-
5	Check: Does the test result of generic test procedure in TS 36.508 subclause 6.4.2.7 indicate that the UE is camped on E-UTRAN Cell 1? NOTE: The UE performs a TAU procedure and the RRC connection is released.	-	-	1	-
6	SS adjusts SIB1 of both Cell 3 and Cell 6: Cell 3 indicates cellBarred=notBarred; Cell 6 indicates cellBarred=notBarred and cellReservedForOperatorUse = reserved.	-	-	-	-
7	Check: Does the test result of generic test procedure in TS 36.508 subclause 6.4.2.7 indicate that the UE is camped on E-UTRAN Cell 3? NOTE: The UE performs a TAU procedure and the RRC connection is released.	-	-	2	-
8	The SS notifies the UE of change of System Information. SS adjusts SIB1 of Cell 3 to indicate cellReservedForOperatorUse = reserved.	<--	<i>Paging</i>	-	-
9	Void	-	-	-	-
10	Check: Does the test result of generic test procedure in TS 36.508 subclause 6.4.2.7 indicate that the UE is camped on E-UTRAN Cell 1? NOTE: The UE performs a TAU procedure and the RRC connection is released.	-	-	2	-

6.1.2.8.3.3 Specific message contents

Table 6.1.2.8.3.3-0: Conditions for specific message contents in Tables 6.1.2.8.3.3-1, 6.1.2.8.3.3-2, 6.1.2.8.3.3-4 and 6.1.2.8.3.3-5

Condition	Explanation
Cell 3	This condition applies to system information transmitted on Cell 3.
Cell 6	This condition applies to system information transmitted on Cell 6.

Table 6.1.2.8.3.3-1: SystemInformationBlockType1 for Cell 3 and Cell 6 (pre-test conditions, Table 6.1.2.8.3.2-1)

Derivation Path: 36.508 clause 4.4.3.2			
Information Element	Value/remark	Comment	Condition
SystemInformationBlockType1 ::= SEQUENCE {			
cellAccessRelatedInfo SEQUENCE {			
plmn-IdentityList SEQUENCE (SIZE (1..6)) OF SEQUENCE {	1 entry		
cellReservedForOperatorUse	notReserved		Cell 3 Cell 6
}			
cellBarred	barred		Cell 3 Cell 6
}			
}			

Table 6.1.2.8.3.3-2: SystemInformationBlockType1 for Cell 3 and Cell 6 (step 1, Table 6.1.2.8.3.2-1)

Derivation Path: 36.508 clause 4.4.3.2			
Information Element	Value/remark	Comment	Condition
SystemInformationBlockType1 ::= SEQUENCE {			
cellAccessRelatedInfo SEQUENCE {			
plmn-IdentityList SEQUENCE (SIZE (1..6)) OF SEQUENCE {	1 entry		
cellReservedForOperatorUse	notReserved		Cell 3 Cell 6
}			
cellBarred	notBarred		Cell 3
}	barred		Cell 6
}			
systemInfoValueTag	1		Cell 3
}	0		Cell 6
}			

Table 6.1.2.8.3.3-2A: SystemInformationBlockType1 for Cell 3 and Cell 6 (step 3, Table 6.1.2.8.3.2-1)

Derivation Path: 36.508 clause 4.4.3.2			
Information Element	Value/remark	Comment	Condition
SystemInformationBlockType1 ::= SEQUENCE {			
cellAccessRelatedInfo SEQUENCE {			
plmn-IdentityList SEQUENCE (SIZE (1..6)) OF SEQUENCE {	1 entry		
cellReservedForOperatorUse	notReserved		Cell 3 Cell 6
}			
cellBarred	barred		Cell 3 Cell 6
}			
systemInfoValueTag	2		Cell 3
}	0		Cell 6
}			

Table 6.1.2.8.3.3-3: Paging (steps 3 & 8, Table 6.1.2.8.3.2-1)

Derivation Path: 36.508 Table 4.6.1-7			
Information Element	Value/remark	Comment	Condition
Paging ::= SEQUENCE {			
pagingRecordList	Not present		
systemInfoModification	true		
etws-Indication	Not present		
nonCriticalExtension SEQUENCE {}	Not present		
}			

Table 6.1.2.8.3.3-4: SystemInformationBlockType1 for Cell 3 and Cell 6 (step 6, Table 6.1.2.8.3.2-1)

Derivation Path: 36.508 clause 4.4.3.2			
Information Element	Value/remark	Comment	Condition
SystemInformationBlockType1 ::= SEQUENCE {			
cellAccessRelatedInfo SEQUENCE {			
plmn-IdentityList SEQUENCE (SIZE (1..6)) OF SEQUENCE {	1 entry		
cellReservedForOperatorUse	notReserved		Cell 3
	reserved		Cell 6
}			
cellBarred	notBarred		Cell 3 Cell 6
}			
systemInfoValueTag	3		Cell 3
	1		Cell 6
}			

Table 6.1.2.8.3.3-5: SystemInformationBlockType1 for Cell 3 and Cell 6 (step 8, Table 6.1.2.8.3.2-1)

Derivation Path: 36.508 clause 4.4.3.2			
Information Element	Value/remark	Comment	Condition
SystemInformationBlockType1 ::= SEQUENCE {			
cellAccessRelatedInfo SEQUENCE {			
plmn-IdentityList SEQUENCE (SIZE (1..6)) OF SEQUENCE {	1 entry		
cellReservedForOperatorUse	reserved		Cell 3 Cell 6
}			
cellBarred	notBarred		Cell 3 Cell 6
}			
systemInfoValueTag	4		Cell 3
	1		Cell 6
}			

6.1.2.8a Cell reselection using cell status and cell reservations / Access control class 0 to 9 / Single Frequency operation

6.1.2.8a.1 Test Purpose (TP)

Same Test Purpose as in clause 6.1.2.8.1

6.1.2.8a.2 Conformance requirements

Same Conformance requirement as in clause 6.1.2.8.2

6.1.2.8a.3 Test description

6.1.2.8a.3.1 Pre-test conditions

System Simulator:

- Three intra-frequency cells as specified in TS36.508 clause 4.4.1.2 are configured broadcasting default NAS parameters as indicated in TS 36.508 Table 4.4.2-2, except that TAC values use the codes in Table 6.0.1-2.
- SIB 1 of Cell 2 and Cell 4 indicate cellBarred=barred.
- Each cell has only a single PLMN identity.
- All cells are high quality.
- The cell power levels are configured as shown in Table 6.1.2.8a.3.1-1.

Table 6.1.2.8a.3.1-1: Cell power configuration

	Parameter	Unit	Cell 1	Cell 2	Cell 4	Remarks
T1	RS EPRE	dBm/15kHz	-73	-67	-97	Cell 2 is best ranked cell
T2	RS EPRE	dBm/15kHz	-97	-73	-67	Cell 4 is best ranked cell

Note 1: The default values (including "not present") for all other parameters influencing cell reselection are suitable for this test. The values are defined in TS36.508 clauses 4.4.3.2 and 4.4.3.3

UE:

- The UE is in Automatic PLMN selection mode.
- The UE is equipped with a USIM containing default values (as per TS 36.508) except for those shown in Table 6.1.2.8a.3.1-2.

Table 6.1.2.8a.3.1-2: USIM Configuration

USIM field	Value
EF _{ACC}	Type "A" as defined in TS34.108 clause 8.3.2.15

Preamble:

- The UE is in state Registered, Idle Mode (State 2) on Cell 1 according to [18].

6.1.2.8a.3.2 Test procedure sequence

Table 6.1.2.8a.3.2-1: Main behaviour

St	Procedure	Message Sequence		TP	Verdict
		U - S	Message		
1	SS adjusts SIB1 of Cell 2 to indicate cellBarred=notBarred and cell levels according to row T1 of table 6.1.2.8a.3.1-1.	-	-	-	-
2	Check: Does the test result of generic test procedure in TS 36.508 subclause 6.4.2.7 indicate that the UE is camped on E-UTRAN Cell 2? NOTE: The UE performs a TAU procedure and the RRC connection is released.	-	-	1	-
3	The SS notifies the UE of change of System Information. SS adjusts SIB1 of Cell 2 to indicate cellBarred=barred. (Cell 2 and Cell 4 are now both barred).	<--	<i>Paging</i>	-	-
4	Check: Does the UE send an <i>RRCConnectionRequest</i> on Cell 1 within 30 s?	-	-	1	F
5	Check: Does the test result of generic procedure in TS 36.508 subclause 6.4.2.5 indicate that the UE does not respond to paging in cell 2 when paged with S-TMSI allocated to UE with CN domain indicator set to "PS"?	-	-	1	-
6	SS adjusts SIB1 of both Cell 2 and Cell 4: Cell 2 indicates cellBarred=notBarred; Cell 4 indicates cellBarred=notBarred and cellReservedForOperatorUse = reserved. SS adjusts cell levels according to row T2 of table 6.1.2.8a.3.1-1	-	-	-	-
7	Check: Does the UE send an <i>RRCConnectionRequest</i> on Cell 4 within 30 s?	-	-	2	F
9	Check: Does the test result of generic procedure in TS 36.508 subclause 6.4.2.5 indicate that the UE does not respond to paging in cell 2 when paged with S-TMSI allocated to UE with CN domain indicator set to "PS"?	-	-	2	-
10	The SS notifies the UE of change of System Information. SS adjusts SIB1 of Cell 4 to indicate cellReservedForOperatorUse = notReserved.	<--	<i>Paging</i>	-	-
11	Check: Does the test result of generic test procedure in TS 36.508 subclause 6.4.2.7 indicate that the UE is camped on E-UTRAN Cell 4? NOTE: The UE performs a TAU procedure and the RRC connection is released.	-	-	2	-

Note : In steps 6-11, UE will have barred all the cells for 300 seconds hence may take more than 300 seconds to initiate the TAU procedure. The default value of intraFreqReselection is 'not allowed' in 36.508 table 4.4.3.2-3.

6.1.2.8a.3.3 Specific message contents

Table 6.1.2.8a.3.3-0: Conditions for specific message contents in Tables 6.1.2.8a.3.3-1, 6.1.2.8a.3.3-2, 6.1.2.8a.3.3-4 and 6.1.2.8a.3.3-5

Condition	Explanation
Cell 2	This condition applies to system information transmitted on Cell 2.
Cell 4	This condition applies to system information transmitted on Cell 4.

Table 6.1.2.8a.3.3-1: SystemInformationBlockType1 for Cell 2 and Cell 4 (pre-test conditions, Table 6.1.2.8a.3.2-1)

Derivation Path: 36.508 clause 4.4.3.2			
Information Element	Value/remark	Comment	Condition
SystemInformationBlockType1 ::= SEQUENCE {			
cellAccessRelatedInfo SEQUENCE {			
plmn-IdentityList SEQUENCE (SIZE (1..6)) OF SEQUENCE {	1 entry		
cellReservedForOperatorUse	notReserved		Cell 2 Cell 4
}			
cellBarred	barred		Cell 2 Cell 4
}			
}			

Table 6.1.2.8a.3.3-2: SystemInformationBlockType1 for Cell 2 and Cell 4 (step 1, Table 6.1.2.8a.3.2-1)

Derivation Path: 36.508 clause 4.4.3.2			
Information Element	Value/remark	Comment	Condition
SystemInformationBlockType1 ::= SEQUENCE {			
cellAccessRelatedInfo SEQUENCE {			
plmn-IdentityList SEQUENCE (SIZE (1..6)) OF SEQUENCE {	1 entry		
cellReservedForOperatorUse	notReserved		Cell 2 Cell 4
}			
cellBarred	notBarred		Cell 2
}	barred		Cell 4
}			
systemInfoValueTag	1		Cell 2
}	0		Cell 4
}			

Table 6.1.2.8a.3.3-2A: SystemInformationBlockType1 for Cell 2 and Cell 4 (step 3, Table 6.1.2.8a.3.2-1)

Derivation Path: 36.508 clause 4.4.3.2			
Information Element	Value/remark	Comment	Condition
SystemInformationBlockType1 ::= SEQUENCE {			
cellAccessRelatedInfo SEQUENCE {			
plmn-IdentityList SEQUENCE (SIZE (1..6)) OF SEQUENCE {	1 entry		
cellReservedForOperatorUse	notReserved		Cell 2 Cell 4
}			
cellBarred	barred		Cell 2 Cell 4
}			
systemInfoValueTag	2		Cell 2
}	0		Cell 4
}			

Table 6.1.2.8a.3.3-3: *Paging* (steps 3 & 10, Table 6.1.2.8a.3.2-1)

Derivation Path: 36.508 Table 4.6.1-7			
Information Element	Value/remark	Comment	Condition
Paging ::= SEQUENCE {			
pagingRecordList	Not present		
systemInfoModification	true		
etws-Indication	Not present		
nonCriticalExtension SEQUENCE {}	Not present		
}			

Table 6.1.2.8a.3.3-4: *SystemInformationBlockType1* for Cell 2 and Cell 4 (step 6, Table 6.1.2.8a.3.2-1)

Derivation Path: 36.508 clause 4.4.3.2			
Information Element	Value/remark	Comment	Condition
SystemInformationBlockType1 ::= SEQUENCE {			
cellAccessRelatedInfo SEQUENCE {			
plmn-IdentityList SEQUENCE (SIZE (1..6)) OF SEQUENCE {	1 entry		
cellReservedForOperatorUse	notReserved		Cell 2
	reserved		Cell 4
}			
cellBarred	notBarred		Cell 2 Cell 4
}			
systemInfoValueTag	3		Cell 2
	1		Cell 4
}			

Table 6.1.2.8a.3.3-5: *SystemInformationBlockType1* for Cell 2 and Cell 4 (step 10, Table 6.1.2.8a.3.2-1)

Derivation Path: 36.508 clause 4.4.3.2			
Information Element	Value/remark	Comment	Condition
SystemInformationBlockType1 ::= SEQUENCE {			
cellAccessRelatedInfo SEQUENCE {			
plmn-IdentityList SEQUENCE (SIZE (1..6)) OF SEQUENCE {	1 entry		
cellReservedForOperatorUse	notReserved		Cell 2 Cell 4
}			
cellBarred	notBarred		Cell 2 Cell 4
}			
systemInfoValueTag	3		Cell 2
	2		Cell 4
}			

6.1.2.9 Cell reselection using cell status and cell reservations / Access control class 11 to 15

6.1.2.9.1 Test Purpose (TP)

(1)

```
with { UE camped normally in state E-UTRA RRC_IDLE and UE fitted with a USIM with access class 0..9
and access classes 11..15 inclusive }
ensure that {
  when { a higher ranked cell is found with cell status "barred" }
  then { UE does not attempt to reselect to the higher ranked cell }
}
```

(2)

```

with { UE camped normally in state E-UTRA RRC_IDLE and UE fitted with a USIM with access class 0..9
and access classes 11..15 inclusive }
ensure that {
  when { a higher ranked cell is found "reserved" for Operator use }
  then { UE re-selects to the higher ranked cell }
}

```

6.1.2.9.2 Conformance requirements

References: The conformance requirements covered in the present TC are specified in: TS 36.304, clauses 5.2.4.4 and 5.3.1.

[TS 36.304, clause 5.2.4.4]

For the highest ranked cell (including serving cell) according to cell reselection criteria specified in subclause 5.2.4.6, the UE shall check if the access is restricted according to the rules in subclause 5.3.1.

If that cell and other cells have to be excluded from the candidate list, as stated in subclause 5.3.1, the UE shall not consider these as candidates for cell reselection. This limitation shall be removed when the highest ranked cell changes.

[TS 36.304, clause 5.3.1]

Cell status and cell reservations are indicated in the *SystemInformationBlockType1* [3] by means of two Information Elements:

- *cellBarred* (IE type: "barred" or "not barred")
- ...
- *cellReservedForOperatorUse* (IE type: "reserved" or "not reserved")
- ...

When cell status is indicated as "not barred" and "not reserved" for operator use,

- All UEs shall treat this cell as candidate during the cell selection and cell re-selection procedures.

When cell status is indicated as "not barred" and "reserved" for operator use for any PLMN,

- UEs assigned to Access Class 11 or 15 operating in their HPLMN/EHPLMN shall treat this cell as candidate during the cell selection and reselection procedures if the IE *cellReservedForOperatorUse* for that PLMN set to "reserved".
- UEs assigned to an Access Class in the range of 0 to 9, 12 to 14 and UEs with AC 11 or 15 not operating in their HPLMN/EHPLMN shall behave as if the cell status is "barred" in case the cell is "reserved for operator use" for the PLMN the UE is currently registered with.

NOTE 1: ...

When cell status "barred" is indicated or to be treated as if the cell status is "barred",

- The UE is not permitted to select/re-select this cell, not even for emergency calls.
- The UE shall select another cell according to the following rule:
 - If the cell is a CSG cell:
 - ...
 - else
 - If the IE *intraFrequencyReselection* in IE *cellAccessRelatedInfo* in *SystemInformationBlockType1* is set to "allowed", the UE may select another cell on the same frequency if selection/re-selection criteria are fulfilled.
 - The UE shall exclude the barred cell as a candidate for cell selection/reselection for 300 seconds.- If the IE *intraFreqReselection* in IE *cellAccessRelatedInfo* in *SystemInformationBlockType1* is set to "not allowed" the UE shall not re-select a cell on the same frequency as the barred cell.

- The UE shall exclude the barred cell as a candidate for cell selection/reselection for 300 seconds.

6.1.2.9.3 Test description

6.1.2.9.3.1 Pre-test conditions

System Simulator:

- Three inter-frequency cells as specified in TS36.508 clause 4.4.1.2 are configured broadcasting default NAS parameters as indicated in TS 36.508 Table 4.4.2-2, except that TAC values use the codes in Table 6.0.1-2.
- SIB 1 of Cell 3 and Cell 6 indicate cellBarred=barred
- Each cell has only a single PLMN identity.
- All cells are high quality.
- The cell power levels are configured as shown in Table 6.1.2.9.3.1-1.
- System information combination 3 as defined in TS 36.508 [18] clause 4.4.3.1 is used in E-UTRA cells.

Table 6.1.2.9.3.1–1: Cell power configuration

Parameter	Unit	Cell 1	Cell 3	Cell 6	Remarks
RS EPRE	dBm/15kHz	-97	-82	-67	S>0 for all cells
Note 1: The default values (including “not present”) for all other parameters influencing cell reselection are suitable for this test. The values are defined in TS36.508 clauses 4.4.3.2 and 4.4.3.3					

UE:

- The UE is in Automatic PLMN selection mode.
- The UE is equipped with a USIM containing default values (as per TS 36.508) except for those shown in Table 6.1.2.9.3.1-2.

Table 6.1.2.9.3.1–2: USIM Configuration

USIM field	Value
EF _{ACC}	Type “B” as defined in TS34.108 clause 8.3.2.15

Preamble:

- The UE is in state Registered, Idle Mode (State 2) on Cell 1 according to [18].

6.1.2.9.3.2 Test procedure sequence

Table 6.1.2.9.3.2-1: Main behaviour

St	Procedure	Message Sequence		TP	Verdict
		U - S	Message		
1	SS adjusts SIB1 of Cell 3 to indicate cellBarred=notBarred	-	-	-	-
2	Check: Does the test result of generic test procedure in TS 36.508 subclause 6.4.2.7 indicate that the UE is camped on E-UTRAN Cell 3? NOTE: The UE performs a TAU procedure with establishment cause 'high priority access' and the RRC connection is released.	-	-	1	-
3	The SS notifies the UE of change of System Information. SS adjusts SIB1 of Cell 3 to indicate cellBarred=barred. (Cell 3 and Cell 6 are now both barred) .	<--	<i>Paging</i>	-	-
4	Void	-	-	-	-
5	Check: Does the test result of generic test procedure in TS 36.508 subclause 6.4.2.7 indicate that the UE is camped on E-UTRAN Cell 1? NOTE: The UE performs a TAU procedure with establishment cause 'high priority access' and the RRC connection is released.	-	-	1	-
6	SS adjusts SIB1 of both Cell 3 and Cell 6: Cell 3 indicates cellBarred=notBarred; Cell 6 indicates cellBarred=notBarred and cellReservedForOperatorUse = reserved	-	-	-	-
7	Check: Does the test result of generic test procedure in TS 36.508 subclause 6.4.2.7 indicate that the UE is camped on E-UTRAN Cell 6? NOTE: The UE performs a TAU procedure with establishment cause 'high priority access' and the RRC connection is released.	-	-	2	-

6.1.2.9.3.3 Specific message contents

Table 6.1.2.9.3.3-0: Conditions for specific message contents in Tables 6.1.2.9.3.3-1, 6.1.2.9.3.3-2 and 6.1.2.8.3.3-4

Condition	Explanation
Cell 3	This condition applies to system information transmitted on Cell 3.
Cell 6	This condition applies to system information transmitted on Cell 6.

Table 6.1.2.9.3.3-1: SystemInformationBlockType1 for Cell 3 and Cell 6 (pre-test conditions, Table 6.1.2.9.3.2-1)

Derivation Path: 36.508 clause 4.4.3.2			
Information Element	Value/remark	Comment	Condition
SystemInformationBlockType1 ::= SEQUENCE {			
cellAccessRelatedInfo SEQUENCE {			
plmn-IdentityList SEQUENCE (SIZE (1..6)) OF SEQUENCE {	1 entry		
cellReservedForOperatorUse	notReserved		Cell 3 Cell 6
}			
cellBarred	barred		Cell 3 Cell 6
}			
}			

Table 6.1.2.9.3.3-2: SystemInformationBlockType1 for Cell 3 and Cell 6 (step 1, Table 6.1.2.9.3.2-1)

Derivation Path: 36.508 clause 4.4.3.2			
Information Element	Value/remark	Comment	Condition
SystemInformationBlockType1 ::= SEQUENCE {			
cellAccessRelatedInfo SEQUENCE {			
plmn-IdentityList SEQUENCE (SIZE (1..6)) OF SEQUENCE {	1 entry		
cellReservedForOperatorUse	notReserved		Cell 3 Cell 6
}			
cellBarred	notBarred		Cell 3
}	barred		Cell 6
}			
systemInfoValueTag	1		Cell 3
}	0		Cell 6
}			

Table 6.1.2.9.3.3-2A: SystemInformationBlockType1 for Cell 3 and Cell 6 (step 3, Table 6.1.2.8.3.2-1)

Derivation Path: 36.508 clause 4.4.3.2			
Information Element	Value/remark	Comment	Condition
SystemInformationBlockType1 ::= SEQUENCE {			
cellAccessRelatedInfo SEQUENCE {			
plmn-IdentityList SEQUENCE (SIZE (1..6)) OF SEQUENCE {	1 entry		
cellReservedForOperatorUse	notReserved		Cell 3 Cell 6
}			
cellBarred	barred		Cell 3 Cell 6
}			
systemInfoValueTag	2		Cell 3 Cell 6
}	0		
}			

Table 6.1.2.9.3.3-3: Paging (step 3, Table 6.1.2.9.3.2-1)

Derivation Path: 36.508 Table 4.6.1-7			
Information Element	Value/remark	Comment	Condition
Paging ::= SEQUENCE {			
pagingRecordList	Not present		
systemInfoModification	true		
etws-Indication	Not present		
nonCriticalExtension SEQUENCE {}	Not present		
}			

Table 6.1.2.9.3.3-4: SystemInformationBlockType1 for Cell 3 and Cell 6 (step 6, Table 6.1.2.9.3.2-1)

Derivation Path: 36.508 clause 4.4.3.2			
Information Element	Value/remark	Comment	Condition
SystemInformationBlockType1 ::= SEQUENCE {			
cellAccessRelatedInfo SEQUENCE {			
plmn-IdentityList SEQUENCE (SIZE (1..6)) OF SEQUENCE {	1 entry		
cellReservedForOperatorUse	notReserved		Cell 3
	reserved		Cell 6
}			
cellBarred	notBarred		Cell 3 Cell 6
}			
systemInfoValueTag	3		Cell 3
	1		Cell 6
}			

Table 6.1.2.9.3.3-5: RRCConnectionRequest (step2, step5 and step7, Table 6.1.2.9.3.2-1)

Derivation Path: 36.508, Table 4.6.1-16			
Information Element	Value/remark	Comment	Condition
RRCConnectionRequest ::= SEQUENCE {			
criticalExtensions CHOICE {			
rrcConnectionRequest-r8 SEQUENCE {			
establishmentCause	highPriorityAccess		
}			
}			
}			

6.1.2.9a Cell reselection using cell status and cell reservations / Access control class 11 to 15 / Single Frequency operation

6.1.2.9a.1 Test Purpose (TP)

Same Test Purpose as in clause 6.1.2.9.1.

6.1.2.9a.2 Conformance requirements

Same Conformance requirement as in clause 6.1.2.9.2.

6.1.2.9a.3 Test description

6.1.2.9a.3.1 Pre-test conditions

System Simulator:

- Three intra-frequency cells as specified in TS36.508 clause 4.4.1.2 are configured broadcasting default NAS parameters as indicated in TS 36.508 Table 4.4.2-2, except that TAC values use the codes in Table 6.0.1-2.
- SIB 1 of Cell 2 and Cell 4 indicate cellBarred=barred

- Each cell has only a single PLMN identity.
- All cells are high quality.
- The cell power levels are configured as shown in Table 6.1.2.9a.3.1-1.

Table 6.1.2.9a.3.1–1: Cell power configuration

	Parameter	Unit	Cell 1	Cell 2	Cell 4	Remarks
T1	RS EPRE	dBm/15kHz	-73	-67	-97	Cell 2 is best ranked cell
T2	RS EPRE	dBm/15kHz	-97	-73	-67	Cell 4 is best ranked cell
Note 1: The default values (including "not present") for all other parameters influencing cell reselection are suitable for this test. The values are defined in TS36.508 clauses 4.4.3.2 and 4.4.3.3						

UE:

- The UE is in Automatic PLMN selection mode.
- The UE is equipped with a USIM containing default values (as per TS 36.508) except for those shown in Table 6.1.2.9a.3.1-2.

Table 6.1.2.9a.3.1–2: USIM Configuration

USIM field	Value
EF _{ACC}	Type "B" as defined in TS34.108 clause 8.3.2.15

Preamble:

- The UE is in state Registered, Idle Mode (State 2) on Cell 1 according to [18].

6.1.2.9a.3.2 Test procedure sequence

Table 6.1.2.9a.3.2-1: Main behaviour

St	Procedure	Message Sequence		TP	Verdict
		U - S	Message		
1	SS adjusts SIB1 of Cell 2 to indicate cellBarred=notBarred and cell levels according to row T1 of table 6.1.2.9a.3.1-1.	-	-	-	-
2	Check: Does the test result of generic test procedure in TS 36.508 subclause 6.4.2.7 indicate that the UE is camped on E-UTRAN Cell 2? NOTE: The UE performs a TAU procedure with establishment cause 'high priority access' and the RRC connection is released.	-	-	-	-
3	The SS notifies the UE of change of System Information. SS adjusts SIB1 of Cell 2 to indicate cellBarred=barred. (Cell 2 and Cell 4 are now both barred).	<--	<i>Paging</i>	-	-
3A	Wait for 2.1* modification period (Note 2) to allow the new system information to take effect.	-	-	-	-
4	Void	-	-	-	-
5	Check: Does the test result of generic procedure in TS 36.508 subclause 6.4.2.5 indicate that the UE does not respond to paging in Cell 2 when paged with S-TMSI allocated to UE with CN domain indicator set to "PS"?	-	-	1	-
5A	Check: Does the UE send an <i>RRCConnectionRequest</i> on Cell 1, Cell 2 or Cell 4 within 300 s of step 3?	-	-	1	F
6	SS adjusts SIB1 of both Cell 2 and Cell 4: Cell 2 indicates cellBarred=notBarred; Cell 4 indicates cellBarred=notBarred and cellReservedForOperatorUse = reserved. SS adjusts cell levels according to row T2 of table 6.1.2.9a.3.1-1.	-	-	-	-
7	Check: Does the test result of generic test procedure in TS 36.508 subclause 6.4.2.7 indicate that the UE is camped on E-UTRAN Cell 4? NOTE: The UE performs a TAU procedure with establishment cause 'high priority access' and the RRC connection is released.	-	-	2	-
<p>Note 1: In steps 3-5A, UE will have barred all the cells for 300 seconds. The default value of <i>intraFreqReselection</i> is 'not allowed' in 36.508 table 4.4.3.2-3.</p> <p>Note 2: The wait time of 2.1* modification period in step 3A is to allow for the network to paging the system information change during the next modification period, and update the system information at the subsequent modification period. UE should acquire the updated system information within 100ms of the start of modification period.</p>					

6.1.2.9a.3.3 Specific message contents

Table 6.1.2.9a.3.3-0: Conditions for specific message contents
in Tables 6.1.2.9a.3.3-1, 6.1.2.9a.3.3-2, 6.1.2.9a.3.3-2A and 6.1.2.9a.3.3-4

Condition	Explanation
Cell 2	This condition applies to system information transmitted on Cell 2.
Cell 4	This condition applies to system information transmitted on Cell 4.

Table 6.1.2.9a.3.3-1: SystemInformationBlockType1 for Cell 2 and Cell 4 (pre-test conditions, Table 6.1.2.9a.3.2-1)

Derivation Path: 36.508 clause 4.4.3.2			
Information Element	Value/remark	Comment	Condition
SystemInformationBlockType1 ::= SEQUENCE {			
cellAccessRelatedInfo SEQUENCE {			
plmn-IdentityList SEQUENCE (SIZE (1..6)) OF SEQUENCE {	1 entry		
cellReservedForOperatorUse	notReserved		Cell 2 Cell 4
}			
cellBarred	barred		Cell 2 Cell 4
}			
}			

Table 6.1.2.9a.3.3-2: SystemInformationBlockType1 for Cell 2 and Cell 4 (step 1, Table 6.1.2.9a.3.2-1)

Derivation Path: 36.508 clause 4.4.3.2			
Information Element	Value/remark	Comment	Condition
SystemInformationBlockType1 ::= SEQUENCE {			
cellAccessRelatedInfo SEQUENCE {			
plmn-IdentityList SEQUENCE (SIZE (1..6)) OF SEQUENCE {	1 entry		
cellReservedForOperatorUse	notReserved		Cell 2 Cell 4
}			
cellBarred	notBarred		Cell 2
	barred		Cell 4
}			
systemInfoValueTag	1		Cell 2
	0		Cell 4
}			

Table 6.1.2.9a.3.3-2A: SystemInformationBlockType1 for Cell 2 and Cell 4 (step 3, Table 6.1.2.9a.3.2-1)

Derivation Path: 36.508 clause 4.4.3.2			
Information Element	Value/remark	Comment	Condition
SystemInformationBlockType1 ::= SEQUENCE {			
cellAccessRelatedInfo SEQUENCE {			
plmn-IdentityList SEQUENCE (SIZE (1..6)) OF SEQUENCE {	1 entry		
cellReservedForOperatorUse	notReserved		Cell 2 Cell 4
}			
cellBarred	barred		Cell 2 Cell 4
}			
systemInfoValueTag	2		Cell 2 Cell 4
	0		
}			

Table 6.1.2.9a.3.3-3: Paging (step 3, Table 6.1.2.9a.3.2-1)

Derivation Path: 36.508 Table 4.6.1-7			
Information Element	Value/remark	Comment	Condition
Paging ::= SEQUENCE {			
pagingRecordList	Not present		
systemInfoModification	true		
etws-Indication	Not present		
nonCriticalExtension SEQUENCE {}	Not present		
}			

Table 6.1.2.9a.3.3-4: SystemInformationBlockType1 for Cell 2 and Cell 4 (step 6, Table 6.1.2.9a.3.2-1)

Derivation Path: 36.508 clause 4.4.3.2			
Information Element	Value/remark	Comment	Condition
SystemInformationBlockType1 ::= SEQUENCE {			
cellAccessRelatedInfo SEQUENCE {			
plmn-IdentityList SEQUENCE (SIZE (1..6)) OF SEQUENCE {	1 entry		
cellReservedForOperatorUse	notReserved		Cell 2
	reserved		Cell 4
}			
cellBarred	notBarred		Cell 2 Cell 4
}			
systemInfoValueTag	3		Cell 2
	1		Cell 4
}			

Table 6.1.2.9a.3.3-5: RRCConnectionRequest (step2, step5 and step7, Table 6.1.2.9a.3.2-1)

Derivation Path: 36.508, Table 4.6.1-16			
Information Element	Value/remark	Comment	Condition
RRCConnectionRequest ::= SEQUENCE {			
criticalExtensions CHOICE {			
rrcConnectionRequest-r8 SEQUENCE {			
establishmentCause	highPriorityAccess		
}			
}			
}			

6.1.2.10 Cell reselection in shared network environment

6.1.2.10.1 Test Purpose (TP)

with { the UE is in E-UTRA RRC_Idle and registered on the HPLMN }
ensure that {
 when { a cell of a different PLMN but shared with the HPLMN becomes highest ranked cell }
 then { the UE reselects the cell shared with the HPLMN }
}

6.1.2.10.2 Conformance requirements

References: The conformance requirements covered in the present TC are specified in: TS 36.304 clause 5.2.4.2 and TS 23.122 clause 4.4.3.

[TS 36.304, clause 5.2.4.6]

The cell-ranking criterion R_s for serving cell and R_n for neighbouring cells is defined by:

$$R_s = Q_{\text{meas},s} + Q_{\text{Hyst}}$$

$$R_n = Q_{\text{meas},n} - Q_{\text{offset}}$$

where:

Q_{meas}	RSRP measurement quantity used in cell reselections.
Q_{offset}	For intra-frequency: Equals to $Q_{\text{offset},s,n}$, if $Q_{\text{offset},s,n}$ is valid, otherwise this equals to zero. For inter-frequency: Equals to $Q_{\text{offset},s,n}$ plus $Q_{\text{offset},\text{frequency}}$, if $Q_{\text{offset},s,n}$ is valid, otherwise this equals to $Q_{\text{offset},\text{frequency}}$.

The UE shall perform ranking of all cells that fulfil the cell selection criterion S, which is defined in 5.2.3.2, but may exclude all CSG cells that are known by the UE to be not allowed.

The cells shall be ranked according to the R criteria specified above, deriving $Q_{\text{meas},n}$ and $Q_{\text{meas},s}$ and calculating the R values using averaged RSRP results.

If a cell is ranked as the best cell the UE shall perform cell reselection to that cell. If this cell is found to be not-suitable, the UE shall behave according to subclause 5.2.4.4.

In all cases, the UE shall reselect the new cell, only if the following conditions are met:

- the new cell is better ranked than the serving cell during a time interval $T_{\text{reselection,RAT}}$;
- more than 1 second has elapsed since the UE camped on the current serving cell.

[TS 23.122, clause 4.4.3]

...

When the MS reselects to a cell in a shared network, the AS may indicate multiple PLMN identities to the NAS according to 3GPP TS 25.304 [32]. The MS shall choose one of these PLMNs. If the registered PLMN is available among these PLMNs, the MS shall not choose a different PLMN.

...

6.1.2.10.3 Test description

6.1.2.10.3.1 Pre-test conditions

System Simulator:

- Cell 1 (HPLMN)
- Cell 2 (primary PLMN: same MCC like HPLMN but different MNC, secondary PLMN: HPLMN)
- System information combination 3 as defined in TS 36.508 [18] clause 4.4.3.1 is used in E-UTRA cells.

UE:

None.

Preamble:

- The UE is in state Registered, Idle mode (state 2) on Cell 1 according to [18].

6.1.2.10.3.2 Test procedure sequence

Table 6.1.2.10.3.2-1 illustrates the downlink power levels and other changing parameters to be applied for the cells at various time instants of the test execution. Row marked "T0" denotes the conditions after the preamble, while columns marked "T1" is to be applied subsequently. The exact instants on which these values shall be applied are described in the texts in this clause.

Table 6.1.2.10.3.2-1: Time instances of cell power level and parameter change

	Parameter	Unit	Cell 1	Cell 2	Remark
T0	Cell-specific RS EPRE	dBm/15kHz	-85	Off	
T1	Cell-specific RS EPRE	dBm/15kHz	-85	-73	The power level values are assigned to satisfy $Srxlev_{Cell 2} > Srxlev_{Cell 1}$

Table 6.1.2.10.3.2-2: Main behaviour

St	Procedure	Message Sequence		TP	Verdict
		U - S	Message		
1	The SS changes Cell 1 and Cell 2 level according to the row "T1" in table 6.1.2.10.3.2-1.	-	-	-	-
2	Check: Does the UE transmit an <i>RRCCoalitionRequest</i> on Cell 2?	-->	<i>RRCCoalitionRequest</i>	1	P
3	The SS transmits an <i>RRCCoalitionSetup</i>	<--	<i>RRCCoalitionSetup</i>	-	-
4	Check; Does the UE transmit an <i>RRCCoalitionSetupComplete</i> message indicating the HPLMN (second PLMN in the list)? Note: this message contains an TRACKING AREA UPDATE REQUEST message according to default message contents.	-->	<i>RRCCoalitionSetupComplete</i>	1	P
5 - 7	Steps 4 to 6 of the generic test procedure in TS 36.508 subclause 6.4.2.7 are performed. NOTE: The UE performs a TAU procedure and the RRC connection is released.	-	-	-	-

6.1.2.10.3.3 Specific message contents

Table 6.1.2.10.3.3-1: SystemInformationBlockType1 (Cell 1, all steps, Table 6.1.2.10.3.2-2)

Derivation path: 36.508 Table 4.4.3.2-3			
Information Element	Value/Remark	Comment	Condition
SystemInformationBlockType1 ::= SEQUENCE { cellAccessRelatedInfo SEQUENCE { plmn-IdentityList SEQUENCE (SIZE (1..6)) OF SEQUENCE { plmn-Identity[1] } } }	Set to the same Mobile Country Code and Mobile Network Code stored in EFIMSI on the test USIM card		

Table 6.1.2.10.3.3-2: SystemInformationBlockType1 (Cell 2, all steps, Table 6.1.2.10.3.2-2)

Derivation path: 36.508 Table 4.4.3.2-3			
Information Element	Value/Remark	Comment	Condition
SystemInformationBlockType1 ::= SEQUENCE { cellAccessRelatedInfo SEQUENCE { plmn-IdentityList SEQUENCE (SIZE (1..6)) OF SEQUENCE { plmn-Identity[1] plmn-Identity[2] } } }	Set to the same Mobile Country Code stored in EFIMSI on the test USIM, MNC=02 Set to the same Mobile Country Code and Mobile Network Code stored in EFIMSI on the test USIM card	This is the same PLMN as Cell 1	

Table 6.1.2.10.3.3-3: RRCConnectionSetupComplete (step 4, Table 6.1.2.10.3.2-2)

Derivation Path: 36.508, Table 4.6.1-18			
Information Element	Value/remark	Comment	Condition
RRCConnectionSetupComplete ::= SEQUENCE {			
criticalExtensions CHOICE {			
c1 CHOICE{			
rrcConnectionSetupComplete-r8 SEQUENCE {			
selectedPLMN-Identity	2	HPLMN	
}			
}			
}			
}			

6.1.2.11 Inter-frequency cell reselection

6.1.2.11.1 Test Purpose (TP)

(1)

```
with { UE in E-UTRA RRC_IDLE state }
ensure that {
  when { UE detects both intra-frequency and equal priority inter-frequency neighbour cells and the
inter-frequency cell is the highest ranked cell }
  then { UE reselects the inter-frequency cell }
}
```

6.1.2.11.2 Conformance requirements

References: The conformance requirements covered in the present TC are specified in: TS 36.304, clause 5.2.4.5 and 5.2.4.6.

[TS 36.304, clause 5.2.4.5]

Cell reselection to a cell on an equal priority E-UTRAN frequency shall be based on ranking for Intra-frequency cell reselection as defined in sub-clause 5.2.4.6.

[TS 36.304, clause 5.2.4.6]

The cell-ranking criterion R_s for serving cell and R_n for neighbouring cells is defined by:

$$R_s = Q_{\text{meas},s} + Q_{\text{Hyst}}$$

$$R_n = Q_{\text{meas},n} - Q_{\text{offset}}$$

where:

Q_{meas}	RSRP measurement quantity used in cell reselections.
Q_{offset}	For intra-frequency: Equals to $Q_{\text{offset},s,n}$, if $Q_{\text{offset},s,n}$ is valid, otherwise this equals to zero. For inter-frequency: Equals to $Q_{\text{offset},s,n}$ plus $Q_{\text{offset},\text{frequency}}$, if $Q_{\text{offset},s,n}$ is valid, otherwise this equals to $Q_{\text{offset},\text{frequency}}$.

The UE shall perform ranking of all cells that fulfil the cell selection criterion S, which is defined in 5.2.3.2, but may exclude all CSG cells that are known by the UE to be not allowed.

The cells shall be ranked according to the R criteria specified above, deriving $Q_{\text{meas},n}$ and $Q_{\text{meas},s}$ and calculating the R values using averaged RSRP results.

If a cell is ranked as the best cell the UE shall perform cell reselection to that cell. If this cell is found to be not-suitable, the UE shall behave according to subclause 5.2.4.4.

In all cases, the UE shall reselect the new cell, only if the following conditions are met:

- the new cell is better ranked than the serving cell during a time interval $T_{\text{reselection,RAT}}$;
- more than 1 second has elapsed since the UE camped on the current serving cell.

6.1.2.11.3 Test description

6.1.2.11.3.1 Pre-test conditions

System Simulator:

- Cell 1, Cell 2 and Cell 3 have different tracking areas according to table 6.0.1-2.
- System information combination 3 as defined in TS 36.508 [18] clause 4.4.3.1 is used in E-UTRA cells.

UE:

None.

Preamble:

- The UE is in state Registered, Idle mode (state 2) on Cell 1 (serving cell) according to [18].

6.1.2.11.3.2 Test procedure sequence

Table 6.1.2.11.3.2-1 illustrates the downlink power levels and other changing parameters to be applied for the cells at various time instants of the test execution. The configuration marked "T1" is applied at the point indicated in the Main behaviour description in Table 6.1.2.11.3.2-2.

Table 6.1.2.11.3.2-1: Time instances of cell power level and parameter changes

	Parameter	Unit	Cell 1	Cell 2	Cell 3	Remark
T1	Cell-specific RS EPRE	dBm/15kHz	-85	-91	-73	The power level values are set so that $R_{\text{Cell 2}} < R_{\text{Cell 1}} < R_{\text{Cell 3}}$.

Table 6.1.2.11.3.2-2: Main behaviour

St	Procedure	Message Sequence		TP	Verdict
		U - S	Message		
1	The SS changes the cells power level setting according to the row "T1" in table 6.1.2.11.3.2-1.	-	-	-	-
2	Check: Does the test result of generic test procedure in TS 36.508 subclause 6.4.2.7 indicate that the UE is camped on E-UTRAN Cell 3? NOTE: The UE performs a TAU procedure and the RRC connection is released.	-	-	1	-

6.1.2.11.3.3 Specific message contents

Table 6.1.2.11.3.3-1: Void

Table 6.1.2.11.3.3-2: Void

Table 6.1.2.11.3.3-3: Void

6.1.2.12 Cell reselection / Cell-specific reselection parameters provided by the network in a neighbouring cell list

6.1.2.12.1 Test Purpose

(1)

```
with { the UE is in RRC_IDLE and SystemInformationBlockType4 contain a cell-specific Qoffset for a
neighbour intra frequency cell }
ensure that {
  when { the neighbour cell has lower power than the serving cell but it is higher ranked due to the
cell-specific Qoffset }
  then { the UE reselects the neighbour cell with cell-specific Qoffset }
}
```

(2)

```
with { the UE is in RRC_IDLE and SystemInformationBlockType4 contain a black listed cell }
ensure that {
  when { a black listed cell becomes higher ranked than the serving cell }
  then { the UE remains camped on the serving cell }
}
```

6.1.2.12.2 Conformance Requirements

References: The conformance requirements covered in the current TC are specified in: TS 36.304, clauses 5.2.4.1 and 5.2.4.6.

[TS 36.304 clause 5.2.4.1]

The UE shall not consider any black listed cells as candidate for cell reselection.

[TS 36.304 clause 5.2.4.6]

The cell-ranking criterion R_s for serving cell and R_n for neighbouring cells is defined by:

$$R_s = Q_{\text{meas},s} + Q_{\text{Hyst}}$$

$$R_n = Q_{\text{meas},n} - Q_{\text{offset}}$$

where:

Q_{meas}	RSRP measurement quantity used in cell reselections.
Qoffset	For intra-frequency: Equals to $Q_{offset_{s,n}}$, if $Q_{offset_{s,n}}$ is valid, otherwise this equals to zero. For inter-frequency: Equals to $Q_{offset_{s,n}}$ plus $Q_{offset_{frequency}}$, if $Q_{offset_{s,n}}$ is valid, otherwise this equals to $Q_{offset_{frequency}}$.

The UE shall perform ranking of all cells that fulfil the cell selection criterion S, which is defined in 5.2.3.2, but may exclude all CSG cells that are known by the UE to be not allowed.

The cells shall be ranked according to the R criteria specified above, deriving $Q_{meas,n}$ and $Q_{meas,s}$ and calculating the R values using averaged RSRP results.

If a cell is ranked as the best cell the UE shall perform cell reselection to that cell. If this cell is found to be not-suitable, the UE shall behave according to subclause 5.2.4.4.

In all cases, the UE shall reselect the new cell, only if the following conditions are met:

- the new cell is better ranked than the serving cell during a time interval $T_{reselection_{RAT}}$;
- more than 1 second has elapsed since the UE camped on the current serving cell.

6.1.2.12.3 Test description

6.1.2.12.3.1 Pre-test conditions

System Simulator:

- cells 1, 2, and 4 on the same E-UTRA frequency and in different tracking areas
- only 2 cells are simultaneously active, Cell 4 can be implemented as minimum uplink cell
- System information combination 2 as defined in TS 36.508 [18] clause 4.4.3.1 is used in E-UTRA cells.
- cell 1 is transmitting *SystemInformationBlockType4* according to specific message contents ($Q_{offset_{1,2}}$ is -24dB)
- cell 2 is transmitting *SystemInformationBlockType4* according to specific message contents ($Q_{offset_{2,1}}$ is 24dB, cell 4 is on black list)

NOTE: $Q_{offset_{2,1}}$ does not serve any test purpose, but symmetrical Qoffset values may be more realistic.

UE:

None.

Preamble:

- the UE is in state Registered, Idle mode (state 2) on Cell 1 according to [18].

6.1.2.12.3.2 Test procedure sequence

Table 6.1.2.12.3.2-1 illustrates the downlink power levels and other changing parameters to be applied for the cells at various time instants of the test execution. Rows marked "T0" denote the conditions after the preamble, while rows marked "T1" and "T2" are to be applied subsequently. The exact instants on which these values shall be applied are described in the texts in this clause.

Table 6.1.2.12.3.2-1: Time instances of cell power level and parameter change

Ti	Parameter	Unit	Cell 1	Cell 2	Cell 4	Remark
T0	Cell-specific RS EPRE	dBm/15kHz	-85	Off	Off	Only Cell 1 is on
T1	Cell-specific RS EPRE (FDD)		-85	-91	Off	Cell 2 has lower power but is higher ranked due to cell-specific Qoffset _{1,2}
	Cell-specific RS EPRE (TDD)		-85	-89	Off	
T2	Cell-specific RS EPRE (FDD)		Off	-91	Off	
	Cell-specific RS EPRE (TDD)		Off	-89	Off	
T3	Cell-specific RS EPRE		Off	-91	-85	Cell 4 has higher power than Cell 2 but is black listed

Table 6.1.2.12.3.2-2: Main behaviour

St	Procedure	Message Sequence		TP	Verdict
		U - S	Message		
1	The SS re-adjusts the cell-specific reference signal levels according to row "T1" in table 6.1.2.12.3.2-1.	-	-	-	-
2	Void				
2A-2E	Check: Does the test result of test steps 1 to 5 of generic procedure 6.4.2.7 indicate that the UE is camped on Cell 2?	-	-	1	-
2F	The SS re-adjusts the cell-specific reference signal levels according to row "T2" in table 6.1.2.12.3.2-1	-	-	-	-
2G	The SS waits for 1s. Note: Delay is added to ensure cell power levels set at T2 has settled on correct level (36.523-3 cl. 7.4.2) before RRC connection is released.	-	-	-	-
2H	The SS transmits an <i>RRConnectionRelease</i> message to release RRC connection and move to RRC_IDLE.	<--	RRC: <i>RRConnectionRelease</i>	-	-
3	The SS re-adjusts the cell-specific reference signal levels according to row "T3" in table 6.1.2.12.3.2-1.	-	-	-	-
4	Check: Does the UE initiate a random access procedure on Cell 4 within the next 120s?	-	-	2	F

6.1.2.12.3.3 Specific message contents

Table 6.1.2.12.3.3-1: SystemInformationBlockType4 for cell 1 (all steps, Table 6.1.2.12.3.2-2)

Derivation path: 36.508 table 4.4.3.3-3			
Information Element	Value/Remark	Comment	Condition
SystemInformationBlockType4 ::= SEQUENCE {			
intraFreqNeighCellList SEQUENCE {	1 entry		
physCellId[1]	PhysicalCellID of Cell 2		
q-OffsetCell[1]	dB-24		
}			
}			

Table 6.1.2.12.3.3-2: SystemInformationBlockType4 for cell 2 (all steps, Table 6.1.2.12.3.2-2)

Derivation path: 36.508 table 4.4.3.3-3			
Information Element	Value/Remark	Comment	Condition
SystemInformationBlockType4 ::= SEQUENCE {			
intraFreqNeighCellList {	1 entry		
physCellId[1]	PhysicalCellID of Cell 1		
q-OffsetCell[1]	dB24		
}			
intraFreqBlackCellList SEQUENCE {	1 entry		
start[1]	PhysicalCellID of Cell 4		
range[1]	Not present		
}			
}			

6.1.2.13 Cell reselection, $S_{\text{intrasearch}}$, $S_{\text{nonintrasearch}}$

6.1.2.13.1 Test Purpose (TP)

(1)

```
with { UE in E-UTRA RRC_IDLE state, and the UE is not in high mobility state }
ensure that {
  when {  $S_{\text{intrasearch}}$  is non-zero in system information }
  then { UE perform measurement and reselects the highest ranked cell upon  $S_{\text{rxlev}} < S_{\text{intrasearch}}$  }
}
```

(2)

```
with { UE in E-UTRA RRC_IDLE state, and the UE is not in high mobility state }
ensure that {
  when {  $S_{\text{nonintrasearch}}$  is non-zero in system information }
  then { UE perform measurement and reselects the cell which belong to the equal priority
frequency cell upon  $S_{\text{rxlev}} < S_{\text{nonintrasearch}}$  }
}
```

(3)

```
with { UE in E-UTRA RRC_IDLE state, and the UE is not in high mobility state }
ensure that {
  when {  $S_{\text{nonintrasearch}}$  is non-zero in system information }
  then { UE perform measurement and reselects the cell which belong to the high priority
frequency cell upon  $S_{\text{rxlev}} > S_{\text{nonintrasearch}}$  }
}
```

6.1.2.13.2 Conformance requirements

References: The conformance requirements covered in the current TC are specified in: TS36.304, clauses 5.2.4.2, 5.2.4.5 and 5.2.4.6; TS36.331, clause 6.3.1; TS36.133, clause 4.2.2.4.

[TS 36.304, clause 5.2.4.2]

When evaluating for reselection purposes cell selection criterion or $S_{\text{nonServingCell},x}$, the UE shall use parameters provided by the serving cell.

Following rules are used by the UE to limit needed measurements:

- If $S_{\text{intraSearch}}$ is sent in the serving cell and $S_{\text{ServingCell}} > S_{\text{intraSearch}}$, UE may choose to not perform intra-frequency measurements.
- If $S_{\text{ServingCell}} \leq S_{\text{intraSearch}}$, or $S_{\text{intraSearch}}$ is not sent in the serving cell UE shall perform intra-frequency measurements.
- The UE shall apply the following rules for E-UTRAN inter-frequencies and inter-RAT frequencies which are indicated in system information and for which the UE has priority provided as defined in 5.2.4.1:
 - For an E-UTRAN inter-frequency or inter-RAT frequency with a reselection priority higher than the reselection priority of the current E-UTRA frequency the UE shall perform measurements of higher priority E-UTRAN inter-frequency or inter-RAT frequencies according to [10].
 - For an E-UTRAN inter-frequency with an equal or lower reselection priority than the reselection priority of the current E-UTRA frequency and for inter-RAT frequency with lower reselection priority than the reselection priority of the current E-UTRAN frequency:
 - If $S_{\text{nonIntraSearch}}$ is sent in the serving cell and $S_{\text{ServingCell}} > S_{\text{nonIntraSearch}}$ UE may choose not to perform measurements of E-UTRAN inter-frequencies or inter-RAT frequency cells of equal or lower priority.
 - If $S_{\text{ServingCell}} \leq S_{\text{nonIntraSearch}}$ or $S_{\text{nonIntraSearch}}$ is not sent in the serving cell the UE shall perform measurements of E-UTRAN inter-frequencies or inter-RAT frequency cells of equal or lower priority according to [10].

Where $S_{\text{ServingCell}}$ is the S_{rxlev} -value of the serving cell.

[TS 36.304, clause 5.2.4.5]

Criteria 1: the $S_{\text{nonServingCell},x}$ of a cell on evaluated frequency is greater than $\text{Thresh}_{x, \text{high}}$ during a time interval $\text{Treselection}_{\text{RAT}}$;

.....

Cell reselection to a cell on an equal priority E-UTRAN frequency shall be based on ranking for Intra-frequency cell reselection as defined in sub-clause 5.2.4.6.

.....

In all the above criteria the value of $\text{Treselection}_{\text{RAT}}$ is scaled when the UE is in the medium or high mobility state as defined in subclause 5.2.4.3.1. If more than one cell meets the above criteria, the UE shall reselect a cell ranked as the best cell among the cells meeting the criteria on the highest priority frequencies or the highest priority RAT if the highest priority RAT is E-UTRA according to criteria defined in 5.2.4.6.

[TS 36.304, clause 5.2.4.6]

The cell-ranking criterion R_s for serving cell and R_n for neighbouring cells is defined by:

$R_s = Q_{\text{meas},s} + Q_{\text{Hyst}}$
$R_n = Q_{\text{meas},n} - Q_{\text{offset}}$

where:

Q_{meas}	RSRP measurement quantity used in cell reselections.
Q_{offset}	For intra-frequency: Equals to $Q_{\text{offset}_{s,n}}$, if $Q_{\text{offset}_{s,n}}$ is valid, otherwise this equals to zero. For inter-frequency: Equals to $Q_{\text{offset}_{s,n}}$ plus $Q_{\text{offset}_{\text{frequency}}}$, if $Q_{\text{offset}_{s,n}}$ is valid, otherwise this equals to $Q_{\text{offset}_{\text{frequency}}}$.

The UE shall perform ranking of all cells that fulfil the cell selection criterion S, which is defined in 5.2.3.2, but may exclude all CSG cells that are known by the UE to be not allowed.

The cells shall be ranked according to the R criteria specified above, deriving $Q_{meas,n}$ and $Q_{meas,s}$ and calculating the R values using averaged RSRP results.

If a cell is ranked as the best cell the UE shall perform cell re-selection to that cell.

...

In all cases, the UE shall reselect the new cell, only if the following conditions are met:

- the new cell is better ranked than the serving cell during a time interval $T_{reselection,RAT}$,
- more than 1 second has elapsed since the UE camped on the current serving cell.

[TS 36.331, clause 6.3.1]

The IE *SystemInformationBlockType3* contains cell re-selection information common for intra-frequency, inter-frequency and/ or inter-RAT cell re-selection (i.e. applicable for more than one type of cell re-selection but not necessarily all) as well as intra-frequency cell re-selection information other than neighbouring cell related.

[TS 36.133, clause 4.2.2.4]

...

The UE shall be able to evaluate whether a newly detectable inter-frequency cell meets the reselection criteria defined in TS36.304 within $K_{carrier} * T_{detect,EUTRAN_Inter}$ if at least carrier frequency information is provided for inter-frequency neighbour cells by the serving cells when $T_{reselection} = 0$ provided that the reselection criteria is met by a margin of at least 5dB for reselections based on ranking or 6dB for RSRP reselections based on absolute priorities or 4dB for RSRQ reselections based on absolute priorities.

6.1.2.13.3 Test description

6.1.2.13.3.1 Pre-test conditions

System Simulator:

- Cell 1, Cell 2 and Cell 3 have different tracking areas according to table 6.0.1-2.
- System information combination 3 as defined in TS 36.508 [18] clause 4.4.3.1 is used in E-UTRA cells.

UE:

None.

Preamble:

- The UE is in state Registered, Idle mode (state 2) on Cell 1(serving cell) according to [18].

6.1.2.13.3.2 Test procedure sequence

Table 6.1.2.13.3.2-1 illustrates the downlink power levels and other changing parameters to be applied for the cells at various time instants of the test execution. The exact instants on which these values shall be applied are described in the texts in this clause. Configurations marked "T1", "T2" and "T3" are applied at the points indicated in the Main behaviour description in Table 6.1.2.13.3.2-2.

Table 6.1.2.13.3.2-1: Time instances of cell power level and parameter change

	Parameter	Unit	Cell 1	Cell 2	Cell 3	Remark
T1	Cell-specific RS EPRE	dBm/15kHz	-91	-79	"Off"	Srxlev of Cell 1 is less than $S_{intra\text{search}}$.
	$Q_{rxlevmin}$	dBm	-106	-106	-106	
	$S_{intra\text{search}}$	dB	22	22	22	
T2	Cell-specific RS EPRE	dBm/15kHz	"Off"	-97	-79	Srxlev of Cell 2 is less than $S_{nonintra\text{search}}$.
	$S_{nonintra\text{search}}$	dB	16	16	16	
T3	Cell-specific RS EPRE	dBm/15kHz	-85	"Off"	-79	Srxlev of Cell 3 is greater than $S_{nonintra\text{search}}$ but Cell 1 is high priority cell.

Note: Power level "Off" is defined in TS36.508 Table 6.2.2.1-1.

Table 6.1.2.13.3.2-2: Main behaviour

St	Procedure	Message Sequence		TP	Verdict
		U - S	Message		
1	The SS re-adjusts the cell-specific reference signal levels according to row "T1" in table 6.1.2.13.3.2-1.	-	-	-	-
2	Check: Does UE transmit an <i>RRCCoNNECTIONRequest</i> message on Cell 2?	-->	<i>RRCCoNNECTIONRequest</i>	1	P
3 - 7	Steps 2 to 6 of the generic test procedure in TS 36.508 subclause 6.4.2.7 are performed on Cell 2. NOTE: The UE performs a TAU procedure and the RRC connection is released.	-	-	-	-
8	The SS re-adjusts the cell-specific reference signal levels according to row "T2" in table 6.1.2.13.3.2-1.	-	-	-	-
9	Check: Does UE transmit an <i>RRCCoNNECTIONRequest</i> message on Cell 3?	-->	<i>RRCCoNNECTIONRequest</i>	2	P
10 - 14	Steps 2 to 6 of the generic test procedure in TS 36.508 subclause 6.4.2.7 are performed on Cell 3. NOTE: The UE performs a TAU procedure and the RRC connection is released.	-	-	-	-
15	The SS notifies the UE of change of System Information and changes the system information for Cell 3. The <i>systemInfoValueTag</i> in the <i>SystemInformationBlockType1</i> is increased.	<--	<i>Paging</i>	-	-
16	Wait for 15 s for the UE to receive system information.	-	-	-	-
16A	SS modifies SIB3 in Cell 1 and the <i>systemInfoValueTag</i> in the <i>SystemInformationBlockType1</i> is increased.	-	-	-	-
17	The SS re-adjusts the cell-specific reference signal levels according to row "T3" in table 6.1.2.13.3.2-1.	-	-	-	-
18	Check: Does the test result of steps 1 to 5 of the generic test procedure in TS 36.508 subclause 6.4.2.7 indicate that the UE is camped on E-UTRAN Cell 1? (Note1) NOTE: The UE performs a TAU procedure. Note: UE uses the new SIB3 modified in step 16A.	-	-	3	-

Note1: UE shall search higher priority layer (i.e. E-UTRA carrier frequency of Cell 1) at least every $(60 * N_{layers})$ seconds, where $N_{layers} = 1$ as specified in [4.2.2, 34].

6.1.2.13.3.3 Specific message contents

Table 6.1.2.13.3.3-1: Void**Table 6.1.2.13.3.3-2: SystemInformationBlockType3 for Cells 1, 2 and 3 (preamble and all steps, table 6.1.2.13.3.2-2)**

Derivation Path: 36.508 table 4.4.3.3-2			
Information Element	Value/remark	Comment	Condition
SystemInformationBlockType3 ::= SEQUENCE {			
cellReselectionServingFreqInfo SEQUENCE {			
s-NonIntraSearch	8 (16 dB)		
}			
intraFreqCellReselectionInfo SEQUENCE {			
s-IntraSearch	11 (22 dB)		
}			
}			

Table 6.1.2.13.3.3-3: SystemInformationBlockType1 for Cell 3 (step 15, Table 6.1.2.13.3.2-2)

Derivation Path: 36.508 table 4.4.3.2-3			
Information Element	Value/remark	Comment	Condition
SystemInformationBlockType1 ::= SEQUENCE {			
systemInfoValueTag	1	Previous value is 0	
}			

Table 6.1.2.13.3.3-4: SystemInformationBlockType5 for Cell 3 (step 15, Table 6.1.2.13.3.2-2)

Derivation path: 36.508 table 4.4.3.3-4			
Information Element	Value/Remark	Comment	Condition
SystemInformationBlockType5 ::= SEQUENCE {			
interFreqCarrierFreqList SEQUENCE (SIZE (1..maxFreq)) OF SEQUENCE {	1 entry		
dl-CarrierFreq[1]	EARFCN of Cell 1		
threshX-High[1]	5	10 dB	
cellReselectionPriority[1]	5		
}			
}			

Table 6.1.2.13.3.3-5: Paging (step 15, Table 6.1.2.13.3.2-2)

Derivation path: 36.508 Table 4.6.1-7			
Information Element	Value/Remark	Comment	Condition
Paging ::= SEQUENCE {			
pagingRecordList	Not present		
systemInfoModification	true		
etws-Indication	Not present		
nonCriticalExtension SEQUENCE {}	Not present		
}			

Table 6.1.2.13.3.3-6: SystemInformationBlockType3 for Cell 1 (step 16A, table 6.1.2.13.3.2-2)

Derivation Path: 36.508 table 4.4.3.3-2			
Information Element	Value/remark	Comment	Condition
SystemInformationBlockType3 ::= SEQUENCE {			
cellReselectionServingFreqInfo SEQUENCE {			
s-NonIntraSearch	8 (16 dB)		
cellReselectionPriority	5		
}			
intraFreqCellReselectionInfo SEQUENCE {			
s-IntraSearch	11 (22 dB)		
}			
}			

Table 6.1.2.13.3.3-7: SystemInformationBlockType1 for Cell 1 (step 16A, Table 6.1.2.13.3.2-2)

Derivation Path: 36.508 table 4.4.3.2-3			
Information Element	Value/remark	Comment	Condition
SystemInformationBlockType1 ::= SEQUENCE {			
systemInfoValueTag	1	Previous value is 0	
}			

6.1.2.14 Speed-dependent cell reselection

6.1.2.14.1 Test Purpose (TP)

(1)

```
with { UE in E-UTRA RRC_IDLE state and in high mobility state }
ensure that {
  when { UE detects the cell ranked as the best cell taking into account scaling factor }
  then { UE reselects the new cell }
}
```

6.1.2.14.2 Conformance requirements

References: The conformance requirements covered in the present TC are specified in: TS 36.304, clause 5.2.4.3 and 5.2.4.3.1. TS 36.133, clause 4.2.2.3.

[TS 36.304, clause 5.2.4.3]

Besides Normal-mobility state a High-mobility and a Medium-mobility state are applicable if the parameters (T_{CRmax} , N_{CR_H} , N_{CR_M} and $T_{CRmaxHyst}$) are sent in the system information broadcast of the serving cell.

State detection criteria:

...

High-mobility state criteria:

- If number of cell reselections during time period T_{CRmax} exceeds N_{CR_H}

The UE shall not count consecutive reselections between same two cells into mobility state detection criteria if same cell is reselected just after one other reselection.

State transitions:

The UE shall:

- if the criteria for High-mobility state is detected:
 - enter High-mobility state.

...

If the UE is in High- or Medium-mobility state, the UE shall apply the speed dependent scaling rules as defined in subclause 5.2.4.3.1.

[TS 36.304, clause 5.2.4.3.1]

UE shall apply the following scaling rules:

- If neither Medium- nor Highmobility state is detected:
 - no scaling is applied.
- If High-mobility state is detected:
 - Add the *sf-High* of "Speed dependent ScalingFactor for Q_{hyst} " to Q_{hyst} if sent on system information
 - For E-UTRAN cells multiply $\text{Treselection}_{\text{EUTRA}}$ by the *sf-High* of "Speed dependent ScalingFactor for $\text{Treselection}_{\text{EUTRA}}$ " if sent on system information
 - For UTRAN cells multiply $\text{Treselection}_{\text{UTRA}}$ by the *sf-High* of "Speed dependent ScalingFactor for $\text{Treselection}_{\text{UTRA}}$ " if sent on system information
 - For GERAN cells multiply $\text{Treselection}_{\text{GERA}}$ by the *sf-High* of "Speed dependent ScalingFactor for $\text{Treselection}_{\text{GERA}}$ state" if sent on system information
 - For CDMA2000 HRPD cells Multiply $\text{Treselection}_{\text{CDMA_HRPD}}$ by the *sf-High* of "Speed dependent ScalingFactor for $\text{Treselection}_{\text{CDMA_HRPD}}$ " if sent on system information
 - For CDMA2000 1xRTT cells Multiply $\text{Treselection}_{\text{CDMA_1xRTT}}$ by the *sf-High* of "Speed dependent ScalingFactor for $\text{Treselection}_{\text{CDMA_1xRTT}}$ " if sent on system information

...

In case scaling is applied to any $\text{Treselection}_{\text{RAT}}$ parameter the UE shall round up the result after all scalings to the nearest second.

[TS 36.133, clause 4.2.2.3]

The UE shall be able to identify new intra-frequency cells and perform RSRP and RSRQ measurements of identified intra-frequency cells without an explicit intra-frequency neighbour list containing physical layer cell identities.

The UE shall be able to evaluate whether a newly detectable intra-frequency cell meets the reselection criteria defined in TS36.304 within $T_{\text{detect,EUTRAN_Intra}}$ when that $\text{Treselection}=0$. An intra frequency cell is considered to be detectable according to RSRP, $\text{RSRP } \hat{E}_s/\text{Iot}$, SCH_RP and $\text{SCH } \hat{E}_s/\text{Iot}$ defined in Annex B.1.1 for a corresponding Band.

The UE shall measure RSRP and RSRQ at least every $T_{\text{measure,EUTRAN_Intra}}$ (see table 4.2.2.3-1) for intra-frequency cells that are identified and measured according to the measurement rules.

The UE shall filter RSRP and RSRQ measurements of each measured intra-frequency cell using at least 2 measurements. Within the set of measurements used for the filtering, at least two measurements shall be spaced by at least $T_{\text{measure,EUTRAN_Intra}}/2$

The UE shall not consider a E-UTRA neighbour cell in cell reselection, if it is indicated as not allowed in the measurement control system information of the serving cell.

For an intra-frequency cell that has been already detected, but that has not been reselected to, the filtering shall be such that the UE shall be capable of evaluating that the intra-frequency cell has met reselection criterion defined [1] within $T_{\text{evaluate,E-UTRAN_intra}}$ when $T_{\text{reselection}}=0$ as specified in table 4.2.2.3-1 provided that the cell is at least 3dB better ranked. When evaluating cells for reselection, the side conditions for RSRP and SCH apply to both serving and non-serving intra-frequency cells.

If $T_{\text{reselection}}$ timer has a non zero value and the intra-frequency cell is better ranked than the serving cell, the UE shall evaluate this intra-frequency cell for the $T_{\text{reselection}}$ time. If this cell remains better ranked within this duration, then the UE shall reselect that cell.

Table 4.2.2.3-1: $T_{\text{detect,EUTRAN_Intra}}$, $T_{\text{measure,EUTRAN_Intra}}$ and $T_{\text{evaluate,E-UTRAN_intra}}$

DRX cycle length [s]	$T_{\text{detect,EUTRAN_Intra}}$ [s] (number of DRX cycles)	$T_{\text{measure,EUTRAN_Intra}}$ [s] (number of DRX cycles)	$T_{\text{evaluate,E-UTRAN_intra}}$ [s] (number of DRX cycles)
0.32	11.52 (36)	1.28 (4)	5.12 (16)
0.64	17.92 (28)	1.28 (2)	5.12 (8)
1.28	32(25)	1.28 (1)	6.4 (5)
2.56	58.88 (23)	2.56 (1)	7.68 (3)

6.1.2.14.3 Test description

6.1.2.14.3.1 Pre-test conditions

System Simulator:

- Cell 1, Cell 2, and Cell 4.

UE:

None.

Preamble:

- The UE is in state Registered, Idle mode (state 2) on Cell 1 according to [18].

6.1.2.14.3.2 Test procedure sequence

Table 6.1.2.14.3.2-1: Time instances of cell power level and parameter changes

	Parameter	Unit	Cell 1	Cell 2	Cell 4	Remark
T1	Cell-specific RS EPRE	dBm/15kHz	-91	-85	-91	Cell 2 becomes the highest ranked cell.
T2	Cell-specific RS EPRE	dBm/15kHz	-91	-91	-85	Cell 4 becomes the highest ranked cell.
T3	Cell-specific RS EPRE	dBm/15kHz	-85	-91	-91	Cell 1 becomes the highest ranked cell.

Table 6.1.2.14.3.2-2: Main behaviour

St	Procedure	Message Sequence		TP	Verdict
		U - S	Message		
1	The SS changes the power level setting according to the row "T1" in table 6.1.2.14.3.2-1.	-	-	-	-
2	Wait for 40s for the UE to perform cell reselection procedure.(Note 1, Note 5)	-	-	-	-
3	The SS changes the power level setting according to the row "T2" in table 6.1.2.14.3.2-1.	-	-	-	-
4	Wait for 14s for the UE to perform cell reselection procedure.(Note 2, Note 6)	-	-	-	-
5	The SS changes the power level setting according to the row "T3" in table 6.1.2.14.3.2-1.	-	-	-	-
6	Wait for 14s for the UE to perform cell reselection procedure. (Note 3, Note 6)	-	-	-	-
7	The SS changes the power level setting according to the row "T1" in table 6.1.2.14.3.2-1.	-	-	-	-
8	Wait for 14s for the UE to perform cell reselection procedure. (Note 4, Note 6)	-	-	-	-
9	The SS changes the TAC for Cell 4 to 2.	-	-	-	-
10	The SS changes the power level setting according to the row "T2" in table 6.1.2.14.3.2-1.	-	-	-	-
11	Check: Does the UE send an <i>RRCConectionRequest</i> on Cell 4 within 2s? (Note 7)	-->	<i>RRCConectionRequest</i>	1	F
12	Check: Does the UE send an <i>RRCConectionRequest</i> on Cell 4 within 7s? (Note 8)	-->	<i>RRCConectionRequest</i>	1	P
13-17	Steps 2 to 6 of the generic test procedure in TS 36.508 subclause 6.4.2.7 are performed on Cell 4.	-	-	1	-
<p>Note 1: N_{CR} (number of cell reselection) is 1.</p> <p>Note 2: N_{CR} is 2.</p> <p>Note 3: N_{CR} is 3.</p> <p>Note 4: N_{CR} is 4 and the UE enters high mobility state because number of cell reselections during time period T_{CRmax} exceeds N_{CR_H}.</p> <p>Note 5: The wait time for reselection to a newly detected intra frequency cell is selected to cover $T_{detect,EUTRAN_intra}(25*1280ms=32s) + T_{reselection}(7s) + 320$ ms system information block type scheduling = 39.32s rounded up to 40s.</p> <p>Note 6: The wait time for reselection to an already detected intra frequency cell is selected to cover $T_{evaluate,E-UTRAN_intra}(6.4s) + T_{reselection}(7s) + 320$ ms system information block type scheduling = 13.72s rounded up to 14s.</p> <p>Note 7: The wait time for evaluating an intra-frequency cell is $T_{reselection}$ after scaling (2s) + 320 ms system information block type scheduling. This wait time is rounded down to nearest second (i.e. 2s in this case).</p> <p>Note 8: The wait time for cell reselection procedure is selected to cover $T_{evaluate,E-UTRAN_intra}(6.4s) + T_{reselection}$ after scaling ($7*0.25$) + 320 ms system information block type scheduling = 8.47s rounded up to 9s. The actual wait time is 7s which covers 9s - 2s (wait time in step 11).</p>					

6.1.2.14.3.3 Specific message contents

Table 6.1.2.14.3.3-1: SystemInformationBlockType1 for Cell 2, and Cell 4 (preamble, Table 6.1.2.14.3.2-2)

Derivation Path: 36.508 Table 4.4.3.2-3			
Information Element	Value/remark	Comment	Condition
SystemInformationBlockType1 ::= SEQUENCE {			
cellAccessRelatedInformation SEQUENCE {			
trackingAreaCode	1		
}			
}			

Table 6.1.2.14.3.3-2: SystemInformationBlockType3 for Cell 1, Cell 2, and Cell 4 (preamble and all steps, Table 6.1.2.14.3.2-2)

Derivation Path: 36.508, Table 4.4.3.3-2			
Information Element	Value/remark	Comment	Condition
SystemInformationBlockType3 ::= SEQUENCE {			
cellReselectionInfoCommon SEQUENCE {			
speedStateReselectionPars SEQUENCE {			
mobilityStateParameters SEQUENCE {			
t-Evaluation	s240		
t-HystNormal	s240		
n-CellChangeMedium	3		
n-CellChangeHigh	3		
}			
q-HystSF SEQUENCE {			
sf-Medium	dB0		
sf-High	dB0		
}			
}			
}			
intraFreqCellReselectionInfo SEQUENCE {			
t-ReselectionEUTRAN	7		
t-ReselectionEUTRA-SF SEQUENCE {			
sf-Medium	oDot25		
sf-High	oDot25		
}			
}			
}			

Table 6.1.2.14.3.3-3: SystemInformationBlockType1 for Cell 4 (step 9, Table 6.1.2.14.3.2-2)

Derivation Path: 36.508 Table 4.4.3.2-3			
Information Element	Value/remark	Comment	Condition
SystemInformationBlockType1 ::= SEQUENCE {			
cellAccessRelatedInformation SEQUENCE {			
trackingAreaCode	2		
}			
systemInfoValueTag	1		
}			

6.1.2.15 Inter-frequency cell reselection according to cell reselection priority provided by SIBs

6.1.2.15.1 Test Purpose (TP)

(1)

with { UE in E-UTRA RRC_IDLE state }
ensure that {

```

when { UE detects the cell re-selection criteria are met for the cell which belongs to the equal
priority frequency }
  then { UE reselects the cell which belongs to the equal priority frequency }
}

```

(2)

```

with { UE in E-UTRA RRC_IDLE state }
ensure that {
  when { UE detects the cell re-selection criteria are met for the cell which belongs to the higher
priority frequency }
    then { UE reselects the cell which belongs to the higher priority frequency }
}

```

(3)

```

with { UE in E-UTRA RRC_IDLE state }
ensure that {
  when { UE detects the cell re-selection criteria are met for the cell which belongs to the lower
priority frequency }
    then { UE reselects the cell which belongs to the lower priority frequency }
}

```

6.1.2.15.2 Conformance requirements

References: The conformance requirements covered in the present TC are specified in: TS 36.304, clause 5.2.4.1, 5.2.4.2, 5.2.4.5 and 5.2.4.6.

[TS 36.304, clause 5.2.4.1]

Absolute priorities of different E-UTRAN frequencies or inter-RAT frequencies may be provided to the UE in the system information, in the *RRConnectionRelease* message, or by inheriting from another RAT at inter-RAT cell (re)selection. In the case of system information, an E-UTRAN frequency or inter-RAT frequency may be listed without providing a priority (i.e. the field *cellReselectionPriority* is absent for that frequency). If priorities are provided in dedicated signalling, the UE shall ignore all the priorities provided in system information. If UE is in *camped on any cell* state, UE shall only apply the priorities provided by system information from current cell, and the UE preserves priorities provided by dedicated signalling unless specified otherwise. When the UE in *camped normally* state, has only dedicated priorities other than for the current frequency, the UE shall consider the current frequency to be the lowest priority frequency (i.e. lower than the eight network configured values). The UE shall delete priorities provided by dedicated signalling when:

- the UE enters RRC_CONNECTED state; or
- the optional validity time of dedicated priorities (T320) expires; or
- a PLMN selection is performed on request by NAS [5].

NOTE: Equal priorities between RATs are not supported.

The UE shall only perform cell reselection evaluation for E-UTRAN frequencies and inter-RAT frequencies that are given in system information and for which the UE has a priority provided.

The UE shall not consider any black listed cells as candidate for cell reselection.

The UE shall inherit the priorities provided by dedicated signalling and the remaining validity time (i.e., T320 in E-UTRA, T322 in UTRA and [T3230, FFS] in GERAN), if configured, at inter-RAT cell (re)selection.

NOTE: The network may assign dedicated cell reselection priorities for frequencies not configured by system information.

[TS 36.304, clause 5.2.4.2]

When evaluating for reselection purposes cell selection criterion or *SnonServingCell,x*, the UE shall use parameters provided by the serving cell.

Following rules are used by the UE to limit needed measurements:

- If $S_{\text{intrasearch}}$ is sent in the serving cell and $S_{\text{ServingCell}} > S_{\text{intrasearch}}$, UE may choose to not perform intra-frequency measurements.
- If $S_{\text{ServingCell}} \leq S_{\text{intrasearch}}$, or $S_{\text{intrasearch}}$ is not sent in the serving cell UE shall perform intra-frequency measurements.
- The UE shall apply the following rules for E-UTRAN inter-frequencies and inter-RAT frequencies which are indicated in system information and for which the UE has priority provided as defined in 5.2.4.1:
 - For an E-UTRAN inter-frequency or inter-RAT frequency with a reselection priority higher than the reselection priority of the current E-UTRA frequency the UE shall perform measurements of higher priority E-UTRAN inter-frequency or inter-RAT frequencies according to [10].
 - For an E-UTRAN inter-frequency with an equal or lower reselection priority than the reselection priority of the current E-UTRA frequency and for inter-RAT frequency with lower reselection priority than the reselection priority of the current E-UTRAN frequency:
 - If $S_{\text{nonintrasearch}}$ is sent in the serving cell and $S_{\text{ServingCell}} > S_{\text{nonintrasearch}}$ UE may choose not to perform measurements of E-UTRAN inter-frequencies or inter-RAT frequency cells of equal or lower priority.
 - If $S_{\text{ServingCell}} \leq S_{\text{nonintrasearch}}$ or $S_{\text{nonintrasearch}}$ is not sent in the serving cell the UE shall perform measurements of E-UTRAN inter-frequencies or inter-RAT frequency cells of equal or lower priority according to [10].

Where $S_{\text{ServingCell}}$ is the S_{rxlev} -value of the serving cell.

[TS 36.304, clause 5.2.4.5]

Criteria 1: the $S_{\text{nonServingCell},x}$ of a cell on evaluated frequency is greater than $\text{Thresh}_{x, \text{high}}$ during a time interval $\text{Treselection}_{\text{RAT}}$;

Cell reselection to a cell on a higher priority E-UTRAN frequency or inter-RAT frequency than serving frequency shall be performed if:

- A cell of a higher priority E-UTRAN frequency or inter-RAT frequency fulfils criteria 1; and
- more than 1 second has elapsed since the UE camped on the current serving cell.

Cell reselection to a cell on a lower priority E-UTRAN frequency or inter-RAT frequency than serving frequency shall be performed if:

- No cell on a higher priority E-UTRAN frequency or inter-RAT frequency than serving frequency fulfils the criteria 1; and
- No cell on serving frequency or on an equal priority E-UTRAN frequency fulfils the criteria in 5.2.4.6; and
- $S_{\text{ServingCell}} < \text{Thresh}_{\text{erving, low}}$ and the $S_{\text{nonServingCell},x}$ of a cell of a lower priority E-UTRAN frequency or inter-RAT frequency is greater than $\text{Thresh}_{x, \text{low}}$ during a time interval $\text{Treselection}_{\text{RAT}}$; and
- more than 1 second has elapsed since the UE camped on the current serving cell.

or if:

- there are no candidate cells for reselection on serving frequency according to 5.2.4.4 or 5.3.1.

Cell reselection to a cell on an equal priority E-UTRAN frequency shall be based on ranking for Intra-frequency cell reselection as defined in sub-clause 5.2.4.6.

For GERAN, UTRAN, and E-UTRAN, $S_{\text{nonServingCell},x}$ is the S_{rxlev} -value of an evaluated cell. For UTRAN FDD, S_{qual} is higher than 0, as defined in [8]. For cdma2000 RATs, $S_{\text{nonServingCell},x}$ is equal to $\text{FLOOR}(-2 \times 10 \times \log_{10} \text{Ec/Io})$ in units of 0.5 dB, as defined in [18], with Ec/Io referring to the value measured from the evaluated cell.

In all the above criteria the value of $\text{Treselection}_{\text{RAT}}$ is scaled when the UE is in the medium or high mobility state as defined in subclause 5.2.4.3.1. If more than one cell meets the above criteria, the UE shall reselect a cell ranked as the best cell among the cells meeting the criteria on the highest priority frequencies or the highest priority RAT if the highest priority RAT is E-UTRA according to criteria defined in 5.2.4.6.

[TS 36.304, clause 5.2.4.6]

The cell-ranking criterion R_s for serving cell and R_n for neighbouring cells is defined by:

$$R_s = Q_{\text{meas},s} + Q_{\text{hyst}_s}$$

$$R_n = Q_{\text{meas},n} - Q_{\text{offset}}$$

where:

Q_{meas}	RSRP measurement quantity used in cell reselections.
Q_{offset}	For intra-frequency: Equals to $Q_{\text{offset}_{s,n}}$, if $Q_{\text{offset}_{s,n}}$ is valid, otherwise this equals to zero. For inter-frequency: Equals to $Q_{\text{offset}_{s,n}}$ plus $Q_{\text{offset}_{\text{frequency}}}$, if $Q_{\text{offset}_{s,n}}$ is valid, otherwise this equals to $Q_{\text{offset}_{\text{frequency}}}$.

The UE shall perform ranking of all cells that fulfil the cell selection criterion S , which is defined in 5.2.3.2, but may exclude all CSG cells that are known by the UE to be not allowed.

The cells shall be ranked according to the R criteria specified above, deriving $Q_{\text{meas},n}$ and $Q_{\text{meas},s}$ and calculating the R values using averaged RSRP results.

If a cell is ranked as the best cell the UE shall perform cell re-selection to that cell. If this cell is found to be not-suitable, the UE shall behave according to subclause 5.2.4.4.

In all cases, the UE shall reselect the new cell, only if the following conditions are met:

- the new cell is better ranked than the serving cell during a time interval $T_{\text{reselection}_{\text{RAT}}}$;
- more than 1 second has elapsed since the UE camped on the current serving cell.

6.1.2.15.3 Test description

6.1.2.15.3.1 Pre-test conditions

System Simulator:

- Cell 1, Cell 3 and Cell 6.
- System information combination 3 as defined in TS 36.508 [18] clause 4.4.3.1 is used in E-UTRA cells.

UE:

None.

Preamble:

- The UE is in state Registered, Idle mode (state 2) on Cell 1 (serving cell) according to [18].

6.1.2.15.3.2 Test procedure sequence

Table 6.1.2.15.3.2-1 illustrates the downlink power levels and other changing parameters to be applied for the cells at various time instants of the test execution. Subsequent configurations marked "T1", "T2" and "T3" are applied at the points indicated in the Main behaviour description in Table 6.1.2.15.3.2-2.

Table 6.1.2.15.3.2-1: Time instances of cell power level and parameter changes

	Parameter	Unit	Cell 1	Cell 3	Cell 6	Remark
T1	Cell-specific RS EPRE	dBm/ 15kHz z	-85	-73	"Off"	The power level values are assigned to satisfy $R_{Cell\ 1} < R_{Cell\ 3}$. (NOTE 1).
T2	Cell-specific RS EPRE	dBm/ 15kHz z	"Off"	-73	-73	The power level values are assigned to satisfy $Srxlev_{Cell\ 1} < 0$ and $Srxlev_{Cell\ 6} > Thresh_{Cell\ 6, high}$. (NOTE 1).
T3	Cell-specific RS EPRE	dBm/ 15kHz z	"Off"	-73	-95	The power level values are assigned to satisfy $Srxlev_{Cell\ 6} < Thresh_{serving, low}$ and $Srxlev_{Cell\ 3} > Thresh_{Cell\ 3, low}$, $Srxlev_{Cell\ 1} < 0$. (NOTE 1).
NOTE 1: Power level "Off" is defined in TS36.508 Table 6.2.2.1-1.						

Table 6.1.2.15.3.2-2: Main behaviour

St	Procedure	Message Sequence		TP	Verdict
		U - S	Message		
1	The SS changes Cell 3 power level according to the row "T1" in table 6.1.2.15.3.2-1.	-	-	-	-
2	Check: Does the test result of generic test procedure in TS 36.508 subclause 6.4.2.7 indicate that the UE is camped on E-UTRAN Cell 3?	-	-	1	-
3	The SS changes Cell 1 and Cell 6 power level according to the row "T2" in table 6.1.2.15.3.2-1.	-	-	-	-
4	Check: Does the test result of generic test procedure in TS 36.508 subclause 6.4.2.7 indicate that the UE is camped on E-UTRAN Cell 6?	-	-	2	-
5	The SS changes Cell 6 power level according to the row "T3" in table 6.1.2.15.3.2-1.	-	-	-	-
6	Check: Does the test result of generic test procedure in TS 36.508 subclause 6.4.2.7 indicate that the UE is camped on E-UTRAN Cell 3?	-	-	3	-

6.1.2.15.3.3 Specific message contents

Table 6.1.2.15.3.3-1: Void**Table 6.1.2.15.3.3-2: Void****Table 6.1.2.15.3.3-3: SystemInformationBlockType3 for Cell 6 (preamble and all steps, Table 6.1.2.15.3.2-2)**

Derivation path: 36.508 table 4.4.3.3-2			
Information Element	Value/Remark	Comment	Condition
SystemInformationBlockType3 ::= SEQUENCE {			
cellReselectionServingFreqInfo SEQUENCE {			
threshServingLow	10	20 dB	
cellReselectionPriority	5		
}			
}			

Table 6.1.2.15.3.3-4: SystemInformationBlockType5 for Cell 1 (preamble and all steps, Table 6.1.2.15.3.2-2)

Derivation path: 36.508 table 4.4.3.3-4			
Information Element	Value/Remark	Comment	Condition
SystemInformationBlockType5 ::= SEQUENCE {			
interFreqCarrierFreqList SEQUENCE (SIZE (1..maxFreq)) OF SEQUENCE {			
dl-CarrierFreq[0]	EARFCN of Cell 6		
threshX-High[0]	10	20 dB	
cellReselectionPriority[0]	5		
dl-CarrierFreq[1]	EARFCN of Cell 3		
threshX-High[1]	10	20 dB	
cellReselectionPriority[1]	4		
}			
}			

Table 6.1.2.15.3.3-5: SystemInformationBlockType5 for Cell 3 (preamble and all steps, Table 6.1.2.15.3.2-2)

Derivation path: 36.508 table 4.4.3.3-4			
Information Element	Value/Remark	Comment	Condition
SystemInformationBlockType5 ::= SEQUENCE {			
interFreqCarrierFreqList SEQUENCE (SIZE (1..maxFreq)) OF SEQUENCE {			
dl-CarrierFreq[n]	EARFCN of Cell 6		
threshX-High[n]	10	20 dB	
cellReselectionPriority[n]	5		
}			
}			

6.1.2.15a Inter-frequency cell reselection according to cell reselection priority provided by SIBs / Between FDD and TDD

6.1.2.15a.1 Test Purpose (TP)

(1)

```
with { UE in E-UTRA RRC_IDLE state in FDD mode}
ensure that {
  when { UE detects the cell re-selection criteria are met for the cell which belongs to the equal
priority TDD frequency }
  then { UE reselects the cell which belongs to the equal priority TDD frequency }
}
```

(2)

```
with { UE in E-UTRA RRC_IDLE state in TDD mode}
ensure that {
  when { UE detects the cell re-selection criteria are met for the cell which belongs to the higher
priority FDD frequency }
  then { UE reselects the cell which belongs to the higher priority FDD frequency }
}
```

(3)

```
with { UE in E-UTRA RRC_IDLE state in FDD mode}
ensure that {
  when { UE detects the cell re-selection criteria are met for the cell which belongs to the lower
priority TDD frequency }
  then { UE reselects the cell which belongs to the lower priority TDD frequency }
}
```

6.1.2.15a.2 Conformance requirements

References: The conformance requirements covered in the present TC are specified in: TS 36.304, clause 5.2.4.1, 5.2.4.2, 5.2.4.5 and 5.2.4.6.

[TS 36.304, clause 5.2.4.1]

Absolute priorities of different E-UTRAN frequencies or inter-RAT frequencies may be provided to the UE in the system information, in the *RRCConnectionRelease* message, or by inheriting from another RAT at inter-RAT cell (re)selection. In the case of system information, an E-UTRAN frequency or inter-RAT frequency may be listed without providing a priority (i.e. the field *cellReselectionPriority* is absent for that frequency). If priorities are provided in dedicated signalling, the UE shall ignore all the priorities provided in system information. If UE is in *camped on any cell* state, UE shall only apply the priorities provided by system information from current cell, and the UE preserves priorities provided by dedicated signalling unless specified otherwise. When the UE in *camped normally* state, has only dedicated priorities other than for the current frequency, the UE shall consider the current frequency to be the lowest priority frequency (i.e. lower than the eight network configured values). The UE shall delete priorities provided by dedicated signalling when:

- the UE enters RRC_CONNECTED state; or
- the optional validity time of dedicated priorities (T320) expires; or
- a PLMN selection is performed on request by NAS [5].

NOTE: Equal priorities between RATs are not supported.

The UE shall only perform cell reselection evaluation for E-UTRAN frequencies and inter-RAT frequencies that are given in system information and for which the UE has a priority provided.

The UE shall not consider any black listed cells as candidate for cell reselection.

The UE shall inherit the priorities provided by dedicated signalling and the remaining validity time (i.e., T320 in E-UTRA, T322 in UTRA and [T3230, FFS] in GERAN), if configured, at inter-RAT cell (re)selection.

NOTE: The network may assign dedicated cell reselection priorities for frequencies not configured by system information.

[TS 36.304, clause 5.2.4.2]

When evaluating for reselection purposes cell selection criterion or $S_{\text{nonServingCell},x}$, the UE shall use parameters provided by the serving cell.

Following rules are used by the UE to limit needed measurements:

- If $S_{\text{intraSearch}}$ is sent in the serving cell and $S_{\text{ServingCell}} > S_{\text{intraSearch}}$, UE may choose to not perform intra-frequency measurements.
- If $S_{\text{ServingCell}} \leq S_{\text{intraSearch}}$, or $S_{\text{intraSearch}}$ is not sent in the serving cell UE shall perform intra-frequency measurements.
- The UE shall apply the following rules for E-UTRAN inter-frequencies and inter-RAT frequencies which are indicated in system information and for which the UE has priority provided as defined in 5.2.4.1:
 - For an E-UTRAN inter-frequency or inter-RAT frequency with a reselection priority higher than the reselection priority of the current E-UTRA frequency the UE shall perform measurements of higher priority E-UTRAN inter-frequency or inter-RAT frequencies according to [10].
 - For an E-UTRAN inter-frequency with an equal or lower reselection priority than the reselection priority of the current E-UTRA frequency and for inter-RAT frequency with lower reselection priority than the reselection priority of the current E-UTRAN frequency:
 - If $S_{\text{nonIntraSearch}}$ is sent in the serving cell and $S_{\text{ServingCell}} > S_{\text{nonIntraSearch}}$ UE may choose not to perform measurements of E-UTRAN inter-frequencies or inter-RAT frequency cells of equal or lower priority.

- If $S_{\text{ServingCell}} \leq S_{\text{nonintra}} \text{ or } S_{\text{nonintra}}$ is not sent in the serving cell the UE shall perform measurements of E-UTRAN inter-frequencies or inter-RAT frequency cells of equal or lower priority according to [10].

Where $S_{\text{ServingCell}}$ is the S_{rxlev} -value of the serving cell.

[TS 36.304, clause 5.2.4.5]

Criteria 1: the $S_{\text{nonServingCell},x}$ of a cell on evaluated frequency is greater than $\text{Thresh}_{x, \text{high}}$ during a time interval $\text{Treselection}_{\text{RAT}}$;

Cell reselection to a cell on a higher priority E-UTRAN frequency or inter-RAT frequency than serving frequency shall be performed if:

- A cell of a higher priority E-UTRAN frequency or inter-RAT frequency fulfils criteria 1; and
- more than 1 second has elapsed since the UE camped on the current serving cell.

Cell reselection to a cell on a lower priority E-UTRAN frequency or inter-RAT frequency than serving frequency shall be performed if:

- No cell on a higher priority E-UTRAN frequency or inter-RAT frequency than serving frequency fulfils the criteria 1; and
- No cell on serving frequency or on an equal priority E-UTRAN frequency fulfils the criteria in 5.2.4.6; and
- $S_{\text{ServingCell}} < \text{Thresh}_{\text{Serving}, \text{low}}$ and the $S_{\text{nonServingCell},x}$ of a cell of a lower priority E-UTRAN frequency or inter-RAT frequency is greater than $\text{Thresh}_{x, \text{low}}$ during a time interval $\text{Treselection}_{\text{RAT}}$; and
- more than 1 second has elapsed since the UE camped on the current serving cell.

or if:

- there are no candidate cells for reselection on serving frequency according to 5.2.4.4 or 5.3.1.

Cell reselection to a cell on an equal priority E-UTRAN frequency shall be based on ranking for Intra-frequency cell reselection as defined in sub-clause 5.2.4.6.

For GERAN, UTRAN, and E-UTRAN, $S_{\text{nonServingCell},x}$ is the S_{rxlev} -value of an evaluated cell. For UTRAN FDD, S_{qual} is higher than 0, as defined in [8]. For cdma2000 RATs, $S_{\text{nonServingCell},x}$ is equal to $\text{FLOOR}(-2 \times 10 \times \log_{10} E_c/I_o)$ in units of 0.5 dB, as defined in [18], with E_c/I_o referring to the value measured from the evaluated cell.

In all the above criteria the value of $\text{Treselection}_{\text{RAT}}$ is scaled when the UE is in the medium or high mobility state as defined in subclause 5.2.4.3.1. If more than one cell meets the above criteria, the UE shall reselect a cell ranked as the best cell among the cells meeting the criteria on the highest priority frequencies or the highest priority RAT if the highest priority RAT is E-UTRA according to criteria defined in 5.2.4.6.

[TS 36.304, clause 5.2.4.6]

The cell-ranking criterion R_s for serving cell and R_n for neighbouring cells is defined by:

$$R_s = Q_{\text{meas},s} + Q_{\text{hyst},s}$$

$$R_n = Q_{\text{meas},n} - Q_{\text{offset}}$$

where:

Q_{meas}	RSRP measurement quantity used in cell reselections.
Q_{offset}	For intra-frequency: Equals to $Q_{\text{offset},n}$, if $Q_{\text{offset},n}$ is valid, otherwise this equals to zero. For inter-frequency: Equals to $Q_{\text{offset},s,n}$ plus $Q_{\text{offset}_{\text{frequency}}}$, if $Q_{\text{offset},s,n}$ is valid, otherwise this equals to $Q_{\text{offset}_{\text{frequency}}}$.

The UE shall perform ranking of all cells that fulfil the cell selection criterion S , which is defined in 5.2.3.2, but may exclude all CSG cells that are known by the UE to be not allowed.

The cells shall be ranked according to the R criteria specified above, deriving $Q_{meas,n}$ and $Q_{meas,s}$ and calculating the R values using averaged RSRP results.

If a cell is ranked as the best cell the UE shall perform cell re-selection to that cell. If this cell is found to be not-suitable, the UE shall behave according to subclause 5.2.4.4.

In all cases, the UE shall reselect the new cell, only if the following conditions are met:

- the new cell is better ranked than the serving cell during a time interval $T_{reselection_{RAT}}$;
- more than 1 second has elapsed since the UE camped on the current serving cell.

6.1.2.15a.3 Test description

6.1.2.15a.3.1 Pre-test conditions

System Simulator:

- Cell 1, Cell 10 and Cell 3 have different tracking areas according to table 6.0.1-2.
- Cell 1 and Cell 3 are set to LTE-FDD mode and Cell 10 is set to LTE-TDD mode.
- System information combination 3 as defined in TS 36.508 [18] clause 4.4.3.1 and Table 6.3.1.2-2 is used in E-UTRA cells.

UE:

None.

Preamble:

- The UE is in state Registered, Idle mode (state 2) on Cell 1 (serving cell) according to [18].

6.1.2.15a.3.2 Test procedure sequence

Table 6.1.2.15a.3.2-1 illustrates the downlink power levels and other changing parameters to be applied for the cells at various time instants of the test execution. Subsequent configurations marked "T1", "T2" and "T3" are applied at the points indicated in the Main behaviour description in Table 6.1.2.15a.3.2-2.

Table 6.1.2.15a.3.2-1: Time instances of cell power level and parameter changes

	Parameter	Unit	Cell 1	Cell 10	Cell 3	Remark
T1	Cell-specific RS EPRE	dBm/15kHz	-85	-73	"Off"	The power level values are assigned to satisfy $R_{Cell\ 1} < R_{Cell\ 10}$. (NOTE 1).
T2	Cell-specific RS EPRE	dBm/15kHz	"Off"	-73	-73	The power level values are assigned to satisfy $Srxlev_{Cell\ 1} < 0$ and $Srxlev_{Cell\ 3} > Thresh_{Cell\ 10, high}$. (NOTE 1).
T3	Cell-specific RS EPRE	dBm/15kHz	"Off"	-73	-95	The power level values are assigned to satisfy $Srxlev_{Cell\ 3} < Thresh_{serving, low}$ and $Srxlev_{Cell\ 10} > Thresh_{Cell\ 3, low}$, $Srxlev_{Cell\ 1} < 0$. (NOTE 1).

Note 1: Power level "Off" is defined in TS36.508 Table 6.2.2.1-1.

Table 6.1.2.15a.3.2-2: Main behaviour

St	Procedure	Message Sequence		TP	Verdict
		U - S	Message		
1	The SS changes Cell 10 power level according to the row "T1" in table 6.1.2.15a.3.2-1.	-	-	-	-
2	Check: Does the test result of generic test procedure in TS 36.508 subclause 6.4.2.7 indicate that the UE is camped on E-UTRAN Cell 10?	-	-	1	P
3	The SS changes Cell 1 and Cell 3 power level according to the row "T2" in table 6.1.2.15a.3.2-1.	-	-	-	-
4	Check: Does the test result of generic test procedure in TS 36.508 subclause 6.4.2.7 indicate that the UE is camped on E-UTRAN Cell 3?	-	-	2	P
5	The SS changes Cell 3 power level according to the row "T3" in table 6.1.2.15a.3.2-1.	-	-	-	-
6	Check: Does the test result of generic test procedure in TS 36.508 subclause 6.4.2.7 indicate that the UE is camped on E-UTRAN Cell 10?	-	-	3	P

6.1.2.15a.3.3 Specific message contents

Table 6.1.2.15a.3.3-1: *SystemInformationBlockType3* for Cell 3 (preamble and all steps, Table 6.1.2.15a.3.2-2)

Derivation path: 36.508 table 4.4.3.3-2			
Information Element	Value/Remark	Comment	Condition
<i>SystemInformationBlockType3</i> ::= SEQUENCE {			
<i>cellReselectionServingFreqInfo</i> SEQUENCE {			
<i>threshServingLow</i>	10	20 dB	
<i>cellReselectionPriority</i>	5		
}			
}			

Table 6.1.2.15a.3.3-2: *SystemInformationBlockType5* for Cell 1 (preamble and all steps, Table 6.1.2.15a.3.2-2)

Derivation path: 36.508 table 4.4.3.3-4			
Information Element	Value/Remark	Comment	Condition
<i>SystemInformationBlockType5</i> ::= SEQUENCE {			
<i>interFreqCarrierFreqList</i> SEQUENCE (SIZE (1.. <i>maxFreq</i>)) OF SEQUENCE {			
<i>dl-CarrierFreq</i> [0]	EARFCN of Cell 3		
<i>threshX-High</i> [0]	10	20 dB	
<i>cellReselectionPriority</i> [0]	5		
<i>dl-CarrierFreq</i> [1]	EARFCN of Cell 10		
<i>threshX-High</i> [1]	10	20 dB	
<i>cellReselectionPriority</i> [1]	4		
}			
}			

Table 6.1.2.15a.3.3-3: SystemInformationBlockType5 for Cell 10 (preamble and all steps, Table 6.1.2.15a.3.2-2)

Derivation path: 36.508 table 4.4.3.3-4			
Information Element	Value/Remark	Comment	Condition
SystemInformationBlockType5 ::= SEQUENCE {			
interFreqCarrierFreqList SEQUENCE (SIZE (1..maxFreq)) OF SEQUENCE {			
dl-CarrierFreq[n]	EARFCN of Cell 3		
threshX-High[n]	10	20 dB	
cellReselectionPriority[n]	5		
}			
}			

6.1.2.15b Inter-band cell reselection according to cell reselection priority provided by SIBs

6.1.2.15b.1 Test Purpose (TP)

Same Test Purposes as in clause 6.1.2.15.1

6.1.2.15b.2 Conformance requirements

Same Conformance requirements as in clause 6.1.2.15.2

6.1.2.15b.3 Test description

6.1.2.15b.3.1 Pre-test conditions

System Simulator:

- Cell 1, cell 10 and 'If (px_SinglePLMN_Tested = Multi PLMN in primary band)' Cell 3 'ELSE If (px_SinglePLMN_Tested = Multi PLMN in Secondary band)' Cell 28.
- System information combination 3 as defined in TS 36.508 [18] clause 4.4.3.1 is used in E-UTRA cells.

UE:

None.

Preamble:

- The UE is in state Registered, Idle mode (state 2) on Cell 1 (serving cell) according to [18].

6.1.2.15b.3.2 Test procedure sequence

Table 6.1.2.15b.3.2-1 illustrates the downlink power levels and other changing parameters to be applied for the cells at various time instants of the test execution. Subsequent configurations marked "T1", "T2" and "T3" are applied at the points indicated in the Main behaviour description in Table 6.1.2.15b.3.2-2.

Table 6.1.2.15b.3.2-1: Time instances of cell power level and parameter changes

	Parameter	Unit	Cell 1	Cell 3 or Cell 28 (If Present)	Cell 10	Remark
T1	Cell-specific RS EPRE	dBm/15kHz	-85	-73	"Off"	The power level values are assigned to satisfy $R_{Cell 1} < R_{Cell 3 \text{ or } 28}$ (NOTE 1).
T2	Cell-specific RS EPRE	dBm/15kHz	"Off"	-73	-73	The power level values are assigned to satisfy $Srxlev_{Cell 1} < 0$ and $Srxlev_{Cell 10} > Thresh_{Cell 10, high}$ (NOTE 1).
T3	Cell-specific RS EPRE	dBm/15kHz	-73	"Off"	-95	The power level values are assigned to satisfy $Srxlev_{Cell 10} < Thresh_{serving, low}$ and $Srxlev_{Cell 1} > Thresh_{Cell 1, low}$, $Srxlev_{Cell 3 \text{ or } 28} < 0$. (NOTE 1).

NOTE 1: Power level "Off" is defined in TS36.508 Table 6.2.2.1-1.

Table 6.1.2.15b.3.2-2: Main behaviour

St	Procedure	Message Sequence		TP	Verdict
		U - S	Message		
-	Exception: Steps 1a1 and 1a2 are executed if cell 3 or cell 28 are configured	-	-	-	-
1a1	The SS changes Cell 3/ Cell 28 power level according to the row "T1" in table 6.1.2.15b.3.2-1.	-	-	-	-
1a2	Check: Does the test result of generic test procedure in TS 36.508 subclause 6.4.2.7 indicate that the UE is camped on E-UTRAN Cell 3/ Cell 28 (if present)?	-	-	1	-
2	The SS changes Cell 1 and Cell10 power level according to the row "T2" in table 6.1.2.15b.3.2-1.	-	-	-	-
3	Check: Does the test result of generic test procedure in TS 36.508 subclause 6.4.2.7 indicate that the UE is camped on E-UTRAN Cell 10?	-	-	2	-
4	The SS changes Cell 10 and cell 1 power level according to the row "T3" in table 6.1.2.15b.3.2-1.	-	-	-	-
5	Check: Does the test result of generic test procedure in TS 36.508 subclause 6.4.2.7 indicate that the UE is camped on E-UTRAN Cell 1?	-	-	3	-

6.1.2.15b.3.3 Specific message contents

Table 6.1.2.15b.3.3-1: SystemInformationBlockType3 for Cell 10 (preamble and all steps, Table 6.1.2.15b.3.2-2)

Derivation path: 36.508 table 4.4.3.3-2			
Information Element	Value/Remark	Comment	Condition
SystemInformationBlockType3 ::= SEQUENCE {			
cellReselectionServingFreqInfo SEQUENCE {			
threshServingLow	10	20 dB	
cellReselectionPriority	5		
}			
}			

Table 6.1.2.15b.3.3-2: SystemInformationBlockType5 for Cell 1 (preamble and all steps, Table 6.1.2.15b.3.2-2)

Derivation path: 36.508 table 4.4.3.3-4			
Information Element	Value/Remark	Comment	Condition
SystemInformationBlockType5 ::= SEQUENCE {			
interFreqCarrierFreqList SEQUENCE (SIZE (1..maxFreq)) OF SEQUENCE {			
dl-CarrierFreq[0]	EARFCN of Cell 10		
threshX-High[0]	10	20 dB	
cellReselectionPriority[0]	5		
dl-CarrierFreq[1]	EARFCN of Cell 3/Cell 28		
threshX-High[1]	10	20 dB	
cellReselectionPriority[1]	4		
}			
}			

Table 6.1.2.15b.3.3-3: SystemInformationBlockType5 for Cell 3/Cell 28 (preamble and all steps, Table 6.1.2.15b.3.2-2)

Derivation path: 36.508 table 4.4.3.3-4			
Information Element	Value/Remark	Comment	Condition
SystemInformationBlockType5 ::= SEQUENCE {			
interFreqCarrierFreqList SEQUENCE (SIZE (1..maxFreq)) OF SEQUENCE {			
dl-CarrierFreq[n]	EARFCN of Cell 10		
threshX-High[n]	10	20 dB	
cellReselectionPriority[n]	5		
}			
}			

6.1.2.16 Cell reselection / interband operation / Between FDD and TDD

6.1.2.16.1 Test Purpose (TP)

(1)

```
with { UE in E-UTRA RRC_IDLE state in FDD mode }
ensure that {
  when { UE detects the cell re-selection criteria are met for the cell on the different TDD
frequency band }
  then { UE reselects the new cell }
}
```

(2)

```
with { UE in E-UTRA RRC_IDLE state in TDD mode }
ensure that {
  when { UE detects the cell re-selection criteria are met for the cell on the different FDD
frequency band }
  then { UE reselects the new cell }
}
```

6.1.2.16.2 Conformance requirements

References: The conformance requirements covered in the present TC are specified in: TS 36.304, clause 5.2.4.1, 5.2.4.2 and 5.2.4.5.

[TS 36.304, clause 5.2.4.1]

Absolute priorities of different E-UTRAN frequencies or inter-RAT frequencies may be provided to the UE in the system information, in the *RRCConnectionRelease* message, or by inheriting from another RAT at inter-RAT cell (re)selection. In the case of system information, an E-UTRAN frequency or inter-RAT frequency may be listed without providing a priority (i.e. the field *cellReselectionPriority* is absent for that frequency). If priorities are provided in

dedicated signalling, the UE shall ignore all the priorities provided in system information. If UE is in *camped on any cell* state, UE shall only apply the priorities provided by system information from current cell, and the UE preserves priorities provided by dedicated signalling unless specified otherwise. When the UE in *camped normally* state, has only dedicated priorities other than for the current frequency, the UE shall consider the current frequency to be the lowest priority frequency (i.e. lower than the eight network configured values). While the UE is camped on a suitable CSG cell, the UE shall always consider the current frequency to be the highest priority frequency (i.e. higher than the eight network configured values), irrespective of any other priority value allocated to this frequency. The UE shall delete priorities provided by dedicated signalling when:

- the UE enters RRC_CONNECTED state; or
- the optional validity time of dedicated priorities (T320) expires; or
- a PLMN selection is performed on request by NAS [5].

NOTE: Equal priorities between RATs are not supported.

The UE shall only perform cell reselection evaluation for E-UTRAN frequencies and inter-RAT frequencies that are given in system information and for which the UE has a priority provided.

The UE shall not consider any black listed cells as candidate for cell reselection.

The UE shall inherit the priorities provided by dedicated signalling and the remaining validity time (i.e., T320 in E-UTRA, T322 in UTRA and T3230 in GERAN), if configured, at inter-RAT cell (re)selection.

NOTE: The network may assign dedicated cell reselection priorities for frequencies not configured by system information.

[TS 36.304, clause 5.2.4.2]

When evaluating for reselection purposes cell selection criterion or $S_{\text{nonServingCell},x}$, the UE shall use parameters provided by the serving cell.

Following rules are used by the UE to limit needed measurements:

- If $S_{\text{intraSearch}}$ is sent in the serving cell and $S_{\text{ServingCell}} > S_{\text{intraSearch}}$, UE may choose to not perform intra-frequency measurements.
- If $S_{\text{ServingCell}} \leq S_{\text{intraSearch}}$, or $S_{\text{intraSearch}}$ is not sent in the serving cell UE shall perform intra-frequency measurements.
- The UE shall apply the following rules for E-UTRAN inter-frequencies and inter-RAT frequencies which are indicated in system information and for which the UE has priority provided as defined in 5.2.4.1:
 - For an E-UTRAN inter-frequency or inter-RAT frequency with a reselection priority higher than the reselection priority of the current E-UTRA frequency the UE shall perform measurements of higher priority E-UTRAN inter-frequency or inter-RAT frequencies according to [10].
 - For an E-UTRAN inter-frequency with an equal or lower reselection priority than the reselection priority of the current E-UTRA frequency and for inter-RAT frequency with lower reselection priority than the reselection priority of the current E-UTRAN frequency:
 - If $S_{\text{nonIntraSearch}}$ is sent in the serving cell and $S_{\text{ServingCell}} > S_{\text{nonIntraSearch}}$ UE may choose not to perform measurements of E-UTRAN inter-frequencies or inter-RAT frequency cells of equal or lower priority.
 - If $S_{\text{ServingCell}} \leq S_{\text{nonIntraSearch}}$ or $S_{\text{nonIntraSearch}}$ is not sent in the serving cell the UE shall perform measurements of E-UTRAN inter-frequencies or inter-RAT frequency cells of equal or lower priority according to [10].

Where $S_{\text{ServingCell}}$ is the S_{rxlev} -value of the serving cell.

[TS 36.304, clause 5.2.4.5]

Criteria 1: the $S_{\text{nonServingCell},x}$ of a cell on evaluated frequency is greater than $\text{Thresh}_{x, \text{high}}$ during a time interval $T_{\text{reselectionRAT}}$;

Cell reselection to a cell on a higher priority E-UTRAN frequency or inter-RAT frequency than serving frequency shall be performed if:

- A cell of a higher priority E-UTRAN frequency or inter-RAT frequency fulfils criteria 1; and
- more than 1 second has elapsed since the UE camped on the current serving cell.

Cell reselection to a cell on an equal priority E-UTRAN frequency shall be based on ranking for Intra-frequency cell reselection as defined in sub-clause 5.2.4.6.

Cell reselection to a cell on a lower priority E-UTRAN frequency or inter-RAT frequency than serving frequency shall be performed if:

- No cell on a higher priority E-UTRAN frequency or inter-RAT frequency than serving frequency fulfils the criteria 1; and
- No cell on serving frequency or on an equal priority E-UTRAN frequency fulfils the criteria in 5.2.4.6; and
- $S_{\text{ServingCell}} < \text{Thresh}_{\text{Serving, low}}$ and the $S_{\text{nonServingCell},x}$ of a cell of a lower priority E-UTRAN frequency or inter-RAT frequency is greater than $\text{Thresh}_{x, \text{low}}$ during a time interval $T_{\text{reselection}_{\text{RAT}}}$; and
- more than 1 second has elapsed since the UE camped on the current serving cell.

For GERAN, UTRAN, and E-UTRAN, $S_{\text{nonServingCell},x}$ is the S_{rxlev} -value of an evaluated cell. For UTRAN FDD, S_{qual} is higher than 0, as defined in [8]. For cdma2000 RATs, $S_{\text{nonServingCell},x}$ is equal to $\text{FLOOR}(-2 \times 10 \times \log_{10} E_c/I_o)$ in units of 0.5 dB, as defined in [18], with E_c/I_o referring to the value measured from the evaluated cell.

For cdma2000 RATs, $\text{Thresh}_{x, \text{high}}$ and $\text{Thresh}_{x, \text{low}}$ are equal to -1 times the values signalled for the corresponding parameters in the system information.

In all the above criteria the value of $T_{\text{reselection}_{\text{RAT}}}$ is scaled when the UE is in the medium or high mobility state as defined in subclause 5.2.4.3.1. If more than one cell meets the above criteria, the UE shall reselect a cell ranked as the best cell among the cells meeting the criteria on the highest priority frequencies or the highest priority RAT if the highest priority RAT is E-UTRA according to criteria defined in 5.2.4.6.

6.1.2.16.3 Test description

6.1.2.16.3.1 Pre-test conditions

System Simulator:

- Cell 1, Cell 28 and Cell 30.
- Cell 1 is FDD mode, Cell 28, Cell 30 are TDD mode in the same TDD band.
- The PLMNs are identified in the test by the identifiers in Table 6.1.2.16.3.1-1.

Table 6.1.2.16.3.1-1: PLMN identifiers

Cell	PLMN name
1	PLMN1
28	PLMN2
30	PLMN3

- System information combination 3 as defined in TS 36.508 [18] clause 4.4.3.1 and Table 6.3.1.2-2 is used in E-UTRA cells.

UE:

- The UE is in Automatic PLMN selection mode.
- The UE is equipped with a USIM containing default values (as per TS 36.508) except for those listed in Table 6.1.2.16.3.1-2.

Table 6.1.2.16.3.1-2: USIM configuration

USIM field	Priority	Value	Access Technology Identifier
EF _{LocI}		PLMN1 (See pre-amble)	

Preamble:

- The UE is registered on PLMN1 (Cell 1) using the procedure described in TS 36.508[18] clause 4.5.2.3 except that the ATTACH ACCEPT message indicates PLMN2/PLMN3 in the Equivalent PLMN list as described in Table 6.1.2.16.3.3-5.

6.1.2.16.3.2 Test procedure sequence

Table 6.1.2.16.3.2-1 illustrates the downlink power levels and other changing parameters to be applied for the cells at various time instants of the test execution. The configuration marked "T1" is applied at the point indicated in the Main behaviour description in Table 6.1.2.16.3.2-2.

Table 6.1.2.16.3.2-1: Time instances of cell power level and parameter changes

	Parameter	Unit	Cell 1	Cell 28	Cell 30	Remark
T1	Cell-specific RS EPRE	dBm/15kHz	-73	Off	-73	Cell 1 and Cell 30 becomes stronger than $Thresh_{x, high}$, but Cell 30 has the higher priority (NOTE 1).
T2	Cell-specific RS EPRE	dBm/15kHz	-73	-73	-85	Cell 1 and Cell 28 become stronger than $Thresh_{x, high}$, but Cell 1 has the higher priority (NOTE 1).

Note 1: Power level "Off" is defined in TS36.508 Table 6.2.2.1-1.

Table 6.1.2.16.3.2-2: Main behaviour

St	Procedure	Message Sequence		TP	Verdict
		U - S	Message		
1	The SS changes Cell 30 power level according to the row "T1" in table 6.1.2.16.3.2-1.	-	-	-	-
2	Check: Does the test result of generic test procedure in TS 36.508 subclause 6.4.2.7 indicate that the UE is camped on E-UTRAN Cell 30? NOTE: The UE performs a TAU procedure with PLMN1 and PLMN2 listed as Equivalent PLMN list in the TRACKING AREA UPDATE ACCEPT message, and the RRC connection is released.	-	-	1,	
-	The SS changes the <i>SystemInformationBlockType3</i> and <i>SystemInformationBlockType5</i> in the system information and transmits a Paging message including a <i>systemInfoModification</i> .	-	-	-	-
3	The SS changes Cell 1, Cell 28 and Cell 30 power level according to the row "T2" in table 6.1.2.16.3.2-1.	-	-	-	-
4	Check: Does the test result of generic test procedure in TS 36.508 subclause 6.4.2.7 indicate that the UE is camped on E-UTRAN Cell 1? NOTE: The UE performs a TAU procedure with PLMN2 and PLMN3 listed as Equivalent PLMN list in the TRACKING AREA UPDATE ACCEPT message, and the RRC connection is released.	-	-	2	

6.1.2.16.3.3 Specific message contents

**Table 6.1.2.16.3.3-0: Conditions for specific message contents
in Tables 6.1.2.16.3.3-1 and 6.1.2.16.3.3-2**

Condition	Explanation
Cell 1	This condition applies to system information transmitted on Cell 1.
Cell 28	This condition applies to system information transmitted on Cell 28.
Cell 30	This condition applies to system information transmitted on Cell 30.

**Table 6.1.2.16.3.3-1: SystemInformationBlockType3 for Cell 1 and Cell 30 (preamble and step 1 and 2,
Table 6.1.2.16.3.2-2)**

Derivation path: 36.508 table 4.4.3.3-2			
Information Element	Value/Remark	Comment	Condition
SystemInformationBlockType3 ::= SEQUENCE {			
cellReselectionServingFreqInfo SEQUENCE {			
cellReselectionPriority	3		Cell 1
	5		Cell 30
}			
}			

**Table 6.1.2.16.3.3-2: SystemInformationBlockType3 for Cell 1, Cell 28 and Cell 30 (step 3 and step 4,
Table 6.1.2.16.3.2-2)**

Derivation path: 36.508 table 4.4.3.3-2			
Information Element	Value/Remark	Comment	Condition
SystemInformationBlockType3 ::= SEQUENCE {			
cellReselectionServingFreqInfo SEQUENCE {			
cellReselectionPriority	5		Cell 1
	4		Cell 28
	3		Cell 30
}			
}			

**Table 6.1.2.16.3.3-3: SystemInformationBlockType5 for Cell 1 and Cell 30 (preamble and step 1 and 2,
Table 6.1.2.16.3.2-2)**

Derivation path: 36.508 table 4.4.3.3-4			
Information Element	Value/Remark	Comment	Condition
SystemInformationBlockType5 ::= SEQUENCE {			
interFreqCarrierFreqList SEQUENCE (SIZE (1..maxFreq)) OF SEQUENCE {			
dl-CarrierFreq	Same downlink EARFCN as used for Cell 30		Cell 1
	Same downlink EARFCN as used for Cell 1		Cell 30
t-ReselectionEUTRA	5		Cell 1
	5		Cell 30
threshX-High	10	20dB	
cellReselectionPriority	5		Cell 1
	3		Cell 30
}			
}			

Table 6.1.2.16.3.3-4: SystemInformationBlockType5 for Cell 1, Cell 28, and Cell 30 (step 3 and 4, Table 6.1.2.16.3.2-2)

Derivation path: 36.508 table 4.4.3.3-4			
Information Element	Value/Remark	Comment	Condition
SystemInformationBlockType5 ::= SEQUENCE { interFreqCarrierFreqList SEQUENCE (SIZE (1..maxFreq)) OF SEQUENCE {			
dl-CarrierFreq[n]	Same downlink EARFCN as used for Cell 28		Cell 1
	Same downlink EARFCN as used for Cell 1		Cell 28, Cell 30
t-ReselectionEUTRA[n]	7		Cell 1
	5		Cell 30
threshX-High[n]	10	20dB	
cellReselectionPriority[n]	4		Cell 1
	5		Cell 28, Cell 30
dl-CarrierFreq[m]	Same downlink EARFCN as used for Cell 30		Cell 1, Cell 28
	Same downlink EARFCN as used for Cell 28		Cell 30
t-ReselectionEUTRA[m]	5		Cell 1
	7		Cell 30
threshX-High[m]	10	20dB	
cellReselectionPriority[m]	3		Cell 1, Cell 28
	4		Cell 30
}			
}			

Table 6.1.2.16.3.3-5: ATTACH ACCEPT for Cell 1 (preamble)

Derivation path: 36.508 Table 4.7.2-1			
Information Element	Value/Remark	Comment	Condition
Equivalent PLMNs	PLMN2,3		

Table 6.1.2.16.3.3-6: TRACKING AREA UPDATE ACCEPT for Cell 30 (step 2, Table 6.1.2.16.3.2-2)

Derivation path: 36.508 Table 4.7.2-24			
Information Element	Value/Remark	Comment	Condition
Equivalent PLMNs	PLMN1, 2		

Table 6.1.2.16.3.3-7: TRACKING AREA UPDATE ACCEPT for Cell 1 (step 4, Table 6.1.2.16.3.2-2)

Derivation path: 36.508 Table 4.7.2-24			
Information Element	Value/Remark	Comment	Condition
Equivalent PLMNs	PLMN2, 3		

6.1.2.17 Cell reselection for Squal to check against $S_{\text{IntraSearchQ}}$ and $S_{\text{nonIntraSearchQ}}$

6.1.2.17.1 Test Purpose (TP)

(1)

```
with { UE in E-UTRA RRC_IDLE state, and the UE is not in high mobility state }
ensure that {
  when {  $S_{\text{IntraSearchQ}}$  is non-zero in system information }
  then { UE perform measurement and reselects the highest ranked cell upon  $S_{\text{qual}} < S_{\text{IntraSearchQ}}$  }
}
```

(2)

```

with { UE in E-UTRA RRC_IDLE state, and the UE is not in high mobility state }
ensure that {
  when {  $S_{\text{nonIntraSearchQ}}$  is non-zero in system information }
  then { UE perform measurement and reselects the cell which belong to the equal priority
frequency cell upon  $S_{\text{qual}} < S_{\text{nonIntraSearchQ}}$  }
}

```

(3)

```

with { UE in E-UTRA RRC_IDLE state, and the UE is not in high mobility state }
ensure that {
  when {  $S_{\text{nonIntraSearchQ}}$  is non-zero in system information }
  then { UE perform measurement and reselects the cell which belong to the high priority
frequency cell upon  $S_{\text{qual}} > S_{\text{nonIntraSearchQ}}$  }
}

```

6.1.2.17.2 Conformance requirements

References: The conformance requirements covered in the current TC are specified in: TS36.304, clauses 5.2.4.2, 5.2.4.5 and 5.2.4.6; TS36.331, clause 6.3.1.

[TS 36.304, clause 5.2.4.2]

When evaluating S_{rxlev} and S_{qual} of non-serving cells for reselection purposes, the UE shall use parameters provided by the serving cell.

Following rules are used by the UE to limit needed measurements:

- If the serving cell fulfils $S_{\text{rxlev}} > S_{\text{IntraSearchP}}$ and $S_{\text{qual}} > S_{\text{IntraSearchQ}}$, the UE may choose not to perform intra-frequency measurements.
- Otherwise, the UE shall perform intra-frequency measurements.
- The UE shall apply the following rules for E-UTRAN inter-frequencies and inter-RAT frequencies which are indicated in system information and for which the UE has priority provided as defined in 5.2.4.1:
 - For an E-UTRAN inter-frequency or inter-RAT frequency with a reselection priority higher than the reselection priority of the current E-UTRA frequency the UE shall perform measurements of higher priority E-UTRAN inter-frequency or inter-RAT frequencies according to [10].
 - For an E-UTRAN inter-frequency with an equal or lower reselection priority than the reselection priority of the current E-UTRA frequency and for inter-RAT frequency with lower reselection priority than the reselection priority of the current E-UTRAN frequency:
 - If the serving cell fulfils $S_{\text{rxlev}} > S_{\text{nonIntraSearchP}}$ and $S_{\text{qual}} > S_{\text{nonIntraSearchQ}}$, the UE may choose not to perform measurements of E-UTRAN inter-frequencies or inter-RAT frequency cells of equal or lower priority.
 - Otherwise, the UE shall perform measurements of E-UTRAN inter-frequencies or inter-RAT frequency cells of equal or lower priority according to [10].

[TS 36.304, clause 5.2.4.5]

If *threshServingLowQ* is provided in *SystemInformationBlockType3*, cell reselection to a cell on a higher priority E-UTRAN frequency or inter-RAT frequency than the serving frequency shall be performed if:

- A cell of a higher priority EUTRAN or UTRAN FDD RAT/ frequency fulfils $S_{\text{qual}} > \text{Thresh}_{\text{X, HighQ}}$ during a time interval $\text{Treselection}_{\text{RAT}}$; or
- A cell of a higher priority UTRAN TDD, GERAN or CDMA2000 RAT/ frequency fulfils $S_{\text{rxlev}} > \text{Thresh}_{\text{X, HighP}}$ during a time interval $\text{Treselection}_{\text{RAT}}$; and
- More than 1 second has elapsed since the UE camped on the current serving cell.

Otherwise, cell reselection to a cell on a higher priority E-UTRAN frequency or inter-RAT frequency than the serving frequency shall be performed if:

- A cell of a higher priority RAT/ frequency fulfils $Srxlev > Thresh_{X, HighP}$ during a time interval $Treselection_{RAT}$; and
- More than 1 second has elapsed since the UE camped on the current serving cell.

Cell reselection to a cell on an equal priority E-UTRAN frequency shall be based on ranking for Intra-frequency cell reselection as defined in sub-clause 5.2.4.6.

If *threshServingLowQ* is provided in *SystemInformationBlockType3*, cell reselection to a cell on a lower priority E-UTRAN frequency or inter-RAT frequency than the serving frequency shall be performed if:

- The serving cell fulfils $Squal < Thresh_{Serving, LowQ}$ and a cell of a lower priority EUTRAN or UTRAN FDD RAT/ frequency fulfils $Squal > Thresh_{X, LowQ}$ during a time interval $Treselection_{RAT}$; or
- The serving cell fulfils $Squal < Thresh_{Serving, LowQ}$ and a cell of a lower priority UTRAN TDD, GERAN or CDMA2000 RAT/ frequency fulfils $Srxlev > Thresh_{X, LowP}$ during a time interval $Treselection_{RAT}$; and
- More than 1 second has elapsed since the UE camped on the current serving cell.

Otherwise, cell reselection to a cell on a lower priority E-UTRAN frequency or inter-RAT frequency than the serving frequency shall be performed if:

- The serving cell fulfils $Srxlev < Thresh_{Serving, LowP}$ and a cell of a lower priority RAT/ frequency fulfils $Srxlev > Thresh_{X, LowP}$ during a time interval $Treselection_{RAT}$; and
- More than 1 second has elapsed since the UE camped on the current serving cell.

Cell reselection to a higher priority RAT/ frequency shall take precedence over a lower priority RAT/ frequency, if multiple cells of different priorities fulfil the cell reselection criteria.

.....

In all the above criteria the value of $Treselection_{RAT}$ is scaled when the UE is in the medium or high mobility state as defined in subclause 5.2.4.3.1. If more than one cell meets the above criteria, the UE shall reselect a cell as follows:

- If the highest-priority frequency is an E-UTRAN frequency, a cell ranked as the best cell among the cells on the highest priority frequency(ies) meeting the criteria according to section 5.2.4.6;
- If the highest-priority frequency is from another RAT, a cell ranked as the best cell among the cells on the highest priority frequency(ies) meeting the criteria of that RAT.

[TS 36.304, clause 5.2.4.6]

The cell-ranking criterion R_s for serving cell and R_n for neighbouring cells is defined by:

$R_s = Q_{meas,s} + Q_{Hyst}$
$R_n = Q_{meas,n} - Q_{offset}$

where:

Q_{meas}	RSRP measurement quantity used in cell reselections.
Q_{offset}	For intra-frequency: Equals to $Q_{offset_{s,n}}$, if $Q_{offset_{s,n}}$ is valid, otherwise this equals to zero. For inter-frequency: Equals to $Q_{offset_{s,n}}$ plus $Q_{offset_{frequency}}$, if $Q_{offset_{s,n}}$ is valid, otherwise this equals to $Q_{offset_{frequency}}$.

The UE shall perform ranking of all cells that fulfil the cell selection criterion S, which is defined in 5.2.3.2, but may exclude all CSG cells that are known by the UE to be not allowed.

The cells shall be ranked according to the R criteria specified above, deriving $Q_{meas,n}$ and $Q_{meas,s}$ and calculating the R values using averaged RSRP results.

If a cell is ranked as the best cell the UE shall perform cell reselection to that cell. If this cell is found to be not-suitable, the UE shall behave according to subclause 5.2.4.4.

In all cases, the UE shall reselect the new cell, only if the following conditions are met:

- the new cell is better ranked than the serving cell during a time interval $T_{\text{reselction}_{\text{RAT}}}$;
- more than 1 second has elapsed since the UE camped on the current serving cell.

[TS 36.331, clause 6.3.1]

The IE *SystemInformationBlockType3* contains cell re-selection information common for intra-frequency, inter-frequency and/ or inter-RAT cell re-selection (i.e. applicable for more than one type of cell re-selection but not necessarily all) as well as intra-frequency cell re-selection information other than neighbouring cell related.

6.1.2.17.3 Test description

6.1.2.17.3.1 Pre-test conditions

System Simulator:

- Cell 1, Cell 2 and Cell 3 have different tracking areas according to table 6.0.1-2.
- System information combination 3 as defined in TS 36.508 [18] clause 4.4.3.1 is used in E-UTRA cells.

UE:

None.

Preamble:

- The UE is in state Registered, Idle mode (state 2) on Cell 1(serving cell) according to [18].

6.1.2.17.3.2 Test procedure sequence

Table 6.1.2.17.3.2-1 illustrates the downlink power levels and other changing parameters to be applied for the cells at various time instants of the test execution. The exact instants on which these values shall be applied are described in the texts in this clause. Configurations marked "T1", "T2" and "T3" are applied at the points indicated in the Main behaviour description in Table 6.1.2.17.3.2-2.

Table 6.1.2.17.3.2-1: Time instances of cell power level and parameter change

	Parameter	Unit	Cell 1	Cell 2	Cell 3	Remark
T1	Cell-specific RS EPRE	dBm/15kHz	-91	-85	-115	Squal of Cell 1 is less than $S_{\text{IntraSearchQ}}$.
	RSRQ	dB	-11.68	-5.68	-30.8	
	Q_{rxlevmin}	dBm	-106	-106	-106	
	Q_{qualmin}	dB	-20	-20	-20	
	$S_{\text{IntraSearchQ}}$	dB	20	20	20	
	Noc	dBm/15kHz	-95	-95	-95	
	S_{rxlev}	dB	15	21	-9	
Squal	dB	8.32	14.32	-10.8		
T2	Cell-specific RS EPRE	dBm/15kHz	-115	-91	-85	Squal of Cell 2 is less than $S_{\text{nonIntraSearchQ}}$.
	RSRQ	dB	-32.32	-8.32	-5.05	
	$S_{\text{nonIntraSearchQ}}$	dB	20	20	20	
	S_{rxlev}	dB	-9	15	21	
	Squal	dB	-12.32	11.68	14.95	
T3	Cell-specific RS EPRE	dBm/15kHz	-85	-115	-85	Squal of Cell 3 is greater than $S_{\text{nonIntraSearchQ}}$ but Cell 1 is high priority cell.
	RSRQ	dB	[-6]	[-25]	[-6]	
	$S_{\text{nonIntraSearchQ}}$	dB	20	20	2	
	S_{rxlev}	dB	21	-9	21	
	Squal	dB	14.95	-15.05	14.95	

Note: Power level "Off" is defined in TS36.508 Table 6.2.2.1-1.

Table 6.1.2.17.3.2-2: Main behaviour

St	Procedure	Message Sequence		TP	Verdict
		U - S	Message		
1	The SS re-adjusts the cell-specific reference signal levels according to row "T1" in table 6.1.2.17.3.2-1.	-	-	-	-
2	Check: Does UE transmits an <i>RRCCONNECTIONREQUEST</i> message on Cell 2 within [6 minutes]?	-->	<i>RRCCONNECTIONREQUEST</i>	1	P
3 - 7	Steps 2 to 6 of the generic test procedure in TS 36.508 subclause 6.4.2.7 are performed on Cell 2. NOTE: The UE performs a TAU procedure and the RRC connection is released.	-	-	-	-
8	The SS re-adjusts the cell-specific reference signal levels according to row "T2" in table 6.1.2.17.3.2-1.	-	-	-	-
9	Check: Does UE transmits an <i>RRCCONNECTIONREQUEST</i> message on Cell 3 within [6 minutes]?	-->	<i>RRCCONNECTIONREQUEST</i>	2	P
10 - 14	Steps 2 to 6 of the generic test procedure in TS 36.508 subclause 6.4.2.7 are performed on Cell 3. NOTE: The UE performs a TAU procedure and the RRC connection is released.	-	-	-	-
15	The SS waits 1 second.	-	-	-	-
16	The SS notifies the UE of change of System Information and changes the system information for Cell 1, 2 & 3. The <i>systemInfoValueTag</i> in the <i>SystemInformationBlockType1</i> is increased.	<--	<i>Paging</i>	-	-
17	Void	-	-	-	-
18	The SS re-adjusts the cell-specific reference signal levels according to row "T3" in table 6.1.2.13.3.2-1.	-	-	-	-
19	Check: Does the test result of the generic test procedure in TS 36.508 subclause 6.4.2.7 indicate that the UE is camped on E-UTRAN Cell 1? (Note1) NOTE: The UE performs a TAU procedure and the RRC connection is released.	-	-	3	-
Note1: UE shall search higher priority layer (i.e. E-UTRA carrier frequency of Cell 1) at least every (60 * N _{layers}) seconds, where N _{layers} = 1 as specified in [4.2.2, 34].					

6.1.2.17.3.3 Specific message contents

Table 6.1.2.17.3.3-1: SystemInformationBlockType1 for Cells 1, 2 and 3 (preamble, Table 6.1.2.17.3.2-2)

Derivation Path: 36.508 table 4.4.3.2-3			
Information Element	Value/remark	Comment	Condition
SystemInformationBlockType1 ::= SEQUENCE {			
cellSelectionInfo SEQUENCE {			
q-RxLevMin	-53 (-106 dBm)		
}			
nonCriticalExtension SEQUENCE {			
lateNonCriticalExtension	Not present		
nonCriticalExtension SEQUENCE {			
ims-EmergencySupport-r9	Not present		
cellSelectionInfo-v920 SEQUENCE {			
q-QualMin-r9	-20 dB		
q-QualMinOffset-r9	Not present		
}			
}			
}			
}			

Table 6.1.2.17.3.3-2: SystemInformationBlockType3 for Cells 1, 2 and 3 (preamble, Table 6.1.2.17.3.2-2)

Derivation Path: 36.508 table 4.4.3.3-2			
Information Element	Value/remark	Comment	Condition
SystemInformationBlockType3 ::= SEQUENCE {			
lateNonCriticalExtension {			
s-IntraSearch-v920 SEQUENCE {			
s-IntraSearchP-r9	0 (0 dB)		
s-IntraSearchQ-r9	20 dB		
}			
s-NonIntraSearch-v920 SEQUENCE {			
s-NonIntraSearchP-r9	0 (0 dB)		
s-NonIntraSearchQ-r9	20 dB		
}			
q-QualMin-r9	-20 dB		
}			
}			

Table 6.1.2.17.3.3-3: SystemInformationBlockType1 for Cell 3 (step 16, Table 6.1.2.17.3.2-2)

Derivation Path: 36.508 table 4.4.3.2-3			
Information Element	Value/remark	Comment	Condition
SystemInformationBlockType1 ::= SEQUENCE {			
systemInfoValueTag	1	Previous value is 0	
nonCriticalExtension SEQUENCE {			
lateNonCriticalExtension	Not present		
nonCriticalExtension SEQUENCE {			
ims-EmergencySupport-r9	Not present		
cellSelectionInfo-v920 SEQUENCE {			
q-QualMin-r9	-20 dB		
q-QualMinOffset-r9	Not present		
}			
}			
}			
}			

Table 6.1.2.17.3.3a: SystemInformationBlockType3 for Cell 3 (step 16, Table 6.1.2.17.3.2-2)

Derivation Path: 36.508 table 4.4.3.3-2			
Information Element	Value/remark	Comment	Condition
SystemInformationBlockType3 ::= SEQUENCE {			
lateNonCriticalExtension {			
s-NonIntraSearch-v920 SEQUENCE {			
s-NonIntraSearchP-r9	0 (0 dB)		
s-NonIntraSearchQ-r9	2 dB		
}			
}			
}			

Table 6.1.2.17.3.3-4: SystemInformationBlockType5 for Cell 3 (step 16, Table 6.1.2.17.3.2-2)

Derivation path: 36.508 table 4.4.3.3-4			
Information Element	Value/Remark	Comment	Condition
SystemInformationBlockType5 ::= SEQUENCE {			
interFreqCarrierFreqList SEQUENCE (SIZE (1..maxFreq)) OF SEQUENCE {	1 entry		
dl-CarrierFreq[1]	EARFCN of Cell 1		
threshX-High[1]	7	14 dB	
cellReselectionPriority[1]	5		
}			
}			

Table 6.1.2.17.3.3-4a: SystemInformationBlockType3 for Cell 1 and 2 (step 16, Table 6.1.2.17.3.2-2)

Derivation Path: 36.508 table 4.4.3.3-2			
Information Element	Value/remark	Comment	Condition
SystemInformationBlockType3 ::= SEQUENCE {			
cellReselectionServingFreqInfo SEQUENCE {			
s-NonIntraSearch	Not present		
threshServingLow	0 (0 dB)		
cellReselectionPriority	5		
}			
}			

Table 6.1.2.17.3.3-5: Paging (step 16, Table 6.1.2.17.3.2-2)

Derivation path: 36.508 Table 4.6.1-7			
Information Element	Value/Remark	Comment	Condition
Paging ::= SEQUENCE {			
pagingRecordList	Not present		
systemInfoModification	true		
etws-Indication	Not present		
nonCriticalExtension SEQUENCE {}	Not present		
}			

Table 6.1.2.17.3.3-6: SystemInformationBlockType1 for Cell 1, Cell 2 and Cell 3 (step 16, Table 6.1.2.17.3.2-2)

Derivation Path: 36.508 table 4.4.3.2-3			
Information Element	Value/remark	Comment	Condition
systemInfoValueTag	1	Previous value is 0	

6.1.2.18 Inter-frequency cell reselection based on common priority information with parameters $\text{Thresh}_{X, \text{HighQ}}$, $\text{Thresh}_{X, \text{LowQ}}$ and $\text{Thresh}_{\text{Serving, LowQ}}$

6.1.2.18.1 Test Purpose (TP)

(1)

```
with { UE in E-UTRA RRC_IDLE state }
ensure that {
  when { UE detects the cell re-selection criteria are met for the cell which belongs to the higher
priority frequency }
  then { UE reselects the cell which belongs to the higher priority frequency }
}
```

(2)

```
with { UE in E-UTRA RRC_IDLE state }
ensure that {
  when { UE detects the cell re-selection criteria are met for the cell which belongs to the lower
priority frequency }
  then { UE reselects the cell which belongs to the lower priority frequency }
}
```

6.1.2.18.2 Conformance requirements

References: The conformance requirements covered in the present TC are specified in: TS 36.304, clause 5.2.4.1, 5.2.4.2 and 5.2.4.5.

[TS 36.304, clause 5.2.4.1]

Absolute priorities of different E-UTRAN frequencies or inter-RAT frequencies may be provided to the UE in the system information, in the *RRCConnectionRelease* message, or by inheriting from another RAT at inter-RAT cell (re)selection. In the case of system information, an E-UTRAN frequency or inter-RAT frequency may be listed without providing a priority (i.e. the field *cellReselectionPriority* is absent for that frequency). If priorities are provided in dedicated signalling, the UE shall ignore all the priorities provided in system information. If UE is in *camped on any cell* state, UE shall only apply the priorities provided by system information from current cell, and the UE preserves priorities provided by dedicated signalling unless specified otherwise. When the UE in *camped normally* state, has only dedicated priorities other than for the current frequency, the UE shall consider the current frequency to be the lowest priority frequency (i.e. lower than the eight network configured values). While the UE is camped on a suitable CSG cell, the UE shall always consider the current frequency to be the highest priority frequency (i.e. higher than the eight network configured values), irrespective of any other priority value allocated to this frequency. The UE shall delete priorities provided by dedicated signalling when:

- the UE enters RRC_CONNECTED state; or
- the optional validity time of dedicated priorities (T320) expires; or
- a PLMN selection is performed on request by NAS [5].

NOTE: Equal priorities between RATs are not supported.

The UE shall only perform cell reselection evaluation for E-UTRAN frequencies and inter-RAT frequencies that are given in system information and for which the UE has a priority provided.

The UE shall not consider any black listed cells as candidate for cell reselection.

The UE shall inherit the priorities provided by dedicated signalling and the remaining validity time (i.e., T320 in E-UTRA, T322 in UTRA and T3230 in GERAN), if configured, at inter-RAT cell (re)selection.

NOTE: The network may assign dedicated cell reselection priorities for frequencies not configured by system information.

[TS 36.304, clause 5.2.4.2]

When evaluating S_{rxlev} and S_{qual} of non-serving cells for reselection purposes, the UE shall use parameters provided by the serving cell.

Following rules are used by the UE to limit needed measurements:

- If the serving cell fulfils $S_{rxlev} > S_{IntraSearchP}$ and $S_{qual} > S_{IntraSearchQ}$, the UE may choose not to perform intra-frequency measurements.
- Otherwise, the UE shall perform intra-frequency measurements.
- The UE shall apply the following rules for E-UTRAN inter-frequencies and inter-RAT frequencies which are indicated in system information and for which the UE has priority provided as defined in 5.2.4.1:
 - For an E-UTRAN inter-frequency or inter-RAT frequency with a reselection priority higher than the reselection priority of the current E-UTRA frequency the UE shall perform measurements of higher priority E-UTRAN inter-frequency or inter-RAT frequencies according to [10].
 - For an E-UTRAN inter-frequency with an equal or lower reselection priority than the reselection priority of the current E-UTRA frequency and for inter-RAT frequency with lower reselection priority than the reselection priority of the current E-UTRAN frequency:
 - If the serving cell fulfils $S_{rxlev} > S_{nonIntraSearchP}$ and $S_{qual} > S_{nonIntraSearchQ}$, the UE may choose not to perform measurements of E-UTRAN inter-frequencies or inter-RAT frequency cells of equal or lower priority.
 - Otherwise, the UE shall perform measurements of E-UTRAN inter-frequencies or inter-RAT frequency cells of equal or lower priority according to [10].

[TS 36.304, clause 5.2.4.5]

If *threshServingLowQ* is provided in *SystemInformationBlockType3*, cell reselection to a cell on a higher priority E-UTRAN frequency or inter-RAT frequency than the serving frequency shall be performed if:

- A cell of a higher priority EUTRAN or UTRAN FDD RAT/ frequency fulfils $S_{qual} > Thresh_{X, HighQ}$ during a time interval $T_{reselection_{RAT}}$; or
- A cell of a higher priority UTRAN TDD, GERAN or CDMA2000 RAT/ frequency fulfils $S_{rxlev} > Thresh_{X, HighP}$ during a time interval $T_{reselection_{RAT}}$; and
- More than 1 second has elapsed since the UE camped on the current serving cell.

Otherwise, cell reselection to a cell on a higher priority E-UTRAN frequency or inter-RAT frequency than the serving frequency shall be performed if:

- A cell of a higher priority RAT/ frequency fulfils $S_{rxlev} > Thresh_{X, HighP}$ during a time interval $T_{reselection_{RAT}}$; and
- More than 1 second has elapsed since the UE camped on the current serving cell.

Cell reselection to a cell on an equal priority E-UTRAN frequency shall be based on ranking for Intra-frequency cell reselection as defined in sub-clause 5.2.4.6.

If *threshServingLowQ* is provided in *SystemInformationBlockType3*, cell reselection to a cell on a lower priority E-UTRAN frequency or inter-RAT frequency than the serving frequency shall be performed if:

- The serving cell fulfils $S_{qual} < Thresh_{Serving, LowQ}$ and a cell of a lower priority EUTRAN or UTRAN FDD RAT/ frequency fulfils $S_{qual} > Thresh_{X, LowQ}$ during a time interval $T_{reselection_{RAT}}$; or
- The serving cell fulfils $S_{qual} < Thresh_{Serving, LowQ}$ and a cell of a lower priority UTRAN TDD, GERAN or CDMA2000 RAT/ frequency fulfils $S_{rxlev} > Thresh_{X, LowP}$ during a time interval $T_{reselection_{RAT}}$; and
- More than 1 second has elapsed since the UE camped on the current serving cell.

Otherwise, cell reselection to a cell on a lower priority E-UTRAN frequency or inter-RAT frequency than the serving frequency shall be performed if:

- The serving cell fulfils $S_{rxlev} < Thresh_{Serving, LowP}$ and a cell of a lower priority RAT/ frequency fulfils $S_{rxlev} > Thresh_{X, LowP}$ during a time interval $T_{reselection_{RAT}}$; and
- More than 1 second has elapsed since the UE camped on the current serving cell.

Cell reselection to a higher priority RAT/ frequency shall take precedence over a lower priority RAT/ frequency, if multiple cells of different priorities fulfil the cell reselection criteria.

.....

In all the above criteria the value of $T_{\text{reselection}_{\text{RAT}}}$ is scaled when the UE is in the medium or high mobility state as defined in subclause 5.2.4.3.1. If more than one cell meets the above criteria, the UE shall reselect a cell as follows:

- If the highest-priority frequency is an E-UTRAN frequency, a cell ranked as the best cell among the cells on the highest priority frequency(ies) meeting the criteria according to section 5.2.4.6;
- If the highest-priority frequency is from another RAT, a cell ranked as the best cell among the cells on the highest priority frequency(ies) meeting the criteria of that RAT.

6.1.2.18.3 Test description

6.1.2.18.3.1 Pre-test conditions

System Simulator:

- Cell 1 and Cell 3.
- System information combination 3 as defined in TS 36.508 [18] clause 4.4.3.1 is used in E-UTRA cells.

UE:

None.

Preamble:

- The UE is in state Registered, Idle mode (state 2) on Cell 1 (serving cell) according to [18].

6.1.2.18.3.2 Test procedure sequence

Table 6.1.2.18.3.2-1 illustrates the downlink power levels and other changing parameters to be applied for the cells at various time instants of the test execution. Subsequent configurations marked "T1" and "T2" are applied at the points indicated in the Main behaviour description in Table 6.1.2.18.3.2-2.

Table 6.1.2.18.3.2-1: Time instances of cell power level and parameter changes

	Parameter	Unit	Cell 1	Cell 3	Remark
T1	Cell-specific RS EPRE	dBm/15kHz	-85	-85	The power level values are assigned to satisfy $S_{\text{rxlev}}^{\text{Cell 1}} > 0$, $S_{\text{rxlev}}^{\text{Cell 3}} < \text{Thresh}_{\text{Cell 3, highP}}$, $S_{\text{qual}}^{\text{Cell 1}} > 0$ and $S_{\text{qual}}^{\text{Cell 3}} > \text{Thresh}_{\text{Cell 3, highQ}}$.
	RSRQ	dB	-3	-3	
	Qqualmin	dB	-20	-20	
	Qrxlevmin	dBm	-100	-100	
	Noc	dBm/15kHz	off	off	
T2	Cell-specific RS EPRE	dBm/15kHz	-85	-91	The power level values are assigned to satisfy $S_{\text{rxlev}}^{\text{Cell 3}} > \text{Thresh}_{\text{-serving, lowP}}$, $S_{\text{qual}}^{\text{Cell 3}} < \text{Thresh}_{\text{-serving, lowQ}}$ and $S_{\text{qual}}^{\text{Cell 1}} > \text{Thresh}_{\text{Cell 1, lowQ}}$.
	RSRQ	dB	-3	-3	

Table 6.1.2.18.3.2-2: Main behaviour

St	Procedure	Message Sequence		TP	Verdict
		U - S	Message		
1	The SS changes Cell 3 power level according to the row "T1" in table 6.1.2.18.3.2-1.	-	-	-	-
2	Check: Does the test result of generic test procedure in TS 36.508 subclause 6.4.2.7 indicate that the UE is camped on E-UTRAN Cell 3?	-	-	1	-
2A	The SS notifies the UE of change of System Information and changes the system information 3. The <i>systemInfoValueTag</i> in the <i>SystemInformationBlockType1</i> is increased.	<--	<i>Paging</i>	-	-
3	The SS changes Cell 3 power level according to the row "T2" in table 6.1.2.18.3.2-1.	-	-	-	-
4	Check: Does the test result of generic test procedure in TS 36.508 subclause 6.4.2.7 indicate that the UE is camped on E-UTRAN Cell 1?	-	-	2	-

6.1.2.18.3.3 Specific message contents

Table 6.1.2.18.3.3-1: Conditions for specific message contents in Tables 6.1.2.18.3.3-2 and 6.1.2.18.3.3-3

Condition	Explanation
Cell 1	This condition applies to system information transmitted on Cell 1.
Cell 3	This condition applies to system information transmitted on Cell 3.

Table 6.1.2.18.3.3-2: *SystemInformationBlockType3* for Cell 1 and Cell 3 (preamble, Table 6.1.2.18.3.2-2)

Derivation path: 36.508 table 4.4.3.3-2			
Information Element	Value/Remark	Comment	Condition
SystemInformationBlockType3 ::= SEQUENCE {			
cellReselectionServingFreqInfo SEQUENCE {			
threshServingLow	1	2 dB	Cell 3
cellReselectionPriority	5		Cell 3
}			
intraFreqCellReselectionInfo SEQUENCE {			
q-RxLevMin	-50 (-100 dBm)		
}			
lateNonCriticalExtension {			
s-IntraSearch-v920 SEQUENCE {}	Not present		
s-NonIntraSearch-v920 SEQUENCE {}	Not present		
q-QualMin-r9	-20 dB		
threshServingLowQ-r9	0 dB		Cell 1
	4 dB		Cell 3
}			
}			
}			

Table 6.1.2.18.3.3-3: SystemInformationBlockType5 for Cell 1 and Cell 3 (preamble and all steps, Table 6.1.2.18.3.2-2)

Derivation path: 36.508 table 4.4.3.3-4			
Information Element	Value/Remark	Comment	Condition
SystemInformationBlockType5 ::= SEQUENCE {			
interFreqCarrierFreqList SEQUENCE (SIZE (1..maxFreq)) OF SEQUENCE {			
dl-CarrierFreq[n]	EARFCN of Cell 1		Cell 3
	EARFCN of Cell 3		Cell 1
q-RxLevMin[n]	-50 (-100 dBm)		
t-ReselectionEUTRA[n]	7		
threshX-High[n]	10 (20 dB)		Cell 1
cellReselectionPriority[n]	4		Cell 3
	5		Cell 1
q-QualMin-r9[n]	-20 dB		
threshX-Q-r9[n] SEQUENCE {			
threshX-HighQ-r9[n]	4	4 dB	
threshX-LowQ-r9[n]	2	2 dB	
}			
}			
}			

Table 6.1.2.18.3.3-2: SystemInformationBlockType3 for Cell 3 (Step 2A, Table 6.1.2.18.3.2-2)

Derivation path: 36.508 table 4.4.3.3-2			
Information Element	Value/Remark	Comment	Condition
SystemInformationBlockType3 ::= SEQUENCE {			
lateNonCriticalExtension {			
s-IntraSearch-v920 SEQUENCE {}	Not present		
s-NonIntraSearch-v920 SEQUENCE {}	Not present		
q-QualMin-r9	-20 dB		
threshServingLowQ-r9	26 dB		
}			
}			

Table 6.1.2.18.3.3-3: SystemInformationBlockType1 for Cell 3 (Step 2A, Table 6.1.2.18.3.2-2)

Derivation Path: 36.508 table 4.4.3.2-3			
Information Element	Value/remark	Comment	Condition
systemInfoValueTag	1	Previous value is 0	

6.1.2.19 Intra-frequency cell reselection / MFBI

6.1.2.19.1 Test Purpose (TP)

(1)

```

with { UE in E-UTRA RRC_IDLE state }
ensure that {
  when { an equal priority E-UTRAN Intra-frequency neighbouring cell which has been included in the
multiBandInfoList provided by the serving
cell becomes available, and, is better ranked than the serving cell during a time interval
TreslectionRAT, and, more than 1 second has elapsed since the UE camped on the current serving cell
}
then { the UE reselects the new cell }
}

```

6.1.2.19.2 Conformance requirements

References: The conformance requirements covered in the present TC are specified in: TS 36.304, clause 5.2.4.2 and 5.2.4.6, TS 36.331, clause 5.2.2.7 and 6.3.1. Unless otherwise stated these are Rel-8 requirements.

[TS 36.304, clause 5.2.4.2]

When evaluating for reselection purposes cell selection criterion or $S_{\text{nonServingCell}}$, x , the UE shall use parameters provided by the serving cell.

Following rules are used by the UE to limit needed measurements:

- If $S_{\text{intrasearch}}$ is sent in the serving cell and $S_{\text{ServingCell}} > S_{\text{intrasearch}}$, UE may choose to not perform intra-frequency measurements.
- If $S_{\text{ServingCell}} \leq S_{\text{intrasearch}}$, or $S_{\text{intrasearch}}$ is not sent in the serving cell UE shall perform intra-frequency measurements.
- The UE shall apply the following rules for E-UTRAN inter-frequencies and inter-RAT frequencies which are indicated in system information and for which the UE has priority provided as defined in 5.2.4.1:
 - For an E-UTRAN inter-frequency or inter-RAT frequency with a reselection priority higher than the reselection priority of the current E-UTRA frequency the UE shall perform measurements of higher priority E-UTRAN inter-frequency inter-RAT frequencies according to [10].
 - For an E-UTRAN inter-frequency with an equal or lower reselection priority than the reselection priority of the current E-UTRA frequency and for inter-RAT frequency with lower reselection priority than the reselection priority of the current E-UTRAN frequency:
 - If $S_{\text{nonintrasearch}}$ is sent in the serving cell and $S_{\text{ServingCell}} > S_{\text{nonintrasearch}}$ UE may choose not to perform measurements of E-UTRAN inter-frequencies or inter-RAT frequency cells of equal or lower priority.
 - If $S_{\text{ServingCell}} \leq S_{\text{nonintrasearch}}$ or $S_{\text{nonintrasearch}}$ is not sent in the serving cell the UE shall perform measurements of E-UTRAN inter-frequencies or inter-RAT frequency cells of equal or lower priority according to [10].

Where $S_{\text{ServingCell}}$ is the S_{rxlev} -value of the serving cell.

[TS 36.304, clause 5.2.4.6]

The cell-ranking criterion R_s for serving cell and R_n for neighbouring cells is defined by:

$$R_s = Q_{\text{meas},s} + Q_{\text{hyst}_s}$$

$$R_n = Q_{\text{meas},n} - Q_{\text{offset}}$$

where:

Q_{meas}	RSRP measurement quantity used in cell reselections.
Q_{offset}	For intra-frequency: Equals to $Q_{\text{offset}_{s,n}}$, if $Q_{\text{offset}_{s,n}}$ is valid, otherwise this equals to zero. For inter-frequency: Equals to $Q_{\text{offset}_{s,n}}$ plus $Q_{\text{offset}_{\text{frequency}}}$, if $Q_{\text{offset}_{s,n}}$ is valid, otherwise this equals to $Q_{\text{offset}_{\text{frequency}}}$.

The UE shall perform ranking of all cells that fulfil the cell selection criterion S , which is defined in 5.2.3.2, but may exclude all CSG cells that are known by the UE to be not allowed.

The cells shall be ranked according to the R criteria specified above, deriving $Q_{\text{meas},n}$ and $Q_{\text{meas},s}$ and calculating the R values using averaged RSRP results.

If a cell is ranked as the best cell the UE shall perform cell re-selection to that cell. If this cell is found to be not-suitable, the UE shall behave according to subclause 5.2.4.4.

In all cases, the UE shall reselect the new cell, only if the following conditions are met:

- the new cell is better ranked than the serving cell during a time interval $T_{\text{reselection}_{\text{RAT}}}$
- more than 1 second has elapsed since the UE camped on the current serving cell.

[TS 36.331, clause 5.2.2.7]

Upon receiving the *SystemInformationBlockType1* either via broadcast or via dedicated signalling, the UE shall:

- 1> if in RRC_CONNECTED while T311 is not running, and the UE supports multi-band cells as defined by bit 31 in *featureGroupIndicators*:
 - 2> disregard the *freqBandIndicator* and *multiBandInfoList*, if received, while in RRC_CONNECTED;
 - 2> forward the *cellIdentity* to upper layers;
 - 2> forward the *trackingAreaCode* to upper layers;
- 1> else:
 - 2> if the frequency band indicated in the *freqBandIndicator* is part of the frequency bands supported by the UE; or
 - 2> if the UE supports *multiBandInfoList*, and if one or more of the frequency bands indicated in the *multiBandInfoList* are part of the frequency bands supported by the UE:
 - 3> forward the *cellIdentity* to upper layers;
 - 3> forward the *trackingAreaCode* to upper layers;
 - 2> else:
 - 3> consider the cell as barred in accordance with TS 36.304 [4]; and
 - 3> perform barring as if *intraFreqReselection* is set to *notAllowed*, and as if the *csg-Indication* is set to *FALSE*;

[TS 36.331, clause 6.3.1]

- *SystemInformationBlockType2*

The IE *SystemInformationBlockType2* contains radio resource configuration information that is common for all UEs.

NOTE: UE timers and constants related to functionality for which parameters are provided in another SIB are included in the corresponding SIB.

...

SystemInformationBlockType2 field descriptions
<p>multiBandInfoList A list of <i>additionalSpectrumEmission</i> i.e. one for each additional frequency band included in <i>multiBandInfoList</i> in <i>SystemInformationBlockType1</i>, listed in the same order.</p>

6.1.2.19.3 Test description

6.1.2.19.3.1 Pre-test conditions

System Simulator:

- Cell 1 and Cell 2 have different tracking areas according to table 6.0.1-2.
- System information combination 1 as defined in TS 36.508 [18] clause 4.4.3.1 is used in E-UTRA cells.

UE:

None.

Preamble:

- The UE is in state Registered, Idle mode (state 2) on Cell 1 (serving cell) according to [18].

6.1.2.19.3.2 Test procedure sequence

Table 6.1.2.19.3.2-1 illustrates the downlink power levels and other changing parameters to be applied for the cells at various time instants of the test execution. The configuration marked "T1" is applied at the point indicated in the Main behaviour description in Table 6.1.2.19.3.2-2.

Table 6.1.2.19.3.2-1: Time instances of cell power level and parameter changes

	Parameter	Unit	Cell 1	Cell 2	Remark
T1	Cell-specific RS EPRE	dBm/15kHz	-85	-73	The power level values are set so that $R_{Cell 1} < R_{Cell 2}$.

Table 6.1.2.19.3.2-2: Main behaviour

St	Procedure	Message Sequence		TP	Verdict
		U - S	Message		
0	Wait 1 second. (to ensure than 1 second has elapsed since the UE camped on the current serving cell)	-	-	-	-
1	The SS changes the cells power level setting according to the row "T1" in table 6.1.2.19.3.2-1.	-	-	-	-
2	Check: Does the test result of generic test procedure in TS 36.508 subclause 6.4.2.7 indicate that the UE is camped on E-UTRAN Cell 2? NOTE: The UE performs a TAU procedure and the RRC connection is released.	-	-	1	-

6.1.2.19.3.3 Specific message contents

Table 6.1.2.19.3.3-1: SystemInformationBlockType1 for Cell 1 and Cell 2 (preamble and all steps, Table 6.1.2.19.3.2-2)

Derivation Path: 36.508 table 4.4.3.2-3		
Information Element	Value/remark	Comment
SystemInformationBlockType1 ::= SEQUENCE {		
lateNonCriticalExtension		
SystemInformationBlockType1-v8h0-IEs ::= SEQUENCE {		
multiBandInfoList SEQUENCE {		
freqBandIndicator	An overlapping Band under test.	The value shall be same between Cell 1 and Cell 2.
}		
}		
}		

Table 6.1.2.19.3.3-2: SystemInformationBlockType2 for Cell 1 and Cell 2 (preamble and all steps, Table 6.1.2.19.3.2-2)

Derivation Path: 36.508 table 4.4.3.3-1		
Information Element	Value/remark	Comment
SystemInformationBlockType2 ::= SEQUENCE { lateNonCriticalExtension		
SystemInformationBlockType2-v8h0-IEs ::= SEQUENCE { multiBandInfoList SEQUENCE { AdditionalSpectrumEmission	1 (NS_01)	A-MPR doesn't apply by default. See TS 36.101 table 6.2.4-1.
}		
}		
}		

6.1.2.20 Inter-frequency cell reselection / MFBI

6.1.2.20.1 Test Purpose (TP)

(1)

```
with { UE in E-UTRA RRC_IDLE state }
ensure that {
  when { an equal priority E-UTRAN inter-frequency neighbouring cell which has been included in the
multiBandInfoList provided by the serving cell becomes available, and, is better ranked than the
serving cell during a time interval TreselectionRAT, and, more than 1 second has elapsed since the
UE camped on the current serving }
  then { the UE reselects the new cell }
}
```

6.1.2.20.2 Conformance requirements

References: The conformance requirements covered in the present TC are specified in: TS 36.304, clause 5.2.4.6 and TS 36.331, clause 6.3.1. Unless otherwise stated these are Rel-8 requirements.

[TS 36.304, clause 5.2.4.6]

The cell-ranking criterion R_s for serving cell and R_n for neighbouring cells is defined by:

$$R_s = Q_{\text{meas},s} + Q_{\text{Hyst}}$$

$$R_n = Q_{\text{meas},n} - Q_{\text{offset}}$$

where:

Q_{meas}	RSRP measurement quantity used in cell reselections.
Q_{offset}	For intra-frequency: Equals to $Q_{\text{offset},s,n}$, if $Q_{\text{offset},s,n}$ is valid, otherwise this equals to zero. For inter-frequency: Equals to $Q_{\text{offset},s,n}$ plus $Q_{\text{offset},\text{frequency}}$, if $Q_{\text{offset},s,n}$ is valid, otherwise this equals to $Q_{\text{offset},\text{frequency}}$.

The UE shall perform ranking of all cells that fulfil the cell selection criterion S , which is defined in 5.2.3.2, but may exclude all CSG cells that are known by the UE to be not allowed.

The cells shall be ranked according to the R criteria specified above, deriving $Q_{\text{meas},n}$ and $Q_{\text{meas},s}$ and calculating the R values using averaged RSRP results.

If a cell is ranked as the best cell the UE shall perform cell reselection to that cell. If this cell is found to be not-suitable, the UE shall behave according to subclause 5.2.4.4.

In all cases, the UE shall reselect the new cell, only if the following conditions are met:

- the new cell is better ranked than the serving cell during a time interval $T_{reselection_{RAT}}$;
- more than 1 second has elapsed since the UE camped on the current serving cell.

[TS 36.331, clause 6.3.1]

- *SystemInformationBlockType5*

The IE *SystemInformationBlockType5* contains information relevant only for inter-frequency cell re-selection i.e. information about other E-UTRA frequencies and inter-frequency neighbouring cells relevant for cell re-selection. The IE includes cell re-selection parameters common for a frequency as well as cell specific re-selection parameters.

...

<i>SystemInformationBlockType5</i> field descriptions
<p><i>multiBandInfoList</i> Indicates the list of frequency bands in addition to the band represented by <i>dl-CarrierFreq</i> for which cell reselection parameters are common. E-UTRAN indicates at most <i>maxMultiBands</i> frequency bands (i.e. the total number of entries across both <i>multiBandInfoList</i> and <i>multiBandInfoList-v9e0</i> is below this limit).</p>

6.1.2.20.3 Test description

6.1.2.20.3.1 Pre-test conditions

System Simulator:

- Cell 1 and Cell 3 have different tracking areas.
- System information combination 3 as defined in TS 36.508 [18] clause 4.4.3.1 is used in E-UTRA cells.

UE:

None.

Preamble:

- The UE is in state Registered, Idle mode (state 2) on Cell 1 (serving cell) according to [18].

6.1.2.20.3.2 Test procedure sequence

Table 6.1.2.20.3.2-1 illustrates the downlink power levels and other changing parameters to be applied for the cells at various time instants of the test execution. The configuration marked "T1" is applied at the point indicated in the Main behaviour description in Table 6.1.2.20.3.2-2.

Table 6.1.2.20.3.2-1: Time instances of cell power level and parameter changes

	Parameter	Unit	Cell 1	Cell 3	Remark
T1	Cell-specific RS EPRE	dBm/15kHz	-85	-73	The power level values are set so that $R_{Cell\ 1} < R_{Cell\ 2}$.

Table 6.1.2.20.3.2-2: Main behaviour

St	Procedure	Message Sequence		TP	Verdict
		U - S	Message		
0	Wait 1 second (to ensure than 1 second has elapsed since the UE camped on the current serving cell)	-	-	-	-
1	The SS changes the cells power level setting according to the row "T1" in table 6.1.2.20.3.2-1.	-	-	-	-
2	Check: Does the test result of generic test procedure in TS 36.508 subclause 6.4.2.7 indicate that the UE is camped on E-UTRAN Cell 3? NOTE: The UE performs a TAU procedure and the RRC connection is released.	-	-	1	-

6.1.2.20.3.3 Specific message contents

Table 6.1.2.20.3.3-1: SystemInformationBlockType1 for cell 1 (preamble)

Derivation Path: 36.508 table 4.4.3.2-3		
Information Element	Value/remark	Comment
SystemInformationBlockType1 ::= SEQUENCE { lateNonCriticalExtension		
SystemInformationBlockType1-v8h0-IEs ::= SEQUENCE {		
multiBandInfoList SEQUENCE {		
freqBandIndicator	Overlapping Bands for Cell 1 under test.	
}		
}		
}		

Table 6.1.2.20.3.3-2: SystemInformationBlockType5 for cell 1 (preamble)

Derivation Path: 36.508 table 4.4.3.3-4		
Information Element	Value/remark	Comment
SystemInformationBlockType5 ::= SEQUENCE { lateNonCriticalExtension		
SystemInformationBlockType5-v8h0-IEs ::= SEQUENCE {		
InterFreqCarrierFreqList-v8h0 SEQUENCE {		
InterFreqCarrierFreqInfo-v8h0 SEQUENCE {		
multiBandInfoList SEQUENCE {		
freqBandIndicator	Overlapping Bands for Cell 3 under test.	
}		
}		
}		
}		

6.1.2.21 Inter-band cell reselection / MFBI

6.1.2.21.1 Test Purpose (TP)

(1)

```
with { UE in E-UTRA RRC_IDLE state }
ensure that {
  when { an equal priority E-UTRAN another band neighbouring cell which has been included in the
multiBandInfoList provided by the serving cell becomes available, and, is better ranked than the
serving cell during a time interval TreselectionRAT, and, more than 1 second has elapsed since the
UE camped on the current serving cell }
```

```

then { the UE reselects the new cell }
}
    
```

6.1.2.21.2 Conformance requirements

References: The conformance requirements covered in the present TC are specified in: TS 36.304, clause 5.2.4.5 and 5.2.4.6; TS 36.331, clause 6.3.1. Unless otherwise stated these are Rel-8 requirements.

[TS 36.304, clause 5.2.4.5]

Cell reselection to a cell on an equal priority E-UTRAN frequency shall be based on ranking for Intra-frequency cell reselection as defined in sub-clause 5.2.4.6.

[TS 36.304, clause 5.2.4.6]

The cell-ranking criterion R_s for serving cell and R_n for neighbouring cells is defined by:

$R_s = Q_{meas,s} + Q_{Hyst}$
$R_n = Q_{meas,n} - Q_{offset}$

where:

Q_{meas}	RSRP measurement quantity used in cell reselections.
Q_{offset}	For intra-frequency: Equals to $Q_{offset_{s,n}}$, if $Q_{offset_{s,n}}$ is valid, otherwise this equals to zero. For inter-frequency: Equals to $Q_{offset_{s,n}}$ plus $Q_{offset_{frequency}}$, if $Q_{offset_{s,n}}$ is valid, otherwise this equals to $Q_{offset_{frequency}}$.

The UE shall perform ranking of all cells that fulfil the cell selection criterion S, which is defined in 5.2.3.2, but may exclude all CSG cells that are known by the UE to be not allowed.

The cells shall be ranked according to the R criteria specified above, deriving $Q_{meas,n}$ and $Q_{meas,s}$ and calculating the R values using averaged RSRP results.

If a cell is ranked as the best cell the UE shall perform cell reselection to that cell. If this cell is found to be not-suitable, the UE shall behave according to subclause 5.2.4.4.

In all cases, the UE shall reselect the new cell, only if the following conditions are met:

- the new cell is better ranked than the serving cell during a time interval $T_{reselection_{RAT}}$;
- more than 1 second has elapsed since the UE camped on the current serving cell.

[TS 36.331, clause 6.3.1]

- *SystemInformationBlockType5*

The IE *SystemInformationBlockType5* contains information relevant only for inter-frequency cell re-selection i.e. information about other E-UTRA frequencies and inter-frequency neighbouring cells relevant for cell re-selection. The IE includes cell re-selection parameters common for a frequency as well as cell specific re-selection parameters.

...

SystemInformationBlockType5 field descriptions
<p>multiBandInfoList Indicates the list of frequency bands in addition to the band represented by <i>dl-CarrierFreq</i> for which cell reselection parameters are common. E-UTRAN indicates at most <i>maxMultiBands</i> frequency bands (i.e. the total number of entries across both <i>multiBandInfoList</i> and <i>multiBandInfoList-v9e0</i> is below this limit).</p>

6.1.2.21.3 Test description

6.1.2.21.3.1 Pre-test conditions

System Simulator:

- Cell 1 and Cell 10 have different tracking areas according to table 6.0.1-2.
- System information combination 3 as defined in TS 36.508 [18] clause 4.4.3.1 is used in E-UTRA cells.

UE:

None.

Preamble:

- The UE is in state Registered, Idle mode (state 2) on Cell 1 (serving cell) according to [18].

6.1.2.21.3.2 Test procedure sequence

Table 6.1.2.21.3.2-1 illustrates the downlink power levels and other changing parameters to be applied for the cells at various time instants of the test execution. The configuration marked "T1" is applied at the point indicated in the Main behaviour description in Table 6.1.2.21.3.2-2.

Table 6.1.2.21.3.2-1: Time instances of cell power level and parameter changes

	Parameter	Unit	Cell 1	Cell 10	Remark
T1	Cell-specific RS EPRE	dBm/15kHz	-85	-73	Cell 10 become stronger than $\text{Thresh}_{x, \text{high}}$.

Table 6.1.2.21.3.2-2: Main behaviour

St	Procedure	Message Sequence		TP	Verdict
		U - S	Message		
0	Wait 1 second. (to ensure than 1 second has elapsed since the UE camped on the current serving cell)	-	-	-	-
1	The SS changes the cells power level setting according to the row "T1" in table 6.1.2.21.3.2-1.	-	-	-	-
2	Check: Does the test result of generic test procedure in TS 36.508 subclause 6.4.2.7 indicate that the UE is camped on E-UTRAN Cell 10? NOTE: The UE performs a TAU procedure and the RRC connection is released.	-	-	1	-

6.1.2.21.3.3 Specific message contents

Table 6.1.2.21.3.3-0: Conditions for specific message contents in Tables 6.1.2.21.3.3-3 and 6.1.2.21.3.3-4

Condition	Explanation
Cell 1	This condition applies to system information transmitted on Cell 1.
Cell 10	This condition applies to system information transmitted on Cell 10.

Table 6.1.2.21.3.3-1: SystemInformationBlockType1 for Cell 10 (preamble and all steps, Table 6.1.2.21.3.2-2)

Derivation Path: 36.508 table 4.4.3.2-3		
Information Element	Value/remark	Comment
SystemInformationBlockType1 ::= SEQUENCE {		
lateNonCriticalExtension		
SystemInformationBlockType1-v8h0-IEs ::= SEQUENCE {		
multiBandInfoList SEQUENCE {		
freqBandIndicator	An overlapping Band for Cell 10 under test.	
}		
}		
}		

Table 6.1.2.21.3.3-2: SystemInformationBlockType2 for Cell 10 (preamble and all steps, Table 6.1.2.21.3.2-2)

Derivation Path: 36.508 table 4.4.3.3-1		
Information Element	Value/remark	Comment
SystemInformationBlockType2 ::= SEQUENCE {		
lateNonCriticalExtension		
SystemInformationBlockType2-v8h0-IEs ::= SEQUENCE {		
multiBandInfoList SEQUENCE {		
AdditionalSpectrumEmission	1 (NS_01)	A-MPR doesn't apply by default. See TS 36.101 table 6.2.4-1.
}		
}		
}		

Table 6.1.2.21.3.3-3: SystemInformationBlockType3 for Cell 1 and Cell 10 (preamble and all steps, Table 6.1.2.21.3.2-2)

Derivation path: 36.508 table 4.4.3.3-2			
Information Element	Value/Remark	Comment	Condition
SystemInformationBlockType3 ::= SEQUENCE {			
cellReselectionServingFreqInfo SEQUENCE {			
cellReselectionPriority	1		Cell 1
	5		Cell 10
}			
}			

Table 6.1.2.21.3.3-4: SystemInformationBlockType5 for Cell 1 and Cell 10 (preamble and all steps, Table 6.1.2.21.3.2-2)

Derivation Path: 36.508 table 4.4.3.3-4			
Information Element	Value/remark	Comment	Condition
SystemInformationBlockType5 ::= SEQUENCE {			
interFreqCarrierFreqList SEQUENCE (SIZE (1..maxFreq)) OF SEQUENCE {			
dl-CarrierFreq	Same downlink EARFCN as used for Cell 10		Cell 1
	Same downlink EARFCN as used for Cell 1		Cell 10
t-ReselectionEUTRA	7		
threshX-High	10	20dB	
cellReselectionPriority	5		Cell 1
	1		Cell 10
}			
lateNonCriticalExtension			Cell 1
SystemInformationBlockType5-v8h0-IEs ::= SEQUENCE {			Cell 1
InterFreqCarrierFreqList-v8h0 SEQUENCE (SIZE (1..maxFreq)) OF SEQUENCE {			Cell 1
InterFreqCarrierFreqInfo-v8h0 [n] SEQUENCE {			Cell 1
multiBandInfoList SEQUENCE {			Cell 1
freqBandIndicator	An overlapping Band for Cell 10 under test.		Cell 1
}			
}			
}			
}			

6.2 Multi-mode environment (E-UTRAN, UTRAN, GERAN, CDMA2000)

6.2.1 Inter-RAT PLMN selection

6.2.1.1 Inter-RAT PLMN Selection / Selection of correct RAT for OPLMN / Automatic mode

6.2.1.1.1 Test Purpose (TP)

(1)

```
with { UE pre-set in Automatic network selection mode }
ensure that {
  when { UE is switched on and there are suitable E-UTRAN and UTRAN cells some on the OPLMN list and
some not on the OPLMN list, none of them being part of the RPLMN }
  then { UE selects the highest priority OPLMN and RAT combination, attaches on the selected cell
and when successfully registered indicates the PLMN to the user }
}
```

(2)

```
with { UE in Automatic network selection mode }
ensure that {
  when { UE returns to coverage and there are suitable E-UTRAN and GERAN cells some on the OPLMN
list and some not on the OPLMN list, none of them being part of the RPLMN }
  then { UE selects the highest priority OPLMN and RAT combination, attaches on the selected cell
and when successfully registered indicates the PLMN to the user }
}
```

(3)

```
with { UE in Automatic network selection mode }
```

```

ensure that {
  when { UE returns to coverage and there are suitable E-UTRAN and UTRAN cells some on the OPLMN
list and some not on the OPLMN list , none of them being part of the RPLMN }
  then { UE selects the highest priority OPLMN and RAT combination, attaches on the selected cell
and when successfully registered indicates the PLMN to the user }
}

```

6.2.1.1.2 Conformance requirements

References: The conformance requirements covered in the present TC are specified in: TS 23.122 clauses 4.4.3.1 and 4.4.3.1.1.

[TS 23.122, clause 4.4.3.1]

If successful registration is achieved, the MS indicates the selected PLMN.

...

NOTE 1: If successful registration is achieved, then the current serving PLMN becomes the registered PLMN and the MS does not store the previous registered PLMN for later use.

[TS 23.122, clause 4.4.3.1.1]

The MS selects and attempts registration on other PLMN/access technology combinations, if available and allowable, in the following order:

- i) either the HPLMN (if the EHPLMN list is not present or is empty) or the highest priority EHPLMN that is available (if the EHPLMN list is present) ;
- ii) each PLMN/access technology combination in the "User Controlled PLMN Selector with Access Technology" data file in the SIM (in priority order);
- iii) each PLMN/access technology combination in the "Operator Controlled PLMN Selector with Access Technology" data file in the SIM (in priority order);
- iv) other PLMN/access technology combinations with received high quality signal in random order;
- v) other PLMN/access technology combinations in order of decreasing signal quality.

6.2.1.1.3 Test description

6.2.1.1.3.1 Pre-test conditions

System Simulator

5 cells are used maximum 3 are operating at the same time:

- 3 cells belong to E-UTRAN (Cell 1, Cell 2 and Cell 3)
- IF pc_GERAN 1 cell belongs to GERAN (Cell 24)
- 1 cell belongs to UTRAN (Cell 9).
- System information combination 1 as defined in TS 36.508 [18] clause 4.4.3.1 is used in E-UTRA cells.

UE

- The UE is in Automatic PLMN selection mode.
- The HPLMN is PLMN1
- There is no RPLMN.

Table 6.2.1.1.3.1-1: USIM configuration IF pc_GERAN

USIM field	Priority	Value	Access technology	Comment
EF _{PLMNwAcT}		3GPP TS 31.102, Annex E		The EF is empty.
EF _{OPLMNwAcT}	1	PLMN2	E-UTRAN	
	2	PLMN13	GERAN	
	3	PLMN13	UTRAN	
	4	PLMN13	E-UTRAN	

Table 6.2.1.1.3.1-2: USIM configuration IF NOT pc_GERAN

USIM field	Priority	Value	Access technology	Comment
EF _{PLMNwAcT}		3GPP TS 31.102, Annex E		The EF is empty.
EF _{OPLMNwAcT}	1	PLMN2	E-UTRAN	
	2	PLMN13	UTRAN	
	3	PLMN13	E-UTRAN	

Preamble

- The UE is in state Switched OFF (State 1)

6.2.1.1.3.2 Test procedure sequence

Tables 6.2.1.1.3.2-1 and 2 show the cell configurations used during the test. The configuration T0 indicates the initial conditions. Subsequent configuration marked "T1" to "T4" are applied at the point indicated in the Main behaviour description in Table 6.2.1.1.3.2-3. Cell powers for the E-UTRAN, UTRAN and GERAN cells are defined in TS 36.508 Table 6.2.2.1-1.

Table 6.2.1.1.3.2-1: Cell PLMN identities

Cell	PLMN name
1	PLMN2
9	PLMN13
3	PLMN14
24	PLMN13
2	PLMN13

Table 6.2.1.1.3.2-2: Time instances of cell power level and parameter changes

	Parameter name	Unit	Cell 1	Cell 2*	Cell 3*	Cell 9	Cell 24
T0	RS EPRE	dBm/15kHz	Serving cell	OFF	Serving cell		
	CPICH_Ec	dBm/3.84 MHz				Serving cell	
	P-CCPCH	dBm/1.28 MHz				Serving cell	
	RF Signal Level	dBm					OFF
T1	RS EPRE	dBm/15kHz	OFF	Serving cell	Serving cell		
	CPICH_Ec	dBm/3.84 MHz				Serving cell	
	P-CCPCH	dBm/1.28 MHz				Serving cell	
	RF Signal Level	dBm					OFF
T2	RS EPRE	dBm/15kHz	Serving cell	OFF	OFF		
	CPICH_Ec	dBm/3.84 MHz				OFF	
	P-CCPCH	dBm/1.28 MHz				OFF	
	RF Signal Level	dBm					OFF
T3	RS EPRE	dBm/15kHz	Serving cell	OFF	Serving cell		
	CPICH_Ec	dBm/3.84 MHz				OFF	
	P-CCPCH	dBm/1.28 MHz				OFF	
	RF Signal Level	dBm					Serving cell
T4	RS EPRE	dBm/15kHz	OFF	Serving cell	Serving cell		
	CPICH_Ec	dBm/3.84 MHz				OFF	
	P-CCPCH	dBm/1.28 MHz				OFF	
	RF Signal Level	dBm					Serving cell

*Only minimum uplink cell configuration required (See 6.3.3.2 in 36.508)

Table 6.2.1.1.3.2-3: Main behaviour

St	Procedure	Message Sequence		TP	Verdict
		U – S	Message		
1	The UE is switched on.	-	-	-	-
2	Check: Does the UE send <i>RRCCONNECTIONREQUEST</i> on Cell 1?	-->	<i>RRCCONNECTIONREQUEST</i>	1	P
3-17	The UE performs Steps 3-17 of the registration procedure described in TS 36.508 table 4.5.2.3-1.	-	-	-	-
18	Check: Is PLMN2 indicated by the UE as the PLMN on which the UE is camped?	-	-	1	P
19	SS adjusts cell levels according to row T1 of table 6.2.1.1.3.2-2.	-	-	-	-
19A	Check: Does the UE send RRC CONNECTION REQUEST on Cell 9?	-->	RRC CONNECTION REQUEST	3	P
19B-19J	The UE performs Steps 2-10 of the routing area update procedure described in TS 36.508 Table 6.4.2.8-1.	-	-	-	-
19K	Check: Is PLMN13 indicated by the UE as the PLMN on which the UE is camped?	-	-	3	P
-	EXCEPTION: Steps 20a1 to 20a32 describe behaviour that depends on UE capabilities; the "lower case letter" identifies a step sequence that take place if the UE supports GERAN.				
20a1	IF pc_GERAN THEN SS adjusts cell levels according to row T2 of table 6.2.1.1.3.2-2.	-	-	-	-
20a2	The UE send <i>RRCCONNECTIONREQUEST</i> on Cell 1	-->	<i>RRCCONNECTIONREQUEST</i>	-	-
20a3-20a17	The UE performs Steps 3-17 of the registration procedure described in TS 36.508 table 4.5.2.3-1.	-	-	-	-
20a18	SS adjusts cell levels according to row T3 of table 6.2.1.1.3.2-2.	-	-	-	-
20a19	Wait for 1s to allow the stable cell condition before the next cell adjustments and catch any not allowed UE behaviour (the UE is expected not to do anything).	-	-	-	-
20a20	SS adjusts cell levels according to row T4 of table 6.2.1.1.3.2-2.	-	-	-	-
20a21-20a30	Check: Does the UE send a CHANNEL REQUEST on Cell 24?	-->	CHANNEL REQUEST	2	P
20a31	The UE performs Steps 2-11 of the routing area update procedure described in 36.508 table 6.4.2.9-1.	-	-	-	-
20a32	Check: Is PLMN13 indicated by the UE?	-	-	2	P
21-46	Void	-	-	-	-

6.2.1.1.3.3 Specific message contents

Table 6.2.1.1.3.3-1: System Information Block type 19 for Cell 9 (preamble and all steps from step 1 up to step 20a1, Table 6.2.1.1.3.2-3)

Derivation Path: 36.508 table 4.4.4.1-1			
Information Element	Value/remark	Comment	Condition
SysInfoType19 ::= SEQUENCE {			
eutra-FrequencyAndPriorityInfoList	Not present		
}			

Table 6.2.1.1.3.3-2: Repeated E-UTRAN Neighbour Cells struct of SI2Quater for Cell 24 (step 20a2 onwards, Table 6.2.1.1.3.2-3)

Derivation Path: 36.508 table 4.4.5-1			
Information Element	Value/remark	Comment	Condition
Repeated E-UTRAN Neighbour Cells	0	Not Present	

6.2.1.2 Inter-RAT PLMN Selection / Selection of correct RAT for UPLMN / Automatic mode

6.2.1.2.1 Test Purpose (TP)

(1)

```
with { UE in Automatic network selection mode and UPLMN and OPLMN cells available on E-UTRAN and UTRAN}
ensure that {
  when { UE is switched on}
  then { UE selects a the highest priority UPLMN and RAT combination and UE attempts to attach on the selected cell and when successfully registered indicates the PLMN to the user. }
}
```

(2)

```
with { UE in Automatic network selection mode and UPLMN and OPLMN cells available on E-UTRAN and UTRAN}
ensure that {
  when { UE returns to coverage}
  then { UE selects a the highest priority VPLMN and RAT combination and UE attempts to attach on the selected cell and when successfully registered indicates the PLMN to the user. }
}
```

6.2.1.2.2 Conformance requirements

References: The conformance requirements covered in the present TC are specified in: TS 23.122 clauses 4.4.3.1 and 4.4.3.1.1.

[TS 23.122, clause 4.4.3.1]

If successful registration is achieved, the MS indicates the selected PLMN.

...

NOTE 1: If successful registration is achieved, then the current serving PLMN becomes the registered PLMN and the MS does not store the previous registered PLMN for later use.

[TS 23.122, clause 4.4.3.1.1]

The MS selects and attempts registration on other PLMN/access technology combinations, if available and allowable, in the following order:

- i) either the HPLMN (if the EHPLMN list is not present or is empty) or the highest priority EHPLMN that is available (if the EHPLMN list is present) ;
- ii) each PLMN/access technology combination in the "User Controlled PLMN Selector with Access Technology" data file in the SIM (in priority order);
- iii) each PLMN/access technology combination in the "Operator Controlled PLMN Selector with Access Technology" data file in the SIM (in priority order);
- iv) other PLMN/access technology combinations with received high quality signal in random order;
- v) other PLMN/access technology combinations in order of decreasing signal quality.

6.2.1.2.3 Test description

6.2.1.2.3.1 Pre-test conditions

System Simulator

- 3 cells are used: 2 cells belong to E-UTRAN and 1 cell belongs to UTRAN. The cells are configured as specified in TS 36.508 clause 4.4.1.4 and Table 4.4.2-2.
- System information combination 1 as defined in TS 36.508 [18] clause 4.4.3.1 is used in E-UTRA cells.

UE

- The UE is in Automatic PLMN selection mode.
- The HPLMN is PLMN1
- There is no RPLMN.

Table 6.2.1.2.3.1-1: USIM configuration

USIM field	Priority	Value	Access technology	Comment
EF _{PLMNwAcT}	1	PLMN13	E-UTRAN	
	2	PLMN14	UTRAN	
EF _{OPLMNwAcT}	1	PLMN2	All	
	2	PLMN14	UTRAN	
	3	PLMN13	E-UTRAN	

Preamble

- The UE is in state Switched OFF (State 1)
- Cell levels are set according to row T0 of table 6.2.1.2.3.2-2.

6.2.1.2.3.2 Test procedure sequence

Tables 6.2.1.2.3.2 – 1 and 2 show the cell configurations used during the test. The configuration T0 indicates the initial conditions. Subsequent configuration marked “T1” is applied at the point indicated in the Main behaviour description in Table 6.2.1.2.3.2-3. Cell powers for the E-UTRAN cell are defined in TS36.508 Table 6.2.2.1-1 and cell powers for the UTRAN cells are defined in TS 36.508 Table 6.2.2.1-1.

Table 6.2.1.2.3.2-1: Cell PLMN identities

Cell	PLMN name
1	PLMN2
9	PLMN14
12	PLMN13

Table 6.2.1.2.3.2-2: Time instances of cell power level and parameter changes

	Parameter name	Unit	Cell 1*	Cell 9	Cell 12
T0	RS EPRE	dBm/15kHz	Serving cell		Serving cell
	CPICH_Ec	dBm/3.84 MHz		Serving cell	
	P-CCPCH	dBm/1.28 MHz		Serving cell	
T1	RS EPRE	dBm/15kHz	Serving cell		Non-suitable “Off”
	CPICH_Ec	dBm/3.84 MHz		Serving cell	
	P-CCPCH	dBm/1.28 MHz		Serving cell	

*Only minimum uplink cell configuration required (See 6.3.3.2 in 36.508)

Table 6.2.1.2.3.2-3: Main behaviour

St	Procedure	Message Sequence		TP	Verdict
		U – S	Message		
1	The UE is switched on.	-	-	-	-
2	Check: Does the UE send <i>RRCConnectionRequest</i> on Cell 12?	-->	<i>RRCConnectionRequest</i>	1	P
3-17	The UE performs Steps 3-17 of the registration procedure described in TS 36.508 table 4.5.2.3-1.	-	-	-	-
18	Check: Is PLMN13 indicated by the UE?	-	-	1	P
19	SS adjusts cell levels according to row T1 of table 6.2.1.2.3.2-2.	-	-	-	-
20	Check: Does the UE send a RRC CONNECTION REQUEST on Cell 9?	-->	RRC CONNECTION REQUEST	2	P
21-29	The UE performs Steps 2-10 of the routing area update procedure described in TS 36.508 Table 6.4.2.8-1.	-	-	-	-
30	Check: Is PLMN14 indicated by the UE?	-	-	2	P

6.2.1.2.3.3 Specific message contents

Table 6.2.1.2.3.3-1: System Information Block type 19 for Cell 9 (preamble and all steps, Table 6.2.1.2.3.2-2)

Derivation Path: 36.508 table 4.4.4.1-1			
Information Element	Value/remark	Comment	Condition
SysInfoType19 ::= SEQUENCE {			
eutra-FrequencyAndPriorityInfoList	Not present		

6.2.1.3 Inter-RAT PLMN Selection / Selection of correct PLMN and RAT in shared network environment / Automatic mode

6.2.1.3.1 Test Purpose (TP)

(1)

```

with { UE in Automatic network selection mode and shared OPLMN cells available on E-UTRAN and UTRAN
}
ensure that {
  when { UE is switched on}
  then { UE selects a the highest priority OPLMN and RAT combination and UE attempts to attach on
the selected cell and PLMN and when successfully registered indicates the correct PLMN to the user.
}
}

```

(2)

```

with { UE in Automatic network selection mode and shared OPLMN cells available on E-UTRAN and UTRAN
}
ensure that {
  then { UE selects a the highest priority OPLMN and RAT combination and UE attempts to attach on
the selected cell and PLMN and when successfully registered indicates the correct PLMN to the user.
}
}

```

6.2.1.3.2 Conformance requirements

References: The conformance requirements covered in the present TC are specified in: TS 23.122 clauses 4.4.3, 4.4.3.1 and 4.4.3.1.1.

[TS 23.122, clause 4.4.3]

When the MS reselects to a cell in a shared network, the AS may indicate multiple PLMN identities to the NAS according to 3GPP TS 25.304 [32]. The MS shall choose one of these PLMNs. If the registered PLMN is available among these PLMNs, the MS shall not choose a different PLMN.

[TS 23.122, clause 4.4.3.1]

At switch on, or following recovery from lack of coverage, the MS selects the registered PLMN or equivalent PLMN (if it is available) using all access technologies that the MS is capable of and if necessary (in the case of recovery from lack of coverage, see subclause 4.5.2) attempts to perform a Location Registration.

...

If successful registration is achieved, the MS indicates the selected PLMN.

[TS 23.122, clause 4.4.3.1.1]

The MS selects and attempts registration on other PLMN/access technology combinations, if available and allowable, in the following order:

- i) either the HPLMN (if the EHPLMN list is not present or is empty) or the highest priority EHPLMN that is available (if the EHPLMN list is present) ;
- ii) each PLMN/access technology combination in the "User Controlled PLMN Selector with Access Technology" data file in the SIM (in priority order);
- iii) each PLMN/access technology combination in the "Operator Controlled PLMN Selector with Access Technology" data file in the SIM (in priority order);
- iv) other PLMN/access technology combinations with received high quality signal in random order;
- v) other PLMN/access technology combinations in order of decreasing signal quality.

6.2.1.3.3 Test description

6.2.1.3.3.1 Pre-test conditions

System Simulator

- 3 cells are used: 2 cells belong to E-UTRAN and 1 cell belongs to UTRAN. The cells are configured as specified in TS 36.508 clause 4.4.1.4 and Table 4.4.2-2.

UE

- The UE is in Automatic PLMN selection mode.
- The HPLMN is PLMN1.
- There is no RPLMN.

Table 6.2.1.3.3.1-1: USIM configuration

USIM field	Priority	Value	Access technology	Comment
EF _{OPLMNwAcT}	1	PLMN2	E-UTRAN	
	2	PLMN2	UTRAN	
	3	PLMN14	UTRAN	
	4	PLMN13	E-UTRAN	

Preamble

- The UE is in state Switched OFF (State 1)
- Cell levels are set according to row T0 of table 6.2.1.3.3.2-2.

6.2.1.3.3.2 Test procedure sequence

Tables 6.2.1.3.3.2 – 1 and 2 show the cell configurations used during the test. The configuration T0 indicates the initial conditions. Subsequent configuration marked "T1" is applied at the point indicated in the Main behaviour description in Table 6.2.1.3.3.2-3. Cell powers for the E-UTRAN cell are defined in TS 36.508 Table 6.2.2.1-1 and cell powers for the UTRAN cells are defined in TS 36.508 Table 6.2.2.1-1.

Table 6.2.1.3.3.2-1: Cell PLMN identities

Cell	PLMN name
1	PLMN13,PLMN2
9	PLMN14, PLMN13
12	PLMN13, PLMN14

Table 6.2.1.3.3.2-2: Time instances of cell power level and parameter changes

	Parameter name	Unit	Cell 1	Cell 9	Cell 12*
T0	RS EPRE	dBm/15kHz	Serving cell		Serving cell
	CPICH_Ec	dBm/3.84 MHz		Serving cell	
	P-CCPCH	dBm/1.28 MHz		Serving cell	
T1	RS EPRE	dBm/15kHz	Non-suitable "Off"		Serving cell
	CPICH_Ec	dBm/3.84 MHz		Serving cell	
	P-CCPCH	dBm/1.28 MHz		Serving cell	

*Only minimum uplink cell configuration required (See 6.3.3.2 in 36.508)

Table 6.2.1.3.3.2-3: Main behaviour

St	Procedure	Message Sequence		TP	Verdict
		U – S	Message		
1	The UE is switched on.	-	-	-	-
2	Check: Does the UE send <i>RRCConnectionRequest</i> on Cell 1?	-->	<i>RRCConnectionRequest</i>	1	P
3-17	The UE performs Steps 3-17 of the registration procedure described in TS 36.508 table 4.5.2.3-1.	-	-	-	-
18	Check: Is PLMN2 indicated by the UE?	-	-	1	P
19	SS adjusts cell levels according to row T1 of table 6.2.1.3.3.2-2.	-	-	-	-
20	Check: Does the UE send a RRC CONNECTION REQUEST on Cell 9?	-->	RRC CONNECTION REQUEST	2	P
20 A	Void	-	-	-	-
20 B	Void	-	-	-	-
21-29	The UE performs Steps 2-10 of the routing area update procedure described in TS 36.508 Table 6.4.2.8-1.	-	-	-	-
30	Check: Is PLMN14 indicated by the UE?	-	-	2	P

6.2.1.3.3.3 Specific message contents

Table 6.2.1.3.3.3-1: SystemInformationBlockType1 for Cell 1(all steps, Table 6.2.1.3.3.2-3)

Derivation path: 36.508 Table 4.4.3.2-3			
Information Element	Value/Remark	Comment	Condition
SystemInformationBlockType1 ::= SEQUENCE { cellAccessRelatedInfo SEQUENCE { plmn-IdentityList SEQUENCE (SIZE (1..6)) OF SEQUENCE { plmn-Identity[1] plmn-Identity[2] } } }	PLMN13. PLMN2		

Table 6.2.1.3.3.2: MasterInformationBlock for Cell 9 (all steps, Table 6.2.1.3.3.2-3)

Derivation path: 34.108 Section 6.1.0a			
Information Element	Value/Remark	Comment	Condition
- Supported PLMN types - PLMN type - PLMN identity - Multiple PLMN List - MIB PLMN Identity - PLMN identity with Optional MCC[1]	GSM-MAP PLMN14 TRUE PLMN13		

Table 6.2.1.3.3.3-3: SystemInformationBlockType1 for Cell 12 (all steps, Table 6.2.1.3.3.2-3)

Derivation path: 36.508 Table 4.4.3.2-3			
Information Element	Value/Remark	Comment	Condition
SystemInformationBlockType1 ::= SEQUENCE { cellAccessRelatedInfo SEQUENCE { plmn-IdentityList SEQUENCE (SIZE (1..6)) OF SEQUENCE { plmn-Identity[1] plmn-Identity[2] } } }	PLMN13 PLMN14		

Table 6.2.1.3.3-4: RRCConnectionSetupComplete (Step 5, Table 6.2.1.3.3.2-3)

Derivation Path: 36.331 clause 6.2.2			
Information Element	Value/remark	Comment	Condition
RRCConnectionSetupComplete ::= SEQUENCE { criticalExtensions CHOICE { c1 CHOICE { rrcConnectionSetupComplete-r8 SEQUENCE { selectedPLMN-Identity } } }	2	PLMN2	

Table 6.2.1.3.3-5: INITIAL DIRECT TRANSFER (Step 23, Table 6.2.1.3.3.2-3)

Derivation Path: 34.108 clause 9.1.1			
Information Element	Value/remark	Comment	Condition
PLMN identity	PLMN14		
Intra Domain NAS Node Selector - CHOICE version - CHOICE CN type - CHOICE Routing basis	R99 GSM-MAP (P)TMSI of different PLMN		

Table 6.2.1.3.3-6: System Information Block type 19 for Cell 9 (all steps, Table 6.2.1.3.3.2-3)

Derivation Path: 36.508 table 4.4.4.1-1			
Information Element	Value/remark	Comment	Condition
SysInfoType19 ::= SEQUENCE { eutra-FrequencyAndPriorityInfoList ::= SEQUENCE (SIZE (1..maxNumEUTRAFreqs)) OF SEQUENCE { earfcn [n] priority [n] } }	Same downlink EARFCN as used for Cell 12 2		

6.2.1.4 Inter-RAT PLMN Selection / Selection of correct RAT from the OPLMN list / Manual mode

6.2.1.4.1 Test Purpose (TP)

(1)

```
with { UE in Manual network selection mode and OPLMN cells available on E-UTRAN and GERAN}
ensure that {
  when { the USER selects an OPLMN}
  then { UE selects a the highest priority RAT for the OPLMN and UE attempts to attach on the
selected cell and when successfully registered indicates the PLMN to the user. }
}
```

(2)

```
with { UE in Manual network selection mode and OPLMN cells available on E-UTRAN and GERAN}
ensure that {
  when { the USER selects an OPLMN and RAT combination}
  then {UE attempts to attach on the selected OPLMN and RAT combination and when successfully
registered indicates the PLMN to the user. }
}
```

6.2.1.4.2 Conformance requirements

References: The conformance requirements covered in the present TC are specified in: TS 23.122 clauses 4.4.3.1.2.

[TS 23.122, clause 4.4.3.1.2]

The MS indicates whether there are any PLMNs, which are available using all supported access technologies. This includes PLMNs in the "forbidden PLMNs" list and PLMNs which only offer services not supported by the MS. An MS which supports GSM COMPACT shall also indicate GSM COMPACT PLMNs (which use PBCCH).

If displayed, PLMNs meeting the criteria above are presented in the following order:

- i)- either the HPLMN (if the EHPLMN list is not present or is empty) or, if one or more of the EHPLMNs are available then based on an optional data field on the SIM either only the highest priority available EHPLMN is to be presented to the user_or all available EHPLMNs are presented to the user in priority order. If the data field is not present on the SIM, then only the highest priority available EHPLMN is presented;
- ii)- PLMN/access technology combinations contained in the " User Controlled PLMN Selector with Access Technology " data file in the SIM (in priority order);
- iii)- PLMN/access technology combinations contained in the "Operator Controlled PLMN Selector with Access Technology" data file in the SIM (in priority order);
- iv)- other PLMN/access technology combinations with received high quality signal in random order;
- v)- other PLMN/access technology combinations in order of decreasing signal quality.

...

The user may select his desired PLMN and the MS then initiates registration on this PLMN using the access technology chosen by the user for that PLMN or using the highest priority available access technology for that PLMN, if the associated access technologies have a priority order. (This may take place at any time during the presentation of PLMNs). For such a registration, the MS shall ignore the contents of the "forbidden LAs for roaming", "forbidden TAs for roaming", "forbidden LAs for regional provision of service", "forbidden TAs for regional provision of service", "forbidden PLMNs for GPRS service" and "forbidden PLMNs" lists.

NOTE 1: It is an MS implementation option whether to indicate access technologies to the user. If the MS does display access technologies, then the access technology selected by the user is only used for initial registration on the selected PLMN. If the MS does not display access technologies, then the access technology chosen for a particular PLMN should be the highest priority available access technology for that PLMN, if the associated access technologies have a priority order, and is only used for initial registration.

6.2.1.4.3 Test description

6.2.1.4.3.1 Pre-test conditions

System Simulator

- 3 cells are used: 2 cells belong to E-UTRAN and 1 cell belongs to GERAN. The cells are configured as specified in TS 36.508 clause 4.4.1.4 and Table 4.4.2-2.

UE

- The HPLMN is PLMN1.

Table 6.2.1.4.3.1-1: USIM configuration

USIM field	Priority	Value	Access technology	Comment
EF _{OPLMNwAcT}	1	PLMN2	E-UTRAN	
	2	PLMN2	GERAN	
	3	PLMN2	UTRAN	
	4	PLMN13	E-UTRAN	

Preamble

- The UE is equipped with a USIM with default settings except for the ones specified in table 6.2.1.4.3.1-1 then the UE is attached to PLMN1 and the UE is set to Manual PLMN selection mode before it is switched off.
- Cell levels are set according to row T0 of table 6.2.1.4.3.2-2.

6.2.1.4.3.2 Test procedure sequence

Tables 6.2.1.4.3.2 – 1 and 2 show the cell configurations used during the test. The configuration T0 indicates the initial conditions. Cell powers for the E-UTRAN cell are defined in TS36.508 Table 6.2.2.1-1 and cell powers for the GERAN cell are defined in TS 36.508 Table 6.2.2.1-1.

Table 6.2.1.4.3.2-1: Cell PLMN identities

Cell	PLMN name
1	PLMN2
12	PLMN13
24	PLMN2

Table 6.2.1.4.3.2-2: Time instances of cell power level and parameter changes

	Parameter name	Unit	Cell 1	Cell 12*	Cell 24
T0	RS EPRE	dBm/15kHz	Serving cell	Serving cell	
	RF Signal Level	dBm			Serving cell
*Only minimum uplink cell configuration required (See 6.3.3.2 in 36.508)					

Table 6.2.1.4.3.2-3: Main behaviour

St	Procedure	Message Sequence		TP	Verdict
		U – S	Message		
1	The UE is switched on.	-	-	-	-
2	Make the UE display the list of available PLMNs.	-	-	-	-
3	PLMN2 (E-UTRAN) is selected.	-	-	-	-
4	Check: Does the UE send an <i>RRCConectionRequest</i> on cell 1?	-->	<i>RRCConectionRequest</i>	1,2	P
5-19	The UE performs Steps 3-17 of the registration procedure described in TS 36.508 table 4.5.2.3-1.	-	-	-	-
20	Check: Is PLMN2 indicated by the UE?	-	-	1,2	P

6.2.1.4.3.3 Specific message contents

None

6.2.1.5

6.2.1.6 Inter-RAT Background HPLMN Search / Search for correct RAT for HPLMN / Automatic Mode

6.2.1.6.1 Test Purpose (TP)

```

with { UE in Automatic network selection mode is camped on a GERAN VPLMN cell and HPLMN cell
available on E-UTRAN }
ensure that {
  when { higher priority PLMN search timer T expires }
  then { UE detects E_UTRA cell and camps on the E-UTRA cell }
}

```

6.2.1.6.2 Conformance requirements

References: The conformance requirements covered in the present TC are specified in: TS 23.122 clauses 4.4.3.3.1.

[TS 23.122, clause 4.4.3.3.1]

If the MS is in a VPLMN, the MS shall periodically attempt to obtain service on its HPLMN (if the EHPLMN list is not present or is empty) or one of its EHPLMNs (if the EHPLMN list is present) or a higher priority PLMN/access technology combinations listed in "user controlled PLMN selector" or "operator controlled PLMN selector" by scanning in accordance with the requirements that are applicable to i), ii) and iii) as defined in the Automatic Network Selection Mode in subclause 4.4.3.1.1. In the case that the mobile has a stored "Equivalent PLMNs" list the mobile shall only select a PLMN if it is of a higher priority than those of the same country as the current serving PLMN which are stored in the "Equivalent PLMNs" list. For this purpose, a value T minutes may be stored in the SIM, T is either in the range 6 minutes to 8 hours in 6 minute steps or it indicates that no periodic attempts shall be made. If no value is stored in the SIM, a default value of 60 minutes is used.

The attempts to access the HPLMN or an EHPLMN or higher priority PLMN shall be as specified below:

- a) The periodic attempts shall only be performed in automatic mode when the MS is roaming, and not while attached for emergency bearer services;
- b) After switch on a period of at least 2 minutes and at most T minutes shall elapse before the first attempt is made;
- c) The MS shall make the following attempts if the MS is on the VPLMN at time T after the last attempt;
- d) Periodic attempts shall only be performed by the MS while in idle mode;
- e) If the HPLMN (if the EHPLMN list is not present or is empty) or a EHPLMN (if the list is present) or a higher priority PLMN is not found, the MS shall remain on the VPLMN.
- f) In steps i), ii) and iii) of subclause 4.4.3.1.1 the MS shall limit its attempts to access higher priority PLMN/access technology combinations to PLMN/access technology combinations of the same country as the current serving VPLMN, as defined in Annex B.
- g) Only the priority levels of Equivalent PLMNs of the same country as the current serving VPLMN, as defined in Annex B, shall be taken into account to compare with the priority level of a selected PLMN.
- h) If the PLMN of the highest priority PLMN/access technology combination available is the current VPLMN, or one of the PLMNs in the "Equivalent PLMNs" list, the MS shall remain on the current PLMN/access technology combination.

6.2.1.6.3 Test description

6.2.1.6.3.1 Pre-test conditions

System Simulator

- GERAN VPLMN Cell 24 serving cell

- E-UTRAN HPLMN Cell 1 off
- Table 6.2.1.6.3.1-1 shows the cell configuration used during the test

- Table 6.2.1.6.3.1-1: Cell PLMN identities

Cell	PLMN name
1	PLMN1
24	PLMN15

UE

Table 6.2.1.6.3.1-2: USIM configuration

USIM field	Priority	Value	Access technology	Comment
EF _{PLMNwAcT}	1	PLMN1	E-UTRAN	
	2	PLMN15	GERAN	
EF _{HPPLMN}		1(=6 min)		The HPLMN Search Period on the USIM shall be set to 6 minutes.

Preamble

- The UE is equipped with a USIM with default settings except for the ones specified in table 6.2.1.6.3.1-2.
- The UE is switched off..

6.2.1.6.3.2 Test procedure sequence

Tables 6.2.1.6.3.2 – 1 illustrates the downlink power levels and other changing parameters to be applied for the cells at various time instants of the test execution. The exact instants on which these values shall be applied are described in the texts in this clause. Cell powers for the E-UTRAN cell are defined in TS36.508 Table 6.2.2.1-1 and cell powers for the GERAN cell are defined in TS 36.508 Table 6.2.2.1-1.

Table 6.2.1.6.3.2-1: Time instances of cell power level and parameter changes

	Parameter name	Unit	Cell 1	Cell 24
T1	RS EPRE	dBm/15kHz	-60	Same as before
*Only minimum uplink cell configuration required(See 6.3.3.2 in 36.508)				

Table 6.2.1.6.3.2-2: Main behaviour

St	Procedure	Message Sequence		TP	Verdict
		U – S	Message		
0A	Power on the UE.	-	-	-	-
1	SS starts timer of tmin = 2 minutes and tmax =(6 minutes + cell selection time) (Note 1)	-	-	-	-
1A	The UE completes the registration procedure on GERAN cell as specified in TS 51.010-1 clause 41.2.8.1.1.	-	-	-	-
2	SS adjusts cell levels for Cell 1 according to row T1 of table 6.2.1.6.3.2-1	-	-	-	-
3	Check: Does the UE send an <i>RRCConnectionRequest</i> on cell 1 after tmin but before tmax expires? (Note 1)	-->	<i>RRC: RRCConnectionRequest</i>	1	P
4-10	The steps from step 2 to step 8 as specified in TS 36.508 Table 6.4.2.7A-2 shall take place	-	-	-	-
Note 1: Timers tmin and tmax in step 1 and 3 are derived from the high priority PLMN search timer T defined by EFHPPLMN					

6.2.2 Inter-RAT cell selection

6.2.2.1 Inter-RAT cell selection / From E-UTRA RRC_IDLE to UTRA_Idle / Serving cell becomes non-suitable

6.2.2.1.1 Test Purpose (TP)

(1)

```
with { UE in E-UTRA RRC_IDLE state }
ensure that {
  when { the serving cell becomes non-suitable and there is a suitable UTRA neighbour cell }
  then { UE selects the suitable UTRA neighbour cell }
```

(2)

```
with { UE in E-UTRA RRC_IDLE state }
ensure that {
  when { the serving cell becomes barred and there is a suitable UTRA neighbour cell }
  then { UE selects the suitable UTRA neighbour cell }
}
```

Note: (SServingCell<0 or barred) condition is for rel 8; (Srxlev<0 or Squal<0 or barred) condition is for rel 9.

6.2.2.1.2 Conformance requirements

References: The conformance requirements covered in the current TC are specified in: TS 36.304, clause 4.1, 4.3,5.2.1, 5.2.3.2 and 5.3.1. TS 25.304, clause 5.2.3.2.

[TS 36.304, clause 4.1]

With the cell selection, the UE searches for a suitable cell of the selected PLMN and chooses that cell to provide available services, further the UE shall tune to its control channel. This choosing is known as "camping on the cell".

The UE shall, if necessary, then register its presence, by means of a NAS registration procedure, in the tracking area of the chosen cell and as outcome of a successful Location Registration the selected PLMN becomes the registered PLMN [5].

If the UE finds a more suitable cell, according to the cell reselection criteria, it reselects onto that cell and camps on it. If the new cell does not belong to at least one tracking area to which the UE is registered, location registration is performed.

[TS 36.304, clause 4.3]

suitable cell:

A "suitable cell" is a cell on which the UE may camp on to obtain normal service. Such a cell shall fulfil all the following requirements.

- The cell is part of either:
 - the selected PLMN, or:
 - the registered PLMN, or:
 - a PLMN of the Equivalent PLMN list
 according to the latest information provided by NAS:
- The cell is not barred, see subclause 5.3.1;
- The cell is part of at least one TA that is not part of the list of "forbidden tracking areas for roaming" [4], which belongs to a PLMN that fulfils the first bullet above;
- The cell selection criteria are fulfilled, see subclause 5.2.3.2;
- For a CSG cell, the CSG ID is part of the allowed CSG list of the UE.

If more than one PLMN identity is broadcast in the cell, the cell is considered to be part of all TAs with TAIs constructed from the PLMN identities and the TAC broadcast in the cell.

barred cell:

A cell is barred if it is so indicated in the system information [3].

[TS 36.304, clause 5.2.1]

When camped on a cell, the UE shall regularly search for a better cell according to the cell reselection criteria. If a better cell is found, that cell is selected.

[TS 36.304, clause 5.2.3.2]

The cell selection criterion S is fulfilled when:

$$S_{rxlev} > 0$$

Where:

$$S_{rxlev} = Q_{rxlevmeas} - (Q_{rxlevmin} + Q_{rxlevminoffset}) - P_{compensation}$$

Where:

the signalled value $Q_{rxlevminOffset}$ is only applied when a cell is evaluated for cell selection as a result of a periodic search for a higher priority PLMN while camped normally in a VPLMN [5]. During this periodic search for higher priority PLMN the UE may check the S criteria of a cell using parameter values stored from a different cell of this higher priority PLMN.

S_{rxlev}	Cell Selection RX level value (dB)
$Q_{rxlevmeas}$	Measured cell RX level value (RSRP).
$Q_{rxlevmin}$	Minimum required RX level in the cell (dBm)
$Q_{rxlevminoffset}$	Offset to the signalled $Q_{rxlevmin}$ taken into account in the S_{rxlev} evaluation as a result of a periodic search for a higher priority PLMN while camped normally in a VPLMN [5]
$P_{compensation}$	$\max(P_{EMAX} - P_{UMAX}, 0)$ (dB)
P_{EMAX}	Maximum TX power level an UE may use when transmitting on the uplink in the cell (dBm) defined as P_{EMAX} in [TS 36.101]
P_{UMAX}	Maximum RF output power of the UE (dBm) according to the UE power class as defined in [TS 36.101]

[TS 36.304, clause 5.3.1]

Cell status and cell reservations are indicated in the *SystemInformationBlockType1* [3] by means of two Information Elements:

- *cellBarred* (IE type: "barred" or "not barred")
In case of multiple PLMNs indicated in SIB1, this IE is common for all PLMNs

...

When cell status is indicated as "not barred" and "not reserved" for operator use,

- All UEs shall treat this cell as candidate during the cell selection and cell re-selection procedures.

...

When cell status "barred" is indicated or to be treated as if the cell status is "barred",

- The UE is not permitted to select/re-select this cell, not even for emergency calls.
- The UE shall select another cell according to the following rule:

- If the cell is a CSG cell:
 - the UE may select another cell on the same frequency if the selection/reselection criteria are fulfilled.
- else
 - If the IE *intraFreqReselection* in IE *cellAccessRelatedInfo* in *SystemInformationBlockType1* is set to "allowed", the UE may select another cell on the same frequency if re-selection criteria are fulfilled.
 - The UE shall exclude the barred cell as a candidate for cell selection/reselection for 300 seconds.
 - If the IE *intraFreqReselection* in IE *cellAccessRelatedInfo* in *SystemInformationBlockType1* is set to "not allowed" the UE shall not re-select a cell on the same frequency as the barred cell.
 - The UE shall exclude the barred cell as a candidate for cell selection/reselection for 300 seconds.

The cell selection of another cell may also include a change of RAT.

[TS 25.304, clause 5.2.3.2]

The cell selection criterion S is fulfilled when:

for FDD cells:	$S_{rxlev} > 0$ AND $S_{qual} > 0$
for TDD cells:	$S_{rxlev} > 0$

Where:

$S_{qual} = Q_{qualmeas} - Q_{qualmin}$
$S_{rxlev} = Q_{rxlevmeas} - Q_{rxlevmin} - P_{compensation}$

Squal	Cell Selection quality value (dB) Applicable only for FDD cells.
Srxlev	Cell Selection RX level value (dB)
$Q_{qualmeas}$	Measured cell quality value. The quality of the received signal expressed in CPICH E_c/N_0 (dB) for FDD cells. CPICH E_c/N_0 shall be averaged as specified in [10]. Applicable only for FDD cells.
$Q_{rxlevmeas}$	Measured cell RX level value. This is received signal, CPICH RSCP for FDD cells (dBm) and P-CCPCH RSCP for TDD cells (dBm).
Qqualmin	Minimum required quality level in the cell (dB). Applicable only for FDD cells.
Qrxlevmin	Minimum required RX level in the cell (dBm)
Pcompensation	$\max(UE_TXPWR_MAX_RACH - P_MAX, 0)$ (dB)
UE_TXPWR_MAX_RACH	Maximum TX power level an UE may use when accessing the cell on RACH (read in system information) (dBm)
P_MAX	Maximum RF output power of the UE (dBm)

6.2.2.1.3 Test description

6.2.2.1.3.1 Pre-test conditions

System Simulator:

- Cell 1 and Cell 5
- System information combination 4 as defined in TS 36.508 [18] clause 4.4.3.1 is used in E-UTRA cells.

UE:

None.

Preamble:

- UE is in state Registered, Idle Mode (state 2) on Cell 1 (serving cell) according to [18].

6.2.2.1.3.2 Test procedure sequence

Tables 6.2.2.1.3.2-1 & 6.2.2.1.3.2-2 illustrates the downlink power levels and other changing parameters to be applied for the cells at various time instants of the test execution. Subsequent configurations marked "T1", "T2" and "T3" are applied at the points indicated in the Main behaviour description in Table 6.2.2.1.3.2-3.

Table 6.2.2.1.3.2-1: Time instances of cell power level and parameter changes

	Parameter	Unit	Cell 1	Remark
T1	Cell-specific RS EPRE	dBm	-120	$Srxlev_{Cell\ 1} < 0$
	Srxlev*	dB	-10	Cell 5 becomes the strongest cell
T2	Cell-specific RS EPRE	dBm	-60	
T3	Cell-specific RS EPRE	dBm	-60	$Srxlev_{Cell\ 1} > Srxlev_{Cell\ 5} > 0$
	Srxlev*	dB	50	
	cellBarred	-	Barred	Serving cell becomes barred
Note: Srxlev is calculated in the UE				

Table 6.2.2.1.3.2-2: Time instances of cell power level and parameter changes

	Parameter	Unit	Cell 5	Remark
T1	CPICH_Ec	dBm/3.84 MHz	-70	$Srxlev_{Cell\ 5} > 0$,for FDD
	P-CCPCH	dBm/1.28 MHz	-72	$Srxlev_{Cell\ 5} > 0$,for TDD
	Srxlev*	dB	9	Cell 5 becomes the strongest cell or the suitable cell
T2	CPICH_Ec	dBm/3.84 MHz	OFF	
	P-CCPCH	dBm/1.28 MHz	OFF	
T3	CPICH_Ec	dBm/3.84 MHz	-70	$Srxlev_{Cell\ 5} > 0$,for FDD
	P-CCPCH	dBm/1.28 MHz	-72	$Srxlev_{Cell\ 5} > 0$,for TDD
	Srxlev*	dB	9	
Note: Srxlev is calculated in the UE				

Table 6.2.2.1.3.2-3: Main behaviour

St	Procedure	Message Sequence		TP	Verdict
		U - S	Message		
0	Wait for 6 s for UE to receive system information.	-	-	-	-
1	SS re-adjusts the cell-specific reference signal level of Cell 1 according to row "T1" in table 6.2.2.1.3.2-1 & Cell 5 power level is set according to row "T1" in table 6.2.2.1.3.2-2.	-	-	-	-
2	Check: Does the test result of generic test procedure in TS 36.508 subclause 6.4.2.8 indicate that the UE is camped on UTRAN Cell 5? NOTE: The UE performs a RAU procedure and the RRC connection is released.	-	-	1	-
3	SS re-adjusts the cell-specific reference signal level of Cell 1 according to row "T2" in table 6.2.2.1.3.2-1 & Cell 5 power level is set according to row "T2" in table 6.2.2.1.3.2-2.	-	-	-	-
4	Generic test procedure in TS 36.508 Table 6.4.2.7A-1 is performed and the UE will camped on E-UTRAN Cell 1. NOTE: The UE performs a TAU procedure and the RRC connection is released.	-	-	-	-
5	Wait for 6 s for UE to receive system information.	-	-	-	-
6	SS changes Cell 5 power level according to row "T3" in table 6.2.2.1.3.2-2 and modifies System Information so that Cell 1 becomes barred according to row "T3" in table 6.2.2.1.3.2-1. The SS transmits a <i>Paging</i> message including <i>systemInfoModification</i> .	<--	<i>Paging</i>	-	-
6A	Void	-	-	-	-
7	Check: Does the test result of generic test procedure in TS 36.508 subclause 6.4.2.8 indicate that the UE is camped on UTRAN Cell 5? NOTE: The UE performs a RAU procedure.	-	-	2	-

6.2.2.1.3.3 Specific message contents

Table 6.2.2.1.3.3-1: *SystemInformationBlockType1* for Cell 1 (preamble and steps 1 to 5, Table 6.2.2.1.3.2-3)

Derivation Path: 36.508 clause 4.4.3.2			
Information Element	Value/remark	Comment	Condition
SystemInformationBlockType1 ::= SEQUENCE {			
cellSelectionInfo SEQUENCE {			
q-Rxlevmin	-55 (-110 dBm)		
q-Rxlevminoffset	Not present		
}			
}			

Table 6.2.2.1.3.3-2: *Paging* for Cell 1 (step 6, Table 6.2.2.1.3.2-3)

Derivation path: 36.508 Table 4.6.1-7			
Information Element	Value/Remark	Comment	Condition
Paging ::= SEQUENCE {			
pagingRecordList	Not present		
systemInfoModification	true		
etws-Indication	Not present		
nonCriticalExtension SEQUENCE {	Not present		
}			

Table 6.2.2.1.3.3-3: *SystemInformationBlockType1* for Cell 1 (step 6, Table 6.2.2.1.3.2-3)

Derivation Path: 36.508 clause 4.4.3.2			
Information Element	Value/remark	Comment	Condition
SystemInformationBlockType1 ::= SEQUENCE {			
cellAccessRelatedInfo SEQUENCE {			
cellBarred	barred		
}			
cellSelectionInfo SEQUENCE {			
q-Rxlevmin	-55 (-110 dBm)		
q-Rxlevminoffset	Not present		
}			
systemInfoValueTag	1	Previous value is 0	
}			

6.2.2.2 Inter-RAT cell selection / From E-UTRA RRC_IDLE to GSM_Idle/GPRS Packet_idle / Serving cell becomes non-suitable

6.2.2.2.1 Test Purpose (TP)

(1)

```
with { UE in E-UTRA RRC_IDLE state }
ensure that {
  when { the serving cell becomes non-suitable and there is a suitable GSM neighbour cell }
  then { UE selects the suitable GSM neighbour cell }
```

(2)

```
with { UE in E-UTRA RRC_IDLE state }
ensure that {
  when { the serving cell becomes barred and there is a suitable GSM neighbour cell }
  then { UE selects the suitable GSM neighbour cell }
```

Note: (SServingCell<0 or barred) condition is for rel 8; (Srxlev<0 or Squal<0 or barred) condition is for rel 9.

6.2.2.2.2 Conformance requirements

References: The conformance requirements covered in the current TC are specified in: TS 36.304, clause 4.1, 4.3,5.2.1, 5.2.3.2, 5.3.1, 4.3.022, clause 3.6 and TS 45.008, clause 6.4.

[TS 36.304, clause 4.1]

With the cell selection, the UE searches for a suitable cell of the selected PLMN and chooses that cell to provide available services, further the UE shall tune to its control channel. This choosing is known as "camping on the cell".

The UE shall, if necessary, then register its presence, by means of a NAS registration procedure, in the tracking area of the chosen cell and as outcome of a successful Location Registration the selected PLMN becomes the registered PLMN [5].

If the UE finds a more suitable cell, according to the cell reselection criteria, it reselects onto that cell and camps on it. If the new cell does not belong to at least one tracking area to which the UE is registered, location registration is performed.

[TS 36.304, clause 4.3]

suitable cell:

A "suitable cell" is a cell on which the UE may camp on to obtain normal service. Such a cell shall fulfil all the following requirements.

- The cell is part of either:

- the selected PLMN, or:
- the registered PLMN, or:
- a PLMN of the Equivalent PLMN list

according to the latest information provided by NAS:

- The cell is not barred, see subclause 5.3.1;
- The cell is part of at least one TA that is not part of the list of "forbidden tracking areas for roaming" [4], which belongs to a PLMN that fulfils the first bullet above;
- The cell selection criteria are fulfilled, see subclause 5.2.3.2;
- For a CSG cell, the CSG ID is part of the allowed CSG list of the UE.

If more than one PLMN identity is broadcast in the cell, the cell is considered to be part of all TAs with TAIs constructed from the PLMN identities and the TAC broadcast in the cell.

barred cell:

A cell is barred if it is so indicated in the system information [3].

[TS 36.304, clause 5.2.1]

When camped on a cell, the UE shall regularly search for a better cell according to the cell reselection criteria. If a better cell is found, that cell is selected.

[TS 36.304, clause 5.2.3.2]

The cell selection criterion S is fulfilled when:

$$S_{rxlev} > 0$$

Where:

$$S_{rxlev} = Q_{rxlevmeas} - (Q_{rxlevmin} + Q_{rxlevminoffset}) - P_{compensation}$$

Where:

the signalled value $Q_{rxlevminOffset}$ is only applied when a cell is evaluated for cell selection as a result of a periodic search for a higher priority PLMN while camped normally in a VPLMN [5]. During this periodic search for higher priority PLMN the UE may check the S criteria of a cell using parameter values stored from a different cell of this higher priority PLMN.

S_{rxlev}	Cell Selection RX level value (dB)
$Q_{rxlevmeas}$	Measured cell RX level value (RSRP).
$Q_{rxlevmin}$	Minimum required RX level in the cell (dBm)
$Q_{rxlevminoffset}$	Offset to the signalled $Q_{rxlevmin}$ taken into account in the S_{rxlev} evaluation as a result of a periodic search for a higher priority PLMN while camped normally in a VPLMN [5]
$P_{compensation}$	$\max(P_{EMAX} - P_{UMAX}, 0)$ (dB)
P_{EMAX}	Maximum TX power level an UE may use when transmitting on the uplink in the cell (dBm) defined as P_{EMAX} in [TS 36.101]
P_{UMAX}	Maximum RF output power of the UE (dBm) according to the UE power class as defined in [TS 36.101]

[TS 36.304, clause 5.3.1]

Cell status and cell reservations are indicated in the *SystemInformationBlockType1* [3] by means of two Information Elements:

- *cellBarred* (IE type: "barred" or "not barred")
In case of multiple PLMNs indicated in SIB1, this IE is common for all PLMNs

...

When cell status is indicated as "not barred" and "not reserved" for operator use,

- All UEs shall treat this cell as candidate during the cell selection and cell re-selection procedures.

...

When cell status "barred" is indicated or to be treated as if the cell status is "barred",

- The UE is not permitted to select/re-select this cell, not even for emergency calls.
- The UE shall select another cell according to the following rule:
 - If the cell is a CSG cell:
 - the UE may select another cell on the same frequency if the selection/reselection criteria are fulfilled.
 - else
 - If the IE *intraFreqReselection* in IE *cellAccessRelatedInfo* in *SystemInformationBlockType1* is set to "allowed", the UE may select another cell on the same frequency if re-selection criteria are fulfilled.
 - The UE shall exclude the barred cell as a candidate for cell selection/reselection for 300 seconds.
 - If the IE *intraFreqReselection* in IE *cellAccessRelatedInfo* in *SystemInformationBlockType1* is set to "not allowed" the UE shall not re-select a cell on the same frequency as the barred cell.
 - The UE shall exclude the barred cell as a candidate for cell selection/reselection for 300 seconds.

The cell selection of another cell may also include a change of RAT.

[TS 43.022, clause 3.6]

The MS uses a "path loss criterion" parameter C1 to determine whether a cell is suitable to camp on. C1 depends on 4 parameters:

- i) The received signal level (suitably averaged);
- ii) The parameter *RXLEV_ACCESS_MIN*, which is broadcast as system information, and is related to the minimum signal that the operator wants the network to receive when being initially accessed by an MS;
- iii) The parameter *MS_TXPWR_MAX_CCH*, which is also broadcast as system information, and is the maximum power that an MS may use when initially accessing the network;
- iv) The maximum power of the MS.

The formula for determining C1 is given in 3GPP TS 45.008.

Use of the parameter C1 enables the MS to determine whether communication is possible with the network in the absence of interference. However because of the possibility of interference degrading the communications, an additional safeguard is used. This is to monitor the success rate of the MS in decoding signalling blocks of the paging subchannel. If there is a downlink signalling failure, i.e. the success rate drops too low, this indicates probable interference on the downlink, and the MS attempts to find another suitable cell. Downlink signalling failure monitoring is specified in 3GPP TS 45.008.

In order to optimize cell reselection, additional cell reselection parameters can be broadcast as system information of each cell. The cell reselection process employs a parameter C2 which depends on these parameters.

The parameters used to calculate C2 are as follows:

- i) *CELL_RESELECT_OFFSET* (see subclause 3.5.2.2);
- ii) *PENALTY_TIME*;

When the MS places the cell on the list of the strongest carriers as specified in 3GPP TS 45.008, it starts a timer which expires after the PENALTY_TIME. This timer will be reset when the cell is taken off the list. For the duration of this timer, C2 is given a negative offset. This will tend to prevent fast moving MSs from selecting the cell.

iii) TEMPORARY_OFFSET;

This is the amount of the negative offset described in (ii) above. An infinite value can be applied, but a number of finite values are also possible.

The permitted values of these parameters and the way in which they are combined to calculate C2 are defined in 3GPP TS 45.008.

Instead of the parameter C2, a GPRS MS applies the corresponding GPRS parameter if provided.

[TS 45.008, clause 6.4]

The path loss criterion parameter C1 used for cell selection and reselection is defined by:

$$C1 = (A - \text{Max}(B,0))$$

where

A	=	RLA_C - RXLEV_ACCESS_MIN
B	=	MS_TXPWR_MAX_CCH - P

except for the class 3 DCS 1 800 MS where:

B	=	MS_TXPWR_MAX_CCH + POWER OFFSET - P
RXLEV_ACCESS_MIN	=	Minimum received signal level at the MS required for access to the system.
MS_TXPWR_MAX_CCH	=	Maximum TX power level an MS may use when accessing the system until otherwise commanded.
POWER OFFSET	=	The power offset to be used in conjunction with the MS TXPWR MAX CCH parameter by the class 3 DCS 1 800 MS.
P	=	Maximum RF output power of the MS.

All values are expressed in dBm.

The path loss criterion (3GPP TS 43.022) is satisfied if $C1 > 0$.

6.2.2.2.3 Test description

6.2.2.2.3.1 Pre-test conditions

System Simulator:

- Cell 1 and Cell 24
- System information combination 5 as defined in TS 36.508 [18] clause 4.4.3.1 is used in E-UTRA cells.

UE:

None.

Preamble:

- UE is in state Registered, Idle Mode (state 2) on Cell 1 (serving cell) according to [18].

6.2.2.2.3.2 Test procedure sequence

Tables 6.2.2.2.3.2-1 & 6.2.2.2.3.2-2 illustrates the downlink power levels and other changing parameters to be applied for the cells at various time instants of the test execution. Subsequent configurations marked "T1", "T2" and "T3" are applied at the points indicated in the Main behaviour description in Table 6.2.2.2.3.2-3.

Table 6.2.2.3.2-1: Time instances of cell power level and parameter changes

	Parameter	Unit	Cell 1	Remark
T1	Cell-specific RS EPRE	dBm	-120	$Srxlev_{Cell\ 1} < 0$
	Srxlev*	dB	-10	Cell 24 becomes the strongest cell
T2	Cell-specific RS EPRE	dBm	-60	
T3	Cell-specific RS EPRE	dBm	-60	$Srxlev_{Cell\ 1} > Srxlev_{Cell\ 24} > 0$
	Srxlev*	dB	50	
	cellBarred	-	Barred	Serving cell becomes barred

Note: Srxlev is calculated in the UE

Table 6.2.2.3.2-2: Time instances of cell power level and parameter changes

	Parameter	Unit	Cell 24	Remark
T1	RF Signal Level	dBm	-80	$Srxlev_{Cell\ 24} > 0$
	C1*	dB	20	Cell 24 becomes the strongest cell
T2	RF Signal Level	dBm	OFF	
T3	RF Signal Level	dBm	-80	$Srxlev_{Cell\ 24} > 0$
	C1*	dB	20	

Note: C1 is calculated in the UE

Table 6.2.2.3.2-3: Main behaviour

St	Procedure	Message Sequence		TP	Verdict
		U - S	Message		
0	Wait for 6 s for UE to receive system information.	-	-	-	-
1	SS re-adjusts the cell-specific reference signal level of Cell 1 according to row "T1" in table 6.2.2.3.2-1 & cell 24 power level is set according to row "T1" in table 6.2.2.3.2-2.	-	-	-	-
2	Check: Does the test result of generic test procedure in TS 36.508 subclause 6.4.2.9 indicate that the UE is camped on GERAN Cell 24? NOTE: The UE performs a RAU procedure.	-	-	1	-
3	SS re-adjusts the cell-specific reference signal level of Cell 1 according to row "T2" in table 6.2.2.3.2-1 & Cell 24 power level is set according to row "T2" in table 6.2.2.3.2-2.	-	-	-	-
4	Generic test procedure in TS 36.508 Table 6.4.2.7A-1 is performed and the UE will camped on E-UTRAN Cell 1. NOTE: The UE performs a TAU procedure and the RRC connection is released.	-	-	-	-
5	Wait for 6 s for UE to receive system information.	-	-	-	-
6	SS changes Cell 24 power level according to row "T3" in table 6.2.2.3.2-2 and modifies System Information so that Cell 1 becomes barred according to row "T3" in table 6.2.2.3.2-1. SI2Quater for cell 24 is updated according to table 6.2.2.3.3-4 to reflect the cell barring. The SS transmits a <i>Paging</i> message including <i>systemInfoModification</i> .	<--	<i>Paging</i>	-	-
7	Check: Does the test result of generic test procedure in TS 36.508 subclause 6.4.2.9 indicate that the UE is camped on GERAN Cell 24? NOTE: The UE performs a RAU procedure.	-	-	2	-

6.2.2.2.3.3 Specific message contents

Table 6.2.2.2.3.3-1: SystemInformationBlockType1 for Cell 1 (preamble and steps 1 to 5, Table 6.2.2.2.3.2-3)

Derivation Path: 36.508 clause 4.4.3.2			
Information Element	Value/remark	Comment	Condition
SystemInformationBlockType1 ::= SEQUENCE {			
cellSelectionInfo SEQUENCE {			
q-Rxlevmin	-55 (-110 dBm)		
q-Rxlevminoffset	Not present		
}			
}			

Table 6.2.2.2.3.3-2: SystemInformationBlockType1 for Cell 1 (step 6, Table 6.2.2.2.3.2-3)

Derivation Path: 36.508 clause 4.4.3.2			
Information Element	Value/remark	Comment	Condition
SystemInformationBlockType1 ::= SEQUENCE {			
cellAccessRelatedInfo SEQUENCE {			
cellBarred	barred		
}			
cellSelectionInfo SEQUENCE {			
q-Rxlevmin	-55 (-110 dBm)		
q-Rxlevminoffset	Not present		
}			
systemInfoValueTag	1	Previous value is 0	
}			

Table 6.2.2.2.3.3-3: Paging for Cell 1 (step 6, Table 6.2.2.2.3.2-3)

Derivation path: 36.508 Table 4.6.1-7			
Information Element	Value/Remark	Comment	Condition
Paging ::= SEQUENCE {			
pagingRecordList	Not present		
systemInfoModification	true		
etws-Indication	Not present		
nonCriticalExtension SEQUENCE {}	Not present		
}			

Table 6.2.2.2.3.3-4: Repeated E-UTRAN Neighbour Cells struct of SI2Quarter for Cell 24 (step 6, Table 6.2.2.2.3.2-3)

Derivation Path: 36.508 Table 4.4.5-1			
Information Element	Value/remark	Comment	Condition
Repeated E-UTRAN Not Allowed Cells struct > ::= {			
Not Allowed Cells : < PCID Group IE >>{			
PCID}	'000000000'B	PCID=0, Meaning that the Cell 1 which have PCID=0 will not be allowed	
E-UTRAN_FREQUENCY_INDEX	'000'B	Cell 1	
}			

6.2.2.3 Inter-RAT Cell selection / From E-UTRA RRC_IDLE to HRPD Idle / Serving cell becomes non-suitable

6.2.2.3.1 Test Purpose (TP)

(1)

```
with { UE in E-UTRA RRC_IDLE state }
ensure that {
  when { the serving cell becomes non-suitable and there is a suitable neighbour HRPD cell (S>0) }
  then { UE selects the suitable neighbour HRPD cell }
}
```

Note: (SServingCell<0 or barred) condition is for rel 8; (Srxlev<0 or Squal<0 or barred) condition is for rel 9.

6.2.2.3.2 Conformance requirements

References: The conformance requirements covered in the current TC are specified in: TS36.300, clause 10.1.1.1 and TS 36.304, clause 4.1, 5.2.1, and 5.2.3.2.

[TS 36.300, clause 10.1.1.1]

Cell selection:

- The UE NAS identifies a selected PLMN and equivalent PLMNs;
- The UE searches the E-UTRA frequency bands and for each carrier frequency identifies the strongest cell. It reads cell system information broadcast to identify its PLMN(s):
 - The UE may search each carrier in turn ("initial cell selection") or make use of stored information to shorten the search ("stored information cell selection").
- The UE seeks to identify a suitable cell; if it is not able to identify a suitable cell it seeks to identify an acceptable cell. When a suitable cell is found or if only an acceptable cell is found it camps on that cell and commence the cell reselection procedure:
 - A suitable cell is one for which the measured cell attributes satisfy the cell selection criteria; the cell PLMN is the selected PLMN, registered or an equivalent PLMN; the cell is not barred or reserved and the cell is not part of a tracking area which is in the list of "forbidden tracking areas for roaming";
 - An acceptable cell is one for which the measured cell attributes satisfy the cell selection criteria and the cell is not barred;

[TS 36.304, clause 4.1]

With the cell selection, the UE searches for a suitable cell of the selected PLMN and chooses that cell to provide available services, further the UE shall tune to its control channel. This choosing is known as "camping on the cell".

The UE will, if necessary, then register its presence, by means of a NAS registration procedure, in the tracking area of the chosen cell and as outcome of a successful Location Registration the selected PLMN becomes the registered PLMN [5].

If the UE finds a more suitable cell, according to the cell reselection criteria, it reselects onto that cell and camps on it. If the new cell does not belong to at least one tracking area to which the UE is registered, location registration is performed.

[TS 36.304, clause 5.2.1]

When camped on a cell, the UE shall regularly search for a better cell according to the cell reselection criteria. If a better cell is found, that cell is selected.

[TS 36.304, clause 5.2.3.2]

The cell selection criterion S is fulfilled when:

$$S_{rxlev} > 0$$

Where:

$$S_{rxlev} = Q_{rxlevmeas} - (Q_{rxlevmin} - Q_{rxlevminoffset}) - P_{compensation}$$

Where:

the signalled value $Q_{rxlevminOffset}$ is only applied when a cell is evaluated for cell selection as a result of a periodic search for a higher priority PLMN while camped normally in a VPLMN [5]. During this periodic search for higher priority PLMN the UE may check the S criteria of a cell using parameter values stored from a different cell of this higher priority PLMN.

S_{rxlev}	Cell Selection RX level value (dB)
$Q_{rxlevmeas}$	Measured cell RX level value (RSRP).
$Q_{rxlevmin}$	Minimum required RX level in the cell (dBm)
$Q_{rxlevminoffset}$	Offset to the signalled $Q_{rxlevmin}$ taken into account in the S_{rxlev} evaluation as a result of a periodic search for a higher priority PLMN while camped normally in a VPLMN [5]
$P_{compensation}$	[FFS]

6.2.2.3.3 Test description

6.2.2.3.3.1 Pre-test conditions

System Simulator:

- Cell 1 is a cell on E-UTRA
- Cell 15 is a cell on HRPD
- System information combination 6 as defined in TS 36.508 [18] clause 4.4.3.1 is used in E-UTRA cells.

UE:

None

Preamble:

- UE is in state Registered, Idle Mode (state 2) on Cell 1 (serving cell) according to [18].

6.2.2.3.3.2 Test procedure sequence

Table 6.2.2.3.3.2-1 illustrates the downlink power levels and other changing parameters to be applied for the cells at various time instants of the test execution. Subsequent configurations marked "T1" and "T2" are applied at the points indicated in the Main behaviour description in Table 6.2.2.3.3.2-2.

Table 6.2.2.3.3.2-1: Time instances of cell power level and parameter changes

	Parameter	Unit	Cell 1	Cell 15	Remark
T1	\hat{I}_{or}/I_{oc}	dB	-	-5	Cell 15 is on
	I_{oc}	dBm/1.23 MHz	-	-55	
	Pilot E_c/I_o (Note 1)	dB	-	-6	
	Cell-specific RS EPRE	dBm/15 KHz	-60		
T2	Cell-specific RS EPRE	dBm/15 kHz	-120	-	$S_{rxlev_{Cell\ 1}} < 0$ and Cell 15 becomes the strongest cell
	S_{rxlev}^*	dB	-10		
	\hat{I}_{or}/I_{oc}	dB	-	-5	
	I_{oc}	dBm/1.23 MHz	-	-55	
	Pilot E_c/I_o (Note 1)	dB	-	-6	

Note 1: This parameter is not directly settable, but is derived by calculation from the other parameters set by the SS.

Table 6.2.2.3.3.2-2: Main behaviour

St	Procedure	Message Sequence		TP	Verdict
		U - S	Message		
1	SS re-adjusts the cell-specific reference signal level of Cell 15 according to "T1" in 6.2.2.3.3.2-1.	-	-	-	-
1A	SS waits [10s] to allow the UE to read the system information	-	-	-	-
2	SS re-adjusts the cell-specific reference signal level of Cell 1 according to "T2" in 6.2.2.3.3.2-1.	-	-	-	-
3	Check: Does the UE transmit an Access Probe on Cell 15?	-->	Access Probe	1	P

6.2.2.3.3.3 Specific message contents

Table 6.2.2.3.3.3-1 SystemInformationBlockType1 to Cell 1 (Preamble and all steps, table 6.2.2.3.3.2-2)

Derivation path: 36.508 table clause 4.4.3.2			
Information Element	Value/Remark	Comment	Condition
SystemInformationBlockType1 ::= SEQUENCE {			
cellSelectionInfo SEQUENCE {			
q-Rxlevmin	-55 (-110 dBm)		
q-Rxlevminoffset	Not present		
}			
}			

Table 6.2.2.3.3-2: SystemInformationBlockType8 to Cell 1 (Preamble and all steps, table 6.2.2.3.3-2)

Derivation path: 36.508 table 4.4.3.3			
Information Element	Value/Remark	Comment	Condition
SystemInformationBlockType8 ::= SEQUENCE {			
systemTimeInfo SEQUENCE {			
cdma-EUTRA-Synchronisation	TRUE		
cdma-SystemTime CHOICE {			
synchronousSystemTime	A valid value as per TS 36.331 and calculated by the SS		
}			
}			
searchWindowSize	5		
parametersHRPD SEQUENCE {			
cellReselectionParametersHRPD SEQUENCE {			
bandClassList SEQUENCE (SIZE (1..maxCDMA - BandClass)) OF SEQUENCE {	The same number of entries as the configured HRPD carriers		
bandClass	Band Class of frequency under test	[Set according to specific test case]	
cellReselectionPriority	5	[3 is applicable when HRPD is lower priority than E-UTRA. 5 is applicable when HRPD is higher priority than E-UTRA]	
threshX-High	30(-30)	INTEGER (0..63)	
threshX-Low	32(-32)	INTEGER (0..63)	
}			
t-ReselectionCDMA2000	0	INTEGER (0..7)	
}			
}			
}			
}			

6.2.2.4 Inter-RAT Cell selection / From E-UTRAN RRC_IDLE to 1xRTT idle / Serving cell becomes non-suitable

6.2.2.4.1 Test Purpose (TP)

(1)

```
with { UE in E-UTRA RRC_IDLE state }
ensure that {
  when { the serving cell becomes non-suitable and
there is a suitable neighbour 1xRTT cell (S>0) }
  then { UE selects the suitable neighbour 1xRTT cell }
}
```

Note: (SServingCell<0 or barred) condition is for rel 8; (Srxlev<0 or Squal<0 or barred) condition is for rel 9.

6.2.2.4.2 Conformance requirements

References: The conformance requirements covered in the current TC are specified in: TS36.300, clause 10.1.1.1 and TS 36.304, clause 4.1, 5.2.1, and 5.2.3.2.

[TS 36.300, clause 10.1.1.1]

Cell selection:

- The UE NAS identifies a selected PLMN and equivalent PLMNs;

- The UE searches the E-UTRA frequency bands and for each carrier frequency identifies the strongest cell. It reads cell system information broadcast to identify its PLMN(s):
 - The UE may search each carrier in turn ("initial cell selection") or make use of stored information to shorten the search ("stored information cell selection").
- The UE seeks to identify a suitable cell; if it is not able to identify a suitable cell it seeks to identify an acceptable cell. When a suitable cell is found or if only an acceptable cell is found it camps on that cell and commence the cell reselection procedure:
 - A suitable cell is one for which the measured cell attributes satisfy the cell selection criteria; the cell PLMN is the selected PLMN, registered or an equivalent PLMN; the cell is not barred or reserved and the cell is not part of a tracking area which is in the list of "forbidden tracking areas for roaming";
 - An acceptable cell is one for which the measured cell attributes satisfy the cell selection criteria and the cell is not barred;

[TS 36.304, clause 4.1]

With the cell selection, the UE searches for a suitable cell of the selected PLMN and chooses that cell to provide available services, further the UE shall tune to its control channel. This choosing is known as "camping on the cell".

The UE will, if necessary, then register its presence, by means of a NAS registration procedure, in the tracking area of the chosen cell and as outcome of a successful Location Registration the selected PLMN becomes the registered PLMN.

If the UE finds a more suitable cell, according to the cell reselection criteria, it reselects onto that cell and camps on it. If the new cell does not belong to at least one tracking area to which the UE is registered, location registration is performed.

[TS 36.304, clause 5.2.1]

When camped on a cell, the UE shall regularly search for a better cell according to the cell reselection criteria. If a better cell is found, that cell is selected.

[TS 36.304, clause 5.2.3.2]

The cell selection criterion S is fulfilled when:

$$S_{rxlev} > 0$$

Where:

$$S_{rxlev} = Q_{rxlevmeas} - (Q_{rxlevmin} - Q_{rxlevminoffset}) - P_{compensation}$$

Where:

the signalled value $Q_{rxlevminOffset}$ is only applied when a cell is evaluated for cell selection as a result of a periodic search for a higher priority PLMN while camped normally in a VPLMN. During this periodic search for higher priority PLMN the UE may check the S criteria of a cell using parameter values stored from a different cell of this higher priority PLMN.

S_{rxlev}	Cell Selection RX level value (dB)
$Q_{rxlevmeas}$	Measured cell RX level value (RSRP).
$Q_{rxlevmin}$	Minimum required RX level in the cell (dBm)
$Q_{rxlevminoffset}$	Offset to the signalled $Q_{rxlevmin}$ taken into account in the S_{rxlev} evaluation as a result of a periodic search for a higher priority PLMN while camped normally in a VPLMN [5]
$P_{compensation}$	[FFS]

6.2.2.4.3 Test description

6.2.2.4.3.1 Pre-test conditions

System Simulator:

- Cell 1 is a cell on E-UTRA
- Cell 19 is a cell on 1xRTT
- System information combination 6 as defined in TS 36.508 [18] clause 4.4.3.1 is used in E-UTRA cells.

UE:

None.

Preamble:

- UE is in state Registered, Idle Mode (state 2) on Cell 1 (serving cell) according to [18].

6.2.2.4.3.2 Test procedure sequence

Table 6.2.2.4.3.2-1 illustrates the downlink power levels and other changing parameters to be applied for the cells at various time instants of the test execution. The configurations marked "T1" and "T2" are applied at the point indicated in the Main behaviour description in Table 6.2.2.4.3.2-2

Table 6.2.2.4.3.2-1: Time instances of cell power level and parameter changes

	Parameter	Unit	Cell 1	Cell 19	Remark
T1	lor/loc	dB	-	0	Cell 19 is on
	Pilot Ec/ lor			-7	
	loc	dBm	-	-75	
	CPICH_Ec/lo (Note 1)	dB	-	-10	
	Cell-specific RS EPRE	dBm/15 KHz	-75	-	
T2	lor/loc	dB	-	0	Srxlev _{Cell 1} < 0 and Cell 19 becomes the strongest cell
	Pilot Ec/ lor	dB	-	-7	
	loc	dBm/1.23 MHz	-	-75	
	CPICH_Ec/lo (Note 1)	dB	-	-10	
	Cell-specific RS EPRE	dBm/15 KHz	-120	-	
Note 1: This parameter is not directly settable, but is derived by calculation from the other parameters set by the SS.					

Table 6.2.2.4.3.2-2: Main behaviour

St	Procedure	Message Sequence		TP	Verdict
		U - S	Message		
1	SS re-adjusts the cell-specific reference signal levels according to row "T1" in Table 6.2.2.4.3.2-1.	-	-	-	-
1A	SS waits [10s] to allow the UE to read the system information.	-	-	-	-
2	SS re-adjusts the cell-specific reference signal levels according to row "T2" in Table 6.2.2.4.3.2-1.	-	-	-	-
3	Check: Does the UE transmit an Access Probe on Cell 19?	-->	Access Probe	1	P

6.2.2.4.3.3 Specific message contents

Table 6.2.2.4.3.3-1 SystemInformationBlockType1 to Cell 1 (Preamble and all steps, table 6.2.2.4.3.2-1)

Derivation path: 36.508 table clause 4.4.3.2			
Information Element	Value/Remark	Comment	Condition
SystemInformationBlockType1 ::= SEQUENCE {			
cellSelectionInfo SEQUENCE {			
q-Rxlevmin	-55 (-110 dBm)		
q-Rxlevminoffset	Not present		
}			
}			

6.2.2.5 Cell selection / No USIM

6.2.2.5.1 Test Purpose (TP)

(1)

```
with { UE fitted with no SIM/USIM }
ensure that {
  when { UE is switched on }
  then { UE camps on a non-LTE cell }
}
```

(2)

```
with { UE fitted with no SIM/USIM and camped on a non-LTE cell }
ensure that {
  when { UE is requested to make an emergency call }
  then { UE transmits an RRC CONNECTION REQUEST message }
}
```

6.2.2.5.2 Conformance requirements

References: The conformance requirements covered in the present TC are specified in: TS 36.304, clause 4.1.

[TS 36.304, clause 4.1]

A UE which is not equipped with a valid USIM (i.e. no UICC or SIM only), or which shall consider the USIM as invalid for EPS services as defined in [15] and [16] (e.g. due to a LR reject #3, #6, #7, #8) shall disable all its E-UTRAN capabilities until switching off or the UICC containing the USIM is removed.

6.2.2.5.3 Test description

6.2.2.5.3.1 Pre-test conditions

System Simulator:

- Cell 1 and Cell 5.

Table 6.2.2.5.3.1-1: Time instances of cell power level and parameter changes

	Parameter	Unit	Cell 1	Cell 5
T0	Cell-specific RS EPRE	dBm	-70	-
	CPICH_Ec (UTRA FDD)	dBm/3.84 MHz	-	-75
	PCCPCH_Ec (UTRA LCR TDD)	dBm/1.28 MHz	-	-77

UE:

- The UE is not equipped with a USIM.

Preamble:

- The UE is in state Switched OFF (state 1) according to [18].

6.2.2.5.3.2 Test procedure sequence

Table 6.2.2.5.3.2-1: Main behaviour

St	Procedure	Message Sequence		TP	Verdict
		U - S	Message		
1	The UE is switched on.	-	-	-	-
2	Wait for 60s for the UE to complete cell selection. E-UTRA cell is more powerful than UTRA cell	-	-	-	-
3	Cause the UE to originate Emergency call. (see Note 1)	-	-	-	-
4	Check: Does the UE transmit an RRC CONNECTION REQUEST message on Cell 5?	-->	RRC CONNECTION REQUEST	1, 2	P
5	The SS transmits an RRC CONNECTION SETUP message on Cell 5.	<--	RRC CONNECTION SETUP	-	-
6	The UE transmits an RRC CONNECTION SETUP COMPLETE message on Cell 5.	-->	RRC CONNECTION SETUP COMPLETE	-	-
7	The UE transmits an INITIAL DIRECT TRANSFER message on Cell 5. This message includes a CM SERVICE REQUEST message.	-->	INITIAL DIRECT TRANSFER	-	-
8	The SS transmits a DOWNLINK DIRECT TRANSFER message on Cell 5. This message includes a CM SERVICE ACCEPT message.	<--	DOWNLINK DIRECT TRANSFER	-	-
9	The UE transmits an UPLINK DIRECT TRANSFER message on Cell 5. This message includes an EMERGENCY SETUP message.	-->	UPLINK DIRECT TRANSFER	-	-
10	The SS transmits a DOWNLINK DIRECT TRANSFER message on Cell 5. This message includes a CALL PROCEEDING message.	<--	DOWNLINK DIRECT TRANSFER	-	-
11	The SS transmits a RADIO BEARER SETUP message on Cell 5.	<--	RADIO BEARER SETUP	-	-
12	The UE transmits a RADIO BEARER SETUP COMPLETE message on Cell 5.	-->	RADIO BEARER SETUP COMPLETE	-	-
13	The SS transmits a DOWNLINK DIRECT TRANSFER message on Cell 5. This message includes an ALERTING message.	<--	DOWNLINK DIRECT TRANSFER	-	-
14	The SS transmits a DOWNLINK DIRECT TRANSFER message on Cell 5. This message includes a CONNECT message.	<--	DOWNLINK DIRECT TRANSFER	-	-
15	The UE transmits an UPLINK DIRECT TRANSFER message on Cell 5. This message includes a CONNECT ACKNOWLEDGE message.	-->	UPLINK DIRECT TRANSFER	-	-

Note 1: The request is assumed to be triggered by AT command D.

6.2.2.5.3.3 Specific message contents

None.

6.2.2.6 Inter-RAT Cell selection / From GSM_Idle/GPRS Packet_idle to E-UTRA_RRC_IDLE / Serving cell becomes non-suitable

6.2.2.6.1 Test Purpose (TP)

(1)

```
with { UE in GSM/GPRS Registered state and no RR connection }
ensure that {
  when { the serving cell becomes non-suitable and there is a suitable E-UTRA neighbour cell }
  then { UE selects the suitable E-UTRA neighbour cell }
```

6.2.2.6.2 Conformance requirements

References: The conformance requirements covered in the present TC are specified in: TS 45.008, clause 6.4 .

...

[TS 45.008, clause 6.4]

The path loss criterion parameter C1 used for cell selection and reselection is defined by:

$$C1 = (A - \text{Max}(B,0))$$

where

A	=	RLA_C - RXLEV_ACCESS_MIN
B	=	MS_TXPWR_MAX_CCH - P

except for the class 3 DCS 1 800 MS where:

B	=	MS_TXPWR_MAX_CCH + POWER OFFSET - P
RXLEV_ACCESS_MIN	=	Minimum received signal level at the MS required for access to the system.
MS_TXPWR_MAX_CCH	=	Maximum TX power level an MS may use when accessing the system until otherwise commanded.
POWER OFFSET	=	The power offset to be used in conjunction with the MS TXPWR MAX CCH parameter by the class 3 DCS 1 800 MS.
P	=	Maximum RF output power of the MS.

All values are expressed in dBm.

The path loss criterion (3GPP TS 43.022) is satisfied if $C1 > 0$.

6.2.2.6.3 Test description

6.2.2.6.3.1 Pre-test conditions

System Simulator:

- Two cells:
 - One GERAN cell, Cell 24 is serving cell.
 - One E-UTRAN cell, Cell 1 is Suitable neighbour inter-RAT cell.

UE:

None.

Preamble:

- The UE is in state Registered, Idle mode (state 2) on Cell 24 according to [18].

6.2.2.6.3.2 Test procedure sequence

Tables 6.2.2.6.3.2-1 illustrates the downlink power levels and other changing parameters to be applied for the cells at various time instants of the test execution. Row marked "T0" denotes the initial conditions after the preamble, while rows marked "T1" are to be applied subsequently. The exact instants on which these values shall be applied are described in the texts in this clause.

Table 6.2.2.6.3.2-1: Time instances of cell power level and parameter changes

	Parameter	Unit	Cell 1	Cell 24	Remark
T0	Cell-specific RS EPRE	dBm/15kHz	-120	-	Srxlev _{Cell 1} < 0
	Qrxlevmin	dBm	-110	-	-
	Srxlev*	dB	N/A	-	-
	RF Signal level	dBm	-	-80	-
T1	Cell-specific RS EPRE	dBm/15kHz	-70	-	-
	Srxlev*	dB	30	-	Srxlev _{Cell 1} > THRESH_E-UTRAN_high
	RF Signal level	dBm	-	OFF	-

Note: Srxlev is calculated in the UE

Table 6.2.2.6.3.2-3: Main behaviour

St	Procedure	Message Sequence		TP	Verdict
		U - S	Message		
1	SS adjusts cell levels according to row T1 of table 6.2.2.6.3.2-1	-	-	-	-
2	Check: Does the test result of generic test procedure in TS 36.508 subclause 6.4.2.7 indicate that the UE is camped on E-UTRAN Cell 1? NOTE: The UE performs a TAU procedure and the RRC connection is released.	-	-	1	-

6.2.2.6.3.3 Specific message contents

None.

6.2.2.7 Inter-RAT Cell selection / From GSM_Idle/GPRS Packet_idle to E-UTRA_RRC_IDLE ,when the serving cell is barred.

6.2.2.7.1 Test Purpose (TP)

(1)

```
with { UE in GSM/GPRS Registered state and no RR connection }
ensure that {
  when { the serving cell becomes barred and there is a suitable E-UTRA neighbour cell }
  then { UE selects the suitable E-UTRA neighbour cell }
}
```

6.2.2.7.2 Conformance requirements

References: The conformance requirements covered in the present TC are specified in: TS 45.008, clause 6.4 and 6.6.1, &TS 43.022 clause 3.2.1.

...

[TS 45.008, clause 6.4]

The path loss criterion parameter C1 used for cell selection and reselection is defined by:

$$C1 = (A - \text{Max}(B,0))$$

where

$$\begin{aligned} A &= \text{RLA}_C - \text{RXLEV_ACCESS_MIN} \\ B &= \text{MS_TXPWR_MAX_CCH} - P \end{aligned}$$

except for the class 3 DCS 1 800 MS where:

$$\begin{aligned} B &= \text{MS_TXPWR_MAX_CCH} + \text{POWER OFFSET} - P \\ \text{RXLEV_ACCESS_MIN} &= \text{Minimum received signal level at the MS required for access to the system.} \\ \text{MS_TXPWR_MAX_CCH} &= \text{Maximum TX power level an MS may use when accessing the system until otherwise commanded.} \\ \text{POWER OFFSET} &= \text{The power offset to be used in conjunction with the MS TXPWR MAX CCH parameter by the class 3 DCS 1 800 MS.} \\ P &= \text{Maximum RF output power of the MS.} \end{aligned}$$

All values are expressed in dBm.

The path loss criterion (3GPP TS 43.022) is satisfied if $C1 > 0$.

[TS 45.008, clause 6.6.1]

The MS shall attempt to decode the full BCCH data of the serving cell at least every 30 seconds or at least as often as possible in the case that system information scheduling period exceeds 30 seconds.

If SI13 is broadcast, the MS supporting change mark in SI13 (See 3GPP TS 44.018) is only required to confirm system information on the BCCH of the serving cell if indicated by change mark in SI13.

[TS 43.022, clause 3.2.1]

The choice of such a suitable cell for the purpose of receiving normal service is referred to as "normal camping". There are various requirements that a cell must satisfy before an MS can perform normal camping on it:

- i) It should be a cell of the selected PLMN or, if the selected PLMN is equal to the last registered PLMN, an equivalent PLMN;
- ii) It should not be "barred" (see subclause 3.5.1);

6.2.2.7.3 Test description

6.2.2.7.3.1 Pre-test conditions

System Simulator:

- Two cells:
 - One GERAN cell, Cell 24 is serving cell.
 - One E-UTRAN cell, Cell 1 is Suitable neighbour inter-RAT cell.

UE:

None.

Preamble:

- The UE is in state Registered, Idle mode (state 2) on Cell 24 according to [18].

6.2.2.7.3.2 Test procedure sequence

Tables 6.2.2.7.3.2-1 illustrates the downlink power levels and other changing parameters to be applied for the cells at various time instants of the test execution. Row marked "T0" denotes the initial conditions after the preamble, while

rows marked "T1" are to be applied subsequently. The exact instants on which these values shall be applied are described in the texts in this clause.

Table 6.2.2.7.3.2-1: Time instances of cell power level and parameter changes

	Parameter	Unit	Cell 1	Cell 24	Remark
T0	Cell-specific RS EPRE	dBm/15kHz	-120	-	Srxlev _{Cell 1} < 0
	Qrxlevmin	dBm	-110	-	
	Srxlev*	dB	N/A	-	
	RF Signal Level	dBm	-	-80	
	RXLEV_ACCESS_MIN	dBm	-	-101	
	C1*	dB	-	21	
T1	Cell-specific RS EPRE	dBm/15kHz	-70	-	
	Srxlev*	dB	30	-	Srxlev _{Cell 1} > THRESH_E-UTRAN_high
	RF Signal Level	dBm	-	-80	
	RXLEV_ACCESS_MIN	dBm	-	21	
	C1*	dB	-	Barred	

Note: Srxlev is calculated in the UE

Table 6.2.2.7.3.2-3: Main behaviour

St	Procedure	Message Sequence		TP	Verdict
		U - S	Message		
1	SS adjusts cells according to row T1 of table 6.2.2.7.3.2-1 and SI2 IE <i>cellBarred</i> according to row "T1" in table 6.2.2.7.3.2-1.	-	-	-	-
2	Check: Does the test result of generic test procedure in TS 36.508 Table 6.4.2.7A-2 indicate that the UE is camped on E-UTRAN Cell 1?	-	-	1	-

6.2.2.7.3.3 Specific message contents

Table 6.2.2.7.3.3-1: RACH Control Parameters of SI2, SI3 and SI4 for Cell 24(step 1, Table 6.2.2.7.3.2-3)

Derivation Path: 51.010-1 clause 40.2.1.1			
Information Element	Value/remark	Comment	Condition
RACH Control Parameters{			
Cell Barred for Access	Barred		
}			

Table 6.2.2.7.3.3-2: SI 13 Rest Octets of , SI13 for Cell 24(step 1, Table 6.2.2.7.3.2-3)

Derivation Path: 51.010-1 clause 40.2.1.1			
Information Element	Value/remark	Comment	Condition
BCCH_CHANGE_MARK {	001		
SI_CHANGE_FIELD	0000		
}			

6.2.2.8 Inter-RAT cell selection / From UTRA_Idle to E-UTRA RRC_IDLE / Serving cell becomes non-suitable

6.2.2.8.1 Test Purpose (TP)

(1)

```
with { UE in UTRA RRC_IDLE state }
ensure that {
  when { the serving cell becomes non-suitable and there is a suitable E-UTRA neighbour cell }
  then { UE selects the suitable E-UTRA neighbour cell }
```

(2)

```

with { UE in UTRA RRC_IDLE state }
ensure that {
  when { the serving cell becomes barred and there is a suitable E-UTRA neighbour cell }
  then { UE selects the suitable E-UTRA neighbour cell }
}

```

Note: (SServingCell<0 or barred) condition is for rel 8; (Srxlev<0 or Squal<0 or barred) condition is for rel 9.

6.2.2.8.2 Conformance requirements

References: The conformance requirements covered in the current TC are specified in: TS 25.304, clause 5.2.1, 4.3, 5.2.1.4, 5.2.3.2. TS 36.304, clause 4.1, 4.3, 5.2.1 and 5.2.3.2.

[TS 25.304, clause 5.2.1]

When camped on a cell, the UE shall regularly search for a better cell according to the cell reselection criteria. If a better cell is found, that cell is selected.

[TS 25.304, clause 4.3]

suitable cell:

A "suitable cell" is a cell on which the UE may camp on to obtain normal service. Such a cell shall fulfil all the following requirements.

- The cell shall be part of either:
 - the selected PLMN, or
 - the registered PLMN, or
 - a PLMN of the Equivalent PLMN list
 according to the latest information provided by the NAS.
- The cell is not barred, see subclause 5.3.1.1;
- The cell is part of at least one LA that is not part of the list of "forbidden LAs for roaming" [9], which belongs to a PLMN that fulfils the first bullet above;
- The cell selection criteria are fulfilled, see subclause 5.2.3.1.2.
- For a CSG cell the CSG ID is part of the CSG whitelist of the UE.

If the IE "Multiple PLMN List" [4] is broadcast in the cell, the cell is considered to be part of all LAs with LAIs constructed from the PLMN identities in the "Multiple PLMN List" and the LAC broadcast in the cell.

barred cell:

A cell is barred if it is so indicated in the system information [4].

[TS 25.304, clause 5.2.5.1]

When camped normally, the UE shall perform the following tasks:

- execute the cell reselection evaluation process on the following occasions/triggers:
 - 1) UE internal triggers, so as to meet performance as specified in [10] and [11];
 - 2) When information on the BCCH used for the cell reselection evaluation procedure has been modified

[TS 36.304, clause 4.1]

With the cell selection, the UE searches for a suitable cell of the selected PLMN and chooses that cell to provide available services, further the UE shall tune to its control channel. This choosing is known as "camping on the cell".

The UE shall, if necessary, then register its presence, by means of a NAS registration procedure, in the tracking area of the chosen cell and as outcome of a successful Location Registration the selected PLMN becomes the registered PLMN [5].

If the UE finds a more suitable cell, according to the cell reselection criteria, it reselects onto that cell and camps on it. If the new cell does not belong to at least one tracking area to which the UE is registered, location registration is performed.

[TS 36.304, clause 4.3]

suitable cell:

A "suitable cell" is a cell on which the UE may camp on to obtain normal service. Such a cell shall fulfil all the following requirements.

- The cell is part of either:
 - the selected PLMN, or
 - the registered PLMN, or
 - a PLMN of the Equivalent PLMN list
 according to the latest information provided by NAS:
 - The cell is not barred, see subclause 5.3.1;
 - The cell is part of at least one TA that is not part of the list of "forbidden tracking areas for roaming" [4], which belongs to a PLMN that fulfils the first bullet above;
 - The cell selection criteria are fulfilled, see subclause 5.2.3.2;
 - For a CSG cell, the CSG ID is part of the allowed CSG list of the UE.

If more than one PLMN identity is broadcast in the cell, the cell is considered to be part of all TAs with TAIs constructed from the PLMN identities and the TAC broadcast in the cell.

[TS 36.304, clause 5.2.1]

When camped on a cell, the UE shall regularly search for a better cell according to the cell reselection criteria. If a better cell is found, that cell is selected.

[TS 36.304, clause 5.2.3.2]

The cell selection criterion S is fulfilled when:

$$S_{rxlev} > 0$$

Where:

$$S_{rxlev} = Q_{rxlevmeas} - (Q_{rxlevmin} + Q_{rxlevminoffset}) - P_{compensation}$$

Where:

the signalled value $Q_{rxlevminOffset}$ is only applied when a cell is evaluated for cell selection as a result of a periodic search for a higher priority PLMN while camped normally in a VPLMN [5]. During this periodic search for higher priority PLMN the UE may check the S criteria of a cell using parameter values stored from a different cell of this higher priority PLMN.

Srxlev	Cell Selection RX level value (dB)
Q _{rxlevmeas}	Measured cell RX level value (RSRP).
Q _{rxlevmin}	Minimum required RX level in the cell (dBm)
Q _{rxlevminoffset}	Offset to the signalled Q _{rxlevmin} taken into account in the Srxlev evaluation as a result of a periodic search for a higher priority PLMN while camped normally in a VPLMN [5]
P _{compensation}	$\max(P_{EMAX} - P_{UMAX}, 0)$ (dB)
P _{EMAX}	Maximum TX power level an UE may use when transmitting on the uplink in the cell (dBm) defined as P _{EMAX} in [TS 36.101]
P _{UMAX}	Maximum RF output power of the UE (dBm) according to the UE power class as defined in [TS 36.101]

[TS 25.304, clause 5.2.3.2]

The cell selection criterion S is fulfilled when:

for FDD cells:	$Srxlev > 0$ AND $Squal > 0$
for TDD cells:	$Srxlev > 0$

Where:

$Squal = Q_{qualmeas} - Q_{qualmin}$
$Srxlev = Q_{rxlevmeas} - Q_{rxlevmin} - P_{compensation}$

Squal	Cell Selection quality value (dB) Applicable only for FDD cells.
Srxlev	Cell Selection RX level value (dB)
Q _{qualmeas}	Measured cell quality value. The quality of the received signal expressed in CPICH E _c /N ₀ (dB) for FDD cells. CPICH E _c /N ₀ shall be averaged as specified in [10]. Applicable only for FDD cells.
Q _{rxlevmeas}	Measured cell RX level value. This is received signal, CPICH RSCP for FDD cells (dBm) and P-CCPCH RSCP for TDD cells (dBm).
Q _{qualmin}	Minimum required quality level in the cell (dB). Applicable only for FDD cells.
Q _{rxlevmin}	Minimum required RX level in the cell (dBm)
P _{compensation}	$\max(UE_TXPWR_MAX_RACH - P_MAX, 0)$ (dB)
UE_TXPWR_MAX_RACH	Maximum TX power level an UE may use when accessing the cell on RACH (read in system information) (dBm)
P_MAX	Maximum RF output power of the UE (dBm)

6.2.2.8.3 Test description

6.2.2.8.3.1 Pre-test conditions

System Simulator:

- Cell 1 and Cell 5
- System information combination 4 as defined in TS 36.508 [18] clause 4.4.3.1 is used in E-UTRA cells.

UE:

None.

Preamble:

- UE is in state Registered, Idle Mode (state 3 or 7) on Cell 5 (serving cell) according to [5].

6.2.2.8.3.2 Test procedure sequence

Tables 6.2.2.8.3.2-1 & 6.2.2.8.3.2-2 illustrates the downlink power levels and other changing parameters to be applied for the cells at various time instants of the test execution. Subsequent configurations marked "T1", "T2" and " T3" are applied at the points indicated in the Main behaviour description in Table 6.2.2.8.3.2-3.

Table 6.2.2.8.3.2-1: Time instances of cell power level and parameter changes for E-UTRA cell

	Parameter	Unit	Cell 1	Remark
T1	Cell-specific RS EPRE	dBm/15kHz	-70	Cell 1 becomes the strongest cell or the suitable cell
	Srxlev*	dB	36	$Srxlev_{Cell\ 1} > 0$
T2	Cell-specific RS EPRE	dBm/15kHz	"Off"	Power level "Off" is defined in TS36.508 Table 6.2.2.1-1.
T3	Cell-specific RS EPRE	dBm/15kHz	-85	
	Srxlev*	dB	21	
Note: Srxlev is calculated in the UE				

Table 6.2.2.8.3.2-2: Time instances of cell power level and parameter changes for UTRA cell

	Parameter	Unit	Cell 5	Remark
T1	CPICH_Ec	dBm/3.84 MHz	-90	$Srxlev_{Cell\ 5} < 0$,for FDD
	P-CCPCH	dBm/1.28 MHz	-92	$Srxlev_{Cell\ 5} < 0$,for TDD
	Srxlev*	dB	-11	
T2	CPICH_Ec	dBm/3.84 MHz	-60	
	P-CCPCH	dBm/1.28 MHz	-62	
	Srxlev*	dB	19	
T3	CPICH_Ec	dBm/3.84 MHz	-50	
	P-CCPCH	dBm/1.28 MHz	-52	
	Srxlev*	dB	29	$Srxlev_{Cell\ 5} > Srxlev_{Cell\ 1} > 0$ Serving cell becomes barred
Note : Srxlev is calculated in the UE				

Table 6.2.2.8.3.2-3: Main behaviour

St	Procedure	Message Sequence		TP	Verdict
		U - S	Message		
1	SS re-adjusts the cell-specific reference signal level of Cell 1 according to row "T1" in table 6.2.2.8.3.2-1 & Cell 5 power level is set according to row "T1" in table 6.2.2.8.3.2-2.	-	-	-	-
2	Check: Does the test result of generic test procedure in TS 36.508 Table 6.4.2.7A-2 is performed and the UE is camped on E-UTRAN Cell 1?	-	-	1	-
2A	Wait for [5] s for UE to receive system information.	-	-	-	-
3	SS re-adjusts the cell-specific reference signal level of Cell 1 according to row "T2" in table 6.2.2.8.3.2-1 & Cell 5 power level is set according to row "T2" in table 6.2.2.8.3.2-2.	-	-	-	-
4	Generic test procedure in TS 36.508 subclause 6.4.2.8 indicate that the UE is camped on UTRAN Cell 5. NOTE: The UE performs a RAU procedure and the RRC connection is released.	-	-	-	-
5	SS changes Cell 1 power level according to row "T3" in table 6.2.2.8.3.2-1 and modifies System Information so that Cell 5 becomes barred according to row "T3" in table 6.2.2.8.3.2-2. The SS transmits a PAGING TYPE 1 message including "BCCH Modification Information".	<--	PAGING TYPE 1	-	-
6	Check: Does the test result of generic test procedure in TS 36.508 Table 6.4.2.7A-1 indicate that the UE is camped on E-UTRAN Cell 1? NOTE: The UE performs a TAU procedure and the RRC Connection is released.	-	-	2	-

6.2.2.8.3.3 Specific message contents

Table 6.2.2.8.3.3-2: PAGING TYPE 1 for Cell 5 (step 5, Table 6.2.2.8.3.2-3)

Derivation path: 34.108 clause 9.1.1			
Information Element	Value/Remark	Comment	Condition
PagingType1 ::= SEQUENCE {			
pagingRecordList	Not present		
bcch-ModificationInfo ::= SEQUENCE {			
mib-ValueTag	Set to (Current MIB value tag + 1)		
bcch-ModificationTime	Not present		
}			
laterNonCriticalExtensions SEQUENCE {}	Not present		
}			

Table 6.2.2.8.3.3-3: SystemInformationBlockType3 for Cell 5 (step 5, Table 6.2.2.8.3.2-3)

Derivation Path: 34.108 clause 4.4.3.2			
Information Element	Value/remark	Comment	Condition
- Cell Access Restriction			
- Cell barred	barred		
- Intra-frequency cell re-selection indicator	Not present		
- T _{barred}	Not present		

6.2.3 Inter-RAT cell reselection

6.2.3.1 Inter-RAT cell reselection / From E-UTRA RRC_IDLE to GSM_Idle/GPRS Packet_Idle

6.2.3.1.1 Test Purpose (TP)

(1)

```
with { UE in E-UTRA RRC_IDLE state }
ensure that {
  when { UE detects the cell re-selection criteria are met for the cell which belongs to the higher
priority inter-RAT(GERAN) frequency for TreselectionRAT }
  then { UE reselects the cell which belongs to the higher priority inter-RAT(GERAN) frequency }
}
```

(2)

```
with { UE in E-UTRA RRC_IDLE state }
ensure that {
  when { UE detects the cell re-selection criteria are met for the cell which belongs to the lower
priority inter-RAT(GERAN) frequency for TreselectionRAT }
  then { UE reselects the cell which belongs to the lower priority inter-RAT(GERAN) frequency }
}
```

6.2.3.1.2 Conformance requirements

References: The conformance requirements covered in the present TC are specified in: TS 36.304, clause 5.2.4.1, 5.2.4.2 and 5.2.4.5.

[TS 36.304, clause 5.2.4.1]

Absolute priorities of different E-UTRAN frequencies or inter-RAT frequencies may be provided to the UE in the system information, in the *RRCConnectionRelease* message, or by inheriting from another RAT at inter-RAT cell (re)selection. In the case of system information, an E-UTRAN frequency or inter-RAT frequency may be listed without providing a priority (i.e. the field *cellReselectionPriority* is absent for that frequency). If priorities are provided in dedicated signalling, the UE shall ignore all the priorities provided in system information. If UE is in *camped on any cell* state, UE shall only apply the priorities provided by system information from current cell, and the UE preserves priorities provided by dedicated signalling unless specified otherwise. When the UE in *camped normally* state, has only dedicated priorities other than for the current frequency, the UE shall consider the current frequency to be the lowest priority frequency (i.e. lower than the eight network configured values). The UE shall delete priorities provided by dedicated signalling when:

- the UE enters RRC_CONNECTED state; or
- the optional validity time of dedicated priorities (T320) expires; or
- a PLMN selection is performed on request by NAS [5].

NOTE: Equal priorities between RATs are not supported.

The UE shall only perform cell reselection evaluation for E-UTRAN frequencies and inter-RAT frequencies that are given in system information and for which the UE has a priority provided.

The UE shall not consider any black listed cells as candidate for cell reselection.

The UE shall inherit the priorities provided by dedicated signalling and the remaining validity time (i.e., T320 in E-UTRA, T322 in UTRA and [T3230, FFS] in GERAN), if configured, at inter-RAT cell (re)selection.

NOTE: The network may assign dedicated cell reselection priorities for frequencies not configured by system information.

[TS 36.304, clause 5.2.4.2]

When evaluating for reselection purposes cell selection criterion or *SnonServingCell,x*, the UE shall use parameters provided by the serving cell.

Following rules are used by the UE to limit needed measurements:

- If $S_{\text{intrasearch}}$ is sent in the serving cell and $S_{\text{ServingCell}} > S_{\text{intrasearch}}$, UE may choose to not perform intra-frequency measurements.
- If $S_{\text{ServingCell}} \leq S_{\text{intrasearch}}$, or $S_{\text{intrasearch}}$ is not sent in the serving cell UE shall perform intra-frequency measurements.
- The UE shall apply the following rules for E-UTRAN inter-frequencies and inter-RAT frequencies which are indicated in system information and for which the UE has priority provided as defined in 5.2.4.1:
 - For an E-UTRAN inter-frequency or inter-RAT frequency with a reselection priority higher than the reselection priority of the current E-UTRA frequency the UE shall perform measurements of higher priority E-UTRAN inter-frequency or inter-RAT frequencies according to [10].
 - For an E-UTRAN inter-frequency with an equal or lower reselection priority than the reselection priority of the current E-UTRA frequency and for inter-RAT frequency with lower reselection priority than the reselection priority of the current E-UTRAN frequency:
 - If $S_{\text{nonintrasearch}}$ is sent in the serving cell and $S_{\text{ServingCell}} > S_{\text{nonintrasearch}}$ UE may choose not to perform measurements of E-UTRAN inter-frequencies or inter-RAT frequency cells of equal or lower priority.
 - If $S_{\text{ServingCell}} \leq S_{\text{nonintrasearch}}$ or $S_{\text{nonintrasearch}}$ is not sent in the serving cell the UE shall perform measurements of E-UTRAN inter-frequencies or inter-RAT frequency cells of equal or lower priority according to [10].

Where $S_{\text{ServingCell}}$ is the S_{rxlev} -value of the serving cell.

[TS 36.304, clause 5.2.4.5]

Criteria 1: the $S_{\text{nonServingCell},x}$ of a cell on evaluated frequency is greater than $\text{Thresh}_{x, \text{high}}$ during a time interval $\text{Treselection}_{\text{RAT}}$;

Cell reselection to a cell on a higher priority E-UTRAN frequency or inter-RAT frequency than serving frequency shall be performed if:

- A cell of a higher priority E-UTRAN frequency or inter-RAT frequency fulfils criteria 1; and
- more than 1 second has elapsed since the UE camped on the current serving cell.

Cell reselection to a cell on a lower priority E-UTRAN frequency or inter-RAT frequency than serving frequency shall be performed if:

- No cell on serving frequency or on an equal priority E-UTRAN frequency or on a higher priority E-UTRAN frequency or inter-RAT frequency than serving frequency fulfils the criteria 1; and
- $S_{\text{ServingCell}} < \text{Thresh}_{\text{serv}, \text{low}}$ and the $S_{\text{nonServingCell},x}$ of a cell of a lower priority E-UTRAN frequency or inter-RAT frequency is greater than $\text{Thresh}_{x, \text{low}}$ during a time interval $\text{Treselection}_{\text{RAT}}$; and
- more than 1 second has elapsed since the UE camped on the current serving cell.

or if:

- there are no candidate cells for reselection on serving frequency according to 5.2.4.4 or 5.3.1.

Cell reselection to a cell on an equal priority E-UTRAN frequency shall be based on ranking for Intra-frequency cell reselection as defined in sub-clause 5.2.4.6.

For GERAN, UTRAN, and E-UTRAN, $S_{\text{nonServingCell},x}$ is the S_{rxlev} -value of an evaluated cell. For UTRAN FDD, S_{qual} is higher than 0, as defined in [8]. For cdma2000 RATs, $S_{\text{nonServingCell},x}$ is equal to $\text{FLOOR}(-2 \times 10 \times \log_{10} E_c/I_o)$ in units of 0.5 dB, as defined in [18], with E_c/I_o referring to the value measured From the evaluated cell.

6.2.3.1.3 Test description

6.2.3.1.3.1 Pre-test conditions

System Simulator:

- Cell 1, Cell 24 and Cell 25.
- System information combination 5 as defined in TS 36.508 [18] clause 4.4.3.1 is used in E-UTRA cells.

UE:

None.

Preamble:

- The UE is in state Registered, Idle mode (state 2) on Cell 1 (serving cell) according to [18].

6.2.3.1.3.2 Test procedure sequence

Tables 6.2.3.1.3.2-1 & 6.2.3.1.3.2-2 illustrates the downlink power levels and other changing parameters to be applied for the cells at various time instants of the test execution. Subsequent configurations marked "T1", "T2" and "T3" are applied at the points indicated in the Main behaviour description in Table 6.2.3.1.3.2-3.

Table 6.2.3.1.3.2-1: Time instances of cell power level and parameter changes for E-UTRA cells

	Parameter	Unit	Cell 1	Remark
T1	Cell-specific RS EPRE	dBm/15kHz	-70	$Srxlev_{Cell\ 1} > 0$
	Srxlev*	dB	36	$Srxlev_{Cell\ 1} > Srxlev_{Cell\ 24} > 0$
T2	Cell-specific RS EPRE	dBm/15kHz	-60	$Srxlev_{Cell\ 1} > 20$
	Srxlev*	dB	46	
T3	Cell-specific RS EPRE	dBm/15kHz	-100	$Srxlev_{Cell\ 1} < 20$ [threshServingLow]

Note: Srxlev is calculated in the UE

Table 6.2.3.1.3.2-2: Time instances of cell power level and parameter changes for GERAN cells

	Parameter	Unit	Cell 24	Cell 25	Remark
T1	RF Signal Level	dBm	-80	OFF	$Srxlev_{Cell\ 24} > 4$ [threshX-High]
	C1*	dB	21	N/A	
T2	RF Signal Level	dBm	OFF	OFF	
	C1*	dB	N/A	21	
T3	RF Signal Level	dBm	OFF	-80	$Srxlev_{Cell\ 25} > 4$ [threshX-Low]

Note: C1 is calculated in the UE

Table 6.2.3.1.3.2-3: Main behaviour

St	Procedure	Message Sequence		TP	Verdict
		U - S	Message		
0	Wait for 6 s for UE to receive system information.	-	-	-	-
1	The SS changes Cell 1 according to the row "T1" in table 6.2.3.1.3.2-1 and Cell 24 level according to the row "T1" in table 6.2.3.1.3.2-2.	-	-	-	-
2	Check: Does the test result of generic test procedure in TS 36.508 subclause 6.4.2.9 indicate that the UE is camped on GERAN Cell 24? NOTE: The UE performs a RAU procedure.	-	-	1	-
3	Void	-	-	-	-
4	Wait for [5 s].	-	-	-	-
5	The SS changes Cell 1 according to the row "T2" in table 6.2.3.1.3.2-1 and Cell 24 level according to the row "T2" in table 6.2.3.1.3.2-2	-	-	-	-
6	UE reselects Cell 1 and completes tracking area update procedure. Steps 1 to 22 of the generic test procedure described in TS 36.508 Table 6.4.2.7A-2 are performed on Cell 1.	-	-	-	-
7	Wait for [5 s].	-	-	-	-
8	The SS changes Cell 1 according to the row "T3" in table 6.2.3.1.3.2-1 and Cell 25 level according to the row "T3" in table 6.2.3.1.3.2-2.	-	-	-	-
9	Void	-	-	-	-
10	Check: Does the test result of generic test procedure in TS 36.508 subclause 6.4.2.9 indicate that the UE is camped on GERAN Cell 25? NOTE: The UE performs a RAU procedure.	-	-	2	-

6.2.3.1.3.3 Specific message contents

Table 6.2.3.1.3.3-1: SystemInformationBlockType3 cell 1 (preamble and all steps, Table 6.2.3.1.3.2-3)

Derivation Path: 36.508 table 4.4.3.3-2			
Information Element	Value/remark	Comment	Condition
SystemInformationBlockType3 ::= SEQUENCE {			
cellReselectionServingFreqInfo SEQUENCE {			
s-NonIntraSearch	Not present		
threshServingLow	10	Actual value =20 dB	
cellReselectionPriority	4	A middle value in the range has been selected.	
}			
}			

Table 6.2.3.1.3.3-2: SystemInformationBlockType7 cell 1 (preamble and all steps, Table 6.2.3.1.3.2-3)

Derivation Path: 36.508 table 4.4.3.3-6			
Information Element	Value/remark	Comment	Condition
SystemInformationBlockType7 ::= SEQUENCE {			
t-ReselectionGERAN	7	INTEGER (0..7)	
speedDependentScalingParameters SEQUENCE	Not present		
{			
carrierFreqsInfoList SEQUENCE (SIZE (1..maxGNFG)) OF SEQUENCE {			
carrierFreqsGERAN SEQUENCE [n] {			
startingARFCN	Same as cell 24		
bandIndicator	Same as cell 24		
followingARFCNs CHOICE {			
explicitListOfARFCNs	Empty		
}			
}			
}			
commonInfo SEQUENCE {			
cellReselectionPriority	5	Greater than EUTRA Freq	
ncc-Permitted	'01000000'B		
q-RxLevMin	2	The actual value of $Q_{rxlevmin}$ in dBm = (IE value * 2) - 115.	
threshX-High	2	Actual value =4 dB	
threshX-Low	2	Actual value =4 dB	
}			
carrierFreqsGERAN SEQUENCE [m] {			
startingARFCN	Same as cell 25		
bandIndicator	Same as cell 25		
followingARFCNs CHOICE {			
explicitListOfARFCNs	Empty		
}			
}			
commonInfo SEQUENCE {			
cellReselectionPriority	3	Less than EUTRA Freq	
ncc-Permitted	'01000000'B		
q-RxLevMin	2	The actual value of $Q_{rxlevmin}$ in dBm = (IE value * 2) - 115.	
threshX-High	2	Actual value =4 dB	
threshX-Low	2	Actual value =4 dB	
}			
}			
}			

Table 6.2.3.1.3.3-3: System Information 2 Quarter for Cell 24 in Preamble and all test steps

Derivation Path: 36.508 4.4.5-1			
Information Element	Value/remark	Comment	Condition
Serving Cell Priority Parameters Description ::= {			
GERAN_PRIORITY	5	Greater than EUTRA freq	
}			

Table 6.2.3.1.3.3-4: System Information 2 Quarter for Cell 25 in Preamble and all test steps

Derivation Path: 36.508 4.4.5-1			
Information Element	Value/remark	Comment	Condition
Serving Cell Priority Parameters Description::= {			
GERAN_PRIORITY	3	Less than EUTRA freq	
}			

6.2.3.1a Inter-RAT cell reselection / From E-UTRA RRC_IDLE to GSM_Idle/GPRS Packet_Idle (Squal < Thresh_{Serving, LowQ}, Srxlev > Thresh_{X, LowP} and Srxlev > Thresh_{X, HighP})

6.2.3.1a.1 Test Purpose (TP)

(1)

```
with { UE in E-UTRA RRC_IDLE state }
ensure that {
  when { UE detects the cell re-selection criteria(Srxlev > ThreshX, HighP) is met for the cell which
  belong to the higher priority inter-RAT(GERAN) frequency for TreselectionRAT }
  then { UE reselects the cell which belongs to the higher priority inter-RAT(GERAN) frequency }
}
```

(2)

```
with { UE in E-UTRA RRC_IDLE state }
ensure that {
  when { UE detects the cell re-selection criteria(Squal < ThreshServing, LowQ and Srxlev > ThreshX, LowP)
  is met for the cell which belong to the lower priority inter-RAT(GERAN) frequency for TreselectionRAT }
  then { UE reselects the cell which belongs to the lower priority inter-RAT(GERAN) frequency }
}
```

6.2.3.1a.2 Conformance requirements

References: The conformance requirements covered in the current TC are specified in: TS36.304, clause 5.2.4.5.

[TS 36.304, clause 5.2.4.5]

If *threshServingLowQ* is provided in *SystemInformationBlockType3*, cell reselection to a cell on a higher priority E-UTRAN frequency or inter-RAT frequency than the serving frequency shall be performed if:

- A cell of a higher priority EUTRAN or UTRAN FDD RAT/ frequency fulfils Squal > Thresh_{X, HighQ} during a time interval Treselection_{RAT}; or
- A cell of a higher priority UTRAN TDD, GERAN or CDMA2000 RAT/ frequency fulfils Srxlev > Thresh_{X, HighP} during a time interval Treselection_{RAT}; and
- More than 1 second has elapsed since the UE camped on the current serving cell.

Otherwise, cell reselection to a cell on a higher priority E-UTRAN frequency or inter-RAT frequency than the serving frequency shall be performed if:

- A cell of a higher priority RAT/ frequency fulfils Srxlev > Thresh_{X, HighP} during a time interval Treselection_{RAT}; and
- More than 1 second has elapsed since the UE camped on the current serving cell.

Cell reselection to a cell on an equal priority E-UTRAN frequency shall be based on ranking for Intra-frequency cell reselection as defined in sub-clause 5.2.4.6.

If *threshServingLowQ* is provided in *SystemInformationBlockType3*, cell reselection to a cell on a lower priority E-UTRAN frequency or inter-RAT frequency than the serving frequency shall be performed if:

- The serving cell fulfils Squal < Thresh_{Serving, LowQ} and a cell of a lower priority EUTRAN or UTRAN FDD RAT/ frequency fulfils Squal > Thresh_{X, LowQ} during a time interval Treselection_{RAT}; or

- The serving cell fulfils $Squal < Thresh_{Serving, LowQ}$ and a cell of a lower priority UTRAN TDD, GERAN or CDMA2000 RAT/ frequency fulfils $Srxlev > Thresh_{X, LowP}$ during a time interval $Treselection_{RAT}$; and
- More than 1 second has elapsed since the UE camped on the current serving cell.

Otherwise, cell reselection to a cell on a lower priority E-UTRAN frequency or inter-RAT frequency than the serving frequency shall be performed if:

- The serving cell fulfils $Srxlev < Thresh_{Serving, LowP}$ and a cell of a lower priority RAT/ frequency fulfils $Srxlev > Thresh_{X, LowP}$ during a time interval $Treselection_{RAT}$; and
- More than 1 second has elapsed since the UE camped on the current serving cell.

Cell reselection to a higher priority RAT/ frequency shall take precedence over a lower priority RAT/ frequency, if multiple cells of different priorities fulfil the cell reselection criteria.

For cdma2000 RATs, $Srxlev$ is equal to $-FLOOR(-2 \times 10 \times \log_{10} Ec/Io)$ in units of 0.5 dB, as defined in [18], with Ec/Io referring to the value measured from the evaluated cell.

For cdma2000 RATs, $Thresh_{X, HighP}$ and $Thresh_{X, LowP}$ are equal to -1 times the values signalled for the corresponding parameters in the system information.

In all the above criteria the value of $Treselection_{RAT}$ is scaled when the UE is in the medium or high mobility state as defined in subclause 5.2.4.3.1. If more than one cell meets the above criteria, the UE shall reselect a cell as follows:

- If the highest-priority frequency is an E-UTRAN frequency, a cell ranked as the best cell among the cells on the highest priority frequency(ies) meeting the criteria according to section 5.2.4.6;
- If the highest-priority frequency is from another RAT, a cell ranked as the best cell among the cells on the highest priority frequency(ies) meeting the criteria of that RAT.

6.2.3.1a.3 Test description

6.2.3.1a.3.1 Pre-test conditions

System Simulator:

- Cell 1, Cell 24 and Cell 25.
- System information combination 5 as defined in TS 36.508 [18] clause 4.4.3.1 is used in E-UTRA cells.

UE:

None

Preamble:

- UE is in state Registered, Idle Mode (state 2) on Cell 1 (serving cell) according to [18].

6.2.3.1a.3.2 Test procedure sequence

Tables 6.2.3.1a.3.2-1 & 6.2.3.1a.3.2-2 illustrates the downlink power levels and other changing parameters to be applied for the cells at various time instants of the test execution. Subsequent configurations marked "T1", "T2" and "T3" are applied at the points indicated in the Main behaviour description in Table 6.2.3.1a.3.2-3.

Table 6.2.3.1a.3.2-1: Time instances of cell power level and parameter changes for E-UTRA cells

	Parameter	Unit	Cell 1	Remark
T1	Cell-specific RS EPRE	dBm/15kHz	-70	$Srxlev_{Cell\ 1} > 0$
T2	Cell-specific RS EPRE	dBm/15kHz	-60	
T3	Cell-specific RS EPRE	dBm/15kHz	-100	Make $Squal_{Cell\ 1} < thresh_{ServingLowQ}$
	RSRQ	dB	-3.01	
	Noc	dBm/15kHz	off	
Note: $Srxlev$ and $Squal$ is calculated in the UE.				

Table 6.2.3.1a.3.2-2: Time instances of cell power level and parameter changes for GERAN cells

	Parameter	Unit	Cell 24	Cell 25	Remark
T1	RF Signal Level	dBm	-80	OFF	Srxlev _{Cell 24} > 4[threshX-High]
	C1*	dB	21	N/A	
T2	RF Signal Level	dBm	OFF	OFF	
	C1*	dB	N/A	N/A	
T3	RF Signal Level	dBm	OFF	-80	Srxlev _{Cell 25} > 4[threshX-Low]

Note: C1 is calculated in the UE.

Table 6.2.3.1a.3.2-3: Main behaviour

St	Procedure	Message Sequence		TP	Verdict
		U - S	Message		
0	Wait for 6 s for UE to receive system information.	-	-	-	-
1	The SS changes Cell 1 according to the row "T1" in table 6.2.3.1a.3.2-1 and Cell 24 level according to the row "T1" in table 6.2.3.1a.3.2-2.	-	-	-	-
2	Check: Does the test result of generic test procedure in TS 36.508 subclause 6.4.2.9 indicate that the UE is camped on GERAN Cell 24? NOTE: The UE performs a RAU procedure.	-	-	1	-
3	The SS send CHANNEL RELEASE message to UE.	<--	CHANNEL RELEASE	-	-
4	The SS changes Cell 1 according to the row "T2" in table 6.2.3.1a.3.2-1 and Cell 24 level according to the row "T2" in table 6.2.3.1a.3.2-2.	-	-	-	-
5	UE performs generic test procedure in TS 36.508 subclause 6.4.2.7A-2 and camp on E-UTRA Cell 1.	-	-	-	-
7	The SS changes Cell 1 according to the row "T3" in table 6.2.3.1a.3.2-1 and Cell 25 level according to the row "T3" in table 6.2.3.1a.3.2-2.	-	-	-	-
8	Check: Does the test result of generic test procedure in TS 36.508 subclause 6.4.2.9 indicate that the UE is camped on GERAN Cell 25? NOTE: The UE performs a RAU procedure.	-	-	2	-
9	The SS send CHANNEL RELEASE message to UE.	<--	CHANNEL RELEASE	-	-

6.2.3.1a.3.3 Specific message contents

Table 6.2.3.1a.3.3-1: SystemInformationBlockType1 cell 1 (preamble and all steps, Table 6.2.3.1a.3.2-3)

Derivation path: 36.508 table 4.4.3.2			
Information Element	Value/remark	Comment	Condition
SystemInformationBlockType1 ::= SEQUENCE {			
nonCriticalExtension SEQUENCE {			
lateNonCriticalExtension	Not present		
nonCriticalExtension SEQUENCE {			
ims-EmergencySupport-r9	Not present		
cellSelectionInfo-v920 SEQUENCE {			
q-QualMin-r9	-20		
q-QualMinOffset-r9	1		
}			
nonCriticalExtension	Not present		
}			
}			
}			
}			

Table 6.2.3.1a.3.3-2: SystemInformationBlockType3 cell 1 (preamble and all steps, Table 6.2.3.1a.3.2-3)

Derivation path: 36.508 table 4.4.3.3-2			
Information Element	Value/remark	Comment	Condition
SystemInformationBlockType3 ::= SEQUENCE {			
cellReselectionServingFreqInfo SEQUENCE {			
s-NonIntraSearch	Not present		
threshServingLow	10	Actual value =20 dB	
cellReselectionPriority	4	A middle value in the range has been selected.	
}			
lateNonCriticalExtension {			
threshServingLowQ-r9	26 dB		
}			
}			

Table 6.2.3.1a.3.3-3: SystemInformationBlockType7 cell 1 (preamble and all steps, Table 6.2.3.1a.3.2-3)

Derivation Path: 36.508 table 4.4.3.3-6			
Information Element	Value/remark	Comment	Condition
SystemInformationBlockType7 ::= SEQUENCE {			
t-ReselectionGERAN	7	INTEGER (0..7)	
t-ReselectionGERAN-SF	Not present		
speedDependentScalingParameters SEQUENCE {	Not present		
}			
carrierFreqsInfoList SEQUENCE (SIZE (1..maxGNFG)) OF SEQUENCE {			
carrierFreqsGERAN SEQUENCE [n] {			
startingARFCN	Same as cell 24		
bandIndicator	Same as cell 24		
followingARFCNs CHOICE {			
equallySpacedARFCNs SEQUENCE {			
arfcn-Spacing	Same as cell 24		
numberOfFollowingARFCNs	Same as cell 24		
}			
}			
}			
}			
commonInfo SEQUENCE {			
cellReselectionPriority	5	Greater than EUTRA Freq	
ncc-Permitted	'11111111'B		
q-RxLevMin	2	The actual value of $Q_{rxlevmin}$ in dBm = (IE value * 2) - 115.	
p-MaxGERAN[n]	TBD		
threshX-High	2	Actual value =4 dB	
threshX-Low	2	Actual value =4 dB	
}			
carrierFreqsGERAN SEQUENCE [m] {			
startingARFCN	Same as cell 25		
bandIndicator	Same as cell 25		
followingARFCNs CHOICE {			
equallySpacedARFCNs SEQUENCE {			
arfcn-Spacing	Same as cell 25		
numberOfFollowingARFCNs	Same as cell 25		
}			
}			
}			
commonInfo SEQUENCE {			
cellReselectionPriority	2	Less than EUTRA Freq	
ncc-Permitted	'11111111'B		
q-RxLevMin	2	The actual value of $Q_{rxlevmin}$ in dBm = (IE value * 2) - 115.	
threshX-High	2	Actual value =4 dB	
threshX-Low	2	Actual value =4 dB	
}			
}			
}			

Table 6.2.3.1a.3.3-4: System Information 2 Quarter for Cell 24 (Preamble and all test steps, , Table 6.2.3.1a.3.2-3)

Derivation Path: 36.508 4.4.5-1			
Information Element	Value/remark	Comment	Condition
Serving Cell Priority Parameters Description::= {			
GERAN_PRIORITY	5	Greater than EUTRA freq	
}			

Table 6.2.3.1a.3.3-5: System Information 2 Quarter for Cell 25 (Preamble and all test steps, , Table 6.2.3.1a.3.2-3)

Derivation Path: 36.508 4.4.5-1			
Information Element	Value/remark	Comment	Condition
Serving Cell Priority Parameters Description::= {			
GERAN_PRIORITY	2	Less than EUTRA freq	
}			

6.2.3.2 Void

6.2.3.3 Inter-RAT cell reselection / From UTRA_Idle to E-UTRA RRC_IDLE

6.2.3.3.1 Test Purpose (TP)

(1)

```
with { UE in UTRA_Idle state }
ensure that {
  when { UE detects the cell re-selection criteria are met for the cell which belongs to the lower
priority inter-RAT E-UTRA cell }
  then { UE reselects the cell which belongs to the lower priority inter-RAT E-UTRA cell }
}
```

(2)

```
with { UE in UTRA_Idle state }
ensure that {
  when { UE detects the cell re-selection criteria are met for the cell which belongs to the higher
priority inter-RAT E-UTRA cell }
  then { UE reselects the cell which belongs to the higher priority inter-RAT E-UTRA cell }
}
```

6.2.3.3.2 Conformance requirements

References: The conformance requirements covered in the present TC are specified in: TS 25.304, clause 5.2.6.1.2a and 5.2.6.1.4a.

[TS 25.304, clause 5.2.6.1.2a]

If the UE has received absolute priority information for inter-RAT layers, the UE shall follow these rules:

- The UE shall perform measurements of inter-RAT layers with a priority higher than the priority of the current serving cell.

NOTE: The rate of these measurements may vary depending on whether S_{rxlev} and S_{qual} of the serving cell are above or below $S_{prioritysearch1}$ and $S_{prioritysearch2}$. This is specified in [10].

- For inter-RAT layers with a priority lower than the priority of the current serving cell:
 - If $S_{rxlev}^{ServingCell} > S_{prioritysearch1}$ and $S_{qual}^{ServingCell} > S_{prioritysearch2}$ the UE may choose not to perform measurements of inter-RAT layers of lower priority.
 - If $S_{rxlev}^{ServingCell} \leq S_{prioritysearch1}$ or $S_{qual}^{ServingCell} \leq S_{prioritysearch2}$ the UE shall perform measurements of inter-RAT layers of lower priority.

[TS 25.304, clause 5.2.6.1.4a]

Absolute priorities of different absolute priority layers may be provided to the UE. The following cell reselection criteria are used for inter-frequency cells if absolute priority information for inter-frequency is available to the UE, and inter-RAT cells if absolute priority information for inter-RAT is available to the UE.

...

The following definitions apply:

- Criterion 1: the $Srxlev_{nonServingCell,x}$ of a cell on an evaluated higher absolute priority layer is greater than $Thresh_{x,high}$ during a time interval $T_{reselection}$;
- ...
- Criterion 3: $Srxlev_{ServingCell} < Thresh_{serving,low}$ or $Squal_{ServingCell} < 0$ and the $Srxlev_{nonServingCell,x}$ of a cell on an evaluated lower absolute priority layer is greater than $Thresh_{x,low}$ during a time interval $T_{reselection}$;

Cell reselection to a cell on a higher absolute priority layer than the camped frequency shall be performed if criterion 1 is fulfilled.

...

Cell reselection to a cell on a lower absolute priority layer than the camped frequency shall be performed if criterion 3 is fulfilled.

If more than one cell meets the above criteria, the UE shall reselect the cell with the highest $Srxlev_{nonServingCell,x}$ among the cells meeting the criteria on the highest absolute priority layer.

The UE shall not perform cell reselection to cells for which the cell selection criterion S is not fulfilled.

The UE shall not perform cell reselection until more than 1 second has elapsed since the UE camped on the current serving cell.

6.2.3.3.3 Test description

6.2.3.3.3.1 Pre-test conditions

System Simulator:

- Cell 1 and Cell 5

UE:

None.

Preamble:

- The UE is in state Registered, Idle mode (state 3 or 7) on Cell 5 (serving cell) according to [5].

6.2.3.3.3.2 Test procedure sequence

Tables 6.2.3.3.3.2-1 & Table 6.2.3.3.3.2-2 illustrate the downlink power levels and other changing parameters to be applied for the cells at various time instants of the test execution. Subsequent configurations marked "T1", "T2" and "T3" are applied at the points indicated in the Main behaviour description in Table 6.2.3.3.3.2-3.

Table 6.2.3.3.2-1: Time instances of cell power level and parameter changes for E-UTRA cell

	Parameter	Unit	Cell 1	Remark
T1	Cell-specific RS EPRE	dBm/15kHz	-85	
	Srxlev*	dB	21	Srxlev = Cell-specific RS EPRE - qRxLevMinEUTRA S _{nonServingCell, Cell1} > Thresh _{Cell1,low}
T2	Cell-specific RS EPRE	dBm/15kHz	-115	
T3	Cell-specific RS EPRE	dBm/15kHz	-80	
	Srxlev*	dB	26	Srxlev = Cell-specific RS EPRE - qRxLevMinEUTRA S _{nonServingCell, Cell1} > Thresh _{Cell1,high}
Note: Srxlev is calculated in the UE				

Table 6.2.3.3.2-2: Time instances of cell power level and parameter changes for UTRA cell

	Parameter	Unit	Cell 5	Remark
T1	CPICH_Ec	dBm/3.84 MHz	-90	
	P-CCPCH	dBm/1.28 MHz	-92	
	Srxlev*	dB	-11	Srxlev _{ServingCell} < Thresh _{Serving,low}
T2	CPICH_Ec	dBm/3.84 MHz	-60	
	P-CCPCH	dBm/1.28 MHz	-62	
	Srxlev*	dB	19	
T3	CPICH_Ec	dBm/3.84 MHz	-70	
	P-CCPCH	dBm/1.28 MHz	-72	
	Srxlev*	dB	9	
Note : Srxlev is calculated in the UE				

Table 6.2.3.3.2-3: Main behaviour

St	Procedure	Message Sequence		TP	Verdict
		U - S	Message		
1	The SS changes Cell 1 and Cell 5 levels according to the row "T1" in table 6.2.3.3.2-1 and table 6.2.3.3.2-2.	-	-	-	-
2	Check: Does the test result of generic test procedure in TS 36.508 Table 6.4.2.7A-2 indicate that the UE is camped on E-UTRAN Cell 1?	-	-	1	-
2A	Wait for 6 s for UE to receive system information.	-	-	-	-
3	The SS changes Cell 1 and Cell 5 levels according to the row "T2" in table 6.2.3.3.2-1 and table 6.2.3.3.2-2.	-	-	-	-
4	Generic test procedure in TS 36.508 subclause 6.4.2.8 indicate that the UE is camped on UTRAN Cell 5. NOTE: The UE performs a RAU procedure and the RRC connection is released.	-	-	-	-
5	The SS changes the E-UTRA cell priority broadcast in system information.	-	-	-	-
6	Notify UE change of System Information.	<--	PAGING TYPE 1	-	-
7	The SS changes Cell 1 and Cell 5 levels according to the row "T3" in table 6.2.3.3.2-1 and table 6.2.3.3.2-2.	-	-	-	-
8	Check: Does the test result of generic test procedure in TS 36.508 Table 6.4.2.7A-1 indicate that the UE is camped on E-UTRAN Cell 1?	-	-	2	-

6.2.3.3.3.3 Specific message contents

Table 6.2.3.3.3-1: System Information Block type 19 for Cell 5 (preamble, Table 6.2.3.3.2-3)

Derivation Path: 36.508 table 4.4.4.1-1			
Information Element	Value/remark	Comment	Condition
SysInfoType19 ::= SEQUENCE {			
utra-PriorityInfoList ::= SEQUENCE {			
utra-ServingCell ::= SEQUENCE {			
priority	4		
s-PrioritySearch1	8 (16 dB)		
s-PrioritySearch2	Not present		
threshServingLow	4 (8 dB)		
}			
utran-FDD-FrequencyList	Not present		UTRA-FDD
utran-TDD-FrequencyList	Not present		UTRA-TDD
}			
gsm-PriorityInfoList	Not present		
eutra-FrequencyAndPriorityInfoList ::= SEQUENCE (SIZE (1..maxNumEUTRAFreqs)) OF SEQUENCE {			
earfcn [n]	Same downlink EARFCN as used for Cell 1		
measurementBandwidth [n]	Not present		
priority [n]	3		
qRxLevMinEUTRA [n]	-60 (-120 dBm)		
threshXhigh [n]	16 (32 dB)		
threshXlow [n]	10 (20 dB)		
eutra-blackListedCellList [n]	Not present		
eutraDetection [n]	TRUE		
}			
}			
Note:	GERAN cell priority is not allocated, hence it will be considered as the less than all allowed values of 0 to 7.		

Table 6.2.3.3.3-2: System Information Block type 19 for Cell 5 (step 5, Table 6.2.3.3.3.2-3)

Derivation Path: 36.508 table 4.4.4.1-1			
Information Element	Value/remark	Comment	Condition
SysInfoType19 ::= SEQUENCE {			
utra-PriorityInfoList ::= SEQUENCE {			
utra-ServingCell ::= SEQUENCE {			
priority	4		
s-PrioritySearch1	8 (16 dB)		
s-PrioritySearch2	Not present		
threshServingLow	4 (8 dB)		
}			
utran-FDD-FrequencyList	Not present		UTRA-FDD
utran-TDD-FrequencyList	Not present		UTRA-TDD
}			
gsm-PriorityInfoList	Not present		
eutra-FrequencyAndPriorityInfoList ::= SEQUENCE (SIZE (1..maxNumEUTRAFreqs)) OF SEQUENCE {			
earfcn [n]	Same downlink EARFCN as used for Cell 1		
measurementBandwidth [n]	Not present		
priority [n]	5		
qRxLevMinEUTRA [n]	-60 (-120 dBm)		
threshXhigh [n]	16 (32 dB)		
threshXlow [n]	10 (20 dB)		
eutra-blackListedCellList [n]	Not present		
eutraDetection [n]	TRUE		
}			
}			
Note:	GERAN cell priority is not allocated, hence it will be considered as the less than all allowed values of 0 to 7.		

Condition	Explanation
UTRA-FDD	UTRA FDD cell environment
UTRA-TDD	UTRA TDD cell environment

Table 6.2.3.3.3.3-3: PAGING TYPE 1 (step 6, Table 6.2.3.3.3.2-3)

Derivation path: 34.108 clause 9.1.1			
Information Element	Value/Remark	Comment	Condition
PagingType1 ::= SEQUENCE {			
pagingRecordList	Not present		
bcch-ModificationInfo ::= SEQUENCE {			
mib-ValueTag	Set to (Current MIB value tag + 1)		
bcch-ModificationTime	Not present		
}			
laterNonCriticalExtensions SEQUENCE {}	Not present		
}			

Table 6.2.3.3.3.3-4: SystemInformationBlockType3 for Cell 1 (preamble, Table 6.2.3.3.3.2-3)

Derivation path: 36.508 table 4.4.3.3-2			
Information Element	Value/Remark	Comment	Condition
SystemInformationBlockType3 ::= SEQUENCE {			
cellReselectionServingFreqInfo SEQUENCE {			
cellReselectionPriority	3		
}			
}			

Table 6.2.3.3.3-5: SystemInformationBlockType3 for Cell 1 (step 5, Table 6.2.3.3.2-3)

Derivation path: 36.508 table 4.4.3.3-2			
Information Element	Value/Remark	Comment	Condition
SystemInformationBlockType3 ::= SEQUENCE {			
cellReselectionServingFreqInfo SEQUENCE {			
cellReselectionPriority	5		
}			
}			

Table 6.2.3.3.3-6: SystemInformationBlockType6 for Cell 1 (preamble, Table 6.2.3.3.2-3)

Derivation path: 36.508 table 4.4.3.3-5			
Information Element	Value/remark	Comment	Condition
SystemInformationBlockType6 ::= SEQUENCE {			
CarrierFreqListUTRA-FDD SEQUENCE (SIZE (1..maxUTRA-FDD-Carrier)) OF SEQUENCE {			UTRA-FDD
carrierFreq[n]	Same downlink UARFCN as used for cell 5		
cellReselectionPriority[n]	4		
}			
CarrierFreqListUTRA-TDD SEQUENCE (SIZE (1..maxUTRA-TDD-Carrier)) OF SEQUENCE {			UTRA-TDD
carrierFreq[n]	Same downlink UARFCN as used for cell 5		
cellReselectionPriority[n]	4		
}			
}			

Condition	Explanation
UTRA-FDD	UTRA FDD cell environment
UTRA-TDD	UTRA TDD cell environment

Table 6.2.3.3.3-7: SystemInformationBlockType1 for Cell 1 (step 5, Table 6.2.3.3.2-3)

Derivation path: 36.508 table 4.4.3.3-2			
Information Element	Value/Remark	Comment	Condition
SystemInformationBlockType1 ::= SEQUENCE {			
systemInfoValueTag	The value is increased		
}			

6.2.3.3a Inter-RAT cell reselection / From UTRA_Idle to E-UTRA RRC_IDLE
($Q_{\text{qualminEUTRA}}$, $S_{\text{qualServingCell}} < \text{Thresh}_{\text{serv,low2}}$, $S_{\text{qualNonServingCell,x}} > \text{Thresh}_{\text{x,low2}}$ and $S_{\text{qualNonServingCell,x}} > \text{Thresh}_{\text{x,high2}}$)

6.2.3.3a.1 Test Purpose (TP)

(1)

```
with { UE in UTRA_Idle state }
ensure that {
  when { UE detects the cell re-selection criteria are met for the cell which belongs to the lower
priority inter-RAT E-UTRA cell }
  then { UE reselects the cell which belongs to the lower priority inter-RAT E-UTRA cell }
}
```

(2)

```
with { UE in UTRA_Idle state }
ensure that {
```

```

when { UE detects the cell re-selection criteria are met for the cell which belongs to the higher
priority inter-RAT E-UTRA cell}
  then { UE reselects the cell which belongs to the higher priority inter-RAT E-UTRA cell }
}

```

6.2.3.3a.2 Conformance requirements

References: The conformance requirements covered in the present TC are specified in: TS 25.304, clause 5.2.6.1.2a and 5.2.6.1.4a.

[TS 25.304, clause 5.2.6.1.2a]

If the UE has received absolute priority information for inter-RAT layers, the UE shall follow these rules:

- The UE shall perform measurements of inter-RAT layers with a priority higher than the priority of the current serving cell.

NOTE: The rate of these measurements may vary depending on whether S_{rxlev} and S_{qual} of the serving cell are above or below $S_{prioritysearch1}$ and $S_{prioritysearch2}$. This is specified in [10].

- For inter-RAT layers with a priority lower than the priority of the current serving cell:
 - If $S_{rxlev_{ServingCell}} > S_{prioritysearch1}$ and $S_{qual_{ServingCell}} > S_{prioritysearch2}$ the UE may choose not to perform measurements of inter-RAT layers of lower priority.
 - If $S_{rxlev_{ServingCell}} \leq S_{prioritysearch1}$ or $S_{qual_{ServingCell}} \leq S_{prioritysearch2}$ the UE shall perform measurements of inter-RAT layers of lower priority.

[TS 25.304, clause 5.2.6.1.4a]

Absolute priorities of different absolute priority layers may be provided to the UE. The following cell reselection criteria are used for inter-frequency cells if absolute priority information for inter-frequency is available to the UE, and inter-RAT cells if absolute priority information for inter-RAT is available to the UE.

...

The following definitions apply for the layers for which $Thresh_{x,high2}$ or $Thresh_{x,low2}$ are not provided:

- Criterion 1: the $S_{rxlev_{nonServingCell,x}}$ of a cell on an evaluated higher absolute priority layer is greater than $Thresh_{x,high}$ during a time interval $T_{reselection}$;

...

- Criterion 3: ($S_{rxlev_{ServingCell}} < Thresh_{serving,low}$ or $S_{qual_{ServingCell}} \leq 0$) and the $S_{rxlev_{nonServingCell,x}}$ of a cell on an evaluated lower absolute priority layer is greater than $Thresh_{x,low}$ during a time interval $T_{reselection}$;

The following definitions apply for the layers for which both $Thresh_{x,high2}$ and $Thresh_{x,low2}$ are provided:

- Criterion 4: the $S_{qual_{nonServingCell,x}}$ of a cell on an evaluated higher absolute priority layer is greater than $Thresh_{x,high2}$ during a time interval $T_{reselection}$;
- Criterion 5: ($S_{qual_{ServingCell}} < Thresh_{serving,low2}$ or $S_{rxlev_{ServingCell}} \leq 0$) and the $S_{qual_{nonServingCell,x}}$ of a cell on an evaluated lower absolute priority layer is greater than $Thresh_{x,low2}$ during a time interval $T_{reselection}$;

Cell reselection to a cell on a higher absolute priority layer than the camped frequency shall be performed if criterion 1 or 4 is fulfilled.

...

Cell reselection to a cell on a lower absolute priority layer than the camped frequency shall be performed if criterion 3 or 5 is fulfilled.

If more than one cell meets the above criteria, the UE shall reselect the cell with the highest $S_{rxlev_{nonServingCell,x}}$ among the cells meeting the criteria on the highest absolute priority layer.

The UE shall not perform cell reselection to cells for which the cell selection criterion S is not fulfilled.

The UE shall not perform cell reselection until more than 1 second has elapsed since the UE camped on the current serving cell.

...

Cell reselection from UTRAN to E-UTRAN, for which Squal (RSRQ) based cell reselection parameters are broadcast in system information, shall be performed based on the Squal criteria (criterion 4 or 5) if the UE supports Squal based cell reselection from E-UTRAN to UTRAN. Otherwise, cell reselection to E-UTRAN shall be performed based on Srxlev criteria.

6.2.3.3a.3 Test description

6.2.3.3a.3.1 Pre-test conditions

System Simulator:

- Cell 1 and Cell 5

UE:

None.

Preamble:

- The UE is in state Registered, Idle mode (state 3 or 7) on Cell 5 (serving cell) according to [5].

6.2.3.3a.3.2 Test procedure sequence

Tables 6.2.3.3a.3.2-1 & Table 6.2.3.3a.3.2-2 illustrate the downlink power levels and other changing parameters to be applied for the cells at various time instants of the test execution. Subsequent configurations marked "T1", "T2" and "T3" are applied at the points indicated in the Main behaviour description in Table 6.2.3.3a.3.2-3.

Table 6.2.3.3a.3.2-1: Time instances of cell power level and parameter changes for E-UTRA cell

	Parameter	Unit	Cell 1	Remark
T1	Cell-specific RS EPRE	dBm/15kHz	-85	Squal _{nonServingCell, Cell1} > Thresh Cell1,low2 (4 dB)
	RSRQ	dB	-3	
	Qqualmin	dB	-20	
	Noc	dBm/15kHz	Off	
T2	Cell-specific RS EPRE	dBm/15kHz	-115	
	RSRQ	dB	-3	
T3	Cell-specific RS EPRE	dBm/15kHz	-85	
	RSRQ	dB	-3	S _{nonServingCell, Cell1} > Thresh Cell1,high2

Table 6.2.3.3a.3.2-2: Time instances of cell power level and parameter changes for UTRA cell

	Parameter	Unit	Cell 5	Remark
T1	CPICH_Ec	dBm/3.84 MHz	-70	Squal _{ServingCell} < Thresh _{Serving,low2} (25 dB)
	P-CCPCH	dBm/1.28 MHz	-72	
	CPICH_Ec/No	dB	-2.89	
	QqualminFDD	dB	-20	
	loc	dBm/3.84MHz	off	
T2	CPICH_Ec	dBm/3.84 MHz	-60	
	P-CCPCH	dBm/1.28 MHz	-62	
	CPICH_Ec/No	dB	-2.89	
T3	CPICH_Ec	dBm/3.84 MHz	-70	
	P-CCPCH	dBm/1.28 MHz	-72	
	CPICH_Ec/No	dB	-2.89	

Table 6.2.3.3a.3.2-3: Main behaviour

St	Procedure	Message Sequence		TP	Verdict
		U - S	Message		
1	The SS changes Cell 1 and Cell 5 levels according to the row "T1" in table 6.2.3.3a.3.2-1 and table 6.2.3.3a.3.2-2.	-	-	-	-
2	Check: Does the test result of generic test procedure in TS 36.508 Table 6.4.2.7A-2 indicate that the UE is camped on E-UTRAN Cell 1?	-	-	1	-
3	Void	-	-	-	-
4	The SS changes Cell 1 and Cell 5 levels according to the row "T2" in table 6.2.3.3a.3.2-1 and table 6.2.3.3a.3.2-2.	-	-	-	-
5	The UE selects and perform the test result of generic test procedure in TS 36.508 subclause 6.4.2.8 indicates that the UE is camped on UTRAN Cell 5.	-	-	-	-
6	The SS changes the E-UTRA cell priority broadcast in system information.	-	-	-	-
7	Notify UE change of System Information.	<--	PAGING TYPE 1	-	-
8	The SS changes Cell 1 and Cell 5 levels according to the row "T3" in table 6.2.3.3a.3.2-1 and table 6.2.3.3a.3.2-2.	-	-	-	-
9	Check: Does the test result of generic test procedure in TS 36.508 Table 6.4.2.7A-1 indicate that the UE is camped on E-UTRAN Cell 1?	-	-	2	-

6.2.3.3a.3.3 Specific message contents

Table 6.2.3.3a.3.3-1: System Information Block type 19 for Cell 5 (preamble, Table 6.2.3.3a.3.2-3)

Derivation Path: 36.508 table 4.4.4.1-1			
Information Element	Value/remark	Comment	Condition
SysInfoType19 ::= SEQUENCE {			
utra-PriorityInfoList ::= SEQUENCE {			
utra-ServingCell ::= SEQUENCE {			
priority	4		
s-PrioritySearch1	12 (24 dB)		
s-PrioritySearch2	0 (0 dB)		
threshServingLow	2 (4 dB)		
}			
utran-FDD-FrequencyList	Not present		UTRA-FDD
utran-TDD-FrequencyList	Not present		UTRA-TDD
}			
gsm-PriorityInfoList	Not present		
eutra-FrequencyAndPriorityInfoList ::= SEQUENCE (SIZE (1..maxNumEUTRAFreqs)) OF SEQUENCE {			
earfcn [n]	Same downlink EARFCN as used for Cell 1		
measurementBandwidth [n]	Not present		
priority [n]	3		
qRxlevMinEUTRA [n]	-53 (-106 dBm)		
qQualminEUTRA [n]	-20		
eutra-blackListedCellList [n]	Not present		
eutraDetection [n]	[TRUE]		
}			
v920NonCriticalExtensions SEQUENCE {			
sysInfoType19-v920ext SEQUENCE {			
utra-PriorityInfoList-v920ext SEQUENCE {			
threshServingLow2	25 (25dB)		
}			
eutra-FrequencyAndPriorityInfoList-v920ext (SIZE (1..maxNumEUTRAFreqs)) OF SEQUENCE {			
qQualMinEUTRA[n]	-20 (-20dB)		
threshXhigh2[n]	8 (8dB)		
threshXlow2[n]	4 (4dB)		
}			
}			
nonCriticalExtensions SEQUENCE {}	Not present		
}			
}			
Note:	GERAN cell priority is not allocated, hence it will be considered as the less than all allowed values of 0 to 7.		

Condition	Explanation
UTRA-FDD	UTRA FDD cell environment
UTRA-TDD	UTRA TDD cell environment

Table 6.2.3.3a.3.3-2: System Information Block type 19 for Cell 5 (step 6, Table 6.2.3.3a.3.2-3)

Derivation Path: 36.508 table 4.4.4.1-1			
Information Element	Value/remark	Comment	Condition
SysInfoType19 ::= SEQUENCE {			
utra-PriorityInfoList ::= SEQUENCE {			
utra-ServingCell ::= SEQUENCE {			
priority	4		
s-PrioritySearch1	2 (4 dB)		
s-PrioritySearch2	0 (0 dB)		
threshServingLow	2 (4 dB)		
}			
utran-FDD-FrequencyList	Not present		UTRA-FDD
utran-TDD-FrequencyList	Not present		UTRA-TDD
}			
gsm-PriorityInfoList	Not present		
eutra-FrequencyAndPriorityInfoList ::= SEQUENCE (SIZE (1..maxNumEUTRAFreqs)) OF SEQUENCE {			
earfcn [n]	Same downlink EARFCN as used for Cell 1		
measurementBandwidth [n]	Not present		
priority [n]	5		
qRxlevMinEUTRA [n]	-53 (106 dBm)		
threshXhigh [n]	15 (30 dB)		
qQualminEUTRA [n]	-20		
eutra-blackListedCellList [n]	Not present		
eutraDetection [n]	[TRUE]		
}			
v920NonCriticalExtensions SEQUENCE {			
sysInfoType19-v920ext SEQUENCE {			
utra-PriorityInfoList-v920ext SEQUENCE {			
threshServingLow2	8 (8dB)		
}			
eutra-FrequencyAndPriorityInfoList-v920ext (SIZE (1..maxNumEUTRAFreqs)) OF SEQUENCE {			
qQualMinEUTRA[n]	-20 (-20dB)		
threshXhigh2[n]	4 (4dB)		
threshXlow2[n]	4 (4dB)		
}			
}			
nonCriticalExtensions SEQUENCE {}	Not present		
}			
}			
Note:	GERAN cell priority is not allocated, hence it will be considered as the less than all allowed values of 0 to 7.		

Condition	Explanation
UTRA-FDD	UTRA FDD cell environment
UTRA-TDD	UTRA TDD cell environment

Table 6.2.3.3a.3.3-3: PAGING TYPE 1 (step 7, Table 6.2.3.3a.3.2-3)

Derivation path: 34.108 clause 9.1.1			
Information Element	Value/Remark	Comment	Condition
PagingType1 ::= SEQUENCE {			
pagingRecordList	Not present		
bcch-ModificationInfo ::= SEQUENCE {			
mib-ValueTag	Set to (Current MIB value tag + 1)		
bcch-ModificationTime	Not present		
}			
laterNonCriticalExtensions SEQUENCE {}	Not present		
}			

Table 6.2.3.3a.3.3-4: SystemInformationBlockType3 for Cell 1(preamble, Table 6.2.3.3a.3.2-3)

Derivation path: 36.508 table 4.4.3.3-2			
Information Element	Value/Remark	Comment	Condition
SystemInformationBlockType3 ::= SEQUENCE {			
cellReselectionServingFreqInfo SEQUENCE {			
cellReselectionPriority	3		
}			
lateNonCriticalExtension {			
s-IntraSearch-v920 SEQUENCE {}	Not present		
s-NonIntraSearch-v920 SEQUENCE {}	Not present		
q-QualMin-r9	-20 dB		
threshServingLowQ-r9	0 dB		
}			

Table 6.2.3.3a.3.3-5: SystemInformationBlockType3 for Cell 1(step 6, Table 6.2.3.3a.3.2-3)

Derivation path: 36.508 table 4.4.3.3-2			
Information Element	Value/Remark	Comment	Condition
SystemInformationBlockType3 ::= SEQUENCE {			
cellReselectionServingFreqInfo SEQUENCE {			
cellReselectionPriority	5		
}			
lateNonCriticalExtension {			
s-IntraSearch-v920 SEQUENCE {}	Not present		
s-NonIntraSearch-v920 SEQUENCE {}	Not present		
q-QualMin-r9	-20 dB		
threshServingLowQ-r9	0 dB		
}			
}			

Table 6.2.3.3a.3.3-6: SystemInformationBlockType6 for Cell 1(preamble, Table 6.2.3.3a.3.2-3)

Derivation path: 36.508 table 4.4.3.3-5			
Information Element	Value/remark	Comment	Condition
SystemInformationBlockType6 ::= SEQUENCE {			
CarrierFreqListUTRA-FDD SEQUENCE (SIZE (1..maxUTRA-FDD-Carrier)) OF SEQUENCE {			UTRA-FDD
carrierFreq[n]	Same downlink UARFCN as used for cell 5		
cellReselectionPriority[n]	4		
}			
CarrierFreqListUTRA-TDD SEQUENCE (SIZE (1..maxUTRA-TDD-Carrier)) OF SEQUENCE {			UTRA-TDD
carrierFreq[n]	Same downlink UARFCN as used for cell 5		
cellReselectionPriority[n]	4		
}			
}			

Condition	Explanation
UTRA-FDD	UTRA FDD cell environment
UTRA-TDD	UTRA TDD cell environment

6.2.3.4 Inter-RAT cell reselection / From UTRA_CELL_PCH state to E-UTRA RRC_IDLE

6.2.3.4.1 Test Purpose (TP)

(1)

```
with { UE in UTRA_CELL_PCH state }
ensure that {
  when { UE detects the cell re-selection criteria are met for the cell which belongs to the higher
priority inter-RAT E-UTRA cell}
  then { UE reselects the cell which belongs to the higher priority inter-RAT E-UTRA cell }
}
```

6.2.3.4.2 Conformance requirements

References: The conformance requirements covered in the present TC are specified in: TS 25.304, clause 5.2.6.1.2a and 5.2.6.1.4a; TS 25.331, clause 8.3.9.2, 8.3.9.3, Annex E.

[TS 25.304, clause 5.2.6.1.2a]

The measurement rules below apply in Idle, URA_PCH, CELL_PCH states.

...

If the UE has received absolute priority information for inter-RAT layers, the UE shall follow these rules:

- The UE shall perform measurements of inter-RAT layers with a priority higher than the priority of the current serving cell.

NOTE: The rate of these measurements may vary depending on whether S_{rxlev} and S_{qual} of the serving cell are above or below $S_{prioritysearch1}$ and $S_{prioritysearch2}$. This is specified in [10].

- For inter-RAT layers with a priority lower than the priority of the current serving cell:
 - If $S_{rxlev}_{ServingCell} > S_{prioritysearch1}$ and $S_{qual}_{ServingCell} > S_{prioritysearch2}$ the UE may choose not to perform measurements of inter-RAT layers of lower priority.
 - If $S_{rxlev}_{ServingCell} \leq S_{prioritysearch1}$ or $S_{qual}_{ServingCell} \leq S_{prioritysearch2}$ the UE shall perform measurements of inter-RAT layers of lower priority.

[TS 25.304, clause 5.2.6.1.4a]

Absolute priorities of different absolute priority layers may be provided to the UE. The following cell reselection criteria are used for inter-frequency cells if absolute priority information for inter-frequency is available to the UE, and inter-RAT cells if absolute priority information for inter-RAT is available to the UE.

...

The following definitions apply:

- Criterion 1: the $Srxlev_{nonServingCell,x}$ of a cell on an evaluated higher absolute priority layer is greater than $Thresh_{x,high}$ during a time interval $Treselection$;

...

Cell reselection to a cell on a higher absolute priority layer than the camped frequency shall be performed if criterion 1 is fulfilled.

...

If more than one cell meets the above criteria, the UE shall reselect the cell with the highest $Srxlev_{nonServingCell,x}$ among the cells meeting the criteria on the highest absolute priority layer.

The UE shall not perform cell reselection to cells for which the cell selection criterion S is not fulfilled.

The UE shall not perform cell reselection until more than 1 second has elapsed since the UE camped on the current serving cell.

For UE in RRC connected mode states CELL_PCH or URA_PCH the interval $Treselection_{s,PCH}$ applies, if provided in SIB4 (see [4]), while for UE in RRC connected mode state CELL_FACH the interval $Treselection_{s,FACH}$ applies, if provided in SIB4 (see [4]).

In all the above criteria the values of $Treselection_s$, $Treselection_{s,PCH}$ or $Treselection_{s,FACH}$ apply for $Treselection$ and are scaled according to the UE mobility state and target RAT, as specified in 5.2.6.1.1a.

[TS 25.331, 8.3.9.2]

This procedure is applicable in states CELL_FACH, CELL_PCH or URA_PCH. Inter-RAT cell reselection to E-UTRAN in CELL_FACH state is not supported in this version of the specification.

When the UE based on received system information makes a cell reselection to a radio access technology other than UTRAN, e.g. GSM/GPRS or E-UTRA, according to the criteria specified in [4], the UE shall:

...

[TS 25.331, 8.3.9.3]

When the UE has succeeded in reselecting a cell in the target radio access technology, the UE shall:

- 1> release all UTRAN specific resources.

UTRAN should:

- 1> release all UE dedicated resources upon indication that the UE has completed a connection establishment to the other radio access technology.

[TS 25.331, Annex E]

This annex contains the definitions of the bits in EUTRA Feature Group Indicators.

In this release of the specification the UE shall include the optional EUTRA Feature Group Indicators IE in the UE multi-mode/multi RAT capability IE of the RRC message. For a specific indicator, if all functionalities for a feature group listed in Table E.1 have been implemented and tested, the UE shall set the indicator as "true" (as one), else (i.e. if any one of the functionalities in a feature group listed in Table E.1 have not been implemented or tested), the UE shall set the indicator as zero.

The UE shall set all indicators, which do not have a definition in the table E.1, as "false" (as zero).

If the optional EUTRA Feature Group Indicators IE is not included by a UE supporting a future release of the specification, the network may assume the UE supports all features in the feature groups listed in table E.1 and deployed in the network.

Table E.1: Definitions of feature group indicators

Index of indicator (bit number)	Definition (description of the supported functionality, if indicator set to 'true')	Notes
1 (leftmost bit)	- UTRA CELL_PCH to EUTRA RRC_IDLE cell reselection - UTRA URA_PCH to EUTRA RRC_IDLE cell reselection	
2	EUTRAN measurements and reporting in connected mode	
3	Undefined	
4	Undefined	

Clarification for mobility to EUTRAN

For mobility to E-UTRAN, it is assumed that we have 6 main "functions":

- A. Support of measurements and cell reselection procedure in idle mode
- B. Support of measurements and cell reselection procedure in CELL/URA_PCH
- C. Support of RRC release with redirection procedure
- D. Support of RRC reject with redirection procedure
- E. Support of EUTRAN measurements and reporting in connected mode
- F. Support of handover procedure in connected mode

Of the above, all UEs that indicate support of E-UTRA in UE capability signalling "Support of E-UTRA FDD" or "Support of E-UTRA TDD" support A), C) and D) EUTRA bands.

For B) above, UEs indicate support by the Group 1 indicator bit (if Group 1 is set to "true", it is supported for all EUTRA bands the UE supports).

For E) above, UEs indicate support by the Group 2 indicator bit (if Group 2 is set to "true", it is supported for all EUTRA bands the UE supports). The compressed mode capability for supported E-UTRA frequency bands ("Need for compressed mode") in "Measurement capability extension" is ignored by the network when Group 2 is set to "false".

For F) above, UEs indicate support by the separate UE capability signalling "Support of Inter-RAT PS Handover to E-UTRA FDD/TDD" defined in TS 25.306 (if this bit is set to "true", PS handover is supported for all EUTRA bands the UE supports). This bit can only be set to "true" if the UE has set the Group 2 indicator bit to "true".

6.2.3.4.3 Test description

6.2.3.4.3.1 Pre-test conditions

System Simulator:

- Cell 1 and Cell 5.
 - Cell 1 suitable neighbour E-UTRA cell
 - Cell 5 UTRA serving cell

UE:

None.

Preamble:

- The UE is in state CELL_PCH (state 6-12) on Cell 5 according to [5].

- The cell power level and parameter for Cell 5 is as follow:

Parameter	Unit	Cell 5	Remark
CPICH_Ec	dBm/3.84 MHz	-60	
P-CCPCH	dBm/1.28 MHz	-62	
Qrxlevmin (FDD)	dBm	-79	Default value
Qrxlevmin(TDD)	dBm	-81	Default value

6.2.3.4.3.2 Test procedure sequence

Table 6.2.3.4.3.2-1: Time instance of cell power level and parameter changes for E-UTRA cell and UTRA cell

	Parameter	Unit	Cell 1	Cell 5	Remark
T1	Cell-specific RS EPRE	dBm/15kHz	-80		
	Srxlev*	dB	26		Srxlev = Cell-specific RS EPRE - qRxLevMinEUTRA S _{nonServingCell, Cell1} > Thresh _{Cell1,high}
	CPICH_Ec	dBm/3.84 MHz		-70	
	P-CCPCH	dBm/1.28 MHz		-72	
	Srxlev*	dB		9	
Note: Srxlev is calculated in the UE					

Table 6.2.3.4.3.2-2: Main behaviour

St	Procedure	Message Sequence		TP	Verdict
		U - S	Message		
1	The SS changes Cell 1 and Cell 5 levels according to the row "T1" in table 6.2.3.4.3.2-1. (Note 1)	-	-	-	-
2	Check: Does the test result of generic test procedure in TS 36.508 Table 6.4.2.7A-1 indicate that the UE is camped on E-UTRAN Cell 1? (Note 2)	-	-	1	-
Note 1: SS should not send any RRC message after UE has successfully proceed to CELL_PCH state in preamble.					
Note 2: UE shall search higher priority layer (i.e. E-UTRA carrier frequency of Cell 1) at least every (60 * N _{layers}) seconds, where N _{layers} = 1 as specified in [4.2.2, 34].					

6.2.3.4.3.3 Specific message contents

Table 6.2.3.4.3.3-1: System Information Block type 19 for Cell 5 (preamble and all steps, Table 6.2.3.4.3.2-2)

Derivation Path: 36.508 table 4.4.4.1-1			
Information Element	Value/remark	Comment	Condition
SysInfoType19 ::= SEQUENCE {			
utra-PriorityInfoList ::= SEQUENCE {			
utra-ServingCell ::= SEQUENCE {			
priority	4		
}			
utra-FrequencyAndPriorityInfoList ::= SEQUENCE (SIZE (1..maxNumEUTRAFreqs)) OF SEQUENCE {	1 entry		
earfcn [1]	Same downlink EARFCN as used for Cell 1		
priority [1]	5		
qRxLevMinEUTRA [1]	-53 (-106 dBm)		
threshXhigh [1]	10 (20 dB)		
threshXlow [1]	5 (10 dB)		
}			
}			

Table 6.2.3.4.3.3-2: Void

Table 6.2.3.4.3.3-3: *SystemInformationBlockType3* for Cell 1 (preamble and all steps, Table 6.2.3.4.3.2-2)

Derivation path: 36.508 table 4.4.3.3-2			
Information Element	Value/Remark	Comment	Condition
SystemInformationBlockType3 ::= SEQUENCE {			
cellReselectionServingFreqInfo SEQUENCE {			
CellReselectionPriority	5		
}			
}			

Table 6.2.3.4.3.3-4: *SystemInformationBlockType6* for Cell 1 (preamble and all steps, Table 6.2.3.4.3.2-2)

Derivation path: 36.508 table 4.4.3.3-5			
Information Element	Value/remark	Comment	Condition
SystemInformationBlockType6 ::= SEQUENCE {			
CarrierFreqListUTRA-FDD SEQUENCE (SIZE (1..maxUTRA-FDD-Carrier)) OF SEQUENCE {			UTRA-FDD
carrierFreq[n]	Same as Cell 5		
cellReselectionPriority[n]	4		
}			
CarrierFreqListUTRA-TDD SEQUENCE (SIZE (1..maxUTRA-TDD-Carrier)) OF SEQUENCE {			UTRA-TDD
carrierFreq[n]	Same as Cell 5		
cellReselectionPriority[n]	4		
}			
}			

Condition	Explanation
UTRA-FDD	UTRA FDD cell environment
UTRA-TDD	UTRA TDD cell environment

6.2.3.4a Inter-RAT cell reselection / From UTRA_CELL_PCH state to E-UTRA RRC_IDLE based on RSRQ+RSRP evaluation

6.2.3.4a.1 Test Purpose (TP)

(1)

```
with { UE in UTRA_CELL_PCH state }
ensure that {
  when { UE detects the cell re-selection criteria ( RSRQ => Squal >0 , RSRP => Srxlev >0 )are met
for the cell which belongs to the higher priority inter-RAT E-UTRA cell}
  then { UE reselects the cell which belongs to the higher priority inter-RAT E-UTRA cell }
}
```

6.2.3.4a.2 Conformance requirements

References: The conformance requirements covered in the present TC are specified in: TS 25.304, clause 5.2.6.1.2a and 5.2.6.1.4a; TS 25.331, clause 8.3.9.2, 8.3.9.3, Annex E.

[TS 25.304, clause 5.2.6.1.2a]

The measurement rules below apply in Idle, URA_PCH, CELL_PCH states.

...

If the UE has received absolute priority information for inter-RAT layers, the UE shall follow these rules:

- The UE shall perform measurements of inter-RAT layers with a priority higher than the priority of the current serving cell.

NOTE: The rate of these measurements may vary depending on whether S_{rxlev} and S_{qual} of the serving cell are above or below $S_{prioritysearch1}$ and $S_{prioritysearch2}$. This is specified in [10].

- For inter-RAT layers with a priority lower than the priority of the current serving cell:
 - If $S_{rxlev}_{ServingCell} > S_{prioritysearch1}$ and $S_{qual}_{ServingCell} > S_{prioritysearch2}$ the UE may choose not to perform measurements of inter-RAT layers of lower priority.
 - If $S_{rxlev}_{ServingCell} \leq S_{prioritysearch1}$ or $S_{qual}_{ServingCell} \leq S_{prioritysearch2}$ the UE shall perform measurements of inter-RAT layers of lower priority.

[TS 25.304, clause 5.2.6.1.4a]

Absolute priorities of different absolute priority layers may be provided to the UE. The following cell reselection criteria are used for inter-frequency cells if absolute priority information for inter-frequency is available to the UE, and inter-RAT cells if absolute priority information for inter-RAT is available to the UE.

...

The following definitions apply:

- Criterion 1: the $S_{rxlev}_{nonServingCell,x}$ of a cell on an evaluated higher absolute priority layer is greater than $Thresh_{x,high}$ during a time interval $T_{reselection}$;

...

Cell reselection to a cell on a higher absolute priority layer than the camped frequency shall be performed if criterion 1 is fulfilled.

...

[TS 25.304, clause 5.2.6.1.4a]

Absolute priorities of different absolute priority layers may be provided to the UE. The following cell reselection criteria are used for inter-frequency cells if absolute priority information for inter-frequency is available to the UE, and inter-RAT cells if absolute priority information for inter-RAT is available to the UE.

...

The following definitions apply for the layers for which $Thresh_{x,high2}$ or $Thresh_{x,low2}$ are not provided:

- Criterion 1: the $S_{rxlev}_{nonServingCell,x}$ of a cell on an evaluated higher absolute priority layer is greater than $Thresh_{x,high}$ during a time interval $T_{reselection}$;
- ...
- Criterion 3: ($S_{rxlev}_{ServingCell} < Thresh_{serving,low}$ or $S_{qual}_{ServingCell} \leq 0$) and the $S_{rxlev}_{nonServingCell,x}$ of a cell on an evaluated lower absolute priority layer is greater than $Thresh_{x,low}$ during a time interval $T_{reselection}$;

The following definitions apply for the layers for which both $Thresh_{x,high2}$ and $Thresh_{x,low2}$ are provided:

- Criterion 4: the $S_{qual}_{nonServingCell,x}$ of a cell on an evaluated higher absolute priority layer is greater than $Thresh_{x,high2}$ during a time interval $T_{reselection}$;
- Criterion 5: ($S_{qual}_{ServingCell} < Thresh_{serving,low2}$ or $S_{rxlev}_{ServingCell} \leq 0$) and the $S_{qual}_{nonServingCell,x}$ of a cell on an evaluated lower absolute priority layer is greater than $Thresh_{x,low2}$ during a time interval $T_{reselection}$;

Cell reselection to a cell on a higher absolute priority layer than the camped frequency shall be performed if criterion 1 or 4 is fulfilled.

...

Cell reselection to a cell on a lower absolute priority layer than the camped frequency shall be performed if criterion 3 or 5 is fulfilled.

The UE shall not perform cell reselection until more than 1 second has elapsed since the UE camped on the current serving cell.

...

If more than one cell meets the above criteria, the UE shall reselect the cell with the highest $Srxlev_{nonServingCell,x}$ among the cells meeting the criteria on the highest absolute priority layer.

The UE shall not perform cell reselection to cells for which the cell selection criterion S is not fulfilled.

The UE shall not perform cell reselection until more than 1 second has elapsed since the UE camped on the current serving cell.

For UE in RRC connected mode states CELL_PCH or URA_PCH the interval $Treselection_{s,PCH}$ applies, if provided in SIB4 (see [4]), while for UE in RRC connected mode state CELL_FACH the interval $Treselection_{s,FACH}$ applies, if provided in SIB4 (see [4]).

In all the above criteria the values of $Treselection_s$, $Treselection_{s,PCH}$ or $Treselection_{s,FACH}$ apply for $Treselection$ and are scaled according to the UE mobility state and target RAT, as specified in 5.2.6.1.1a.

...

Cell reselection from UTRAN to E-UTRAN, for which Squal (RSRQ) based cell reselection parameters are broadcast in system information, shall be performed based on the Squal criteria (criterion 4 or 5) if the UE supports Squal based cell reselection from E-UTRAN to UTRAN. Otherwise, cell reselection to E-UTRAN shall be performed based on $Srxlev$ criteria.

[TS 25.331, 8.3.9.2]

This procedure is applicable in states CELL_FACH, CELL_PCH or URA_PCH. Inter-RAT cell reselection to E-UTRAN in CELL_FACH state is not supported in this version of the specification.

When the UE based on received system information makes a cell reselection to a radio access technology other than UTRAN, e.g. GSM/GPRS or E-UTRA, according to the criteria specified in [4], the UE shall:

...

[TS 25.331, 8.3.9.3]

When the UE has succeeded in reselecting a cell in the target radio access technology, the UE shall:

- 1> release all UTRAN specific resources.

UTRAN should:

- 1> release all UE dedicated resources upon indication that the UE has completed a connection establishment to the other radio access technology.

[TS 25.331, Annex E]

This annex contains the definitions of the bits in EUTRA Feature Group Indicators.

In this release of the specification the UE shall include the optional EUTRA Feature Group Indicators IE in the UE multi-mode/multi RAT capability IE of the RRC message. For a specific indicator, if all functionalities for a feature group listed in Table E.1 have been implemented and tested, the UE shall set the indicator as "true" (as one), else (i.e. if any one of the functionalities in a feature group listed in Table E.1 have not been implemented or tested), the UE shall set the indicator as zero.

The UE shall set all indicators, which do not have a definition in the table E.1, as "false" (as zero).

If the optional EUTRA Feature Group Indicators IE is not included by a UE supporting a future release of the specification, the network may assume the UE supports all features in the feature groups listed in table E.1 and deployed in the network.

Table E.1: Definitions of feature group indicators

Index of indicator (bit number)	Definition (description of the supported functionality, if indicator set to 'true')	Notes
1 (leftmost bit)	- UTRA CELL_PCH to EUTRA RRC_IDLE cell reselection - UTRA URA_PCH to EUTRA RRC_IDLE cell reselection	
2	EUTRAN measurements and reporting in connected mode	
3	Undefined	
4	Undefined	

Clarification for mobility to EUTRAN

For mobility to E-UTRAN, it is assumed that we have 6 main "functions":

- A. Support of measurements and cell reselection procedure in idle mode
- B. Support of measurements and cell reselection procedure in CELL/URA_PCH
- C. Support of RRC release with redirection procedure
- D. Support of RRC reject with redirection procedure
- E. Support of EUTRAN measurements and reporting in connected mode
- F. Support of handover procedure in connected mode

Of the above, all UEs that indicate support of E-UTRA in UE capability signalling "Support of E-UTRA FDD" or "Support of E-UTRA TDD" support A), C) and D) EUTRA bands.

For B) above, UEs indicate support by the Group 1 indicator bit (if Group 1 is set to "true", it is supported for all EUTRA bands the UE supports).

For E) above, UEs indicate support by the Group 2 indicator bit (if Group 2 is set to "true", it is supported for all EUTRA bands the UE supports). The compressed mode capability for supported E-UTRA frequency bands ("Need for compressed mode") in "Measurement capability extension" is ignored by the network when Group 2 is set to "false".

For F) above, UEs indicate support by the separate UE capability signalling "Support of Inter-RAT PS Handover to E-UTRA FDD/TDD" defined in TS 25.306 (if this bit is set to "true", PS handover is supported for all EUTRA bands the UE supports). This bit can only be set to "true" if the UE has set the Group 2 indicator bit to "true".

6.2.3.4a.3 Test description**6.2.3.4a.3.1 Pre-test conditions**

System Simulator:

- Cell 1 and Cell 5.
 - Cell 1 suitable neighbour E-UTRA cell
 - Cell 5 UTRA serving cell

UE:

None.

Preamble:

- UE is in state Registered, Idle Mode (state 3 or 7) on Cell 5 (serving cell) according to [5].
- The cell power level and parameter for Cell 5 is as follow:

Parameter	Unit	Cell 5	Remark
CPICH_Ec	dBm/3.84 MHz	-60	
P-CCPCH	dBm/1.28 MHz	-62	
Qrxlevmin (FDD)	dBm	-79	Default value
Qrxlevmin(TDD)	dBm	-81	Default value

6.2.3.4a.3.2 Test procedure sequence

Tables 6.2.3.3a.3.2-1 & Table 6.2.3.3a.3.2-2 illustrate the downlink power levels and other changing parameters to be applied for the cells applied at the points indicated in the Main behaviour description in Table 6.2.3.4a.3.2-3.

Table 6.2.3.3a.3.2-1: Time instances of cell power level and parameter changes for E-UTRA cell

	Parameter	Unit	Cell 1	Remark
T1	Cell-specific RS EPRE	dBm/15 kHz	-75	Steps 1-3, $Squal_{nonServingCell,1} < Thresh_{x,high2}(26 \text{ dB})$ Steps 4-7, $Squal_{nonServingCell,1} > Thresh_{x,high2}(4 \text{ dB})$
	RSRQ	dB	-3	
	Qrxlevmin	dBm	-84	
	Qqualmin	dB	-20	
	Noc	dBm/15 kHz	off	
	Note: The downlink signal level uncertainty is specified in TS 36.508 section 4.3.4.1			

Table 6.2.3.3a.3.2-2: Time instances of cell power level and parameter changes for UTRA cell

	Parameter	Unit	Cell 5	Remark
T1	CPICH_Ec	dBm/3.84 MHz	-70	
	P-CCPCH	dBm/1.28 MHz	-72	
	CPICH_Ec/Io	dB	-2.89	
	QqualminFDD	dB	-20	
	loc	dBm/3.84MHz	off	

Table 6.2.3.4a.3.2-3: Main behaviour

St	Procedure	Message Sequence		TP	Verdict
		U - S	Message		
1	The SS changes Cell 1 and Cell 5 levels according to the row "T1" in table 6.2.3.4a.3.2-1 and 6.2.3.4a.3.2-2.	-	-	-	-
2	The UE is brought to state CELL_PCH (state 6-12) on Cell 5 according to [5] with modified SIB-19 info so that Cell 1 $Squal_{cell 1} < thresh_{Xhigh2}$ according to table 6.2.3.4a.3.2-1	-	-	-	-
3	Check: Does the test result of generic test procedure in TS 36.508 Table 6.4.2.7A-2 indicate that the UE is NOT camped on E-UTRAN Cell 1? (Note 2)	-	-	-	-
4	The SS changes the SIB-19 info so that for Cell 1 $Squal_{cell 1} > thresh_{Xhigh2}$ according to table 6.2.3.4a.3.2-2.	-	-	-	-
5	Notify UE change of System Information.	<-	- PAGING TYPE 1		
6	Wait for 6 s for UE to receive system information.	-	-	-	-
7	Check: Does the test result of generic test procedure in TS 36.508 Table 6.4.2.7A-1 indicate that the UE is camped on E-UTRAN Cell 1? (Note 2)	-	-	1	-

Note 1: Void

Note 2: UE shall search higher priority layer (i.e. E-UTRA carrier frequency of Cell 1) at least every $(60 * N_{layers})$ seconds, where $N_{layers} = 1$ as specified in [4.2.2, 34].

6.2.3.4a.3.3 Specific message contents

Table 6.2.3.4a.3.3-1: System Information Block type 19 for Cell 5 (at preamble, Table 6.2.3.4a.3.2-3)

Derivation Path: 36.508 table 4.4.4.1-1			
Information Element	Value/remark	Comment	Condition
SysInfoType19 ::= SEQUENCE {			
utra-PriorityInfoList ::= SEQUENCE {			
utra-ServingCell ::= SEQUENCE {			
Priority	3		
s-PrioritySearch1	2 (4 dB)		
s-PrioritySearch2	0 (0 dB)		
threshServingLow	2 (4 dB)		
}			
utran-FDD-FrequencyList	Not present		UTRA-FDD
utran-TDD-FrequencyList	Not present		UTRA-TDD
}			
gsm-PriorityInfoList	Not present		
eutra-FrequencyAndPriorityInfoList ::= SEQUENCE (SIZE (1..maxNumEUTRAFreqs)) OF SEQUENCE {			
earfcn [n]	Same downlink EARFCN as used for Cell 1		
measurementBandwidth [n]	Not present		
priority [n]	5		
qRxlevMinEUTRA [n]	-84 (-168 dBm)		
qQualminEUTRA [n]	-20		
eutra-blackListedCellList [n]	Not present		
eutraDetection [n]	TRUE		
}			
v920NonCriticalExtensions SEQUENCE {			
sysInfoType19-v920ext SEQUENCE {			
utra-PriorityInfoList-v920ext SEQUENCE {			
threshServingLow2	8 (8dB)		
}			
eutra-FrequencyAndPriorityInfoList-v920ext (SIZE (1..maxNumEUTRAFreqs)) OF SEQUENCE {			
qQualMinEUTRA[n]	-20 (-20dB)		
threshXhigh2[n]	26 (26dB)		
threshXlow2[n]	4 (4dB)		
}			
}			
nonCriticalExtensions SEQUENCE {}	Not present		
}			
}			
Note:	GERAN cell priority is not allocated, hence it will be considered as the less than all allowed values of 0 to 7.		

Condition	Explanation
UTRA-FDD	UTRA FDD cell environment
UTRA-TDD	UTRA TDD cell environment

Table 6.2.3.4a.3.3-2: System Information Block type 19 for Cell 5 (at step 4, Table 6.2.3.4a.3.2-3)

Derivation Path: 36.508 table 4.4.4.1-1			
Information Element	Value/remark	Comment	Condition
SysInfoType19 ::= SEQUENCE {			
utra-PriorityInfoList ::= SEQUENCE {			
utra-ServingCell ::= SEQUENCE {			
priority	3		
s-PrioritySearch1	2 (4 dB)		
s-PrioritySearch2	0 (0 dB)		
threshServingLow	2 (4 dB)		
}			
utran-FDD-FrequencyList	Not present		UTRA-FDD
utran-TDD-FrequencyList	Not present		UTRA-TDD
}			
gsm-PriorityInfoList	Not present		
eutra-FrequencyAndPriorityInfoList ::= SEQUENCE (SIZE (1..maxNumEUTRAFreqs)) OF SEQUENCE {			
earfcn [n]	Same downlink EARFCN as used for Cell 1		
measurementBandwidth [n]	Not present		
priority [n]	5		
qRxlevMinEUTRA [n]	-84 (164 dBm)		
threshXhigh [n]	15 (30 dB)		
qQualminEUTRA [n]	-20		
eutra-blackListedCellList [n]	Not present		
eutraDetection [n]	TRUE		
}			
v920NonCriticalExtensions SEQUENCE {			
sysInfoType19-v920ext SEQUENCE {			
utra-PriorityInfoList-v920ext SEQUENCE {			
threshServingLow2	8 (8dB)		
}			
eutra-FrequencyAndPriorityInfoList-v920ext (SIZE (1..maxNumEUTRAFreqs)) OF SEQUENCE {			
qQualMinEUTRA[n]	-20 (-20dB)		
threshXhigh2[n]	4 (4dB)		
threshXlow2[n]	4 (4dB)		
}			
}			
nonCriticalExtensions SEQUENCE {}	Not present		
}			
}			
Note:	GERAN cell priority is not allocated, hence it will be considered as the less than all allowed values of 0 to 7.		

Condition	Explanation
UTRA-FDD	UTRA FDD cell environment
UTRA-TDD	UTRA TDD cell environment

Table 6.2.3.4a.3.3-3: PAGING TYPE 1 for Cell 5 (step 5, Table 6.2.2.4a.3.2-3)

Derivation path: 34.108 clause 9.1.1			
Information Element	Value/Remark	Comment	Condition
PagingType1 ::= SEQUENCE {			
pagingRecordList	Not present		
bcch-ModificationInfo ::= SEQUENCE {			
mib-ValueTag	Set to (Current MIB value tag + 1)		
bcch-ModificationTime	Not present		
}			
laterNonCriticalExtensions SEQUENCE {}	Not present		
}			

Table 6.2.3.4a.3.3-4: SystemInformationBlockType3 for Cell 1 (preamble and all steps, Table 6.2.3.4a.3.2-3)

Derivation path: 36.508 table 4.4.3.3-2			
Information Element	Value/Remark	Comment	Condition
SystemInformationBlockType3 ::= SEQUENCE {			
cellReselectionServingFreqInfo SEQUENCE {			
cellReselectionPriority	5		
}			
lateNonCriticalExtension {			
s-IntraSearch-v920 SEQUENCE {}	Not present		
s-NonIntraSearch-v920 SEQUENCE {}	Not present		
q-QualMin-r9	-20 dB		
threshServingLowQ-r9	0 dB		
}			
}			

Table 6.2.3.4a.3.3-5: SystemInformationBlockType6 for Cell 1 (preamble and all steps, Table 6.2.3.4a.3.2-3)

Derivation path: 36.508 table 4.4.3.3-5			
Information Element	Value/remark	Comment	Condition
SystemInformationBlockType6 ::= SEQUENCE {			
CarrierFreqListUTRA-FDD SEQUENCE (SIZE (1..maxUTRA-FDD-Carrier)) OF SEQUENCE {			UTRA-FDD
carrierFreq[n]	Same as Cell 5		
cellReselectionPriority[n]	3		
}			
CarrierFreqListUTRA-TDD SEQUENCE (SIZE (1..maxUTRA-TDD-Carrier)) OF SEQUENCE {			UTRA-TDD
carrierFreq[n]	Same as Cell 5		
cellReselectionPriority[n]	3		
}			
}			

Condition	Explanation
UTRA-FDD	UTRA FDD cell environment
UTRA-TDD	UTRA TDD cell environment

6.2.3.5 Inter-RAT cell reselection / From E-UTRA RRC_IDLE to UTRA_Idle

6.2.3.5.1 Test Purpose (TP)

(1)

```
with { UE in E-UTRA RRC_IDLE state }
ensure that {
  when { UE detects the cell re-selection criteria are met for the neighbour cell which belongs to
the higher priority UTRAN frequency }
```

```

then { UE reselects the UTRA cell }
}

```

6.2.3.5.2 Conformance requirements

References: The conformance requirements covered in the present TC are specified in: TS 36.304, clause 5.2.4.5.

[TS 36.304, clause 5.2.4.5]

Criteria 1: the $S_{\text{nonServingCell},x}$ of a cell on evaluated frequency is greater than $\text{Thresh}_{x, \text{high}}$ during a time interval $\text{Treselection}_{\text{RAT}}$;

Cell reselection to a cell on a higher priority E-UTRAN frequency or inter-RAT frequency than serving frequency shall be performed if:

- A cell of a higher priority E-UTRAN frequency or inter-RAT frequency fulfils criteria 1; and
- more than 1 second has elapsed since the UE camped on the current serving cell.

...

For GERAN, UTRAN, and E-UTRAN, $S_{\text{nonServingCell},x}$ is the S_{rxlev} -value of an evaluated cell. ...

6.2.3.5.3 Test description

6.2.3.5.3.1 Pre-test conditions

System Simulator:

- 2 cells, one E-UTRA and one UTRA cell :
 - Cell 1 is a E-UTRA cell
 - Cell 5 is a UTRA cell
 - System information combination 4 as defined in TS 36.508 [18] clause 4.4.3.1 is used in E-UTRA cells.

UE:

None.

Preamble:

- The UE is in state Registered, Idle mode (state 2) on Cell 1 (serving cell) according to [18].

6.2.3.5.3.2 Test procedure sequence

Table 6.2.3.5.3.2-1 illustrates the downlink power levels and other changing parameters to be applied for the cells at various time instants of the test execution. Subsequent configuration marked "T1" is applied at the points indicated in the Main behaviour description in Table 6.2.3.5.3.2-2.

Table 6.2.3.5.3.2-1: Time instances of cell power level and parameter changes

	Parameter	Unit	Cell 1	Cell 5	Remark
T1	Cell-specific RS EPRE	dBm/15kHz	-85	-	
	CPICH_Ec	dBm/3.84 MHz	-	-65	$S_{\text{nonServingCell, Cell5}} > \text{Thresh}_{\text{Cell 5,high}}$
	P-CCPCH	dBm/1.28 MHz		-67	

Table 6.2.3.5.3.2-2: Main behaviour

St	Procedure	Message Sequence		TP	Verdict
		U - S	Message		
0	Wait for 6 s for UE to receive system information.	-	-	-	-
1	The SS changes Cell 1 and Cell 5 levels according to the row "T1" in table 6.2.3.5.3.2-1.	-	-	-	-
2	Check: Does the test result of generic test procedure in TS 36.508 subclause 6.4.2.8 indicate that the UE is camped on UTRAN Cell 5? NOTE: The UE performs an RAU procedure and the RRC connection is released.	-	-	1	-

6.2.3.5.3.3 Specific message contents

Table 6.2.3.5.3.3-1: Void

Table 6.2.3.5.3.3-2: Void

Table 6.2.3.5.3.3-3: SystemInformationBlockType6 for Cell 1 (preamble and all steps, Table 6.2.3.5.3.2-2)

Derivation Path: 36.508 table 4.4.3.3-5			
Information Element	Value/remark	Comment	Condition
SystemInformationBlockType6 ::= SEQUENCE { carrierFreqListUTRA-FDD SEQUENCE (SIZE (1..maxUTRA-FDD-Carrier)) OF SEQUENCE { carrierFreq[n]	Same downlink UARFCN as used for cell 5		UTRA-FDD
cellReselectionPriority[n]	5	Higher priority than E-UTRA	
}			
carrierFreqListUTRA-TDD SEQUENCE (SIZE (1..maxUTRA-TDD-Carrier)) OF SEQUENCE { carrierFreq[n]	Same downlink UARFCN as used for cell 5		UTRA-TDD
cellReselectionPriority[n]	5	Higher priority than E-UTRA	
}			
}			

Condition	Explanation
UTRA-FDD	UTRA FDD cell environment
UTRA-TDD	UTRA TDD cell environment

Table 6.2.3.5.3.3-4: System Information Block type 19 for Cell 5 (preamble and all steps, Table 6.2.3.5.3.2-2)

Derivation Path: 36.508 table 4.4.4.1-1			
Information Element	Value/remark	Comment	Condition
SysInfoType19 ::= SEQUENCE { utra-PriorityInfoList ::= SEQUENCE { utra-ServingCell ::= SEQUENCE { priority	5		
}			
}			

6.2.3.5a Inter-RAT cell reselection / From E-UTRA RRC_IDLE to UTRA_Idle ($S_{\text{qual}} > \text{Thresh}_{X, \text{HighQ}}$, $S_{\text{qual}} < \text{Thresh}_{\text{Serving}, \text{LowQ}}$, $S_{\text{qual}} > \text{Thresh}_{X, \text{LowQ}}$ and $S_{\text{nonIntraSearchQ}}$)

6.2.3.5a.1 Test Purpose (TP)

(1)

```
with { UE in E-UTRA_Idle state }
ensure that {
  when { UE detects the cell re-selection criteria are met for the cell which belongs to the lower
priority inter-RAT UTRA cell }
  then { UE reselects the cell which belongs to the lower priority inter-RAT UTRA cell }
}
```

(2)

```
with { UE in E-UTRA_Idle state }
ensure that {
  when { UE detects the cell re-selection criteria are met for the cell which belongs to the higher
priority inter-RAT UTRA cell }
  then { UE reselects the cell which belongs to the higher priority inter-RAT UTRA cell }
}
```

(3)

```
with { UE in E-UTRA RRC_IDLE state, and the UE is not in high mobility state }
ensure that {
  when { threshX-HighQ-r9 is non-zero in system information }
  then { UE perform measurement and reselects the cell which belong to the high priority UTRA
cell upon  $S_{\text{qual}} > \text{threshX-HighQ-r9}$  }
}
```

6.2.3.5a.2 Conformance requirements

References: The conformance requirements covered in the present TC are specified in: TS 36.304, clause 5.2.4.2 and 5.2.4.5.

[TS 36.304, clause 5.2.4.2]

When evaluating S_{rxlev} and S_{qual} of non-serving cells for reselection purposes, the UE shall use parameters provided by the serving cell.

Following rules are used by the UE to limit needed measurements:

- If the serving cell fulfils $S_{\text{rxlev}} > S_{\text{IntraSearchP}}$ and $S_{\text{qual}} > S_{\text{IntraSearchQ}}$, the UE may choose not to perform intra-frequency measurements.
- Otherwise, the UE shall perform intra-frequency measurements.
- The UE shall apply the following rules for E-UTRAN inter-frequencies and inter-RAT frequencies which are indicated in system information and for which the UE has priority provided as defined in 5.2.4.1:
 - For an E-UTRAN inter-frequency or inter-RAT frequency with a reselection priority higher than the reselection priority of the current E-UTRA frequency the UE shall perform measurements of higher priority E-UTRAN inter-frequency or inter-RAT frequencies according to [10].
 - For an E-UTRAN inter-frequency with an equal or lower reselection priority than the reselection priority of the current E-UTRA frequency and for inter-RAT frequency with lower reselection priority than the reselection priority of the current E-UTRAN frequency:
 - If the serving cell fulfils $S_{\text{rxlev}} > S_{\text{nonIntraSearchP}}$ and $S_{\text{qual}} > S_{\text{nonIntraSearchQ}}$, the UE may choose not to perform measurements of E-UTRAN inter-frequencies or inter-RAT frequency cells of equal or lower priority.
 - Otherwise, the UE shall perform measurements of E-UTRAN inter-frequencies or inter-RAT frequency cells of equal or lower priority according to [10].

[TS 36.304, clause 5.2.4.5]

If *threshServingLowQ* is provided in *SystemInformationBlockType3*, cell reselection to a cell on a higher priority E-UTRAN frequency or inter-RAT frequency than the serving frequency shall be performed if:

- A cell of a higher priority EUTRAN or UTRAN FDD RAT/ frequency fulfils $S_{qual} > Thresh_{X, HighQ}$ during a time interval $T_{reselection_{RAT}}$; or
- ...
- More than 1 second has elapsed since the UE camped on the current serving cell.

Otherwise, cell reselection to a cell on a higher priority E-UTRAN frequency or inter-RAT frequency than the serving frequency shall be performed if:

- A cell of a higher priority RAT/ frequency fulfils $S_{rxlev} > Thresh_{X, HighP}$ during a time interval $T_{reselection_{RAT}}$; and
- More than 1 second has elapsed since the UE camped on the current serving cell.

...

If *threshServingLowQ* is provided in *SystemInformationBlockType3*, cell reselection to a cell on a lower priority E-UTRAN frequency or inter-RAT frequency than the serving frequency shall be performed if:

- The serving cell fulfils $S_{qual} < Thresh_{Serving, LowQ}$ and a cell of a lower priority EUTRAN or UTRAN FDD RAT/ frequency fulfils $S_{qual} > Thresh_{X, LowQ}$ during a time interval $T_{reselection_{RAT}}$; or
- ...
- More than 1 second has elapsed since the UE camped on the current serving cell.

Otherwise, cell reselection to a cell on a lower priority E-UTRAN frequency or inter-RAT frequency than the serving frequency shall be performed if:

- The serving cell fulfils $S_{rxlev} < Thresh_{Serving, LowP}$ and a cell of a lower priority RAT/ frequency fulfils $S_{rxlev} > Thresh_{X, LowP}$ during a time interval $T_{reselection_{RAT}}$; and
- More than 1 second has elapsed since the UE camped on the current serving cell.

Cell reselection to a higher priority RAT/ frequency shall take precedence over a lower priority RAT/ frequency, if multiple cells of different priorities fulfil the cell reselection criteria.

...

Cell reselection to another RAT, for which *S_{qual}* based cell reselection parameters are broadcast in system information, shall be performed based on the *S_{qual}* criteria if the UE supports *S_{qual}* (RSRQ) based cell reselection to E-UTRAN from all the other RATs provided by system information which UE supports. Otherwise, cell reselection to another RAT shall be performed based on *S_{rxlev}* criteria.

6.2.3.5a.3 Test description

6.2.3.5a.3.1 Pre-test conditions

System Simulator:

- Cell 1 and Cell 5.
- System information combination 4 as defined in TS 36.508 [18] clause 4.4.3.1 is used in E-UTRA cells.

UE:

None.

Preamble:

- The UE is in state Registered, Idle mode (state 2) on Cell 1 (serving cell) according to [18].

6.2.3.5a.3.2 Test procedure sequence

Tables 6.2.3.5a.3.2-1 & Table 6.2.3.5a.3.2-2 illustrate the downlink power levels and other changing parameters to be applied for the cells at various time instants of the test execution. Subsequent configurations marked "T1", "T2" and "T3" are applied at the points indicated in the Main behaviour description in Table 6.2.3.5a.3.2-3.

Table 6.2.3.5a.3.2-1: Time instances of cell power level and parameter changes for E-UTRA cell

	Parameter	Unit	Cell 1	Remark
T1	Cell-specific RS EPRE	dBm/15kHz	-85	Squal _{ServingCell, Cell1} < Thresh _{Serving, LowQ}
	RSRQ	dB	-3	
	Qqualmin	dB	-20	
	Noc	dBm/15kHz	off	
T2	Cell-specific RS EPRE	dBm/15kHz	-80	
	RSRQ	dB	-3	
T3	Cell-specific RS EPRE	dBm/15kHz	-85	
	RSRQ	dB	-3	

Table 6.2.3.5a.3.2-2: Time instances of cell power level and parameter changes for UTRA cell

	Parameter	Unit	Cell 5	Remark
T1	CPICH_Ec	dBm/3.84 MHz	-60	Note 1
	P-CCPCH	dBm/1.28 MHz	-62	
	QqualminFDD	dB	-20	
	Ioc	dBm/3.84MHz	Off	
	CPICH_Ec/No	dB	-2.89	
T2	CPICH_Ec	dBm/3.84 MHz	-90	Note 2
	P-CCPCH	dBm/1.28 MHz	-92	
	CPICH_Ec/No	dB	off	
T3	CPICH_Ec	dBm/3.84 MHz	-70	Note 3
	P-CCPCH	dBm/1.28 MHz	-72	
	CPICH_Ec/No	dB	-2.89	
Note 1:	Since no interference is occurred, Squal _{nonServingCell, Cell 5} > Thresh _{Cell5, LowQ} is satisfied,			
Note 2:	Since no interference is occurred, Squal _{ServingCell, Cell 5} < 0 is satisfied.			
Note 3:	Since no interference is occurred, Squal _{nonServingCell, Cell5} > Thresh _{Cell5,highQ} is satisfied,			

Table 6.2.3.5a.3.2-3: Main behaviour

St	Procedure	Message Sequence		TP	Verdict
		U - S	Message		
1	Wait for 6 s for UE to receive system information.	-	-	-	-
2	The SS changes Cell 1 and Cell 5 levels according to the row "T1" in table 6.2.3.5a.3.2-1 and table 6.2.3.5a.3.2-2.	-	-	-	-
3	Check: Does the test result of generic test procedure in TS 36.508 Table 6.4.2.8 indicate that the UE is camped on UTRAN Cell 5? NOTE: The UE performs a RAU procedure and the RRC Connection is released.	-	-	1	-
4	The SS changes Cell 1 and Cell 5 levels according to the row "T2" in table 6.2.3.5a.3.2-1 and table 6.2.3.5a.3.2-2.	-	-	-	-
5	The UE selects and perform the test result of generic test procedure in TS 36.508 Table 6.4.2.7A-1 indicates that the UE is camped on E-UTRAN Cell 1.	-	-	-	-
6	The SS changes the UTRA cell priority broadcast in system information.	-	-	-	-
7	Notify UE change of System Information.	<--	<i>Paging</i>	-	-
8	Wait for 6 s for UE to receive system information.	-	-	-	-
9	The SS changes Cell 1 and Cell 5 levels according to the row "T3" in table 6.2.3.5a.3.2-1 and table 6.2.3.5a.3.2-2.	-	-	-	-
10-17	Check: Does the test result of steps 1 to 8 generic test procedure in TS 36.508 Table 6.4.2.8 indicate that the UE is camped on UTRAN Cell 5? NOTE: The UE performs a RAU procedure	-	-	2, 3	-

6.2.3.5a.3.3 Specific message contents

Table 6.2.3.5a.3.3-1: SystemInformationBlockType3 for Cell 1 (preamble, Table 6.2.3.5a.3.2-3)

Derivation path: 36.508 table 4.4.3.3-2			
Information Element	Value/Remark	Comment	Condition
SystemInformationBlockType3 ::= SEQUENCE {			
lateNonCriticalExtension {			
s-IntraSearch-v920 SEQUENCE {}	Not present		
s-NonIntraSearch-v920 SEQUENCE {}	Not present		
q-QualMin-r9	-20 dB		
threshServingLowQ-r9	26 dB		
}			
}			

Table 6.2.3.5a.3.3-2: SystemInformationBlockType6 for Cell 1 (preamble, Table 6.2.3.5a.3.2-3)

Derivation path: 36.508 table 4.4.3.3-5			
Information Element	Value/remark	Comment	Condition
SystemInformationBlockType6 ::= SEQUENCE {			
CarrierFreqListUTRA-FDD SEQUENCE (SIZE (1..maxUTRA-FDD-Carrier)) OF SEQUENCE {			UTRA-FDD
carrierFreq[n]	Same downlink UARFCN as used for Cell 5		
cellReselectionPriority[n]	3		
q-QualMin[n]	-20 (-20 dB)		
threshX-Q-r9[n] SEQUENCE {			
threshX-HighQ-r9	2 (2 dB)		
threshX-LowQ-r9	1 (1 dB)		
}			
}			
CarrierFreqListUTRA-TDD SEQUENCE (SIZE (1..maxUTRA-TDD-Carrier)) OF SEQUENCE {			UTRA-TDD
carrierFreq[n]	Same downlink UARFCN as used for Cell 5		
cellReselectionPriority[n]	3		
}			
}			

Condition	Explanation
UTRA-FDD	UTRA FDD cell environment
UTRA-TDD	UTRA TDD cell environment

Table 6.2.3.5a.3.3-3: System Information Block type 19 for Cell 5 (preamble, Table 6.2.3.5a.3.2-3)

Derivation Path: 36.508 table 4.4.4.1-1			
Information Element	Value/remark	Comment	Condition
SysInfoType19 ::= SEQUENCE {			
utra-PriorityInfoList ::= SEQUENCE {			
utra-ServingCell ::= SEQUENCE {			
priority	3		
s-PrioritySearch1	2 (4 dB)		
s-PrioritySearch2	0 (0 dB)		
threshServingLow	2 (4 dB)		
}			
utran-FDD-FrequencyList	Not present		UTRA-FDD
utran-TDD-FrequencyList	Not present		UTRA-TDD
}			
gsm-PriorityInfoList	Not present		
eutra-FrequencyAndPriorityInfoList ::= SEQUENCE (SIZE (1..maxNumEUTRAFreqs)) OF SEQUENCE {			
earfcn [n]	Same downlink EARFCN as used for Cell 1		
measurementBandwidth [n]	Not present		
priority [n]	4		
qRxlevMinEUTRA [n]	-53 (-106 dBm)		
qQualminEUTRA [n]	-20		
eutra-blackListedCellList [n]	Not present		
eutraDetection [n]	[TRUE]		
}			
v920NonCriticalExtensions SEQUENCE {			
sysInfoType19-v920ext SEQUENCE {			
utra-PriorityInfoList-v920ext SEQUENCE {			
threshServingLow2	8 (8dB)		
}			
eutra-FrequencyAndPriorityInfoList-v920ext (SIZE (1..maxNumEUTRAFreqs)) OF SEQUENCE {			
qQualMinEUTRA[n]	-20 (-20dB)		
threshXhigh2[n]	8 (8dB)		
threshXlow2[n]	4 (4dB)		
}			
}			
nonCriticalExtensions SEQUENCE {}	Not present		
}			
}			
Note:	GERAN cell priority is not allocated, hence it will be considered as the less than all allowed values of 0 to 7.		

Condition	Explanation
UTRA-FDD	UTRA FDD cell environment
UTRA-TDD	UTRA TDD cell environment

Table 6.2.3.5a.3.3-4: Void

Table 6.2.3.5a.3.3-5: SystemInformationBlockType6 for Cell 1 (step 6, Table 6.2.3.5a.3.2-3)

Derivation path: 36.508 table 4.4.3.3-5			
Information Element	Value/remark	Comment	Condition
SystemInformationBlockType6 ::= SEQUENCE {			
CarrierFreqListUTRA-FDD SEQUENCE (SIZE (1..maxUTRA-FDD-Carrier)) OF SEQUENCE {			UTRA-FDD
carrierFreq[n]	Same downlink UARFCN as used for Cell 5		
cellReselectionPriority[n]	5		
threshX-High[n]	10 (20 dB)		
q-QualMin[n]	-20 (-20 dB)		
threshX-Q-r9[n] SEQUENCE {			
threshX-HighQ-r9	2 (2 dB)		
threshX-LowQ-r9	1 (1 dB)		
}			
}			
CarrierFreqListUTRA-TDD SEQUENCE (SIZE (1..maxUTRA-TDD-Carrier)) OF SEQUENCE {			UTRA-TDD
carrierFreq[n]	Same downlink UARFCN as used for Cell 5		
cellReselectionPriority[n]	5		
}			
}			

Condition	Explanation
UTRA-FDD	UTRA FDD cell environment
UTRA-TDD	UTRA TDD cell environment

Table 6.2.3.5a.3.3-6: System Information Block type 19 for Cell 5 (step 6, Table 6.2.3.5a.3.2-3)

Derivation Path: 36.508 table 4.4.4.1-1			
Information Element	Value/remark	Comment	Condition
SysInfoType19 ::= SEQUENCE {			
utra-PriorityInfoList ::= SEQUENCE {			
utra-ServingCell ::= SEQUENCE {			
priority	5		
s-PrioritySearch1	2 (4 dB)		
s-PrioritySearch2	0 (0 dB)		
threshServingLow	2 (4 dB)		
}			
utran-FDD-FrequencyList	Not present		UTRA-FDD
utran-TDD-FrequencyList	Not present		UTRA-TDD
}			
gsm-PriorityInfoList	Not present		
eutra-FrequencyAndPriorityInfoList ::= SEQUENCE (SIZE (1..maxNumEUTRAFreqs)) OF SEQUENCE {			
earfcn [n]	Same downlink EARFCN as used for Cell 1		
measurementBandwidth [n]	Not present		
priority [n]	4		
qRxlevMinEUTRA [n]	-53 (106 dBm)		
threshXhigh [n]	15 (30 dB)		
qQualminEUTRA [n]	-20		
eutra-blackListedCellList [n]	Not present		
eutraDetection [n]	[TRUE]		
}			
v920NonCriticalExtensions SEQUENCE {			
sysInfoType19-v920ext SEQUENCE {			
utra-PriorityInfoList-v920ext SEQUENCE {			
threshServingLow2	8 (8dB)		
}			
eutra-FrequencyAndPriorityInfoList-v920ext (SIZE (1..maxNumEUTRAFreqs)) OF SEQUENCE {			
qQualMinEUTRA[n]	-20 (-20dB)		
threshXhigh2[n]	8 (8dB)		
threshXlow2[n]	4 (4dB)		
}			
}			
nonCriticalExtensions SEQUENCE {}	Not present		
}			
}			
Note:	GERAN cell priority is not allocated, hence it will be considered as the less than all allowed values of 0 to 7.		

Condition	Explanation
UTRA-FDD	UTRA FDD cell environment
UTRA-TDD	UTRA TDD cell environment

Table 6.2.3.5a.3.3-7: Paging (step 7, Table 6.2.3.5a.3.2-3)

Derivation path: 36.508 Table 4.6.1-7			
Information Element	Value/Remark	Comment	Condition
Paging ::= SEQUENCE {			
pagingRecordList	Not present		
systemInfoModification	True		
etws-PrimaryNotificationIndication	Not present		
nonCriticalExtension SEQUENCE {}	Not present		
}			

6.2.3.6 Inter-RAT cell reselection / From E-UTRA RRC_IDLE to UTRA_Idle according to RAT priority provided by dedicated signalling

6.2.3.6.1 Test Purpose (TP)

(1)

```
with { UE in E-UTRA RRC_IDLE state having received an RRCConnectionRelease message including a
cellReselectionPriority }
ensure that {
  when { UE detects the cell re-selection criteria are met for the cell which belongs to the higher
priority RAT }
  then { UE reselects the cell which belongs to the higher priority RAT }
}
```

(2)

```
with { UE in E-UTRA RRC_IDLE state having received an RRCConnectionRelease message including a
cellReselectionPriority }
ensure that {
  when { UE detects the cell re-selection criteria are met for the cell which belongs to the lower
priority RAT }
  then { UE reselects the cell which belongs to the lower priority RAT }
}
```

(3)

```
with { UE in E-UTRA RRC_IDLE state having received an RRCConnectionRelease message including a
cellReselectionPriority }
ensure that {
  when { T320 expires }
  then { UE reselects a cell by applying the cellReselectionPriority broadcast in the system
information }
}
```

(4)

```
with { UE in E-UTRA RRC_IDLE state, and reselection priorities have been provided in dedicated
signalling }
ensure that {
  when { T320 has not expired }
  then { The UE shall ignore all the priorities provided in system information, and not perform
cell reselection evaluation for E-UTRAN frequencies and inter-RAT frequencies for which the UE
doesn't have a priority provided }
}
```

6.2.3.6.2 Conformance requirements

References: The conformance requirements covered in the present TC are specified in: TS 36.304, clause 5.2.4.1 and 5.2.4.5 and TS 36.331, clause 5.3.8.3 and 5.3.8.4.

[TS 36.304, clause 5.2.4.1]

Absolute priorities of different E-UTRAN frequencies or inter-RAT frequencies may be provided to the UE in the system information, in the RRCConnectionRelease message, or by inheriting from another RAT at inter-RAT cell (re)selection. In the case of system information, an E-UTRAN frequency or inter-RAT frequency may be listed without providing a priority (i.e. the field *cellReselectionPriority* is absent for that frequency). If priorities are provided in dedicated signalling, the UE shall ignore all the priorities provided in system information. If UE is in camped on any cell state, UE shall only apply the priorities provided by system information from current cell, and the UE preserves priorities provided by dedicated signalling unless specified otherwise. When the UE in camped normally state, has only dedicated priorities other than for the current frequency, the UE shall consider the current frequency to be the lowest priority frequency (i.e. lower than the eight network configured values). While the UE is camped on a suitable CSG cell, the UE shall always consider the current frequency to be the highest priority frequency (i.e. higher than the eight network configured values), irrespective of any other priority value allocated to this frequency. The UE shall delete priorities provided by dedicated signalling when:

- the UE enters RRC_CONNECTED state; or
- the optional validity time of dedicated priorities (T320) expires; or

- a PLMN selection is performed on request by NAS [5].

NOTE: Equal priorities between RATs are not supported.

The UE shall only perform cell reselection evaluation for E-UTRAN frequencies and inter-RAT frequencies that are given in system information and for which the UE has a priority provided.

The UE shall not consider any black listed cells as candidate for cell reselection.

The UE shall inherit the priorities provided by dedicated signalling and the remaining validity time (i.e., T320 in E-UTRA, T322 in UTRA and T3230 in GERAN), if configured, at inter-RAT cell (re)selection.

NOTE: The network may assign dedicated cell reselection priorities for frequencies not configured by system information.

[TS 36.304, clause 5.2.4.5]

Criteria 1: the $S_{\text{nonServingCell},x}$ of a cell on evaluated frequency is greater than $\text{Thresh}_{x, \text{high}}$ during a time interval $\text{Treselection}_{\text{RAT}}$;

Cell reselection to a cell on a higher priority E-UTRAN frequency or inter-RAT frequency than serving frequency shall be performed if:

- A cell of a higher priority E-UTRAN frequency or inter-RAT frequency fulfils criteria 1; and
- more than 1 second has elapsed since the UE camped on the current serving cell.

Cell reselection to a cell on an equal priority E-UTRAN frequency shall be based on ranking for Intra-frequency cell reselection as defined in sub-clause 5.2.4.6.

Cell reselection to a cell on a lower priority E-UTRAN frequency or inter-RAT frequency than serving frequency shall be performed if:

- No cell on a higher priority E-UTRAN frequency or inter-RAT frequency than serving frequency fulfils the criteria 1; and
- No cell on serving frequency or on an equal priority E-UTRAN frequency fulfils the criteria in 5.2.4.6; and
- $S_{\text{ServingCell}} < \text{Thresh}_{\text{serv}, \text{low}}$ and the $S_{\text{nonServingCell},x}$ of a cell of a lower priority E-UTRAN frequency or inter-RAT frequency is greater than $\text{Thresh}_{x, \text{low}}$ during a time interval $\text{Treselection}_{\text{RAT}}$; and
- more than 1 second has elapsed since the UE camped on the current serving cell.

...

For GERAN, UTRAN, and E-UTRAN, $S_{\text{nonServingCell},x}$ is the S_{rxlev} -value of an evaluated cell. For UTRAN FDD, S_{qual} is higher than 0, as defined in [8]. For cdma2000 RATs, $S_{\text{nonServingCell},x}$ is equal to $-\text{FLOOR}(-2 \times 10 \times \log_{10} E_c/I_o)$ in units of 0.5 dB, as defined in [18], with E_c/I_o referring to the value measured from the evaluated cell.

For cdma2000 RATs, $\text{Thresh}_{x, \text{high}}$ and $\text{Thresh}_{x, \text{low}}$ are equal to -1 times the values signalled for the corresponding parameters in the system information.

In all the above criteria the value of $\text{Treselection}_{\text{RAT}}$ is scaled when the UE is in the medium or high mobility state as defined in subclause 5.2.4.3.1. If more than one cell meets the above criteria, the UE shall reselect a cell ranked as the best cell among the cells meeting the criteria on the highest priority frequencies or the highest priority RAT if the highest priority RAT is E-UTRA according to criteria defined in 5.2.4.6.

[TS 36.331, clause 5.3.8.3]

The UE shall:

- 1> delay the following actions defined in this sub-clause 60 ms from the moment the *RRCCConnectionRelease* message was received or optionally when lower layers indicate that the receipt of the *RRCCConnectionRelease* message has been successfully acknowledged, whichever is earlier;
- 1> if the *RRCCConnectionRelease* message includes the *idleModeMobilityControlInfo*:

2> store the cell reselection priority information provided by the *idleModeMobilityControlInfo*;

2> if the *t320* is included:

3> start timer T320, with the timer value set according to the value of *t320*;

1> else:

2> apply the cell reselection priority information broadcast in the system information;

1> if the *releaseCause* received in the *RRCConnectionRelease* message indicates '*loadBalancingTAURequired*':

2> perform the actions upon leaving RRC_CONNECTED as specified in 5.3.12, with release cause 'load balancing TAU required';

1> else:

2> perform the actions upon leaving RRC_CONNECTED as specified in 5.3.12, with release cause 'other';

[TS 36.331, clause 5.3.8.4]

The UE shall:

1> if T320 expires:

2> if stored, discard the cell reselection priority information provided by the *idleModeMobilityControlInfo* or inherited from another RAT;

2> apply the cell reselection priority information broadcast in the system information;

6.2.3.6.3 Test description

6.2.3.6.3.1 Pre-test conditions

System Simulator:

- Cell 1(E-UTRA) and Cell 5(UTRA).
- System information combination 4 as defined in TS 36.508 [18] clause 4.4.3.1 is used in E-UTRA cells.

UE:

None.

Preamble:

- The UE is in state Generic RB Established (state 3) on Cell 1 according to [18].

6.2.3.6.3.2 Test procedure sequence

Table 6.2.3.6.3.2-1 illustrates the downlink power levels and other changing parameters to be applied for the cells at various time instants of the test execution. Row marked "T0" denotes the initial conditions after preamble, while columns marked "T1", "T2", "T3", "T4" and "T5" are to be applied subsequently. The exact instants on which these values are applied are described in the texts in this clause.

Table 6.2.3.6.3.2-1: Time instances of cell power level and parameter changes

	Parameter	Unit	Cell 1	Cell 5	Remark
T0	Cell-specific RS EPRE	dBm/15k Hz	-70	-	The power level values are assigned to satisfy $Srxlev_{Cell 1} > 0$ and $Srxlev_{Cell 5} < 0$.
	CPICH Ec	dBm/3.8 4 MHz	-	-90	
	PCCPCH RSCP	dBm/1.2 8MHz		-92	
T1	Cell-specific RS EPRE	dBm/15k Hz	-90	-	The power level values are assigned to satisfy $Thresh_{x,high} < Srxlev_{cell 5}$.
	CPICH Ec	dBm/3.8 4 MHz	-	-65	
	PCCPCH RSCP	dBm/1.2 8MHz		-65	
T2	Cell-specific RS EPRE	dBm/15k Hz	-70	-	The power level values are such that camping on Cell 1 is guaranteed.
	CPICH Ec	dBm/3.8 4 MHz	-	-90	
	PCCPCH RSCP	dBm/1.2 8MHz		-92	
T3	Cell-specific RS EPRE	dBm/15k Hz	-115	-	The power level values are assigned to satisfy $Srxlev_{cell 1} < Thresh_{serving, low}$ and $Thresh_{x,low} < Srxlev_{cell 5}$.
	CPICH Ec	dBm/3.8 4 MHz	-	-65	
	PCCPCH RSCP	dBm/1.2 8MHz		-65	
T4	Cell-specific RS EPRE	dBm/15k Hz	-70	-	The power level values are such that camping on Cell 1 is guaranteed.
	CPICH Ec	dBm/3.8 4 MHz	-	-90	
	PCCPCH RSCP	dBm/1.2 8MHz		-92	
T5	Cell-specific RS EPRE	dBm/15k Hz	-70	-	The power level values are assigned to satisfy $Srxlev_{cell 1} > Thresh_{serving, low}$ and $Thresh_{x,high} < Srxlev_{cell 5}$.
	CPICH Ec	dBm/3.8 4 MHz	-	-65	
	PCCPCH RSCP	dBm/1.2 8MHz		-65	

Table 6.2.3.6.3.2-2: Main behaviour

St	Procedure	Message Sequence		TP	Verdict
		U - S	Message		
1	The SS transmits an <i>RRConnectionRelease</i> message with an <i>idleModeMobilityControllInfo</i> including a <i>cellReselectionPriority</i> on Cell 1.	<--	<i>RRConnectionRelease</i>	-	-
2	The SS changes Cell 5 level according to row "T1" in table 6.2.3.6.3.2-1.	-	-	-	-
3	Check: Does the UE transmit an RRC CONNECTION REQUEST message within the next 30s on Cell 5?	-->	RRC CONNECTION REQUEST	4	F
4	The SS transmits a <i>Paging</i> message including matched identity on Cell 1.	<--	<i>Paging</i>	-	-
5	UE transmit an <i>RRConnectionRequest</i> message on Cell 1.	-->	<i>RRConnectionRequest</i>	-	-
6	The SS transmits an <i>RRConnectionSetup</i> message on Cell 1.	<--	<i>RRConnectionSetup</i>	-	-
7	The UE transmits an <i>RRConnectionSetupComplete</i> on Cell 1.	-->	<i>RRConnectionSetupComplete</i>	-	-
8	The SS transmits an <i>RRConnectionRelease</i> message with an <i>idleModeMobilityControllInfo</i> including a <i>cellReselectionPriority</i> on Cell 1.	<--	<i>RRConnectionRelease</i>	-	-
9	Check: Does the test result of generic test procedure in TS 36.508 subclause 6.4.2.8 indicate that the UE is camped on UTRAN Cell 5? NOTE: The UE performs an RAU procedure and the RRC connection is released.	-	-	1	-
10	The SS changes Cell 1 and Cell 5 parameters according to the row "T2" in table 6.2.3.6.3.2-1.	-	-	-	-
11	Generic test procedure in TS 36.508 subclause 6.4.2.7 is performed on Cell 1. NOTE: The UE performs a TAU procedure and the RRC connection is released.	-	-	-	-
12	The SS changes Cell 1 and Cell 5 parameters according to the row "T3" in table 6.2.3.6.3.2-1.	-	-	-	-
13	Check: Does the test result of generic test procedure in TS 36.508 subclause 6.4.2.8 indicate that the UE is camped on UTRAN Cell 5? NOTE: The UE performs an RAU procedure and the RRC connection is released.	-	-	2	-
14	The SS changes Cell 1 and Cell 5 parameters according to the row "T4" in table 6.2.3.6.3.2-1.	-	-	-	-
15	Generic test procedure in TS 36.508 subclause 6.4.2.7 is performed on Cell 1. NOTE: The UE performs a TAU procedure and the RRC connection is released.	-	-	-	-
16	The SS changes Cell 1 and Cell 5 parameters according to the row "T5" in table 6.2.3.6.3.2-1.	-	-	-	-
17	Wait for 5 minutes from step 15 to ensure that T320 expires.	-	-	-	-
18	Check: Does the test result of generic test procedure in TS 36.508 subclause 6.4.2.8 indicate that the UE is camped on UTRAN Cell 5?	-	-	3	-

6.2.3.6.3.3 Specific message contents

Table 6.2.3.6.3.3-1: Void

Table 6.2.3.6.3.3-2: SystemInformationBlockType3 for Cell 1 (preamble and all steps, Table 6.2.3.6.3.2-2)

Derivation Path: 36.508 table 4.4.3.3-2			
Information Element	Value/remark	Comment	Condition
SystemInformationBlockType3 ::= SEQUENCE {			
cellReselectionServingFreqInfo SEQUENCE {			
threshServingLow	1		
}			
}			

Table 6.2.3.6.3.3-3: SystemInformationBlockType6 for Cell 1 (preamble and all steps, Table 6.2.3.6.3.2-2)

Derivation path: 36.508 table 4.4.3.3-5			
Information Element	Value/Remark	Comment	Condition
SystemInformationBlockType6 ::= SEQUENCE {			
carrierFreqListUTRA-FDD SEQUENCE (SIZE (1..maxUTRA-FDD-Carrier)) OF SEQUENCE {			UTRA-FDD
carrierFreq[n]	Same downlink UARFCN as used for Cell 5		
cellReselectionPriority[n]	5		
p-MaxUTRA[n]	0		
}			
carrierFreqListUTRA-TDD SEQUENCE (SIZE (1..maxUTRA-TDD-Carrier)) OF SEQUENCE {			UTRA-TDD
carrierFreq[n]	Same downlink UARFCN as used for Cell 5		
cellReselectionPriority[n]	5		
p-MaxUTRA[n]	0		
}			
}			

Condition	Explanation
UTRA-FDD	UTRA FDD cell environment
UTRA-TDD	UTRA TDD cell environment

Table 6.2.3.6.3.3-4: *RRConnectionRelease* (Step 1, Table 6.2.3.6.3.2-2)

Derivation path: 36.508 table 4.6.1-15			
Information Element	Value/Remark	Comment	Condition
RRConnectionRelease ::= SEQUENCE {			
criticalExtensions CHOICE {			
c1 CHOICE {			
rrcConnectionRelease-r8 SEQUENCE {			
idleModeMobilityControlInfo ::= SEQUENCE {			
freqPriorityListEUTRA SEQUENCE (SIZE (1..	1 entry		
maxFreq)) OF SEQUENCE {			
carrierFreq[1]	Same downlink EARFCN as used for Cell1		
cellReselectionPriority[1]	4		
}			
freqPriorityListGERAN	Not present		
freqPriorityListUTRA-FDD	Not present		UTRA-TDD
freqPriorityListUTRA-TDD	Not present		UTRA-FDD
bandClassPriorityListHRPD	Not present		
bandClassPriorityList1XRTT	Not present		
t320	Not present		
}			
}			
}			
}			

Condition	Explanation
UTRA-FDD	UTRA FDD cell environment
UTRA-TDD	UTRA TDD cell environment

Table 6.2.3.6.3.3-5: *RRConnectionRelease* (step 8, Table 6.2.3.6.3.2-2)

Derivation Path: 36.508, Table 4.6.1-15			
Information Element	Value/remark	Comment	Condition
RRConnectionRelease ::= SEQUENCE {			
criticalExtensions CHOICE {			
c1 CHOICE {			
rrcConnectionRelease-r8 SEQUENCE {			
idleModeMobilityControllInfo SEQUENCE {			
freqPriorityListEUTRA SEQUENCE (SIZE (1..maxFreq)) OF SEQUENCE {	1 entry		
carrierFreq[1]	Same downlink EARFCN as used for Cell 1		
cellReselectionPriority[1]	4		
}			
freqPriorityListGERAN	Not present		
freqPriorityListUTRA-FDD SEQUENCE (SIZE (1..maxUTRA-FDD-Carrier)) OF SEQUENCE {	1 entry		UTRA-FDD
carrierFreq[1]	Same downlink ARFCN as used for Cell 5		
cellReselectionPriority[1]	5		
}			
freqPriorityListUTRA-TDD SEQUENCE (SIZE (1..maxUTRA-TDD-Carrier)) OF SEQUENCE {	1 entry		UTRA-TDD
carrierFreq[1]	Same downlink ARFCN as used for Cell 5		
cellReselectionPriority[1]	5		
}			
bandClassPriorityListHRPD	Not present		
bandClassPriorityList1XRTT	Not present		
t320	Not present		
}			
}			
}			
}			
}			

Condition	Explanation
UTRA-FDD	UTRA FDD cell environment
UTRA-TDD	UTRA TDD cell environment

Table 6.2.3.6.3.3-6: *RRCConnectionRelease* (step 11, Table 6.2.3.6.3.2-2)

Derivation Path: 36.508, Table 4.6.1-15			
Information Element	Value/remark	Comment	Condition
RRCConnectionRelease ::= SEQUENCE {			
criticalExtensions CHOICE {			
c1 CHOICE {			
rrcConnectionRelease-r8 SEQUENCE {			
idleModeMobilityControllInfo SEQUENCE {			
freqPriorityListEUTRA SEQUENCE (SIZE (1..maxFreq)) OF SEQUENCE {	1 entry		
carrierFreq[1]	Same downlink EARFCN as used for Cell 1		
cellReselectionPriority[1]	4		
}			
freqPriorityListGERAN	Not present		
freqPriorityListUTRA-FDD SEQUENCE (SIZE (1..maxUTRA-FDD-Carrier)) OF SEQUENCE {	1 entry		UTRA-FDD
carrierFreq[1]	Same downlink ARFCN as used for Cell 5		
cellReselectionPriority[1]	3		
}			
freqPriorityListUTRA-TDD SEQUENCE (SIZE (1..maxUTRA-TDD-Carrier)) OF SEQUENCE {	1 entry		UTRA-TDD
carrierFreq[1]	Same downlink ARFCN as used for Cell 5		
cellReselectionPriority[1]	3		
}			
bandClassPriorityListHRPD	Not present		
bandClassPriorityList1XRTT	Not present		
t320	Not present		
}			
}			
}			
}			
}			

Condition	Explanation
UTRA-FDD	UTRA FDD cell environment
UTRA-TDD	UTRA TDD cell environment

Table 6.2.3.6.3.3-7: RRCConnectionRelease (step 15, Table 6.2.3.6.3.2-2)

Derivation Path: 36.508, Table 4.6.1-15			
Information Element	Value/remark	Comment	Condition
RRCConnectionRelease ::= SEQUENCE {			
criticalExtensions CHOICE {			
c1 CHOICE {			
rrcConnectionRelease-r8 SEQUENCE {			
idleModeMobilityControllInfo SEQUENCE {			
freqPriorityListEUTRA SEQUENCE (SIZE (1..maxFreq)) OF SEQUENCE {	1 entry		
carrierFreq[1]	Same downlink EARFCN as used for Cell 1		
cellReselectionPriority[1]	4		
}			
freqPriorityListGERAN	Not present		
freqPriorityListUTRA-FDD SEQUENCE (SIZE (1..maxUTRA-FDD-Carrier)) OF SEQUENCE {	1 entry		UTRA-FDD
carrierFreq[1]	Same downlink ARFCN as used for Cell 5		
cellReselectionPriority[1]	3		
}			
freqPriorityListUTRA-TDD SEQUENCE (SIZE (1..maxUTRA-TDD-Carrier)) OF SEQUENCE {	1 entry		UTRA-TDD
carrierFreq[1]	Same downlink ARFCN as used for Cell 5		
cellReselectionPriority[1]	3		
}			
bandClassPriorityListHRPD	Not present		
bandClassPriorityList1XRTT	Not present		
t320	min5		
}			
}			
}			
}			
}			

Condition	Explanation
UTRA-FDD	UTRA FDD cell environment
UTRA-TDD	UTRA TDD cell environment

Table 6.2.3.6.3.3-8: System Information Block type 19 for Cell 5 (preamble, Table 6.2.3.6.3.2-2)

Derivation Path: 36.508 table 4.4.4.1-1			
Information Element	Value/remark	Comment	Condition
SysInfoType19 ::= SEQUENCE {			
utra-PriorityInfoList ::= SEQUENCE {			
utra-ServingCell ::= SEQUENCE {			
priority	5		
}			
}			

6.2.3.7 Inter-RAT cell reselection / From E-UTRA RRC_IDLE to HRPD Idle / HRPD cell is higher reselection priority than E-UTRA

6.2.3.7.1 Test Purpose (TP)

(1)

```
with { UE in E-UTRA RRC_IDLE state and UE detects the cell re-selection criteria that HRPD cell is higher reselection priority than E-UTRAN serving cell }
ensure that { when { UE searches for and measures HRPD cell at least every Thigher_priority_search and Srxlev,HRPD > Threshx, HighP }
then { UE reselects the HRPD cell }
}
```

6.2.3.7.2 Conformance requirements

References: The conformance requirements covered in the present TC are specified in: TS 36.304, clause 5.2.4.1, 5.2.4.2 and 5.2.4.5 and TS 36.133, clause 4.2.2.5 and 4.2.2.5.4.

[TS 36.304, clause 5.2.4.1]

Absolute priorities of different E-UTRAN frequencies or inter-RAT frequencies may be provided to the UE in the system information, in the *RRCConnectionRelease* message, or by inheriting from another RAT at inter-RAT cell (re)selection. In the case of system information, an E-UTRAN frequency or inter-RAT frequency may be listed without providing a priority (i.e. the field *cellReselectionPriority* is absent for that frequency). If priorities are provided in dedicated signalling, the UE shall ignore all the priorities provided in system information. If UE is in *camped on any cell* state, UE shall only apply the priorities provided by system information from current cell, and the UE preserves priorities provided by dedicated signalling unless specified otherwise. When the UE in *camped normally* state, has only dedicated priorities other than for the current frequency, the UE shall consider the current frequency to be the lowest priority frequency (i.e. lower than the eight network configured values). While the UE is camped on a suitable CSG cell, the UE shall always consider the current frequency to be the highest priority frequency (i.e. higher than the eight network configured values), irrespective of any other priority value allocated to this frequency. The UE shall delete priorities provided by dedicated signalling when:

- the UE enters RRC_CONNECTED state; or
- the optional validity time of dedicated priorities (T320) expires; or
- a PLMN selection is performed on request by NAS [5].

NOTE: Equal priorities between RATs are not supported.

The UE shall only perform cell reselection evaluation for E-UTRAN frequencies and inter-RAT frequencies that are given in system information and for which the UE has a priority provided.

[TS 36.304, clause 5.2.4.2]

Following rules are used by the UE to limit needed measurements:

- If $S_{\text{intrasearch}}$ is sent in the serving cell and $S_{\text{ServingCell}} > S_{\text{intrasearch}}$, UE may choose to not perform intra-frequency measurements.
- If $S_{\text{ServingCell}} \leq S_{\text{intrasearch}}$, or $S_{\text{intrasearch}}$ is not sent in the serving cell UE shall perform intra-frequency measurements.
- The UE shall apply the following rules for E-UTRAN inter-frequencies and inter-RAT frequencies which are indicated in system information and for which the UE has priority provided as defined in 5.2.4.1:
 - For an E-UTRAN inter-frequency or inter-RAT frequency with a reselection priority higher than the reselection priority of the current E-UTRA frequency the UE shall perform measurements of higher priority E-UTRAN inter-frequency or inter-RAT frequencies according to [10].
 - For an E-UTRAN inter-frequency with an equal or lower reselection priority than the reselection priority of the current E-UTRA frequency and for inter-RAT frequency with lower reselection priority than the reselection priority of the current E-UTRAN frequency:
 - If $S_{\text{nonintrasearch}}$ is sent in the serving cell and $S_{\text{ServingCell}} > S_{\text{nonintrasearch}}$ UE may choose to not perform measurements of E-UTRAN inter-frequencies or inter-RAT frequency cells of equal or lower priority.
 - If $S_{\text{ServingCell}} \leq S_{\text{nonintrasearch}}$ or $S_{\text{nonintrasearch}}$ is not sent in the serving cell the UE shall perform measurements of E-UTRAN inter-frequencies or inter-RAT frequency cells of equal or lower priority according to [10].

Where $S_{\text{ServingCell}}$ is the S_{rxlev} -value of the serving cell.

[TS 36.304, clause 5.2.4.5]

If $ThreshX-Q$ is provided, cell reselection to a cell on a higher priority E-UTRAN frequency or inter-RAT frequency than the serving frequency shall be performed if:

- A cell of a higher priority RAT/ frequency fulfils $S_{qual} > Thresh_{X, HighQ}$ during a time interval $T_{reselection_{RAT}}$; and
- More than 1 second has elapsed since the UE camped on the current serving cell.

Otherwise, cell reselection to a cell on a higher priority E-UTRAN frequency or inter-RAT frequency than the serving frequency shall be performed if:

- A cell of a higher priority RAT/ frequency fulfils $S_{rxlev} > Thresh_{X, HighP}$ during a time interval $T_{reselection_{RAT}}$; and
- More than 1 second has elapsed since the UE camped on the current serving cell.

Cell reselection to a cell on an equal priority E-UTRAN frequency shall be based on ranking for Intra-frequency cell reselection as defined in sub-clause 5.2.4.6.

If $ThreshX-Q$ is provided, cell reselection to a cell on a lower priority E-UTRAN frequency or inter-RAT frequency than the serving frequency shall be performed if:

- The serving cell fulfils $S_{qual} < Thresh_{Serving, LowQ}$ and a cell of a lower priority RAT/ frequency fulfils $S_{qual} > Thresh_{X, LowQ}$ during a time interval $T_{reselection_{RAT}}$; and
- More than 1 second has elapsed since the UE camped on the current serving cell.

Otherwise, cell reselection to a cell on a lower priority E-UTRAN frequency or inter-RAT frequency than the serving frequency shall be performed if:

- The serving cell fulfils $S_{rxlev} < Thresh_{Serving, LowP}$ and a cell of a lower priority RAT/ frequency fulfils $S_{rxlev} > Thresh_{X, LowP}$ during a time interval $T_{reselection_{RAT}}$; and
- More than 1 second has elapsed since the UE camped on the current serving cell.

Cell reselection to a higher priority RAT/ frequency shall take precedence over a lower priority RAT/ frequency, if multiple cells of different priorities fulfil the cell reselection criteria.

For cdma2000 RATs, S_{rxlev} is equal to $-FLOOR(-2 \times 10 \times \log_{10} E_c/I_o)$ in units of 0.5 dB, as defined in [18], with E_c/I_o referring to the value measured from the evaluated cell.

For cdma2000 RATs, $Thresh_{X, HighP}$ and $Thresh_{X, LowP}$ are equal to -1 times the values signalled for the corresponding parameters in the system information.

[TS 36.133, clause 4.2.2.5]

If the $S_{ServingCell}$ of the E-UTRA serving cell is greater than $S_{nonintraSearch}$, then the UE shall search for inter-RAT layers of higher priority at least every $T_{higher_priority_search}$ where $T_{higher_priority_search}$ is described in section 4.2.2.

If the $S_{ServingCell}$ of the E-UTRA serving cell is less than or equal to $S_{nonintraSearch}$ then the UE shall search for and measure inter-RAT layers of higher, lower priority in preparation for possible reselection. In this scenario, the minimum rate at which the UE is required to search for and measure higher priority inter-RAT layers shall be the same as that defined below for lower priority RATs.

[TS 36.133, clause 4.2.2.5.4]

In order to perform measurement and cell reselection to HRPD cell, the UE shall acquire the timing of HRPD cells.

When the measurement rules indicate that HRPD cells are to be measured, the UE shall measure CDMA2000 HRPD Pilot Strength of HRPD cells in the neighbour cell list at the minimum measurement rate specified in this section.

The parameter 'Number of HRPD Neighbour Frequency', which is transmitted on E-UTRAN BCCH, is the number of carriers used for all HRPD cells in the neighbour cell list.

When the RSRP of the E-UTRA serving cell (or other cells on the same frequency layer) is lower than 'HRPD Start Measuring E-UTRAN Rx Power Strength Threshold' and HRPD is of lower priority than the currently selected E-UTRAN frequency layer, the UE shall measure CDMA2000 HRPD Pilot Strength of the HRPD cells at least every $(\text{Number of HRPD Neighbour Frequency}) \times T_{measureHRPD}$.

The UE shall be capable of evaluating that the HRPD cell has met cell reselection criterion defined in [1] within $T_{\text{evaluateHRPD}}$.

Table 4.2.2.5.4-1 gives values of $T_{\text{measureHRPD}}$ and $T_{\text{evaluateHRPD}}$.

Table 4.2.2.5.4-1: $T_{\text{measureHRPD}}$ and $T_{\text{evaluateHRPD}}$

DRX cycle length [s]	$T_{\text{measureHRPD}}$ [s] (number of DRX cycles)	$T_{\text{evaluateHRPD}}$ [s] (number of DRX cycles)
0.32	5.12 (16)	15.36 (48)
0.64	5.12 (8)	15.36 (24)
1.28	6.4 (5)	19.2 (15)
2.56	7.68 (3)	23.04 (9)

6.2.3.7.3 Test description

6.2.3.7.3.1 Pre-test conditions

System Simulator:

- Cell 1 for E-UTRAN
- Cell 15 for HRPD with higher reselection priority than Cell 1
- System information combination 6 as defined in TS 36.508 [18] clause 4.4.3.1 is used in E-UTRA cells.

UE:

None.

Preamble:

- The UE is in state Registered, Idle mode (state 2) on Cell 1 (serving cell) according to [18].

6.2.3.7.3.2 Test procedure sequence

Table 6.2.3.7.3.2-1 illustrates the downlink power levels and other changing parameters to be applied for the cells at various time instants of the test execution. The configurations marked "T1" and "T2" are applied at the point indicated in the Main behaviour description in Table 6.2.3.7.3.2-2.

Table 6.2.3.7.3.2-1: Time instances of cell power level and parameter changes

	Parameter	Unit	Cell 1	Cell 15	Remark
T1	$\hat{I}_{or/loc}$	dB	-	-20	Cell 15 is on $S_{rxlev,HRPD}$ of Cell 15 < $Thresh_{X, HighP}$
	loc	dBm/1.23 MHz	-	-75	
	Pilot E_c/I_o (Note 1)	dB	-	-20	
	Cell-specific RS EPRE	dBm/1.23 MHz	-60		
T2	$\hat{I}_{or/loc}$	dB	-	0	Increase pilot power of HRPD cell such that $S_{rxlev,HRPD}$ of Cell 15 > $Thresh_{X, HighP}$
	loc	dBm/1.23 MHz	-	-75	
	Pilot E_c/I_o (Note 1)	dB	-	-3	
	Cell-specific RS EPRE	dBm/1.23 MHz	-60		
Note 1: This parameter is not directly settable, but is derived by calculation from the other parameters set by the SS.					

Table 6.2.3.7.3.2-2: Main behaviour

St	Procedure	Message Sequence		TP	Verdict
		U - S	Message		
1	Void	-	-	-	-
2	The SS changes Cell 15 level according to row "T1" in table 6.2.3.7.3.2-1. Cell 15 is on and it has higher reselection priority than Cell1.	-	-	-	-
3	UE performs measurement for Cell 15 at every $T_{higher_priority_search}$	-	-	-	-
4	Check: Does the UE transmit an Access Probe on Cell 15 within the next [60s]?	-->	Access Probe	1	F
5	SS adjust HRPD cell signal level to make sure $S_{nonServingCell,HRPD}$ of Cell 15 > $Thresh_{HRPD, high}$, according to "T2" in table 6.2.3.7.3.2-2	-	-	-	-
6	Check: Does the UE transmit an Access Probe on Cell 15?	-->	Access Probe	1	P

6.2.3.7.3.3 Specific message contents

Table 6.2.3.7.3.3-1: *SystemInformationBlockType1* to Cell 1 (Preamble and all steps, table 6.2.3.7.3.2-1)

Derivation path: 36.508 table clause 4.4.3.2			
Information Element	Value/Remark	Comment	Condition
<i>SystemInformationBlockType1</i> ::= SEQUENCE {			
<i>cellSelectionInfo</i> SEQUENCE {			
<i>q-Rxlevmin</i>	-55 (-110 dBm)		
<i>q-Rxlevminoffset</i>	Not present		
}			

Table 6.2.3.7.3.3-2: SystemInformationBlockType8 to Cell 1 (Preamble and all steps, table 6.2.3.7.3.2-1)

Derivation path: 36.508 table 4.4.3.3			
Information Element	Value/Remark	Comment	Condition
SystemInformationBlockType8 ::= SEQUENCE {			
systemTimeInfo SEQUENCE {			
cdma-EUTRA-Synchronisation	TRUE		
cdma-SystemTime CHOICE {			
synchronousSystemTime	A valid value as per TS 36.331 and calculated by the SS		
}			
}			
searchWindowSize	5		
parametersHRPD SEQUENCE {			HRPD
cellReselectionParametersHRPD SEQUENCE {			
bandClassList SEQUENCE (SIZE (1..maxCDMA - BandClass)) OF SEQUENCE {	The same number of entries as the configured HRPD carriers		
bandClass	Band Class of frequency under test	[Set according to specific test case]	
cellReselectionPriority	5	[3 is applicable when HRPD is lower priority than E-UTRA. 5 is applicable when HRPD is higher priority than E-UTRA]	
threshX-High	30(-30)	INTEGER (0..63)	
threshX-Low	32(-32)	INTEGER (0..63)	
}			
t-ReselectionCDMA2000	7	INTEGER (0..7)	
}			
}			
}			
}			

6.2.3.7a Inter-RAT cell reselection / From E-UTRA RRC_IDLE to HRPD Idle / HRPD cell is higher reselection priority than E-UTRA ($Srxlev_{HRPD, HighP} > Thresh_{HRPD, HighP}$)

6.2.3.7a.1 Test Purpose (TP)

(1)

```
with { UE in E-UTRA RRC_IDLE }
ensure that {
  when { UE detects a HRPD cell with higher reselection priority than the E-UTRAN serving cell }
  then { UE does not reselect the HRPD cell }
}
```

Note: The UE is expected during this time to do measurements on the HRPD cell at least every $T_{higher_priority_search}$ but this cannot be easily verified

(2)

```
with { UE in E-UTRA RRC_IDLE having detected a HRPD cell with higher reselection priority than the E-UTRAN serving cell }
ensure that {
  when {  $Srxlev_{HRPD} > Thresh_{HRPD, HighP}$  }
  then { UE reselects the HRPD cell }
}
```

6.2.3.7a.2 Conformance requirements

References: The conformance requirements covered in the present TC are specified in: TS 36.304, clause 5.2.4.1, 5.2.4.2 and 5.2.4.5 and TS 36.133, clause 4.2.2.5 and 4.2.2.5.4.

[TS 36.304, clause 5.2.4.1]

Absolute priorities of different E-UTRAN frequencies or inter-RAT frequencies may be provided to the UE in the system information, in the *RRConnectionRelease* message, or by inheriting from another RAT at inter-RAT cell (re)selection. In the case of system information, an E-UTRAN frequency or inter-RAT frequency may be listed without providing a priority (i.e. the field *cellReselectionPriority* is absent for that frequency). If priorities are provided in dedicated signalling, the UE shall ignore all the priorities provided in system information. If UE is in *camped on any cell* state, UE shall only apply the priorities provided by system information from current cell, and the UE preserves priorities provided by dedicated signalling unless specified otherwise. When the UE is *camped normally* state, has only dedicated priorities other than for the current frequency, the UE shall consider the current frequency to be the lowest priority frequency (i.e. lower than the eight network configured values). While the UE is camped on a suitable CSG cell, the UE shall always consider the current frequency to be the highest priority frequency (i.e. higher than the eight network configured values), irrespective of any other priority value allocated to this frequency. The UE shall delete priorities provided by dedicated signalling when:

- the UE enters RRC_CONNECTED state; or
- the optional validity time of dedicated priorities (T320) expires; or
- a PLMN selection is performed on request by NAS [5].

NOTE: Equal priorities between RATs are not supported.

The UE shall only perform cell reselection evaluation for E-UTRAN frequencies and inter-RAT frequencies that are given in system information and for which the UE has a priority provided.

The UE shall not consider any black listed cells as candidate for cell reselection.

The UE shall inherit the priorities provided by dedicated signalling and the remaining validity time (i.e., T320 in E-UTRA, T322 in UTRA and T3230 in GERAN), if configured, at inter-RAT cell (re)selection.

NOTE: The network may assign dedicated cell reselection priorities for frequencies not configured by system information.

[TS 36.304, clause 5.2.4.2]

When evaluating *Srxlev* and *Squal* of non-serving cells for reselection purposes, the UE shall use parameters provided by the serving cell.

Following rules are used by the UE to limit needed measurements:

- If the serving cell fulfils $S_{rxlev} > S_{IntraSearchP}$ and $S_{qual} > S_{IntraSearchQ}$, the UE may choose not to perform intra-frequency measurements.
- Otherwise, the UE shall perform intra-frequency measurements.
- The UE shall apply the following rules for E-UTRAN inter-frequencies and inter-RAT frequencies which are indicated in system information and for which the UE has priority provided as defined in 5.2.4.1:
 - For an E-UTRAN inter-frequency or inter-RAT frequency with a reselection priority higher than the reselection priority of the current E-UTRA frequency the UE shall perform measurements of higher priority E-UTRAN inter-frequency or inter-RAT frequencies according to [10].
 - For an E-UTRAN inter-frequency with an equal or lower reselection priority than the reselection priority of the current E-UTRA frequency and for inter-RAT frequency with lower reselection priority than the reselection priority of the current E-UTRAN frequency:
 - If the serving cell fulfils $S_{rxlev} > S_{nonIntraSearchP}$ and $S_{qual} > S_{nonIntraSearchQ}$, the UE may choose not to perform measurements of E-UTRAN inter-frequencies or inter-RAT frequency cells of equal or lower priority.
 - Otherwise, the UE shall perform measurements of E-UTRAN inter-frequencies or inter-RAT frequency cells of equal or lower priority according to [10].

[TS 36.304, clause 5.2.4.5]

If *threshServingLowQ* is provided in *SystemInformationBlockType3*, cell reselection to a cell on a higher priority E-UTRAN frequency or inter-RAT frequency than the serving frequency shall be performed if:

- A cell of a higher priority EUTRAN or UTRAN FDD RAT/ frequency fulfils $Squal > Thresh_{X, HighQ}$ during a time interval $T_{reselection_{RAT}}$; or
- A cell of a higher priority UTRAN TDD, GERAN or CDMA2000 RAT/ frequency fulfils $Srxlev > Thresh_{X, HighP}$ during a time interval $T_{reselection_{RAT}}$; and
- More than 1 second has elapsed since the UE camped on the current serving cell.

Otherwise, cell reselection to a cell on a higher priority E-UTRAN frequency or inter-RAT frequency than the serving frequency shall be performed if:

- A cell of a higher priority RAT/ frequency fulfils $Srxlev > Thresh_{X, HighP}$ during a time interval $T_{reselection_{RAT}}$; and
- More than 1 second has elapsed since the UE camped on the current serving cell.

Cell reselection to a cell on an equal priority E-UTRAN frequency shall be based on ranking for Intra-frequency cell reselection as defined in sub-clause 5.2.4.6.

If *threshServingLowQ* is provided in *SystemInformationBlockType3*, cell reselection to a cell on a lower priority E-UTRAN frequency or inter-RAT frequency than the serving frequency shall be performed if:

- The serving cell fulfils $Squal < Thresh_{Serving, LowQ}$ and a cell of a lower priority EUTRAN or UTRAN FDD RAT/ frequency fulfils $Squal > Thresh_{X, LowQ}$ during a time interval $T_{reselection_{RAT}}$; or
- The serving cell fulfils $Squal < Thresh_{Serving, LowQ}$ and a cell of a lower priority UTRAN TDD, GERAN or CDMA2000 RAT/ frequency fulfils $Srxlev > Thresh_{X, LowP}$ during a time interval $T_{reselection_{RAT}}$; and
- More than 1 second has elapsed since the UE camped on the current serving cell.

Otherwise, cell reselection to a cell on a lower priority E-UTRAN frequency or inter-RAT frequency than the serving frequency shall be performed if:

- The serving cell fulfils $Srxlev < Thresh_{Serving, LowP}$ and a cell of a lower priority RAT/ frequency fulfils $Srxlev > Thresh_{X, LowP}$ during a time interval $T_{reselection_{RAT}}$; and
- More than 1 second has elapsed since the UE camped on the current serving cell.

Cell reselection to a higher priority RAT/ frequency shall take precedence over a lower priority RAT/ frequency, if multiple cells of different priorities fulfil the cell reselection criteria.

For cdma2000 RATs, $Srxlev$ is equal to $-FLOOR(-2 \times 10 \times \log_{10} Ec/Io)$ in units of 0.5 dB, as defined in [18], with Ec/Io referring to the value measured from the evaluated cell.

For cdma2000 RATs, $Thresh_{X, HighP}$ and $Thresh_{X, LowP}$ are equal to -1 times the values signalled for the corresponding parameters in the system information.

In all the above criteria the value of $T_{reselection_{RAT}}$ is scaled when the UE is in the medium or high mobility state as defined in subclause 5.2.4.3.1. If more than one cell meets the above criteria, the UE shall reselect a cell as follows:

- If the highest-priority frequency is an E-UTRAN frequency, a cell ranked as the best cell among the cells on the highest priority frequency(ies) meeting the criteria according to section 5.2.4.6;
- If the highest-priority frequency is from another RAT, a cell ranked as the best cell among the cells on the highest priority frequency(ies) meeting the criteria of that RAT.

[TS 36.133, clause 4.2.2.5]

If $Srxlev > S_{nonIntraSearchP}$ and $Squal > S_{nonIntraSearchQ}$ then the UE shall search for inter-RAT layers of higher priority at least every $T_{higher_priority_search}$ where $T_{higher_priority_search}$ is described in section 4.2.2

If $Srxlev \leq S_{nonIntraSearchP}$ or $Squal \leq S_{nonIntraSearchQ}$ then the UE shall search for and measure inter-RAT layers of higher, lower priority in preparation for possible reselection. In this scenario, the minimum rate at which the UE is required to

search for and measure higher priority inter-RAT layers shall be the same as that defined below for lower priority RATs.

[TS 36.133, clause 4.2.2.5.4]

In order to perform measurement and cell reselection to HRPD cell, the UE shall acquire the timing of HRPD cells.

When the measurement rules indicate that HRPD cells are to be measured, the UE shall measure CDMA2000 HRPD Pilot Strength of HRPD cells in the neighbour cell list at the minimum measurement rate specified in this section.

The parameter ‘Number of HRPD Neighbour Frequency’, which is transmitted on E-UTRAN BCCH, is the number of carriers used for all HRPD cells in the neighbour cell list.

When the E-UTRA serving cell fulfils $S_{rxlev} > S_{nonIntraSearchP}$ and $S_{qual} > S_{nonIntraSearchQ}$, the UE shall search for CDMA2000 HRPD layers of higher priority at least every $T_{higher_priority_search}$ where $T_{higher_priority_search}$ is defined in section 4.2.2.

For CDMA2000 HRPD cells which have been detected, the UE shall measure CDMA2000 HRPD Pilot Strength at least every $(\text{Number of HRPD Neighbour Frequency}) * T_{measureHRPD}$, when the E-UTRA serving cell $S_{rxlev} \leq S_{nonIntraSearchP}$ or $S_{qual} \leq S_{nonIntraSearchQ}$.

The UE shall be capable of evaluating that the CDMA2000 HRPD cell has met cell reselection criterion defined in [1] within $T_{evaluateHRPD}$.

Table 4.2.2.5.4-1 gives values of $T_{measureHRPD}$ and $T_{evaluateHRPD}$.

Table 4.2.2.5.4-1: $T_{measureHRPD}$ and $T_{evaluateHRPD}$

DRX cycle length [s]	$T_{measureHRPD}$ [s] (number of DRX cycles)	$T_{evaluateHRPD}$ [s] (number of DRX cycles)
0.32	5.12 (16)	15.36 (48)
0.64	5.12 (8)	15.36 (24)
1.28	6.4 (5)	19.2 (15)
2.56	7.68 (3)	23.04 (9)

If $T_{reselection}$ timer has a non zero value and the CDMA2000 HRPD cell is satisfied with the reselection criteria which are defined in [1], the UE shall evaluate this CDMA2000 HRPD cell for the $T_{reselection}$ time. If this cell remains satisfied with the reselection criteria within this duration, then the UE shall reselect that cell.

6.2.3.7a.3 Test description

6.2.3.7a.3.1 Pre-test conditions

System Simulator:

- Cell 1 for E-UTRAN
- Cell 15 for HRPD with higher reselection priority than Cell 1
- System information combination 6 as defined in TS 36.508 [18] clause 4.4.3.1 is used in E-UTRA cells.

UE:

None.

Preamble:

- The UE is in state Registered, Idle mode (state 2) on Cell 1 (serving cell) according to [18].

6.2.3.7a.3.2 Test procedure sequence

Table 6.2.3.7.3.2-1 illustrates the downlink power levels and other changing parameters to be applied for the cells at various time instants of the test execution. The configurations marked "T1" and "T2" are applied at the point indicated in the Main behaviour description in Table 6.2.3.7.3.2-2.

Table 6.2.3.7a.3.2-1: Time instances of cell power level and parameter changes

	Parameter	Unit	Cell 1	Cell 15	Remark
T1	$\bar{I}_{or/loc}$	dB	-	-20	Cell 15 is on $S_{rxlev,HRPD}$ of Cell 15 < $Thresh_{HRPD,HighP}$
	loc	dBm/1.23 MHz	-	-75	
	Pilot Ec/Io (Note 1)	dB	-	-20	
	Cell-specific RS EPRE	dBm/1.5 KHz	-60		
T2	$\bar{I}_{or/loc}$	dB	-	0	Increase pilot power of HRPD cell such that $S_{rxlev,HRPD}$ of Cell 15 > $Thresh_{HRPD,HighP}$
	loc	dBm/1.23 MHz	-	-75	
	Pilot Ec/Io (Note 1)	dB	-	-3	
	Cell-specific RS EPRE	dBm/1.5 KHz	-60		
Note 1: This parameter is not directly settable, but is derived by calculation from the other parameters set by the SS.					

Table 6.2.3.7a.3.2-2: Main behaviour

St	Procedure	Message Sequence		TP	Verdict
		U - S	Message		
1	The SS changes Cell 15 level according to row "T1" in table 6.2.3.7a.3.2-1. Cell 15 is on and it has higher reselection priority than Cell1.	-	-	-	-
2	UE performs measurement for Cell 15 at every $T_{higher_priority_search}$	-	-	-	-
3	Check: Does the UE transmit an Access Probe on Cell 15 within the next [60s]?	-->	Access Probe	1	F
4	SS adjust HRPD cell signal level to make sure S_{rxlev} of Cell 15 > $Thresh_{HRPD, HighP}$, according to "T2" in table 6.2.3.7a.3.2-1	-	-	-	-
5	Check: Does the UE transmit an Access Probe on Cell 15?	-->	Access Probe	2	P
Note 1: The UE is expected during this time to do measurements on the HRPD cell at least every $T_{higher_priority_search}$ but this cannot be easily verified.					

6.2.3.7a.3.3 Specific message contents

Table 6.2.3.7a.3.3-1: SystemInformationBlockType1 to Cell 1 (Preamble and all steps, table 6.2.3.7.3.2-2)

Derivation path: 36.508 table clause 4.4.3.2			
Information Element	Value/Remark	Comment	Condition
SystemInformationBlockType1 ::= SEQUENCE {			
cellSelectionInfo SEQUENCE {			
q-Rxlevmin	-55 (-110 dBm)		
q-Rxlevminoffset	Not present		
}			

Table 6.2.3.7a.3.3-2: Void

Table 6.2.3.7a.3.3-3: *SystemInformationBlockType8* to Cell 1 (Preamble and all steps, table 6.2.3.7a.3.2-2)

Derivation path: 36.508 table 4.4.3.3			
Information Element	Value/Remark	Comment	Condition
SystemInformationBlockType8 ::= SEQUENCE {			
systemTimeInfo SEQUENCE {			
cdma-EUTRA-Synchronisation	TRUE		
cdma-SystemTime CHOICE {			
synchronousSystemTime	A valid value as per TS 36.331 and calculated by the SS		
}			
}			
searchWindowSize	5		
parametersHRPD SEQUENCE {			HRPD
cellReselectionParametersHRPD SEQUENCE {			
bandClassList SEQUENCE (SIZE (1..maxCDMA - BandClass)) OF SEQUENCE {	The same number of entries as the configured HRPD carriers		
bandClass	Band Class of frequency under test	[Set according to specific test case]	
cellReselectionPriority	5	[3 is applicable when HRPD is lower priority than E-UTRA. 5 is applicable when HRPD is higher priority than E-UTRA]	
threshX-High	30(-30)	INTEGER (0..63)	
threshX-Low	32(-32)	INTEGER (0..63)	
}			
t-ReselectionCDMA2000	7	INTEGER (0..7)	
}			
}			
}			
}			

6.2.3.8 Inter-RAT cell reselection / From E-UTRA RRC_IDLE to HRPD Idle / HRPD is lower reselection priority than E-UTRA

6.2.3.8.1 Test Purpose (TP)

(1)

```
with { UE in E-UTRA RRC_IDLE state and UE detects the cell re-selection criteria that HRPD cell is equal to or lower reselection priority than E-UTRAN serving cell }
ensure that {
  When{ SServingCell <= ThreshServing, LowP and Srxlev > ThreshHRPD, low }
  then { UE searches for and measures HRPD cell at least every TmeasureHRPD and reselects the HRPD cell }
}
```

6.2.3.8.2 Conformance requirements

References: The conformance requirements covered in the present TC are specified in: TS 36.304, clause 5.2.4.1, 5.2.4.2 and 5.2.4.5 and TS 36.133, clause 4.2.2.5 and 4.2.2.5.4.

[TS 36.304, clause 5.2.4.1]

Absolute priorities of different E-UTRAN frequencies or inter-RAT frequencies may be provided to the UE in the system information or in the RRC message releasing the RRC connection. If priorities are assigned via dedicated signalling, the UE shall ignore all the priorities provided in system information. The UE shall delete priorities provided by dedicated signalling when:

- the UE enters RRC_CONNECTED state; or
- the optional validity time of dedicated priorities (T320) expires; or
- a PLMN selection is performed on request by NAS [5].

NOTE: Equal priorities between RATs are not supported.

UE shall only perform reselection evaluation for E-UTRAN frequencies and inter-RAT frequencies that are given in system information and for which the UE has a priority provided.

[TS 36.304, clause 5.2.4.2]

Following rules are used by the UE to limit needed measurements:

- If $S_{\text{ServingCell}} > S_{\text{Intrasearch}}$, UE may choose to not perform intra-frequency measurements.
- If $S_{\text{ServingCell}} \leq S_{\text{Intrasearch}}$, UE shall perform intra-frequency measurements.
- The UE shall apply the following rules for E-UTRAN inter-frequencies and inter-RAT frequencies which are indicated in system information and for which the UE has priority provided as defined in 5.2.4.1:
 - o For an E-UTRAN inter-frequency or inter-RAT frequency with a reselection priority higher than the reselection priority of the current E-UTRA frequency the UE shall perform measurements of higher priority E-UTRAN inter-frequency or inter-RAT frequencies according to [10].
 - o For an E-UTRAN inter-frequency with a equal or lower reselection priority than the reselection priority of the current E-UTRA frequency and for inter-RAT frequency with lower reselection priority than the reselection priority of the current E-UTRAN frequency:
 - If $S_{\text{ServingCell}} > S_{\text{Nonintrasearch}}$ UE may choose not to perform measurements of E-UTRAN inter-frequencies or inter-RAT frequencies of equal or lower priority.
 - If $S_{\text{ServingCell}} \leq S_{\text{Nonintrasearch}}$ the UE shall perform measurements of E-UTRAN inter-frequencies or inter-RAT frequencies cells of equal or lower priority according to [10].

Where $S_{\text{ServingCell}}$ is the S_{rxlev} -value of the serving cell.

[TS 36.304, clause 5.2.4.5]

If ThreshX-Q is provided, cell reselection to a cell on a higher priority E-UTRAN frequency or inter-RAT frequency than the serving frequency shall be performed if:

- A cell of a higher priority RAT/ frequency fulfils $S_{\text{qual}} > \text{Thresh}_{\text{X, HighQ}}$ during a time interval $T_{\text{reselectionRAT}}$; and
- More than 1 second has elapsed since the UE camped on the current serving cell.

Otherwise, cell reselection to a cell on a higher priority E-UTRAN frequency or inter-RAT frequency than the serving frequency shall be performed if:

- A cell of a higher priority RAT/ frequency fulfils $S_{\text{rxlev}} > \text{Thresh}_{\text{X, HighP}}$ during a time interval $T_{\text{reselectionRAT}}$; and
- More than 1 second has elapsed since the UE camped on the current serving cell.

Cell reselection to a cell on an equal priority E-UTRAN frequency shall be based on ranking for Intra-frequency cell reselection as defined in sub-clause 5.2.4.6.

If ThreshX-Q is provided, cell reselection to a cell on a lower priority E-UTRAN frequency or inter-RAT frequency than the serving frequency shall be performed if:

- The serving cell fulfils $S_{\text{qual}} < \text{Thresh}_{\text{Serving, LowQ}}$ and a cell of a lower priority RAT/ frequency fulfils $S_{\text{qual}} > \text{Thresh}_{\text{X, LowQ}}$ during a time interval $T_{\text{reselectionRAT}}$; and
- More than 1 second has elapsed since the UE camped on the current serving cell.

Otherwise, cell reselection to a cell on a lower priority E-UTRAN frequency or inter-RAT frequency than the serving frequency shall be performed if:

- The serving cell fulfils $S_{rxlev} < \text{Thresh}_{\text{Serving, LowP}}$ and a cell of a lower priority RAT/ frequency fulfils $S_{rxlev} > \text{Thresh}_{X, \text{LowP}}$ during a time interval $T_{\text{reselection}_{\text{RAT}}}$; and
- More than 1 second has elapsed since the UE camped on the current serving cell.

Cell reselection to a higher priority RAT/ frequency shall take precedence over a lower priority RAT/ frequency, if multiple cells of different priorities fulfil the cell reselection criteria.

For cdma2000 RATs, S_{rxlev} is equal to $-\text{FLOOR}(-2 \times 10 \times \log_{10} E_c/I_o)$ in units of 0.5 dB, as defined in [18], with E_c/I_o referring to the value measured from the evaluated cell.

For cdma2000 RATs, $\text{Thresh}_{X, \text{HighP}}$ and $\text{Thresh}_{X, \text{LowP}}$ are equal to -1 times the values signalled for the corresponding parameters in the system information.

[TS 36.133, clause 4.2.2.5]

If the $S_{\text{ServingCell}}$ of the E-UTRA serving cell (or other cells on the same frequency layer) is greater than $S_{\text{nonintrasearch}}$, then

- the UE may not search for, or measure inter-RAT layers of equal or lower priority.
- the UE shall search for inter-RAT layers of higher priority at least every $T_{\text{higher_priority_search}}$ where $T_{\text{higher_priority_search}}$ is described in section 4.2.2.

If the $S_{\text{ServingCell}}$ of the E-UTRA serving cell is less than or equal to $S_{\text{nonintrasearch}}$, then the UE shall search for and measure inter-RAT layers of higher, equal or lower priority in preparation for possible reselection. In this scenario, the minimum rate at which the UE is required to search for and measure such layers is not reduced and shall be the same as that defined below for lower priority RATs.

[TS 36.133, clause 4.2.2.5.4]

In order to perform measurement and cell reselection to HRPD cell, the UE shall acquire the timing of HRPD cells.

When the measurement rules indicate that HRPD cells are to be measured, the UE shall measure CDMA2000 HRPD Pilot Strength of HRPD cells in the neighbour cell list at the minimum measurement rate specified in this section.

The parameter 'Number of HRPD Neighbour Frequency', which is transmitted on E-UTRAN BCCH, is the number of carriers used for all HRPD cells in the neighbour cell list.

When the RSRP of the E-UTRA serving cell (or other cells on the same frequency layer) is lower than 'HRPD Start Measuring E-UTRAN Rx Power Strength Threshold' and HRPD is of lower priority than the currently selected E-UTRAN frequency layer, the UE shall measure CDMA2000 HRPD Pilot Strength of the HRPD cells at least every $(\text{Number of HRPD Neighbour Frequency}) \times T_{\text{measureHRPD}}$. In case HRPD is of higher priority than the currently selected E-UTRAN frequency layer the UE shall measure HRPD cells at least every $(\text{Number of HRPD Neighbour Frequency}) \times T_{\text{higher_priority_search}}$. The parameter $T_{\text{higher_priority_search}}$ is defined in section 4.2.2.

The UE shall be capable of evaluating that the HRPD cell has met cell reselection criterion defined in [1] within $T_{\text{evaluateHRPD}}$.

Table 4.2.2.5.4-1 gives values of $T_{\text{measureHRPD}}$ and $T_{\text{evaluateHRPD}}$.

Table 4.2.2.5.4-1: $T_{\text{measureHRPD}}$ and $T_{\text{evaluateHRPD}}$

DRX cycle length [s]	$T_{\text{measureHRPD}}$ [s] (number of DRX cycles)	$T_{\text{evaluateHRPD}}$ [s] (number of DRX cycles)
0.32	5.12 (16)	15.36 (48)
0.64	5.12 (8)	15.36 (24)
1.28	6.4 (5)	19.2 (15)
2.56	7.68 (3)	23.04 (9)

6.2.3.8.3 Test description

6.2.3.8.3.1 Pre-test conditions

System Simulator:

- Cell 1 for E-UTRAN
- Cell 15 for HRPD with lower reselection priority than Cell 1
- System information combination 6 as defined in TS 36.508 [18] clause 4.4.3.1 is used in E-UTRA cells.

UE:

None.

Preamble:

- The UE is in state Registered, Idle mode (state 2) on Cell 1 (serving cell) according to [18].

6.2.3.8.3.2 Test procedure sequence

Table 6.2.3.8.3.2-1 illustrates the downlink power levels and other changing parameters to be applied for the cells at various time instants of the test execution. The configurations marked "T1" and "T2" are applied at the point indicated in the Main behaviour description in Table 6.2.3.8.3.2-2.

Table 6.2.3.8.3.2-1: Time instances of cell power level and parameter changes

	Parameter	Unit	Cell 1	Cell 15	Remark
T1	$\bar{I}_{or/loc}$	dB	-	-20	Cell 15 is on
	loc	dBm/ 1.23 MHz	-	-55	
	Pilot E_c/I_o (Note 1)	dB	-	-20	
	Cell-specific RS EPRE	dBm/1 5kHz	-70	-	$S_{ServingCell}$ of the E-UTRA > $Thresh_{Serving, LowP}$ and $S_{rxlev, HRPD}$ of Cell 15 < $Thresh_{x, low}$
	S_{rxlev} (Note 1)	dB	40	-40	
T2	$\bar{I}_{or/loc}$	dB	-	-5	Increase pilot power of HRPD cell such that $S_{nonServingCell, HRPD}$ of Cell 15 > $Thresh_{x, low}$
	loc	dBm/1. 23 MHz	-	-55	
	Pilot E_c/I_o (Note 1)	dB	-	-6.2	
	Cell-specific RS EPRE	dBm/1 5kHz	-120	-	
	S_{rxlev} (Note 1)	dB	-10	-12	
Note 1: This parameter is not directly settable, but is derived by calculation from the other parameters set by the SS.					
Note 2: Default value of $Thresh_{Serving, LowP}$ is 0.					

Table 6.2.3.8.3.2-2: Main behaviour

St	Procedure	Message Sequence		TP	Verdict
		U - S	Message		
1	Cell 15 is on and it has lower reselection priority than Cell 1, according to "T1" in 6.2.3.8.3-1. SS adjusts the serving cell signal level so that $S_{\text{ServingCell of the E-UTRA}} \leq S_{\text{nonintra search.2}}$	-	-	-	-
2	Void				
3	UE performs measurement for Cell 15 at every $T_{\text{measureHRPD}}$	-	-	-	-
4	Check: Does the UE transmit an Access Probe on Cell 15 within the next [60s]?	-->	Access Probe	1	F
5	SS adjust HRPD cell signal level to make sure $S_{\text{nonServingCell, HRPD}}$ of Cell 15 > $\text{Thresh}_{\text{HRPD, low}}$ according to "T2" in 6.2.3.8.3.2-1.	-	-	-	-
6	Check: Does the UE transmit an Access Probe on Cell 15?	-->	Access Probe	1	P

6.2.3.8.3.3 Specific message contents

Table 6.2.3.8.3.3-1: *SystemInformationBlockType1* to Cell 1 (Preamble and all steps, table 6.2.3.8.3.2-1)

Derivation path: 36.508 table 4.4.3.2			
Information Element	Value/Remark	Comment	Condition
<i>SystemInformationBlockType1</i> ::= SEQUENCE {			
<i>cellSelectionInfo</i> SEQUENCE {			
<i>q-Rxlevmin</i>	-55 (-110 dBm)		
<i>q-Rxlevminoffset</i>	Not present		
}			
}			

Table 6.2.3.8.3.3-2: SystemInformationBlockType8 to Cell 1 (Preamble and all steps, table 6.2.3.8.3.2-1)

Derivation path: 36.508 table 4.4.3.3			
Information Element	Value/Remark	Comment	Condition
SystemInformationBlockType8 ::= SEQUENCE {			
systemTimeInfo SEQUENCE {			
cdma-EUTRA-Synchronisation	TRUE		
cdma-SystemTime CHOICE {			
synchronousSystemTime	A valid value as per TS 36.331 and calculated by the SS		
}			
}			
searchWindowSize	5		
parametersHRPD SEQUENCE {			HRPD
cellReselectionParametersHRPD SEQUENCE {			
bandClassList SEQUENCE (SIZE (1..maxCDMA - BandClass)) OF SEQUENCE {	The same number of entries as the configured HRPD carriers		
bandClass	Band Class of frequency under test	[Set according to specific test case]	
cellReselectionPriority	3	[3 is applicable when HRPD is lower priority than E-UTRA. 5 is applicable when HRPD is higher priority than E-UTRA]	
threshX-High	30[-30]	INTEGER (0..63)	
threshX-Low	32[-32]	INTEGER (0..63)	
}			
t-ReselectionCDMA2000	0	INTEGER (0..7)	
}			
}			
}			
}			

6.2.3.8a Inter-RAT cell reselection / From E-UTRA RRC_IDLE to HRPD Idle / HRPD cell is lower reselection priority than E-UTRA (Squal < Thresh_{Serving, LowQ} and Srxlev > Thresh_{HRPD, LowP})

6.2.3.8a.1 Test Purpose (TP)

(1)

```
with { UE in E-UTRA RRC_IDLE }
ensure that {
  when { UE detects a HRPD cell with equal or lower reselection priority than the E-UTRAN serving cell }
  then { UE does not reselect the HRPD cell }
}
```

Note: The UE is expected during this time to do measurements on the HRPD cell at least every $T_{\text{measureHRPD}}$ but this cannot be easily verified

(2)

```
with { UE in E-UTRA RRC_IDLE having detected a HRPD cell with equal or lower reselection priority than the E-UTRAN serving cell }
ensure that {
  when { Srxlev, HRPD > ThreshHRPD, LowP }
  then { UE reselects the HRPD cell }
}
```

6.2.3.8a.2 Conformance requirements

References: The conformance requirements covered in the present TC are specified in: TS 36.304, clause 5.2.4.1, 5.2.4.2 and 5.2.4.5 and TS 36.133, clause 4.2.2.5 and 4.2.2.5.4.

[TS 36.304, clause 5.2.4.1]

Absolute priorities of different E-UTRAN frequencies or inter-RAT frequencies may be provided to the UE in the system information, in the *RRCConnectionRelease* message, or by inheriting from another RAT at inter-RAT cell (re)selection. In the case of system information, an E-UTRAN frequency or inter-RAT frequency may be listed without providing a priority (i.e. the field *cellReselectionPriority* is absent for that frequency). If priorities are provided in dedicated signalling, the UE shall ignore all the priorities provided in system information. If UE is in *camped on any cell* state, UE shall only apply the priorities provided by system information from current cell, and the UE preserves priorities provided by dedicated signalling unless specified otherwise. When the UE in *camped normally* state, has only dedicated priorities other than for the current frequency, the UE shall consider the current frequency to be the lowest priority frequency (i.e. lower than the eight network configured values). While the UE is camped on a suitable CSG cell, the UE shall always consider the current frequency to be the highest priority frequency (i.e. higher than the eight network configured values), irrespective of any other priority value allocated to this frequency. The UE shall delete priorities provided by dedicated signalling when:

- the UE enters RRC_CONNECTED state; or
- the optional validity time of dedicated priorities (T320) expires; or
- a PLMN selection is performed on request by NAS [5].

NOTE: Equal priorities between RATs are not supported.

The UE shall only perform cell reselection evaluation for E-UTRAN frequencies and inter-RAT frequencies that are given in system information and for which the UE has a priority provided.

The UE shall not consider any black listed cells as candidate for cell reselection.

The UE shall inherit the priorities provided by dedicated signalling and the remaining validity time (i.e., T320 in E-UTRA, T322 in UTRA and T3230 in GERAN), if configured, at inter-RAT cell (re)selection.

NOTE: The network may assign dedicated cell reselection priorities for frequencies not configured by system information.

[TS 36.304, clause 5.2.4.2]

When evaluating *Srxlev* and *Squal* of non-serving cells for reselection purposes, the UE shall use parameters provided by the serving cell.

Following rules are used by the UE to limit needed measurements:

- If the serving cell fulfils $S_{rxlev} > S_{IntraSearchP}$ and $S_{qual} > S_{IntraSearchQ}$, the UE may choose not to perform intra-frequency measurements.
- Otherwise, the UE shall perform intra-frequency measurements.
- The UE shall apply the following rules for E-UTRAN inter-frequencies and inter-RAT frequencies which are indicated in system information and for which the UE has priority provided as defined in 5.2.4.1:
 - For an E-UTRAN inter-frequency or inter-RAT frequency with a reselection priority higher than the reselection priority of the current E-UTRA frequency the UE shall perform measurements of higher priority E-UTRAN inter-frequency or inter-RAT frequencies according to [10].
 - For an E-UTRAN inter-frequency with an equal or lower reselection priority than the reselection priority of the current E-UTRA frequency and for inter-RAT frequency with lower reselection priority than the reselection priority of the current E-UTRAN frequency:
 - If the serving cell fulfils $S_{rxlev} > S_{nonIntraSearchP}$ and $S_{qual} > S_{nonIntraSearchQ}$, the UE may choose not to perform measurements of E-UTRAN inter-frequencies or inter-RAT frequency cells of equal or lower priority.

- Otherwise, the UE shall perform measurements of E-UTRAN inter-frequencies or inter-RAT frequency cells of equal or lower priority according to [10].

[TS 36.304, clause 5.2.4.5]

If *threshServingLowQ* is provided in *SystemInformationBlockType3*, cell reselection to a cell on a higher priority E-UTRAN frequency or inter-RAT frequency than the serving frequency shall be performed if:

- A cell of a higher priority EUTRAN or UTRAN FDD RAT/ frequency fulfils $S_{qual} > Thresh_{X, HighQ}$ during a time interval $T_{reselection_{RAT}}$; or
- A cell of a higher priority UTRAN TDD, GERAN or CDMA2000 RAT/ frequency fulfils $S_{rxlev} > Thresh_{X, HighP}$ during a time interval $T_{reselection_{RAT}}$; and
- More than 1 second has elapsed since the UE camped on the current serving cell.

Otherwise, cell reselection to a cell on a higher priority E-UTRAN frequency or inter-RAT frequency than the serving frequency shall be performed if:

- A cell of a higher priority RAT/ frequency fulfils $S_{rxlev} > Thresh_{X, HighP}$ during a time interval $T_{reselection_{RAT}}$; and
- More than 1 second has elapsed since the UE camped on the current serving cell.

Cell reselection to a cell on an equal priority E-UTRAN frequency shall be based on ranking for Intra-frequency cell reselection as defined in sub-clause 5.2.4.6.

If *threshServingLowQ* is provided in *SystemInformationBlockType3*, cell reselection to a cell on a lower priority E-UTRAN frequency or inter-RAT frequency than the serving frequency shall be performed if:

- The serving cell fulfils $S_{qual} < Thresh_{Serving, LowQ}$ and a cell of a lower priority EUTRAN or UTRAN FDD RAT/ frequency fulfils $S_{qual} > Thresh_{X, LowQ}$ during a time interval $T_{reselection_{RAT}}$; or
- The serving cell fulfils $S_{qual} < Thresh_{Serving, LowQ}$ and a cell of a lower priority UTRAN TDD, GERAN or CDMA2000 RAT/ frequency fulfils $S_{rxlev} > Thresh_{X, LowP}$ during a time interval $T_{reselection_{RAT}}$; and
- More than 1 second has elapsed since the UE camped on the current serving cell.

Otherwise, cell reselection to a cell on a lower priority E-UTRAN frequency or inter-RAT frequency than the serving frequency shall be performed if:

- The serving cell fulfils $S_{rxlev} < Thresh_{Serving, LowP}$ and a cell of a lower priority RAT/ frequency fulfils $S_{rxlev} > Thresh_{X, LowP}$ during a time interval $T_{reselection_{RAT}}$; and
- More than 1 second has elapsed since the UE camped on the current serving cell.

Cell reselection to a higher priority RAT/ frequency shall take precedence over a lower priority RAT/ frequency, if multiple cells of different priorities fulfil the cell reselection criteria.

For cdma2000 RATs, S_{rxlev} is equal to $-FLOOR(-2 \times 10 \times \log_{10} E_c/I_o)$ in units of 0.5 dB, as defined in [18], with E_c/I_o referring to the value measured from the evaluated cell.

For cdma2000 RATs, $Thresh_{X, HighP}$ and $Thresh_{X, LowP}$ are equal to -1 times the values signalled for the corresponding parameters in the system information.

In all the above criteria the value of $T_{reselection_{RAT}}$ is scaled when the UE is in the medium or high mobility state as defined in subclause 5.2.4.3.1. If more than one cell meets the above criteria, the UE shall reselect a cell as follows:

- If the highest-priority frequency is an E-UTRAN frequency, a cell ranked as the best cell among the cells on the highest priority frequency(ies) meeting the criteria according to section 5.2.4.6;
- If the highest-priority frequency is from another RAT, a cell ranked as the best cell among the cells on the highest priority frequency(ies) meeting the criteria of that RAT.

[TS 36.133, clause 4.2.2.5]

If $S_{rxlev} > S_{nonIntraSearchP}$ and $S_{qual} > S_{nonIntraSearchQ}$ then the UE shall search for inter-RAT layers of higher priority at least every $T_{higher_priority_search}$ where $T_{higher_priority_search}$ is described in section 4.2.2

If $S_{rxlev} \leq S_{nonIntraSearchP}$ or $S_{qual} \leq S_{nonIntraSearchQ}$ then the UE shall search for and measure inter-RAT layers of higher, lower priority in preparation for possible reselection. In this scenario, the minimum rate at which the UE is required to search for and measure higher priority inter-RAT layers shall be the same as that defined below for lower priority RATs.

[TS 36.133, clause 4.2.2.5.4]

In order to perform measurement and cell reselection to HRPD cell, the UE shall acquire the timing of HRPD cells.

When the measurement rules indicate that HRPD cells are to be measured, the UE shall measure CDMA2000 HRPD Pilot Strength of HRPD cells in the neighbour cell list at the minimum measurement rate specified in this section.

The parameter ‘Number of HRPD Neighbour Frequency’, which is transmitted on E-UTRAN BCCH, is the number of carriers used for all HRPD cells in the neighbour cell list.

When the E-UTRA serving cell fulfils $S_{rxlev} > S_{nonIntraSearchP}$ and $S_{qual} > S_{nonIntraSearchQ}$, the UE shall search for CDMA2000 HRPD layers of higher priority at least every $T_{higher_priority_search}$ where $T_{higher_priority_search}$ is defined in section 4.2.2.

For CDMA2000 HRPD cells which have been detected, the UE shall measure CDMA2000 HRPD Pilot Strength at least every (Number of HRPD Neighbour Frequency)* $T_{measureHRPD}$, when the E-UTRA serving cell $S_{rxlev} \leq S_{nonIntraSearchP}$ or $S_{qual} \leq S_{nonIntraSearchQ}$.

The UE shall be capable of evaluating that the CDMA2000 HRPD cell has met cell reselection criterion defined in [1] within $T_{evaluateHRPD}$.

Table 4.2.2.5.4-1 gives values of $T_{measureHRPD}$ and $T_{evaluateHRPD}$.

Table 4.2.2.5.4-1: $T_{measureHRPD}$ and $T_{evaluateHRPD}$

DRX cycle length [s]	$T_{measureHRPD}$ [s] (number of DRX cycles)	$T_{evaluateHRPD}$ [s] (number of DRX cycles)
0.32	5.12 (16)	15.36 (48)
0.64	5.12 (8)	15.36 (24)
1.28	6.4 (5)	19.2 (15)
2.56	7.68 (3)	23.04 (9)

If $T_{reselection}$ timer has a non zero value and the CDMA2000 HRPD cell is satisfied with the reselection criteria which are defined in [1], the UE shall evaluate this CDMA2000 HRPD cell for the $T_{reselection}$ time. If this cell remains satisfied with the reselection criteria within this duration, then the UE shall reselect that cell.

6.2.3.8a.3 Test description

6.2.3.8a.3.1 Pre-test conditions

System Simulator:

- Cell 1 for E-UTRAN
- Cell 15 for HRPD with lower reselection priority than Cell 1
- System information combination 6 as defined in TS 36.508 [18] clause 4.4.3.1 is used in E-UTRA cells.

UE:

None.

Preamble:

- The UE is in state Registered, Idle mode (state 2) on Cell 1 (serving cell) according to [18].

6.2.3.8a.3.2 Test procedure sequence

Table 6.2.3.8a.3.2-1 illustrates the downlink power levels and other changing parameters to be applied for the cells at various time instants of the test execution. The configurations marked "T1" and "T2" are applied at the point indicated in the Main behaviour description in Table 6.2.3.8.3.2-2.

Table 6.2.3.8a.3.2-1: Time instances of cell power level and parameter changes

	Parameter	Unit	Cell 1	Cell 15	Remark
T1	$\bar{I}_{or/loc}$	dB	-	-20	Cell 15 is on
	loc	dBm/1.23 MHz	-	-55	
	Pilot E_c/I_o (Note 1)	dB	-	-20	
	Cell-specific RS EPRE	dBm/1.5 kHz	-70	-	$S_{ServingCell}$ of the E-UTRA > $Thresh_{Serving, LowP}$ and $S_{rxlev, HRPD}$ of Cell 15 < $Thresh_{HRPD, LowP}$
	S_{rxlev} (Note 1)	dB	40	-40	
T2	$\bar{I}_{or/loc}$	dB	-	-5	Increase pilot power of HRPD cell such that $S_{nonServingCell, HRPD}$ of Cell 15 > $Thresh_{HRPD, LowP}$
	loc	dBm/1.23 MHz	-	-55	
	Pilot E_c/I_o (Note 1)	dB	-	-6.2	
	Cell-specific RS EPRE	dBm/1.5 kHz	-120	-	
	S_{rxlev} (Note 1)	dB	-10	-12	
Note 1: This parameter is not directly settable, but is derived by calculation from the other parameters set by the SS.					
Note 2: Default value of $Thresh_{Serving, LowP}$ is 0.					

Table 6.2.3.8a.3.2-2: Main behaviour

St	Procedure	Message Sequence		TP	Verdict
		U - S	Message		
1	Cell 15 is on and it has lower reselection priority than Cell 1, according to "T1" in 6.2.3.8a.3.2-1. SS adjusts the serving cell signal level so that E-UTRA serving cell $S_{qual} \leq S_{nonIntraSearchQ}$	-	-	-	-
3	UE performs measurement for Cell 15 at every $T_{measureHRPD}$	-	-	-	-
4	Check: Does the UE transmit an Access Probe on Cell 15 within the next [60s]?	-->	Access Probe	1	F
5	SS adjust HRPD cell signal level to make sure S_{rxlev} of Cell 15 > $Thresh_{HRPD, LowP}$ according to "T2" in 6.2.3.8a.3.2-1.	-	-	-	-
6	Check: Does the UE transmit an Access Probe on Cell 15?	-->	Access Probe	2	P
Note 1: The UE is expected during this time to do measurements on the HRPD cell at least every $T_{measureHRPD}$ but this cannot be easily verified.					

6.2.3.8a.3.3 Specific message contents

Table 6.2.3.8a.3.3-1: SystemInformationBlockType1 to Cell 1 (Preamble and all steps, table 6.2.3.8a.3.2-2)

Information Element	Value/Remark	Comment	Condition
Derivation path: 36.508 table 4.4.3.2			
SystemInformationBlockType1 ::= SEQUENCE {			
cellSelectionInfo SEQUENCE {			
q-Rxlevmin	-55 (-110 dBm)		
q-Rxlevminoffset	Not present		
}			
}			

Table 6.2.3.8a.3.3-2: SystemInformationBlockType3 for Cell 1 (Preamble and all steps, table 6.2.3.8a.3.2-2)

Derivation path: 36.508 table 4.4.3.3-2			
Information Element	Value/Remark	Comment	Condition
SystemInformationBlockType3 ::= SEQUENCE {			
cellReselectionServingFreqInfo SEQUENCE {			
threshServingLow	5 (10dB)		
cellReselectionPriority	4		
}			
lateNonCriticalExtension {			
threshServingLowQ-r9	26		
}			
}			

Table 6.2.3.8a.3.3-3: SystemInformationBlockType8 to Cell 1 (Preamble and all steps, table 6.2.3.8a.3.2-2)

Derivation path: 36.508 table 4.4.3.3			
Information Element	Value/Remark	Comment	Condition
SystemInformationBlockType8 ::= SEQUENCE {			
systemTimeInfo SEQUENCE {			
cdma-EUTRA-Synchronisation	TRUE		
cdma-SystemTime CHOICE {			
synchronousSystemTime	A valid value as per TS 36.331 and calculated by the SS		
}			
}			
searchWindowSize	5		
parametersHRPD SEQUENCE {			HRPD
cellReselectionParametersHRPD SEQUENCE {			
bandClassList SEQUENCE (SIZE (1..maxCDMA - BandClass)) OF SEQUENCE {	The same number of entries as the configured HRPD carriers		
bandClass	Band Class of frequency under test	[Set according to specific test case]	
cellReselectionPriority	3	[3 is applicable when HRPD is lower priority than E-UTRA. 5 is applicable when HRPD is higher priority than E-UTRA]	
threshX-High	30[-30]	INTEGER (0..63)	
threshX-Low	32[-32]	INTEGER (0..63)	
}			
t-ReselectionCDMA2000	7	INTEGER (0..7)	
}			
}			

6.2.3.9 Inter-RAT Cell Reselection: from E-UTRA RRC_IDLE to CDMA2000 1xRTT Dormant– When CDMA2000 1xRTT cell is higher reselection priority than E-UTRA

6.2.3.9.1 Test Purpose (TP)

(1)

with { UE in E-UTRA RRC_IDLE and UE detects a 1xRTT cell with higher reselection priority than E-UTRAN serving cell }
ensure that {

```

when { SnonServingCell,CDMA2000_1x <= Thresh1xRTT, high }
  then { UE does not reselect the CDMA2000 1xRTT cell }
}

```

(2)

```

with { UE in E-UTRA RRC_IDLE and UE detects a 1xRTT cell with higher reselection priority than E-UTRA serving cell }
ensure that {
  when { SnonServingCell,CDMA2000_1x > Thresh1xRTT, high }
    then { UE reselects the CDMA2000 1xRTT cell }
}

```

6.2.3.9.2 Conformance requirements

References: The conformance requirements covered in the present TC are specified in: TS 36.304, clause 5.2.4.1, 5.2.4.2 and 5.2.4.5 and TS 36.133, clause 4.2.2.5 and 4.2.2.5.4.

[TS 36.304, clause 5.2.4.1]

Absolute priorities of different E-UTRAN frequencies or inter-RAT frequencies may be provided to the UE in the system information, in the *RRConnectionRelease* message, or by inheriting from another RAT at inter-RAT cell (re)selection. In the case of system information, an E-UTRAN frequency or inter-RAT frequency may be listed without providing a priority (i.e. the field *cellReselectionPriority* is absent for that frequency). If priorities are provided in dedicated signalling, the UE shall ignore all the priorities provided in system information. If UE is in *camped on any cell* state, UE shall only apply the priorities provided by system information from current cell, and the UE preserves priorities provided by dedicated signalling unless specified otherwise. When the UE in *camped normally* state, has only dedicated priorities other than for the current frequency, the UE shall consider the current frequency to be the lowest priority frequency (i.e. lower than the eight network configured values). While the UE is camped on a suitable CSG cell, the UE shall always consider the current frequency to be the highest priority frequency (i.e. higher than the eight network configured values), irrespective of any other priority value allocated to this frequency. The UE shall delete priorities provided by dedicated signalling when:

- the UE enters RRC_CONNECTED state; or
- the optional validity time of dedicated priorities (T320) expires; or
- a PLMN selection is performed on request by NAS [5].

NOTE: Equal priorities between RATs are not supported.

The UE shall only perform cell reselection evaluation for E-UTRAN frequencies and inter-RAT frequencies that are given in system information and for which the UE has a priority provided.

The UE shall not consider any black listed cells as candidate for cell reselection.

The UE shall inherit the priorities provided by dedicated signalling and the remaining validity time (i.e., T320 in E-UTRA, T322 in UTRA and T3230 in GERAN), if configured, at inter-RAT cell (re)selection.

NOTE: The network may assign dedicated cell reselection priorities for frequencies not configured by system information.

[TS 36.304, clause 5.2.4.5]

If *Thresh_{X-Q}* is provided, cell reselection to a cell on a higher priority E-UTRAN frequency or inter-RAT frequency than the serving frequency shall be performed if:

- A cell of a higher priority RAT/ frequency fulfils $S_{qual} > Thresh_{X, HighQ}$ during a time interval $T_{reselection_{RAT}}$; and
- More than 1 second has elapsed since the UE camped on the current serving cell.

Otherwise, cell reselection to a cell on a higher priority E-UTRAN frequency or inter-RAT frequency than the serving frequency shall be performed if:

- A cell of a higher priority RAT/ frequency fulfils $S_{rxlev} > Thresh_{X, HighP}$ during a time interval $T_{reselection_{RAT}}$; and

- More than 1 second has elapsed since the UE camped on the current serving cell.

Cell reselection to a cell on an equal priority E-UTRAN frequency shall be based on ranking for Intra-frequency cell reselection as defined in sub-clause 5.2.4.6.

If $ThreshX-Q$ is provided, cell reselection to a cell on a lower priority E-UTRAN frequency or inter-RAT frequency than the serving frequency shall be performed if:

- The serving cell fulfils $Squal < Thresh_{Serving, LowQ}$ and a cell of a lower priority RAT/ frequency fulfils $Squal > Thresh_{X, LowQ}$ during a time interval $T_{reselection_{RAT}}$; and
- More than 1 second has elapsed since the UE camped on the current serving cell.

Otherwise, cell reselection to a cell on a lower priority E-UTRAN frequency or inter-RAT frequency than the serving frequency shall be performed if:

- The serving cell fulfils $Srxlev < Thresh_{Serving, LowP}$ and a cell of a lower priority RAT/ frequency fulfils $Srxlev > Thresh_{X, LowP}$ during a time interval $T_{reselection_{RAT}}$; and
- More than 1 second has elapsed since the UE camped on the current serving cell.

Cell reselection to a higher priority RAT/ frequency shall take precedence over a lower priority RAT/ frequency, if multiple cells of different priorities fulfil the cell reselection criteria.

For cdma2000 RATs, $Srxlev$ is equal to $-FLOOR(-2 \times 10 \times \log_{10} Ec/Io)$ in units of 0.5 dB, as defined in [18], with Ec/Io referring to the value measured from the evaluated cell.

For cdma2000 RATs, $Thresh_{X, HighP}$ and $Thresh_{X, LowP}$ are equal to -1 times the values signalled for the corresponding parameters in the system information.

In all the above criteria the value of $T_{reselection_{RAT}}$ is scaled when the UE is in the medium or high mobility state as defined in subclause 5.2.4.3.1. If more than one cell meets the above criteria, the UE shall reselect a cell as follows:

- If the highest-priority frequency is an E-UTRAN frequency, a cell ranked as the best cell among the cells on the highest priority frequency(ies) meeting the criteria according to section 5.2.4.6;
- If the highest-priority frequency is from another RAT, a cell ranked as the best cell among the cells on the highest priority frequency(ies) meeting the criteria of that RAT.

[TS 36.133, clause 4.2.2.5]

If $Srxlev > S_{nonIntraSearchP}$ and $Squal > S_{nonIntraSearchQ}$ then the UE shall search for inter-RAT layers of higher priority at least every $T_{higher_priority_search}$ where $T_{higher_priority_search}$ is described in section 4.2.2

If $Srxlev \leq S_{nonIntraSearchP}$ or $Squal \leq S_{nonIntraSearchQ}$ then the UE shall search for and measure inter-RAT layers of higher, lower priority in preparation for possible reselection. In this scenario, the minimum rate at which the UE is required to search for and measure higher priority inter-RAT layers shall be the same as that defined below for lower priority RATs.

[TS 36.133, clause 4.2.2.5.5]

In order to perform measurement and cell reselection to cdma2000 1X cell, the UE shall acquire the timing of cdma2000 1X cells.

When the measurement rules indicate that cdma2000 1X cells are to be measured, the UE shall measure cdma2000 1x RTT Pilot Strength of cdma2000 1X cells in the neighbour cell list at the minimum measurement rate specified in this section.

The parameter 'Number of CDMA2000 1X Neighbour Frequency', which is transmitted on E-UTRAN BCCH, is the number of carriers used for all cdma2000 1X cells in the neighbour cell list.

If $S_{ServingCell}$ of the E-UTRA serving cell is greater than $S_{nonintraSearch}$, the UE shall search for cdma2000 1X layers of higher priority at least every $T_{higher_priority_search}$ where $T_{higher_priority_search}$ is defined in section 4.2.2.

For CDMA2000 1X cells which have been detected, the UE shall measure CDMA2000 1xRTT Pilot Strength at least every (Number of CDMA2000 1X Neighbour Frequency)* $T_{\text{measureCDMA2000_1X}}$, when the $S_{\text{ServingCell}}$ of the E-UTRA serving cell is less than or equal to $S_{\text{nonintrasearch}}$.

The UE shall be capable of evaluating that the cdma2000 1X cell has met cell reselection criterion defined in [1] within $T_{\text{evaluateCDMA2000_1X}}$.

Table 4.2.2.5.5-1 gives values of $T_{\text{measureCDMA2000_1X}}$ and $T_{\text{evaluateCDMA2000_1X}}$.

Table 4.2.2.5.5-1: $T_{\text{measureCDMA2000_1X}}$ and $T_{\text{evaluateCDMA2000_1X}}$

DRX cycle length [s]	$T_{\text{measureCDMA2000_1X}}$ [s] (number of DRX cycles)	$T_{\text{evaluateCDMA2000_1X}}$ [s] (number of DRX cycles)
0.32	5.12 (16)	15.36 (48)
0.64	5.12 (8)	15.36 (24)
1.28	6.4 (5)	19.2 (15)
2.56	7.68 (3)	23.04 (9)

If $T_{\text{reselection}}$ timer has a non zero value and the CDMA2000 1X cell is better ranked than the serving cell, the UE shall evaluate this CDMA2000 1X cell for the $T_{\text{reselection}}$ time. If this cell remains better ranked within this duration, then the UE shall reselect that cell.

6.2.3.9.3 Test description

6.2.3.9.3.1 Pre-test conditions

System Simulator:

- Cell 1 for E-UTRAN
- Cell 19 for CDMA2000 1xRTT with higher reselection priority than Cell 1
- System information combination 46 as defined in TS 36.508 [18] clause 4.4.3.1 is used in E-UTRA cells.

UE:

None.

Preamble:

- The UE is in state Registered, Idle mode (state 2) on Cell 1 according to [18].

6.2.3.9.3.2 Test procedure sequence

Table 6.2.3.9.3.2-1 illustrates the downlink power levels and other changing parameters to be applied for the cells at various time instants of the test execution. Row marked "T0" denotes the initial conditions, while rows marked "T1" and "T2" are to be applied subsequently. The exact instants on which these values shall be applied are described in the texts in this clause.

Table 6.2.3.9.3.2-1: Time instances of cell power level and parameter changes

	Parameter	Unit	Cell 1	Cell 19	Remark
T0	Cell-specific RS EPRE	dBm/15 KHz	-75	-	The power levels are such that camping on Cell 1 is guaranteed.
T1	Cell-specific RS EPRE	dBm/15 KHz	-75		Cell 19 is on
	\hat{I}_{or}/I_{oc}	dB		-15	
	Pilot Ec/ Ior			-7	
	Ioc	dBm	-	-75	
	Pilot Ec/ Io (Note 1)	dB	-	-22	
T2	Cell-specific RS EPRE	dBm/15 KHz	-75		Increase pilot power of 1xRTT cell such that $S_{nonServingCell, 1xRTT}$ of Cell 19 > $Thresh_{1xRTT, high}$
	\hat{I}_{or}/I_{oc}	dB		0	
	Pilot Ec/ Ior	dB	-	-7	
	Ioc	dBm/1.23 MHz	-	-75	
	Pilot Ec/ Io (Note 1)	dB	-	-10	

Note 1: This parameter is not directly settable, but is derived by calculation from the other parameters set by the SS.

Table 6.2.3.9.3.2-2: Main behaviour

St	Procedure	Message Sequence		TP	Verdict
		U - S	Message		
1	Cell 19 is on and it has higher reselection priority than Cell1, according to "T1" in 6.2.3.9.3.2-1	-	-	-	-
2	Void	-	-	-	-
3	Check: Does the UE transmit an Access Probe on Cell 19 within the next 60s?	-->	Access Probe	1	F
4	SS adjust CDMA2000 1xRTT cell signal level to make sure $S_{nonServingCell, 1xRTT}$ of Cell 19 > $Thresh_{1xRTT, high}$, according to "T2" in 6.2.3.9.3.2-1	-	-	-	-
5	Check: Does the UE transmit an Access Probe on Cell 19?	-->	Access Probe	2	P

6.2.3.9.3.3 Specific message contents

Table 6.2.3.9.3.3-1: SystemInformationBlockType1 to Cell 1 (Preamble and all steps, table 6.2.3.9.3.2-1)

Derivation path: 36.508 table clause 4.4.3.2			
Information Element	Value/Remark	Comment	Condition
SystemInformationBlockType1 ::= SEQUENCE {			
cellSelectionInfo SEQUENCE {			
q-Rxlevmin	-55 (-110 dBm)		
q-Rxlevminoffset	Not present		
}			
}			

Table 6.2.3.9.3.3-2: SystemInformationBlockType8 to Cell 1 (Preamble and all steps, table 6.2.3.9.3.2-1)

Derivation path: 36.508 table 4.4.3.3			
Information Element	Value/Remark	Comment	Condition
SystemInformationBlockType8 ::= SEQUENCE {			
systemTimeInfo SEQUENCE {			
cdma-EUTRA-Synchronisation	TRUE		
cdma-SystemTime CHOICE {			
synchronousSystemTime	A valid value as per TS 36.331 and calculated by the SS		
}			
}			
searchWindowSize	5		
parameters1XRTT SEQUENCE {			1XRTT
cellReselectionParameters1XRTT SEQUENCE {			
bandClassList SEQUENCE (SIZE (1..maxCDMA - BandClass)) OF SEQUENCE {	The same number of entries as the configured 1xRTT carriers		
bandClass	Band Class of frequency under test	ENUMERATED { bc0, bc1, bc2, bc3, bc4, bc5, bc6, bc7, bc8, bc9, bc10, bc11, bc12, bc13, bc14, bc15, bc16, bc17, spare14, spare13, spare12, spare11, spare10, spare9, spare8, spare7, spare6, spare5, spare4, spare3, spare2, spare1, ... }	
cellReselectionPriority	5	[3 is applicable when 1xRTT is lower priority than E-UTRA. 5 is applicable when 1xRTT is higher priority than E-UTRA]	
threshX-High	30(-30)	INTEGER (0..63)	
threshX-Low	32(-32)	INTEGER (0..63)	
}			
t-ReselectionCDMA2000	7	INTEGER (0..7)	
}			
}			
}			

6.2.3.9a Inter-RAT cell reselection / From E-UTRA RRC_IDLE to 1xRTT Dormant / 1xRTT cell is higher reselection priority than E-UTRA ($Srxlev > Thresh_{1xRTT, HighP}$)

6.2.3.9a.1 Test Purpose (TP)

(1)

```
with { UE in E-UTRA RRC_IDLE }
ensure that {
  when { UE detects a 1xRTT cell with higher reselection priority than the E-UTRAN serving cell }
  then { UE does not reselect the 1xRTT cell }
}
```

Note: The UE is expected during this time to do measurements on the 1xRTT cell at least every $T_{higher_priority_search}$ but this cannot be easily verified.

(2)

```

with { UE in E-UTRA RRC_IDLE having detected a 1xRTT cell with higher reselection priority than the
E-UTRAN serving cell } ensure that {
  when { Srxlev,CDMA2000_1x > Thresh1xRTT, HighP }
  then { UE reselects the CDMA2000 1xRTT cell }
}

```

6.2.3.9a.2 Conformance requirements

References: The conformance requirements covered in the present TC are specified in: TS 36.304, clause 5.2.4.1, 5.2.4.2 and 5.2.4.5 and TS 36.133, clause 4.2.2.5 and 4.2.2.5.4.

[TS 36.304, clause 5.2.4.1]

Absolute priorities of different E-UTRAN frequencies or inter-RAT frequencies may be provided to the UE in the system information, in the *RRCConnectionRelease* message, or by inheriting from another RAT at inter-RAT cell (re)selection. In the case of system information, an E-UTRAN frequency or inter-RAT frequency may be listed without providing a priority (i.e. the field *cellReselectionPriority* is absent for that frequency). If priorities are provided in dedicated signalling, the UE shall ignore all the priorities provided in system information. If UE is in *camped on any cell* state, UE shall only apply the priorities provided by system information from current cell, and the UE preserves priorities provided by dedicated signalling unless specified otherwise. When the UE in *camped normally* state, has only dedicated priorities other than for the current frequency, the UE shall consider the current frequency to be the lowest priority frequency (i.e. lower than the eight network configured values). While the UE is camped on a suitable CSG cell, the UE shall always consider the current frequency to be the highest priority frequency (i.e. higher than the eight network configured values), irrespective of any other priority value allocated to this frequency. The UE shall delete priorities provided by dedicated signalling when:

- the UE enters RRC_CONNECTED state; or
- the optional validity time of dedicated priorities (T320) expires; or
- a PLMN selection is performed on request by NAS [5].

NOTE: Equal priorities between RATs are not supported.

The UE shall only perform cell reselection evaluation for E-UTRAN frequencies and inter-RAT frequencies that are given in system information and for which the UE has a priority provided.

The UE shall not consider any black listed cells as candidate for cell reselection.

The UE shall inherit the priorities provided by dedicated signalling and the remaining validity time (i.e., T320 in E-UTRA, T322 in UTRA and T3230 in GERAN), if configured, at inter-RAT cell (re)selection.

NOTE: The network may assign dedicated cell reselection priorities for frequencies not configured by system information.

[TS 36.304, clause 5.2.4.5]

If *threshServingLowQ* is provided in *SystemInformationBlockType3*, cell reselection to a cell on a higher priority E-UTRAN frequency or inter-RAT frequency than the serving frequency shall be performed if:

- A cell of a higher priority EUTRAN or UTRAN FDD RAT/ frequency fulfils $Squal > Thresh_{X, HighQ}$ during a time interval $T_{reselection_{RAT}}$; or
- A cell of a higher priority UTRAN TDD, GERAN or CDMA2000 RAT/ frequency fulfils $Srxlev > Thresh_{X, HighP}$ during a time interval $T_{reselection_{RAT}}$; and
- More than 1 second has elapsed since the UE camped on the current serving cell.

Otherwise, cell reselection to a cell on a higher priority E-UTRAN frequency or inter-RAT frequency than the serving frequency shall be performed if:

- A cell of a higher priority RAT/ frequency fulfils $Srxlev > Thresh_{X, HighP}$ during a time interval $T_{reselection_{RAT}}$; and
- More than 1 second has elapsed since the UE camped on the current serving cell.

Cell reselection to a cell on an equal priority E-UTRAN frequency shall be based on ranking for Intra-frequency cell reselection as defined in sub-clause 5.2.4.6.

If *threshServingLowQ* is provided in *SystemInformationBlockType3*, cell reselection to a cell on a lower priority E-UTRAN frequency or inter-RAT frequency than the serving frequency shall be performed if:

- The serving cell fulfils $S_{qual} < Thresh_{Serving, LowQ}$ and a cell of a lower priority EUTRAN or UTRAN FDD RAT/ frequency fulfils $S_{qual} > Thresh_{X, LowQ}$ during a time interval $T_{reselection_{RAT}}$; or
- The serving cell fulfils $S_{qual} < Thresh_{Serving, LowQ}$ and a cell of a lower priority UTRAN TDD, GERAN or CDMA2000 RAT/ frequency fulfils $S_{rxlev} > Thresh_{X, LowP}$ during a time interval $T_{reselection_{RAT}}$; and
- More than 1 second has elapsed since the UE camped on the current serving cell.

Otherwise, cell reselection to a cell on a lower priority E-UTRAN frequency or inter-RAT frequency than the serving frequency shall be performed if:

- The serving cell fulfils $S_{rxlev} < Thresh_{Serving, LowP}$ and a cell of a lower priority RAT/ frequency fulfils $S_{rxlev} > Thresh_{X, LowP}$ during a time interval $T_{reselection_{RAT}}$; and
- More than 1 second has elapsed since the UE camped on the current serving cell.

Cell reselection to a higher priority RAT/ frequency shall take precedence over a lower priority RAT/ frequency, if multiple cells of different priorities fulfil the cell reselection criteria.

For cdma2000 RATs, S_{rxlev} is equal to $-FLOOR(-2 \times 10 \times \log_{10} E_c/I_o)$ in units of 0.5 dB, as defined in [18], with E_c/I_o referring to the value measured from the evaluated cell.

For cdma2000 RATs, $Thresh_{X, HighP}$ and $Thresh_{X, LowP}$ are equal to -1 times the values signalled for the corresponding parameters in the system information.

In all the above criteria the value of $T_{reselection_{RAT}}$ is scaled when the UE is in the medium or high mobility state as defined in subclause 5.2.4.3.1. If more than one cell meets the above criteria, the UE shall reselect a cell as follows:

- If the highest-priority frequency is an E-UTRAN frequency, a cell ranked as the best cell among the cells on the highest priority frequency(ies) meeting the criteria according to section 5.2.4.6;
- If the highest-priority frequency is from another RAT, a cell ranked as the best cell among the cells on the highest priority frequency(ies) meeting the criteria of that RAT.

[TS 36.133, clause 4.2.2.5]

If $S_{rxlev} > S_{nonIntraSearchP}$ and $S_{qual} > S_{nonIntraSearchQ}$ then the UE shall search for inter-RAT layers of higher priority at least every $T_{higher_priority_search}$ where $T_{higher_priority_search}$ is described in section 4.2.2

If $S_{rxlev} \leq S_{nonIntraSearchP}$ or $S_{qual} \leq S_{nonIntraSearchQ}$ then the UE shall search for and measure inter-RAT layers of higher, lower priority in preparation for possible reselection. In this scenario, the minimum rate at which the UE is required to search for and measure higher priority inter-RAT layers shall be the same as that defined below for lower priority RATs.

[TS 36.133, clause 4.2.2.5.5]

In order to perform measurement and cell reselection to cdma2000 1X cell, the UE shall acquire the timing of cdma2000 1X cells.

When the measurement rules indicate that cdma2000 1X cells are to be measured, the UE shall measure cdma2000 1x RTT Pilot Strength of cdma2000 1X cells in the neighbour cell list at the minimum measurement rate specified in this section.

The parameter 'Number of CDMA2000 1X Neighbour Frequency', which is transmitted on E-UTRAN BCCH, is the number of carriers used for all cdma2000 1X cells in the neighbour cell list.

When the E-UTRA serving cell fulfils $S_{rxlev} > S_{nonIntraSearchP}$ and $S_{qual} > S_{nonIntraSearchQ}$, the UE shall search for cdma2000 1X layers of higher priority at least every $T_{higher_priority_search}$ where $T_{higher_priority_search}$ is defined in section 4.2.2.

For CDMA2000 1X cells which have been detected, the UE shall measure CDMA2000 1xRTT Pilot Strength at least every (Number of CDMA2000 1X Neighbour Frequency)* $T_{\text{measureCDMA2000_1X}}$, when the E-UTRA serving cell $S_{\text{rxlev}} \leq S_{\text{nonIntraSearchP}}$ or $S_{\text{qual}} \leq S_{\text{nonIntraSearchQ}}$. The UE shall be capable of evaluating that the cdma2000 1X cell has met cell reselection criterion defined in [1] within $T_{\text{evaluateCDMA2000_1X}}$.

Table 4.2.2.5.5-1 gives values of $T_{\text{measureCDMA2000_1X}}$ and $T_{\text{evaluateCDMA2000_1X}}$.

Table 4.2.2.5.5-1: $T_{\text{measureCDMA2000_1X}}$ and $T_{\text{evaluateCDMA2000_1X}}$

DRX cycle length [s]	$T_{\text{measureCDMA2000_1X}}$ [s] (number of DRX cycles)	$T_{\text{evaluateCDMA2000_1X}}$ [s] (number of DRX cycles)
0.32	5.12 (16)	15.36 (48)
0.64	5.12 (8)	15.36 (24)
1.28	6.4 (5)	19.2 (15)
2.56	7.68 (3)	23.04 (9)

If $T_{\text{reselection}}$ timer has a non zero value and the CDMA2000 1X cell is satisfied with the reselection criteria which are defined in [1], the UE shall evaluate this CDMA2000 1X cell for the $T_{\text{reselection}}$ time. If this cell remains satisfied with the reselection criteria within this duration, then the UE shall reselect that cell.

6.2.3.9a.3 Test description

6.2.3.9a.3.1 Pre-test conditions

System Simulator:

- Cell 1 for E-UTRAN
- Cell 19 for CDMA2000 1xRTT with higher reselection priority than Cell 1
- System information combination 46 as defined in TS 36.508 [18] clause 4.4.3.1 is used in E-UTRA cells.

UE:

None.

Preamble:

- The UE is in state Registered, Idle mode (state 2) on Cell 1 according to [18].

6.2.3.9a.3.2 Test procedure sequence

Table 6.2.3.9.3.2-1 illustrates the downlink power levels and other changing parameters to be applied for the cells at various time instants of the test execution. Row marked "T0" denotes the initial conditions, while rows marked "T1" and "T2" are to be applied subsequently. The exact instants on which these values shall be applied are described in the texts in this clause.

Table 6.2.3.9a.3.2-1: Time instances of cell power level and parameter changes

	Parameter	Unit	Cell 1	Cell 19	Remark
T0	Cell-specific RS EPRE	dBm/15 KHz	-75	-	The power levels are such that camping on Cell 1 is guaranteed.
T1	Cell-specific RS EPRE	dBm/15 KHz	-75		Cell 19 is on
	$\hat{I}_{or/loc}$	dB		-15	
	Pilot Ec/ Ior			-7	
	loc	dBm	-	-75	
	Pilot Ec/ Io (Note 1)	dB	-	-22	
T2	Cell-specific RS EPRE	dBm/15 KHz	-75		Increase pilot power of 1xRTT cell such that $S_{nonServingCell}$, of Cell 19 > $Thresh_{1xRTT, HighP}$
	$\hat{I}_{or/loc}$	dB		0	
	Pilot Ec/ Ior	dB	-	-7	
	loc	dBm/1.23 MHz	-	-75	
	Pilot Ec/ Io (Note 1)	dB	-	-10	

Note 1: This parameter is not directly settable, but is derived by calculation from the other parameters set by the SS.

Table 6.2.3.9a.3.2-2: Main behaviour

St	Procedure	Message Sequence		TP	Verdict
		U - S	Message		
1	Cell 19 is on and it has higher reselection priority than Cell1, according to "T1" in 6.2.3.9a.3.2-1	-	-	-	-
2	UE performs measurement for Cell 19 at every $T_{higher_priority_search}$	-	-	-	-
3	Check: Does the UE transmit an Access Probe on Cell 19 within the next [60s]?	-->	Access Probe	1	F
4	SS adjust CDMA2000 1xRTT cell signal level to make sure S_{rxlev} of Cell 19 > $Thresh_{1xRTT, HighP}$, according to "T2" in 6.2.3.9a.3.2-1	-	-	-	-
5	Check: Does the UE transmit an Access Probe on Cell 19?	-->	Access Probe	2	P

Note 1: The UE is expected during this time to do measurements on the HRPD cell at least every $T_{higher_priority_search}$ but this cannot be easily verified.

6.2.3.9a.3.3 Specific message contents

Table 6.2.3.9a.3.3-1: SystemInformationBlockType1 to Cell 1 (Preamble and all steps, table 6.2.3.9a.3.2-2)

Derivation path: 36.508 table clause 4.4.3.2			
Information Element	Value/Remark	Comment	Condition
SystemInformationBlockType1 ::= SEQUENCE {			
cellSelectionInfo SEQUENCE {			
q-Rxlevmin	-55 (-110 dBm)		
q-Rxlevminoffset	Not present		
}			
}			

Table 6.2.3.9a.3.3-2: Void

Table 6.2.3.9a.3.3-3: *SystemInformationBlockType8* to Cell 1 (Preamble and all steps, table 6.2.3.9a.3.2-2)

Derivation path: 36.508 table 4.4.3.3			
Information Element	Value/Remark	Comment	Condition
SystemInformationBlockType8 ::= SEQUENCE {			
systemTimeInfo SEQUENCE {			
cdma-EUTRA-Synchronisation	TRUE		
cdma-SystemTime CHOICE {			
synchronousSystemTime	A valid value as per TS 36.331 and calculated by the SS		
}			
}			
searchWindowSize	5		
parameters1XRTT SEQUENCE {			1XRTT
cellReselectionParameters1XRTT SEQUENCE {			
bandClassList SEQUENCE (SIZE (1..maxCDMA - BandClass)) OF SEQUENCE {	The same number of entries as the configured 1xRTT carriers		
bandClass	Band Class of frequency under test	ENUMERATED { bc0, bc1, bc2, bc3, bc4, bc5, bc6, bc7, bc8, bc9, bc10, bc11, bc12, bc13, bc14, bc15, bc16, bc17, spare14, spare13, spare12, spare11, spare10, spare9, spare8, spare7, spare6, spare5, spare4, spare3, spare2, spare1, ...}	
cellReselectionPriority	5	[3 is applicable when 1xRTT is lower priority than E-UTRA. 5 is applicable when 1xRTT is higher priority than E-UTRA]	
threshX-High	30(-30)	INTEGER (0..63)	
threshX-Low	32(-32)	INTEGER (0..63)	
}			
t-ReselectionCDMA2000	7	INTEGER (0..7)	
}			
}			
}			
}			

6.2.3.10 Inter-RAT Cell Reselection: from E-UTRA RRC_IDLE to CDMA2000 1xRTT Idle – When CDMA2000 1xRTT is lower reselection priority than E-UTRA

6.2.3.10.1 Test Purpose (TP)

(1)

```

with { UE in E-UTRA RRC_IDLE state and UE detects the cell re-selection criteria that CDMA2000 1xRTT cell is equal to or lower reselection priority than E-UTRAN serving cell }
ensure that {
  When{ SservicingCell <= Snonintrasearch }
  then { UE searches for and measures CDMA2000 1xRTT cell at least every TmeasureCDMA2000_1X }
  when { SnonServicingCell,1xRTT > Thresh1xRTT, low }
  then { UE reselects the CDMA2000 1xRTT cell }
}

```

}

6.2.3.10.2 Conformance requirements

References: The conformance requirements covered in the present TC are specified in: TS 36.304, clause 5.2.4.1, 5.2.4.2 and 5.2.4.5 and TS 36.133, clause 4.2.2.5 and 4.2.2.5.4.

[TS 36.304, clause 5.2.4.1]

Absolute priorities of different E-UTRAN frequencies or inter-RAT frequencies may be provided to the UE in the system information, in the *RRConnectionRelease* message, or by inheriting from another RAT at inter-RAT cell (re)selection. In the case of system information, an E-UTRAN frequency or inter-RAT frequency may be listed without providing a priority (i.e. the field *cellReselectionPriority* is absent for that frequency). If priorities are provided in dedicated signalling, the UE shall ignore all the priorities provided in system information. If UE is in *camped on any cell* state, UE shall only apply the priorities provided by system information from current cell, and the UE preserves priorities provided by dedicated signalling unless specified otherwise. When the UE in *camped normally* state, has only dedicated priorities other than for the current frequency, the UE shall consider the current frequency to be the lowest priority frequency (i.e. lower than the eight network configured values). While the UE is camped on a suitable CSG cell, the UE shall always consider the current frequency to be the highest priority frequency (i.e. higher than the eight network configured values), irrespective of any other priority value allocated to this frequency. The UE shall delete priorities provided by dedicated signalling when:

- the UE enters RRC_CONNECTED state; or
- the optional validity time of dedicated priorities (T320) expires; or
- a PLMN selection is performed on request by NAS [5].

NOTE: Equal priorities between RATs are not supported.

The UE shall only perform cell reselection evaluation for E-UTRAN frequencies and inter-RAT frequencies that are given in system information and for which the UE has a priority provided.

The UE shall not consider any black listed cells as candidate for cell reselection.

The UE shall inherit the priorities provided by dedicated signalling and the remaining validity time (i.e., T320 in E-UTRA, T322 in UTRA and T3230 in GERAN), if configured, at inter-RAT cell (re)selection.

NOTE: The network may assign dedicated cell reselection priorities for frequencies not configured by system information.

[TS 36.304, clause 5.2.4.5]

If *ThreshX-Q* is provided, cell reselection to a cell on a higher priority E-UTRAN frequency or inter-RAT frequency than the serving frequency shall be performed if:

- A cell of a higher priority RAT/ frequency fulfils $S_{qual} > Thresh_{X, HighQ}$ during a time interval $T_{reselection_{RAT}}$; and
- More than 1 second has elapsed since the UE camped on the current serving cell.

Otherwise, cell reselection to a cell on a higher priority E-UTRAN frequency or inter-RAT frequency than the serving frequency shall be performed if:

- A cell of a higher priority RAT/ frequency fulfils $S_{rxlev} > Thresh_{X, HighP}$ during a time interval $T_{reselection_{RAT}}$; and
- More than 1 second has elapsed since the UE camped on the current serving cell.

Cell reselection to a cell on an equal priority E-UTRAN frequency shall be based on ranking for Intra-frequency cell reselection as defined in sub-clause 5.2.4.6.

If *ThreshX-Q* is provided, cell reselection to a cell on a lower priority E-UTRAN frequency or inter-RAT frequency than the serving frequency shall be performed if:

- The serving cell fulfils $S_{qual} < \text{Thresh}_{\text{Serving, LowQ}}$ and a cell of a lower priority RAT/ frequency fulfils $S_{qual} > \text{Thresh}_{X, \text{LowQ}}$ during a time interval $T_{\text{reselection}_{\text{RAT}}}$; and
- More than 1 second has elapsed since the UE camped on the current serving cell.

Otherwise, cell reselection to a cell on a lower priority E-UTRAN frequency or inter-RAT frequency than the serving frequency shall be performed if:

- The serving cell fulfils $S_{rxlev} < \text{Thresh}_{\text{Serving, LowP}}$ and a cell of a lower priority RAT/ frequency fulfils $S_{rxlev} > \text{Thresh}_{X, \text{LowP}}$ during a time interval $T_{\text{reselection}_{\text{RAT}}}$; and
- More than 1 second has elapsed since the UE camped on the current serving cell.

Cell reselection to a higher priority RAT/ frequency shall take precedence over a lower priority RAT/ frequency, if multiple cells of different priorities fulfil the cell reselection criteria.

For cdma2000 RATs, S_{rxlev} is equal to $-\text{FLOOR}(-2 \times 10 \times \log_{10} E_c/I_o)$ in units of 0.5 dB, as defined in [18], with E_c/I_o referring to the value measured from the evaluated cell.

For cdma2000 RATs, $\text{Thresh}_{X, \text{HighP}}$ and $\text{Thresh}_{X, \text{LowP}}$ are equal to -1 times the values signalled for the corresponding parameters in the system information.

In all the above criteria the value of $T_{\text{reselection}_{\text{RAT}}}$ is scaled when the UE is in the medium or high mobility state as defined in subclause 5.2.4.3.1. If more than one cell meets the above criteria, the UE shall reselect a cell as follows:

- If the highest-priority frequency is an E-UTRAN frequency, a cell ranked as the best cell among the cells on the highest priority frequency(ies) meeting the criteria according to section 5.2.4.6;
- If the highest-priority frequency is from another RAT, a cell ranked as the best cell among the cells on the highest priority frequency(ies) meeting the criteria of that RAT.

[TS 36.133, clause 4.2.2.5]

If the $S_{\text{ServingCell}}$ of the E-UTRA serving cell (or other cells on the same frequency layer) is greater than $S_{\text{nonIntraSearch}}$, then

- the UE may not search for, or measure inter-RAT layers of equal or lower priority.
- the UE shall search for inter-RAT layers of higher priority at least every $T_{\text{higher_priority_search}}$ where $T_{\text{higher_priority_search}}$ is described in section 4.2.2.

If the $S_{\text{ServingCell}}$ of the E-UTRA serving cell is less than or equal to $S_{\text{nonIntraSearch}}$, then the UE shall search for and measure inter-RAT layers of higher, equal or lower priority in preparation for possible reselection. In this scenario, the minimum rate at which the UE is required to search for and measure such layers is not reduced and shall be the same as that defined below for lower priority RATs.

[TS 36.133, clause 4.2.2.5]

If $S_{rxlev} > S_{\text{nonIntraSearchP}}$ and $S_{qual} > S_{\text{nonIntraSearchQ}}$ then the UE shall search for inter-RAT layers of higher priority at least every $T_{\text{higher_priority_search}}$ where $T_{\text{higher_priority_search}}$ is described in section 4.2.2

If $S_{rxlev} \leq S_{\text{nonIntraSearchP}}$ or $S_{qual} \leq S_{\text{nonIntraSearchQ}}$ then the UE shall search for and measure inter-RAT layers of higher, lower priority in preparation for possible reselection. In this scenario, the minimum rate at which the UE is required to search for and measure higher priority inter-RAT layers shall be the same as that defined below for lower priority RATs.

[TS 36.133, clause 4.2.2.5.5]

In order to perform measurement and cell reselection to cdma2000 1X cell, the UE shall acquire the timing of cdma2000 1X cells.

When the measurement rules indicate that cdma2000 1X cells are to be measured, the UE shall measure cdma2000 1x RTT Pilot Strength of cdma2000 1X cells in the neighbour cell list at the minimum measurement rate specified in this section.

The parameter 'Number of CDMA2000 1X Neighbour Frequency', which is transmitted on E-UTRAN BCCH, is the number of carriers used for all cdma2000 1X cells in the neighbour cell list.

If $S_{\text{ServingCell}}$ of the E-UTRA serving cell is greater than $S_{\text{nonintrasearch}}$, the UE shall search for cdma2000 1X layers of higher priority at least every $T_{\text{higher_priority_search}}$ where $T_{\text{higher_priority_search}}$ is defined in section 4.2.2.

For CDMA2000 1X cells which have been detected, the UE shall measure CDMA2000 1xRTT Pilot Strength at least every $(\text{Number of CDMA2000 1X Neighbour Frequency}) \cdot T_{\text{measureCDMA2000_1X}}$, when the $S_{\text{ServingCell}}$ of the E-UTRA serving cell is less than or equal to $S_{\text{nonintrasearch}}$.

The UE shall be capable of evaluating that the cdma2000 1X cell has met cell reselection criterion defined in [1] within $T_{\text{evaluateCDMA2000_1X}}$.

Table 4.2.2.5.5-1 gives values of $T_{\text{measureCDMA2000_1X}}$ and $T_{\text{evaluateCDMA2000_1X}}$.

Table 4.2.2.5.5-1: $T_{\text{measureCDMA2000_1X}}$ and $T_{\text{evaluateCDMA2000_1X}}$

DRX cycle length [s]	$T_{\text{measureCDMA2000_1X}}$ [s] (number of DRX cycles)	$T_{\text{evaluateCDMA2000_1X}}$ [s] (number of DRX cycles)
0.32	5.12 (16)	15.36 (48)
0.64	5.12 (8)	15.36 (24)
1.28	6.4 (5)	19.2 (15)
2.56	7.68 (3)	23.04 (9)

If $T_{\text{reselection}}$ timer has a non zero value and the CDMA2000 1X cell is better ranked than the serving cell, the UE shall evaluate this CDMA2000 1X cell for the $T_{\text{reselection}}$ time. If this cell remains better ranked within this duration, then the UE shall reselect that cell.

6.2.3.10.3 Test description

6.2.3.10.3.1 Pre-test conditions

System Simulator:

- Cell 1 for E-UTRAN
- Cell 19 for CDMA2000 1xRTT with lower reselection priority than Cell 1
- System information combination 6 as defined in TS 36.508 [18] clause 4.4.3.1 is used in E-UTRA cells.

UE:

None.

Preamble:

- The UE is in state Registered, Idle mode (state 2) on Cell 1 according to [18].

6.2.3.10.3.2 Test procedure sequence

Table 6.2.3.10.3.2-1 illustrates the downlink power levels and other changing parameters to be applied for the cells at various time instants of the test execution. Row marked "T0" denotes the initial conditions, while rows marked "T1" and "T2" are to be applied subsequently. The exact instants on which these values shall be applied are described in the texts in this clause.

Table 6.2.3.10.3.2-1: Time instances of cell power level and parameter changes

	Parameter	Unit	Cell 1	Cell 19	Remark
T0	Cell-specific RS EPRE	dBm/15 KHz	-75	-	The power levels are such that camping on Cell 1 is guaranteed.
T1	Cell-specific RS EPRE	dBm/15 KHz	-100	-	Cell 19 is on and $S_{nonServingCell}$, of Cell 19 < $Thresh_{1xRTT, Low}$
	$\hat{I}_{or/loc}$	dB	-	-15	
	Pilot Ec/ Ior			-7	
	Ioc	dBm	-	-75	
	Pilot Ec/ Io (Note 1)	dB	-	-22	
T2	Cell-specific RS EPRE	dBm/15 KHz	-120	-	Increase pilot power of 1xRTT cell such that $S_{nonServingCell}$, of Cell 19 > $Thresh_{1xRTT, Low}$ and $S_{ServingCell}$ of the E-UTRA < $Thresh_{Serving, LowP}$
	$\hat{I}_{or/loc}$	dB	-	0	
	Pilot Ec/ Ior	dB	-	-7	
	Ioc	dBm/1.23 MHz	-	-75	
	Pilot Ec/ Io (Note 1)	dB	-	-10	

Note 1: This parameter is not directly settable, but is derived by calculation from the other parameters set by the SS.
 Note 2: Default value of $Thresh_{Serving, LowP}$ is 0.

Table 6.2.3.10.3.2-2: Main behaviour

St	Procedure	Message Sequence		TP	Verdict
		U - S	Message		
1	Cell 19 is on and it has lower reselection priority than Cell 1, according to "T1" in 6.2.3.10.3.2-1 SS adjust the serving cell signal level so that $S_{ServingCell}$ of the E-UTRA $\leq S_{nonIntrasearch}$	-	-	-	-
2	UE performs measurement for Cell 19 at every $T_{measureCDMA2000_1X}$	-	-		
3	Check: Does the UE transmit an Access Probe on Cell 19 within the next [60s]?	-->	Access Probe	1	F
4	SS adjust CDMA2000 1xRTT Cell 19 signal level to make sure $S_{nonServingCell, 1xRTT}$ of Cell 19 > $Thresh_{1xRTT, low}$, according to "T2" in 6.2.3.10.3.2-1				
5	Check: Does the UE transmit an Access Probe on Cell 19?	-->	Access Probe	1	P

6.2.3.10.3.3 Specific message contents

Table 6.2.3.10.3.3-1: SystemInformationBlockType1 to Cell 1 (Preamble and all steps, table 6.2.3.10.3.2-1)

Derivation path: 36.508 table 4.4.3.2			
Information Element	Value/Remark	Comment	Condition
SystemInformationBlockType1 ::= SEQUENCE {			
cellSelectionInfo SEQUENCE {			
q-Rxlevmin	-55 (-110 dBm)		
q-Rxlevminoffset	Not present		
}			
}			

Table 6.2.3.10.3.3-2: SystemInformationBlockType8 to Cell 1 (Preamble and all steps, table 6.2.3.10.3.2-1)

Derivation path: 36.508 table 4.4.3.3			
Information Element	Value/Remark	Comment	Condition
SystemInformationBlockType8 ::= SEQUENCE {			
systemTimeInfo SEQUENCE {			
cdma-EUTRA-Synchronisation	TRUE		
cdma-SystemTime CHOICE {			
synchronousSystemTime	A valid value as per TS 36.331 and calculated by the SS		
}			
}			
searchWindowSize	5		
parameters1XRTT SEQUENCE {			1XRTT
cellReselectionParameters1XRTT SEQUENCE {			
bandClassList SEQUENCE (SIZE (1..maxCDMA - BandClass)) OF SEQUENCE {	The same number of entries as the configured 1xRTT carriers		
bandClass	Band Class of frequency under test	ENUMERATED { bc0, bc1, bc2, bc3, bc4, bc5, bc6, bc7, bc8, bc9, bc10, bc11, bc12, bc13, bc14, bc15, bc16, bc17, spare14, spare13, spare12, spare11, spare10, spare9, spare8, spare7, spare6, spare5, spare4, spare3, spare2, spare1, ... }	
cellReselectionPriority	3	[3 is applicable when 1xRTT is lower priority than E-UTRA. 5 is applicable when 1xRTT is higher priority than E-UTRA]	
threshX-High	30(-30)	INTEGER (0..63)	
threshX-Low	32(-32)	INTEGER (0..63)	
}			
t-ReselectionCDMA2000	7	INTEGER (0..7)	
}			
}			
}			

6.2.3.10a Inter-RAT cell reselection / From E-UTRA RRC_IDLE to 1xRTT Dormant / 1xRTT cell is lower reselection priority than E-UTRA (Squal < Thresh_{Serving, LowQ} and Srxlev > Thresh_{1xRTT, LowP})

6.2.3.10a.1 Test Purpose (TP)

(1)

```
with { UE in E-UTRA RRC_IDLE }
ensure that {
  when { UE detects a CDMA2000 1xRTT cell with equal or lower reselection priority than the E-UTRAN serving cell }
  then { UE does not reselect the a CDMA2000 1xRTT cell }
```

Note: The UE is expected during this time to do measurements on the CDMA2000 1xRTT cell at least every T_{measureCDMA2000_1x} but this cannot be easily verified

(2)

```

with { UE in E-UTRA RRC_IDLE having detected a HRPD cell with equal or lower reselection priority
than the E-UTRA serving_cell } ensure that {
  when { Srxlev1xRTT > Thresh1xRTT, LowP }
  then { UE reselects the CDMA2000 1xRTT cell }
}

```

6.2.3.10a.2 Conformance requirements

References: The conformance requirements covered in the present TC are specified in: TS 36.304, clause 5.2.4.1, 5.2.4.2 and 5.2.4.5 and TS 36.133, clause 4.2.2.5 and 4.2.2.5.4.

[TS 36.304, clause 5.2.4.1]

Absolute priorities of different E-UTRAN frequencies or inter-RAT frequencies may be provided to the UE in the system information, in the *RRConnectionRelease* message, or by inheriting from another RAT at inter-RAT cell (re)selection. In the case of system information, an E-UTRAN frequency or inter-RAT frequency may be listed without providing a priority (i.e. the field *cellReselectionPriority* is absent for that frequency). If priorities are provided in dedicated signalling, the UE shall ignore all the priorities provided in system information. If UE is in *camped on any cell* state, UE shall only apply the priorities provided by system information from current cell, and the UE preserves priorities provided by dedicated signalling unless specified otherwise. When the UE in *camped normally* state, has only dedicated priorities other than for the current frequency, the UE shall consider the current frequency to be the lowest priority frequency (i.e. lower than the eight network configured values). While the UE is camped on a suitable CSG cell, the UE shall always consider the current frequency to be the highest priority frequency (i.e. higher than the eight network configured values), irrespective of any other priority value allocated to this frequency. The UE shall delete priorities provided by dedicated signalling when:

- the UE enters RRC_CONNECTED state; or
- the optional validity time of dedicated priorities (T320) expires; or
- a PLMN selection is performed on request by NAS [5].

NOTE: Equal priorities between RATs are not supported.

The UE shall only perform cell reselection evaluation for E-UTRAN frequencies and inter-RAT frequencies that are given in system information and for which the UE has a priority provided.

The UE shall not consider any black listed cells as candidate for cell reselection.

The UE shall inherit the priorities provided by dedicated signalling and the remaining validity time (i.e., T320 in E-UTRA, T322 in UTRA and T3230 in GERAN), if configured, at inter-RAT cell (re)selection.

NOTE: The network may assign dedicated cell reselection priorities for frequencies not configured by system information.

[TS 36.304, clause 5.2.4.5]

If *threshServingLowQ* is provided in *SystemInformationBlockType3*, cell reselection to a cell on a higher priority E-UTRAN frequency or inter-RAT frequency than the serving frequency shall be performed if:

- A cell of a higher priority EUTRAN or UTRAN FDD RAT/ frequency fulfils $S_{qual} > Thresh_{X, HighQ}$ during a time interval $T_{reselection_{RAT}}$; or
- A cell of a higher priority UTRAN TDD, GERAN or CDMA2000 RAT/ frequency fulfils $S_{rxlev} > Thresh_{X, HighP}$ during a time interval $T_{reselection_{RAT}}$; and
- More than 1 second has elapsed since the UE camped on the current serving cell.

Otherwise, cell reselection to a cell on a higher priority E-UTRAN frequency or inter-RAT frequency than the serving frequency shall be performed if:

- A cell of a higher priority RAT/ frequency fulfils $S_{rxlev} > Thresh_{X, HighP}$ during a time interval $T_{reselection_{RAT}}$; and

- More than 1 second has elapsed since the UE camped on the current serving cell.

Cell reselection to a cell on an equal priority E-UTRAN frequency shall be based on ranking for Intra-frequency cell reselection as defined in sub-clause 5.2.4.6.

If *threshServingLowQ* is provided in *SystemInformationBlockType3*, cell reselection to a cell on a lower priority E-UTRAN frequency or inter-RAT frequency than the serving frequency shall be performed if:

- The serving cell fulfils $S_{qual} < Thresh_{Serving, LowQ}$ and a cell of a lower priority EUTRAN or UTRAN FDD RAT/ frequency fulfils $S_{qual} > Thresh_{X, LowQ}$ during a time interval $T_{reselection_{RAT}}$; or
- The serving cell fulfils $S_{qual} < Thresh_{Serving, LowQ}$ and a cell of a lower priority UTRAN TDD, GERAN or CDMA2000 RAT/ frequency fulfils $S_{rxlev} > Thresh_{X, LowP}$ during a time interval $T_{reselection_{RAT}}$; and
- More than 1 second has elapsed since the UE camped on the current serving cell.

Otherwise, cell reselection to a cell on a lower priority E-UTRAN frequency or inter-RAT frequency than the serving frequency shall be performed if:

- The serving cell fulfils $S_{rxlev} < Thresh_{Serving, LowP}$ and a cell of a lower priority RAT/ frequency fulfils $S_{rxlev} > Thresh_{X, LowP}$ during a time interval $T_{reselection_{RAT}}$; and
- More than 1 second has elapsed since the UE camped on the current serving cell.

Cell reselection to a higher priority RAT/ frequency shall take precedence over a lower priority RAT/ frequency, if multiple cells of different priorities fulfil the cell reselection criteria.

For cdma2000 RATs, S_{rxlev} is equal to $-FLOOR(-2 \times 10 \times \log_{10} E_c/I_o)$ in units of 0.5 dB, as defined in [18], with E_c/I_o referring to the value measured from the evaluated cell.

For cdma2000 RATs, $Thresh_{X, HighP}$ and $Thresh_{X, LowP}$ are equal to -1 times the values signalled for the corresponding parameters in the system information.

In all the above criteria the value of $T_{reselection_{RAT}}$ is scaled when the UE is in the medium or high mobility state as defined in subclause 5.2.4.3.1. If more than one cell meets the above criteria, the UE shall reselect a cell as follows:

- If the highest-priority frequency is an E-UTRAN frequency, a cell ranked as the best cell among the cells on the highest priority frequency(ies) meeting the criteria according to section 5.2.4.6;
- If the highest-priority frequency is from another RAT, a cell ranked as the best cell among the cells on the highest priority frequency(ies) meeting the criteria of that RAT.

[TS 36.133, clause 4.2.2.5]

If $S_{rxlev} > S_{nonIntraSearchP}$ and $S_{qual} > S_{nonIntraSearchQ}$ then the UE shall search for inter-RAT layers of higher priority at least every $T_{higher_priority_search}$ where $T_{higher_priority_search}$ is described in section 4.2.2

If $S_{rxlev} \leq S_{nonIntraSearchP}$ or $S_{qual} \leq S_{nonIntraSearchQ}$ then the UE shall search for and measure inter-RAT layers of higher, lower priority in preparation for possible reselection. In this scenario, the minimum rate at which the UE is required to search for and measure higher priority inter-RAT layers shall be the same as that defined below for lower priority RATs.

[TS 36.133, clause 4.2.2.5.5]

In order to perform measurement and cell reselection to cdma2000 1X cell, the UE shall acquire the timing of cdma2000 1X cells.

When the measurement rules indicate that cdma2000 1X cells are to be measured, the UE shall measure cdma2000 1x RTT Pilot Strength of cdma2000 1X cells in the neighbour cell list at the minimum measurement rate specified in this section.

The parameter 'Number of CDMA2000 1X Neighbour Frequency', which is transmitted on E-UTRAN BCCH, is the number of carriers used for all cdma2000 1X cells in the neighbour cell list.

When the E-UTRA serving cell fulfils $S_{rxlev} > S_{nonIntraSearchP}$ and $S_{qual} > S_{nonIntraSearchQ}$, the UE shall search for cdma2000 1X layers of higher priority at least every $T_{higher_priority_search}$ where $T_{higher_priority_search}$ is defined in section 4.2.2.

For CDMA2000 1X cells which have been detected, the UE shall measure CDMA2000 1xRTT Pilot Strength at least every (Number of CDMA2000 1X Neighbour Frequency)* $T_{\text{measureCDMA2000_1X}}$, when the E-UTRA serving cell $S_{\text{rxlev}} \leq S_{\text{nonIntraSearchP}}$ or $S_{\text{qual}} \leq S_{\text{nonIntraSearchQ}}$. The UE shall be capable of evaluating that the cdma2000 1X cell has met cell reselection criterion defined in [1] within $T_{\text{evaluateCDMA2000_1X}}$.

Table 4.2.2.5.5-1 gives values of $T_{\text{measureCDMA2000_1X}}$ and $T_{\text{evaluateCDMA2000_1X}}$.

Table 4.2.2.5.5-1: $T_{\text{measureCDMA2000_1X}}$ and $T_{\text{evaluateCDMA2000_1X}}$

DRX cycle length [s]	$T_{\text{measureCDMA2000_1X}}$ [s] (number of DRX cycles)	$T_{\text{evaluateCDMA2000_1X}}$ [s] (number of DRX cycles)
0.32	5.12 (16)	15.36 (48)
0.64	5.12 (8)	15.36 (24)
1.28	6.4 (5)	19.2 (15)
2.56	7.68 (3)	23.04 (9)

If $T_{\text{reselection}}$ timer has a non zero value and the CDMA2000 1X cell is satisfied with the reselection criteria which are defined in [1], the UE shall evaluate this CDMA2000 1X cell for the $T_{\text{reselection}}$ time. If this cell remains satisfied with the reselection criteria within this duration, then the UE shall reselect that cell.

6.2.3.10a.3 Test description

6.2.3.10a.3.1 Pre-test conditions

System Simulator:

- Cell 1 for E-UTRAN
- Cell 19 for CDMA2000 1xRTT with lower reselection priority than Cell 1
- System information combination 6 as defined in TS 36.508 [18] clause 4.4.3.1 is used in E-UTRA cells.

UE:

None.

Preamble:

- The UE is in state Registered, Idle mode (state 2) on Cell 1 according to [18].

6.2.3.10a.3.2 Test procedure sequence

Table 6.2.3.10.3.2-1 illustrates the downlink power levels and other changing parameters to be applied for the cells at various time instants of the test execution. Row marked "T0" denotes the initial conditions, while rows marked "T1" and "T2" are to be applied subsequently. The exact instants on which these values shall be applied are described in the texts in this clause.

Table 6.2.3.10a.3.2-1: Time instances of cell power level and parameter changes

	Parameter	Unit	Cell 1	Cell 19	Remark
T0	Cell-specific RS EPRE	dBm/15 KHz	-75	-	The power levels are such that camping on Cell 1 is guaranteed.
T1	Cell-specific RS EPRE	dBm/15 KHz	-100	-	Cell 19 is on and $S_{\text{nonServingCell}}$, of Cell 19 < $\text{Thresh}_{1\text{xRTT, LowP}}$
	$\hat{I}_{\text{or/loc}}$	dB	-	-15	
	Pilot Ec/ Ior			-7	
	Ioc	dBm	-	-75	
	Pilot Ec/ Io (Note 1)	dB	-	-22	
T2	Cell-specific RS EPRE	dBm/15 KHz	-120	-	Increase pilot power of 1xRTT cell such that $S_{\text{nonServingCell}}$, of Cell 19 > $\text{Thresh}_{1\text{xRTT, LowP}}$ and $S_{\text{ServingCell}}$ of the E-UTRA < $\text{Thresh}_{\text{Serving, LowP}}$
	$\hat{I}_{\text{or/loc}}$	dB	-	0	
	Pilot Ec/ Ior	dB	-	-7	
	Ioc	dBm/1.23 MHz	-	-75	
	Pilot Ec/ Io (Note 1)	dB	-	-10	

Note 1: This parameter is not directly settable, but is derived by calculation from the other parameters set by the SS.
Note 2: Default value of $\text{Thresh}_{\text{Serving, LowP}}$ is 0.

Table 6.2.3.10a.3.2-2: Main behaviour

St	Procedure	Message Sequence		TP	Verdict
		U - S	Message		
1	Cell 19 is on and it has lower reselection priority than Cell 1, according to "T1" in 6.2.3.10a.3.2-1 SS adjust the serving cell signal level so that E-UTRA serving cell $S_{\text{qual}} \leq S_{\text{nonIntraSearchQ}}$	-	-	-	-
2	UE performs measurement for Cell 19 at every $T_{\text{measureCDMA2000_1X}}$	-	-		
3	Check: Does the UE transmit an Access Probe on Cell 19 within the next [60s]?	-->	Access Probe	1	F
4	SS adjust CDMA2000 1xRTT Cell 19 signal level to make sure S_{rxlev} of Cell 19 > $\text{Thresh}_{1\text{xRTT, low}}$, according to "T2" in 6.2.3.10a.3.2-1				
5	Check: Does the UE transmit an Access Probe on Cell 19?	-->	Access Probe	2	P

Note 1: The UE is expected during this time to do measurements on the HRPD cell at least every $T_{\text{measureCDMA2000_1X}}$ but this cannot be easily verified.

6.2.3.10a.3.3 Specific message contents

Table 6.2.3.10a.3.3-1: SystemInformationBlockType1 to Cell 1 (Preamble and all steps, table 6.2.3.10.3.2-2)

Derivation path: 36.508 table 4.4.3.2			
Information Element	Value/Remark	Comment	Condition
SystemInformationBlockType1 ::= SEQUENCE {			
cellSelectionInfo SEQUENCE {			
q-Rxlevmin	-55 (-110 dBm)		
q-Rxlevminoffset	Not present		
}			
}			

Table 6.2.3.10a.3.3-2: SystemInformationBlockType3 for Cell 1 (Preamble and all steps, table 6.2.3.10a.3.2-2)

Derivation path: 36.508 table 4.4.3.3-2			
Information Element	Value/Remark	Comment	Condition
SystemInformationBlockType3 ::= SEQUENCE {			
cellReselectionServingFreqInfo SEQUENCE {			
threshServingLow	5 (10dB)		
cellReselectionPriority	4		
}			
}			

lateNonCriticalExtension {			
threshServingLowQ-r9	26		
}			
}			

Table 6.2.3.10a.3.3-3: SystemInformationBlockType8 to Cell 1 (Preamble and all steps, table 6.2.3.10a.3.2-2)

Derivation path: 36.508 table 4.4.3.3			
Information Element	Value/Remark	Comment	Condition
SystemInformationBlockType8 ::= SEQUENCE {			
systemTimeInfo SEQUENCE {			
cdma-EUTRA-Synchronisation	TRUE		
cdma-SystemTime CHOICE {			
synchronousSystemTime	A valid value as per TS 36.331 and calculated by the SS		
}			
}			
searchWindowSize	5		
parameters1XRTT SEQUENCE {			1XRTT
cellReselectionParameters1XRTT SEQUENCE {			
bandClassList SEQUENCE (SIZE (1..maxCDMA - BandClass)) OF SEQUENCE {	The same number of entries as the configured 1xRTT carriers		
bandClass	Band Class of frequency under test	ENUMERATED { bc0, bc1, bc2, bc3, bc4, bc5, bc6, bc7, bc8, bc9, bc10, bc11, bc12, bc13, bc14, bc15, bc16, bc17, spare14, spare13, spare12, spare11, spare10, spare9, spare8, spare7, spare6, spare5, spare4, spare3, spare2, spare1, ...}	
cellReselectionPriority	3	[3 is applicable when 1xRTT is lower priority than E-UTRA. 5 is applicable when 1xRTT is higher priority than E-UTRA]	
threshX-High	30(-30)	INTEGER (0..63)	
threshX-Low	32(-32)	INTEGER (0..63)	
}			
t-ReselectionCDMA2000	7	INTEGER (0..7)	
}			
}			
}			

6.2.3.11 Void

6.2.3.12 Void

6.2.3.13 Inter-RAT cell reselection / From UTRA_Idle to E-UTRA RRC_IDLE according to RAT priority provided by dedicated signalling

6.2.3.13.1 Test Purpose (TP)

(1)

```
with { UE in UTRA_Idle state }
ensure that {
  when { UE detects the cell re-selection criteria are met for the cell which belongs to the lower
priority inter-RAT E-UTRA cell based on the configured RAT priority provided by dedicated signaling
}
  then { UE reselects the cell which belongs to the lower priority inter-RAT E-UTRA cell }
}
```

(2)

```
with { UE in E-UTRA RRC_IDLE state having inherit RAT priority provided by dedicated signaling with
the remaining validity time }
ensure that {
  when { UE discard the inherit RAT priority upon connection establishment }
  then { UE reselects a cell by applying the cellReselectionPriority broadcast in the system
information }
}
```

6.2.3.13.2 Conformance requirements

References: The conformance requirements covered in the present TC are specified in: TS 25.304, clause 5.2.6.1.2a and 5.2.6.1.4a; TS 25.331, clause 8.3.3.3 and 8.6.7.23; TS 36.331, clause 5.3.3.4; TS 25.133, clause 4.2.2.5a

[TS 25.304, clause 5.2.6.1.2a]

If the UE has received absolute priority information for inter-RAT layers, the UE shall follow these rules:

- The UE shall perform measurements of inter-RAT layers with a priority higher than the priority of the current serving cell.

NOTE: The rate of these measurements may vary depending on whether S_{rxlev} and S_{qual} of the serving cell are above or below $S_{prioritysearch1}$ and $S_{prioritysearch2}$. This is specified in [10].

- For inter-RAT layers with a priority lower than the priority of the current serving cell:
 - If $S_{rxlev}^{servingCell} > S_{prioritysearch1}$ and $S_{qual}^{servingCell} > S_{prioritysearch2}$ the UE may choose not to perform measurements of inter-RAT layers of lower priority.
 - If $S_{rxlev}^{servingCell} \leq S_{prioritysearch1}$ or $S_{qual}^{servingCell} \leq S_{prioritysearch2}$ the UE shall perform measurements of inter-RAT layers of lower priority.

[TS 25.304, clause 5.2.6.1.4a]

Absolute priorities of different absolute priority layers may be provided to the UE. The following cell reselection criteria are used for inter-frequency cells if absolute priority information for inter-frequency is available to the UE, and inter-RAT cells if absolute priority information for inter-RAT is available to the UE.

...

The UE shall inherit the priorities provided by dedicated signalling and the remaining validity time (i.e., T320 in E-UTRA, T322 in UTRA and [T3230, FFS] in GERAN), if configured, at inter-RAT cell (re)selection.

The following definitions apply:

- Criterion 1: the $S_{rxlev}^{nonServingCell,x}$ of a cell on an evaluated higher absolute priority layer is greater than $Thresh_{x,high}$ during a time interval $T_{reselection}$;

...

- Criterion 3: $Srxlev_{\text{ServingCell}} < \text{Thresh}_{\text{Serving,low}}$ or $Squal_{\text{ServingCell}} < 0$ and the $Srxlev_{\text{nonServingCell},x}$ of a cell on an evaluated lower absolute priority layer is greater than $\text{Thresh}_{x,\text{low}}$ during a time interval $T_{\text{reselection}}$;

Cell reselection to a cell on a higher absolute priority layer than the camped frequency shall be performed if criterion 1 is fulfilled.

...

Cell reselection to a cell on a lower absolute priority layer than the camped frequency shall be performed if criterion 3 is fulfilled.

If more than one cell meets the above criteria, the UE shall reselect the cell with the highest $Srxlev_{\text{nonServingCell},x}$ among the cells meeting the criteria on the highest absolute priority layer.

The UE shall not perform cell reselection to cells for which the cell selection criterion S is not fulfilled.

The UE shall not perform cell reselection until more than 1 second has elapsed since the UE camped on the current serving cell.

[TS 25.331, clause 8.3.3.3]

When the UE receives a UTRAN MOBILITY INFORMATION message, it shall:

- 1> act on received information elements as specified in subclause 8.6;
- 1> if the IE "Dedicated Priority Information" is present:
 - 2> act upon the received IE as described in subclause 8.6.7.23.

[TS 25.331, clause 8.6.7.23]

If the CHOICE "Action" has the value "Configure dedicated priorities", the UE shall:

- 1> clear the variable PRIORITY_INFO_LIST;
- 1> stop timer T322, if it is running;
- 1> set the value of IE "Priority status" in the variable PRIORITY_INFO_LIST to "dedicated_priority";
- 1> for each occurrence of the IE "Priority Level List":
 - 2> create a new entry in the IE "Priority Info List" in the variable PRIORITY_INFO_LIST, and in that new entry:
 - 3> set the CHOICE "Radio Access Technology" to the value received in the IE "Priority Level List";
 - 3> set the IE "priority" to the value received in the IE "Priority Level List";
 - 3> set the values in IE "Frequency List" or "BCCH ARFCN List" to the values received in the IE "Priority Level List".
- 1> set the IE "E-UTRA detection" to the value received in the IE "Priority Level List".
- 1> if the IE "T322" is present:
 - 2> start timer T322 using the value signalled in this IE.
- 1> if the UE is not in CELL_DCH state:
 - 2> take the actions as described in subclause 8.1.1.6.19 using stored System information Block type 19.

[TS 36.331, clause 5.3.3.4]

The UE shall:

- 1> perform the radio resource configuration procedure in accordance with the received *radioResourceConfigDedicated* and as specified in 5.3.10;
- 1> if stored, discard the cell reselection priority information provided by the *idleModeMobilityControlInfo* or inherited from another RAT;
- 1> stop timer T300;
- 1> stop timer T302, if running;
- 1> stop timer T303, if running;
- 1> stop timer T305, if running;
- 1> perform the actions as specified in 5.3.3.7;
- 1> stop timer T320, if running;
- 1> enter RRC_CONNECTED;
- 1> stop the cell re-selection procedure;
- 1> set the content of *RRCConnectionSetupComplete* message as follows:
 - ...
 - 2> submit the *RRCConnectionSetupComplete* message to lower layers for transmission, upon which the procedure ends;

[TS 25.133, clause 4.2.2.5a]

...

The UE shall be able to evaluate whether a new detectable lower priority inter-RAT E-UTRA cell meets the reselection criteria defined in [1] within $K_{\text{carrier}} * T_{\text{detectE-UTRA}}$, where $T_{\text{detectE-UTRA}}$ is given in Table 4.2, if E-UTRA carrier frequency information is provided in the inter-RAT measurement control system information when $T_{\text{reselection}}=0$ provided that the reselection criteria is met by at least 6dB. The parameter K_{carrier} is the number of E-UTRA carrier frequencies indicated in the inter-RAT measurement control system information. An inter RAT E-UTRAN cell is considered to be detectable if:

- RSRP_{dBm} according to Annex B.1.1 for a corresponding Band

...

For an inter-RAT E-UTRA cell that has been already detected, but that has not been reselected to, the filtering shall be such that the UE shall be capable of evaluating that the E-UTRA cell has met reselection criterion defined TS 36.304 within $K_{\text{carrier}} * T_{\text{evaluateEUTRA}}$ as specified in table 4.2 provided that the reselection criteria is met by at least 6dB and the $T_{\text{reselection}}$ timer is set to zero.

6.2.3.13.3 Test description

6.2.3.13.3.1 Pre-test conditions

System Simulator:

- Cell 1 and Cell 5.
 - Cell 1 suitable neighbour E-UTRA cell
 - Cell 5 UTRA serving cell

NOTE: Common Priority information for Cell 1 & Cell 5: UTRA priority = 3; E-UTRA priority = 4.

- System information combination 4 as defined in TS 36.508 [18] clause 4.4.3.1 is used in E-UTRA cells.

UE:

None.

Preamble:

- The UE is in state PS-DCCH+DTCH_DCH (state 6-10) on Cell 5 according to [5].

6.2.3.13.3.2 Test procedure sequence

Tables 6.2.3.13.3.2-1 and 6.2.3.13.3.2-2 illustrates the downlink power levels and other changing parameters to be applied for the cells at various time instants of the test execution. Row marked "T0" denotes the conditions after the preamble, while row marked "T1" and "T2" are to be applied subsequently. The exact instants on which these values shall be applied are described in the texts in this clause.

Table 6.2.3.13.3.2-1: Time instances of cell power level and parameter changes for E-UTRA cell

	Parameter	Unit	Cell 1	Remark
T0	Cell-specific RS EPRE	dBm/15kHz	-97	
	Qrxlevmin	dBm	-106	Default value
	Srxlev*	dB	9	
T1	Cell-specific RS EPRE	dBm/15kHz	-85	
	Srxlev*	dB	21	$S_{rxlev} = \text{Cell-specific RS EPRE} - q_{RxLevMinEUTRA}$ $S_{nonServingCell, Cell1} > \text{Thresh}_{Cell1,low}$
T2	Cell-specific RS EPRE	dBm/15kHz	-97	
	Qrxlevmin	dBm	-106	Default value
	Srxlev*	dB	9	
Note: Srxlev is calculated in the UE				

Table 6.2.3.13.3.2-2: Time instances of cell power level and parameter changes for UTRA cell

	Parameter	Unit	Cell 5	Remark
T0	CPICH_Ec	dBm/3.84 MHz	-60	The power levels are such that camping on Cell 5 is guaranteed.
	P-CCPCH	dBm/1.28 MHz	-62	
	Qrxlevmin	dBm	-79	Default value
	Srxlev*	dB	19	
T1	CPICH_Ec	dBm/3.84 MHz	-75	
	P-CCPCH	dBm/1.28 MHz	-77	
	Srxlev*	dB	4	$S_{rxlevServingCell} < \text{Thresh}_{Serving,low}$
T2	CPICH_Ec	dBm/3.84 MHz	-60	
	P-CCPCH	dBm/1.28 MHz	-62	
	Srxlev*	dB	19	
Note: Srxlev is calculated in the UE				

Table 6.2.3.13.3.2-3: Main behaviour

St	Procedure	Message Sequence		TP	Verdict
		U - S	Message		
1	The SS provides dedicated priority information (UTRA priority = 5; E-UTRA priority = 4) and validity timer to the UE.	<--	UTRAN MOBILITY INFORMATION	-	-
2	The SS receives the UTRAN MOBILITY INFORMATION CONFIRM message.	-->	UTRAN MOBILITY INFORMATION CONFIRM	-	-
3	The SS releases the UE connection.	<--	RRC CONNECTION RELEASE	-	-
4	The SS receives UE release complete message.	-->	RRC CONNECTION RELEASE COMPLETE	-	-
5	The SS receives UE release complete message.	-->	RRC CONNECTION RELEASE COMPLETE	-	-
6	The SS receives UE release complete message.	-->	RRC CONNECTION RELEASE COMPLETE	-	-
7	The SS changes Cell 1 and Cell 5 levels according to the row "T1" in table 6.2.3.13.3.2-1 and table 6.2.3.13.3.2-2.	-	-	-	-
8	Check: does the test result of generic test procedure in TS 36.508 Table 6.4.2.7A-1 indicate that the UE is camped on E-UTRAN Cell 1? NOTE: The UE performs a TAU procedure and the RRC Connection is released.	-	-	1	-
9	Void	-	-	-	-
10	Wait for 6 s for UE to receive system information.	-	-	-	-
11	The SS changes Cell 1 and Cell 5 levels according to the row "T2" in table 6.2.3.13.3.2-1 and table 6.2.3.13.3.2-2.	-	-	-	-
12	Check: does the test result of generic test procedure in TS 36.508 subclause 6.4.2.8 indicate that the UE is camped on UTRAN Cell 5?	-	-	2	-

6.2.3.13.3.3 Specific message contents

Table 6.2.3.13.3.3-1: UTRAN MOBILITY INFORMATION for Cell 5 (step 1, Table 6.2.3.13.3.2-3)

Derivation Path: 34.108, clause 9			
Information Element	Value/remark	Comment	Condition
UTRANMobilityInformation ::= CHOICE {			
later-than-r3 SEQUENCE {			
criticalExtensions CHOICE {			
criticalExtensions CHOICE {			
r7 SEQUENCE {			
v860NonCriticalExtensions SEQUENCE {			
utranMobilityInformation-v860ext SEQUENCE {			
{			
dedicatedPriorityInformation SEQUENCE {			
action CHOICE {			
configureDedicatedPriorities SEQUENCE {			
{			
t-322	5	Time in minutes	
priorityLevelList SEQUENCE (SIZE (1..maxPrio)) OF SEQUENCE {	2 entry		
priority[1]	5		
radioAccessTechnology[1] CHOICE {			
utraFDD SEQUENCE (SIZE (1..maxNumFDDFreqs)) OF SEQUENCE {	1 entry		UTRA-FDD
uarfcn	Same downlink UARFCN as used for Cell 5		
}			
utraTDD SEQUENCE (SIZE (1..maxNumTDDFreqs)) OF SEQUENCE {	1 entry		UTRA-TDD
uarfcn	Same downlink UARFCN as used for Cell 5		
}			
}			
}			
priority[2]	4		
radioAccessTechnology[2] CHOICE {			
eutra SEQUENCE (SIZE (1..maxNumEUTRAFreqs)) OF SEQUENCE {	1 entry		
earfcn	Same downlink EARFCN as used for Cell 1		
}			
}			
}			
}			
}			
}			
}			

Condition	Explanation
UTRA-FDD	UTRA FDD cell environment
UTRA-TDD	UTRA TDD cell environment

Table 6.2.3.13.3.3-2: RRC CONNECTION RELEASE for Cell 5 (step 3, Table 6.2.3.13.3.2-3)

Derivation Path: 34.108, clause 9			
Information Element	Value/remark	Comment	Condition
RRCConnectionRelease ::= CHOICE {			
later-than-r3 SEQUENCE {			
criticalExtensions CHOICE {			
r4 SEQUENCE {			
rrcConnectionRelease-r4 SEQUENCE {			
n-308	2	2 (for CELL_DCH state). Not Present (for UE in other connected mode states).	
releaseCause	normalEvent		
rplmn-information	Not Present		
}			
v4d0NonCriticalExtensions SEQUENCE {}	Not Present		
}			
}			
}			
}			

Table 6.2.3.13.3.3-3: System Information Block type 19 for Cell 5 (preamble and all steps, Table 6.2.3.13.3.2-3)

Derivation Path: 36.508 table 4.4.4.1-1			
Information Element	Value/remark	Comment	Condition
SysInfoType19 ::= SEQUENCE {			
utra-PriorityInfoList ::= SEQUENCE {			
utra-ServingCell ::= SEQUENCE {			
s-PrioritySearch1	8 (16 dB)		
threshServingLow	4 (8 dB)		
}			
}			
eutra-FrequencyAndPriorityInfoList ::= SEQUENCE (SIZE (1..maxNumEUTRAFreqs)) OF SEQUENCE {			
earfcn [n]	Same downlink EARFCN as used for Cell 1		
measurementBandwidth [n]	Not present		
qRxLevMinEUTRA [n]	-53 (-106 dBm)		
threshXhigh [n]	16 (32 dB)		
threshXlow [n]	6 (12 dB)		
}			
}			

Note: GERAN cell priority is not allocated, hence it will be considered as the less than all allowed values of 0 to 7.

Table 6.2.3.13.3.3-4: SystemInformationBlockType3 for Cell 1 (preamble and all steps, Table 6.2.3.13.3.2-3)

Derivation path: 36.508 table 4.4.3.3-2			
Information Element	Value/Remark	Comment	Condition
SystemInformationBlockType3 ::= SEQUENCE {			
cellReselectionServingFreqInfo SEQUENCE {			
threshServingLow	10 (20dB)		
cellReselectionPriority	4		
}			
}			

Table 6.2.3.13.3.3-5: SystemInformationBlockType6 for Cell 1 (preamble and all steps, Table 6.2.3.13.3.2-3)

Derivation Path: 36.508 table 4.4.3.3-5			
Information Element	Value/remark	Comment	Condition
SystemInformationBlockType6 ::= SEQUENCE {			
carrierFreqListUTRA-FDD SEQUENCE (SIZE (1..maxUTRA-FDD-Carrier)) OF SEQUENCE {			UTRA-FDD
carrierFreq[n]	Downlink UARFCN of Cell 5		
cellReselectionPriority[n]	3		
threshX-High[n]	5 (10dB)		
threshX-Low[n]	5 (10dB)		
}			
carrierFreqListUTRA-TDD SEQUENCE (SIZE (1..maxUTRA-TDD-Carrier)) OF SEQUENCE {			UTRA-TDD
carrierFreq[n]	Downlink UARFCN of Cell 5		
cellReselectionPriority[n]	3		
threshX-High[n]	5 (10dB)		
threshX-Low[n]	5 (10dB)		
}			
}			

Condition	Explanation
UTRA-FDD	UTRA FDD cell environment
UTRA-TDD	UTRA TDD cell environment

6.2.3.14 Inter-RAT Cell Reselection / from GSM_Idle/GPRS Packet_Idle to E-UTRA (priority of E-UTRA cells are higher than the serving cell)

6.2.3.14.1 Test Purpose (TP)

(1)

```
with { UE in GSM/GPRS Registered state and no RR connection }
ensure that {
  when { Priority of E-UTRA neighbour cell is set lower than GERAN cell }
  then { UE does not reselects the lower priority E-UTRA neighbour cell }
}
```

(2)

```
with { UE in GSM/GPRS Registered state and no RR connection }
ensure that {
  when { Priority of E-UTRA neighbour cell is set higher than GERAN cell }
  then { UE reselects the higher priority inter-RAT E-UTRA neighbour cell }
}
```

6.2.3.14.2 Conformance requirements

References: The conformance requirements covered in the present TC are specified in: TS 45.008, clause 10.1.3.3 & TS 44.018, clause 3.4.1.2.1.1a.

[TS 45.008, clause 10.1.3.3]

Cell reselection to a cell of another inter-RAT frequency shall be performed if any of the conditions below (to be evaluated in the order shown) is satisfied:

- The $S_{\text{non-serving_XXX}}$ of one or more cells of a higher priority inter-RAT frequency is greater than THRESH_XXX_high (or, in case of an E-UTRAN target, $\text{THRESH_E-UTRAN_high_Q}$, if provided) during a time interval $T_{\text{reselection}}$; in that case, the mobile station shall consider the cells for reselection in decreasing order of priority and, for cells of the same inter-RAT frequency or of inter-RAT frequencies of equal priority, in decreasing order of $S_{\text{non-serving_XXX}}$, and reselect the first cell that satisfies the conditions above;

...

If the mobile station applies either common priorities or individual priorities received through dedicated signalling and priorities are available only for some inter-RAT frequencies, cells belonging to frequencies for which no priority is available or no threshold is provided by the serving cell shall not be considered for measurement and for cell re-selection.

If a mobile station in camped normally state (see 3GPP TS 43.022) applies individual priorities received through dedicated signalling and no priority is available for the serving cell, the mobile station shall consider any GSM cell (including the serving cell) to have lowest priority (i.e. lower than the eight network configured values).

[TS 44.018, clause 3.4.1.2.1.1a]

This applies only to a multi-RAT MS supporting E-UTRAN. One or more instances of the Measurement Information message or SI2quater message may provide E-UTRAN Neighbour Cell Description information in one or more instances of the Repeated E-UTRAN Neighbour Cells IE. This is used to build the E-UTRAN Neighbour Cell list. The E-UTRAN Neighbour Cell list may contain up to 8 E-UTRAN frequencies. For each E-UTRAN frequency, zero or more E-UTRAN neighbour cells may be specified that are not allowed for cell reselection. The list of not allowed cells is defined in the Not Allowed Cells IEs.

Each EARFCN in each instance of the Repeated E-UTRAN Neighbour Cells IE is added to the E-UTRAN Neighbour Cell list in the order in which it is received.

6.2.3.14.3 Test description

6.2.3.14.3.1 Pre-test conditions

System Simulator:

- Two cells:
 - One GERAN cell, Cell 24 is serving cell.
 - One E-UTRAN cell, Cell 1 is Suitable neighbour inter-frequency cell.

UE:

None.

Preamble:

- The UE is in state Registered, IDLE (GPRS) on Cell 24 (3GPP TS 51.010-1 clause 41.2.8.1.1)

6.2.3.14.3.2 Test procedure sequence

Table 6.2.3.14.3.2-1: Main behaviour

St	Procedure	Message Sequence		TP	Verdict
		U - S	Message		
1	Check: Does the UE send an RRCConnectionRequest on Cell 1 within the next 75 s (70 s + T_reselect)?	-->	RRCConnectionRequest	1	F
2	The SS changes SI2Quater in Cell 24 according to table 6.2.3.14.3.3-2.	-	-	-	-
3	The SS changes SI13 in Cell 24 according to table 6.2.3.14.3.3-3.	-	-	-	-
4	Void	-	-	-	-
5	Check: Does the test result of generic test procedure in TS 36.508 Table 6.4.2.7A-2 indicate that the UE is camped on E-UTRAN Cell 1?	-	-	2	-

6.2.3.14.3.3 Specific message contents

Table 6.2.3.14.3.3-1: Repeated E-UTRAN Neighbour Cells struct of SI2Quater for Cell 24 in Preamble

Derivation Path: 36.508 table 4.4.5-1			
Information Element	Value/remark	Comment	Condition
Serving Cell Priority Parameters Description ::= {			
GERAN_PRIORITY	5		
THRESH_Priority_Search	0		
THRESH_GSM_low	0		
}			
Repeated E-UTRAN Neighbour Cells ::= {			
EARFCN	Same as cell 1	This field specifies the E-UTRA Absolute Radio Frequency Channel Number as defined in 3GPP TS 36.104.	
Measurement Bandwidth	Same as cell 1		
E-UTRAN_PRIORITY	'100'B	4	
THRESH_E-UTRAN_high	'00010'B	Actual value =4 dB	
THRESH_E-UTRAN_low	'00010'B	Actual value =4 dB	
}			

Table 6.2.3.14.3.3-2: Repeated E-UTRAN Neighbour Cells struct of SI2Quater for Cell 24 in table 6.2.3.14.3.2-1 step 2

Derivation Path: 36.508 table 4.4.5-1			
Information Element	Value/remark	Comment	Condition
SI 2QUATER REST OCTETS			
MP Change Mark	1		
Repeated E-UTRAN Neighbour Cells ::= {			
EARFCN	Same as cell 1	This field specifies the E-UTRA Absolute Radio Frequency Channel Number as defined in 3GPP TS 36.104.	
Measurement Bandwidth	Same as cell 1		
E-UTRAN_PRIORITY	'110'B	6	
THRESH_E-UTRAN_high	'00010'B	Actual value =4 dB	
THRESH_E-UTRAN_low	'00010'B	Actual value =4 dB	
}			

Table 6.2.3.14.3.3-3: SI13 for Cell 24 in table 6.2.3.14.3.2-1 step 3

Derivation Path: 51.010-1 clause 40.2.1.1.1			
Information Element	Value/remark	Comment	Condition
SI 13 Rest Octets ::= {			
BCCH_CHANGE_MARK	'001'B		
SI_CHANGE_FIELD	'0010'B	Update of SI2, SI2 bis or SI2 ter message or any instance of SI2quater messages.	
}			

6.2.3.15 Inter-RAT Cell Reselection / from GSM_Idle/GPRS Packet_Idle to E-UTRA (priority of E-UTRA cells are lower than the serving cell)

6.2.3.15.1 Test Purpose (TP)

(1)

```
with { UE in GSM/GPRS Registered state and no RR connection }
ensure that {
  when {  $S_{rxlev_{eutra}} < THRESH_{E-UTRA\_low}$  for the lower priority inter-RAT E-UTRA cell }
  then { UE does not reselects the lower priority inter-RAT E-UTRA cell }
}
```

(2)

```
with { UE in GSM/GPRS Registered state and no RR connection }
ensure that {
  when {  $S_{rxlev_{eutra}} > THRESH_{E-UTRA\_low}$  for the lower priority inter-RAT E-UTRA cell }
  then { UE reselects the lower priority inter-RAT E-UTRA cell }
}
```

6.2.3.15.2 Conformance requirements

References: The conformance requirements covered in the present TC are specified in: TS 45.008, clause 10.1.3.3 & TS 44.018, clause 3.4.1.2.1.1a.

[TS 45.008, clause 10.1.3.3]

Cell reselection to a cell of another inter-RAT frequency shall be performed if any of the conditions below (to be evaluated in the order shown) is satisfied:

...

- The value of $S_{serving}$ is lower than $THRESH_{serving_low}$ for the serving cell and all measured GSM cells; in this case, the mobile station shall consider for reselection the inter-RAT cells in the following order, and reselect the first one that satisfies the following criteria:
 - cells of a lower priority inter-RAT frequency whose $S_{non-serving_XXX}$ is greater than $THRESH_{XXX_low}$ during a time interval $T_{reselection}$; these cells shall be considered in decreasing order of priority and, for cells of the same RAT, in decreasing order of $S_{non-serving_XXX}$;

[TS 44.018, clause 3.4.1.2.1.1a]

This applies only to a multi-RAT MS supporting E-UTRAN. One or more instances of the Measurement Information message or SI2quater message may provide E-UTRAN Neighbour Cell Description information in one or more instances of the Repeated E-UTRAN Neighbour Cells IE. This is used to build the E-UTRAN Neighbour Cell list. The E-UTRAN Neighbour Cell list may contain up to 8 E-UTRAN frequencies. For each E-UTRAN frequency, zero or more E-UTRAN neighbour cells may be specified that are not allowed for cell reselection. The list of not allowed cells is defined in the Not Allowed Cells IEs.

Each EARFCN in each instance of the Repeated E-UTRAN Neighbour Cells IE is added to the E-UTRAN Neighbour Cell list in the order in which it is received.

6.2.3.15.3 Test description

6.2.3.15.3.1 Pre-test conditions

System Simulator:

- Two cells:
 - One GERAN cell, Cell 24 is serving cell.
 - One E-UTRAN cell, Cell 1 is Suitable neighbour inter-frequency cell.

None.

Preamble:

- The UE is in state Registered, IDLE (GPRS) on Cell 24 (3GPP TS 51.010-1 clause 41.2.8.1.1).

6.2.3.15.3.2 Test procedure sequence

Table 6.2.3.15.3.2-1: Main behaviour

St	Procedure	Message Sequence		TP	Verdict
		U – S	Message		
1	Check: Does the UE send an RRCConnectionRequest on Cell 1 within the next 30 s (25 s+T_reselect)?	-->	RRCConnectionRequest	1	F
2	The SS changes SI2Quater in Cell 24 according to table 6.2.3.15.3.3-2. Srxlev _{Cell 1} > THRESH_E-UTRAN_low.	-	-	-	-
3	The SS changes SI13 in Cell 24 according to table 6.2.3.15.3.3-3.	-	-	-	-
4	Void	-	-	-	-
5	Check: Does the test result of generic test procedure in TS 36.508 Table 6.4.2.7A-2 indicate that the UE is camped on E-UTRAN Cell 1?	-	-	2	-

6.2.3.15.3.3 Specific message contents

Table 6.2.3.15.3.3-1: Repeated E-UTRAN Neighbour Cells struct of SI2Quater for Cell 24 in Preamble

Derivation Path: 36.508 table 4.4.5-1			
Information Element	Value/remark	Comment	Condition
Serving Cell Priority Parameters Description ::= {			
GERAN_PRIORITY	7		
THRESH_Priority_Search	0		
THRESH_GSM_low	15	MS is always allowed to reselect to lower priority cells	
}			
Repeated E-UTRAN Neighbour Cells ::= SEQUENCE {			
EARFCN	Same as Cell 1	This field specifies the E-UTRA Absolute Radio Frequency Channel Number as defined in 3GPP TS 36.104.	
Measurement Bandwidth	Same as Cell 1		
E-UTRAN_PRIORITY	'001'B		
THRESH_E-UTRAN_high	'00010'B	Actual value = 4 dB	
THRESH_E-UTRAN_low	'10010'B	Actual value = 36 dB	
}			

Table 6.2.3.15.3.3-2: Repeated E-UTRAN Neighbour Cells struct of SI2Quater for Cell 24 in table 6.2.3.15.3.2-1 step 2

Derivation Path: 36.508 table 4.4.5-1			
Information Element	Value/remark	Comment	Condition
SI 2QUATER REST OCTETS			
3G BA Indicator	1		
MP Change Mark	1		
Serving Cell Priority Parameters Description ::= {			
THRESH_GSM_low	15	MS is always allowed to reselect to lower priority cells	
}			
Repeated E-UTRAN Neighbour Cells ::= {			
EARFCN	Same as Cell 1	This field specifies the E-UTRA Absolute Radio Frequency Channel Number as defined in 3GPP TS 36.104.	
Measurement Bandwidth	Same as Cell 1		
E-UTRAN_PRIORITY	'001'B		
THRESH_E-UTRAN_high	'00010'B	Actual value = 4 dB	
THRESH_E-UTRAN_low	'00010'B	Actual value = 4 dB	
}			

Table 6.2.3.15.3.3-3: SI13 for Cell 24 in table 6.2.3.15.3.2-1 step 3

Derivation Path: 51.010-1 clause 40.2.1.1.1			
Information Element	Value/remark	Comment	Condition
SI 13 Rest Octets ::= {			
BCCH_CHANGE_MARK	'001'B		
SI_CHANGE_FIELD	'0010'B	Update of SI2, SI2 bis or SI2 ter message or any instance of SI2quater messages.	
}			

6.2.3.16 Inter-RAT Cell Reselection / from GSM_Idle to E-UTRAN /based on H_PRIO criteria

6.2.3.16.1 Test Purpose (TP)

(1)

```
with { UE in GSM/GPRS Registered state and no RR connection }
ensure that {
  when { Srxlev_eutran < THRESH_E-UTRAN_low for the lower priority inter-RAT E-UTRA cell and H_PRIO is off }
  then { UE does not reselects the lower priority inter-RAT E-UTRA cell }
}
```

(2)

```
with { UE in GSM/GPRS Registered state and no RR connection }
ensure that {
  when { Srxlev_eutran < THRESH_E-UTRAN_low for the lower priority inter-RAT E-UTRA cell and when Srxlev_eutran is higher than ServingCell by at least H_PRIO }
  then { UE reselects the inter-RAT E-UTRA cell based on H_PRIO }
}
```

6.2.3.16.2 Conformance requirements

References: The conformance requirements covered in the present TC are specified in: TS 45.008, clause 6.6.6 & TS 44.018, clause 3.4.1.2.1.1a.

[TS 45.008, clause 6.6.6]

Cell reselection to a cell of another inter-RAT frequency shall be performed if any of the conditions below (to be evaluated in the order shown) is satisfied:

...

- The value of S_{GSM} is lower than $THRESH_{GSM_low}$ for the serving cell and all measured GSM cells during a time interval $T_{reselection}$; in this case, the mobile station shall consider for reselection the inter-RAT cells in the following order, and reselect the first one that satisfies the following criteria:
 - cells of a lower priority inter-RAT frequency whose $S_{non-serving_XXX}$ is greater than $THRESH_{XXX_low}$ (or, in case of an E-UTRAN target, $THRESH_{E-UTRAN_low_Q}$, if provided) during a time interval $T_{reselection}$; these cells shall be considered in decreasing order of priority and, for cells of the same RAT, in decreasing order of $S_{non-serving_XXX}$;
 - if no cells satisfy the criterion above, inter-RAT cells for which, during a time interval $T_{reselection}$, $S_{non-serving_XXX}$ is higher than S_{GSM} for the serving cell by at least a specific hysteresis H_{PRIO} ; these cells shall be considered in decreasing order of $S_{non-serving_XXX}$.

[TS 44.018, clause 3.4.1.2.1.1a]

This applies only to a multi-RAT MS supporting E-UTRAN. One or more instances of the Measurement Information message or SI2quater message may provide E-UTRAN Neighbour Cell Description information in one or more instances of the Repeated E-UTRAN Neighbour Cells IE. This is used to build the E-UTRAN Neighbour Cell list. The E-UTRAN Neighbour Cell list may contain up to 8 E-UTRAN frequencies. For each E-UTRAN frequency, zero or more E-UTRAN neighbour cells may be specified that are not allowed for cell reselection. The list of not allowed cells is defined in the Not Allowed Cells IEs.

Each EARFCN in each instance of the Repeated E-UTRAN Neighbour Cells IE is added to the E-UTRAN Neighbour Cell list in the order in which it is received.

6.2.3.16.3 Test description

6.2.3.16.3.1 Pre-test conditions

System Simulator:

- Two cells:
 - One GERAN cell, Cell 24 is serving cell.
 - One E-UTRAN cell, Cell 1.

None.

Preamble:

- The UE is in state Registered, IDLE (GPRS) on Cell 24 (3GPP TS 51.010-1 clause 41.2.8.1.1).

6.2.3.16.3.2 Test procedure sequence

Table 6.2.3.16.3.2-1: Time instances of cell power level and parameter changes

	Parameter	Unit	Cell 1	Cell 24	Remark
T0	Cell-specific RS EPRE	dBm/15kHz	-80	-	
	Qrxlevmin	dBm	-112	-	
	Srxlev*	dB	32	-	Srxlev should be at least 4dB > C1
	RF Signal level	dBm	-	-80	
	RXLEV_ACCESS_MIN	dBm	-	-101	
	C1*	dB	-	21	

Note: Srxlev and C1 is calculated in the UE

Table 6.2.3.16.3.2-1: Main behaviour

St	Procedure	Message Sequence		TP	Verdict
		U – S	Message		
1	Check: Does the UE send an RRCConnectionRequest on Cell 1 within the next 30s (25 s+T_reselect)?	-->	RRCConnectionRequest	1	F
2	The SS changes SI2Quater in Cell 24 according to table 6.2.3.16.3.3-2. H_PRIO=2 (4dB)	-	-	-	-
3	The SS changes SI13 in Cell 24 according to table 6.2.3.16.3.3-3.	-	-	-	-
4	Void	-	-	-	-
5	Check: Does the test result of generic test procedure in TS 36.508 Table 6.4.2.7A-2 indicate that the UE is camped on E-UTRAN Cell 1?	-	-	2	p

6.2.3.16.3.3 Specific message contents

Table 6.2.3.16.3.3-1: Repeated E-UTRAN Neighbour Cells struct of SI2Quater for Cell 24 in Preamble

Derivation Path: 36.508 table 4.4.5-1			
Information Element	Value/remark	Comment	Condition
Serving Cell Priority Parameters Description ::= {			
GERAN_PRIORITY	7		
THRESH_Priority_Search	15		
THRESH_GSM_low	15	MS is always allowed to reselect to lower priority cells	
H_PRIO	0	Rule disabled	
}			
Repeated E-UTRAN Neighbour Cells ::= SEQUENCE {			
E-UTRAN_PRIORITY	'001'B		
THRESH_E-UTRAN_high	'00010'B	Actual value = 4 dB	
THRESH_E-UTRAN_low	'11110'B	Actual value = 62 dB	
E-UTRAN_QRXLEVMIN	14 (-112 dBm)		
}			

Table 6.2.3.16.3.3-2: Repeated E-UTRAN Neighbour Cells struct of SI2Quater for Cell 24 in table 6.2.3.16.3.2-1 step 2

Derivation Path: 36.508 table 4.4.5-1			
Information Element	Value/remark	Comment	Condition
SI 2QUATER REST OCTETS			
MP Change Mark	1		
Serving Cell Priority Parameters Description::= {			
GERAN_PRIORITY	7		
THRESH_Priority_Search	15		
THRESH_GSM_low	15	MS is always allowed to reselect to lower priority cells	
H_PRIO	2	Reselect to inter-RAT cell which is at least 4dB higher than Serving cell	
}			
Repeated E-UTRAN Neighbour Cells ::= SEQUENCE {			
E-UTRAN_PRIORITY	'001'B		
THRESH_E-UTRAN_high	'00010'B	Actual value = 4 dB	
THRESH_E-UTRAN_low	'11110'B	Actual value = 62 dB	
E-UTRAN_QRXLEVMIN	14 (-112 dBm)		
}			

Table 6.2.3.16.3.3-3: SI13 for Cell 24 in table 6.2.3.16.3.2-1 step 3

Derivation Path: 51.010-1 clause 40.2.1.1.1			
Information Element	Value/remark	Comment	Condition
SI 13 Rest Octets ::= {			
BCCH_CHANGE_MARK	'001'B		
SI_CHANGE_FIELD	'0010'B	Update of SI2, SI2 bis or SI2 ter message or any instance of SI2quater messages.	
}			

6.2.3.17 Inter-RAT Cell Reselection / from GSM_Idle/GPRS Packet_Idle to E-UTRA (priority E-UTRA cells)

6.2.3.17.1 Test Purpose (TP)

(1)

```
with { UE in GSM/GPRS Registered state and no RR connection }
ensure that {
  when { UE detects the cell re-selection criteria are met for the cell which has priority}
  then { UE does not reselects the inter-RAT E-UTRA cell without priority}
}
```

6.2.3.17.2 Conformance requirements

References: The conformance requirements covered in the present TC are specified in: TS 45.008, clause 6.6.6 & TS 44.018, clause 3.4.1.2.1.1a.

[TS 45.008, clause 6.6.6]

The network shall provide priority information if E-UTRAN frequencies are included in the neighbour cell list; the network may provide priority information if only UTRAN frequencies are included in the neighbour cell list. If priority information is available to the mobile station and the mobile station supports priority based inter-RAT cell re-selection, the algorithm in this subclause shall be used for inter-RAT reselection towards all RATs. The rules regarding which set of priorities is valid at any given time are defined in 3GPP TS 44.018.

[TS 44.018, clause 3.4.1.2.1.1a]

This applies only to a multi-RAT MS supporting E-UTRAN. One or more instances of the Measurement Information message or SI2quater message may provide E-UTRAN Neighbour Cell Description information in one or more instances of the Repeated E-UTRAN Neighbour Cells IE. This is used to build the E-UTRAN Neighbour Cell list. The E-UTRAN Neighbour Cell list may contain up to 8 E-UTRAN frequencies. For each E-UTRAN frequency, zero or more E-UTRAN neighbour cells may be specified that are not allowed for cell reselection. The list of not allowed cells is defined in the Not Allowed Cells IEs.

Each EARFCN in each instance of the Repeated E-UTRAN Neighbour Cells IE is added to the E-UTRAN Neighbour Cell list in the order in which it is received.

6.2.3.17.3 Test description

6.2.3.17.3.1 Pre-test conditions

System Simulator:

- Cell 24 is serving cell.
- Cell 1 and Cell 3 off cells.

UE:

None.

Preamble:

- The UE is in state Registered, IDLE (GPRS) on Cell 24 (3GPP TS 51.010-1 clause 41.2.8.1.1).

6.2.3.17.3.2 Test procedure sequence

Table 6.2.3.17.3.2-1: Time instances of cell power level and parameter changes

	Parameter	Unit	Cell 1	Cell3	Cell 24	Remark
T1	Cell-specific RS EPRE	dBm/15kHz	-60	-80	-	
	Qrxlevmin	dBm	-110	-110	-	
	Srxlev*	dB	50	30	-	
	RF Signal level	dBm			-80	
	C1	dB			21	

Note: Srxlev and C1 is calculated in the UE

Table 6.2.3.17.3.2-2: Main behaviour

St	Procedure	Message Sequence		TP	Verdict
		U – S	Message		
1	SS adjusts cell levels according to row T1 of table 6.2.2.17.3.2-1	-	-	-	-
2	Check: Does the test result of generic test procedure in TS 36.508 subclause 6.4.2.7A-2 indicate that the UE is camped on E-UTRAN Cell 3? NOTE: The UE performs a TAU procedure and the RRC connection is released.	-	-	1	-

6.2.3.17.3.3 Specific message contents

Table 6.2.3.17.3.3-1 Repeated E-UTRAN Neighbour Cells struct of SI2Quater for Cell 24

Derivation Path: 36.508 Table 4.4.5-1			
Information Element	Value/remark	Comment	Condition
Serving Cell Priority Parameters Description::= {			
GERAN_PRIORITY	7		
THRESH_GSM_low	15	MS is always allowed to reselect to lower priority cells	
}			
Repeated E-UTRAN Neighbour Cells ::= SEQUENCE {			
EARFCN	Same as Cell 1	This field specifies the E-UTRA Absolute Radio Frequency Channel Number as defined in 3GPP TS 36.104.	
Measurement Bandwidth	Same as Cell 1		
E-UTRAN_PRIORITY	'0'	Not Present	
E-UTRAN_QRXLEVMIN	15 (-110 dBm)		
}			
{			
EARFCN	Same as Cell 3	This field specifies the E-UTRA Absolute Radio Frequency Channel Number as defined in 3GPP TS 36.104.	
Measurement Bandwidth}	Same as Cell 3		
E-UTRAN_PRIORITY	2		
THRESH_E-UTRAN_low	'01010'B	Actual value = 20 dB	
E-UTRAN_QRXLEVMIN	15 (-110 dBm)		
}			

6.2.3.18 Inter-RAT Cell Reselection / from GSM_Idle/GPRS Packet_Idle to E-UTRA (blacklisted E-UTRA cells)

6.2.3.18.1 Test Purpose (TP)

(1)

```

with { UE in GSM/GPRS Registered state and no RR connection }
ensure that {
  when { Priority of E-UTRA neighbour cells are set higher than GERAN cell. Among two E-UTRA
neighbor cells, the cell with higher priority is blacklisted }
  then { UE ignores black listed E-UTRA neighbour cell
}

```

6.2.3.18.2 Conformance requirements

References: The conformance requirements covered in the present TC are specified in: TS 45.008, clause 6.6.6 & TS 44.018, clause 3.4.1.2.1.1a.

[TS 45.008, clause 6.6.6]

Cell reselection to a cell of another inter-RAT frequency shall be performed if any of the conditions below (to be evaluated in the order shown) is satisfied:

- The $S_{\text{non-serving_XXX}}$ of one or more cells of a higher priority inter-RAT frequency is greater than THRESH_XXX_high (or, in case of an E-UTRAN target, $\text{THRESH_E-UTRAN_high_Q}$, if provided) during a time interval $T_{\text{reselection}}$; in that case, the mobile station shall consider the cells for reselection in decreasing order of priority and, for cells of the same inter-RAT frequency or of inter-RAT frequencies of equal priority, in decreasing order of $S_{\text{non-serving_XXX}}$, and reselect the first cell that satisfies the conditions above;

....

E-UTRAN cells which are included in the list of not allowed cells shall not be considered as candidates for cell reselection. If the strongest cells on a E-UTRAN frequency are included in the list of not allowed cells, the mobile station may reselect the strongest valid cell (see subclause 8.4.7) on that frequency.

[TS 44.018, clause 3.4.1.2.1.1a]

This applies only to a multi-RAT MS supporting E-UTRAN. One or more instances of the Measurement Information message or SI2quater message may provide E-UTRAN Neighbour Cell Description information in one or more instances of the Repeated E-UTRAN Neighbour Cells IE. This is used to build the E-UTRAN Neighbour Cell list. The E-UTRAN Neighbour Cell list may contain up to 8 E-UTRAN frequencies. For each E-UTRAN frequency, zero or more E-UTRAN neighbour cells may be specified that are not allowed for cell reselection. The list of not allowed cells is defined in the Not Allowed Cells IEs.

Each EARFCN in each instance of the Repeated E-UTRAN Neighbour Cells IE is added to the E-UTRAN Neighbour Cell list in the order in which it is received.

6.2.3.18.3 Test description

6.2.3.18.3.1 Pre-test conditions

System Simulator:

- Cell 24 is serving cell.
- Cell 1 and Cell 3 off cells

None.

Preamble:

- The UE is in state Registered, IDLE (GPRS) on Cell 24 (3GPP TS 51.010-1 clause 41.2.8.1.1).

6.2.3.18.3.2 Test procedure sequence

Table 6.2.3.18.3.2-1: Time instances of cell power level and parameter changes

	Parameter	Unit	Cell 1	Cell3	Cell 24	Remark
T1	Cell-specific RS EPRE	dBm/15kHz	-60	OFF	-	
	Qrxlevmin	dBm	-110	-	-	
	Srxlev*	dB	50	-	-	
	RF Signal level	dBm	-	-	-80	
	C1	-	-	-	21	
T2	Cell-specific RS EPRE	dBm/15kHz	-60	-80	-	
	Qrxlevmin	dBm	-110	-110	-	
	Srxlev*	dB	50	30	-	
	RF Signal level	dBm	-	-	-80	
	C1	dB	-	-	21	

Note: Srxlev and C1 is calculated in the UE

Table 6.2.3.18.3.2-2: Main behaviour

St	Procedure	Message Sequence		TP	Verdict
		U – S	Message		
1	SS adjusts cell levels according to row T1 of table 6.2.2.18.3.2-1	-	-	-	-
2	Check: Does the UE send an RRCConnectionRequest on Cell 1 within the next 75 s (70 s+T_reselect)?	-->	RRCConnectionRequest	1	F
3	SS adjusts cell levels according to row T2 of table 6.2.2.18.3.2-1	-	-	-	-
4	Check: Does the test result of generic test procedure in TS 36.508 Table 6.4.2.7A-2 indicate that the UE is camped on E-UTRAN Cell 3?	-	-	1	-

6.2.3.18.3.3 Specific message contents

Table 6.2.3.18.3.3-1 Repeated E-UTRAN Neighbour Cells struct of SI2Quater for Cell 24

Derivation Path: 36.508 Table 4.4.5-1			
Information Element	Value/remark	Comment	Condition
Serving Cell Priority Parameters Description ::= {			
THRESH_Priority_Search	'0000'B	Actual value=0	
}			
Repeated E-UTRAN Neighbour Cells ::=			
SEQUENCE {			
EARFCN	Same as Cell 1	This field specifies the E-UTRA Absolute Radio Frequency Channel Number as defined in 3GPP TS 36.104.	
Measurement Bandwidth	Same as Cell 1		
E-UTRAN_PRIORITY	'111'B	Actual value=7	
E-UTRAN_QRXLEVMIN	15 (-110 dBm)		
}			
{			
EARFCN	Same as Cell 3	This field specifies the E-UTRA Absolute Radio Frequency Channel Number as defined in 3GPP TS 36.104.	
Measurement Bandwidth	Same as Cell 3		
E-UTRAN_PRIORITY	'101'B	Actual value=5	
E-UTRAN_QRXLEVMIN	15 (-110 dBm)		
}			
Repeated E-UTRAN Not Allowed Cells struct > ::=			
{			
Not Allowed Cells : < PCID Group IE >>{			
PCID}	'000000000'B	PCID=0, Meaning that the Cell 1 which have PCID=0 will not be allowed	
E-UTRAN_FREQUENCY_INDEX	'000'B	Cell 1	
}			

6.2.3.19 Redirection to E-UTRA upon the release of the CS connection

6.2.3.19.1 Test Purpose (TP)

(1)

with { UE in CS Active state }

```

ensure that {
  when { UE receives CHANNEL RELEASE message including an IE Cell selection indicator after release of all TCH and SDCCH, including E-UTRAN carrier frequency of Cell 1 }
  then { UE enters RRC_IDLE state on E-UTRAN Carrier included in IE Cell selection indicator info }
}

```

6.2.3.19.2 Conformance requirements

References: The conformance requirements covered in the current TC are specified in: TS 44.018, clause 3.4.13.1.1, and TS 45.008, clause 6.7.1.

[TS 44.018, clause 3.4.13.1.1]

The CHANNEL RELEASE message may include the information element "Cell selection indicator after release of all TCH and SDCCH" which shall be used by the mobile station in its cell selection algorithm after release of all TCH and SDCCH (see 3GPP TS 45.008).

The CHANNEL RELEASE message may include Individual priorities IE to convey individual priorities information to the MS (see subclause 3.2.4). When the MS receives an Individual priorities IE it shall start an instance of timer T3230 with the value supplied in the Individual priorities IE.

[TS 45.008, clause 6.7.1]

In *A/Gb mode*, when the MS releases all TCHs or SDCCH and returns to idle mode, packet idle mode or MAC-Idle state, it shall, as quickly as possible, camp on the cell whose channel has just been released. Similarly in *Iu mode*, when the MS releases all DBPSCHs and returns to MAC-Idle state, it shall, as quickly as possible, camp on the cell whose channel has just been released. However, in both modes (*A/Gb mode* or *Iu mode*), if the CHANNEL RELEASE message contains a "cell selection indicator after release of all TCH and SDCCH" (see TS 44.018), the MS shall as quickly as possible camp on an indicated GSM, UTRAN or E-UTRAN cell that has been identified by the CHANNEL RELEASE message. If UTRAN or E-UTRAN frequency only is indicated the MS shall as quickly as possible camp on a suitable cell of this frequency.

In case the "cell selection indicator after release of all TCHs and SDCCH" is not present, then if the full (P)BCCH data for that cell was not decoded in the preceding 30s, the MS shall attempt to decode the full (P)BCCH data. Until the MS has decoded the (P)BCCH data required for determining the paging group, it shall also monitor all paging blocks on timeslot 0 of the BCCH carrier or, for GPRS if PCCCH exists and for *Iu mode*, on the PDCH indicated on BCCH for possible paging messages that might address it. If the MS receives a page before having decoded the full (P)BCCH data for the cell, the MS shall store the page and respond once the relevant (P)BCCH data has been decoded, provided that the cell is not barred and the MS's access class is allowed. Reception of full BCCH(BA) information is not required before responding to the page.

If the CHANNEL RELEASE does not contain a "cell selection indicator after release of all TCH and SDCCH", and the MS has the knowledge that the cell whose channel is being released is not suitable (see 3GPP TS 43.022), the MS is allowed to camp on any suitable cell.

If the CHANNEL RELEASE contains a "cell selection indicator after release of all TCH and SDCCH" and

- the MS cannot find a suitable cell from the indicated ones within 10 s, or
- none of the indicated cells are suitable,

the MS is allowed to camp on any suitable cell.

NOTE: The received signal level measurements on surrounding cells made during the last 5 seconds on the TCH or SDCCH in *A/Gb mode*, or on the DBPSCH in *Iu mode*, may be averaged and used, where possible, to speed up the process. However, it should be noted that the received signal level monitoring while on the TCH or SDCCH in *A/Gb mode*, or on the DBPSCH in *Iu mode*, is on carriers in BA (SACCH), while the carriers to be monitored for cell reselection are in BA (BCCH) or BA (GPRS).

After decoding the relevant (P)BCCH data the MS shall perform cell reselection as specified in 3GPP TS 43.022.

6.2.3.19.3 Test description

6.2.3.19.3.1 Pre-test conditions

System Simulator:

- 2 cells, one GSM and one E-UTRA cell:
 - Cell 24 GSM serving cell
 - Cell 1 suitable neighbour E-UTRA cell

UE:

None

Preamble:

U10 Active state on cell 24.as per TS 51.010 clause 40.4.3.22

6.2.3.19.3.2 Test procedure sequence

Table 6.2.3.19.3.2-1: Main behaviour

St	Procedure	Message Sequence		TP	Verdict
		U – S	Message		
1	SS initiate a disconnect call	<--	DISCONNECT	-	-
2	UE sends RELEASE message	-->	RELEASE	-	-
3	SS sends RELEASE COMPLETE message	<--	RELEASE COMPLETE	-	-
4	The SS transmits an CHANNEL RELEASE message with IE, <i>Cell selection indicator after release of all TCH and SDCCH</i> including E-UTRAN carrier frequency of Cell 1	<--	CHANNEL RELEASE	-	-
5	Check: Does the test result of generic test procedure in TS 36.508 Table 6.4.2.7A-2 indicate that the UE is camped on E-UTRAN Cell 1?	-	-	1	-

6.2.3.19.3.3 Specific message or IE contents

Table 6.2.3.19.3.3-1: Channel Release message (step 4, Table 6.2.3.19.3.2-1]

Information Element	Value/remark	Comment	Condition
Protocol Discriminator	0110	RR Management	
Skip Indicator	0000		
Message Type	00001101		
RR Cause			
- RR Cause Value	Normal event.		
<Cell Selection Indicator after release of all TCH and SDCCH IE > ::=			
E-UTRAN Description	011	{ 1 <E-UTRAN Description : < E-UTRAN Description struct >> }	
EARFCN	Same as cell 1	This field specifies the E-UTRA Absolute Radio Frequency Channel Number as defined in 3GPP TS 36.104.	
Measurement Bandwidth	Same as cell 1		
TARGET_PCID	Same as cell 1		

6.2.3.20 Void

6.2.3.21 Inter-RAT cell reselection / From GPRS Packet_Transfer (NC0 mode) to E-UTRA

6.2.3.21.1 Test Purpose (TP)

(1)

```

with { UE in GPRS Registered state with active packet data transfer in NC0 mode }
ensure that {
  when { UE detects the cell re-selection criteria are met for the cell which belongs to the higher
priority inter-RAT E-UTRA cell}
  then { UE reselects the cell which belongs to the higher priority inter-RAT E-UTRA cell }
}

```

6.2.3.21.2 Conformance requirements

References: The conformance requirements covered in the present TC are specified in: TS 45.008, clause 10.1.3.3 & TS 44.018, clause 3.4.1.2.1.1a.

[TS 45.008, clause 10.1.3.3]

The algorithm in this subclause shall be used for inter-RAT cell reselection if priority information is available to the MS and threshold information is provided by the network. The network shall provide priority information if E-UTRAN frequencies are included in the neighbour cell list. The mobile station may apply either priorities broadcast in system information or individual priorities received through dedicated signalling. The rules regarding which set of priorities shall apply are defined in 3GPP TS 44.018 and 3GPP TS 44.060.

NOTE: Throughout the specification, the phrase “neighbour cell list” will include also the E-UTRAN Neighbour Cell list and/or the GPRS E-UTRAN Neighbour Cell list where appropriate.

If the GPRS 3G Cell Reselection list or the GPRS E-UTRAN Neighbour Cell list include frequencies of other radio access technologies, the MS shall, at least every 5 seconds update the value RLA_P for the serving cell and each of the at least 6 strongest non serving GSM cells.

The MS shall then reselect a suitable (see 3GPP TS 25.304 for UTRAN and 3GPP TS 36.304 for E-UTRAN) cell of another radio access technology if the criteria below are satisfied. $S_{\text{non-serving_XXX}}$ is the measurement quantity of a non-serving inter-RAT cell and XXX indicates the other radio access technology/mode. $S_{\text{non-serving_XXX}}$ is defined in subclause 6.6.6.

Cell reselection to a cell of another inter-RAT frequency shall be performed if any of the conditions below (to be evaluated in the order shown) is satisfied:

- The $S_{\text{non-serving_XXX}}$ of one or more cells of a higher priority inter-RAT frequency is greater than THRESH_XXX_high during a time interval $T_{\text{reselection}}$; in that case, the mobile station shall consider the cells for reselection in decreasing order of priority and, for cells of the same inter-RAT frequency, in decreasing order of $S_{\text{non-serving_XXX}}$, and reselect the first cell that satisfies the conditions above;
- The value of S_{serving} is lower than $\text{THRESH_serving_low}$ for the serving cell and all measured GSM cells; in this case, the mobile station shall consider for reselection the inter-RAT cells in the following order, and reselect the first one that satisfies the following criteria:
 - cells of a lower priority inter-RAT frequency whose $S_{\text{non-serving_XXX}}$ is greater than THRESH_XXX_low during a time interval $T_{\text{reselection}}$; these cells shall be considered in decreasing order of priority and, for cells of the same RAT, in decreasing order of $S_{\text{non-serving_XXX}}$;
 - if no cells satisfy the criterion above, inter-RAT cells for which, during a time interval $T_{\text{reselection}}$, $S_{\text{non-serving_XXX}}$ is higher than S_{serving} by at least a specific hysteresis H_{PRIO} ; these cells shall be considered in decreasing order of $S_{\text{non-serving_XXX}}$.

A UTRAN FDD cell shall only be reselected if, in addition to the criteria above, its measured E_c/N_0 value is equal to or greater than $\text{FDD_Qmin} - \text{FDD_Qmin_Offset}$.

Cell reselection to a cell of another radio access technology (e.g. UTRAN or E-UTRAN) shall not occur within [5] seconds after the MS has reselected a GSM cell from an inter-RAT cell if a suitable GSM cell can be found.

If the mobile station applies individual priorities received through dedicated signalling and priority information is available only for some inter-RAT frequencies, cells belonging to frequencies for which no individual priority is available or no threshold is broadcast in system information shall not be considered for measurement and for cell reselection.

If a mobile station in camped normally state (see 3GPP TS 43.022) applies individual priorities received through dedicated signalling and no priority is available for the serving cell, the mobile station shall consider any GSM cell (including the serving cell) to have lowest priority (i.e. lower than the eight network configured values).

A mobile station in camped on any cell state (see 3GPP TS 43.022) shall ignore individual priorities received through dedicated signalling and shall apply priorities received from the system information of the serving cell while attempting to find a suitable cell. If the mobile station supports CS voice services, the MS shall avoid reselecting acceptable (but not suitable) E-UTRA cells regardless of the priorities provided in system information.

NOTE: If the MS is camping on an acceptable cell, individual priorities are not discarded until an event leading to their deletion occurs.

In case of a reselection attempt towards a barred UTRAN cell, the MS shall abandon further reselection attempts towards this UTRAN cell as defined by the Tbarred value on the barred UTRAN cell (see 3GPP TS 25.331).

NOTE: It is FFS whether a similar requirement should be added in case of a reselection attempt towards a barred E-UTRAN cell.

NOTE: Requirements for cells belonging to “forbidden LAs for roaming” should be included here.

[TS 44.018, clause 3.4.1.2.1.1a]

This applies only to a multi-RAT MS supporting E-UTRAN. One or more instances of the Measurement Information message or SI2quater message may provide E-UTRAN Neighbour Cell Description information in one or more instances of the Repeated E-UTRAN Neighbour Cells IE. This is used to build the E-UTRAN Neighbour Cell list. The E-UTRAN Neighbour Cell list may contain up to 8 E-UTRAN frequencies. For each E-UTRAN frequency, zero or more E-UTRAN neighbour cells may be specified that are not allowed for cell reselection. The list of not allowed cells is defined in the Not Allowed Cells IEs.

Each EARFCN in each instance of the Repeated E-UTRAN Neighbour Cells IE is added to the E-UTRAN Neighbour Cell list in the order in which it is received.

6.2.3.21.3 Test description

6.2.3.21.3.1 Pre-test conditions

System Simulator:

2 cells, one GSM and one E-UTRA cell:

- Cell 24 GSM serving cell
- Cell 1 suitable neighbour E-UTRA cell Cell 1 is off.

UE:

None.

Preamble:

- The UE is GPRS attached and the PDP context 2 activated according to [23].

6.2.3.21.3.2 Test procedure sequence

Table 6.2.3.21.3.2-1 illustrates the downlink power levels and other changing parameters to be applied for the cells at various time instants of the test execution. The exact instants on which these values shall be applied are described in the texts in this clause.

Table 6.2.3.21.3.2-1: Time instances of cell power level and parameter changes for E-UTRA cell

	Parameter	Unit	Cell 1	Remark
T1	Cell-specific RS EPRE	dBm/15kHz	-70	
	Srxlev*	dB	30	Srxlev _{Cell 1} >THRESH_E-UTRAN_high
Note: Srxlev is calculated in the UE				

Table 6.2.3.21.3.2-2: Main behaviour

St	Procedure	Message Sequence		TP	Verdict
		U -- S	Message		
1	UE is brought into downlink packet transfer mode	-	-	-	-
-	EXCEPTION: Step 2 is repeated 5 times.	-	-	-	-
2	The SS sends one downlink data block	-	-	-	-
3	Void	-	-	-	-
4	SS adjusts cell levels for Cell 1 according to row T1 of table 6.2.3.21.3.2-1	-	-	-	-
-	EXCEPTION: Step 5 is repeated until the parallel behaviour in table 6.2.3.21.3.2-3 takes place.	-	-	-	-
5	The SS sends one downlink data block	-	-	-	-

Table 6.2.3.21.3.2-3: Parallel behaviour

St	Procedure	Message Sequence		TP	Verdict
		U -- S	Message		
1	Check: Does the test result of generic test procedure in TS 36.508 Table 6.4.2.7A-1 indicate that the UE is camped on E-UTRAN Cell 1?	-	-	1	-

6.2.3.21.3.3 Specific message contents

None.

6.2.3.22 Void

6.2.3.23 Inter-RAT Cell Reselection from GPRS Packet transfer to E-UTRA in CCN Mode(PACKET CELL CHANGE CONTINUE)

6.2.3.23.1 Test Purpose (TP)

(1)

```
with { UE in GPRS Registered state with active packet data transfer in NC1 mode }
ensure that {
  when { UE detects the cell re-selection criteria are met for the cell and in CCN mode }
  then { UE leaves CCN mode, reselects the E-UTRA cell }
}
```

6.2.3.23.2 Conformance requirements

References: The conformance requirements covered in the present TC are specified in: TS 45.008 section 6.6.6, 10.1.3.3, 10.1.4 and TS44.060 section 5.5.1.1a.2 and 5.5.2.3

[TS 45.008, section 6.6.6 and 10.1.3.3]

The algorithm in this subclause shall be used for inter-RAT cell reselection if priorities are available to the MS and thresholds are provided by the network, and if the mobile station supports priority based inter-RAT cell re-selection and priority information for the serving cell is provided by the network. A mobile station supporting E-UTRAN shall support priority based inter-RAT cell re-selection towards all the supported RATs. A mobile station not supporting E-

UTRAN and supporting UTRAN and supporting priority based reselection from UTRAN to GERAN shall support priority based inter-RAT cell re-selection towards UTRAN

The network shall provide priority information if E-UTRAN frequencies are included in the neighbour cell list. If priority information is available to the mobile station and the mobile station supports priority based inter-RAT cell re-selection, the algorithm in this subclause shall be used for inter-RAT reselection towards all RATs.

If the 3G Cell Reselection list or the E-UTRAN Neighbour Cell list include frequencies of other radio access technologies, the MS shall, at least every 5 s update the value RLA_C for the serving cell and each of the at least 6 strongest non serving GSM cells.

The MS shall then reselect a suitable (see 3GPP TS 25.304 for UTRAN and 3GPP TS 36.304 for E-UTRAN) cell of another radio access technology if the criteria below are satisfied. S_non-serving_XXX is the measurement quantity of a non-serving inter-RAT cell and XXX indicates the other radio access technology/mode and is defined as follows:

- for a E-UTRAN cell, is the measured RSRP value for the cell minus E-UTRAN_QRXLEVMIN for the cell's frequency if THRESH_E-UTRAN_high_Q is not provided; otherwise, if THRESH_E-UTRAN_high_Q is provided, is the measured RSRQ value for the cell minus E-UTRAN_QQUALMIN for the cell's frequency.

[TS 45.008, clause 10.1.4]

The network may request measurement reports from the MS and control its cell re-selection. This is indicated by the parameter NETWORK_CONTROL_ORDER. The meaning of the different parameter values is specified as follows:

NC0	Normal MS control The MS shall perform autonomous cell re-selection.
NC1	MS control with measurement reports The MS shall send measurement reports to the network as defined in subclause 10.1.4.1. The MS shall perform autonomous cell re-selection.
NC2	Network control The MS shall send measurement reports to the network as defined in subclause 10.1.4.1. The MS shall only perform autonomous cell re-selection when the reselection is triggered by a downlink signalling failure as defined in subclause 6.5 or a random access failure as defined in 3GPP TS 44.018 and 3GPP TS 44.060 or if the cell is barred or the C1 criterion falls below zero. The MS shall only determine whether the cell is barred once camped on the cell.
RESET	The MS shall return to the broadcast parameters. Only sent on PCCCH or PACCH.

All signalling for support of network controlled cell re-selection and measurement reports are defined in 3GPP TS 44.060 section 5.5.1.1a.2 and 5.5.2.3.

6.2.3.23.3 Test description

6.2.3.23.3.1 Pre-test conditions

System Simulator:

- Cell 24 is serving GERAN Cell
- Cell 1 is suitable E-UTRAN Cell

UE:

None.

Preamble:

- The UE is GPRS attached and the PDP context 2 activated according to section 41.2.8.1.1 and 40.4.3.15 of TS51010-1

6.2.3.23.3.2 Test procedure sequence

Tables 6.2.3.23.3.2-1 & 6.2.3.23.3.2-2 illustrates the downlink power levels and other changing parameters to be applied for the cells at various time instants of the test execution. Row marked "T0" denotes the initial conditions after

the preamble, while rows marked "T1" are to be applied subsequently. The exact instants on which these values shall be applied are described in the texts in this clause.

Table 6.2.3.23.3.2-1: Time instances of cell power level and parameter changes for E-UTRA cell

	Parameter	Unit	Cell 1	Cell24	Remark
T1	Cell-specific RS EPRE	dBm/15kHz	-60	No change	The power level is such that $SrxlevCell\ 1 > 0$
Note: $Srxlev$ is calculated in the UE					

Table 6.2.3.23.3.2-3: Main behaviour

St	Procedure	Message Sequence		TP	Verdict
		U - S	Message		
1	Uplink dynamic allocation two phase access according to TS 51.010 clause 40.4.3.9 using $n=5000$ octets of data	-	-	-	-
2	EXCEPTION: MS continues to transfer data and send measurement reports for cell 1 in PACKET MEASUREMENT REPORT in parallel to steps 3 to 4	-	-	-	-
3	SS adjusts cell levels for Cell 1 according to row T1 of table 6.2.3.23.3.2-1	-	-	-	-
4	The UE transmits PACKET CELL CHANGE NOTIFICATION to E-UTRA cell on 24	-->	PACKET CELL CHANGE NOTIFICATION		
5	The SS sends PACKET CELL CHANGE CONTINUE for cell 1 as the target cell on cell 24	<--	PACKET CELL CHANGE CONTINUE	-	-
6	Check: Does UE send RRC CONNECTION REQUEST on cell1?	-->	RRCConnectionRequest	1	P
7	SS sends RRCConnectionSetup to the UE	<--	RRCConnectionSetup	-	-
8	Check: Does the UE send RRCConnectionSetupComplete message on cell 1?	-->	RRCConnectionSetupComplete	1	P

6.2.3.23.3.3 Specific message contents

Table 6.2.3.23.3.3-1: SI2Quater for Cell 24[Preamble]

Derivation Path: 36.508 table 4.4.5-1			
Information Element	Value/remark	Comment	Condition
NC Measurement parameters ::= {			
NETWORK_CONTROL_ORDER	'01'B	NC1	
NC_REPORTING_PERIOD_I	'111'B	61.44 sec	
NC_REPORTING_PERIOD_T	'111'B	61.44 sec	
}			
Serving Cell Priority Parameters ::= {			
GERAN_PRIORITY	'001'B	This field specifies GERAN cell priority	
}			
Repeated E-UTRAN Neighbour Cells ::= {			
EARFCN	Same as cell 1	This field specifies the E-UTRA Absolute Radio Frequency Channel Number as defined in 3GPP TS 36.104.	
Measurement Bandwidth	Same as cell 1		
E-UTRAN_PRIORITY	'100'B	Same as cell 1	
E-UTRAN_QRXLEVMIN	17 (-106 dBm)		
}			
E-UTRAN Parameters Description struct ::= {			
E-UTRAN_CCN_ACTIVE	1	CCN is enabled in the cell	
}			

Table 6.2.3.23.3.3-2: PACKET CELL CHANGE CONTINUE (step 5, Table 6.2.3.23.3.3-2)

Information Element	Value/remark	Comment	Condition
Packet Cell Change Continue message content ::=			
PAGE_MODE	'00'B	Normal Paging	
Global TFI	TFI of the uplink TBF		

Table 6.2.3.23.3.3-3: SI 13 for Cell 24 (Preamble)

Information Element	Value/remark	Comment	Condition
NETWORK_CONTROL_ORDER	'01'B	NC1	

6.2.3.24 Inter-RAT Cell Reselection from GPRS Packet transfer to E-UTRA in CCN Mode (PACKET CELL CHANGE ORDER)

6.2.3.24.1 Test Purpose (TP)

(1)

```

with { UE in GPRS Registered state with active packet data transfer in NC0 mode }
ensure that {
  when { UE detects the cell re-selection criteria are met for the cell and in CCN mode }
  then { UE leaves CCN mode, reselects the E-UTRA cell }
}

```

6.2.3.24.2 Conformance requirements

References: The conformance requirements covered in the present TC are specified in: TS 45.008 section 6.6.6, 10.1.3.3, 10.1.4 and TS 44.060 section 5.5.1.1a.2 and 5.5.2.3

[TS 44.060, section 5.5.1.1a.2]

A mobile station, which has *CCN Enabled*, can enter *CCN Mode*.

The mobile station shall enable CCN when the following criteria are fulfilled:

- the mobile station is camping on a cell (see 3GPP TS 45.008); and
- the network indicates CCN ACTIVE/3G CCN ACTIVE/E-UTRAN CCN ACTIVE either in system information to all mobile stations in the cell or in an individual order to a certain mobile station; and
- the mobile station is neither in dedicated mode nor Dual Transfer Mode; and
- the mobile station is in NC0 or in NC1 mode; and
- the mobile station is in Packet Transfer mode.

The CCN procedures and the criteria for entering and leaving CCN mode are specified in sub-clauses 8.8.2 and 8.8.3.

[TS 45.008, section 6.6.6 and 10.1.3.3]

The algorithm in this subclause shall be used for inter-RAT cell reselection if priorities are available to the MS and thresholds are provided by the network, and if the mobile station supports priority based inter-RAT cell re-selection and priority information for the serving cell is provided by the network. A mobile station supporting E-UTRAN shall support priority based inter-RAT cell re-selection towards all the supported RATs. A mobile station not supporting E-UTRAN and supporting UTRAN and supporting priority based reselection from UTRAN to GERAN shall support priority based inter-RAT cell re-selection towards UTRAN

The network shall provide priority information if E-UTRAN frequencies are included in the neighbour cell list. If priority information is available to the mobile station and the mobile station supports priority based inter-RAT cell re-selection, the algorithm in this subclause shall be used for inter-RAT reselection towards all RATs.

If the 3G Cell Reselection list or the E-UTRAN Neighbour Cell list include frequencies of other radio access technologies, the MS shall, at least every 5 s update the value RLA_C for the serving cell and each of the at least 6 strongest non serving GSM cells.

The MS shall then reselect a suitable (see 3GPP TS 25.304 for UTRAN and 3GPP TS 36.304 for E-UTRAN) cell of another radio access technology if the criteria below are satisfied. $S_{\text{non-serving_XXX}}$ is the measurement quantity of a non-serving inter-RAT cell and XXX indicates the other radio access technology/mode and is defined as follows:

- for a E-UTRAN cell, is the measured RSRP value for the cell minus E-UTRAN_QRXLEVMIN for the cell's frequency if THRESH_E-UTRAN_high_Q is not provided; otherwise, if THRESH_E-UTRAN_high_Q is provided, is the measured RSRQ value for the cell minus E-UTRAN_QQUALMIN for the cell's frequency.

[TS 45.008, clause 10.1.4]

The network may request measurement reports from the MS and control its cell re-selection. This is indicated by the parameter NETWORK_CONTROL_ORDER. The meaning of the different parameter values is specified as follows:

NC0	Normal MS control The MS shall perform autonomous cell re-selection.
NC1	MS control with measurement reports The MS shall send measurement reports to the network as defined in subclause 10.1.4.1. The MS shall perform autonomous cell re-selection.
NC2	Network control The MS shall send measurement reports to the network as defined in subclause 10.1.4.1. The MS shall only perform autonomous cell re-selection when the reselection is triggered by a downlink signalling failure as defined in subclause 6.5 or a random access failure as defined in 3GPP TS 44.018 and 3GPP TS 44.060 or if the cell is barred or the C1 criterion falls below zero. The MS shall only determine whether the cell is barred once camped on the cell.
RESET	The MS shall return to the broadcast parameters. Only sent on PCCCH or PACCH.

All signalling for support of network controlled cell re-selection and measurement reports are defined in 3GPP TS 44.060 section 5.5.1.1a.2 and 5.5.2.3.

6.2.3.24.3 Test description

6.2.3.24.3.1 Pre-test conditions

System Simulator:

- Cell 24 is serving GERAN Cell
- Cell 1 is OFF

UE:

None.

Preamble:

- The UE is GPRS attached and the PDP context 2 activated according to section 41.2.8.1.1 and 40.4.3.15 of TS 51010-1

6.2.3.24.3.2 Test procedure sequence

Table 6.2.3.23.3.2-1 illustrates the downlink power levels and other changing parameters to be applied for the cells at various time instants of the test execution. The exact instants on which these values shall be applied are described in the texts in this clause.

Table 6.2.3.24.3.2-1: Time instances of cell power level and parameter changes for E-UTRA cell

	Parameter	Unit	Cell 1	Cell24	Remark
T1	Cell-specific RS EPRE	dBm/15kHz	-60	Same as before	The power level is such that $SrxlevCell\ 1 > 0$
Note: Srxlev is calculated in the UE					

Table 6.2.3.24.3.2-2: Main behaviour

St	Procedure	Message Sequence		TP	Verdict
		U - S	Message		
1	Uplink dynamic allocation two phase access according to TS 51.010 clause 40.4.3.9 using $n=10000$ octets of data	-	-	-	-
-	EXCEPTION: MS continues to transfer data in parallel to steps 2 to 4	-	-	-	-
2	SS adjusts cell levels for Cell 1 according to row T1 of table 6.2.3.24.3.2-1	-	-	-	-
3	The UE transmits PACKET CELL CHANGE NOTIFICATION to E_UTRA cell on 24	-->	PACKET CELL CHANGE NOTIFICATION		
4	The SS sends PACKET CELL CHANGE ORDER for cell 1 as the target cell on cell 24	<--	PACKET CELL CHANGE ORDER	-	-
5	Check: Does UE send RRC CONNECTION REQUEST on cell1?	-->	RRCConnectionRequest	1	P
6	SS sends RRCConnectionSetup to the UE	<--	RRCConnectionSetup	-	-
7	Check: Does the UE send RRCConnectionSetupComplete message on cell 1?	-->	RRCConnectionSetupComplete	1	P

6.2.3.24.3.3 Specific message contents

Table 6.2.3.24.3.3-1 Repeated E-UTRAN Neighbour Cells struct of SI2Quater for Cell 24[Preamble]

Derivation Path: 36.508 table 4.4.5-1			
Information Element	Value/remark	Comment	Condition
Serving Cell Priority Parameters ::=			
{			
GERAN_PRIORITY	'001'B	This field specifies GERAN cell priority	
}			
Repeated E-UTRAN Neighbour Cells ::=			
{			
EARFCN	Same as cell 1	This field specifies the E-UTRA Absolute Radio Frequency Channel Number as defined in 3GPP TS 36.104.	
Measurement Bandwidth	Same as cell 1		
}			
E-UTRAN Parameters Description struct ::=			
{			
E-UTRAN_CCN_ACTIVE	1	CCN is enabled in the cell	
}			

Table 6.2.3.24.3.3-2: PACKET CELL CHANGE ORDER (step 5, Table 6.2.3.24.3.2-2)

Information element	Value/remark
< PAGE_MODE : bit (2) >	00 (Normal Paging)
0 10	0
< GLOBAL_TFI : Global TFI IE >	<5 bit Uplink TFI>
0 1	1
Message Escape	00
< IMMEDIATE_REL >	1 (Immediate abort of operation in the old cell is required)
0 1<UTRAN FDD Target cell IE>	0 (not present)
0 1<UTRAN TDD Target cell IE>	0 (not present)
<i>Additions in Rel-5</i>	1
0 1 < G-RNTI extension	0 (not present)
<i>Additions in Rel-8</i>	1
0 1<E-UTRAN Target cell IE>	1
EARFCN	EARFCN of the cell 1
0 1 < Measurement Bandwidth	0 (not present)
Physical Layer Cell identity	PCID of the cell 1
0 1 < Individual Priorities	0 (not present)

6.2.3.25 Void

6.2.3.26 Inter-RAT Autonomous Cell Reselection GPRS Packet_transfer to E-UTRA (NC1 mode)

6.2.3.26.1 Test Purpose (TP)

(1)

```

with { UE in GPRS Registered state with active packet data transfer in NC1 mode }
ensure that {
  when { UE detects the cell re-selection criteria are met for the cell which belongs to the higher
priority inter-RAT E-UTRA cell }
  then { UE performs autonomous, reselection to the E-UTRA cell }
}

```

6.2.3.26.2 Conformance requirements

References: The conformance requirements covered in the present TC are specified in: TS 45.008 section 6.6.6, 10.1.3.3 and 10.1.4:

[TS 45.008, section 6.6.6 and 10.1.3.3]

The algorithm in this subclause shall be used for inter-RAT cell reselection if priorities are available to the MS and thresholds are provided by the network, and if the mobile station supports priority based inter-RAT cell re-selection and priority information for the serving cell is provided by the network. A mobile station supporting E-UTRAN shall support priority based inter-RAT cell re-selection towards all the supported RATs. A mobile station not supporting E-UTRAN and supporting UTRAN and supporting priority based reselection from UTRAN to GERAN shall support priority based inter-RAT cell re-selection towards UTRAN

The network shall provide priority information if E-UTRAN frequencies are included in the neighbour cell list. If priority information is available to the mobile station and the mobile station supports priority based inter-RAT cell re-selection, the algorithm in this subclause shall be used for inter-RAT reselection towards all RATs.

If the 3G Cell Reselection list or the E-UTRAN Neighbour Cell list include frequencies of other radio access technologies, the MS shall, at least every 5 s update the value RLA_C for the serving cell and each of the at least 6 strongest non serving GSM cells.

The MS shall then reselect a suitable (see 3GPP TS 25.304 for UTRAN and 3GPP TS 36.304 for E-UTRAN) cell of another radio access technology if the criteria below are satisfied. $S_{\text{non-serving_XXX}}$ is the measurement quantity of a non-serving inter-RAT cell and XXX indicates the other radio access technology/mode and is defined as follows:

- for a E-UTRAN cell, is the measured RSRP value for the cell minus E-UTRAN_QRXLEVMIN for the cell's frequency if THRESH_E-UTRAN_high_Q is not provided; otherwise, if THRESH_E-UTRAN_high_Q is provided, is the measured RSRQ value for the cell minus E-UTRAN_QQUALMIN for the cell's frequency.

[TS 45.008, clause 10.1.4]

The network may request measurement reports from the MS and control its cell re-selection. This is indicated by the parameter NETWORK_CONTROL_ORDER. The meaning of the different parameter values is specified as follows:

NC0	Normal MS control The MS shall perform autonomous cell re-selection.
NC1	MS control with measurement reports The MS shall send measurement reports to the network as defined in subclause 10.1.4.1. The MS shall perform autonomous cell re-selection.
NC2	Network control The MS shall send measurement reports to the network as defined in subclause 10.1.4.1. The MS shall only perform autonomous cell re-selection when the reselection is triggered by a downlink signalling failure as defined in subclause 6.5 or a random access failure as defined in 3GPP TS 44.018 and 3GPP TS 44.060 or if the cell is barred or the C1 criterion falls below zero. The MS shall only determine whether the cell is barred once camped on the cell.
RESET	The MS shall return to the broadcast parameters. Only sent on PCCCH or PACCH.

All signalling for support of network controlled cell re-selection and measurement reports are defined in 3GPP TS 44.060 section 5.5.1.1a.2 and 5.5.2.3.

6.2.3.26.3 Test description

6.2.3.26.3.1 Pre-test conditions

System Simulator:

- Cell 24 is serving GERAN Cell
- Cell 1 is suitable E-UTRAN Cell

UE:

None.

Preamble:

- The UE is GPRS attached and the PDP context 2 activated according to section 41.2.8.1.1 and 40.4.3.15 of TS 51.010-1

6.2.3.26.3.2 Test procedure sequence

Tables 6.2.3.26.3.2-1 & 6.2.3.26.3.2-2 illustrates the downlink power levels and other changing parameters to be applied for the cells at various time instants of the test execution. Row marked "T0" denotes the initial conditions after the preamble, while rows marked "T1" are to be applied subsequently. The exact instants on which these values shall be applied are described in the texts in this clause.

Table 6.2.3.26.3.2-1: Time instances of cell power level and parameter changes for E-UTRA cell

	Parameter	Unit	Cell 1	Remark
T0	Cell-specific RS EPRE	dBm/15kHz	OFF	
	Qrxlevmin	dBm	-106	
	Srxlev*	dB	N/A	
T1	Cell-specific RS EPRE	dBm/15kHz	-70	
	Srxlev*	dB	30	Srxlev _{Cell 1} > THRESH_E-UTRAN_high

Note: Srxlev is calculated in the UE

Table 6.2.3.26.3.2-2: Time instances of cell power level and parameter changes for GERAN cells

	Parameter	Unit	Cell 24	Remark
T0	RF Signal Level	dBm	-80	Camping on Cell 24 is guaranteed
	RXLEV_ACCESS_MIN	dBm	-101	
	C1*	dB	21	
T1	RF Signal Level	dBm		Same as before
	RXLEV_ACCESS_MIN	dBm		Same as before
	C1*	dB		Same as before

Note: C1 is calculated in the UE

Table 6.2.3.26.3.2-2: Main behaviour

St	Procedure	Message Sequence		TP	Verdict
		U - S	Message		
1	Downlink TBF is established according to TS 51.010 clause 40.4.3.14	-	-	-	-
-	EXCEPTION: Steps 2 and 3 are repeated until measurement results for cell 1 are included in PACKET MEASUREMENT REPORT	-	-	-	-
2	SS sends downlink data	<--			
3	UE sends PACKET MEASUREMENT REPORT	-->	PACKET MEASUREMENT REPORT		
4	SS adjusts cell levels for Cell 1 according to row T1 of table 6.2.3.26.3.2-1	-	-	-	-
-	EXCEPTION: Steps 5 and 6 are repeated until the parallel behaviour in table 6.2.3.26.3.2-3 takes place	-	-	-	-
5	SS sends downlink data				
6	UE sends PACKET MEASUREMENT REPORT	-->	PACKET MEASUREMENT REPORT		

Table 6.2.3.26.3.2-3: Parallel behaviour

St	Procedure	Message Sequence		TP	Verdict
		U - S	Message		
1	Check: Does the test result of generic test procedure in TS 36.508 Table 6.4.2.7A-1 indicate that the UE is camped on E-UTRAN Cell 1?	-	-	1	-

6.2.3.26.3.3 Specific message contents

Table 6.2.3.26.3.3-1 Repeated E-UTRAN Neighbour Cells struct of SI2Quater for Cell 24[Preamble]

Derivation Path: 36.508 table 4.4.5-1			
Information Element	Value/remark	Comment	Condition
Serving Cell Priority Parameters ::=			
{			
GERAN_PRIORITY	'001'B	This field specifies GERAN cell priority	
}			
Repeated E-UTRAN Neighbour Cells ::=			
{			
EARFCN	Same as cell 1	This field specifies the E-UTRA Absolute Radio Frequency Channel Number as defined in 3GPP TS 36.104.	
Measurement Bandwidth	Same as cell 1		
E-UTRAN_PRIORITY	'100'B	Same as cell 1	
THRESH_E-UTRAN_high	'00010'B	Actual value =4 dB	
THRESH_E-UTRAN_low	'00010'B	Actual value =4 dB	
E-UTRAN_QRXLEVMIN	17 (-106 dBm)		
}			

Table 6.2.3.27.3.3-2: Message ATTACH REQUEST (Preamble)

Derivation Path: Table 9.4.1/3GPP TS 24.008			
Information Element	Value/remark	Comment	Condition
MS Radio Access capability			
GERAN to E-UTRA support in GERAN packet transfer mode	'10'B or '11'B	UTRAN Neighbour Cell measurements and MS autonomous cell reselection to E-UTRAN and CCN towards E-UTRAN, E-UTRAN Neighbour Cell measurement reporting and Network controlled cell reselection to E-UTRAN	
Mobile station classmark 3			
E-UTRA FDD support	'0'B or '1'B		C1
E-UTRA TDD support	'0'B or '1'B		C1

C1	At least one of these fields shall be set to '1'B
----	---

6.2.3.27 Inter-RAT Cell selection from GPRS Packet_transfer to E-UTRA (NC2 Mode)

6.2.3.27.1 Test Purpose (TP)

(1) with { UE in GPRS Registered state with active packet data transfer in NC2 mode }

```

ensure that {
  when { UE detects network re-selection criteria are met on the E-UTRA cell}
  then { UE performs cell change to E-UTRA cell and the data transfer is continued and completed
in E-UTRA cell }
}

```

6.2.3.27.2 Conformance requirements

References: The conformance requirements covered in the present TC are specified in: TS 45.008, clause 6.4, 10.1.4, 10.1.4.1 and 10.1.4.2, TS 44.018, clause 3.4.1.2.1.1a:

[TS 45.008, clause 6.4]

The path loss criterion parameter C1 used for cell selection and reselection is defined by:

$$C1 = (A - \text{Max}(B,0))$$

where

$$\begin{aligned}
 A &= RLA_C - RXLEV_ACCESS_MIN \\
 B &= MS_TXPWR_MAX_CCH - P
 \end{aligned}$$

except for the class 3 DCS 1 800 MS where:

$$\begin{aligned}
 B &= MS_TXPWR_MAX_CCH + \text{POWER OFFSET} - P \\
 RXLEV_ACCESS_MIN &= \text{Minimum received signal level at the MS required for access to the system.} \\
 MS_TXPWR_MAX_CCH &= \text{Maximum TX power level an MS may use when accessing the system until otherwise commanded.} \\
 \text{POWER OFFSET} &= \text{The power offset to be used in conjunction with the MS TXPWR MAX CCH parameter by the class 3 DCS 1 800 MS.} \\
 P &= \text{Maximum RF output power of the MS.}
 \end{aligned}$$

All values are expressed in dBm.

[TS 45.008, clause 10.1.4]

The network may request measurement reports from the MS and control its cell re-selection. This is indicated by the parameter NETWORK_CONTROL_ORDER. The meaning of the different parameter values is specified as follows:

NC0	Normal MS control The MS shall perform autonomous cell re-selection.
NC1	MS control with measurement reports The MS shall send measurement reports to the network as defined in subclause 10.1.4.1. The MS shall perform autonomous cell re-selection.
NC2	Network control The MS shall send measurement reports to the network as defined in subclause 10.1.4.1. The MS shall only perform autonomous cell re-selection when the reselection is triggered by a downlink signalling failure as defined in subclause 6.5 or a random access failure as defined in 3GPP TS 44.018 and 3GPP TS 44.060 or if the cell is barred or the C1 criterion falls below zero. The MS shall only determine whether the cell is barred once camped on the cell.
RESET	The MS shall return to the broadcast parameters. Only sent on PCCCH or PACCH.

A list given by Packet Cell Change Order applies in the new cell. This list may also include cells with other radio access technologies.

All signalling for support of network controlled cell re-selection and measurement reports are defined in 3GPP TS 44.060.

If the MS operates in NC2 mode, the following rules shall be applied:

- The network controls the measurements of UTRAN cells by the parameter Qsearch_P. The network controls the measurements of E-UTRAN cells by the parameter Qsearch_P_E-UTRAN.

- The network may control UTRAN measurements per individual UTRAN frequency by the parameters Measurement_Control_UTRAN and E-UTRAN measurements per individual E-UTRAN frequency by the parameters Measurement_Control_E-UTRAN.

[TS 45.008, clause 10.1.4.1]

When ordered to send measurement reports, the MS shall continuously monitor all carriers in BA(GPRS) or as indicated by the parameter NC_FREQUENCY_LIST and the BCCH carrier of the serving cell. The measurement requirements are defined in subclause 10.1.1 for the actual packet mode

[TS 44.018, clause 3.4.1.2.1.1a]

This applies only to a multi-RAT MS supporting E-UTRAN. One or more instances of the Measurement Information message or SI2quater message may provide E-UTRAN Neighbour Cell Description information in one or more instances of the Repeated E-UTRAN Neighbour Cells IE. This is used to build the E-UTRAN Neighbour Cell list. The fast acquisition of system information procedure, as defined in subclause 3.4.1.2.1.11, shall be used to acquire E-UTRAN measurement parameters and neighbour cell information from SI2quater and MEASUREMENT INFORMATION.

6.2.3.27.3 Test description

6.2.3.27.3.1 Pre-test conditions

System Simulator:

- 2 Cells, one GSM and one E-UTRA:
- Cell 24 GSM serving cell
- Cell 1 non-suitable “Off” cell

UE:

- None

Preamble:

- The UE is GPRS attached to the home PLMN and the PDP context 2 activated according to TS 51.010-1 clause 40.4.3.15.

6.2.3.27.3.2 Test procedure sequence

Table 6.2.3.27.3.2-1 illustrates the downlink power levels and other changing parameters to be applied for the cells at various time instants of the test execution. The exact instants on which these values shall be applied are described in the texts in this clause.

Table 6.2.3.27.3.2-1: Time instances of cell power level and parameter changes (E-UTRA and GERAN cell)

	Parameter	Unit	Cell 1	Cell 24	Remark
T1	Cell-specific RS EPRE	dBm/15kHz	-70	-	$S_{rxlevCell1} > 0$
	Qrxlevmin	dBm	-106	-	-
	Qrxlevminoffset	dB	0	-	-
	Pcompensation	dB	0	-	-
	C1*	dB	-	<0	Cell 24 become weakest cell
Note: S_{rxlev} is calculated in the UE C1 is calculated in the UE					

Table 6.2.3.27.3.2-2: Main behaviour

St	Procedure	Message Sequence		TP	Verdict
		U - S	Message		
1	Uplink dynamic allocation two phase access according to TS 51.010 clause 40.4.3.9 using n=1500 octets of data.	-->	-	-	-
2	The UE transmits PACKET MEASUREMENT REPORT	-->	PACKET MEASUREMENT REPORT	-	-
3	SS adjusts cell levels according to row T1 of table 6.2.3.27.3.2-1.	-	-	-	-
-	EXCEPTION: Step 2 is repeated until measurement results for cell 1 are included in the PACKET MEASUREMENT REPORT message in step 4. SS continues to transfer data in parallel of step 4.	-	-	-	-
4	The UE transmits PACKET MEASUREMENT REPORT for cell 1 are included in the PACKET MEASUREMENT REPORT message	-->	PACKET MEASUREMENT REPORT	-	-
5	Check: Does UE send RRC CONNECTION REQUEST on cell 1?	-->	<i>RRCCconnectionRequest</i>	1	P
6	SS sends <i>RRCCconnectionSetup</i> to the UE	<--	<i>RRCCconnectionSetup</i>	-	-
7	Check: Does the UE send <i>RRCCconnectionSetupComplete</i> message on cell 1?	-->	<i>RRCCconnectionSetupComplete</i> NAS: TRACKING AREA UPDATE REQUEST	1	P
8-11	Steps 4 to 7 from generic procedure 36.508 Table 6.4.2.7A-1 are executed	-	-	-	-
	{How to handle data from GERAN to E-UTRAN is under FFS}	-	-	-	-

6.2.3.27.3.3 Specific message contents

Table 6.2.3.27.3.3-1: SI2Quater for Cell 24 (Preamble)

Derivation Path: 44.018 Table 10.5.2.33b.1			
Information Element	Value/remark	Comment	Condition
Serving Cell Priority Parameters Description ::= SEQUENCE {			
GERAN_PRIORITY	7		
THRESH_Priority_Search	0		
THRESH_GSM_low	0(-98 dBm)		
H_PRIO	0	Hysteresis used in the priority reselection algorithm	
T_Reselection	3(=20 seconds)	Time hysteresis in the reselection algorithm	
}			
Repeated E-UTRAN Neighbour Cells ::= SEQUENCE {			
EARFCN	Same as cell 1	This field specifies the E-UTRA Absolute Radio Frequency Channel Number as defined in 3GPP TS 36.104.	
Measurement Bandwidth	Same as cell 1		
E-UTRAN_PRIORITY	'100'B	Same as cell 1	
E-UTRAN_QRXLEVMIN	17 (-106 dBm)		
}			

Table 6.2.3.27.3.3-2: Message ATTACH REQUEST (Preamble)

Derivation Path: Table 9.4.1/3GPP TS 24.008			
Information Element	Value/remark	Comment	Condition
MS Radio Access capability			
GERAN to E-UTRA support in GERAN packet transfer mode	'10'B or '11'B	UTRAN Neighbour Cell measurements and MS autonomous cell reselection to E-UTRAN and CCN towards E-UTRAN, E-UTRAN Neighbour Cell measurement reporting and Network controlled cell reselection to E-UTRAN	
Mobile station classmark 3			
E-UTRA FDD support	'0'B or '1'B		C1
E-UTRA TDD support	'0'B or '1'B		C1

C1	At least one of these fields shall be set to '1'B
----	---

Table 6.2.3.27.3.3-3: RRCConnectionRequest (step 5, Table 6.2.3.27.3.2-2)

Derivation Path: 36.508 table 4.6.1-16			
Information Element	Value/remark	Comment	Condition
ue-Identity	Any allowed value		

6.2.3.28 Inter-RAT Cell Reselection from GPRS Packet_transfer to E-UTRA (Network Assisted Cell Change)

6.2.3.28.1 Test Purpose (TP)

```
(1) with { UE in GPRS Registered state with active packet data transfer in NC2 mode }
ensure that {
  when { UE detects network assisted cell change and the target E-UTRA cell}
  then { UE reselects for the target E-UTRA cell}
}
```

6.2.3.28.2 Conformance requirements

References: The conformance requirements covered in the present TC are specified in: TS 45.008, clause 10.1.4, 10.1.4.1 and 10.1.4.2, TS 44.018, clause 3.4.1.2.1.1a:

[TS 45.008, clause 10.1.4]

The network may request measurement reports from the MS and control its cell re-selection. This is indicated by the parameter NETWORK_CONTROL_ORDER. The meaning of the different parameter values is specified as follows:

- NC0 Normal MS control
The MS shall perform autonomous cell re-selection.
- NC1 MS control with measurement reports
The MS shall send measurement reports to the network as defined in subclause 10.1.4.1.
The MS shall perform autonomous cell re-selection.
- NC2 Network control
The MS shall send measurement reports to the network as defined in subclause 10.1.4.1.
The MS shall only perform autonomous cell re-selection when the reselection is triggered by a downlink signalling failure as defined in subclause 6.5 or a random access failure as defined in 3GPP TS 44.018 and 3GPP TS 44.060 or if the cell is barred or the C1 criterion falls below zero.
The MS shall only determine whether the cell is barred once camped on the cell.

RESET The MS shall return to the broadcast parameters. Only sent on PCCCH or PACCH.

A list given by Packet Cell Change Order applies in the new cell. This list may also include cells with other radio access technologies.

All signalling for support of network controlled cell re-selection and measurement reports are defined in 3GPP TS 44.060.

If the MS operates in NC2 mode, the following rules shall be applied:

- The network controls the measurements of UTRAN cells by the parameter `Qsearch_P`. The network controls the measurements of E-UTRAN cells by the parameter `Qsearch_P_E-UTRAN`.
- The network may control UTRAN measurements per individual UTRAN frequency by the parameters `Measurement_Control_UTRAN` and E-UTRAN measurements per individual E-UTRAN frequency by the parameters `Measurement_Control_E-UTRAN`.

[TS 45.008, clause 10.1.4.1]

When ordered to send measurement reports, the MS shall continuously monitor all carriers in BA(GPRS) or as indicated by the parameter `NC_FREQUENCY_LIST` and the BCCH carrier of the serving cell. The measurement requirements are defined in subclause 10.1.1 for the actual packet mode

[TS 45.008, clause 10.1.4.2]

A cell re-selection command may be sent from the network to an MS. When the MS receives the command, it shall re-select the cell according to the included cell description and change the network control mode according to the command (see 3GPP TS 44.060). The command may include re-selection of another radio access technology/mode.

[TS 44.018, clause 3.4.1.2.1.1a]

This applies only to a multi-RAT MS supporting E-UTRAN. One or more instances of the Measurement Information message or SI2quater message may provide E-UTRAN Neighbour Cell Description information in one or more instances of the Repeated E-UTRAN Neighbour Cells IE. This is used to build the E-UTRAN Neighbour Cell list. The fast acquisition of system information procedure, as defined in subclause 3.4.1.2.1.11, shall be used to acquire E-UTRAN measurement parameters and neighbour cell information from SI2quater and MEASUREMENT INFORMATION.

6.2.3.28.3 Test description

6.2.3.28.3.1 Pre-test conditions

System Simulator:

- Cell 1 and Cell 24.

UE:

- The HPLMN is PLMN1.

Preamble:

- The UE is GPRS attached to the home PLMN and the PDP context 2 activated according to [23].

Tables 6.2.3.28.3.2-1 & 6.2.3.28.3.2-2 illustrates the downlink power levels and other changing parameters to be applied for the cells at various time instants of the test execution. Row marked "T0" denotes the initial conditions after the preamble, while rows marked "T1" are to be applied subsequently. The exact instants on which these values shall be applied are described in the texts in this clause.

Table 6.2.3.28.3.2-1: Time instances of cell power level and parameter changes for the E-UTRA cell

	Parameter	Unit	Cell 1	Remark
T0	Cell-specific RS EPRE	dBm/15kHz	OFF	
	Qrxlevmin	dBm	-106	
	Qrxlevminoffset	dB	0	
	Pcompensation	dB	0	
T1	Cell-specific RS EPRE	dBm/15kHz	-70	$S_{rxlevCell1} > 0$
	Qrxlevmin	dBm	-106	
	Qrxlevminoffset	dB	0	
	Pcompensation	dB	0	

Note: S_{rxlev} is calculated in the UE

Table 6.2.3.28.3.2-2: Time instances of cell power level and parameter changes for the GERAN cell

	Parameter	Unit	Cell 24	Remark
T0	RF Signal Level	dBm	-80	Camping on Cell 24 is guaranteed
	RXLEV_ACCESS_MIN	dBm	-101	
	C1*	dB	21	
T1	RF Signal Level	dBm	-80	
	RXLEV_ACCESS_MIN	dBm	-101	
	C1*	dB	21	

Note: C1 is calculated in the UE

Table 6.2.3.28.3.2-3: Main behaviour

St	Procedure	Message Sequence		TP	Verdict
		U - S	Message		
1	UE is brought into downlink packet transfer mode . SS sends PACKET DOWNLINK ASSIGNMENT	<--	PACKET DOWNLINK ASSIGNMENT	-	-
2	SS sends PACKET MEASUREMENT ORDER	<--	PACKET MEASUREMENT ORDER	-	-
3	SS sends downlink data	<--	-	-	-
4	The UE transmits PACKET MEASUREMENT REPORT	-->	PACKET MEASUREMENT REPORT		
5	SS adjusts cell levels according to row T1 of tables 6.2.3.28.3.2-1 and 6.2.3.28.3.2-2.	-	-	-	-
6	EXCEPTION: Step 3 to 4 are repeated until measurement results for cell 1 are included in the PACKET MEASUREMENT REPORT message	-	-	-	-
7	SS sends PACKET CELL CHANGE ORDER for cell 1 as the target cell	<--	PACKET CELL CHANGE ORDER	-	-
8	Check: Does UE send RRC CONNECTION REQUEST on cell 1?	-->	<i>RRCCconnectionRequest</i>	1	P
9	SS sends <i>RRCCconnectionSetup</i> to the UE	<--	<i>RRCCconnectionSetup</i>	-	-
10	Check: Does the UE send <i>RRCCconnectionSetupComplete</i> message on cell 1?	-->	<i>RRCCconnectionSetupComplete</i>	1	P

Note: GERAN cell priority is not allocated, hence it will be considered as the less than all allowed values of 1 to 8.

6.2.3.28.3.3 Specific message contents

Table 6.2.3.28.3.3-1: SI2Quater for Cell 24 (Preamble)

Derivation Path: 44.018 Table 10.5.2.33b.1			
Information Element	Value/remark	Comment	Condition
Repeated E-UTRAN Neighbour Cells ::= SEQUENCE {			
EARFCN	Same as cell 1	This field specifies the E-UTRA Absolute Radio Frequency Channel Number as defined in 3GPP TS 36.104.	
Measurement Bandwidth	Same as cell 1		
E-UTRAN_PRIORITY	'100'B	Same as cell 1	
E-UTRAN_QRXLEVMIN	17 (-106 dBm)		
}			

Table 6.2.3.28.3.3-2: Message ATTACH REQUEST (Preamble)

Derivation Path: Table 9.4.1/3GPP TS 24.008			
Information Element	Value/remark	Comment	Condition
MS Radio Access capability			
GERAN to E-UTRA support in GERAN packet transfer mode	'10'B or '11'B	UTRAN Neighbour Cell measurements and MS autonomous cell reselection to E-UTRAN and CCN towards E-UTRAN, E-UTRAN Neighbour Cell measurement reporting and Network controlled cell reselection to E-UTRAN	
Mobile station classmark 3			
E-UTRA FDD support	'0'B or '1'B		C1
..E-UTRA TDD support	'0'B or '1'B		C1

C1	At least one of these fields shall be set to '1'B
----	---

Table 6.2.3.28.3.3-3: Message PACKET MEASUREMENT ORDER (step 2, Table 6.2.3.28.3.2-3)

Derivation Path: 51.010-1 clause 42.4.3.2.3			
Information Element	Value/remark	Comment	Condition
Global TFI	TFI of the uplink TBF		
NC Measurement parameters ::= {			
NETWORK_CONTROL_ORDER	'10'B	NC2	
NC_REPORTING_PERIOD_I	'111'B	61.44 sec	
NC_REPORTING_PERIOD_T	'010'B	1.92 sec	
}			
NC_FREQUENCY_LIST	0	Not present	

Table 6.2.3.28.3.3-4: Message PACKET CELL CHANGE ORDER (step 7, Table 6.2.3.28.3.2-3)

Derivation Path: 51.010-1 clause 42.4.3.2.1			
Information Element	Value/remark	Comment	Condition
Global TFI	TFI of the uplink TBF		
IMMEDIATE_REL	1		
E-UTRAN Target cell IE			
EARFCN	specified for cell 1		
Physical Layer Cell Identity	specified for cell 1		

Table 6.2.3.28.3.3-5: RRCConnectionRequest (step 8, Table 6.2.3.28.3.2-3)

Derivation Path: 36.508 table 4.6.1-16			
Information Element	Value/remark	Comment	Condition
ue-Identity	Any allowed value		

6.2.3.29 Inter-RAT cell Reselection from GPRS packet_transfer to E-UTRA in CCN mode (PACKET MEASUREMENT ORDER)

6.2.3.29.1 Test Purpose (TP)

(1)

```
with { UE in GPRS packet_transfer state with active data transfer in NC1 mode }
  ensure that {
    when { UE with CCN enable detects E-UTRA cell, enters CCN mode, receives PACKET MEASUREMENT
ORDER to enter NC2 and subsequently receives PACKET CELL CHANGE ORDER }
      then { UE does not perform autonomous reselection, but performs cell change to E-UTRA cell
only on receipt of PACKET CELL CHANGE ORDER }
  }
```

6.2.3.29.2 Conformance requirements

References: The conformance requirements covered in the present TC are specified in: TS 45.008, clause 6.6.6, 10.1.4, 10.1.4.1, 10.1.4.2, TS 44.060 clause 5.5.1.1a.2, and TS 36.331 clause 5.4.6.2:

[TS 45.008, clause 6.6.6]

The algorithm in this subclause shall be used for inter-RAT cell reselection if priorities are available to the MS and thresholds are provided by the network, and if the mobile station supports priority based inter-RAT cell re-selection and priority information for the serving cell is provided by the network. A mobile station supporting E-UTRAN shall support priority based inter-RAT cell re-selection towards all the supported RATs. A mobile station not supporting E-UTRAN and supporting UTRAN and supporting priority based reselection from UTRAN to GERAN shall support priority based inter-RAT cell re-selection towards UTRAN.

The network shall provide priority information if E-UTRAN frequencies are included in the neighbour cell list; the network may provide priority information if only UTRAN frequencies are included in the neighbour cell list. If priority information is available to the mobile station and the mobile station supports priority based inter-RAT cell re-selection, the algorithm in this subclause shall be used for inter-RAT reselection towards all RATs. The rules regarding which set of priorities is valid at any given time are defined in 3GPP TS 44.018.

NOTE 1: “Priority information” includes priorities and thresholds which are related to each UTRAN or E-UTRAN frequency (e.g. UTRAN_PRIORITY, E-UTRAN_PRIORITY, THRESH_UTRAN_high, THRESH_E-UTRAN_high) and information related to the serving cell (e.g. GERAN_PRIORITY, THRESH_GSM_low).

NOTE 2: Throughout the specification, the phrase “neighbour cell list” will include also the E-UTRAN Neighbour Cell list where appropriate.

NOTE 3: Priorities need to be provided also for frequencies of networks that do not support priority-based cell reselection.

If the 3G Cell Reselection list or the E-UTRAN Neighbour Cell list include frequencies of other radio access technologies, the MS shall, at least every 5 s update the value RLA_C for the serving cell and each of the at least 6 strongest non serving GSM cells.

The MS shall then reselect a suitable (see 3GPP TS 25.304 for UTRAN and 3GPP TS 36.304 for E-UTRAN) cell of another radio access technology if the criteria below are satisfied. $S_{\text{non-serving_XXX}}$ is the measurement quantity of a non-serving inter-RAT cell and XXX indicates the other radio access technology/mode and is defined as follows:

- for a UTRAN cell, is the measured RSCP value for the cell minus UTRAN_QRXLEVMIN for the cell's frequency;
- for a E-UTRAN cell, is the measured RSRP value for the cell minus E-UTRAN_QRXLEVMIN for the cell's frequency if THRESH_E-UTRAN_high_Q is not provided; otherwise, if THRESH_E-UTRAN_high_Q is provided, is the measured RSRQ value for the cell minus E-UTRAN_QQUALMIN for the cell's frequency.

[TS 45.008, clause 10.1.4]

The network may request measurement reports from the MS and control its cell re-selection. This is indicated by the parameter NETWORK_CONTROL_ORDER. The meaning of the different parameter values is specified as follows:

NC0	Normal MS control The MS shall perform autonomous cell re-selection.
NC1	MS control with measurement reports The MS shall send measurement reports to the network as defined in subclause 10.1.4.1. The MS shall perform autonomous cell re-selection.
NC2	Network control The MS shall send measurement reports to the network as defined in subclause 10.1.4.1. The MS shall only perform autonomous cell re-selection when the reselection is triggered by a downlink signalling failure as defined in subclause 6.5 or a random access failure as defined in 3GPP TS 44.018 and 3GPP TS 44.060 or if the cell is barred or the C1 criterion falls below zero. The MS shall only determine whether the cell is barred once camped on the cell.
RESET	The MS shall return to the broadcast parameters. Only sent on PCCCH or PACCH.

A list given by Packet Cell Change Order applies in the new cell. This list may also include cells with other radio access technologies.

All signalling for support of network controlled cell re-selection and measurement reports are defined in 3GPP TS 44.060.

[TS 45.008, clause 10.1.4.1]

When ordered to send measurement reports, the MS shall continuously monitor all carriers in BA(GPRS) or as indicated by the parameter NC_FREQUENCY_LIST and the BCCH carrier of the serving cell. The measurement requirements are defined in subclause 10.1.1 for the actual packet mode

[TS 45.008, clause 10.1.4.2]

A cell re-selection command may be sent from the network to an MS. When the MS receives the command, it shall re-select the cell according to the included cell description and change the network control mode according to the command (see 3GPP TS 44.060). The command may include re-selection of another radio access technology/mode.

[TS 44.060, clause 5.5.1.1a.2]

A mobile station, which has *CCN Enabled*, can enter *CCN Mode*.

The mobile station shall enable CCN when the following criteria are fulfilled:

- the mobile station is camping on a cell (see 3GPP TS 45.008); and
- the network indicates CCN ACTIVE/3G CCN ACTIVE/E-UTRAN CCN ACTIVE either in system information to all mobile stations in the cell or in an individual order to a certain mobile station; and
- the mobile station is neither in dedicated mode nor Dual Transfer Mode; and

- the mobile station is in NC0 or in NC1 mode; and
- the mobile station is in Packet Transfer mode.

The CCN procedures and the criteria for entering and leaving CCN mode are specified in sub-clauses 8.8.2 and 8.8.3.

[TS 36.331, clause 5.4.6.2]

The procedure is initiated when a radio access technology other than E-UTRAN, e.g. GSM/GPRS, using procedures specific for that RAT, orders the UE to change to an E-UTRAN cell. In response, upper layers request the establishment of an RRC connection as specified in subclause 5.3.3.

NOTE: Within the message used to order the UE to change to an E-UTRAN cell, the source RAT should specify the identity of the target E-UTRAN cell as specified in the specifications for that RAT.

The UE shall:

- 1> upon receiving an *RRCConnectionSetup* message:
- 2> consider the inter-RAT cell change order procedure to have completed successfully;

6.2.3.29.3 Test description

6.2.3.29.3.1 Pre-test conditions

System Simulator:

- GERAN Cell 24 serving cell
- E-UTRAN Cell 1 off

UE:

None

Preamble:

- The UE is GPRS attached and the PDP context 2 activated according to section 40.4.3.15 of TS51010-1

6.2.3.29.3.2 Test procedure sequence

Table 6.2.3.29.3.2-1 illustrates the downlink power levels and other changing parameters to be applied for the cells at various time instants of the test execution. The exact instants on which these values shall be applied are described in the texts in this clause.

Table 6.2.3.29.3.2-1: Time instances of cell power level and parameter changes (GERAN and E-UTRA cells)

	Parameter	Unit	Cell 1	Cell24	Remark
T1	Cell-specific RS EPRE	dBm/15kHz	-60	No change	The power level is such that $SrxlevCell\ 1 > 0$
Note: $Srxlev$ is calculated in the UE					

Table 6.2.3.29.3.2-2: Main behaviour

St	Procedure	Message Sequence		TP	Verdict
		U - S	Message		
1	Uplink dynamic allocation two phase access according to TS 51.010 clause 40.4.3.9 using n=5000 octets of data	-	-	-	-
-	UE continues to transfer data. See Note.	-	-	-	-
2	SS adjusts cell levels for Cell 1 according to row T1 of table 6.2.3.29.3.2-1	-	-	-	-
3	The UE transmits PACKET CELL CHANGE NOTIFICATION to E_UTRA cell on cell 24	-->	PACKET CELL CHANGE NOTIFICATION		
4	SS sends PACKET MEASUREMENT ORDER activating NC2	<--	PACKET MEASUREMENT ORDER		
5	The UE moves out of CCN mode and does not perform cell reselection Check: Does UE send <i>RRCCConnectionRequest</i> on cell 1?	-->	<i>RRCCConnectionRequest</i>	1	F
6	The UE sends PACKET MEASUREMENT REPORT including the Cell 1 information in the message.	-->	PACKET MEASUREMENT REPORT	-	-
7	SS sends PACKET CELL CHANGE ORDER for cell 1 as the target cell	<--	PACKET CELL CHANGE ORDER		
8	Check: Does UE send <i>RRCCConnectionRequest</i> on cell 1?	-->	<i>RRCCConnectionRequest</i>	1	P
9 - 14	Steps 2 to 7 from generic procedure 36.508 Table 6.4.2.7A-1 are executed	-	-	-	-
Note: Uplink data transfer can be completed in any step after step 4 and before step 7 in Cell 24, or any step after step 7 in Cell 1					

6.2.3.29.3.3 Specific message contents

Table 6.2.3.29.3.3-1: Repeated E-UTRAN Neighbour Cells struct of SI2Quater for Cell 24 (Preamble)

Derivation Path: 36.508 table 4.4.5-1			
Information Element	Value/remark	Comment	Condition
Serving Cell Priority Parameters ::=			
GERAN_PRIORITY	'001'B	This field specifies GERAN cell priority	
E-UTRAN Parameters Description ::=			
E-UTRAN_CCN_ACTIVE	1	CCN is enabled in the cell	
Repeated E-UTRAN Neighbour Cells ::=			
{			
Measurement Bandwidth	Same as cell 1		
}			

Table 6.2.3.29.3.3-2 Message ATTACH REQUEST (Preamble)

Derivation Path: Table 9.4.1/3GPP TS 24.008			
Information Element	Value/remark	Comment	Condition
MS Radio Access capability			
GERAN to E-UTRA support in GERAN packet transfer mode	'10'B or '11'B	UTRAN Neighbour Cell measurements and MS autonomous cell reselection to E-UTRAN and CCN towards E-UTRAN, E-UTRAN Neighbour Cell measurement reporting and Network controlled cell reselection to E-UTRAN	
E-UTRA FDD support	'0'B or '1'B		C1
E-UTRA TDD support	'0'B or '1'B		C1

C1	At least one of these fields shall be set to '1'B
----	---

Table 6.2.3.29.3.3-3: Message PACKET MEASUREMENT ORDER (step 4, Table 6.2.3.29.3.2-2)

Derivation Path: 51.010-1 clause 42.4.3.2.3			
Information Element	Value/remark	Comment	Condition
Global TFI	TFI of the uplink TBF		
NC Measurement parameters ::= {			
NETWORK_CONTROL_ORDER	'10'B	NC2	
NC_REPORTING_PERIOD_I	'111'B	61.44 sec	
NC_REPORTING_PERIOD_T	'010'B	1.92 sec	
}			
NC_FREQUENCY_LIST	0	Not present	

Table 6.2.3.29.3.3-4: Message PACKET CELL CHANGE ORDER (step 7, Table 6.2.3.29.3.2-2)

Derivation Path: 51.010-1 clause 42.4.3.2.1			
Information Element	Value/remark	Comment	Condition
Global TFI	TFI of the uplink TBF		
IMMEDIATE_REL	1		
E-UTRAN Target cell IE			
EARFCN	specified for cell 1		
Physical Layer Cell Identity	specified for cell 1		

6.2.3.30 Inter-RAT Cell Reselection failure from GPRS Packet transfer to E-UTRA (Network Assisted Cell Change)

6.2.3.30.1 Test Purpose (TP)

(1)

```
with { UE in GPRS Registered state with active packet data transfer in NC2 mode }
ensure that {
  when { UE detects network assisted cell change and cell re-selection failure for the target E-UTRA cell }
  then { UE reselects back the GERAN cell and downlink data transfer is continued and completed in GERAN cell }
}
```

6.2.3.30.2 Conformance requirements

References: The conformance requirements covered in the present TC are specified in: TS 45.008, clause 10.1.4, and 10.1.4.2:

[TS 45.008, clause 10.1.4]

The network may request measurement reports from the MS and control its cell re-selection. This is indicated by the parameter NETWORK_CONTROL_ORDER. The meaning of the different parameter values is specified as follows:

NC0	Normal MS control The MS shall perform autonomous cell re-selection.
NC1	MS control with measurement reports The MS shall send measurement reports to the network as defined in subclause 10.1.4.1. The MS shall perform autonomous cell re-selection.
NC2	Network control The MS shall send measurement reports to the network as defined in subclause 10.1.4.1. The MS shall only perform autonomous cell re-selection when the reselection is triggered by a downlink signalling failure as defined in subclause 6.5 or a random access failure as defined in 3GPP TS 44.018 and 3GPP TS 44.060 or if the cell is barred or the C1 criterion falls below zero. The MS shall only determine whether the cell is barred once camped on the cell.
RESET	The MS shall return to the broadcast parameters. Only sent on PCCCH or PACCH.

A list given by Packet Cell Change Order applies in the new cell. This list may also include cells with other radio access technologies.

All signalling for support of network controlled cell re-selection and measurement reports are defined in 3GPP TS 44.060.

If the MS operates in NC2 mode, the following rules shall be applied:

- The network controls the measurements of UTRAN cells by the parameter Qsearch_P. The network controls the measurements of E-UTRAN cells by the parameter Qsearch_P_E-UTRAN.
- The network may control UTRAN measurements per individual UTRAN frequency by the parameters Measurement_Control_UTRAN and E-UTRAN measurements per individual E-UTRAN frequency by the parameters Measurement_Control_E-UTRAN.

[TS 45.008, clause 10.1.4.2]

A cell re-selection command may be sent from the network to an MS. When the MS receives the command, it shall re-select the cell according to the included cell description and change the network control mode according to the command (see 3GPP TS 44.060). The command may include re-selection of another radio access technology/mode.

If a UTRAN capable MS receives a cell re-selection command towards a not known UTRAN cell (see 3GPP TS 25.133 and 3GPP TS 25.123), or if a E-UTRAN capable MS receives a cell re-selection command towards a not known E-UTRAN cell (see 3GPP TS 36.133), then the MS shall search for synchronisation information up to 800 ms. In case of failure, the MS shall return to the old cell and indicate a packet cell change failure (see 3GPP TS 44.060).

6.2.3.30.3 Test description

6.2.3.30.3.1 Pre-test conditions

System Simulator:

- Cell 1 and Cell 24.

UE:

The HPLMN is PLMN1.

Preamble:

- The UE is GPRS attached to the home PLMN and the PDP context 2 activated according to [23].

6.2.3.30.3.2 Test procedure sequence

Tables 6.2.3.30.3.2-1 & 6.2.3.30.3.2-2 illustrates the downlink power levels and other changing parameters to be applied for the cells at various time instants of the test execution. Row marked "T0" denotes the initial conditions after

the preamble, while rows marked "T1" are to be applied subsequently. The exact instants on which these values shall be applied are described in the texts in this clause.

Table 6.2.3.30.3.2-1: Time instances of cell power level and parameter changes for E-UTRA cell

	Parameter	Unit	Cell 1	Remark
T0	Cell-specific RS EPRE	dBm/15kHz	OFF	
	Qrxlevmin	dBm	-106	
	Qrxlevminoffset	dB	0	
	Pcompensation	dB	0	
T1	Cell-specific RS EPRE	dBm/15kHz	-70	The power level is such that $S_{rxlevCell\ 1} > 0$
Note: S_{rxlev} is calculated in the UE				

Table 6.2.3.30.3.2-2: Time instances of cell power level and parameter changes for GERAN cells

	Parameter	Unit	Cell 24	Remark
T0	RF Signal Level	dBm	-80	Camping on Cell 24 is guaranteed
	RXLEV_ACCESS_MIN	dBm	-101	
	C1*	dB	21	
T1	RF Signal Level	dBm	-80	
	RXLEV_ACCESS_MIN	dBm	-101	
	C1*	dB	21	
Note: C1 is calculated in the UE				

Table 6.2.3.30.3.2-3: Main behaviour

St	Procedure	Message Sequence		TP	Verdict
		U - S	Message		
1	Downlink TBF is established according to TS 51.010 clause 40.4.3.14			-	-
2	SS sends PACKET MEASUREMENT ORDER	<--	PACKET MEASUREMENT ORDER	-	-
3	SS sends downlink data	<--	-	-	-
4	The UE transmits PACKET MEASUREMENT REPORT	-->	PACKET MEASUREMENT REPORT		
5	SS adjusts cell levels for Cell 1 according to row T1 of table 6.2.3.30.3.2-1	-	-	-	-
6	EXCEPTION: Step 3 to 4 are repeated until measurement results for cell 1 are included in the PACKET MEASUREMENT REPORT message	-	-	-	-
7	SS sends PACKET CELL CHANGE ORDER for cell 1 as the target cell	<--	PACKET CELL CHANGE ORDER	-	-
8	UE sends <i>RRCCConnectionRequest</i> to cell 1	-->	<i>RRCCConnectionRequest</i>	-	-
9	SS sends <i>RRCCConnectionReject</i> to the UE	<--	<i>RRCCConnectionReject</i>	-	-
10	All the UL/DL messages sent in steps 11-20 shall be sent on cell 24.	-		-	-
11	Check: Does the UE send CHANNEL REQUEST ?	-->	CHANNEL REQUEST	1	P
12	SS sends IMMEDIATE ASSIGNMENT	<--	IMMEDIATE ASSIGNMENT	-	-
13	Check: Does the UE send PACKET CELL CHANGE FAILURE?	-->	PACKET CELL CHANGE FAILURE	1	P
-	EXCEPTION: Steps 14a to 14c describe behaviour that depends on the UE capability; the "lower case letter" identifies a step sequence that takes place. This is checked for a period of 1s	-	-	-	-
14a	the UE transmit a ROUTING AREA UPDATE REQUEST message?	-->	ROUTING AREA UPDATE REQUEST	-	-
14b	The SS transmits a ROUTING AREA UPDATE ACCEPT message.	<--	ROUTING AREA UPDATE ACCEPT	-	-
14c	The UE transmits a ROUTING AREA UPDATE COMPLETE message.	-->	ROUTING AREA UPDATE COMPLETE	-	-
15	Downlink TBF is established according to TS 51.010 clause 40.4.3.14				
16	SS sends downlink data until downlink data transfer is complete	<--	-	-	-

Note 1: GERAN cell priority is not allocated, hence it will be considered as the less than all allowed values of 1 to 8.

6.2.3.30.3.3 Specific message contents

Table 6.2.3.30.3.3-1: Message SI2Quater for Cell 24 (Preamble)

Derivation Path: 44.018 Table 10.5.2.33b.1			
Information Element	Value/remark	Comment	Condition
Repeated E-UTRAN Neighbour Cells ::= SEQUENCE {			
EARFCN	Same as cell 1	This field specifies the E-UTRA Absolute Radio Frequency Channel Number as defined in 3GPP TS 36.104.	
Measurement Bandwidth	Same as cell 1		
E-UTRAN_PRIORITY	'100'B	Same as cell 1	
E-UTRAN_QRXLEVMIN	17 (-106 dBm)		
}			

Table 6.2.3.30.3.3-2: Message ATTACH REQUEST (Preamble)

Derivation Path: Table 9.4.1/3GPP TS 24.008			
Information Element	Value/remark	Comment	Condition
MS Radio Access capability			
GERAN to E-UTRA support in GERAN packet transfer mode	'10'B or '11'B	UTRAN Neighbour Cell measurements and MS autonomous cell reselection to E-UTRAN and CCN towards E-UTRAN, E-UTRAN Neighbour Cell measurement reporting and Network controlled cell reselection to E-UTRAN	
Mobile station classmark 3			
E-UTRA FDD support	'0'B or '1'B		C1
..E-UTRA TDD support	'0'B or '1'B		C1

C1	At least one of these fields shall be set to '1'B
----	---

Table 6.2.3.30.3.3-3: Message PACKET MEASUREMENT ORDER (step 2, Table 6.2.3.30.3.2-3)

Derivation Path: 51.010-1 clause 42.4.3.2.3			
Information Element	Value/remark	Comment	Condition
Global TFI	TFI of the uplink TBF		
NC Measurement parameters ::= {			
NETWORK_CONTROL_ORDER	'10'B	NC2	
NC_REPORTING_PERIOD_I	'111'B	61.44 sec	
NC_REPORTING_PERIOD_T	'010'B	1.92 sec	
}			
NC_FREQUENCY_LIST	0	Not present	

Table 6.2.3.30.3.3-4: Message PACKET CELL CHANGE ORDER (step 7, Table 6.2.3.30.3.2-3)

Derivation Path: 51.010-1 clause 42.4.3.2.1			
Information Element	Value/remark	Comment	Condition
Global TFI	TFI of the uplink TBF		
IMMEDIATE_REL	1		
E-UTRAN Target cell IE			
EARFCN	specified for cell 1		
Physical Layer Cell Identity	specified for cell 1		

Table 6.2.3.30.3.3-5: RRCConnectionRequest (step 8, Table 6.2.3.30.3.2-3)

Derivation Path: 36.508 table 4.6.1-16			
Information Element	Value/remark	Comment	Condition
ue-Identity	Any allowed value		

Table 6.2.3.30.3.3-6: Message PACKET CELL CHANGE FAILURE (step 13, Table 6.2.3.30.3.2-3)

Derivation Path: 51.010-1 clause 42.4.3.2.2			
Information Element	Value/remark	Comment	Condition
CAUSE	'0010'B		

6.2.3.31 Inter-RAT cell reselection / From UTRA_Idle (low priority) to E-UTRA RRC_IDLE (high priority) according to RAT priority provided by dedicated signalling

6.2.3.31.1 Test Purpose (TP)

(1)

```
with { UE in UTRA_Idle state }
ensure that {
  when { UE detects the cell re-selection criteria are met for the cell which belongs to the high
  priority inter-RAT E-UTRA cell based on the configured RAT priority provided by dedicated signaling
  }
  then { UE reselects the cell which belongs to the higher priority inter-RAT E-UTRA cell }
}
```

6.2.3.31.2 Conformance requirements

References: The conformance requirements covered in the present TC are specified in: TS 25.304, clause 5.2.6.1.2a and 5.2.6.1.4a; TS 25.331, clause 8.3.3.3 and 8.6.7.23; TS 36.331, clause 5.3.3.4.

[TS 25.304, clause 5.2.6.1.2a]

If the UE has received absolute priority information for inter-RAT layers, the UE shall follow these rules:

- The UE shall perform measurements of inter-RAT layers with a priority higher than the priority of the current serving cell.

NOTE: The rate of these measurements may vary depending on whether S_{rxlev} and S_{qual} of the serving cell are above or below $S_{prioritysearch1}$ and $S_{prioritysearch2}$. This is specified in [10].

- For inter-RAT layers with a priority lower than the priority of the current serving cell:
 - If $S_{rxlev_{ServingCell}} > S_{prioritysearch1}$ and $S_{qual_{ServingCell}} > S_{prioritysearch2}$ the UE may choose not to perform measurements of inter-RAT layers of lower priority.
 - If $S_{rxlev_{ServingCell}} \leq S_{prioritysearch1}$ or $S_{qual_{ServingCell}} \leq S_{prioritysearch2}$ the UE shall perform measurements of inter-RAT layers of lower priority.

[TS 25.304, clause 5.2.6.1.4a]

Absolute priorities of different absolute priority layers may be provided to the UE. The following cell reselection criteria are used for inter-frequency cells if absolute priority information for inter-frequency is available to the UE, and inter-RAT cells if absolute priority information for inter-RAT is available to the UE.

...

The UE shall inherit the priorities provided by dedicated signalling and the remaining validity time (i.e., T320 in E-UTRA, T322 in UTRA and T3230 in GERAN), if configured, at inter-RAT cell (re)selection.

The following definitions apply:

- Criterion 1: the $S_{rxlev_{nonServingCell,x}}$ of a cell on an evaluated higher absolute priority layer is greater than $Thresh_{x,high}$ during a time interval $T_{reselection}$;
- ...
- Criterion 3: $S_{rxlev_{ServingCell}} < Thresh_{serving,low}$ or $S_{qual_{ServingCell}} < 0$ and the $S_{rxlev_{nonServingCell,x}}$ of a cell on an evaluated lower absolute priority layer is greater than $Thresh_{x,low}$ during a time interval $T_{reselection}$;

Cell reselection to a cell on a higher absolute priority layer than the camped frequency shall be performed if criterion 1 is fulfilled.

...

Cell reselection to a cell on a lower absolute priority layer than the camped frequency shall be performed if criterion 3 is fulfilled.

If more than one cell meets the above criteria, the UE shall reselect the cell with the highest $Srxlev_{nonServingCell,x}$ among the cells meeting the criteria on the highest absolute priority layer.

The UE shall not perform cell reselection to cells for which the cell selection criterion S is not fulfilled.

The UE shall not perform cell reselection until more than 1 second has elapsed since the UE camped on the current serving cell.

[TS 25.331, clause 8.3.3.3]

When the UE receives a UTRAN MOBILITY INFORMATION message, it shall:

- 1> act on received information elements as specified in subclause 8.6;
- 1> if the IE "Dedicated Priority Information" is present:
 - 2> act upon the received IE as described in subclause 8.6.7.23.

[TS 25.331, clause 8.6.7.23]

If the CHOICE "Action" has the value "Configure dedicated priorities", the UE shall:

- 1> clear the variable PRIORITY_INFO_LIST;
- 1> stop timer T322, if it is running;
- 1> set the value of IE "Priority status" in the variable PRIORITY_INFO_LIST to "dedicated_priority";
- 1> for each occurrence of the IE "Priority Level List":
 - 2> create a new entry in the IE "Priority Info List" in the variable PRIORITY_INFO_LIST, and in that new entry:
 - 3> set the CHOICE "Radio Access Technology" to the value received in the IE "Priority Level List";
 - 3> set the IE "priority" to the value received in the IE "Priority Level List";
 - 3> set the values in IE "Frequency List" or "BCCH ARFCN List" to the values received in the IE "Priority Level List".
- 1> set the IE "E-UTRA detection" to the value received in the IE "Priority Level List".
- 1> if the IE "T322" is present:
 - 2> start timer T322 using the value signalled in this IE.
- 1> if the UE is not in CELL_DCH state:
 - 2> take the actions as described in subclause 8.1.1.6.19 using stored System information Block type 19.

[TS 36.331, clause 5.3.3.4]

The UE shall:

- 1> perform the radio resource configuration procedure in accordance with the received *radioResourceConfigDedicated* and as specified in 5.3.10;
- 1> if stored, discard the cell reselection priority information provided by the *idleModeMobilityControlInfo* or inherited from another RAT;
- 1> stop timer T300;
- 1> stop timer T302, if running;
- 1> stop timer T303, if running;
- 1> stop timer T305, if running;

1> perform the actions as specified in 5.3.3.7;

1> stop timer T320, if running;

1> enter RRC_CONNECTED;

1> stop the cell re-selection procedure;

1> set the content of *RRConnectionSetupComplete* message as follows:

...

2> submit the *RRConnectionSetupComplete* message to lower layers for transmission, upon which the procedure ends;

6.2.3.31.3 Test description

6.2.3.31.3.1 Pre-test conditions

System Simulator:

- Cell 1 and Cell 5.
 - Cell 1 suitable neighbour E-UTRA cell
 - Cell 5 UTRA serving cell

NOTE: Common Priority information for Cell 1 & Cell 5: UTRA priority = 3; E-UTRA priority = 4.

UE:

None.

Preamble:

- The UE is in state PS-DCCH+DTCH_DCH (state 6-10) on Cell 5 according to [5].

6.2.3.31.3.2 Test procedure sequence

Tables 6.2.3.31.3.2-1 and 6.2.3.31.3.2-2 illustrates the downlink power levels and other changing parameters to be applied for the cells at various time instants of the test execution. Row marked "T0" denotes the conditions after the preamble, while row marked "T1" is to be applied subsequently. The exact instants on which these values shall be applied are described in the texts in this clause.

Table 6.2.3.31.3.2-1: Time instances of cell power level and parameter changes for E-UTRA cell

	Parameter	Unit	Cell 1	Remark
T0	Cell-specific RS EPRE	dBm/15kHz	-97	
	Qrxlevmin	dBm	-106	Default value
	Srxlev*	dB	9	
T1	Cell-specific RS EPRE	dBm/15kHz	-79	
	Srxlev*	dB	27	$S_{\text{nonServingCell, Cell1}} = \text{Cell-specific RS EPRE} - q_{\text{RxLevMinEUTRA}}$ $S_{\text{nonServingCell, Cell1}} > \text{Thresh}_{\text{Cell1,high}}$
Note: Srxlev is calculated in the UE				

Table 6.2.3.31.3.2-2: Time instances of cell power level and parameter changes for UTRA cell

	Parameter	Unit	Cell 5	Remark
T0	CPICH_Ec	dBm/3.84 MHz	-60	The power levels are such that camping on Cell 5 is guaranteed.
	P-CCPCH	dBm/1.28 MHz	-62	
	Qrxlevmin	dBm	-79	Default value
	Srxlev*	dB	19	
T1	CPICH_Ec	dBm/3.84 MHz	-75	
	P-CCPCH	dBm/1.28 MHz	-77	
	Srxlev*	dB	4	

Note: Srxlev is calculated in the UE

Table 6.2.3.31.3.2-3: Main behaviour

St	Procedure	Message Sequence		TP	Verdict
		U - S	Message		
1	The SS provides dedicated priority information (UTRA priority = 3; E-UTRA priority = 4) and validity timer to the UE.	<--	UTRAN MOBILITY INFORMATION	-	-
2	The UE transmits UTRAN MOBILITY INFORMATION CONFIRM message on Cell 5.	-->	UTRAN MOBILITY INFORMATION CONFIRM	-	-
3	The SS transmits an RRC CONNECTION RELEASE message to release UE connection.	<--	RRC CONNECTION RELEASE	-	-
4	The UE transmits an RRC CONNECTION RELEASE COMPLETE message on Cell 5.	-->	RRC CONNECTION RELEASE COMPLETE	-	-
5	The UE transmits an RRC CONNECTION RELEASE COMPLETE message on Cell 5.	-->	RRC CONNECTION RELEASE COMPLETE	-	-
6	The UE transmits an RRC CONNECTION RELEASE COMPLETE message on Cell 5.	-->	RRC CONNECTION RELEASE COMPLETE	-	-
7	The SS changes Cell 1 and Cell 5 levels according to the row "T1" in table 6.2.3.31.3.2-1 and table 6.2.3.31.3.2-2.	-	-	-	-
8-14	Check: Does the test result of steps 1 to 7 of the generic test procedure in TS 36.508 Table 6.4.2.7A-1 indicate that the UE is camped on E-UTRAN Cell 1? NOTE: The UE performs a TAU procedure.	-	-	1	-
-	At the end of this test procedure sequence, the UE is in end state E-UTRA connected (E2_T3440) according to TS 36.508.	-	-	-	-

6.2.3.31.3.3 Specific message contents

Table 6.2.3.31.3.3-1: UTRAN MOBILITY INFORMATION for Cell 5 (step 1, Table 6.2.3.31.3.2-3)

Derivation Path: 34.108, clause 9			
Information Element	Value/remark	Comment	Condition
UTRANMobilityInformation ::= CHOICE {			
later-than-r3 SEQUENCE {			
criticalExtensions CHOICE {			
criticalExtensions CHOICE {			
r7 SEQUENCE {			
v860NonCriticalExtensions SEQUENCE {			
utranMobilityInformation-v860ext SEQUENCE {			
{			
dedicatedPriorityInformation SEQUENCE {			
action CHOICE {			
configureDedicatedPriorities SEQUENCE {			
{			
t-322	5	Time in minutes	
priorityLevelList SEQUENCE (SIZE (1..maxPrio)) OF SEQUENCE {	2 entry		
priority[1]	3		
radioAccessTechnology[1] CHOICE {			
utraFDD SEQUENCE (SIZE (1..maxNumFDDFreqs)) OF SEQUENCE {	1 entry		UTRA-FDD
uarfcn	Same downlink UARFCN as used for Cell 5		
}			
utraTDD SEQUENCE (SIZE (1..maxNumTDDFreqs)) OF SEQUENCE {	1 entry		UTRA-TDD
uarfcn	Same downlink UARFCN as used for Cell 5		
}			
}			
priority[2]	4		
radioAccessTechnology[2] CHOICE {			
eutra SEQUENCE (SIZE (1..maxNumEUTRAFreqs)) OF SEQUENCE {	1 entry		
earfcn	Same downlink EARFCN as used for Cell 1		
}			
}			
}			
e-UTRA detection	TRUE		
}			
}			
}			
}			
}			
}			
}			
}			
}			
}			
}			
}			
}			
}			
}			

Condition	Explanation
UTRA-FDD	UTRA FDD cell environment
UTRA-TDD	UTRA TDD cell environment

Table 6.2.3.31.3.3-2: RRC CONNECTION RELEASE for Cell 5 (step 3, Table 6.2.3.31.3.2-3)

Derivation Path: 34.108, clause 9			
Information Element	Value/remark	Comment	Condition
RRCCONNECTIONRELEASE ::= CHOICE {			
later-than-r3 SEQUENCE {			
criticalExtensions CHOICE {			
r4 SEQUENCE {			
rrcConnectionRelease-r4 SEQUENCE {			
n-308	2	2 (for CELL_DCH state). Not Present (for UE in other connected mode states).	
releaseCause	normalEvent		
rplmn-information	Not Present		
}			
v4d0NonCriticalExtensions SEQUENCE {}	Not Present		
}			
}			

Table 6.2.3.31.3.3-3: System Information Block type 19 for Cell 5 (preamble and all steps, Table 6.2.3.31.3.2-3)

Derivation Path: 36.508 table 4.4.4.1-1			
Information Element	Value/remark	Comment	Condition
SysInfoType19 ::= SEQUENCE {			
utra-PriorityInfoList ::= SEQUENCE {			
utra-ServingCell ::= SEQUENCE {			
s-PrioritySearch1	8 (16 dB)		
threshServingLow	4 (8 dB)		
}			
}			
eutra-FrequencyAndPriorityInfoList ::= SEQUENCE (SIZE (1..maxNumEUTRAFreqs)) OF SEQUENCE {	1 entry		
earfcn [1]	Same downlink EARFCN as used for Cell 1		
measurementBandwidth [1]	Not present		
qRxLevMinEUTRA [1]	-53 (-106 dBm)		
threshXhigh [1]	12 (24 dB)		
threshXlow [1]	8 (16 dB)		
}			
}			

Note: GERAN cell priority is not allocated, hence it will be considered as the less than all allowed values of 0 to 7.

Table 6.2.3.31.3.3-4: SystemInformationBlockType3 for Cell 1 (preamble and all steps, Table 6.2.3.31.3.2-3)

Derivation path: 36.508 table 4.4.3.3-2			
Information Element	Value/Remark	Comment	Condition
SystemInformationBlockType3 ::= SEQUENCE {			
cellReselectionServingFreqInfo SEQUENCE {			
threshServingLow	5 (10dB)		
cellReselectionPriority	4		
}			
}			

Table 6.2.3.31.3.3-5: SystemInformationBlockType6 for Cell 1 (preamble and all steps, Table 6.2.3.31.3.2-3)

Derivation Path: 36.508 table 4.4.3.3-5			
Information Element	Value/remark	Comment	Condition
SystemInformationBlockType6 ::= SEQUENCE {			
carrierFreqListUTRA-FDD SEQUENCE (SIZE (1..maxUTRA-FDD-Carrier)) OF SEQUENCE {	1 entry		UTRA-FDD
carrierFreq[1]	Downlink UARFCN of Cell 5		
cellReselectionPriority[1]	3		
threshX-High[1]	5 (10dB)		
threshX-Low[1]	5 (10dB)		
}			
carrierFreqListUTRA-TDD SEQUENCE (SIZE (1..maxUTRA-TDD-Carrier)) OF SEQUENCE {	1 entry		UTRA-TDD
carrierFreq[1]	Downlink UARFCN of Cell 5		
cellReselectionPriority[1]	3		
threshX-High[1]	5 (10dB)		
threshX-Low[1]	5 (10dB)		
}			
}			

Condition	Explanation
UTRA-FDD	UTRA FDD cell environment
UTRA-TDD	UTRA TDD cell environment

6.2.3.32 Inter-RAT cell reselection / From E-UTRA RRC_IDLE to UTRA_Idle, $S_{\text{nonintrasearch}}$

6.2.3.32.1 Test Purpose (TP)

(1)

```
with { UE in E-UTRA RRC_IDLE state, and the UE is not in high mobility state }
ensure that {
  when {  $S_{\text{nonintrasearch}}$  is non-zero in system information }
    then { UE perform measurement and reselects the cell which belong to the high priority UTRA cell upon  $S_{\text{rxlev}} > S_{\text{nonintrasearch}}$  }
}
```

6.2.3.32.2 Conformance requirements

References: The conformance requirements covered in the current TC are specified in: TS36.304, clauses 5.2.4.2, 5.2.4.5 and 5.2.4.6; TS36.331, clause 6.3.1.

[TS 36.304, clause 5.2.4.2]

When evaluating for reselection purposes cell selection criterion or $S_{\text{nonServingCell},x}$, the UE shall use parameters provided by the serving cell.

Following rules are used by the UE to limit needed measurements:

- If $S_{\text{intrasearch}}$ is sent in the serving cell and $S_{\text{ServingCell}} > S_{\text{intrasearch}}$, UE may choose to not perform intra-frequency measurements.
- If $S_{\text{ServingCell}} \leq S_{\text{intrasearch}}$, or $S_{\text{intrasearch}}$ is not sent in the serving cell UE shall perform intra-frequency measurements.
- The UE shall apply the following rules for E-UTRAN inter-frequencies and inter-RAT frequencies which are indicated in system information and for which the UE has priority provided as defined in 5.2.4.1:

- For an E-UTRAN inter-frequency or inter-RAT frequency with a reselection priority higher than the reselection priority of the current E-UTRA frequency the UE shall perform measurements of higher priority E-UTRAN inter-frequency or inter-RAT frequencies according to [10].
- For an E-UTRAN inter-frequency with an equal or lower reselection priority than the reselection priority of the current E-UTRA frequency and for inter-RAT frequency with lower reselection priority than the reselection priority of the current E-UTRAN frequency:
 - If $S_{\text{nonintrasearch}}$ is sent in the serving cell and $S_{\text{ServingCell}} > S_{\text{nonintrasearch}}$ UE may choose not to perform measurements of E-UTRAN inter-frequencies or inter-RAT frequency cells of equal or lower priority.
 - If $S_{\text{ServingCell}} \leq S_{\text{nonintrasearch}}$ or $S_{\text{nonintrasearch}}$ is not sent in the serving cell the UE shall perform measurements of E-UTRAN inter-frequencies or inter-RAT frequency cells of equal or lower priority according to [10].

Where $S_{\text{ServingCell}}$ is the S_{rxlev} -value of the serving cell.

[TS 36.304, clause 5.2.4.5]

Criteria 1: the $S_{\text{nonServingCell},x}$ of a cell on evaluated frequency is greater than $\text{Thresh}_{x, \text{high}}$ during a time interval $\text{Treselection}_{\text{RAT}}$;

Cell reselection to a cell on a higher priority E-UTRAN frequency or inter-RAT frequency than serving frequency shall be performed if:

- A cell of a higher priority E-UTRAN frequency or inter-RAT frequency fulfils criteria 1; and
- more than 1 second has elapsed since the UE camped on the current serving cell.

.....

In all the above criteria the value of $\text{Treselection}_{\text{RAT}}$ is scaled when the UE is in the medium or high mobility state as defined in subclause 5.2.4.3.1. If more than one cell meets the above criteria, the UE shall reselect a cell ranked as the best cell among the cells meeting the criteria on the highest priority frequencies or the highest priority RAT if the highest priority RAT is E-UTRA according to criteria defined in 5.2.4.6.

[TS 36.304, clause 5.2.4.6]

The cell-ranking criterion R_s for serving cell and R_n for neighbouring cells is defined by:

$R_s = Q_{\text{meas},s} + Q_{\text{Hyst}}$
$R_n = Q_{\text{meas},n} - Q_{\text{offset}}$

where:

Q_{meas}	RSRP measurement quantity used in cell reselections.
Q_{offset}	For intra-frequency: Equals to $Q_{\text{offset}_{s,n}}$, if $Q_{\text{offset}_{s,n}}$ is valid, otherwise this equals to zero. For inter-frequency: Equals to $Q_{\text{offset}_{s,n}}$ plus $Q_{\text{offset}_{\text{frequency}}}$, if $Q_{\text{offset}_{s,n}}$ is valid, otherwise this equals to $Q_{\text{offset}_{\text{frequency}}}$.

The UE shall perform ranking of all cells that fulfil the cell selection criterion S , which is defined in 5.2.3.2, but may exclude all CSG cells that are known by the UE to be not allowed.

The cells shall be ranked according to the R criteria specified above, deriving $Q_{\text{meas},n}$ and $Q_{\text{meas},s}$ and calculating the R values using averaged RSRP results.

If a cell is ranked as the best cell the UE shall perform cell re-selection to that cell.

...

In all cases, the UE shall reselect the new cell, only if the following conditions are met:

- the new cell is better ranked than the serving cell during a time interval $T_{\text{reselection}_{\text{RAT}}}$,
- more than 1 second has elapsed since the UE camped on the current serving cell.

[TS 36.331, clause 6.3.1]

The IE *SystemInformationBlockType3* contains cell re-selection information common for intra-frequency, inter-frequency and/ or inter-RAT cell re-selection (i.e. applicable for more than one type of cell re-selection but not necessarily all) as well as intra-frequency cell re-selection information other than neighbouring cell related.

[TS 36.133, clause 4.2.2.5.1]

...

The UE shall evaluate whether newly detectable UTRA FDD cells have met the reselection criteria in TS 36.304 within time $(N_{\text{UTRA_carrier}}) * T_{\text{detectUTRA_FDD}}$ when $S_{\text{rxlev}} \leq S_{\text{nonIntraSearchP}}$ or $S_{\text{qual}} \leq S_{\text{nonIntraSearchQ}}$ when $T_{\text{reselection}_{\text{RAT}}} = 0$ provided that the reselection criteria is met by a margin of at least 6dB for reselections based on RSCP, or a margin of at least 3dB for reselections based on E_c/I_o .

...

For a cell that has been already detected, but that has not been reselected to, the filtering shall be such that the UE shall be capable of evaluating that an already identified UTRA FDD cell has met reselection criterion defined in 3GPP TS 36.304 [1] within $(N_{\text{UTRA_carrier}}) * T_{\text{evaluateUTRA_FDD}}$ when $T_{\text{reselection}} = 0$ as specified in table 4.2.2.5.1-1 provided that the reselection criteria is met by a margin of at least 6dB for reselections based on RSCP, or a margin of at least 3dB for reselections based on E_c/I_o .

[TS 36.133, clause 4.2.2.5.2]

...

The UE shall evaluate whether newly detectable UTRA TDD cells have met the reselection criteria in TS 36.304 within time $(N_{\text{UTRA_carrier_TDD}}) * T_{\text{detectUTRA_TDD}}$ when $S_{\text{rxlev}} \leq S_{\text{nonIntraSearchP}}$ or $S_{\text{qual}} \leq S_{\text{nonIntraSearchQ}}$ when $T_{\text{reselection}} = 0$ provided that the reselection criteria is met by a margin of at least 6dB.

...

For a cell that has been already detected, but that has not been reselected to, the filtering shall be such that the UE shall be capable of evaluating that an already identified UTRA TDD cell has met reselection criterion defined in [1] within $N_{\text{UTRA_carrier_TDD}} * T_{\text{evaluateUTRA_TDD}}$ when $T_{\text{reselection}} = 0$ as specified in table 4.2.2.5.2-1 provided that the reselection criteria is met by a margin of at least 6dB.

6.2.3.32.3 Test description

6.2.3.32.3.1 Pre-test conditions

System Simulator:

- Cell 1 and Cell 5.
- System information combination 4 as defined in TS 36.508 [18] clause 4.4.3.1 is used in E-UTRA cells.

UE:

None.

Preamble:

- The UE is in state Registered, Idle mode (state 2) on Cell 1(serving cell) according to [18].

6.2.3.32.3.2 Test procedure sequence

Table 6.2.3.32.3.2-1 and 6.2.3.32.3.2-2 illustrates the downlink power levels and other changing parameters to be applied for the cells at various time instants of the test execution. The exact instants on which these values shall be applied are described in the texts in this clause. Configurations marked "T1" is applied at the points indicated in the Main behaviour description in Table 6.2.3.32.3.2-3.

Table 6.2.3.32.3.2-1: Time instances of cell power level and parameter change for E-UTRA cell

	Parameter	Unit	Cell 1	Remark
T1	Cell-specific RS EPRE	dBm/15kHz	-85	Srxlev of Cell 1 is greater than S _{nonintrasearch}
	Q _{rxlevmin}	dBm	-106	
	S _{nonintrasearch}	dB	[14]	
	Srxlev*	dB	21	
Note: Srxlev is calculated in the UE				

Table 6.2.3.32.3.2-2: Time instances of cell power level and parameter changes for UTRA cell

	Parameter	Unit	Cell 5	Remark
T1	CPICH Ec	dBm/3.84 MHz	-60	
	P-CCPCH	dBm/1.28 MHz	-62	
	Srxlev*	dB	19	Srxlev _{nonServingCell, Cell 5} > Thresh _{Cell 5,high}
Note: Srxlev is calculated in the UE				

Table 6.2.3.32.3.2-3: Main behaviour

St	Procedure	Message Sequence		TP	Verdict
		U - S	Message		
0	Wait for 6 s for UE to receive system information.	-	-	-	-
1	The SS re-adjusts the cell-specific reference signal levels according to row "T1" in table 6.2.3.32.3.2-1 and 6.2.3.32.3.2-2.	-	-	-	-
2	Check: Does the test result of steps 1 to 8 of the generic test procedure in TS 36.508 subclause 6.4.2.8 indicate that the UE is camped on UTRAN Cell 5? (Note 1) NOTE: The UE performs a RAU procedure.	-	-	1	-
Note 1: UE shall search higher priority layer (i.e. UTRA carrier frequency of Cell 5) at least every (60 * N _{layers}) seconds, where N _{layers} = 1 as specified in [4.2.2, 34].					

6.2.3.32.3.3 Specific message contents

Table 6.2.3.32.3.3-1: SystemInformationBlockType3 for Cell 1 (preamble and all steps, table 6.2.3.32.3.2-3)

Derivation Path: 36.508 table 4.4.3.3-2			
Information Element	Value/remark	Comment	Condition
SystemInformationBlockType3 ::= SEQUENCE {			
cellReselectionServingFreqInfo SEQUENCE {			
s-NonIntraSearch	7 (14 dB)		
}			
intraFreqCellReselectionInfo SEQUENCE {			
s-IntraSearch	11 (22 dB)		
}			
}			

Table 6.2.3.32.3.3-2: SystemInformationBlockType6 for Cell 1 (preamble and all steps, Table 6.2.3.32.3.2-3)

Derivation path: 36.508 table 4.4.3.3-5			
Information Element	Value/remark	Comment	Condition
SystemInformationBlockType6 ::= SEQUENCE {			
carrierFreqListUTRA-FDD SEQUENCE (SIZE (1..maxUTRA-FDD-Carrier)) OF SEQUENCE {			UTRA-FDD
carrierFreq[n]	Same downlink UARFCN as used for cell 5		
cellReselectionPriority[n]	5		
threshX-High[n]	5	10 dB	
}			
carrierFreqListUTRA-TDD SEQUENCE (SIZE (1..maxUTRA-TDD-Carrier)) OF SEQUENCE {			UTRA-TDD
carrierFreq[n]	Same downlink UARFCN as used for cell 5		
cellReselectionPriority[n]	5		
threshX-High[n]	5	10 dB	
}			
}			

Condition	Explanation
UTRA-FDD	UTRA FDD cell environment
UTRA-TDD	UTRA TDD cell environment

Table 6.2.3.32.3.3-3: System Information Block Type 19 for Cell 5 (preamble and all steps, Table 6.2.3.32.3.2-3)

Derivation path: 36.508 table 4.4.3.3-5			
Information Element	Value/remark	Comment	Condition
SysInfoType19 ::= SEQUENCE {			
utra-PriorityInfoList SEQUENCE {			
priority	5		
}			
}			

6.2.3.33 Inter-RAT cell reselection / From E-UTRA RRC_IDLE to UTRA_Idle / Squal based cell reselection parameters are broadcasted in E-UTRAN / UE does not support Squal based cell reselection in UTRAN

6.2.3.33.1 Test Purpose (TP)

(1)

```
with { UE in E-UTRA RRC_IDLE state not supporting Squal based inter RAT cell reselection from UTRAN to E-UTRAN and having received SystemInformationBlockType3 containing Squal based cell reselection parameters from serving E-UTRAN cell }
ensure that {
  when { UE detects the cell re-selection criteria based on Srxlev are met for the neighbour UTRA cell }
  then { UE reselects the UTRA cell }
}
```

6.2.3.33.2 Conformance requirements

References: The conformance requirements covered in the present TC are specified in: TS 36.304, clause 5.2.4.5.

[TS 36.304, clause 5.2.4.5]

If *threshServingLowQ* is provided in *SystemInformationBlockType3*, cell reselection to a cell on a higher priority E-UTRAN frequency or inter-RAT frequency than the serving frequency shall be performed if:

- A cell of a higher priority EUTRAN or UTRAN FDD RAT/ frequency fulfils $S_{qual} > Thresh_{X, HighQ}$ during a time interval $T_{reselection_{RAT}}$; or
- A cell of a higher priority UTRAN TDD, GERAN or CDMA2000 RAT/ frequency fulfils $S_{rxlev} > Thresh_{X, HighP}$ during a time interval $T_{reselection_{RAT}}$; and
- More than 1 second has elapsed since the UE camped on the current serving cell.

Otherwise, cell reselection to a cell on a higher priority E-UTRAN frequency or inter-RAT frequency than the serving frequency shall be performed if:

- A cell of a higher priority RAT/ frequency fulfils $S_{rxlev} > Thresh_{X, HighP}$ during a time interval $T_{reselection_{RAT}}$; and
- More than 1 second has elapsed since the UE camped on the current serving cell.

...

If *threshServingLowQ* is provided in *SystemInformationBlockType3*, cell reselection to a cell on a lower priority E-UTRAN frequency or inter-RAT frequency than the serving frequency shall be performed if:

- The serving cell fulfils $S_{qual} < Thresh_{Serving, LowQ}$ and a cell of a lower priority EUTRAN or UTRAN FDD RAT/ frequency fulfils $S_{qual} > Thresh_{X, LowQ}$ during a time interval $T_{reselection_{RAT}}$; or
- The serving cell fulfils $S_{qual} < Thresh_{Serving, LowQ}$ and a cell of a lower priority UTRAN TDD, GERAN or CDMA2000 RAT/ frequency fulfils $S_{rxlev} > Thresh_{X, LowP}$ during a time interval $T_{reselection_{RAT}}$; and
- More than 1 second has elapsed since the UE camped on the current serving cell.

Otherwise, cell reselection to a cell on a lower priority E-UTRAN frequency or inter-RAT frequency than the serving frequency shall be performed if:

- The serving cell fulfils $S_{rxlev} < Thresh_{Serving, LowP}$ and a cell of a lower priority RAT/ frequency fulfils $S_{rxlev} > Thresh_{X, LowP}$ during a time interval $T_{reselection_{RAT}}$; and
- More than 1 second has elapsed since the UE camped on the current serving cell.

...

Cell reselection to another RAT, for which Squal based cell reselection parameters are broadcast in system information, shall be performed based on the Squal criteria if the UE supports Squal (RSRQ) based cell reselection to E-UTRAN from all the other RATs provided by system information which UE supports. Otherwise, cell reselection to another RAT shall be performed based on S_{rxlev} criteria.

6.2.3.33.3 Test description

6.2.3.33.3.1 Pre-test conditions

System Simulator:

- Cell 1 and Cell 5
- System information combination 4 as defined in TS 36.508 [18] clause 4.4.3.1 is used in E-UTRA Cell 1.

UE:

None.

Preamble:

- The UE is in state Registered, Idle mode (state 2) on Cell 1 according to [18].

6.2.3.33.3.2 Test procedure sequence

Table 6.2.3.33.3.2-1 illustrates the downlink power levels and other changing parameters to be applied for the cells at various time instants of the test execution. The configuration marked "T1" is applied at the point indicated in the Main behaviour description in Table 6.2.3.33.3.2-2.

Table 6.2.3.33.3.2-1: Time instances of cell power level and parameter changes

	Parameter	Unit	Cell 1	Cell 5	Remark
T1	Cell-specific RS EPRE	dBm/15kHz	-97	-	The power level value is assigned to satisfy $Srxlev_{Cell\ 1} < Thresh_{Serving, LowP}$. (20 dB) $Squal_{Cell\ 1} > Thresh_{Serving, LowQ}$ (4 dB)
	Noc	dBm/15kHz	Off	-	
	CPICH_Ec	dBm/3.84 MHz	-	-65	The power level value is assigned to satisfy $Srxlev_{Cell\ 5} > Thresh_{X, LowP}$. (2 dB)
	loc	dBm/3.84kHz	-	Off	
	CPICH_Ec/No	dB	-	-2.89	

Table 6.2.3.33.3.2-2: Main behaviour

St	Procedure	Message Sequence		TP	Verdict
		U - S	Message		
1	Wait for 6 s for UE to receive system information.	-	-	-	-
2	The SS changes Cell 1 and Cell 5 level according to the row "T1" in table 6.2.3.33.3.2-1.	-	-	-	-
3	Check: Does the test result of generic test procedure in TS 36.508 subclause 6.4.2.8 indicate that the UE is camped on UTRAN Cell 5?	-	-	1	-

6.2.3.33.3.3 Specific message contents

Table 6.2.3.33.3.3-1: SystemInformationBlockType3 for Cell 1 (preamble and all steps, Table 6.2.3.33.3.2-2)

Derivation Path: 36.508, Table 4.4.3.3-2			
Information Element	Value/remark	Comment	Condition
SystemInformationBlockType3 ::= SEQUENCE {			
cellReselectionServingFreqInfo SEQUENCE {			
threshServingLow	10	20 dB	
}			
lateNonCriticalExtension {			
s-IntraSearch-v920 SEQUENCE {}	Not present	Default of infinity applied.	
s-NonIntraSearch-v920 SEQUENCE {}	Not present	Default 0 dB applied	
q-QualMin-r9	-20 dB		
threshServingLowQ-r9	4		
}			
}			

Table 6.2.3.33.3.3-2: Void

Table 6.2.3.33.3-3: System Information Block type 19 for Cell 5 (preamble and all steps, Table 6.2.3.33.3-2)

Derivation Path: 36.508, Table 4.4.4.1-1			
Information Element	Value/remark	Comment	Condition
SysInfoType19 ::= SEQUENCE {			
eutra-FrequencyAndPriorityInfoList SEQUENCE			
(SIZE (1..maxNumEUTRAFreqs)) OF SEQUENCE {			
earfcn[n]	Same downlink EUARFCN as used for Cell 1		
qRxLevMinEUTRA[n]	-53	-106 dBm	
threshXhigh[n]	15	30 dB	
}			
}			

6.3 Closed Subscriber Group cells

6.3.1 Inter-frequency cell reselection / From E-UTRA RRC_IDLE non-CSG cell to E-UTRA RRC_IDLE CSG cell

6.3.1.1 Test Purpose (TP)

(1)

```
with { UE in E-UTRA RRC_IDLE state }
ensure that {
  when { Manual CSG ID selection is requested }
  then { UE selects the requested CSG cell }
}
```

(2)

```
with { UE in E-UTRA RRC_IDLE state on a non-CSG cell and UE's Allowed CSG list is not empty }
ensure that {
  when { a previously visited allowed E-UTRA CSG cell becomes the strongest cell on its frequency }
  then { UE reselects the E-UTRA CSG cell }
}
```

6.3.1.2 Conformance requirements

References: The conformance requirements covered in the present TC are specified in: TS 36.304, clause 5.2.4.8.1, and 36.133, clauses 4.2.2.10 and 4.2.2.10.1.

[TS 36.304, clause 5.2.4.8.1]

In addition to normal cell reselection, the UE shall use an autonomous search function to detect at least previously visited allowed CSG cells on non-serving frequencies, including inter-RAT frequencies, according to the performance requirements specified in [10], when at least one CSG ID is included in the UE's CSG whitelist. The UE may also use autonomous search on the serving frequency. The UE shall disable the autonomous search function for CSG cells if the UE's CSG whitelist is empty.

NOTE: The UE autonomous search function, per UE implementation, determines when and/or where to search for allowed CSG cells.

If the UE detects one or more suitable CSG cells on different frequencies, then the UE shall reselect to one of the detected cells irrespective of the frequency priority of the cell the UE is currently camped on, if the concerned CSG cell is the highest ranked cell on that frequency.

[TS 36.133, clause 4.2.2.10]

Reselection from non CSG to CSG cells may be performed using UE autonomous search as defined in [1] when at least one CSG ID is included in the UE's CSG whitelist. The requirements in this section are valid for reselection to CSG cells previously visited by the UE when the radio configuration parameters, including the carrier frequency and physical cell identity of the CSG cell, non CSG cell and other neighbour cells are unchanged from the most recent previous visit.

[TS 36.133, clause 4.2.2.10.1]

The UE shall perform search and reselection to an allowed inter-frequency CSG cell that has met reselection criterion defined in [1] and that is in its whitelist, within 6 minutes in the conditions shown in table 4.2.2.10.1-1. There is no need for statistical testing of this requirement.

Table 4.2.2.10.1-1: Parameters for CSG inter-frequency reselection

Parameter	Unit	Cell 1	Cell 2		
EARFCN ^{Note1}		Channel 1	Channel 2		
CSG indicator		False	True		
Physical cell identity ^{Note1}		1	2		
CSG identity		Not sent	Already stored in UE whitelist from previous visit		
Propagation conditions		Static, non multipath			
CSG cell previously visited by UE		Yes			
PBCH_RA	dB	0	0		
PBCH_RB	dB				
PSS_RA	dB				
SSS_RA	dB				
PCFICH_RB	dB				
PHICH_RA	dB				
PHICH_RB	dB				
PDCCH_RA	dB				
PDCCH_RB	dB				
PDSCH_RA	dB				
PDSCH_RB	dB				
OCNG_RA ^{Note 1}	dB				
OCNG_RB ^{Note 1}	dB				
Qrxlevmin	dBm			-140	-140
N_{oc}	dBm/15 kHz			Off	
RSRP ^{Note2}	dBm/15 KHz	-110	-110		
Note 1: For this requirement to be applicable, the EARFCN and physical cell identity for cell 1 and cell 2 shall be unchanged from when the CSG cell was visited previously Note 2: Chosen to ensure that CSG autonomous search has a high probability of success on every attempt made by UE					

6.3.1.3 Test description

6.3.1.3.1 Pre-test conditions

System Simulator:

- Cell 1, Cell 3, Cell 11 and Cell 23 have different tracking areas according to table 6.0.1-2.
- Cell 1, Cell 11 and Cell 23 are not CSG cells.
- Cell 3 is a CSG cell.
- System information combination 3 as defined in TS 36.508 [18] clause 4.4.3.1 is used in E-UTRA Cell 1, Cell 11 and Cell 23.
- System information combination 13 as defined in TS 36.508 [18] clause 4.4.3.1 is used in E-UTRA Cell 3.

UE:

- The UE's Allowed CSG list is empty.

Preamble:

- The UE is in state Switched OFF (state 1) according to [18].

6.3.1.3.2 Test procedure sequence

Table 6.3.1.3.2-1 illustrates the downlink power levels and other changing parameters to be applied for the cells at various time instants of the test execution. Configurations marked "T0", "T1", "T2", "T3" and "T4" are applied at the points indicated in the Main behaviour description in Table 6.3.1.3.2-2.

Table 6.3.1.3.2-1: Time instances of cell power level and parameter changes

	Parameter	Unit	Cell 1	Cell 3	Cell 11	Cell 23	Remark
T0	Cell-specific RS EPRE	dBm/15k Hz	-65	Off	Off	Off	The power levels are such that camping on Cell 1 is guaranteed.
	Qrxlevmin	dBm	-140	-140	-140	-140	
	Srxlev*	dB	75	-	-	-	
T1	Cell-specific RS EPRE	dBm/15k Hz	-65	-85	Off	-91	
	Srxlev*	dB	75	55	-	49	
T2	Cell-specific RS EPRE	dBm/15k Hz	Off	Off	-65	Off	The power levels are such that camping on Cell 11 is guaranteed.
	Srxlev*	dB	-	-	75	-	
T3	Cell-specific RS EPRE	dBm/15k Hz	-65	Off	-91	-85	
	Srxlev*	dB	75	-	49	55	
T4	Cell-specific RS EPRE	dBm/15k Hz	-65	-85	Off	-91	
	Srxlev*	dB	75	55	-	49	

Table 6.3.1.3.2-2: Main behaviour

St	Procedure	Message Sequence		TP	Verdict
		U - S	Message		
1	The UE is switched on.	-	-	-	-
2-17	Steps 2 to 17 of the registration procedure described in TS 36.508 subclause 4.5.2.3 are performed on Cell 1. NOTE: the UE performs registration and the RRC connection is released.	-	-	-	-
18	The SS changes Cell 3 and Cell 23 levels according to row "T1" in table 6.3.1.3.2-1.	-	-	-	-
19	The UE is made to perform manual CSG ID selection and select Cell 3.	-	-	-	-
20	Check: Does the test result of generic test procedure in TS 36.508 subclause 6.4.2.7 indicate that the UE is camped on Cell 3? NOTE: The UE performs a TAU procedure and the RRC connection is released.	-	-	1	-
21	The SS changes Cell1, Cell 3, Cell 11 and Cell 23 levels according to row "T2" in table 6.3.1.3.2-1.	-	-	-	-
22-27	Steps 1 to 6 of the TAU procedure described in TS 36.508 subclause 6.4.2.7 are performed on Cell 11. NOTE: the UE performs a TAU and the RRC connection is released.	-	-	-	-
28	The SS changes Cell 1, Cell 11 and Cell 23 levels according to row "T3" in table 6.3.1.3.2-1.	-	-	-	-
29-34	Steps 1 to 6 of the TAU procedure described in TS 36.508 subclause 6.4.2.7 are performed on Cell 1. NOTE: the UE performs a TAU and the RRC connection is released.	-	-	-	-
35	The SS changes Cell 3, Cell 11 and Cell 23 levels according to row "T4" in table 6.3.1.3.2-1.	-	-	-	-
36-40	Check: Does the test result of Steps 1 to 5 of the generic test procedure in TS 36.508 subclause 6.4.2.7 indicate that the UE is camped on Cell 3 within 6 mins from "T4" to the time <i>RRCCoNNECTIONRequest</i> received by SS? NOTE: The UE performs a TAU procedure.	-	-	2	-
-	At the end of this test procedure sequence, the UE is in end state E-UTRA connected (E2_T3440) according to TS 36.508.	-	-	-	-

6.3.1.3.3

Specific message contents

Table 6.3.1.3.3-1: Conditions for table 6.3.1.3.3-2

Condition	Explanation
Cell 1	This condition applies to system information transmitted on Cell 1.
Cell 3	This condition applies to system information transmitted on Cell 3.
Cell 11	This condition applies to system information transmitted on Cell 11.
Cell 23	This condition applies to system information transmitted on Cell 23.

Table 6.3.1.3.3-2: SystemInformationBlockType1 for Cell 1, 3, 11 and 23 (preamble and all steps, Table 6.3.1.3.2-2)

Derivation Path: 36.508 clause 4.4.3.2			
Information Element	Value/remark	Comment	Condition
SystemInformationBlockType1 ::= SEQUENCE {			
cellAccessRelatedInfo SEQUENCE {			
csg-Indication	FALSE		Cell 1 Cell 11 Cell 23
	TRUE		Cell 3
csg-Identity	Not present		Cell 1 Cell 11 Cell 23
	'000 0000 0000 0000 0000 0000 0011'B		Cell 3
}			
}			

Table 6.3.1.3.3-3: SystemInformationBlockType4 for Cell 3 (Pre-test conditions and all steps, table 6.3.1.3.2-2)

Derivation Path: 36.508 clause 4.4.3.3, Table 4.4.3.3-3			
Information Element	Value/remark	Comment	Condition
SystemInformationBlockType4 ::= SEQUENCE {			
csg-PhysCellIdRange ::= SEQUENCE {			
start	3		
range	Not present	The UE shall apply value 1 in case the field is absent, in which case only the physical cell identity value indicated by start applies.	
}			
}			

6.3.2 Inter-RAT cell reselection / From GSM_Idle/GPRS Packet_Idle to E-UTRA idle CSG cell

6.3.2.1 Test Purpose (TP)

(1)

```
with { UE in GSM/GPRS Registered state and no RR connection }
ensure that {
  when { Manual CSG ID selection is requested }
  then { UE select the suitable E-UTRAN CSG cell }
}
```

(2)

```
with { UE in GSM/GPRS Registered state and no RR connection and UE's Allowed CSG list is not empty }
ensure that {
  when { UE detects a suitable E-UTRAN CSG cell previously visited }
  then { UE reselects the suitable previously visited E-UTRAN CSG cell irrespective of the EUTRAN cell reselection priority }
}
```

6.3.2.2 Conformance requirements

References: The conformance requirements covered in the present TC are specified in: TS 24.301, clause 5.5.3.2.4, TS 45.008, clause 6.6.7.1, TS 45.008, clause 6.6.7.2 and TS 36.304, clause 10.1.3.4.

[TS 24.301, clause 5.5.3.2.4]

If the UE has initiated the tracking area updating procedure due to manual CSG selection and receives a TRACKING AREA UPDATE ACCEPT message, the UE shall check if the CSG ID of the cell where the UE has sent the TRACKING AREA UPDATE REQUEST message is contained in the Allowed CSG list. If not, the UE shall add that CSG ID to the Allowed CSG list.

[TS 45.008, clause 6.6.7.1]

If a mobile station is a member of at least one Closed Subscriber Group, i.e. at least one CSG ID is included in the MS's "Allowed CSG list", then, in addition to normal cell reselection, the MS shall use an autonomous search function to detect UTRAN and/or E-UTRAN CSG cells. The autonomous search function shall at least detect previously visited allowed CSG cells.

NOTE 1: The autonomous search function is implementation dependent and controls when and/or where to search for allowed CSG cells.

...

If the strongest cell (see 3GPP TS 25.304 and 3GPP TS 36.304 for the definition of the strongest cell) which the MS has detected on a UTRAN or E-UTRAN frequency during a time interval $T_{\text{reselection}}$ is a suitable CSG cell (see 3GPP TS 25.304 and 3GPP TS 36.304 for suitability criteria for UTRAN and E-UTRAN CSG cells respectively), the MS shall reselect to this cell irrespective of the cell reselection rules applicable for the cell on which the MS is currently camped.

The following requirements are valid for reselection to allowed CSG cells previously visited by the MS when the radio configuration parameters, including the carrier frequency and PSC/PCI (whichever and if it is applicable) of the CSG cell, non CSG cell and other neighbour cells, are unchanged from the most recent previous visit. The autonomous search and cell re-selection to a previously visited allowed CSG cell shall meet the performance requirements defined as follows:

- the MS shall perform search and re-selection to a previously visited allowed UTRAN FDD CSG cell, that has met the CSG cell re-selection criterion defined above, within 6 minutes in the radio conditions specified for an UTRAN FDD CSG cell in 3GPP TS 36.133 in terms of parameters for CSG inter-RAT UTRAN FDD reselection; UARFCN and PSC shall be unchanged from the most recent previous visit of the UTRAN FDD CSG cell; Serving GSM cell at $RXLEV = -70$ dBm, with 6 GSM neighbours at $RXLEV = -75$ dBm;
- the MS shall perform search and re-selection to a previously visited allowed E-UTRAN CSG cell, that has met the CSG cell re-selection criterion defined above, within 6 minutes in the radio conditions specified for an E-UTRAN CSG cell in 3GPP TS 25.133 in terms of parameters for CSG inter-RAT E-UTRA reselection; E-UARFCN and PCI shall be unchanged from the most recent previous visit of the E-UTRAN CSG cell; Serving GSM cell at $RXLEV = -70$ dBm, with 6 GSM neighbours at $RXLEV = -75$ dBm.

NOTE 4: The above performance requirements are minimum requirements defined to ensure the testability of autonomous CSG search.

[TS 45.008, clause 6.6.7.2]

If NAS requests AS to search for available CSG IDs, the MS shall perform the search and report the results to NAS as described in 3GPP TS 25.304 for UTRAN and as described in 3GPP TS 36.304 for E-UTRAN.

If a CSG ID is manually selected by NAS, the MS shall behave as specified in 3GPP TS 25.304 or in 3GPP TS 36.304, depending on the RAT type of the selected CSG cell.

[TS 45.008, clause 10.1.3.4]

If a mobile station is a member of at least one Closed Subscriber Group, i.e. at least one CSG ID is included in the MS's "Allowed CSG list", then, in addition to normal cell reselection, the MS shall use an autonomous search function to detect UTRAN and/or E-UTRAN CSG cells. The autonomous search function shall at least detect previously visited allowed CSG cells.

6.3.2.3 Test description

6.3.2.3.1 Pre-test conditions

System Simulator:

- Cell 1 and Cell 2.
- Cell 24 and Cell 25.
- Cell 1, Cell 24 and Cell 25 are not CSG cells.
- Cell 2 is CSG cell.
- Cell 24 and Cell 25 have different Routing Area.
- System information combination 5 as defined in TS 36.508 [18] clause 4.4.3.1 is used in E-UTRA Cell 1.
- System information combination 14 as defined in TS 36.508 [18] clause 4.4.3.1 is used in E-UTRA Cell 2.

UE:

- The UE's Allowed CSG list is empty.

Preamble:

- The UE is in state Switched OFF (state 1) according to [18].

6.3.2.3.2 Test procedure sequence

Tables 6.3.2.3.2-1 and 6.3.2.3.2-2 illustrates the downlink power levels and other changing parameters to be applied for the cells at various time instants of the test execution. Row marked "T0" denotes the initial conditions, while rows marked "T1", "T2", "T3" and "T4" are to be applied subsequently. The exact instants on which these values shall be applied are described in the texts in this clause.

Table 6.3.2.3.2-1: Time instances of cell power level and parameter changes for E-UTRA cell

	Parameter	Unit	Cell 1	Cell 2	Remark
T0	Cell-specific RS EPRE	dBm/15kHz	"Off"	"Off"	Power level "Off" is defined in TS36.508 Table 6.2.2.1-1.
	Qrxlevmin	dBm	-106	-106	
T1	Cell-specific RS EPRE	dBm/15kHz	-91	-85	
	Srxlev*	dB	15	21	Srxlev = Cell-specific RS EPRE - qRxLevMinEUTRA
T2	Cell-specific RS EPRE	dBm/15kHz	"Off"	"Off"	Power level "Off" is defined in TS 36.508 Table 6.2.2.1-1.
	Srxlev*	dB	"Off"	"Off"	$S_{\text{nonServingCell, Cell7}} > \text{Thresh}_{\text{Cell7,high}}$
T3	Cell-specific RS EPRE	dBm/15kHz	-85	"Off"	
T4	Cell-specific RS EPRE	dBm/15kHz	-91	-85	
	Srxlev*	dB	15	21	Srxlev = Cell-specific RS EPRE - qRxLevMinEUTRA

Note: Srxlev is calculated in the UE

Table 6.3.2.3.2-2: Time instances of cell power level and parameter changes for GERAN cell

	Parameter	Unit	Cell 24	Cell 25	Remark
T0	RF Signal Level	dBm	-80	"Off"	The power levels are such that camping on Cell 24 is guaranteed.
	RXLEV_ACCESS_MIN	dBm	-101	"Off"	
	C1*	dB	21	"Off"	
T1	RF Signal Level	dBm	-80	"Off"	
	RXLEV_ACCESS_MIN	dBm	-101	"Off"	
	C1*	dB	21	"Off"	
T2	RF Signal Level	dBm	"Off"	-80	The power levels are such that camping on Cell 25 is guaranteed.
	RXLEV_ACCESS_MIN	dBm	"Off"	-101	
	C1*	dB	"Off"	21	
T3	RF Signal Level	dBm	-80	-90	
	RXLEV_ACCESS_MIN	dBm	-101	-101	
	C1*	dB	21	11	
T4	RF Signal Level	dBm	-80	"Off"	
	RXLEV_ACCESS_MIN	dBm	-101	"Off"	
	C1*	dB	21	"Off"	

Note: C1 is calculated in the UE

Table 6.3.2.3.2-3: Main behaviour

St	Procedure	Message Sequence		TP	Verdict
		U - S	Message		
1	The UE is switched on.	-	-	-	-
2	Call the registration procedure described in TS 34.123-3 subclause 6.10.2.7.1.1 performed on Cell 24. NOTE: The UE performs registration and the RR connection is released.	-	-	-	-
3	The SS changes Cell 1 and Cell 2 levels according to the row "T1" in table 6.3.2.3.2-1.	-	-	-	-
4	The UE is made to perform manual CSG ID selection and select Cell 2.	-	-	-	-
5	Check: Does the test result of generic test procedure in TS 36.508 Table 6.4.2.7A-2 indicate that the UE is camped on E-UTRAN Cell 2?	-	-	1	-
5A	Wait for 6 s for UE to receive system information.	-	-	-	-
6	The SS changes Cell 1, Cell 2, Cell 24 and Cell 25 levels according to row "T2" in table 6.3.2.3.2-1 and table 6.3.2.3.2-2.	-	-	-	-
7-17	Steps 1 to 11 of the Routing Area Update procedure described in TS 36.508 subclause 6.4.2.9 are performed on Cell 25. NOTE: The UE performs RAU and the RR connection is released.	-	-	-	-
18	The SS changes Cell 1, Cell 24 and Cell 25 levels according to row "T3" in table 6.3.2.3.2-1 and table 6.3.2.3.2-2.	-	-	-	-
19-29	Steps 1 to 11 of the Routing Area Update procedure described in TS 36.508 subclause 6.4.2.9 are performed on Cell 24. NOTE: The UE performs RAU and the RR connection is released.	-	-	-	-
30	The SS changes Cell 1, Cell 2 and Cell 25 level according to row "T4" in table 6.3.2.3.2-1 and table 6.3.2.3.2-2.	-	-	-	-
31	Check: Does the test result of generic test procedure in TS 36.508 Table 6.4.2.7A-1 indicate that the UE is camped on E-UTRAN Cell 2 within 6 mins?	-	-	2	-

6.3.2.3.3 Specific message contents

Table 6.3.2.3.3-1: SystemInformationBlockType1 for Cell 2 (preamble and all steps, Table 6.3.2.3.2-3)

Derivation Path: 36.508 Table 4.4.3.2-3			
Information Element	Value/remark	Comment	Condition
SystemInformationBlockType1 ::= SEQUENCE {			
cellAccessRelatedInfo SEQUENCE {			
csg-Indication	TRUE		
csg-Identity	1		
}			
}			

Table 6.3.2.3.3-2: SystemInformationBlockType4 for Cell 2 (preamble and all steps, Table 6.3.2.3.2-3)

Derivation Path: 36.508 Table 4.4.3.3-3			
Information Element	Value/remark	Comment	Condition
SystemInformationBlockType4 ::= SEQUENCE {			
csg-PhysCellIdRange SEQUENCE {			
start	2		
range	n4		
}			
}			

Table 6.3.2.3.3-3: SYSTEM INFORMATION TYPE 2 Quarter for Cell 24 and Cell 25 (Pre-test conditions and all steps, Table 6.3.2.3.2-3)

Derivation Path: 36.508 clause 4.4.5, Table 4.4.5-1			
Information Element	Value/remark	Comment	Condition
SI 2QUATER REST OCTETS			
Additions in release 8	H		
Priority and E-UTRAN Parameters Description	1	Present	
Serving Cell Priority Parameters Description	1	Present	
GERAN_PRIORITY	5	Higher priority than E-UTRA	

Table 6.3.2.3.3-4: SystemInformationBlockType7 for Cell 1 and Cell 2 (Pre-test conditions and all steps, Table 6.3.2.3.2-3)

Derivation Path: 36.508 table 4.4.3.3-6			
Information Element	Value/remark	Comment	Condition
SystemInformationBlockType7 ::= SEQUENCE {			
t-ReselectionGERAN	7	INTEGER (0..7)	
speedDependentScalingParameters SEQUENCE	Not present		
{			
carrierFreqsInfoList SEQUENCE (SIZE			
(1..maxGNFG)) OF SEQUENCE {			
carrierFreqsGERAN SEQUENCE [1] {			
startingARFCN	Same as cell 24		
bandIndicator	Same as cell 24		
followingARFCNs CHOICE {			
equallySpacedARFCNs SEQUENCE {			
arfcn-Spacing	Same as cell 24		
numberOfFollowingARFCNs	Same as cell 24		
}			
}			
}			
}			
commonInfo SEQUENCE {			
cellReselectionPriority	5	Higher priority than EUTRA Freq	
ncc-Permitted	'11111111'B		
}			
carrierFreqsGERAN SEQUENCE [2] {			
startingARFCN	Same as cell 25		
bandIndicator	Same as cell 25		
followingARFCNs CHOICE {			
equallySpacedARFCNs SEQUENCE {			
arfcn-Spacing	Same as cell 25		
numberOfFollowingARFCNs	Same as cell 25		
}			
}			
}			
commonInfo SEQUENCE {			
cellReselectionPriority	5	Higher priority than EUTRA Freq	
ncc-Permitted	'11111111'B		
}			
}			
}			
}			

6.3.3 Inter-RAT cell reselection / From UTRA_Idle to E-UTRA RRC_IDLE CSG cell

6.3.3.1 Test Purpose (TP)

(1)

```
with { UE in UTRA IDLE state }
ensure that {
  when { Manual CSG ID selection is requested }
  then { UE select the suitable E-UTRAN CSG cell }
}
```

(2)

```
with { UE in UTRA IDLE state and UE's Allowed CSG list is not empty }
ensure that {
  when { UE detects a suitable E-UTRAN CSG cell previously visited }
  then { UE reselects the suitable previously visited E-UTRAN CSG cell irrespective of the EUTRAN cell reselection priority }
}
```

6.3.3.2 Conformance requirements

References: The conformance requirements covered in the present TC are specified in: TS 25.304, clause 5.6.1, 5.2.6.4.1, TS 36.304 clause 5.2.4.8.1, 5.2.4.6, 5.2.4.8.2, 5.2.4.1 and TS 25.133, clause 4.2.2.11.2.

[TS 24.301, clause 5.5.3.2.4]

If the UE has initiated the tracking area updating procedure due to manual CSG selection and receives a TRACKING AREA UPDATE ACCEPT message, the UE shall check if the CSG ID of the cell where the UE has sent the TRACKING AREA UPDATE REQUEST message is contained in the Allowed CSG list. If not, the UE shall add that CSG ID to the Allowed CSG list.

[TS 25.304, clause 5.6.1]

In the UE on request of NAS, the AS shall scan all RF channels in the UTRA bands according to its capabilities to find available CSG IDs. On each carrier, the UE shall at least search for the strongest cell, read its system information and report available CSG ID(s) together with their "HNB name" (if broadcast) and PLMN(s) to the NAS. The search for available CSG IDs may be stopped on request of the NAS.

If NAS has selected a CSG ID and provided this selection to AS, the UE shall search for an acceptable or suitable cell belonging to the selected CSG ID to camp on.

[TS 25.304, clause 5.2.6.4.1]

In addition to normal cell reselection, the UE shall use an autonomous search function to detect at least previously visited allowed CSG cells on non-serving frequencies, including inter-RAT frequencies, according to the performance requirements specified in [10], when at least one CSG ID is included in the UE's CSG whitelist. The UE is required to perform autonomous search function in Idle, Cell_PCH and URA_PCH states. The UE shall disable the autonomous search function for CSG cells if the UE's CSG whitelist is empty. If "Dedicated CSG frequency(ies)" IE is present, the UE may use the autonomous search function only on these dedicated frequencies and on the other frequencies listed in the system information.

NOTE: The UE autonomous search function, per UE implementation, determines when and/or where to search for allowed CSG cells.

When the UE has no or an empty CSG whitelist, the UE may ignore cells with PSC in the stored range "CSG PSC Split Information" [4] reserved for CSG cells for intra-frequency and inter-frequency measurements and cell re-selections.

...

If the UE detects a suitable CSG cell on a different frequency it shall reselect this cell irrespective of the cell reselection rules applicable for the cell the UE is currently camped on, if the detected suitable CSG cell is the strongest cell on that frequency. If suitable CSG cells are detected on different frequencies and these are the strongest cells on their frequencies, then the UE shall reselect to any one of them.

If the UE detects one or more suitable CSG cell on another RAT, the UE shall reselect to one of them according to [18].

[TS 25.133, clause 4.2.2.11.2]

The UE shall perform search and reselection to an allowed inter-RAT E-UTRA CSG cell that has met CSG reselection criterion defined in [1] and that is in its whitelist, within 6 minutes in the conditions shown in table 4.2.2.11.2-1. There is no need for statistical testing of this requirement.

Table 4.2.2.11.2-1: Parameters for CSG inter-RAT E-UTRA reselection

Parameter	Unit	Cell 1	Cell 2	
UARFCN ^{Note1}		Channel 1	N/A	
EARFCN ^{Note1}		N/A	Channel 2	
CSG indicator		False	True	
Primary scrambling code ^{Note1}		Scrambling code 1	N/A	
Physical cell identity ^{Note1}		N/A	2	
CSG identity		Not sent	Sent (Already stored in UE whitelist from previous visit)	
Propagation conditions		Static, non multipath		
CSG cell previously visited by UE		Yes		
CPICH_RSCP ^{Note2}	dBm	-100	N/A	
CPICH_Ec/lor	dB	-10		
PCCPCH_Ec/lor	dB	-12		
SCCPCH_Ec/lor	dB	-12		
AICH_Ec/lor	dB	-15		
SCH_Ec/lor	dB	-15		
PICH_Ec/lor	dB	-15		
I_{oc}	dBm/3.84 MHz	Off		
PBCH_RA	dB	N/A	0	
PBCH_RB	dB			
PSS_RA	dB			
SSS_RA	dB			
PCFICH_RB	dB			
PHICH_RA	dB			
PHICH_RB	dB			
PDCCH_RA	dB			
PDCCH_RB	dB			
PDSCH_RA	dB			
PDSCH_RB	dB			
OCNG_RA ^{Note 1}	dB			
OCNG_RB ^{Note 1}	dB			
Qrxlevmin	dBm			-140
N_{oc}	dBm/15 kHz			Off
RSRP ^{Note2}	dBm/15 KHz			-110
Note 1:	For this requirement to be applicable, the UARFCN and scrambling code for cell 1 and the EARFCN and physical cell identity for cell 2 shall be unchanged from when the CSG cell was visited previously			
Note 2:	Chosen to ensure that CSG autonomous search has a high probability of success on every attempt made by UE			

[TS 36.304, clause 5.2.4.8.1]

In addition to normal cell reselection, the UE shall use an autonomous search function to detect at least previously visited allowed CSG cells on non-serving frequencies, including inter-RAT frequencies, according to the performance requirements specified in [10], when at least one CSG ID is included in the UE's CSG whitelist. The UE may also use autonomous search on the serving frequency. The UE shall disable the autonomous search function for CSG cells if the UE's CSG whitelist is empty.

NOTE: The UE autonomous search function, per UE implementation, determines when and/or where to search for allowed CSG cells.

If the UE detects one or more suitable CSG cells on different frequencies, then the UE shall reselect to one of the detected cells irrespective of the frequency priority of the cell the UE is currently camped on, if the concerned CSG cell is the highest ranked cell on that frequency.

If the UE detects a suitable CSG cell on the same frequency, it shall reselect to this cell as per normal reselection rules (5.2.4.6.).

[TS 36.304, clause 5.2.4.6]

The cell-ranking criterion R_s for serving cell and R_n for neighbouring cells is defined by:

$$R_s = Q_{\text{meas},s} + Q_{\text{Hyst}}$$

$$R_n = Q_{\text{meas},n} - Q_{\text{offset}}$$

where:

Q_{meas}	RSRP measurement quantity used in cell reselections.
Q_{offset}	For intra-frequency: Equals to $Q_{\text{offset},s,n}$, if $Q_{\text{offset},s,n}$ is valid, otherwise this equals to zero. For inter-frequency: Equals to $Q_{\text{offset},s,n}$ plus $Q_{\text{offset}_{\text{frequency}}}$, if $Q_{\text{offset},s,n}$ is valid, otherwise this equals to $Q_{\text{offset}_{\text{frequency}}}$.

The UE shall perform ranking of all cells that fulfil the cell selection criterion S , which is defined in 5.2.3.2, but may exclude all CSG cells that are known by the UE to be not allowed.

The cells shall be ranked according to the R criteria specified above, deriving $Q_{\text{meas},n}$ and $Q_{\text{meas},s}$ and calculating the R values using averaged RSRP results.

If a cell is ranked as the best cell the UE shall perform cell reselection to that cell. If this cell is found to be not-suitable, the UE shall behave according to subclause 5.2.4.4.

In all cases, the UE shall reselect the new cell, only if the following conditions are met:

- the new cell is better ranked than the serving cell during a time interval $T_{\text{reselection,RAT}}$;
- more than 1 second has elapsed since the UE camped on the current serving cell.

[TS 36.304, clause 5.2.4.8.2]

While camped on a suitable CSG cell, the UE shall apply the normal cell reselection rules as defined in subclause 5.2.4.

[TS 36.304, clause 5.2.4.1]

Absolute priorities of different E-UTRAN frequencies or inter-RAT frequencies may be provided to the UE in the system information, in the *RRConnectionRelease* message, or by inheriting from another RAT at inter-RAT cell (re)selection.

...

While the UE is camped on a suitable CSG cell, the UE shall always consider the current frequency to be the highest priority frequency (i.e. higher than the eight network configured values), irrespective of any other priority value allocated to this frequency.

6.3.3.3 Test description

6.3.3.3.1 Pre-test conditions

System Simulator:

- Cell 1 and Cell 2.
- Cell 5 and Cell 7.
- Cell 1, Cell 5 and Cell 7 are not CSG cells.
- Cell 2 is CSG cell.
- Cell 5 and Cell 7 have different Routing Area.
- System information combination 4 as defined in TS 36.508 [18] clause 4.4.3.1 is used in E-UTRA Cell 1.

- System information combination 11 as defined in TS 36.508 [18] clause 4.4.3.1 is used in E-UTRA Cell 2.

UE:

- The UE's Allowed CSG list is empty.

Preamble:

- The UE is in state Switched OFF (state 1) according to [5].

6.3.3.3.2 Test procedure sequence

Tables 6.3.3.3.2-1 and 6.3.3.3.2-2 illustrate the downlink power levels and other changing parameters to be applied for the cells at various time instants of the test execution. Row marked "T0" denotes the initial conditions, while rows marked "T1", "T2", "T3" and "T4" are to be applied subsequently. The exact instants on which these values shall be applied are described in the texts in this clause.

Table 6.3.3.3.2-1: Time instances of cell power level and parameter changes for E-UTRA cell

	Parameter	Unit	Cell 1	Cell 2	Remark
T0	Cell-specific RS EPRE	dBm/15kHz	"Off"	"Off"	Power level "Off" is defined in TS36.508 Table 6.2.2.1-1.
	Qrxlevmin	dBm	-106	-106	
T1	Cell-specific RS EPRE	dBm/15kHz	-91	-85	
	Srxlev*	dB	15	21	$S_{rxlev} = \text{Cell-specific RS EPRE} - q_{rxLevMinEUTRA}$
T2	Cell-specific RS EPRE	dBm/15kHz	"Off"	"Off"	Power level "Off" is defined in TS 36.508 Table 6.2.2.1-1.
	Srxlev*	dB	N/A	N/A	$S_{nonServingCell, Cell7} > \text{Thresh}_{Cell7,high}$
T3	Cell-specific RS EPRE	dBm/15kHz	-85	"Off"	
T4	Cell-specific RS EPRE	dBm/15kHz	-91	-85	
	Srxlev*	dB	15	21	$S_{rxlev} = \text{Cell-specific RS EPRE} - q_{rxLevMinEUTRA}$

Note: Srxlev is calculated in the UE

Table 6.3.3.3.2-2: Time instances of cell power level and parameter changes for UTRA cell

	Parameter	Unit	Cell 5	Cell 7	Remark
T0	CPICH_Ec	dBm/3.84 MHz	-60	"Off"	The power levels are such that camping on Cell 5 is guaranteed.
	P-CCPCH	dBm/1.28 MHz	-62	"Off"	The power levels are such that camping on Cell 5 is guaranteed.
	Qrxlevmin (FDD)	dBm	-79	-79	Default value
	Qrxlevmin(TDD)	dBm	-81	-81	Default value
	Srxlev*	dB	19	"Off"	
T1	CPICH_Ec	dBm/3.84 MHz	-60	"Off"	
	P-CCPCH	dBm/1.28 MHz	-62	"Off"	
	Srxlev*	dB	19	"Off"	
T2	CPICH_Ec	dBm/3.84 MHz	"Off"	-60	
	P-CCPCH	dBm/1.28 MHz	"Off"	-62	
	Srxlev*	dB	"Off"	19	
T3	CPICH_Ec	dBm/3.84 MHz	-60	-70	
	P-CCPCH	dBm/1.28 MHz	-62	-72	
	Srxlev*	dB	19	9	
T4	CPICH_Ec	dBm/3.84 MHz	-60	"Off"	
	P-CCPCH	dBm/1.28 MHz	-62	"Off"	
	Srxlev*	dB	19	"Off"	

Note : Srxlev is calculated in the UE

Table 6.3.3.2-3: Main behaviour

St	Procedure	Message Sequence		TP	Verdict
		U - S	Message		
1	The UE is switched on.	-	-	-	-
2-13	Steps 2 to 13 of the registration procedure described in TS 34.108 subclause 7.2.2.3.3 are performed on Cell 5. NOTE: The UE performs registration and the RRC connection is released.	-	-	-	-
14	The SS changes Cell 1 and Cell 2 levels according to the row "T1" in table 6.3.3.2-1.	-	-	-	-
15	The UE is made to perform manual CSG ID selection and select Cell 2.	-	-	-	-
16	Check: Does the test result of generic test procedure in TS 36.508 Table 6.4.2.7A-2 indicate that the UE is camped on E-UTRAN Cell 2?	-	-	1	-
16A	Wait for 6 s for UE to receive system information.	-	-	-	-
17	The SS changes Cell 1, Cell 2, Cell 5 and Cell 7 levels according to row "T2" in table 6.3.3.2-1 and table 6.3.3.2-2.	-	-	-	-
18-27	Steps 1 to 10 of the Routing Area Update procedure described in TS 36.508 subclause 6.4.2.8 are performed on Cell 7. NOTE: The UE performs RAU and the RRC connection is released.	-	-	-	-
28	The SS changes Cell 1, Cell 5 and Cell 7 levels according to row "T3" in table 6.3.3.2-1 and table 6.3.3.2-2.	-	-	-	-
29-38	Steps 1 to 10 of the Routing Area Update procedure described in TS 36.508 subclause 6.4.2.8 are performed on Cell 5. NOTE: The UE performs RAU and the RRC connection is released.	-	-	-	-
39	The SS changes Cell 1, Cell 2 and Cell 7 level according to row "T4" in table 6.3.3.2-1 and table 6.3.3.2-2.	-	-	-	-
40-46	Check: Does the test result of Steps 1 to 7 of generic test procedure in TS 36.508 Table 6.4.2.7A-1 indicate that the UE is camped on E-UTRAN Cell 2 within 6 mins from "T4" to the time <i>RRCConnectionRequest</i> received by SS? NOTE: The UE performs a TAU procedure.	-	-	2	-

6.3.3.3.3

Specific message contents

Table 6.3.3.3-1: Conditions for specific message contents in Table 6.3.3.3-2

Condition	Explanation
Cell 1	This condition applies to system information transmitted on Cell 1.
Cell 2	This condition applies to system information transmitted on Cell 2.

Table 6.3.3.3.2-2: SystemInformationBlockType1 for Cell 1 and Cell 2 (preamble and all steps, Table 6.3.3.3.2-3)

Derivation Path: 36.508 Table 4.4.3.2-3			
Information Element	Value/remark	Comment	Condition
SystemInformationBlockType1 ::= SEQUENCE {			
cellAccessRelatedInfo SEQUENCE {			
csg-Indication	FALSE		Cell 1
	TRUE		Cell 2
csg-Identity	Not present		Cell 1
	1		Cell 2
}			
}			
}			

Table 6.3.3.3.3-3: SystemInformationBlockType4 for Cell 2 (preamble and all steps, Table 6.3.3.3.2-3)

Derivation Path: 36.508 Table 4.4.3.3-3			
Information Element	Value/remark	Comment	Condition
SystemInformationBlockType4 ::= SEQUENCE {			
csg-PhysCellIdRange SEQUENCE {			
start	2		
range	n4		
}			
}			

Table 6.3.3.3.4-4: System Information Block type 19 for Cell 5 and Cell 7 (Pre-test conditions and all steps, Table 6.3.3.3.2-3)

Derivation Path: 36.508 clause 4.4.4.1, Table 4.4.4.1-1			
Information Element	Value/remark	Comment	Condition
SysInfoType19 ::= SEQUENCE {			
utra-PriorityInfoList SEQUENCE {			
utra-ServingCell SEQUENCE {			
priority	5	Higher priority than E-UTRA	
}			
eutra-FrequencyAndPriorityInfoList SEQUENCE (SIZE (1..maxNumEUTRAFreqs)) OF SEQUENCE			
earfcn[n]	Same downlink EARFCN as used for cell 1		
priority[n]	4		
}			
}			

Table 6.3.3.3-5: SystemInformationBlockType6 for Cell 1 and Cell 2 (Pre-test conditions and all steps, Table 6.3.3.3-2-3)

Derivation Path: 36.508 Table 4.4.3.3-5			
Information Element	Value/remark	Comment	Condition
SystemInformationBlockType6 ::= SEQUENCE {			
carrierFreqListUTRA-FDD SEQUENCE (SIZE (1..maxUTRA-FDD-Carrier)) OF SEQUENCE {			UTRA-FDD
carrierFreq[n]	Same downlink UARFCN as used for cell 5		
cellReselectionPriority[n]	5		
}			
carrierFreqListUTRA-TDD SEQUENCE (SIZE (1..maxUTRA-TDD-Carrier)) OF SEQUENCE {			UTRA-TDD
carrierFreq[n]	Same downlink UARFCN as used for cell 5		
cellReselectionPriority[n]	5		
}			
}			

Condition	Explanation
UTRA-FDD	UTRA FDD cell environment
UTRA-TDD	UTRA TDD cell environment

6.3.4 Inter-RAT cell reselection / From UTRA CELL_PCH state to E-UTRA RRC_IDLE CSG cell

6.3.4.1 Test Purpose (TP)

(1)

```
with { UE in UTRA Cell PCH state and UE's Allowed CSG list is not empty }
ensure that {
  when { UE detects a suitable CSG cell that is not the strongest cell on that frequency }
  then { UE does not reselect to the CSG cell }
}
```

(2)

```
with { UE in UTRA Cell PCH state and UE's Allowed CSG list is not empty }
ensure that {
  when { UE detects a suitable E-UTRAN CSG cell previously visited }
  then { UE reselects the suitable previously visited E-UTRAN CSG cell irrespective of the EUTRAN cell reselection priority }
}
```

6.3.4.2 Conformance requirements

References: The conformance requirements covered in the present TC are specified in: TS 25.304, 5.2.6.4.1, TS 36.304 clause 5.2.4.8.1, 5.2.4.6, 5.2.4.8.2, 5.2.4.1, TS 25.133 clause 4.2.2.11.2 and TS 25.331, Annex E.

[TS 25.304, clause 5.2.6.4.1]

In addition to normal cell reselection, the UE shall use an autonomous search function to detect at least previously visited allowed CSG cells on non-serving frequencies, including inter-RAT frequencies, according to the performance requirements specified in [10], when at least one CSG ID is included in the UE's CSG whitelist. The UE is required to perform autonomous search function in Idle, Cell_PCH and URA_PCH states. The UE shall disable the autonomous search function for CSG cells if the UE's CSG whitelist is empty. If "Dedicated CSG frequency(ies)" IE is present, the UE may use the autonomous search function only on these dedicated frequencies and on the other frequencies listed in the system information.

NOTE: The UE autonomous search function, per UE implementation, determines when and/or where to search for allowed CSG cells.

When the UE has no or an empty CSG whitelist, the UE may ignore cells with PSC in the stored range "CSG PSC Split Information" [4] reserved for CSG cells for intra-frequency and inter-frequency measurements and cell re-selections.

...

If the UE detects a suitable CSG cell on a different frequency it shall reselect this cell irrespective of the cell reselection rules applicable for the cell the UE is currently camped on, if the detected suitable CSG cell is the strongest cell on that frequency. If suitable CSG cells are detected on different frequencies and these are the strongest cells on their frequencies, then the UE shall reselect to any one of them.

If the UE detects one or more suitable CSG cell on another RAT, the UE shall reselect to one of them according to [18].

[TS 25.133, clause 4.2.2.11.2]

The UE shall perform search and reselection to an allowed inter-RAT E-UTRA CSG cell that has met CSG reselection criterion defined in [1] and that is in its whitelist, within 6 minutes in the conditions shown in table 4.2.2.11.2-1. There is no need for statistical testing of this requirement.

Table 4.2.2.11.2-1: Parameters for CSG inter-RAT E-UTRA reselection

Parameter	Unit	Cell 1	Cell 2	
UARFCN ^{Note1}		Channel 1	N/A	
EARFCN ^{Note1}		N/A	Channel 2	
CSG indicator		False	True	
Primary scrambling code ^{Note1}		Scrambling code 1	N/A	
Physical cell identity ^{Note1}		N/A	2	
CSG identity		Not sent	Sent (Already stored in UE whitelist from previous visit)	
Propagation conditions		Static, non multipath		
CSG cell previously visited by UE		Yes		
CPICH_RSCP ^{Note2}	dBm	-100	N/A	
CPICH_Ec/Ior	dB	-10		
PCCPCH_Ec/Ior	dB	-12		
SCCPCH_Ec/Ior	dB	-12		
AICH_Ec/Ior	dB	-15		
SCH_Ec/Ior	dB	-15		
PICH_Ec/Ior	dB	-15		
I_{oc}	dBm/3.84 MHz	Off	0	
PBCH_RA	dB	N/A		
PBCH_RB	dB			
PSS_RA	dB			
SSS_RA	dB			
PCFICH_RB	dB			
PHICH_RA	dB			
PHICH_RB	dB			
PDCCH_RA	dB			
PDCCH_RB	dB			
PDSCH_RA	dB			
PDSCH_RB	dB			
OCNG_RA ^{Note 1}	dB			
OCNG_RB ^{Note 1}	dB			
Qrxlevmin	dBm			-140
N_{oc}	dBm/15 kHz			Off
RSRP ^{Note2}	dBm/15 KHz		-110	
Note 1:	For this requirement to be applicable, the UARFCN and scrambling code for cell 1 and the EARFCN and physical cell identity for cell 2 shall be unchanged from when the CSG cell was visited previously			
Note 2:	Chosen to ensure that CSG autonomous search has a high probability of success on every attempt made by UE			

[TS 36.304, clause 5.2.4.8.1]

In addition to normal cell reselection, the UE shall use an autonomous search function to detect at least previously visited allowed CSG cells on non-serving frequencies, including inter-RAT frequencies, according to the performance requirements specified in [10], when at least one CSG ID is included in the UE's CSG whitelist. The UE may also use autonomous search on the serving frequency. The UE shall disable the autonomous search function for CSG cells if the UE's CSG whitelist is empty.

NOTE: The UE autonomous search function, per UE implementation, determines when and/or where to search for allowed CSG cells.

If the UE detects one or more suitable CSG cells on different frequencies, then the UE shall reselect to one of the detected cells irrespective of the frequency priority of the cell the UE is currently camped on, if the concerned CSG cell is the highest ranked cell on that frequency.

If the UE detects a suitable CSG cell on the same frequency, it shall reselect to this cell as per normal reselection rules (5.2.4.6.).

[TS 36.304, clause 5.2.4.6]

The cell-ranking criterion R_s for serving cell and R_n for neighbouring cells is defined by:

$$R_s = Q_{\text{meas},s} + Q_{\text{Hyst}}$$

$$R_n = Q_{\text{meas},n} - Q_{\text{offset}}$$

where:

Q_{meas}	RSRP measurement quantity used in cell reselections.
Q_{offset}	For intra-frequency: Equals to $Q_{\text{offset}_{s,n}}$, if $Q_{\text{offset}_{s,n}}$ is valid, otherwise this equals to zero. For inter-frequency: Equals to $Q_{\text{offset}_{s,n}}$ plus $Q_{\text{offset}_{\text{frequency}}}$, if $Q_{\text{offset}_{s,n}}$ is valid, otherwise this equals to $Q_{\text{offset}_{\text{frequency}}}$.

The UE shall perform ranking of all cells that fulfil the cell selection criterion S , which is defined in 5.2.3.2, but may exclude all CSG cells that are known by the UE to be not allowed.

The cells shall be ranked according to the R criteria specified above, deriving $Q_{\text{meas},n}$ and $Q_{\text{meas},s}$ and calculating the R values using averaged RSRP results.

If a cell is ranked as the best cell the UE shall perform cell reselection to that cell. If this cell is found to be not-suitable, the UE shall behave according to subclause 5.2.4.4.

In all cases, the UE shall reselect the new cell, only if the following conditions are met:

- the new cell is better ranked than the serving cell during a time interval $T_{\text{reselection}_{\text{RAT}}}$;
- more than 1 second has elapsed since the UE camped on the current serving cell.

[TS 36.304, clause 5.2.4.8.2]

While camped on a suitable CSG cell, the UE shall apply the normal cell reselection rules as defined in subclause 5.2.4.

[TS 36.304, clause 5.2.4.1]

Absolute priorities of different E-UTRAN frequencies or inter-RAT frequencies may be provided to the UE in the system information, in the *RRConnectionRelease* message, or by inheriting from another RAT at inter-RAT cell (re)selection.

...

While the UE is camped on a suitable CSG cell, the UE shall always consider the current frequency to be the highest priority frequency (i.e. higher than the eight network configured values), irrespective of any other priority value allocated to this frequency.

[TS 25.331, Annex E]

This annex contains the definitions of the bits in EUTRA Feature Group Indicators.

In this release of the specification the UE shall include the optional EUTRA Feature Group Indicators IE in the UE multi-mode/multi RAT capability IE of the RRC message. For a specific indicator, if all functionalities for a feature group listed in Table E.1 have been implemented and tested, the UE shall set the indicator as "true" (as one), else (i.e. if any one of the functionalities in a feature group listed in Table E.1 have not been implemented or tested), the UE shall set the indicator as zero.

The UE shall set all indicators, which do not have a definition in the table E.1, as "false" (as zero).

If the optional EUTRA Feature Group Indicators IE is not included by a UE supporting a future release of the specification, the network may assume the UE supports all features in the feature groups listed in table E.1 and deployed in the network.

Table E.1: Definitions of feature group indicators

Index of indicator (bit number)	Definition (description of the supported functionality, if indicator set to 'true')	Notes
1 (leftmost bit)	- UTRA CELL_PCH to EUTRA RRC_IDLE cell reselection - UTRA URA_PCH to EUTRA RRC_IDLE cell reselection	
2	EUTRAN measurements and reporting in connected mode	
3	Undefined	
4	Undefined	

Clarification for mobility to EUTRAN

For mobility to E-UTRAN, it is assumed that we have 6 main "functions":

- A. Support of measurements and cell reselection procedure in idle mode
- B. Support of measurements and cell reselection procedure in CELL/URA_PCH
- C. Support of RRC release with redirection procedure
- D. Support of RRC reject with redirection procedure
- E. Support of EUTRAN measurements and reporting in connected mode
- F. Support of handover procedure in connected mode

Of the above, all UEs that indicate support of E-UTRA in UE capability signalling "Support of E-UTRA FDD" or "Support of E-UTRA TDD" support A), C) and D) EUTRA bands.

For B) above, UEs indicate support by the Group 1 indicator bit (if Group 1 is set to "true", it is supported for all EUTRA bands the UE supports).

For E) above, UEs indicate support by the Group 2 indicator bit (if Group 2 is set to "true", it is supported for all EUTRA bands the UE supports). The compressed mode capability for supported E-UTRA frequency bands ("Need for compressed mode") in "Measurement capability extension" is ignored by the network when Group 2 is set to "false".

For F) above, UEs indicate support by the separate UE capability signalling "Support of Inter-RAT PS Handover to E-UTRA FDD/TDD" defined in TS 25.306 (if this bit is set to "true", PS handover is supported for all EUTRA bands the UE supports). This bit can only be set to "true" if the UE has set the Group 2 indicator bit to "true".

6.3.4.3 Test description

6.3.4.3.1 Pre-test conditions

System Simulator:

- Cell 1 and Cell 2.

- Cell 5.
- Cell 1, Cell 5 are not CSG cells.
- Cell 2 is CSG cell.
- System information combination 4 as defined in TS 36.508 [18] clause 4.4.3.1 is used in E-UTRA Cell 1.
- System information combination 11 as defined in TS 36.508 [18] clause 4.4.3.1 is used in E-UTRA Cell 2.

UE:

- The UE's Allowed CSG list is not empty and it includes the CSG ID of Cell 2.

Preamble:

- Cell 2 is a previously visited cell.
- The UE is in state CELL_PCH (state 6-12) on Cell 5 according to [5].

6.3.4.3.2 Test procedure sequence

Table 6.3.4.3.2-1 and Table 6.3.4.3.2-2 illustrate the downlink power levels and other changing parameters to be applied for the cells at various time instants of the test execution. Row marked "T0" denotes the initial conditions, while rows marked "T1" and "T2" are to be applied subsequently. The exact instants on which these values shall be applied are described in the texts in this clause.

Table 6.3.4.3.2-1: Time instances of cell power level and parameter changes for E-UTRA cell

	Parameter	Unit	Cell 1	Cell 2	Remark
T0	Cell-specific RS EPRE	dBm/15kHz	"Off"	"Off"	Power level "Off" is defined in TS36.508 Table 6.2.2.1-1.
	Qrxlevmin	dBm	-106	-106	
T1	Cell-specific RS EPRE	dBm/15kHz	-85	-91	
	Srxlev*	dB	21	15	Srxlev = Cell-specific RS EPRE - qRxLevMinEUTRA
T2	Cell-specific RS EPRE	dBm/15kHz	-91	-85	
	Srxlev*	dB	15	21	Srxlev = Cell-specific RS EPRE - qRxLevMinEUTRA
Note: Srxlev is calculated in the UE					

Table 6.3.4.3.2-2: Time instances of cell power level and parameter changes for UTRA cell

	Parameter	Unit	Cell 5	Remark
T0	CPICH_Ec	dBm/3.84 MHz	-60	
	P-CCPCH	dBm/1.28 MHz	-62	
	Qrxlevmin (FDD)	dBm	-79	Default value
	Qrxlevmin(TDD)	dBm	-81	Default value
	Srxlev*	dB	19	
T1	CPICH_Ec	dBm/3.84 MHz	-60	
	P-CCPCH	dBm/1.28 MHz	-62	
	Srxlev*	dB	19	
T2	CPICH_Ec	dBm/3.84 MHz	-60	
	P-CCPCH	dBm/1.28 MHz	-62	
	Srxlev*	dB	19	

Table 6.3.4.3.2-3: Main behaviour

St	Procedure	Message Sequence		TP	Verdict
		U - S	Message		
1	The SS changes Cell 1 and Cell 2 levels according to the row "T1" in table 6.3.4.3.2-1. (Note 1)	-	-	-	-
2	Check: Does the UE send an <i>RRCConnectionRequest</i> on Cell 2 within 6 minutes?	-	-	1	F
3	The SS changes Cell 1 and Cell 2 levels according to the row "T2" in table 6.3.4.3.2-1.	-	-	-	-
4-10	Check: Does the test result of steps 1 to 7 of the generic test procedure in TS 36.508 Table 6.4.2.7A-1 indicate that the UE is camped on E-UTRAN Cell 2 within 6 minutes from "T2" to the time <i>RRCConnctionRequest</i> received by SS? NOTE: The UE performs a TAU procedure	-	-	2	-
-	At the end of this test procedure sequence, the UE is in end state E-UTRA connected (E2_T3440) according to TS 36.508.	-	-	-	-

Note 1: SS should not send any RRC message after UE has successfully proceed to CELL_PCH state in preamble.

6.3.4.3.3 Specific message contents

Table 6.3.4.3.3-1: Conditions for specific message contents in Table 6.3.4.3.3-2

Condition	Explanation
Cell 1	This condition applies to system information transmitted on Cell 1.
Cell 2	This condition applies to system information transmitted on Cell 2.

Table 6.3.4.3.3-2: *SystemInformationBlockType1* for Cell 1 and Cell 2 (preamble and all steps, Table 6.3.4.3.2-3)

Derivation Path: 36.508 Table 4.4.3.2-3			
Information Element	Value/remark	Comment	Condition
<i>SystemInformationBlockType1</i> ::= SEQUENCE {			
<i>cellAccessRelatedInfo</i> SEQUENCE {			
<i>csg-Indication</i>	FALSE		Cell 1
	TRUE		Cell 2
<i>csg-Identity</i>	Not present		Cell 1
	1		Cell 2
}			
}			

Table 6.3.3.3.3-3: *SystemInformationBlockType4* for Cell 2 (preamble and all steps, Table 6.3.4.3.2-3)

Derivation Path: 36.508 Table 4.4.3.3-3			
Information Element	Value/remark	Comment	Condition
<i>SystemInformationBlockType4</i> ::= SEQUENCE {			
<i>csg-PhysCellIdRange</i> SEQUENCE {			
<i>start</i>	2		
<i>range</i>	n4		
}			
}			

Table 6.3.4.3.3-4: System Information Block type 19 for Cell 5 (Pre-test conditions and all steps, Table 6.3.4.3.2-3)

Derivation Path: 36.508 clause 4.4.4.1, Table 4.4.4.1-1			
Information Element	Value/remark	Comment	Condition
SysInfoType19 ::= SEQUENCE {			
utra-PriorityInfoList SEQUENCE {			
utra-ServingCell SEQUENCE {			
priority	5	Higher priority than E-UTRA	
}			
eutra-FrequencyAndPriorityInfoList SEQUENCE (SIZE (1..maxNumEUTRAFreqs)) OF SEQUENCE	1 entry	the first entry only	
priority[1]	4		
}			
}			

Table 6.3.4.3.3-5: Void**Table 6.3.4.3.3-6: SystemInformationBlockType6 for Cell 1 and Cell 2 (Pre-test conditions and all steps, Table 6.3.4.3.2-3)**

Derivation Path: 36.508 Table 4.4.3.3-5			
Information Element	Value/remark	Comment	Condition
SystemInformationBlockType6 ::= SEQUENCE {			
carrierFreqListUTRA-FDD SEQUENCE (SIZE (1..maxUTRA-FDD-Carrier)) OF SEQUENCE {	1 entry	the first entry only	UTRA-FDD
cellReselectionPriority[1]	5		
}			
carrierFreqListUTRA-TDD SEQUENCE (SIZE (1..maxUTRA-TDD-Carrier)) OF SEQUENCE {	1 entry	the first entry only	UTRA-TDD
cellReselectionPriority[1]	5		
}			
}			

Condition	Explanation
UTRA-FDD	UTRA FDD cell environment
UTRA-TDD	UTRA TDD cell environment

6.3.5 Manual support for CSG ID selection

6.3.5.1 Test Purpose (TP)

(1)

```
with { UE in E-UTRA RRC_IDLE state }
ensure that {
  when { an intra-frequency CSG ID cell in the CSG subscription data for the UE at the network side
is manually selected }
    then { UE camps on a cell with the selected CSG ID }
}
```

(2)

```
with { UE in E-UTRA RRC_IDLE state }
ensure that {
  when { an intra-frequency CSG ID cell in the UE's Allowed CSG list but not in the CSG subscription
data for the UE at the network side is manually selected }
    then { UE is rejected by the network by sending TRACKING AREA UPDATE REJECT with cause #25,
still camps on the original cell and updates the UE's Allowed CSG list by deleting this CSG ID from
the UE's Allowed CSG list }
}
```

(3)

```

with { UE in E-UTRA RRC_IDLE state }
ensure that {
  when { an inter-frequency CSG ID cell not in the UE's Allowed CSG list but in the CSG subscription
data for the UE at the network side is manually selected }
  then { UE camps on the strongest cell with the selected CSG ID, performs a TAU procedure and
updates the UE's Allowed CSG list by adding this CSG ID into the UE's Allowed CSG list }
}

```

6.3.5.2 Conformance requirements

References: The conformance requirements covered in the present TC are specified in: TS 36.304, clause 5.5.1, clause 5.2.4.8.2, TS 23.122, clause 3.1A and clause 4.4.3.1.3.

[TS 36.304, clause 5.5.1]

In the UE on request of NAS, the AS shall scan all RF channels in the E-UTRA bands according to its capabilities to find available CSG IDs of available CSG cells. On each carrier, the UE shall at least search for the strongest cell, read its system information and report available CSG ID(s) belonging to the registered PLMN together with their “HNB name” (if broadcast) to the NAS. The search for available CSG IDs may be stopped on request of the NAS.

If NAS has selected a CSG ID and provided this selection to AS, the UE shall search for an acceptable or suitable cell belonging to the selected CSG ID to camp on.

[TS 36.304, clause 5.2.4.8.2]

While camped on a suitable CSG cell, the UE shall apply the normal cell reselection rules as defined in subclause 5.2.4.

[TS 23.122, clause 3.1A]

If the MS supports CSG, it is provisioned with a list of allowed CSG identities and associated PLMN identities from the USIM if the list is available in the USIM or as described in 3GPP TS 24.285 [47] if the list is not available in the USIM. This list has zero or more entries. There are two modes of CSG selection:

...

- Manual mode: In this mode, the MS indicates to the user the list of available CSGs in the currently registered PLMN. The list of CSGs presented to the user is not restricted by the Allowed CSG list stored in the MS. After the user makes a selection, the MS camps on a cell with the selected CSG identity and may attempt to register with the associated PLMN (see 3GPP TS 24.008 [23] and 3GPP TS 24.301 [23A]).

[TS 23.122, clause 4.4.3.1.3]

The MS displays to the user the CSGs that are available with the currently registered PLMN using all access technologies which support CSGs and which are supported by the MS. For each entry in the list, an indication is provided whether that CSG identity is in the Allowed CSG list stored in the UE for this PLMN. Additional requirements for the display, including for the display of HNB name, can be found in 3GPP TS 22.011 [9].

The user may select a CSG from the available ones and the MS then camps on a cell with the selected CSG identity. The MS attempts to perform a Location Registration on the currently registered PLMN if the selected CSG Identity is not in the allowed CSG list stored in the MS.

6.3.5.3 Test description

6.3.5.3.1 Pre-test conditions

System Simulator:

- Cell 1, Cell 2, Cell 3 and Cell 4.
- Cell 1 is not a CSG cell.
- CSG 4 (Cell 4), CSG 2 (Cell 2), and CSG 3 (Cell 3)
- CSG 4 and CSG 3 are in the CSG subscription data for the UE, CSG 2 is not.
- Cell 3 and Cell 4 have the same tracking areas

- System information combination 13 as defined in TS 36.508 [18] clause 4.4.3.1 is used in Cell 2 and Cell 3.
- System information combination 2 as defined in TS 36.508 [18] clause 4.4.3.1 is used in Cell 1.
- System information combination 7 as defined in TS 36.508 [18] clause 4.4.3.1 is used in Cell 4.

UE:

- CSG 2 is in the UE's Allowed CSG list, while CSG 3 is not.
- The UE is equipped with a USIM containing default values except for those listed below.

USIM field	PLMN	CSG ID
EFACSGL	PLMN 1	CSG 2

Preamble:

- The UE is in state Registered, Idle mode (State 2) according to [18] on Cell 1.

6.3.5.3.2 Test procedure sequence

Table 6.3.5.3.2-1 illustrates the downlink power levels and other changing parameters to be applied for the cells at various time instants of the test execution. Configurations marked "T0", "T1", "T2", "T3" and "T4" are applied at the points indicated in the Main behaviour description in Table 6.3.5.3.2-2.

Table 6.3.5.3.2-1: Time instances of cell power level and parameter changes

	Parameter	Unit	Cell 1	Cell 2	Cell 3	Cell 4	Remark
T0	Cell-specific RS EPRE	dBm/15k Hz	-65	Off	Off	Off	Cell 1 serving cell
	Srxlev*	dB	75	-	-	-	
T1	Cell-specific RS EPRE	dBm/15k Hz	-71	Off	Off	-65	
	Srxlev*	dB	69	-	-	75	
T2	Cell-specific RS EPRE	dBm/15k Hz	-65	Off	Off	-95	
	Srxlev*	dB	75	-	-	45	
T3	Cell-specific RS EPRE	dBm/15k Hz	-71	-65	Off	Off	
	Srxlev*	dB	75	75	-	-	
T4	Cell-specific RS EPRE	dBm/15k Hz	-71	Off	-65	-95	
	Srxlev*	dB	69	-	75	45	

Table 6.3.5.3.2-2: Main behaviour

St	Procedure	Message Sequence		TP	Verdict
		U - S	Message		
1	The SS changes Cell 1 and Cell 4 levels according to row "T1" in table 6.3.5.3.2-1.	-	-	-	-
2	The UE is made to perform manual CSG ID selection and select CSG 4.	-	-	-	-
3	Check: Does the test result of generic test procedure in TS 36.508 subclause 6.4.2.7 indicate that the UE is camped on Cell 4? NOTE: The UE performs a TAU procedure and the RRC connection is released.	-	-	1	P
4	The SS changes Cell1 and Cell 4 levels according to row "T2" in table 6.3.5.3.2-1.	-	-	-	-
5-10	Steps 1 to 6 of the procedure described in TS 36.508 subclause 6.4.2.7 is performed on Cell 1. NOTE: The UE performs a TAU procedure and the RRC connection is released.	-	-	-	-
11	The SS changes Cell 1, Cell 2 and Cell 4 levels according to row "T3" in table 6.3.5.3.2-1.	-	-	-	-
12	Void	-	-	-	-
13	The UE transmits an <i>RRCCONNECTIONREQUEST</i> on Cell 2	-->	<i>RRCCONNECTIONREQUEST</i>	-	-
14	SS transmits an <i>RRCCONNECTIONSETUP</i> message.	<--	RRC: <i>RRCCONNECTIONSETUP</i>	-	-
15	The UE transmits a <i>RRCCONNECTIONSETUPCOMPLETE</i> message to confirm the successful completion of the connection establishment and a TRACKING AREA UPDATE REQUEST message is sent to update the registration of the actual tracking area.	-->	RRC: <i>RRCCONNECTIONSETUPCOMPLETE</i> NAS: TRACKING AREA UPDATE REQUEST	-	-
16	The SS transmits a TRACKING AREA UPDATE REJECT message with cause #25 (not authorized for this CSG) to fail the UE's TAU on Cell 2.	<--	RRC: <i>DLINFORMATIONTRANSFER</i> NAS: TRACKING AREA UPDATE REJECT	-	-
17	The SS transmits an <i>RRCCONNECTIONRELEASE</i> message to release RRC connection and move to RRC_IDLE.	<--	RRC: <i>RRCCONNECTIONRELEASE</i>	-	-
18	Check1: Does the test result of generic test procedure in TS 36.508 subclause 6.4.2.2 indicate that the UE is camped on Cell 1? Check2: Is CSG2 not in the UE's Allowed CSG list?	-	-	2	P
19	The SS changes Cell1, Cell 2, Cell 3 and Cell 4 levels according to row "T4" in table 6.3.5.3.2-1.	-	-	-	-
20	The UE is made to perform manual CSG ID selection and select CSG 3.	-	-	-	-
21-26	Check1: Does the test result of generic test procedure (steps 1 to 6) in TS 36.508 subclause 6.4.2.7 indicate that the UE is camped on Cell 3? Check 2: Is CSG 3 added in the UE's Allowed CSG list? NOTE: The UE performs a TAU procedure and the RRC connection is released.	-	-	3	P

6.3.5.3.3 Specific message contents

Table 6.3.5.3.3-1: Conditions for table 6.3.5.3.3-2, 6.3.5.3.3-3 and 6.3.5.3.3-4

Condition	Explanation
Cell 2	This condition applies to system information transmitted on Cell 2.
Cell 3	This condition applies to system information transmitted on Cell 3.
Cell 4	This condition applies to system information transmitted on Cell 4

Table 6.3.5.3.3-2: SystemInformationBlockType1 for Cell 2, 3 and 4 (preamble and all steps except step 11, Table 6.3.5.3.2-2)

Derivation Path: 36.508 clause 4.4.3.2			
Information Element	Value/remark	Comment	Condition
SystemInformationBlockType1 ::= SEQUENCE {			
cellAccessRelatedInfo SEQUENCE {			
csg-Indication	TRUE		Cell 2 Cell 3 Cell 4
csg-Identity	'000 0000 0000 0000 0000 0000 0010'B		Cell 2
	'000 0000 0000 0000 0000 0000 0011'B		Cell 3
	'000 0000 0000 0000 0000 0000 0100'B		Cell 4
}			
}			

Table 6.3.5.3.3-3: SystemInformationBlockType3 for Cell 4 (preamble and all steps, table 6.3.5.3.2-2)

Derivation Path: 36.508 clause 4.4.3.3, Table 4.4.3.3-2			
Information Element	Value/remark	Comment	Condition
SystemInformationBlockType3 ::= SEQUENCE {			
cellReselectionInfoCommon SEQUENCE {			
q-Hyst	dB20		
}			
}			

Table 6.3.5.3.3-4: SystemInformationBlockType4 for Cell 2, 3 and 4 (preamble and all steps, table 6.3.5.3.2-2)

Derivation Path: 36.508 clause 4.4.3.3, Table 4.4.3.3-3			
Information Element	Value/remark	Comment	Condition
csg-PhysCellIdRange ::= SEQUENCE {			
start	0	Indicates the lowest physical cell identity in the range	
range	n12	Indicates the number of physical cell identities in the range (including <i>start</i>).	
}			
}			

Table 6.3.5.3.3-5: SystemInformationBlockType9 for Cell 2, 3 and 4 (preamble and all steps except for step 11, table 6.3.5.3.2-2)

Derivation Path: 36.331 clause 6.3.1			
Information Element	Value/remark	Comment	Condition
SystemInformationBlockType9 ::= SEQUENCE {			
hnb-Name	"3gppTest_CSG2"		Cell 2
	"3gppTest_CSG3"		Cell 3
	"3gppTest_CSG4"		Cell 4
}			

Table 6.3.5.3.3-6: TRACKING AREA UPDATE REJECT (step 16, Table 6.3.5.3.2-2)

Derivation path: 36.508 table 4.7.2-26			
Information Element	Value/Remark	Comment	Condition
EMM cause	'00011001' B	Not authorized for this CSG	

Table 6.3.5.3.3-7: TRACKING AREA UPDATE REQUEST (step 23, Table 6.3.5.3.2-2)

Derivation path: 36.508 table 4.7.2-27			
Information Element	Value/Remark	Comment	Condition
EPS update type	'000'B	"TA updating"	TA_only
EPS update type	'010'B	"combined TA/LA updating with IMSI attach"	combined_ TA_LA

6.3.6 Ignoring CSG cells in cell selection/reselection when allowed CSG list is empty or not supported

6.3.6.1 Test Purpose (TP)

(1)

```
with { UE in E-UTRA RRC_IDLE state and UE does not support Allowed CSG list or UE's Allowed CSG list is empty }
ensure that {
  when { Srxlev < 0 for non-CSG cell and Srxlev > 0 for intra-frequency CSG cell and Srxlev > 0 for inter-frequency CSG cell }
  then { UE does not select the intra-freq CSG cell nor the inter-frequency CSG cell }
}
```

(2)

```
with { UE in E-UTRA RRC_IDLE state and UE does not support Allowed CSG list or UE's Allowed CSG list is empty }
ensure that {
  when { Srxlev > 0 for non-CSG cell and Srxlev of non-CSG cell > Srxlev of intra-frequency CSG cell and Srxlev of non-CSG cell < Srxlev of inter-frequency CSG cell }
  then { UE selects the non-CSG cell }
}
```

(3)

```
with { UE in E-UTRA RRC_IDLE state and UE does not support Allowed CSG list or UE's Allowed CSG list is empty }
ensure that {
  when { UE detects an intra-frequency CSG cell with  $R_n$  higher than  $R_s$  }
  then { UE does not reselect to the intra-frequency CSG cell }
}
```

(4)

```
with { UE in E-UTRA RRC_IDLE state and UE does not support Allowed CSG list or UE's Allowed CSG list is empty }
```

```

ensure that {
  when { UE detects an inter-frequency CSG cell with  $R_n$  higher than  $R_s$  }
  then { UE does not reselect to the inter-frequency CSG cell }
}

```

6.3.6.2 Conformance requirements

References: The conformance requirements covered in the present TC are specified in: TS 36.304, clause 5.2.3.2, 5.2.4.6 and TS 36.331, clause B.2.

[TS 36.304, clause 5.2.3.2]

The cell selection criterion S is fulfilled when:

$$S_{rxlev} > 0$$

Where:

$$S_{rxlev} = Q_{rxlevmeas} - (Q_{rxlevmin} + Q_{rxlevminoffset}) - P_{compensation}$$

Where:

the signalled value $Q_{rxlevminOffset}$ is only applied when a cell is evaluated for cell selection as a result of a periodic search for a higher priority PLMN while camped normally in a VPLMN [3]. During this periodic search for higher priority PLMN the UE may check the S criteria of a cell using parameter values stored from a different cell of this higher priority PLMN.

S_{rxlev}	Cell Selection RX level value (dB)
$Q_{rxlevmeas}$	Measured cell RX level value (RSRP).
$Q_{rxlevmin}$	Minimum required RX level in the cell (dBm)
$Q_{rxlevminoffset}$	Offset to the signalled $Q_{rxlevmin}$ taken into account in the S_{rxlev} evaluation as a result of a periodic search for a higher priority PLMN while camped normally in a VPLMN [5]
$P_{compensation}$	$\max(P_{EMAX} - P_{UMAX}, 0)$ (dB)
P_{EMAX}	Maximum TX power level an UE may use when transmitting on the uplink in the cell (dBm) defined as P_{EMAX} in [TS 36.101]
P_{UMAX}	Maximum RF output power of the UE (dBm) according to the UE power class as defined in [TS 36.101]

[TS 36.304, clause 5.2.4.6]

The cell-ranking criterion R_s for serving cell and R_n for neighbouring cells is defined by:

$$R_s = Q_{meas,s} + Q_{hyst,s}$$

$$R_n = Q_{meas,n} - Q_{offset}$$

where:

Q_{meas}	RSRP measurement quantity used in cell reselections.
Q_{offset}	For intra-frequency: Equals to $Q_{offsets,n}$, if $Q_{offsets,n}$ is valid, otherwise this equals to zero. For inter-frequency: Equals to $Q_{offset_{s,n}}$ plus $Q_{offset_{frequency}}$, if $Q_{offset_{s,n}}$ is valid, otherwise this equals to $Q_{offset_{frequency}}$.

The UE shall perform ranking of all cells that fulfil the cell selection criterion S, which is defined in 5.2.3.2

The cells shall be ranked according to the R criteria specified above, deriving $Q_{meas,n}$ and $Q_{meas,s}$ and calculating the R values using averaged RSRP results.

If a cell is ranked as the best cell the UE shall perform cell re-selection to that cell. If this cell is found to be not-suitable, the UE shall behave according to subclause 5.2.4.4.

In all cases, the UE shall reselect the new cell, only if the following conditions are met:

- the new cell is better ranked than the serving cell during a time interval $T_{\text{reselection}_{\text{RAT}}}$;
- more than 1 second has elapsed since the UE camped on the current serving cell.

[TS 36.331, clause B.2]

In this release of the protocol, it is mandatory for the UE to support a minimum set of CSG functionality consisting of:

- Identifying whether a cell is CSG or not;
- Ignoring CSG cells in cell selection/reselection.

6.3.6.3 Test description

6.3.6.3.1 Pre-test conditions

System Simulator:

- Cell 1, Cell 2 and Cell 3.
- Cell 1 is not a CSG cell.
- Cell 2 and Cell 3 are CSG cells.
- System information combination 3 as defined in TS 36.508 [18] clause 4.4.3.1 is used in E-UTRA Cell 1.
- System information combination 13 as defined in TS 36.508 [18] clause 4.4.3.1 is used in E-UTRA Cell 2 and Cell 3.

UE:

- If `pc_Allowed_CSG_list`, the UE's Allowed CSG list is empty.

Preamble:

- The UE is in state Switched OFF (state 1) according to [18].

6.3.6.3.2 Test procedure sequence

Table 6.3.6.3.2-1 illustrates the downlink power levels and other changing parameters to be applied for the cells at various time instants of the test execution. Row marked "T0" denotes the initial conditions, while rows marked "T1", "T2" and "T3" are to be applied subsequently. The exact instants on which these values shall be applied are described in the texts in this clause.

Table 6.3.6.3.2-1: Time instances of cell power level and parameter changes

	Parameter	Unit	Cell 1	Cell 2	Cell 3	Remark
T0	Cell-specific RS EPRE	dBm/15k Hz	-115	-97	-85	$Srxlev_{\text{Cell 1}} < 0$ and $Srxlev_{\text{Cell 3}} > Srxlev_{\text{Cell 2}} > 0$.
	Qrxlevmin	dBm	-106	-106	-106	
	Qhyst	dB	0	0	0	
	Srxlev*	dB	-9	9	21	Cell 3 is the strongest cell
T1	Cell-specific RS EPRE	dBm/15k Hz	-85	-91	-73	$Srxlev_{\text{Cell 3}} > Srxlev_{\text{Cell 1}} > Srxlev_{\text{Cell 2}} > 0$.
	Srxlev*	dB	21	15	33	Cell 3 is the strongest cell
T2	Cell-specific RS EPRE	dBm/15k Hz	-85	-79	-115	The power level values are assigned to satisfy $R_{\text{Cell 1}} < R_{\text{Cell 2}}$.
T3	Cell-specific RS EPRE	dBm/15k Hz	-85	-115	-73	The power level values are assigned to satisfy $R_{\text{Cell 1}} < R_{\text{Cell 3}}$.

Table 6.3.6.3.2-2: Main behaviour

St	Procedure	Message Sequence		TP	Verdict
		U - S	Message		
1	The UE is switched on.	-	-	-	-
2	Check: Does the UE send an <i>RRCCoNNECTIONRequest</i> on Cell 2 or Cell 3 within 60 seconds?	-->	<i>RRCCoNNECTIONRequest</i>	1	F
3	The SS changes Cell 1, Cell 2 and Cell 3 levels according to row "T1" in table 6.3.6.3.2-1.	-	-	-	-
4	Check: Does the UE send an <i>RRCCoNNECTIONRequest</i> on Cell 1?	-->	<i>RRCCoNNECTIONRequest</i>	2	P
5-19	Steps 3 to 17 of the registration procedure described in TS 36.508 subclause 4.5.2.3 are performed on Cell 1. NOTE: The UE performs registration and the RRC connection is released.	-	-	-	-
20	The SS changes Cell 1, Cell 2 and Cell 3 levels according to row "T2" in table 6.3.6.3.2-1.	-	-	-	-
21	Check: Does the UE send an <i>RRCCoNNECTIONRequest</i> on Cell 2 within 60 seconds?	-->	<i>RRCCoNNECTIONRequest</i>	3	F
22	The SS changes Cell 1, Cell 2 and Cell 3 levels according to row "T3" in table 6.3.6.3.2-1.	-	-	-	-
23	Check: Does the UE send an <i>RRCCoNNECTIONRequest</i> on Cell 3 within 60 seconds?	-->	<i>RRCCoNNECTIONRequest</i>	4	F

6.3.6.3.3 Specific message contents

Table 6.3.6.3.3-1: Conditions for tables 6.3.6.3.3-2 and 6.3.6.3.3-4

Condition	Explanation
Cell 1	This condition applies to system information transmitted on Cell 1.
Cell 2	This condition applies to system information transmitted on Cell 2.
Cell 3	This condition applies to system information transmitted on Cell 3.

Table 6.3.6.3.3-2: *SystemInformationBlockType1* for Cell 1, 2 and 3 (Pre-test conditions and all steps, Table 6.3.6.3.2-2)

Derivation Path: 36.508 clause 4.4.3.2				
Information Element	Value/remark	Comment	Condition	
<i>SystemInformationBlockType1</i> ::= SEQUENCE {				
<i>cellAccessRelatedInfo</i> SEQUENCE {				
<i>csg-Indication</i>	FALSE			Cell 1
	TRUE			Cell 2 Cell 3
<i>csg-Identity</i>	Not present			Cell 1
	'000 0000 0000 0000 0000 0000 0010'B			Cell 2
	'000 0000 0000 0000 0000 0000 0011'B			Cell 3
}				
}				

Table 6.3.6.3.3-3: SystemInformationBlockType3 for Cell 1, 2 and 3 (Pre-test conditions and all steps, table 6.3.6.3.2-2)

Derivation Path: 36.508 clause 4.4.3.3, Table 4.4.3.3-2			
Information Element	Value/remark	Comment	Condition
SystemInformationBlockType3 ::= SEQUENCE {			
cellReselectionInfoCommon SEQUENCE {			
q-Hyst	dB0		
}			
}			

Table 6.3.6.3.3-4: SystemInformationBlockType4 for Cell 2 and 3 (Pre-test conditions and all steps, table 6.3.6.3.2-2)

Derivation Path: 36.508 clause 4.4.3.3, Table 4.4.3.3-3			
Information Element	Value/remark	Comment	Condition
SystemInformationBlockType4 ::= SEQUENCE {			
csg-PhysCellIdRange ::= SEQUENCE {			
start	2		Cell 2
	3		Cell 3
range	Not present	The UE shall apply value 1 in case the field is absent, in which case only the physical cell identity value indicated by start applies.	
}			
}			

6.3.7 Inter-RAT Cell reselection from E-UTRA idle non-CSG cell to a UTRA CSG cell

6.3.7.1 Test Purpose (TP)

(1)

```
with { UE in E-UTRA RRC_IDLE state and UE's Allowed CSG list is not empty }
ensure that {
  when { UE detects a suitable UTRA CSG cell previously visited }
  then { UE selects the suitable UTRA CSG cell irrespective of its lower priority than EUTRA
cells}
}
```

6.3.7.2 Conformance requirements

References: The conformance requirements covered in the present TC are specified in: TS 36.304, clause 5.2.4.8, 4.3, TS 25.304, clause 5.6.1, 5.2.3.1.2, TS 25.367, clause 6.1, 7.2.3 and TS 36.133, clause 4.2.2.10.2.

[TS 36.304, clause 5.2.4.8]

In addition to normal cell reselection, the UE shall use an autonomous search function to detect allowed CSG cells on non-serving frequencies, including inter-RAT frequencies, when at least one CSG ID is included in the UE's CSG whitelist. The UE may also use autonomous search on the serving frequency. The UE shall disable the autonomous search function for CSG cells if the UE's CSG whitelist is empty.

If the UE detects one or more suitable CSG cells on another RAT, the UE shall reselect to one of them, if allowed according to [19].

[TS 36.304, clause 4.3]

suitable cell:

A "suitable cell" is a cell on which the UE may camp on to obtain normal service. Such a cell shall fulfil all the following requirements.

- The cell is part of either:
 - the selected PLMN, or:
 - the registered PLMN, or:
 - a PLMN of the Equivalent PLMN list
 according to the latest information provided by NAS:
- The cell is not barred, see subclause 5.3.1;
- The cell is part of at least one TA that is not part of the list of "forbidden tracking areas for roaming" [4], which belongs to a PLMN that fulfils the first bullet above;
- The cell selection criteria are fulfilled, see subclause 5.2.3.2;
- For a CSG cell, the CSG ID is part of the allowed CSG list of the UE.

If more than one PLMN identity is broadcast in the cell, the cell is considered to be part of all TAs with TAIs constructed from the PLMN identities and the TAC broadcast in the cell.

[TS 25.304, clause 5.6.1]

In the UE on request of NAS, the AS shall scan all RF channels in the UTRA bands according to its capabilities to find available CSG IDs. On each carrier, the UE shall at least search for the strongest cell, read its system information and report available CSG ID(s) belonging to the registered PLMN together with their "HNB name" (if broadcast) to the NAS. The search for available CSG IDs may be stopped on request of the NAS.

If NAS has selected a CSG ID and provided this selection to AS, the UE shall search for an acceptable or suitable cell belonging to the selected CSG ID to camp on.

[TS 25.304, clause 5.2.3.1.2]

The cell selection criterion S is fulfilled when:

for FDD cells:	$S_{rxlev} > 0 \text{ AND } S_{qual} > 0$
for TDD cells:	$S_{rxlev} > 0$

Where:

$S_{qual} = Q_{qualmeas} - (Q_{qualmin} + Q_{qualminOffset})$ $S_{rxlev} = Q_{rxlevmeas} - (Q_{rxlevmin} + Q_{rxlevminOffset}) - P_{compensation}$
--

Where:

the signalled values $Q_{qualminOffset}$ and $Q_{rxlevminOffset}$ are only applied when a cell is evaluated for cell selection as a result of a periodic search for a higher priority PLMN while camped normally in a VPLMN [5]. During this periodic search for higher priority PLMN the UE may check the S criteria of a cell using parameter values stored from a different cell of this higher priority PLMN.

Squal	Cell Selection quality value (dB) Applicable only for FDD cells.
Srxlev	Cell Selection RX level value (dB)
Q_{qualmeas}	Measured cell quality value. The quality of the received signal expressed in CPICH E_c/N_0 (dB) for FDD cells. CPICH E_c/N_0 shall be averaged as specified in [10]. Applicable only for FDD cells.
$Q_{\text{rxlevmeas}}$	Measured cell RX level value. This is received signal, CPICH RSCP for FDD cells (dBm) and P-CCPCH RSCP for TDD cells (dBm).
Qqualmin	Minimum required quality level in the cell (dB). Applicable only for FDD cells.
QqualminOffset	Offset to the signalled Qqualmin taken into account in the Squal evaluation as a result of a periodic search for a higher priority PLMN while camped normally in a VPLMN [5]
Qrxlevmin	Minimum required RX level in the cell (dBm)
QrxlevminOffset	Offset to the signalled Qrxlevmin taken into account in the Srxlev evaluation as a result of a periodic search for a higher priority PLMN while camped normally in a VPLMN [5]
Pcompensation	$\max(\text{UE_TXPWR_MAX_RACH} - \text{P_MAX}, 0)$ (dB)
UE_TXPWR_MAX_RACH	Maximum TX power level an UE may use when accessing the cell on RACH (read in system information) (dBm)
P_MAX	Maximum RF output power of the UE (dBm)

[TS 25.367, clause 6.1]

During manual CSG ID selection a UE is allowed to perform Location Registration procedure on a CSG cell whose CSD ID is not in the CSG whitelist.

Based on the outcome of a Location Registration procedure initiated on a CSG cell, the UE's CSG whitelist is updated.

[TS 25.367, clause 7.2.3]

Inter-RAT reselection to an allowed CSG cell is supported when the UE is camped on another RAT. The UE requirements are defined in the specifications of the concerned RAT.

[TS 36.133, clause 4.2.2.10.2]

The UE shall perform search and reselection to an allowed inter-RAT UTRAN FDD CSG cell that has met CSG reselection criterion defined in [1] and that is in its whitelist, within 6 minutes in the conditions shown in table 4.2.2.10.2-1. There is no need for statistical testing of this requirement.

Table 4.2.2.10.2-1: Parameters for CSG inter-RAT UTRAN FDD reselection

Parameter	Unit	Cell 1	Cell 2
EARFCN ^{Note1}		Channel 1	N/A
UARFCN ^{Note1}		N/A	Channel 2
CSG indicator		False	True
Physical cell identity ^{Note1}		1	N/A
Primary scrambling code ^{Note1}		N/A	Scrambling code 2
CSG identity		Not sent	Sent (Already stored in UE whitelist from previous visit)
Propagation conditions		Static, non multipath	
CSG cell previously visited by UE		Yes	
PBCH_RA	dB	0	N/A
PBCH_RB	dB		
PSS_RA	dB		
SSS_RA	dB		
PCFICH_RB	dB		
PHICH_RA	dB		
PHICH_RB	dB		
PDCCH_RA	dB		
PDCCH_RB	dB		
PDSCH_RA	dB		
PDSCH_RB	dB		
OCNG_RA ^{Note 1}	dB		
OCNG_RB ^{Note 1}	dB		
Qrxlevmin	dBm		
N_{oc}	dBm/15 kHz	Off	
RSRP ^{Note2}	dBm/15 KHz	-110	
CPICH_RSCP ^{Note2}	dBm	N/A	-100
CPICH_Ec/lor	dB		-10
PCCPCH_Ec/lor	dB		-12
SCCPCH_Ec/lor	dB		-12
AICH_Ec/lor	dB		-15
SCH_Ec/lor	dB		-15
PICH_Ec/lor	dB		-15
I_{oc}	dBm/3.84 MHz		Off
<p>Note 1: For this requirement to be applicable, the EARFCN and physical cell identity for cell 1 and the UARFCN and scrambling code for cell 2 shall be unchanged from when the CSG cell was visited previously</p> <p>Note 2: Chosen to ensure that CSG autonomous search has a high probability of success on every attempt made by UE</p>			

6.3.7.3 Test description

6.3.7.3.1 Pre-test conditions

System Simulator:

- Cell 1 and Cell 2 are E-UTRAN cells
- Cell 5 and Cell 7 are UTRAN cells
- Cell 5 is a UTRA CSG cell
- System information combination 4 as defined in TS 36.508 [18] clause 4.4.3.1 is used in E-UTRA cells.

UE:

- The UE's Allowed CSG list is empty.

Preamble:

- UE is in state Registered, Idle Mode (state 2) according to [18] in Cell 1.

6.3.7.3.2 Test procedure sequence

Tables 6.3.7.3.2-1 & 6.3.7.3.2-2 illustrate the downlink power levels and other changing parameters to be applied for the cells at various time instants of the test execution. Row marked "T0" denotes the initial conditions, while rows marked "T1", "T2", "T3" and "T4" are to be applied subsequently. The exact instants on which these values shall be applied are described in the texts in this clause.

Table 6.3.7.3.2-1: Time instances of cell power level and parameter changes for E-UTRA Cell 1 and Cell 2

	Parameter	Unit	Cell 1	Cell 2	Remark
T0	Cell-specific RS EPRE	dBm/15kHz	-85	OFF	
	Qrxlevmin	dBm	-106	-106	Default value
	Qrxlevminoffset	dB	0	0	Default value
	Qhyst	dB	0	0	Default value
	Srxlev*	dB	21	N/A	Cell 1 is the strongest cell
T1	Cell-specific RS EPRE	dBm/15kHz	-85	OFF	
	Srxlev*	dB	21	N/A	
T2	Cell-specific RS EPRE	dBm/15kHz	OFF	-85	
	Srxlev*	dB	N/A	21	
T3	Cell-specific RS EPRE	dBm/15kHz	-85	-91	
	Srxlev*	dB	21	15	
T4	Cell-specific RS EPRE	dBm/15kHz	-85	OFF	
	Srxlev*	dB	21	N/A	

Note: Srxlev is calculated in the UE

Table 6.3.7.3.2-2: Time instances of cell power level and parameter changes for UTRA Cell 5 and Cell 7

	Parameter	Unit	Cell 5	Cell 7	Remark
T0	CPICH_Ec	dBm/3.84 MHz	OFF	OFF	Camping on Cell 1 is guaranteed
	PCCPCH RSCP	dBm/1.28 MHz	OFF	OFF	Camping on Cell 1 is guaranteed
	Qrxlevmin (FDD)	dBm	-79	-79	Default value
	Qrxlevmin (TDD)	dBm	-81	-81	Default value
	Srxlev*	dB	N/A	N/A	
T1	CPICH_Ec	dBm/3.84 MHz	-60	-66	$Srxlev_{Cell 5} > 0$, for FDD
	PCCPCH RSCP	dBm/1.28 MHz	-62	-68	$Srxlev_{Cell 5} > 0$, for TDD
	Srxlev*	dB	19	13	Cell 5 becomes the suitable cell
T2	CPICH_Ec	dBm/3.84 MHz	OFF	OFF	
	PCCPCH RSCP	dBm/1.28 MHz	OFF	OFF	
	Srxlev*	dB	N/A	N/A	
T3	CPICH_Ec	dBm/3.84 MHz	OFF	-66	
	PCCPCH RSCP	dBm/1.28 MHz	OFF	-68	
	Srxlev*	dB	N/A	13	
T4	CPICH_Ec	dBm/3.84 MHz	-60	-66	$Srxlev_{Cell 5} > 0$, for FDD
	PCCPCH RSCP	dBm/1.28 MHz	-62	-68	$Srxlev_{Cell 5} > 0$, for TDD
	Srxlev*	dB	19	13	Cell 5 becomes the suitable cell

Note: Srxlev is calculated in the UE

Table 6.3.7.3.2-3: Main behaviour

St	Procedure	Message Sequence		TP	Verdict
		U - S	Message		
0	Wait for 6 s for UE to receive system information.	-	-	-	-
1	The SS changes Cell 5 and Cell 7 levels according to the row "T1" in table 6.3.7.3.2-2.	-	-	-	-
2	UE performs manual CSG ID selection. CSG Identity ('000 0000 0000 0000 0000 0000 0010'B) is selected manually and added in UE's Allowed CSG list.	-	-	-	-
3-12	Steps 1 to 10 of the generic test procedure described in TS 36.508 subclause 6.4.2.8 are performed on UTRA CSG Cell 5. NOTE: The UE performs a RAU procedure and the RRC connection is released.	-	-	-	-
13	The SS changes Cell 1, Cell 2, Cell 5 and Cell 7 levels according to the row "T2" in table 6.3.7.3.2-1 and table 6.3.7.3.2-2.	-	-	-	-
14-21	Steps 1 to 8 of the procedure described in TS 36.508 Table 6.4.2.7A-1 is performed on Cell 2. NOTE: The UE performs a TAU procedure and the RRC connection is released.	-	-	-	-
22	The SS changes Cell 1, Cell 2 and Cell 7 levels according to the row "T3" in table 6.3.7.3.2-1 and table 6.3.7.3.2-2.	-	-	-	-
23-28	Steps 1 to 6 of the procedure described in TS 36.508 subclause 6.4.2.7 is performed on Cell 1. NOTE: The UE performs a TAU procedure and the RRC connection is released.	-	-	-	-
28 A	Wait for 6 s for UE to receive system information.	-	-	-	-
29	The SS changes Cell 2 and Cell 5 levels according to the row "T4" in table 6.3.7.3.2-1 and table 6.3.7.3.2-2.	-	-	-	-
30-37	Check: Does the test result of steps 1 to 8 of generic test procedure in TS 36.508 subclause 6.4.2.8 indicate that the UE is camped on UTRAN CSG Cell 5 in 6 mins from "T4" to the time RRC CONNECTION REQUEST received by SS? NOTE: The UE performs a RAU procedure	-	-	1	-

6.3.7.3.3

Specific message contents

Table 6.3.7.3.3-1: Void

Table 6.3.7.3.3-2: Void

Table 6.3.7.3.3-3: SystemInformationBlockType6 for Cell 1 and Cell 2 (preamble and all steps, Table 6.3.7.3.2-3)

Derivation Path: 36.508 clause 4.4.3.3, Table 4.4.3.3-5			
Information Element	Value/remark	Comment	Condition
SystemInformationBlockType6 ::= SEQUENCE {			
carrierFreqListUTRA-FDD SEQUENCE (SIZE (1..maxUTRA-FDD-Carrier)) OF SEQUENCE {	1 entry	the first entry only	UTRA-FDD
cellReselectionPriority[1]	3	Lower priority than E-UTRA	
}			
carrierFreqListUTRA-TDD SEQUENCE (SIZE (1..maxUTRA-TDD-Carrier)) OF SEQUENCE {	1 entry	the first entry only	UTRA-TDD
cellReselectionPriority[1]	3	Lower priority than E-UTRA	
}			
}			

Table 6.3.7.3.3-4: Master Information Block for Cell 5 (preamble and all steps, Table 6.3.7.3.2-3)

Derivation Path: 34.108 clause 6.1.0a.3			
Information Element	Value/remark	Comment	Condition
- CSG Indicator	TRUE		

Table 6.3.7.3.3-5: System Information Block type 3 for Cell 5 (preamble and all steps, Table 6.3.7.3.2-3)

Derivation Path: 34.108 clause 6.1.0b			
Information Element	Value/remark	Comment	Condition
- CSG Identity	'000 0000 0000 0000 0000 0000 0010'B		
- CSG PSC Split Information			
- Start PSC	104		
- Number of PSCs	5		
- PSC Range 2 Offset	Not present		

Table 6.3.7.3.3-6: System Information Block type 19 for Cell 5 and Cell 7 (preamble and all steps, Table 6.3.7.3.2-3)

Derivation Path: 36.508 clause 4.4.4.1, Table 4.4.4.1-1			
Information Element	Value/remark	Comment	Condition
SysInfoType19 ::= SEQUENCE {			
utra-PriorityInfoList SEQUENCE {			
utra-ServingCell SEQUENCE {			
priority	3	Lower priority than E-UTRA	
}			
eutra-FrequencyAndPriorityInfoList SEQUENCE (SIZE (1..maxNumEUTRAFreqs)) OF SEQUENCE	1 entry	the first entry only	
priority[1]	4		
}			
}			

6.3.8 Inter-RAT CSG Cell Reselection from E-UTRA CSG cell to UTRA CSG cell

6.3.8.1 Test Purpose (TP)

(1)

with { UE in E-UTRA RRC_IDLE state and UE's Allowed CSG list is not empty }
ensure that {

```

when { UE detects a suitable UTRA CSG cell previously visited }
then { UE selects the suitable UTRA CSG cell irrespective of its lower priority than EUTRA cells
}
}

```

6.3.8.2 Conformance requirements

References: The conformance requirements covered in the present TC are specified in: TS 36.304, clause 5.2.4.8, 4.3, TS 25.304, clause 4.3, 5.6.1, 5.2.3.1.2, TS 25.367, clause 6.1, 7.4 and TS 36.133, clause 4.2.2.10.2.

[TS 36.304, clause 5.2.4.8]

While camped on a suitable CSG cell, the UE shall apply the normal cell reselection rules as defined in subclause 5.2.4.

To search for suitable CSG cells on non-serving frequencies, the UE may use an autonomous search function. If the UE detects a CSG cell on a non-serving frequency, the UE may reselect to the detected CSG cell if it is the highest ranked cell on its frequency.

If the UE detects one or more suitable CSG cells on another RAT, the UE may reselect to one of them if allowed according to [19].

[TS 36.304, clause 4.3]

suitable cell:

A "suitable cell" is a cell on which the UE may camp on to obtain normal service. Such a cell shall fulfil all the following requirements.

- The cell is part of either:
 - the selected PLMN, or:
 - the registered PLMN, or:
 - a PLMN of the Equivalent PLMN list
 according to the latest information provided by NAS:
- The cell is not barred, see subclause 5.3.1;
- The cell is part of at least one TA that is not part of the list of "forbidden tracking areas for roaming" [4], which belongs to a PLMN that fulfils the first bullet above;
- The cell selection criteria are fulfilled, see subclause 5.2.3.2;
- For a CSG cell, the CSG ID is part of the allowed CSG list of the UE.

If more than one PLMN identity is broadcast in the cell, the cell is considered to be part of all TAs with TAIs constructed from the PLMN identities and the TAC broadcast in the cell.

[TS 25.304, clause 4.3]

suitable cell:

A "suitable cell" is a cell on which the UE may camp on to obtain normal service. Such a cell shall fulfil all the following requirements.

- The cell shall be part of either:
 - the selected PLMN, or:
 - the registered PLMN, or:
 - a PLMN of the Equivalent PLMN list
 according to the latest information provided by the NAS.
- The cell is not barred, see subclause 5.3.1.1;

- The cell is part of at least one LA that is not part of the list of "forbidden LAs for roaming" [9], which belongs to a PLMN that fulfils the first bullet above;
- The cell selection criteria are fulfilled, see subclause 5.2.3.1.2.
- For a CSG cell the CSG ID is part of the Allowed CSG list of the UE.

If the IE "Multiple PLMN List" [4] is broadcast in the cell, the cell is considered to be part of all LAs with LAIs constructed from the PLMN identities in the "Multiple PLMN List" and the LAC broadcast in the cell.

[TS 25.304, clause 5.6.1]

In the UE on request of NAS, the AS shall scan all RF channels in the UTRA bands according to its capabilities to find available CSG IDs. On each carrier, the UE shall at least search for the strongest cell, read its system information and report available CSG ID(s) belonging to the registered PLMN together with their "HNB name" (if broadcast) to the NAS. The search for available CSG IDs may be stopped on request of the NAS.

If NAS has selected a CSG ID and provided this selection to AS, the UE shall search for an acceptable or suitable cell belonging to the selected CSG ID to camp on.

[TS 25.304, clause 5.2.3.1.2]

The cell selection criterion S is fulfilled when:

for FDD cells:	$Srxlev > 0 \text{ AND } Squal > 0$
for TDD cells:	$Srxlev > 0$

Where:

$Squal = Q_{qualmeas} - (Q_{qualmin} + Q_{qualminOffset})$ $Srxlev = Q_{rxlevmeas} - (Q_{rxlevmin} + Q_{rxlevminOffset}) - P_{compensation}$
--

Where:

the signalled values $Q_{qualminOffset}$ and $Q_{rxlevminOffset}$ are only applied when a cell is evaluated for cell selection as a result of a periodic search for a higher priority PLMN while camped normally in a VPLMN [5]. During this periodic search for higher priority PLMN the UE may check the S criteria of a cell using parameter values stored from a different cell of this higher priority PLMN.

Squal	Cell Selection quality value (dB) Applicable only for FDD cells.
Srxlev	Cell Selection RX level value (dB)
$Q_{qualmeas}$	Measured cell quality value. The quality of the received signal expressed in CPICH E_c/N_0 (dB) for FDD cells. CPICH E_c/N_0 shall be averaged as specified in [10]. Applicable only for FDD cells.
$Q_{rxlevmeas}$	Measured cell RX level value. This is received signal, CPICH RSCP for FDD cells (dBm) and P-CCPCH RSCP for TDD cells (dBm).
$Q_{qualmin}$	Minimum required quality level in the cell (dB). Applicable only for FDD cells.
$Q_{qualminOffset}$	Offset to the signalled $Q_{qualmin}$ taken into account in the Squal evaluation as a result of a periodic search for a higher priority PLMN while camped normally in a VPLMN [5]
$Q_{rxlevmin}$	Minimum required RX level in the cell (dBm)
$Q_{rxlevminOffset}$	Offset to the signalled $Q_{rxlevmin}$ taken into account in the Srxlev evaluation as a result of a periodic search for a higher priority PLMN while camped normally in a VPLMN [5]
$P_{compensation}$	$\max(UE_TXPWR_MAX_RACH - P_MAX, 0)$ (dB)
UE_TXPWR_MAX_RACH	Maximum TX power level an UE may use when accessing the cell on RACH (read in system information) (dBm)
P_MAX	Maximum RF output power of the UE (dBm)

[TS 25.367, clause 6.1]

During manual CSG ID selection a UE is allowed to perform Location Registration procedure on a CSG cell whose CSD ID is not in the CSG whitelist.

Based on the outcome of a Location Registration procedure initiated on a CSG cell, the UE's CSG whitelist is updated.

[TS 25.367, clause 7.4]

For reselection between allowed CSG cells, the UE follows the same cell ranking rules as those defined for the UTRA case in [2].

[TS 36.133, clause 4.2.2.10.2]

The UE shall perform search and reselection to an allowed inter-RAT UTRAN FDD CSG cell that has met CSG reselection criterion defined in [1] and that is in its whitelist, within 6 minutes in the conditions shown in table 4.2.2.10.2-1. There is no need for statistical testing of this requirement.

Table 4.2.2.10.2-1: Parameters for CSG inter-RAT UTRAN FDD reselection

Parameter	Unit	Cell 1	Cell 2
EARFCN ^{Note1}		Channel 1	N/A
UARFCN ^{Note1}		N/A	Channel 2
CSG indicator		False	True
Physical cell identity ^{Note1}		1	N/A
Primary scrambling code ^{Note1}		N/A	Scrambling code 2
CSG identity		Not sent	Sent (Already stored in UE whitelist from previous visit)
Propagation conditions		Static, non multipath	
CSG cell previously visited by UE		Yes	
PBCH_RA	dB	0	N/A
PBCH_RB	dB		
PSS_RA	dB		
SSS_RA	dB		
PCFICH_RB	dB		
PHICH_RA	dB		
PHICH_RB	dB		
PDCCH_RA	dB		
PDCCH_RB	dB		
PDSCH_RA	dB		
PDSCH_RB	dB		
OCNG_RA ^{Note1}	dB		
OCNG_RB ^{Note1}	dB		
Qrxlevmin	dBm		
N_{oc}	dBm/15 kHz	Off	
RSRP ^{Note2}	dBm/15 KHz	-110	
CPICH_RSCP ^{Note2}	dBm	N/A	-100
CPICH_Ec/lor	dB		-10
PCCPCH_Ec/lor	dB		-12
SCCPCH_Ec/lor	dB		-12
AICH_Ec/lor	dB		-15
SCH_Ec/lor	dB		-15
PICH_Ec/lor	dB		-15
I_{oc}	dBm/3.84 MHz		Off
Note 1:	For this requirement to be applicable, the EARFCN and physical cell identity for cell 1 and the UARFCN and scrambling code for cell 2 shall be unchanged from when the CSG cell was visited previously		
Note 2:	Chosen to ensure that CSG autonomous search has a high probability of success on every attempt made by UE		

6.3.8.3 Test description

6.3.8.3.1 Pre-test conditions

System Simulator:

- Cell 1, Cell 2 and Cell 5
- Cell 1 is an E-UTRA CSG cell
- Cell 5 is a UTRA CSG cell
- System information combination 4 as defined in TS 36.508 [18] clause 4.4.3.1 is used in E-UTRA Cell 2.
- System information combination 11 as defined in TS 36.508 [18] clause 4.4.3.1 is used in E-UTRA Cell 1.

UE:

- The UE's Allowed CSG list is not empty and it includes a CSG ID of Cell 1.

Preamble:

- UE is in state Registered, Idle Mode (state 2) according to [18] in Cell 1.

6.3.8.3.2 Test procedure sequence

Tables 6.3.8.3.2-1 & 6.3.8.3.2-2 illustrate the downlink power levels and other changing parameters to be applied for the cells at various time instants of the test execution. Row marked "T0" denotes the initial conditions, while rows marked "T1", "T2" and "T3" are to be applied subsequently. The exact instants on which these values shall be applied are described in the text in this clause.

Table 6.3.8.3.2-1: Time instances of cell power level and parameter changes for E-UTRA cells

	Parameter	Unit	Cell 1	Cell 2	Remark
T0	Cell-specific RS EPRE	dBm/15kHz	-85	-91	
	Qrxlevmin	dBm	-106	-106	Default value
	Qrxlevminoffset	dB	0	0	Default value
	Qhyst	dB	0	0	Default value
	Srxlev*	dB	21	15	Cell 1 is the strongest cell and camping on Cell 1 is guaranteed
T1	Cell-specific RS EPRE	dBm/15kHz	-85	-91	
	Srxlev*	dB	21	15	
T2	Cell-specific RS EPRE	dBm/15kHz	-85	-91	
	Srxlev*	dB	21	15	
T3	Cell-specific RS EPRE	dBm/15kHz	-91	-85	
	Srxlev*	dB	15	21	
Note: Srxlev is calculated in the UE					

Table 6.3.8.3.2-2: Time instances of cell power level and parameter changes for UTRA cell

	Parameter	Unit	Cell 5	Remark
T0	CPICH_Ec	dBm/3.84 MHz	OFF	Camping on Cell 1 is guaranteed
	PCCPCH RSCP	dBm/1.28 MHz	OFF	Camping on Cell 1 is guaranteed
	Qrxlevmin (FDD)	dBm	-79	
	Qrxlevmin (TDD)	dBm	-81	Default value
	Srxlev*	dB	N/A	
T1	CPICH_Ec	dBm/3.84 MHz	-60	Srxlev _{Cell 5} > 0, for FDD
	PCCPCH RSCP	dBm/1.28 MHz	-62	Srxlev _{Cell 5} > 0, for TDD
	Srxlev*	dB	19	
T2	CPICH_Ec	dBm/3.84 MHz	OFF	
	PCCPCH RSCP	dBm/1.28 MHz	OFF	
	Srxlev*	dB	N/A	
T3	CPICH_Ec	dBm/3.84 MHz	-60	Srxlev _{Cell 5} > 0, for FDD
	PCCPCH RSCP	dBm/1.28 MHz	-62	Srxlev _{Cell 5} > 0, for TDD
	Srxlev*	dB	19	

Note: Srxlev is calculated in the UE

Table 6.3.8.3.2-3: Main behaviour

St	Procedure	Message Sequence		TP	Verdict
		U - S	Message		
0	Wait for 6 s for UE to receive system information.	-	-	-	-
1	The SS change Cell 5 levels according to the row "T1" in table 6.3.8.3.2-2.	-	-	-	-
2	UE performs manual CSG ID selection and CSG Identity ('000 0000 0000 0000 0000 0000 0100'B) is selected manually and added in UE's Allowed CSG list.	-	-	-	-
3-12	Steps 1 to 10 of the generic test procedure described in TS 36.508 subclause 6.4.2.8 is performed on Cell 5. NOTE: The UE performs a RAU procedure and the RRC connection is released.	-	-	-	-
13	The SS changes Cell 5 levels according to the row "T2" in table 6.3.8.3.2-2.	-	-	-	-
14-21	Steps 1 to 8 of the generic procedure described in TS 36.508 Table 6.4.2.7A-1 are performed on Cell 1. NOTE: The UE performs a TAU procedure and the RRC connection is released.	-	-	-	-
21 A	Wait for 6 s for UE to receive system information.	-	-	-	-
22	The SS changes Cell 1, Cell 2 and Cell 5 levels according to the row "T3" in table 6.3.8.3.2-1 and table 6.3.8.3.2-2.	-	-	-	-
23-30	Check: Does the test result of steps 1 to 8 of generic test procedure in TS 36.508 subclause 6.4.2.8 indicate that the UE is camped on UTRAN Cell 5 in 6 mins from "T3" to the time RRC CONNECTION REQUEST received by SS? NOTE: The UE performs a RAU procedure.	-	-	1	-

6.3.8.3.3 Specific message contents

Table 6.3.8.3.3-1: Conditions for Tables 6.3.8.3.3-2, 6.3.8.3.3-3, 6.3.8.3.3-4, 6.3.8.3.3-5, 6.3.8.3.3-6 and 6.3.8.3.3-7

Condition	Explanation
Cell 1	This condition applies to system information transmitted on Cell 1.
Cell 2	This condition applies to system information transmitted on Cell 2.

Table 6.3.8.3.2-2: SystemInformationBlockType1 for Cell 1 and Cell 2 (preamble and all steps, Table 6.3.8.3.2-3)

Derivation Path: 36.508 table 4.4.3.2-3			
Information Element	Value/remark	Comment	Condition
SystemInformationBlockType1 ::= SEQUENCE {			
cellAccessRelatedInfo SEQUENCE {			
csg-Indication	TRUE		Cell 1
csg-Identity	'000 0000 0000 0000 0000 0000 0010'B		Cell 1
}			
cellSelectionInfo SEQUENCE {			
q-RxLevMin	-53 (-106 dBm)		Cell 1 Cell 2
}			
}			

Table 6.3.8.3.3-3: SystemInformationBlockType4 for Cell 1 (preamble and all steps, Table 6.3.8.3.2-3)

Derivation Path: 36.508 clause 4.4.3.3, Table 4.4.3.3-3			
Information Element	Value/remark	Comment	Condition
SystemInformationBlockType4 ::= SEQUENCE {			
csg-PhysCellIdRange ::= SEQUENCE {			
start	2		
range	Not present	The UE shall apply value 1 in case the field is absent, in which case only the physical cell identity value indicated by start applies.	
}			
}			

Table 6.3.8.3.3-4: SystemInformationBlockType6 for Cell 1 and Cell 2 (preamble and all steps, Table 6.3.8.3.2-3)

Derivation Path: 36.508 clause 4.4.3.3, Table 4.4.3.3-5			
Information Element	Value/remark	Comment	Condition
SystemInformationBlockType6 ::= SEQUENCE {			
carrierFreqListUTRA-FDD SEQUENCE (SIZE (1..maxUTRA-FDD-Carrier)) OF SEQUENCE {	1 entry	the first entry only	UTRA-FDD
cellReselectionPriority[1]	3	Lower priority than E-UTRA	
}			
carrierFreqListUTRA-TDD SEQUENCE (SIZE (1..maxUTRA-TDD-Carrier)) OF SEQUENCE {	1 entry	the first entry only	UTRA-TDD
cellReselectionPriority[1]	3	Lower priority than E-UTRA	
}			
}			

Condition	Explanation
UTRA-FDD	UTRA FDD cell environment
UTRA-TDD	UTRA TDD cell environment

Table 6.3.8.3.3-5: Master Information Block for Cell 5 (preamble and all steps, Table 6.3.8.3.2-3)

Derivation Path: 34.108 clause 6.1.0a.3			
Information Element	Value/remark	Comment	Condition
- CSG Indicator	TRUE		

Table 6.3.8.3.3-6: System Information Block type 3 for Cell 5 (preamble and all steps, Table 6.3.8.3.2-3)

Derivation Path: 34.108 clause 6.1.0b			
Information Element	Value/remark	Comment	Condition
- CSG Identity	'000 0000 0000 0000 0000 0000 0100'B		
- CSG PSC Split Information			
- Start PSC	104		
- Number of PSCs	5		
- PSC Range 2 Offset	Not present		

Table 6.3.8.3.3-7: System Information Block type 19 for Cell 5 (preamble and all steps, Table 6.3.8.3.2-3)

Derivation Path: 36.508 clause 4.4.4.1, Table 4.4.4.1-1			
Information Element	Value/remark	Comment	Condition
SysInfoType19 ::= SEQUENCE {			
utra-PriorityInfoList SEQUENCE {			
utra-ServingCell SEQUENCE {			
Priority	3	Lower priority than E-UTRA	
}			
utra-FrequencyAndPriorityInfoList SEQUENCE (SIZE (1..maxNumEUTRAFreqs)) OF SEQUENCE	1 entry	the first entry only	
priority[1]	4		
}			
}			

6.3.9 Manual CSG ID selection across PLMNs

6.3.9.1 Test Purpose (TP)

(1)

```
with { UE in E-UTRA RRC_IDLE state }
ensure that {
  when { a CSG cell not belonging to the Registered PLMN is manually selected }
  then { UE selects the requested CSG cell }
}
```

(2)

```
with { UE having selected a CSG cell not belonging to the initial Registered PLMN }
ensure that {
  when { the UE is no longer within coverage of the CSG cell }
  then { UE returns to the stored duplicate PLMN selection mode and selects a cell on the initial Registered PLMN }
}
```

6.3.9.2 Conformance requirements

References: The conformance requirements covered in the present TC are specified in: TS 23.122, clause 4.4.3.1.3.3.

[TS 23.122, clause 4.4.3.1.3.3]

If the user selects a CSG in a PLMN that is different from the RPLMN, then the following applies:

- i) The MS shall store a duplicate of the RPLMN and a duplicate of the current PLMN selection mode;
- ii) The MS shall enter into Manual mode of PLMN selection in state M4 (Trying PLMN) as defined in subclause 4.3.1.2;
- iii) The MS shall select the PLMN corresponding to the CSG and attempt to register on the selected CSG cell in the PLMN; and
- iv) If the registration fails or the MS is no longer in the coverage of the CSG, then the MS shall return to the stored duplicate PLMN selection mode and use the stored duplicate value of RPLMN for further action.

6.3.9.3 Test description

6.3.9.3.1 Pre-test conditions

System Simulator:

- Cell 1, Cell 3 and Cell 12.
- Cell 1 and Cell 12 are not CSG cells.
- Cell 3 is a CSG cell.
- System information combination 3 as defined in TS 36.508 [18] clause 4.4.3.1 is used in E-UTRA Cell 1 and Cell 12.
- System information combination 13 as defined in TS 36.508 [18] clause 4.4.3.1 is used in E-UTRA Cell 3.
- The PLMNs are identified in the test by the identifiers in Table 6.3.9.1.3.1-1.

Table 6.3.9.1.3.1-1: PLMN identifiers

Cell	PLMN name
1	PLMN1
3	PLMN2
12	PLMN2

UE:

- The UE's Allowed CSG list is empty.
- The UE's Operator CSG list is empty.

Preamble:

- The UE is in state Switched OFF (state 1) according to [18].

6.3.9.3.2 Test procedure sequence

Table 6.3.9.3.2-1 illustrates the downlink power levels and other changing parameters to be applied for the cells at various time instants of the test execution. Configurations marked "T0", "T1" and "T2" are applied at the points indicated in the Main behaviour description in Table 6.3.9.3.2-2.

Table 6.3.9.3.2-1: Time instances of cell power level and parameter changes

	Parameter	Unit	Cell 1	Cell 3	Cell 12	Remark
T0	Cell-specific RS EPRE	dBm/15k Hz	-65	Off	Off	The power levels are such that camping on Cell 1 is guaranteed.
	Srxlev*	dB	41	-	-	
T1	Cell-specific RS EPRE	dBm/15k Hz	-65	-85	Off	
	Srxlev*	dB	41	21	-	
T2	Cell-specific RS EPRE	dBm/15k Hz	-85	Off	-65	
	Srxlev*	dB	21	-	41	

Table 6.3.9.3.2-2: Main behaviour

St	Procedure	Message Sequence		TP	Verdict
		U - S	Message		
1	The UE is switched on.	-	-	-	-
2-17	Steps 2 to 17 of the registration procedure described in TS 36.508 subclause 4.5.2.3 are performed on Cell 1. NOTE: the UE performs registration and the RRC connection is released.	-	-	-	-
18	The SS changes Cell 3 level according to row "T1" in table 6.3.9.3.2-1.	-	-	-	-
19	The UE is made to perform manual CSG ID selection and select Cell 3.	-	-	-	-
20	Check: Does the test result of generic test procedure in TS 36.508 subclause 6.4.2.7 indicate that the UE is camped on Cell 3? NOTE: The UE performs a TAU procedure and the RRC connection is released.	-	-	1	-
21	The SS changes Cell 1, Cell 3 and Cell 12 levels according to row "T2" in table 6.3.9.3.2-1.	-	-	-	-
22-26	Check: Does the test result of Steps 1 to 5 of the generic test procedure in TS 36.508 subclause 6.4.2.7 indicate that the UE is camped on Cell 1? NOTE: The UE performs a TAU procedure.	-	-	2	-
-	At the end of this test procedure sequence, the UE is in end state E-UTRA connected (E2_T3440) according to TS 36.508.	-	-	-	-

6.3.9.3.3 Specific message contents

Table 6.3.9.3.3-1: Conditions for table 6.3.9.3.3-2

Condition	Explanation
Cell 1	This condition applies to system information transmitted on Cell 1.
Cell 3	This condition applies to system information transmitted on Cell 3.
Cell 12	This condition applies to system information transmitted on Cell 12.

Table 6.3.9.3.3-2: *SystemInformationBlockType1* for Cell 1, 3 and 12 (preamble and all steps, Table 6.3.9.3.2-2)

Derivation Path: 36.508 clause 4.4.3.2			
Information Element	Value/remark	Comment	Condition
<i>SystemInformationBlockType1</i> ::= SEQUENCE {			
<i>cellAccessRelatedInfo</i> SEQUENCE {			
<i>csg-Indication</i>	FALSE		Cell 1 Cell 12
	TRUE		Cell 3
<i>csg-Identity</i>	Not present		Cell 1 Cell 12
	'000 0000 0000 0000 0000 0000 0011'B		Cell 3
}			
}			

Table 6.3.9.3.3-3: SystemInformationBlockType4 for Cell 3 (Pre-test conditions and all steps, table 6.3.9.3.2-2)

Derivation Path: 36.508 clause 4.4.3.3, Table 4.4.3.3-3			
Information Element	Value/remark	Comment	Condition
SystemInformationBlockType4 ::= SEQUENCE {			
csg-PhysCellIdRange ::= SEQUENCE {			
start	3		
range	Not present	The UE shall apply value 1 in case the field is absent, in which case only the physical cell identity value indicated by start applies.	
}			
}			

6.3.10 Intra-Frequency cell selection / From E-UTRA_Idle to E-UTRA RRC_IDLE / CSG cell on same PLMN as previously visited CSG cell

6.3.10.1 Test Purpose (TP)

(1)

```
with { UE in E-UTRA IDLE state and UE's Allowed CSG list is not empty }
ensure that {
  when { UE detects strongest E-UTRAN CSG cell, previously not visited, on the same PLMN and on the
    same frequency as previously visited weaker CSG cell}
  then { UE selects to strongest previously not visited E-UTRAN CSG cell irrespective of stored
    CSG Cell}
}
```

6.3.10.2 Conformance requirements

References:

The conformance requirements covered in the present TC are specified in: TS 24.301, clause 5.5.3.2.4, TS 36.300 clause 10.1.1.1, TS 36.304 clauses 5.2.3.1, 5.2.3.2, 5.2.4.6, 5.2.4.8.2, 5.2.8, 5.5.1, TS 36.331 clause 6.3.1.

[TS 24.301, clause 5.5.3.2.4]

If the UE has initiated the tracking area updating procedure due to manual CSG selection and receives a TRACKING AREA UPDATE ACCEPT message, the UE shall check if the CSG ID of the cell where the UE has sent the TRACKING AREA UPDATE REQUEST message is contained in the Allowed CSG list. If not, the UE shall add that CSG ID to the Allowed CSG list.

[TS 36.300 Clause 10.1.1.1 "Cell Selection"]

The principles of PLMN selection in E-UTRA are based on the 3GPP PLMN selection principles. Cell selection is required on transition from EMM_DETACHED to EMM-REGISTERED and from ECM-IDLE or ECM-CONNECTED.

Cell selection:

- The UE NAS layer identifies a selected PLMN and equivalent PLMNs;
- The UE searches the E-UTRA frequency bands and for each carrier frequency identifies the strongest cell. It reads cell system information broadcast to identify its PLMN(s):
 - The UE may search each carrier in turn ("initial cell selection") or make use of stored information to shorten the search ("stored information cell selection").

[TS 36.304 Clause 5.2.3.1 "Cell Selection Process - Description"]

The UE shall use one of the following two cell selection procedures:

a) Initial Cell Selection

This procedure requires no prior knowledge of which RF channels are E-UTRA carriers. The UE shall scan all RF channels in the E-UTRA bands according to its capabilities to find a suitable cell. On each carrier frequency, the UE need only search for the strongest cell. Once a suitable cell is found this cell shall be selected.

b) Stored Information Cell Selection

This procedure requires stored information of carrier frequencies and optionally also information on cell parameters, from previously received measurement control information elements or from previously detected cells. Once the UE has found a suitable cell the UE shall select it. If no suitable cell is found the Initial Cell Selection procedure shall be started.

NOTE: Priorities between different frequencies or RATs provided to the UE by system information or dedicated signalling are not used in the cell selection process.

[TS 36.304 Clause 5.2.3.2 “Cell Selection Criterion”]

The cell selection criterion S is fulfilled when:

$$S_{rxlev} > 0 \text{ AND } S_{qual} > 0$$

where:

$$S_{rxlev} = Q_{rxlevmeas} - (Q_{rxlevmin} + Q_{rxlevminoffset}) - P_{compensation}$$

$$S_{qual} = Q_{qualmeas} - (Q_{qualmin} + Q_{qualminoffset})$$

where:

S_{rxlev}	Cell selection RX level value (dB)
S_{qual}	Cell selection quality value (dB)
$Q_{rxlevmeas}$	Measured cell RX level value (RSRP)
$Q_{qualmeas}$	Measured cell quality value (RSRQ)
$Q_{rxlevmin}$	Minimum required RX level in the cell (dBm)
$Q_{qualmin}$	Minimum required quality level in the cell (dB)
$Q_{rxlevminoffset}$	Offset to the signalled $Q_{rxlevmin}$ taken into account in the S_{rxlev} evaluation as a result of a periodic search for a higher priority PLMN while camped normally in a VPLMN [5]
$Q_{qualminoffset}$	Offset to the signalled $Q_{qualmin}$ taken into account in the S_{qual} evaluation as a result of a periodic search for a higher priority PLMN while camped normally in a VPLMN [5]
$P_{compensation}$	$\max(P_{EMAX} - P_{PowerClass}, 0)$ (dB)
P_{EMAX}	Maximum TX power level an UE may use when transmitting on the uplink in the cell (dBm) defined as P_{EMAX} in [TS 36.101]
$P_{PowerClass}$	Maximum RF output power of the UE (dBm) according to the UE power class as defined in [TS 36.101]

The signalled values $Q_{rxlevminoffset}$ and $Q_{qualminoffset}$ are only applied when a cell is evaluated for cell selection as a result of a periodic search for a higher priority PLMN while camped normally in a VPLMN [5]. During this periodic search for higher priority PLMN the UE may check the S criteria of a cell using parameter values stored from a different cell of this higher priority PLMN.

[TS 36.304 Clause 5.2.4.6 “Intra-frequency and equal priority inter-frequency Cell Reselection criteria”]

The cell-ranking criterion R_s for serving cell and R_n for neighbouring cells is defined by:

$$R_s = Q_{\text{meas},s} + Q_{\text{Hyst}}$$

$$R_n = Q_{\text{meas},n} - Q_{\text{offset}}$$

where:

Q_{meas}	RSRP measurement quantity used in cell reselections.
Q_{offset}	For intra-frequency: Equals to $Q_{\text{offset},s,n}$, if $Q_{\text{offset},s,n}$ is valid, otherwise this equals to zero. For inter-frequency: Equals to $Q_{\text{offset},s,n}$ plus $Q_{\text{offset},\text{frequency}}$, if $Q_{\text{offset},s,n}$ is valid, otherwise this equals to $Q_{\text{offset},\text{frequency}}$.

The UE shall perform ranking of all cells that fulfil the cell selection criterion S, which is defined in 5.2.3.2, but may exclude all CSG cells that are known by the UE to be not allowed.

The cells shall be ranked according to the R criteria specified above, deriving $Q_{\text{meas},n}$ and $Q_{\text{meas},s}$ and calculating the R values using averaged RSRP results.

If a cell is ranked as the best cell the UE shall perform cell reselection to that cell. If this cell is found to be not-suitable, the UE shall behave according to subclause 5.2.4.4.

In all cases, the UE shall reselect the new cell, only if the following conditions are met:

- the new cell is better ranked than the serving cell during a time interval $T_{\text{reselection,RAT}}$;
- more than 1 second has elapsed since the UE camped on the current serving cell.

[TS 36.304 Clause 5.2.4.8.2 “Cell reselection from a CSG cell”]

While camped on a suitable CSG cell, the UE shall apply the normal cell reselection rules as defined in subclause 5.2.4.

[TS 36.304 Clause 5.2.8 “Any Cell Selection state”]

In this state, the UE shall attempt to find an acceptable cell of any PLMN to camp on, trying all RATs that are supported by the UE and searching first for a high quality cell, as defined in subclause 5.1.2.2.

The UE, which is not camped on any cell, shall stay in this state until an acceptable cell is found.

[TS 36.304 Clause 5.5.1 “Support for manual CSG selection – E-UTRA case”]

In the UE on request of NAS, the AS shall scan all RF channels in the E-UTRA bands according to its capabilities to find available CSGs. On each carrier, the UE shall at least search for the strongest cell, read its system information and report available CSG ID(s) together with their “HNB name” (if broadcast) and PLMN(s) to the NAS. The search for available CSGs may be stopped on request of the NAS.

If NAS has selected a CSG and provided this selection to AS, the UE shall search for an acceptable or suitable cell belonging to the selected CSG to camp on.

[TS 36.331, Clause 6.3.1]

SystemInformationBlockType4

The IE *SystemInformationBlockType4* contains neighbouring cell related information relevant only for intra-frequency cell re-selection. The IE includes cells with specific re-selection parameters as well as blacklisted cells.

SystemInformationBlockType4 information element

```
-- ASN1START
SystemInformationBlockType4 ::= SEQUENCE {
    intraFreqNeighCellList      IntraFreqNeighCellList      OPTIONAL, -- Need OR
    intraFreqBlackCellList     IntraFreqBlackCellList     OPTIONAL, -- Need OR
    csg-PhysCellIdRange        PhysCellIdRange            OPTIONAL, -- Cond CSG
    . . .
    lateNonCriticalExtension    OCTET STRING                OPTIONAL  -- Need OP
}
```



```
IntraFreqNeighCellList ::= SEQUENCE (SIZE (1..maxCellIntra)) OF IntraFreqNeighCellInfo
IntraFreqNeighCellInfo ::= SEQUENCE {
    physCellId PhysCellId,
    q-OffsetCell Q-OffsetRange,
    ...
}
IntraFreqBlackCellList ::= SEQUENCE (SIZE (1..maxCellBlack)) OF PhysCellIdRange
-- ASN1STOP
```

SystemInformationBlockType4 field descriptions
<p>csg-PhysCellIdRange Set of physical cell identities reserved for CSG cells on the frequency on which this field was received. The received <i>csg-PhysCellIdRange</i> applies if less than 24 hours has elapsed since it was received and the UE is camped on a cell of the same primary PLMN where this field was received. The 3 hour validity restriction (section 5.2.1.3) does not apply to this field. The UE shall not apply any stored <i>csg-PhysCellIdRange</i> when it is in <i>any cell selection</i> state defined in TS 36.304 [4].</p>
<p>intraFreqBlackCellList List of blacklisted intra-frequency neighbouring cells.</p>
<p>intraFreqNeighbCellList List of intra-frequency neighbouring cells with specific cell re-selection parameters.</p>
<p>q-OffsetCell Parameter "Qoffset_{s,n}" in TS 36.304 [4].</p>

Conditional presence	Explanation
CSG	This field is optional, need OP, for non-CSG cells, and mandatory for CSG cells.

6.3.10.3 Test description

6.3.10.3.1 Pre-test conditions

System Simulator:

- Cell 1, Cell 2 and Cell 3 are E-UTRA cells.
- Cell 1 is not a CSG cell.
- Cell 2 and Cell 3 are CSG cells.
- System information combination 13 as defined in TS 36.508 [18] clause 4.4.3.1 is used in E-UTRA Cell 2 and Cell 3.
- System information combination 3 as defined in TS 36.508 [18] clause 4.4.3.1 is used in E-UTRA Cell 1.

UE:

- The UE's Allowed CSG list is empty.

Preamble:

- The UE is in state Switched OFF (state 1) according to [5].

6.3.10.3.2 Test procedure sequence

Table 6.3.10.3.2-1 illustrates the downlink power levels and other changing parameters to be applied for the cells at various time instants of the test execution. Row marked "T0" denotes the initial conditions, while rows marked "T1", "T2", and "T3" are to be applied subsequently. The exact instants at which these values shall be applied are described in the text in this clause.

Table 6.3.10.3.2-2 shows the test steps.

Table 6.3.10.3.2-1: Time instances of cell power level and parameter changes for E-UTRA cells

	Parameter	Unit	Cell 1	Cell 2	Cell 3	Remark
T0	Cell-specific RS EPRE	dBm/15kHz	-85	"Off"	"Off"	Power level "Off" is defined in TS36.508 Table 6.2.2.1-1.
	Qrxlevmin	dBm	N/A	-106	-106	
T1	Cell-specific RS EPRE	dBm/15kHz	-91	-85	"Off"	Power level "Off" is defined in TS36.508 Table 6.2.2.1-1.
	Srxlev*	dB	15	21	N/A	Srxlev = Cell-specific RS EPRE - qRxLevMinEUTRA
T2	Cell-specific RS EPRE	dBm/15kHz	-85	-91	"Off"	Power level "Off" is defined in TS36.508 Table 6.2.2.1-1.
	Srxlev*	dB	21	15	N/A	
T3	Cell-specific RS EPRE	dBm/15kHz	"Off"	-91	-85	Power level "Off" is defined in TS36.508 Table 6.2.2.1-1.
	Srxlev*	dB	N/A	15	21	

Note: Srxlev is calculated in the UE

Table 6.3.10.3.2-2: Main behaviour

Step	Procedure	Message Sequence		TP	Verdict
		U - S	Message		
1	The SS sets the Cell levels according to row "T0" in Table 6.3.10.3.2-1. The UE is switched on.	-	-	-	-
2-17	Steps 2 to 17 of the registration procedure described in TS 36.508 subclause 4.5.2.3 are performed on Cell 1. NOTE: The UE performs registration and the RRC connection is released.	-	-	-	-
18	The SS changes Cell 2 levels according to the row "T1" in Table 6.3.10.3.2-1.	-	-	-	-
19	The UE is made to perform manual CSG ID selection to Cell 2 (CSG Identity ('000 0000 0000 0000 0000 0000 0010'B)) and Cell 2 is added to the UE's Allowed CSG list.	-	-	-	-
20-25	UE performs Steps 1-6 of the generic test procedure in TS 36.508 Table 6.4.2.7-1 and camps on E-UTRAN Cell 2.	-	-	-	-
26	Wait for 6 s for UE to receive system information.	-	-	-	-
27	The SS changes Cell 1 and Cell 2 levels according to row "T2" in Table 6.3.10.3.2-1.	-	-	-	-
28-33	UE performs Steps 1-6 of the generic test procedure in TS 36.508 Table 6.4.2.7-1 and camps on E-UTRAN Cell 1.	-	-	-	-
34	The SS changes Cell 1, Cell 2 and Cell 3 levels according to row "T3" in table 6.3.10.3.2-1.	-	-	-	-
35	Check: Does the test result of generic test procedure in TS 36.508 Table 6.4.2.7-1 indicate that the UE is camped on E-UTRAN Cell 3?	-	-	1	-

6.3.10.3.3 Specific message contents

Table 6.3.10.3.3-1: SystemInformationBlockType1 for Cell 1, Cell 2 and Cell 3 (preamble and all steps, Table 6.3.10.3.2-2)

Derivation Path: 36.508 Table 4.4.3.2-3			
Information Element	Value/remark	Comment	Condition
SystemInformationBlockType1 ::= SEQUENCE {			
cellAccessRelatedInfo SEQUENCE {			
csg-Indication	FALSE		Cell 1
	TRUE		Cell 2
	TRUE		Cell 3
csg-Identity	Not present		Cell 1
	1		Cell 2
	1		Cell 3
}			
}			
}			
}			

6.3.11 Inter-RAT cell reselection / From UTRA_Idle to E-UTRA RRC_IDLE / CSG cell on same PLMN as previously visited CSG cell

6.3.11.1 Test Purpose (TP)

(1)

```

with { UE in UTRA IDLE state and UE's Allowed CSG list is not empty }
ensure that {
  when { UE detects strongest E-UTRAN CSG cell, previously not visited, on the same PLMN and the
same frequency as previously visited weaker E-UTRAN CSG cell}
  then { UE reselects to strongest previously not visited E-UTRAN CSG cell irrespective of stored
csg-PhysCellIdRange Information}
}

```

6.3.11.2 Conformance requirements

References: The conformance requirements covered in the present TC are specified in: TS 25.304, clause 5.6.1, 5.2.6.4.1, TS 36.304 clause 5.2.4.8.1, 5.2.4.6, 5.2.4.8.2, 5.2.4.1, TS 25.133, clause 4.2.2.11.2 and TS 36.331 section 6.3.1.

[TS 24.301, clause 5.5.3.2.4]

If the UE has initiated the tracking area updating procedure due to manual CSG selection and receives a TRACKING AREA UPDATE ACCEPT message, the UE shall check if the CSG ID of the cell where the UE has sent the TRACKING AREA UPDATE REQUEST message is contained in the Allowed CSG list. If not, the UE shall add that CSG ID to the Allowed CSG list.

[TS 25.304, clause 5.6.1]

In the UE on request of NAS, the AS shall scan all RF channels in the UTRA bands according to its capabilities to find available CSG IDs. On each carrier, the UE shall at least search for the strongest cell, read its system information and report available CSG ID(s) together with their "HNB name" (if broadcast) and PLMN(s) to the NAS. The search for available CSG IDs may be stopped on request of the NAS.

If NAS has selected a CSG ID and provided this selection to AS, the UE shall search for an acceptable or suitable cell belonging to the selected CSG ID to camp on.

[TS 25.304, clause 5.2.6.4.1]

In addition to normal cell reselection, the UE shall use an autonomous search function to detect at least previously visited allowed CSG cells on non-serving frequencies, including inter-RAT frequencies, according to the performance requirements specified in [10], when at least one CSG ID is included in the UE's CSG whitelist. The UE is required to perform autonomous search function in Idle, Cell_PCH and URA_PCH states. The UE shall disable the autonomous search function for CSG cells if the UE's CSG whitelist is empty. If "Dedicated CSG frequency(ies)" IE is present, the

UE may use the autonomous search function only on these dedicated frequencies and on the other frequencies listed in the system information.

NOTE: The UE autonomous search function, per UE implementation, determines when and/or where to search for allowed CSG cells.

When the UE has no or an empty CSG whitelist, the UE may ignore cells with PSC in the stored range "CSG PSC Split Information" [4] reserved for CSG cells for intra-frequency and inter-frequency measurements and cell re-selections.

...

If the UE detects a suitable CSG cell on a different frequency it shall reselect this cell irrespective of the cell reselection rules applicable for the cell the UE is currently camped on, if the detected suitable CSG cell is the strongest cell on that frequency. If suitable CSG cells are detected on different frequencies and these are the strongest cells on their frequencies, then the UE shall reselect to any one of them.

If the UE detects one or more suitable CSG cell on another RAT, the UE shall reselect to one of them according to [18].

[TS 25.133, clause 4.2.2.11.2]

The UE shall perform search and reselection to an allowed inter-RAT E-UTRA CSG cell that has met CSG reselection criterion defined in [1] and that is in its whitelist, within 6 minutes in the conditions shown in table 4.2.2.11.2-1. There is no need for statistical testing of this requirement.

Table 4.2.2.11.2-1: Parameters for CSG inter-RAT E-UTRA reselection

Parameter	Unit	Cell 1	Cell 2	
UARFCN ^{Note1}		Channel 1	N/A	
E-UARFCN ^{Note1}		N/A	Channel 2	
CSG indicator		False	True	
Primary scrambling code ^{Note1}		Scrambling code 1	N/A	
Physical cell identity ^{Note1}		N/A	2	
CSG identity		Not sent	Sent (Already stored in UE whitelist from previous visit)	
Propagation conditions		Static, non multipath		
CSG cell previously visited by UE		Yes		
CPICH_Ec ^{Note2}	dBm	[≥TBD]	N/A	
CPICH_Ec/lor	dB	-10		
PCCPCH_Ec/lor	dB	-12		
SCCPCH_Ec/lor	dB	-12		
AICH_Ec/lor	dB	-15		
SCH_Ec/lor	dB	-15		
PICH_Ec/lor	dB	-15		
I_{oc}	dBm/3.84 MHz	Off		
PBCH_RA	dB	N/A	0	
PBCH_RB	dB			
PSS_RA	dB			
SSS_RA	dB			
PCFICH_RB	dB			
PHICH_RA	dB			
PHICH_RB	dB			
PDCCH_RA	dB			
PDCCH_RB	dB			
PDSCH_RA	dB			
PDSCH_RB	dB			
OCNG_RA ^{Note 1}	dB			
OCNG_RB ^{Note 1}	dB			
Qrxlevmin	dBm			-140
N_{oc}	dBm/15 kHz			Off
RSRP ^{Note2}	dBm/15 KHz			[≥TBD]
<p>Note 1: For this requirement to be applicable, the UARFCN and scrambling code for cell 1 and the E-UARFCN and physical cell identity for cell 2 shall be unchanged from when the CSG cell was visited previously</p> <p>Note 2: Chosen to ensure that CSG autonomous search has a high probability of success on every attempt made by UE</p>				

[TS 36.304, clause 5.2.4.8.1]

In addition to normal cell reselection, the UE shall use an autonomous search function to detect at least previously visited allowed CSG cells on non-serving frequencies, including inter-RAT frequencies, according to the performance requirements specified in [10], when at least one CSG ID is included in the UE's CSG whitelist. The UE may also use autonomous search on the serving frequency. The UE shall disable the autonomous search function for CSG cells if the UE's CSG whitelist is empty.

NOTE: The UE autonomous search function, per UE implementation, determines when and/or where to search for allowed CSG cells.

If the UE detects one or more suitable CSG cells on different frequencies, then the UE shall reselect to one of the detected cells irrespective of the frequency priority of the cell the UE is currently camped on, if the concerned CSG cell is the highest ranked cell on that frequency.

If the UE detects a suitable CSG cell on the same frequency, it shall reselect to this cell as per normal reselection rules (5.2.4.6.).

[TS 36.304, clause 5.2.4.6]

The cell-ranking criterion R_s for serving cell and R_n for neighbouring cells is defined by:

$$R_s = Q_{\text{meas},s} + Q_{\text{Hyst}}$$

$$R_n = Q_{\text{meas},n} - Q_{\text{offset}}$$

where:

Q_{meas}	RSRP measurement quantity used in cell reselections.
Q_{offset}	For intra-frequency: Equals to $Q_{\text{offset},s,n}$, if $Q_{\text{offset},s,n}$ is valid, otherwise this equals to zero. For inter-frequency: Equals to $Q_{\text{offset},s,n}$ plus $Q_{\text{offset}_{\text{frequency}}}$, if $Q_{\text{offset},s,n}$ is valid, otherwise this equals to $Q_{\text{offset}_{\text{frequency}}}$.

The UE shall perform ranking of all cells that fulfil the cell selection criterion S , which is defined in 5.2.3.2, but may exclude all CSG cells that are known by the UE to be not allowed.

The cells shall be ranked according to the R criteria specified above, deriving $Q_{\text{meas},n}$ and $Q_{\text{meas},s}$ and calculating the R values using averaged RSRP results.

If a cell is ranked as the best cell the UE shall perform cell reselection to that cell. If this cell is found to be not-suitable, the UE shall behave according to subclause 5.2.4.4.

In all cases, the UE shall reselect the new cell, only if the following conditions are met:

- the new cell is better ranked than the serving cell during a time interval $T_{\text{reselection,RAT}}$;
- more than 1 second has elapsed since the UE camped on the current serving cell.

[TS 36.304, clause 5.2.4.8.2]

While camped on a suitable CSG cell, the UE shall apply the normal cell reselection rules as defined in subclause 5.2.4.

[TS 36.304, clause 5.2.4.1]

Absolute priorities of different E-UTRAN frequencies or inter-RAT frequencies may be provided to the UE in the system information, in the *RRConnectionRelease* message, or by inheriting from another RAT at inter-RAT cell (re)selection.

...

While the UE is camped on a suitable CSG cell, the UE shall always consider the current frequency to be the highest priority frequency (i.e. higher than the eight network configured values), irrespective of any other priority value allocated to this frequency.

[TS 36.331, clause 6.3.1]

SystemInformationBlockType4

The IE *SystemInformationBlockType4* contains neighbouring cell related information relevant only for intra-frequency cell re-selection. The IE includes cells with specific re-selection parameters as well as blacklisted cells.

SystemInformationBlockType4 information element

```
-- ASN1START
SystemInformationBlockType4 ::= SEQUENCE {
    intraFreqNeighCellList      IntraFreqNeighCellList      OPTIONAL, -- Need OR
    intraFreqBlackCellList      IntraFreqBlackCellList      OPTIONAL, -- Need OR
    csg-PhysCellIdRange         PhysCellIdRange             OPTIONAL, -- Cond CSG
    ...,
    lateNonCriticalExtension     OCTET STRING                 OPTIONAL  -- Need OP
}
-- ASN1END
```

```
IntraFreqNeighCellList ::= SEQUENCE (SIZE (1..maxCellIntra)) OF IntraFreqNeighCellInfo
IntraFreqNeighCellInfo ::= SEQUENCE {
    physCellId          PhysCellId,
    q-OffsetCell        Q-OffsetRange,
    ...
}
IntraFreqBlackCellList ::= SEQUENCE (SIZE (1..maxCellBlack)) OF PhysCellIdRange
-- ASN1STOP
```

SystemInformationBlockType4 field descriptions	
csg-PhysCellIdRange	Set of physical cell identities reserved for CSG cells on the frequency on which this field was received. The received <i>csg-PhysCellIdRange</i> applies if less than 24 hours has elapsed since it was received and the UE is camped on a cell of the same primary PLMN where this field was received. The 3 hour validity restriction (section 5.2.1.3) does not apply to this field. The UE shall not apply any stored <i>csg-PhysCellIdRange</i> when it is in <i>any cell selection</i> state defined in TS 36.304 [4].
intraFreqBlackCellList	List of blacklisted intra-frequency neighbouring cells.
intraFreqNeighbCellList	List of intra-frequency neighbouring cells with specific cell re-selection parameters.
q-OffsetCell	Parameter "Qoffset _{s,n} " in TS 36.304 [4].

Conditional presence	Explanation
CSG	This field is optional, need OP, for non-CSG cells, and mandatory for CSG cells.

6.3.11.3 Test description

6.3.11.3.1 Pre-test conditions

System Simulator:

- Cell 5 (non-CSG cell).
- Cell 1 and Cell 2 (CSG cell on same PLMN).
- System information combination 11 as defined in TS 36.508 [18] clause 4.4.3.1 is used in E-UTRA Cell 1 and 2.

UE:

- The UE's Allowed CSG list is empty.

Preamble:

- The UE is in state Switched OFF (state 1) according to [5].

6.3.11.3.2 Test procedure sequence

Tables 6.3.11.3.2-1 and 6.3.11.3.2-2 illustrates the downlink power levels and other changing parameters to be applied for the cells at various time instants of the test execution. Row marked "T0" denotes the initial conditions, while rows marked "T1", "T2", "T3" and "T4" are to be applied subsequently. The exact instants on which these values shall be applied are described in the texts in this clause.

Table 6.3.11.3.2-1: Time instances of cell power level and parameter changes

	Parameter	Unit	Cell 5	Cell 1	Cell 2	Remark
T0	Cell-specific RS EPRE	dBm/15kHz	-	-	-	
	CPICH_Ec	dBm/3.84 MHz	-60	"Off"	"Off"	
	PCCPCH RSCP	dBm/1.28 MHz	-62	"Off"	"Off"	
	Srxlev*	dB	-19	-	-	
T1	Cell-specific RS EPRE	dBm/15kHz	"Off"	-85	-	
	CPICH_Ec	dBm/3.84 MHz	-	-	"Off"	
	PCCPCH RSCP	dBm/1.28 MHz	-	-	"Off"	
	Srxlev*	dB	-	21	-	
T2	Cell-specific RS EPRE	dBm/15kHz	-	-	-	
	CPICH_Ec	dBm/3.84 MHz	-60	"Off"	"Off"	
	PCCPCH RSCP	dBm/1.28 MHz	-62	"Off"	"Off"	
	Srxlev*	dB	-19	-	-	
T3	Cell-specific RS EPRE	dBm/15kHz	"Off"	-91	-85	
	CPICH_Ec	dBm/3.84 MHz	-	-	-	
	PCCPCH RSCP	dBm/1.28 MHz	-	-	-	
	Srxlev*	dB	-	15	21	Both cells are suitable but Cell 2 is stronger

Note: Srxlev is calculated in the UE

Table 6.3.11.3.2-3: Main behaviour

St	Procedure	Message Sequence		TP	Verdict
		U - S	Message		
1	The UE is switched on.	-	-	-	-
2-13	Steps 2 to 13 of the registration procedure described in TS 34.108 subclause 7.2.2.3.3 are performed on Cell 5. NOTE: The UE performs registration and the RRC connection is released.	-	-	-	-
14	The SS changes Cell 5 and Cell 1 levels according to the row "T1" in table 6.3.11.3.2-1.	-	-	-	-
15	The UE is made to perform manual CSG ID ('000 0000 0000 0000 0000 0000 0001'B) selection to the Allowed CSG list.	-	-	-	-
16	The UE selects Cell 1.	-	-	-	-
17	Check: Does the test result of generic test procedure in TS 36.508 Table 6.4.2.7A-2 indicate that the UE is camped on E-UTRAN Cell 1?	-	-	-	-
18	Wait for 6 s for UE to receive system information.	-	-	-	-
19	The SS changes Cell 1, Cell 2, and Cell 5 levels according to row "T2" in table 6.3.11.3.2-1.	-	-	-	-
20-29	Steps 1 to 10 of the Routing Area Update procedure described in TS 36.508 subclause 6.4.2.8 are performed on Cell 5 NOTE: The UE performs RAU and the RRC connection is released.	-	-	-	-
30	The SS changes Cell 1, Cell 2 and Cell 5 level according to row "T3" in table 6.3.11.3.2-1.	-	-	-	-
31-37-46	Check: Does the test result of Steps 1 to 7 of generic test procedure in TS 36.508 Table 6.4.2.7A-1 indicate that the UE is camped on E-UTRAN Cell 2 within 6 mins from "T3" to the time <i>RRConnectionRequest</i> received by SS? NOTE: The UE performs a TAU procedure.	-	-	1	-

6.3.11.3.3 Specific message contents

Table 6.3.11.3.3-1: SystemInformationBlockType1 for Cell 1 and Cell 2

Derivation Path: 36.508 Table 4.4.3.2-3			
Information Element	Value/remark	Comment	Condition
SystemInformationBlockType1 ::= SEQUENCE {			
cellAccessRelatedInfo SEQUENCE {			
csg-Indication	TRUE		
csg-Identity	1		Cell 1
	1		Cell 2
}			
}			
}			

6.3.12 Inter-RAT cell selection / From E-UTRA RRC_IDLE to UTRA_Idle / CSG cell on same PLMN as previously visited CSG cell

6.3.12.1 Test Purpose (TP)

(1)

```

with { UE in E-UTRA RRC IDLE state and UE's Allowed CSG list is not empty }
ensure that {
  when { UE in "any cell selection" state detects a strongest UTRAN CSG cell, previously not
visited, on the same PLMN and the same frequency as the previously visited weaker CSG cell}
  then { UE selects the strongest previously not visited UTRAN CSG cell irrespective of stored CSG
PSC Split Information }
}

```

6.3.12.2 Conformance requirements

References: The conformance requirements covered in the present TC are specified in: TS 24.008 clause 4.7.5.1.3, TS 25.331 clause 8.6.2.4, TS 25.304 clauses 5.2.6.4.2, 5.2.8 and 5.6.1 and TS 36.304 clause 5.2.4.8.1.

[TS 24.008, clause 4.7.5.1.3]

If the MS has initiated the routing area updating procedure due to manual CSG selection and receives a ROUTING AREA UPDATE ACCEPT message, and the MS sent the ROUTING AREA UPDATE REQUEST message in a CSG cell, the MS shall check if the CSG ID and associated PLMN identity of the cell are contained in the Allowed CSG list. If not, the MS shall add that CSG ID and associated PLMN identity to the Allowed CSG list and the MS may add the HNB Name (if provided by lower layers) to the Allowed CSG list if the HNB Name is present in neither the Operator CSG list nor the Allowed CSG list.

[TS 25.331, clause 8.6.2.4]

The UE shall:

- 1> if the IE "CSG PSC Split Information" is included in a received message:
 - 2> consider the CSG PSC split information received on this cell to be valid for:
 - 3> the UARFCN of the carrier on which it was received;
 - 3> any cell not referenced in SIB18, or when SIB18 is not broadcast, while the cell the UE is camped on has a PLMN which is the same as the PLMN of the cell where the CSG PSC split information was received;
 - 3> any cell referenced in SIB18 that has the same PLMN as the PLMN of the cell in which the CSG PSC split information was received;
 - 3> while UE is not in Any Cell Selection state [4];
 - 3> 24 hours from the time it was received.

NOTE 1: If the IE "CSG PSC Split Information" is received in both SIB3 and SIB11bis in the same cell then UE behaviour is unspecified.

NOTE 2: The PLMN of a cell in the above paragraph is the PLMN in IE 'PLMN identity' of that cell.

NOTE 3: The 6 hour validity restriction (section 8.1.1.6) does not apply to this field.

[TS 25.304, clause 5.2.6.4.2]

While camped on a suitable CSG cell, the UE shall consider the frequency of the serving cell to be the highest priority frequency (i.e. higher than the eight network configured values or highest HCS priority) and shall not reselect to non-CSG cell as long as the serving cell remains the highest ranked cell on that frequency (This includes the case when the UE has only dedicated priorities for other frequencies but not for the current frequency, i.e. the UE does not consider the current frequency to be the lowest priority frequency according to rules in 5.2.6.1.2a and 5.2.6.1.4a). Cell reselection rules as defined in section 5.2.6.1 are applied for cell reselection from a CSG cell to non-CSG cell.

[TS 25.304, clause 5.2.8]

Any Cell Selection state

In this state, the UE shall attempt to find an acceptable cell of an any PLMN to camp on, trying all RATs that are supported by the UE and searching first for a high quality cell, as defined in subclause 5.1.2.2.

The UE, which is not camped on any cell, shall stay in this state until an acceptable cell is found.

[TS 25.304, clause 5.6.1]

In the UE on request of NAS, the AS shall scan all RF channels in the UTRA bands according to its capabilities to find available CSGs. On each carrier, the UE shall at least search for the strongest cell, read its system information and report available CSG ID(s) together with their "HNB name" (if broadcast) and PLMN(s) to the NAS. The search for available CSGs may be stopped on request of the NAS.

If NAS has selected a CSG and provided this selection to AS, the UE shall search for an acceptable or suitable cell belonging to the selected CSG to camp on.

[TS 36.304, clause 5.2.4.8.1]

In addition to normal cell reselection, the UE shall use an autonomous search function to detect at least previously visited allowed CSG cells on non-serving frequencies, including inter-RAT frequencies, according to the performance requirements specified in [10], when at least one CSG ID with associated PLMN identity is included in the UE's CSG whitelist. The UE may also use autonomous search on the serving frequency. The UE shall disable the autonomous search function for CSG cells if the UE's CSG whitelist is empty.

NOTE: The UE autonomous search function, per UE implementation, determines when and/or where to search for allowed CSG cells.

If the UE detects one or more suitable CSG cells on different frequencies, then the UE shall reselect to one of the detected cells irrespective of the frequency priority of the cell the UE is currently camped on, if the concerned CSG cell is the highest ranked cell on that frequency.

If the UE detects a suitable CSG cell on the same frequency, it shall reselect to this cell as per normal reselection rules (5.2.4.6.).

If the UE detects one or more suitable CSG cells on another RAT, the UE shall reselect to one of them according to [19].

6.3.12.3 Test description

6.3.12.3.1 Pre-test conditions

System Simulator:

- Cell 1 (non-CSG cell)
- Cell 5 and Cell 7 (CSG cells on the same PLMN)
- System information combination 4 as defined in TS 36.508 [18] clause 4.4.3.1 is used in E-UTRA Cell 1.

UE:

- The UE's Allowed CSG list is empty.

Preamble:

- The UE is in state Registered, Idle mode (State 2) according to [18] on Cell 1.

6.3.12.3.2 Test procedure sequence

Table 6.3.12.3.2-1 illustrates the downlink power levels and other changing parameters to be applied for the cells at various time instants of the test execution. Row marked "T0" denotes the initial conditions, while rows marked "T1", "T2", and "T3" are to be applied subsequently. The exact instants on which these values shall be applied are described in the texts in this clause.

Table 6.3.12.3.2-1: Time instances of cell power level and parameter changes

	Parameter	Unit	Cell 1	Cell 5	Cell 7	Remark
T0	Cell-specific RS EPRE	dBm/15kHz	-85	-	-	
	CPICH_Ec	dBm/3.84 MHz	-	"Off"	"Off"	
	PCCPCH RSCP	dBm/1.28 MHz	-	"Off"	"Off"	
	Qrxlevmin	dBm	-106	-	-	Default value
	Qrxlevminoffset	dB	0	-	-	Default value
	Qhyst	dB	0	-	-	Default value
	Qrxlevmin (FDD)	dBm	-	-79	-79	Default value
	Qrxlevmin (TDD)	dBm	-	-81	-81	Default value
Srxlev*	dB	21	-	-		
T1	Cell-specific RS EPRE	dBm/15kHz	"Off"	-	-	
	CPICH_Ec	dBm/3.84 MHz	-	-60	"Off"	
	PCCPCH RSCP	dBm/1.28 MHz	-	-62	"Off"	
	Srxlev*	dB	-	19	-	
T2	Cell-specific RS EPRE	dBm/15kHz	-85	-	-	
	CPICH_Ec	dBm/3.84 MHz	-	"Off"	"Off"	
	PCCPCH RSCP	dBm/1.28 MHz	-	"Off"	"Off"	
	Srxlev*	dB	21	-	-	
T3	Cell-specific RS EPRE	dBm/15kHz	"Off"	-	-	
	CPICH_Ec	dBm/3.84 MHz	-	-66	-60	
	PCCPCH RSCP	dBm/1.28 MHz	-	-68	-62	
	Srxlev*	dB	-	13	19	Both cells are suitable but Cell 7 is stronger

Note: Srxlev is calculated in the UE

Table 6.3.12.3.2-2: Main behaviour

St	Procedure	Message Sequence		TP	Verdict
		U - S	Message		
1	The SS changes cell levels according to the row "T1" in table 6.3.12.3.2-1.	-	-	-	-
2	UE performs manual CSG ID selection to Cell 5. CSG Identity ('000 0000 0000 0000 0000 0000 0010'B) is selected manually and added in UE's Allowed CSG list.	-	-	-	-
3-12	Steps 1 to 10 of the generic test procedure described in TS 36.508 subclause 6.4.2.8 are performed on UTRA CSG Cell 5. NOTE: The UE performs a RAU procedure and the RRC connection is released.	-	-	-	-
13	The SS changes cell levels according to the row "T2" in table 6.3.12.3.2-1.	-	-	-	-
14-21	Steps 1 to 8 of the procedure described in TS 36.508 Table 6.4.2.7A-1 is performed on Cell 1. NOTE: The UE performs a TAU procedure and the RRC connection is released.	-	-	-	-
22	The SS changes cell levels according to the row "T3" in table 6.3.12.3.2-1.	-	-	-	-
23	Check: Does the UE transmit a RRC CONNECTION REQUEST message on Cell 7 within 6 mins?	-	RRC CONNECTION REQUEST	1	P
24-30	Steps 2 to 8 of generic test procedure in TS 36.508 subclause 6.4.2.8 are performed on UTRAN CSG Cell 7. NOTE: The UE performs a RAU procedure.	-	-	1	-

6.3.12.3.3 Specific message contents

Table 6.3.12.3.3-1: Master Information Block for Cell 5 and Cell 7 (preamble and all steps, Table 6.3.12.3.2-2)

Derivation Path: 34.108 clause 6.1.0a.3			
Information Element	Value/remark	Comment	Condition
- CSG Indicator	TRUE		

Table 6.3.12.3.3-2: System Information Block type 3 for Cell 5 (preamble and all steps, Table 6.3.12.3.2-2)

Derivation Path: 34.108 clause 6.1.0b			
Information Element	Value/remark	Comment	Condition
- CSG Identity	'000 0000 0000 0000 0000 0000 0010'B		
- CSG PSC Split Information			
- Start PSC	Primary Scrambling Code of Cell 5		
- Number of PSCs	5		This shall not encompass the PSC of Cell 7
- PSC Range 2 Offset	Not present		

Table 6.3.12.3.3-3: System Information Block type 3 for Cell 7 (preamble and all steps, Table 6.3.12.3.2-2)

Derivation Path: 34.108 clause 6.1.0b			
Information Element	Value/remark	Comment	Condition
- CSG Identity	'000 0000 0000 0000 0000 0000 0010'B		

6.4 Hybrid cells

6.4.1 Manual CSG ID selection / Hybrid cell whose CSG ID is not in the Allowed CSG list nor Operator's list

6.4.1.1 Test Purpose (TP)

(1)

```
with { UE in E-UTRA RRC_IDLE state }
ensure that {
  when { a hybrid cell whose CSG ID is not included in the Allowed CSG list nor Operator CSG List is manually selected }
  then { UE selects the requested hybrid cell }
}
```

(2)

```
with { UE camping on a non-CSG cell in which the UE previously selected a hybrid cell manually whose CSG ID is not included in the Allowed CSG list nor Operator CSG List }
ensure that {
  when { the hybrid cell the UE previously selected is activated }
  then { UE does not reselect the hybrid cell against normal cell reselection criteria }
}
```

6.4.1.2 Conformance requirements

References: The conformance requirements covered in the present TC are specified in: TS 23.122, clause 4.4.3.1.3.1 and 4.4.3.1.3.2, TS 23.401, clause 5.3.3.2, TS 36.133, clause 4.2.2.10.1 and TS 36.304, clause 5.4.2.9.

[TS 23.122, clause 4.4.3.1.3.1]

The HPLMN may configure the MS whether to provide to the user CSGs for a certain PLMN without any restriction or to provide to the user only CSGs in the Operator CSG List for that PLMN. This configuration may be done either:

- in the USIM if the Operator CSG list is available in the USIM; or
- as described in 3GPP TS 24.285 [47].

In the absence of such configuration from the HPLMN for a certain PLMN, the MS shall by default provide to the user CSGs for that PLMN without any restriction.

For PLMNs where no restriction is configured, the MS provides to the user the CSGs that are available and the associated PLMNs using all access technologies which support CSGs (see 3GPP TS 23.003 [22A]) and which are supported by the MS. For each entry in the list, an indication is provided whether that CSG identity is in the Allowed CSG list or in the Operator CSG List stored in the MS for this PLMN.

For PLMNs where the MS is configured to provide to the user only CSGs in the Operator CSG List, the MS provides to the user the CSGs that are available and in the Operator CSG list, using all access technologies which support CSGs (see 3GPP TS 23.003 [22A]) and which are supported by the MS. For each entry in the list, the MS provides to the user the associated PLMN and an indication that the CSG identity is in the Operator CSG List stored in the MS for this PLMN.

Additional requirements for the display, including for the display of HNB name, can be found in 3GPP TS 22.220 [49].

The user may select a CSG from the indicated CSGs.

If the MS has a PDN connection for emergency bearer services, manual CSG selection shall not be performed.

[TS 23.122, clause 4.4.3.1.3.2]

If the user selects a CSG whose CSG identity is not included in the Allowed CSG list or Operator CSG list, then the MS shall attempt to register on a cell that corresponds to the CSG.

[TS 23.401, clause 5.3.3.2]

NOTE 7: If the UE receives a TAU Accept message via a hybrid cell, the UE does not add the corresponding CSG ID to its Allowed CSG list. Adding a CSG ID to the UE's local Allowed CSG list for a hybrid cell is performed only by OTA or OMA DM procedures.

[TS 36.133, clause 4.2.2.10.1]

The UE shall perform search and reselection to an allowed inter-frequency CSG cell that has met CSG reselection criterion defined in [1] and that is in its whitelist, within 6 minutes in the conditions shown in table 4.2.2.10.1-1. There is no need for statistical testing of this requirement.

Table 4.2.2.10.1-1: Parameters for CSG inter-frequency reselection

Parameter	Unit	Cell 1	Cell 2
E-UARFCN ^{Note1}		Channel 1	Channel 2
CSG indicator		False	True
Physical cell identity ^{Note1}		1	2
CSG identity		Not sent	Sent (Already stored in UE whitelist from previous visit)
Propagation conditions		Static, non multipath	
CSG cell previously visited by UE		Yes	
PBCH_RA	dB	0	0
PBCH_RB	dB		
PSS_RA	dB		
SSS_RA	dB		
PCFICH_RB	dB		
PHICH_RA	dB		
PHICH_RB	dB		
PDCCH_RA	dB		
PDCCH_RB	dB		
PDSCH_RA	dB		
PDSCH_RB	dB		
OCNG_RA ^{Note 1}	dB		
OCNG_RB ^{Note 1}	dB		
Qrxlevmin	dBm		
N_{oc}	dBm/15 kHz	Off	
RSRP ^{Note2}	dBm/15 KHz	[≥TBD]	[≥TBD]
Note 1: For this requirement to be applicable, the E-UARFCN and physical cell identity for cell 1 and cell 2 shall be unchanged from when the CSG cell was visited previously. Note 2: Chosen to ensure that CSG autonomous search has a high probability of success on every attempt made by UE.			

[TS 36.304, clause 5.2.4.9]

In addition to normal cell reselection rules, the UE shall use an autonomous search function to detect at least previously visited hybrid cells whose CSG IDs are in the UE's CSG whitelist according to the performance requirements specified in [10]. The UE shall treat detected hybrid cells as CSG cells if the CSG ID of the hybrid cell is in the UE's CSG whitelist and as normal cells otherwise.

6.4.1.3 Test description

6.4.1.3.1 Pre-test conditions

System Simulator:

- Cell 1 and Cell 3 are E-UTRAN cells and have different tracking areas according to table 6.0.1-2.
- Cell 1 is a non-CSG cell.
- Cell 3 is a hybrid cell.
- System information combination 3 as defined in TS 36.508 [18] clause 4.4.3.1 is used in E-UTRA Cell 1.
- System information combination 13 as defined in TS 36.508 [18] clause 4.4.3.1 is used in E-UTRA Cell 3.

UE:

- the UE's Allowed CSG list is empty.
- the UE's Operator CSG list is empty

Preamble:

- The UE is in state Registered, Idle mode (state 2) on Cell 1 according to [18].

6.4.1.3.2 Test procedure sequence

Table 6.4.1.3.2-1 illustrates the downlink power levels and other changing parameters to be applied for the cells at various time instants of the test execution. The configurations marked "T1" and "T2" are applied at the points indicated in the Main behaviour description in Table 6.4.1.3.2-2.

Table 6.4.1.3.2-1: Time instances of cell power level and parameter changes

	Parameter	Unit	Cell 1	Cell 3	Remark
T1	Cell-specific RS EPRE	dBm/15kHz	-97	-85	The power level values are assigned so that the UE can detect Cell 3.
T2	Cell-specific RS EPRE	dBm/15kHz	-85	"Off"	The power level values are assigned so that camping on Cell 1 is guaranteed.

Table 6.4.1.3.2-2: Main behaviour

St	Procedure	Message Sequence		TP	Verdict
		U - S	Message		
1	The SS changes Cell 1 and Cell 3 levels according to row "T1" in Table 6.4.1.3.2-1.	-	-	-	-
2	The UE is made to perform manual CSG ID selection and select Cell 3.	-	-	-	-
3	Check: Does the test result of generic test procedure in TS 36.508 subclause 6.4.2.7 indicate that the UE is camped on Cell 3? NOTE: The UE performs a TAU procedure and the RRC connection is released.	-	-	1	-
4	The SS changes Cell 1 and Cell 3 levels according to row "T2" in Table 6.4.1.3.2-1.	-	-	-	-
5	The generic test procedure in TS 36.508 subclause 6.4.2.7 is performed on Cell 1. NOTE: The UE performs a TAU procedure and the RRC connection is released.	-	-	-	-
6	The SS changes Cell 1 and Cell 3 levels according to row "T1" in Table 6.4.1.3.2-1.	-	-	-	-
7	Check: Does the UE transmit an <i>RRCCONNECTIONREQUEST</i> message on Cell 3 within 6 minutes?	-->	<i>RRCCONNECTIONREQUEST</i>	2	F
8	Check: Does the test result of generic test procedure in TS 36.508 subclause 6.4.2.2 indicate that the UE is in E-UTRA RRC_IDLE state on Cell 1?	-	-	2	-

6.4.1.3.3 Specific message contents

Table 6.4.1.3.3-1: *SystemInformationBlockType5* for Cell 1 (preamble and all steps, Table 6.4.1.3.2-2)

Derivation Path: 36.508, Table 4.4.3.3-4			
Information Element	Value/remark	Comment	Condition
<i>SystemInformationBlockType5</i> ::= SEQUENCE {			
interFreqCarrierFreqList SEQUENCE (SIZE (1..maxFreq)) OF SEQUENCE {			
dl-CarrierFreq[n]	EARFCN of Cell 3		
cellReselectionPriority[n]	3	lower priority than the frequency for Cell 1	
}			
}			

Table 6.4.1.3.3-2: *SystemInformationBlockType1* for Cell 3 (preamble and all steps, Table 6.4.1.3.2-2)

Derivation Path: 36.508, Table 4.4.3.2-3			
Information Element	Value/remark	Comment	Condition
<i>SystemInformationBlockType1</i> ::= SEQUENCE {			
cellAccessRelatedInfo SEQUENCE {			
csg-Identity	'000 0000 0000 0000 0000 0000 0011'B		
}			
}			

Table 6.4.1.3.3-3: SystemInformationBlockType3 for Cell 3 (preamble and all steps, Table 6.4.1.3.2-2)

Derivation Path: 36.508, Table 4.4.3.3-2			
Information Element	Value/remark	Comment	Condition
SystemInformationBlockType3 ::= SEQUENCE {			
cellReselectionServingFreqInfo SEQUENCE {			
cellReselectionPriority	3	lower priority than the frequency for Cell 1	
}			
}			

Table 6.4.1.3.3-4: SystemInformationBlockType5 for Cell 3 (preamble and all steps, Table 6.4.1.3.2-2)

Derivation Path: 36.508, Table 4.4.3.3-4			
Information Element	Value/remark	Comment	Condition
SystemInformationBlockType5 ::= SEQUENCE {			
interFreqCarrierFreqList SEQUENCE (SIZE (1..maxFreq)) OF SEQUENCE {			
dl-CarrierFreq[n]	EARFCN of Cell 1		
threshX-High[n]	10	20 dB	
}			
}			

Table 6.4.1.3.3-5: SystemInformationBlockType4 for Cell 3 (preamble and all steps, Table 6.4.1.3.2-2)

Derivation Path: 36.508, Table 4.4.3.3-3			
Information Element	Value/remark	Comment	Condition
SystemInformationBlockType4 ::= SEQUENCE {			
csg-PhysCellIdRange SEQUENCE {			
start	4		
range	Not present	The UE shall apply value 1 in case the field is absent, in which case only the physical cell identity value indicated by start applies.	
}			
}			

6.4.2 Inter-frequency cell reselection / From E-UTRA RRC_IDLE non-CSG cell to E-UTRA RRC_IDLE member hybrid cell

6.4.2.1 Test Purpose (TP)

(1)

```
with { UE in E-UTRA RRC_IDLE state }
ensure that {
  when { Manual CSG ID selection is requested }
  then { UE selects the requested hybrid cell }
}
```

(2)

```
with { UE in E-UTRA RRC_IDLE state on a non-CSG cell and UE's Allowed CSG list is not empty }
ensure that {
  when { a previously visited E-UTRA member hybrid cell becomes the strongest cell on its frequency }
  then { UE reselects the E-UTRA member hybrid cell }
}
```

6.4.2.2 Conformance requirements

References: The conformance requirements covered in the present TC are specified in: TS 36.304, clauses 5.2.4.9 and 5.2.4.8.1, and 36.133, clauses 4.2.2.10 and 4.2.2.10.1.

[TS 36.304, clause 5.2.4.9]

In addition to normal cell reselection rules, the UE shall use an autonomous search function to detect at least previously visited hybrid cells whose CSG IDs are in the UE's CSG whitelist according to the performance requirements specified in [10]. The UE shall treat detected hybrid cells as CSG cells if the CSG ID of the hybrid cell is in the UE's CSG whitelist and as normal cells otherwise.

[TS 36.304, clause 5.2.4.8.1]

In addition to normal cell reselection, the UE shall use an autonomous search function to detect at least previously visited allowed CSG cells on non-serving frequencies, including inter-RAT frequencies, according to the performance requirements specified in [10], when at least one CSG ID is included in the UE's CSG whitelist. The UE may also use autonomous search on the serving frequency. The UE shall disable the autonomous search function for CSG cells if the UE's CSG whitelist is empty.

NOTE: The UE autonomous search function, per UE implementation, determines when and/or where to search for allowed CSG cells.

If the UE detects one or more suitable CSG cells on different frequencies, then the UE shall reselect to one of the detected cells irrespective of the frequency priority of the cell the UE is currently camped on, if the concerned CSG cell is the highest ranked cell on that frequency.

[TS 36.133, clause 4.2.2.10]

Reselection from non CSG to CSG cells may be performed using UE autonomous search as defined in [1] when at least one CSG ID is included in the UE's CSG whitelist. The requirements in this section are valid for reselection to CSG cells previously visited by the UE when the radio configuration parameters, including the carrier frequency and physical cell identity of the CSG cell, non CSG cell and other neighbour cells are unchanged from the most recent previous visit.

[TS 36.133, clause 4.2.2.10.1]

The UE shall perform search and reselection to an allowed inter-frequency CSG cell that has met reselection criterion defined in [1] and that is in its whitelist, within [6] minutes in the conditions shown in table 4.2.2.10.1-1. There is no need for statistical testing of this requirement.

Table 4.2.2.10.1-1: Parameters for CSG inter-frequency reselection

Parameter	Unit	Cell 1	Cell 2
E-UARFCN ^{Note1}		Channel 1	Channel 2
CSG indicator		False	True
Physical cell identity ^{Note1}		1	2
CSG identity		Not sent	Already stored in UE whitelist from previous visit
Propagation conditions		Static, non multipath	
CSG cell previously visited by UE		Yes	
PBCH_RA	dB	0	0
PBCH_RB	dB		
PSS_RA	dB		
SSS_RA	dB		
PCFICH_RB	dB		

PHICH_RA	dB		
PHICH_RB	dB		
PDCCH_RA	dB		
PDCCH_RB	dB		
PDSCH_RA	dB		
PDSCH_RB	dB		
OCNG_RA ^{Note 1}	dB		
OCNG_RB ^{Note 1}	dB		
Qrxlevmin	dBm	-140	-140
N_{oc}	dBm/15 kHz	Off	
RSRP ^{Note 2}	dBm/15 KHz	[≥TBD]	[≥TBD]
<p>Note 1: For this requirement to be applicable, the E-UARFCN and physical cell identity for cell 1 and cell 2 shall be unchanged from when the CSG cell was visited previously</p> <p>Note 2: Chosen to ensure that CSG autonomous search has a high probability of success on every attempt made by UE</p>			

6.4.2.3 Test description

6.4.2.3.1 Pre-test conditions

System Simulator:

- Cell 1, Cell 3, Cell 11 and Cell 23.
- Cell 1, Cell 11 and Cell 23 are not CSG cells.
- Cell 3 is a hybrid cell.
- System information combination 3 as defined in TS 36.508 [18] clause 4.4.3.1 is used in E-UTRA Cell 1, Cell 11 and Cell 23.
- System information combination 13 as defined in TS 36.508 [18] clause 4.4.3.1 is used in E-UTRA Cell 3.
- Cell 1, Cell 3, Cell 11 and Cell 23 have different tracking areas according to table 6.0.1-2.

UE:

- The UE's Allowed CSG list contains the CSG ID of Cell 3.

Preamble:

- The UE is in state Switched OFF (state 1) according to [18].

6.4.2.3.2 Test procedure sequence

Table 6.4.2.3.2-1 illustrates the downlink power levels and other changing parameters to be applied for the cells at various time instants of the test execution. Configurations marked "T0", "T1", "T2", "T3" and "T4" are applied at the points indicated in the Main behaviour description in Table 6.4.2.3.2-2.

Table 6.4.2.3.2-1: Time instances of cell power level and parameter changes

	Parameter	Unit	Cell 1	Cell 3	Cell 11	Cell 23	Remark
T0	Cell-specific RS EPRE	dBm/15k Hz	-65	Off	Off	Off	The power levels are such that camping on Cell 1 is guaranteed.
	Srxlev*	dB	41	-	-	-	
T1	Cell-specific RS EPRE	dBm/15k Hz	-65	-85	Off	-91	
	Srxlev*	dB	41	21	-	15	
T2	Cell-specific RS EPRE	dBm/15k Hz	Off	Off	-65	Off	The power levels are such that camping on Cell 11 is guaranteed.
	Srxlev*	dB	-	-	41	-	
T3	Cell-specific RS EPRE	dBm/15k Hz	-65	Off	-91	-85	
	Srxlev*	dB	41	-	15	21	
T4	Cell-specific RS EPRE	dBm/15k Hz	-65	-85	Off	-91	
	Srxlev*	dB	41	21	-	15	

Table 6.4.2.3.2-2: Main behaviour

St	Procedure	Message Sequence		TP	Verdict
		U - S	Message		
1	The UE is switched on.	-	-	-	-
2-17	Steps 2 to 17 of the registration procedure described in TS 36.508 subclause 4.5.2.3 are performed on Cell 1. NOTE: the UE performs registration and the RRC connection is released.	-	-	-	-
18	The SS changes Cell 3 and Cell 23 levels according to row "T1" in table 6.4.2.3.2-1.	-	-	-	-
19	The UE is made to perform manual CSG ID selection and select Cell 3.	-	-	-	-
20	Check: Does the test result of generic test procedure in TS 36.508 subclause 6.4.2.7 indicate that the UE is camped on Cell 3? NOTE: The UE performs a TAU procedure and the RRC connection is released.	-	-	1	-
21	The SS changes Cell1, Cell 3, Cell 11 and Cell 23 levels according to row "T2" in table 6.4.2.3.2-1.	-	-	-	-
22-27	Steps 1 to 6 of the TAU procedure described in TS 36.508 subclause 6.4.2.7 are performed on Cell 11. NOTE: the UE performs a TAU and the RRC connection is released.	-	-	-	-
28	The SS changes Cell 1, Cell 11 and Cell 23 levels according to row "T3" in table 6.4.2.3.2-1.	-	-	-	-
29-34	Steps 1 to 6 of the TAU procedure described in TS 36.508 subclause 6.4.2.7 are performed on Cell 1. NOTE: the UE performs a TAU and the RRC connection is released.	-	-	-	-
35	The SS changes Cell 3, Cell 11 and Cell 23 levels according to row "T4" in table 6.4.2.3.2-1.	-	-	-	-
36-40	Check: Does the test result of Steps 1 to 5 of the generic test procedure in TS 36.508 subclause 6.4.2.7 indicate that the UE is camped on Cell 3 within [6] min from T4 to the time the <i>RRCConnectionRequest</i> is received by the SS? NOTE: The UE performs a TAU procedure.	-	-	2	-
-	At the end of this test procedure sequence, the UE is in end state E-UTRA connected (E2_T3440) according to TS 36.508.	-	-	-	-

6.4.2.3.3

Specific message contents

Table 6.4.2.3.3-1: Conditions for table 6.4.2.3.3-2

Condition	Explanation
Cell 1	This condition applies to system information transmitted on Cell 1.
Cell 3	This condition applies to system information transmitted on Cell 3.
Cell 11	This condition applies to system information transmitted on Cell 11.
Cell 23	This condition applies to system information transmitted on Cell 23.

Table 6.4.2.3.3-2: SystemInformationBlockType1 for Cell 1, 3, 11 and 23 (preamble and all steps, Table 6.4.2.3.2-2)

Derivation Path: 36.508 clause 4.4.3.2			
Information Element	Value/remark	Comment	Condition
SystemInformationBlockType1 ::= SEQUENCE {			
cellAccessRelatedInfo SEQUENCE {			
csg-Indication	FALSE		
csg-Identity	Not present		Cell 1 Cell 11 Cell 23
}	'000 0000 0000 0000 0000 0000 0011'B		Cell 3
}			
}			

Table 6.4.2.3.3-3: SystemInformationBlockType4 for Cell 3 (Pre-test conditions and all steps, table 6.4.2.3.2-2)

Derivation Path: 36.508 clause 4.4.3.3, Table 4.4.3.3-3			
Information Element	Value/remark	Comment	Condition
SystemInformationBlockType4 ::= SEQUENCE {			
csg-PhysCellIdRange ::= SEQUENCE {			
start	5		
range	Not present	The UE shall apply value 1 in case the field is absent, in which case only the physical cell identity value indicated by start applies.	
}			
}			

6.4.3 Inter-RAT cell reselection / From E-UTRA RRC_IDLE non-CSG cell to UTRA_Idle member hybrid cell

6.4.3.1 Test Purpose (TP)

(1)

```
with { UE in E-UTRA RRC_IDLE state on a non-CSG cell and UE's Allowed CSG list is not empty }
ensure that {
  when { a previously visited UTRA member hybrid cell becomes the strongest cell on its frequency }
  then { UE reselects the suitable UTRA member hybrid cell irrespective of its lower priority than EUTRA cell }
}
```

6.4.3.2 Conformance requirements

References: The conformance requirements covered in the present TC are specified in: TS 25.304, clause 5.6.1; TS 36.304, clauses 5.2.4.8.1 and 5.2.4.9; and TS 36.133, clauses 4.2.2.10 and 4.2.2.10.2.

[TS 25.304, clause 5.6.1]

In the UE on request of NAS, the AS shall scan all RF channels in the UTRA bands according to its capabilities to find available CSG IDs. On each carrier, the UE shall at least search for the strongest cell, read its system information and report available CSG ID(s) together with their "HNB name" (if broadcast) and PLMN(s) to the NAS. The search for available CSG IDs may be stopped on request of the NAS.

If NAS has selected a CSG ID and provided this selection to AS, the UE shall search for an acceptable or suitable cell belonging to the selected CSG ID to camp on.

[TS 36.304, clause 5.2.4.8.1]

In addition to normal cell reselection, the UE shall use an autonomous search function to detect at least previously visited allowed CSG cells on non-serving frequencies, including inter-RAT frequencies, according to the performance requirements specified in [10], when at least one CSG ID is included in the UE's CSG whitelist. The UE may also use autonomous search on the serving frequency. The UE shall disable the autonomous search function for CSG cells if the UE's CSG whitelist is empty.

NOTE: The UE autonomous search function, per UE implementation, determines when and/or where to search for allowed CSG cells.

If the UE detects one or more suitable CSG cells on different frequencies, then the UE shall reselect to one of the detected cells irrespective of the frequency priority of the cell the UE is currently camped on, if the concerned CSG cell is the highest ranked cell on that frequency.

[TS 36.304, clause 5.2.4.9]

In addition to normal cell reselection rules, the UE shall use an autonomous search function to detect at least previously visited hybrid cells whose CSG IDs are in the UE's CSG whitelist according to the performance requirements specified in [10]. The UE shall treat detected hybrid cells as CSG cells if the CSG ID of the hybrid cell is in the UE's CSG whitelist and as normal cells otherwise.

[TS 36.133, clause 4.2.2.10]

Reselection from non CSG to CSG cells may be performed using UE autonomous search as defined in [1] when at least one CSG ID is included in the UE's CSG whitelist. The requirements in this section are valid for reselection to CSG cells previously visited by the UE when the radio configuration parameters, including the carrier frequency and physical cell identity of the CSG cell, non CSG cell and other neighbour cells are unchanged from the most recent previous visit.

[TS 36.133, clause 4.2.2.10.2]

The UE shall perform search and reselection to an allowed inter-RAT UTRAN FDD CSG cell that has met CSG reselection criterion defined in [1] and that is in its whitelist, within 6 minutes in the conditions shown in table 4.2.2.10.2-1. There is no need for statistical testing of this requirement.

Table 4.2.2.10.2-1: Parameters for CSG inter-RAT UTRAN FDD reselection

Parameter	Unit	Cell 1	Cell 2
E-UARFCN ^{Note1}		Channel 1	N/A
UARFCN ^{Note1}		N/A	Channel 2
CSG indicator		False	True
Physical cell identity ^{Note1}		1	N/A
Primary scrambling code ^{Note1}		N/A	Scrambling code 2
CSG identity		Not sent	Sent (Already stored in UE whitelist from previous visit)
Propagation conditions		Static, non multipath	
CSG cell previously visited by UE		Yes	
PBCH_RA	dB	0	N/A
PBCH_RB	dB		
PSS_RA	dB		
SSS_RA	dB		
PCFICH_RB	dB		
PHICH_RA	dB		
PHICH_RB	dB		
PDCCH_RA	dB		
PDCCH_RB	dB		
PDSCH_RA	dB		
PDSCH_RB	dB		
OCNG_RA ^{Note 1}	dB		
OCNG_RB ^{Note 1}	dB		
Qrxlevmin	dBm		
N_{oc}	dBm/15 kHz	Off	
RSRP ^{Note2}	dBm/15 KHz	[≥TBD]	
CPICH_Ec ^{Note2}	dBm		[≥TBD]
CPICH_Ec/lor	dB		-10
PCCPCH_Ec/lor	dB		-12
SCCPCH_Ec/lor	dB		-12
AICH_Ec/lor	dB		-15
SCH_Ec/lor	dB		-15
PICH_Ec/lor	dB		-15
I_{oc}	dBm/3.84 MHz		Off
Note 1:	For this requirement to be applicable, the E-UARFCN and physical cell identity for cell 1 and the UARFCN and scrambling code for cell 2 shall be unchanged from when the CSG cell was visited previously.		
Note 2:	Chosen to ensure that CSG autonomous search has a high probability of success on every attempt made by the UE.		

6.4.3.3 Test description

6.4.3.3.1 Pre-test conditions

System Simulator:

- Cell 1 and Cell 2 are E-UTRAN cells and have different tracking areas according to table 6.0.1-2.
- Cell 5 and Cell 7 are UTRAN cells
- Cell 1, Cell 2 and Cell 7 are not CSG cells.
- Cell 5 is a hybrid cell.
- System information combination 4 as defined in TS 36.508 [18] clause 4.4.3.1 is used in E-UTRA cells.

UE:

- The UE's Allowed CSG list contains the CSG ID of Cell 5.

Preamble:

- The UE is in state Registered, Idle Mode (state 2) according to [18] in Cell 1.

6.4.3.3.2 Test procedure sequence

Table 6.4.3.3.2-1 & 6.4.3.3.2-2 illustrates the downlink power levels and other changing parameters to be applied for the cells at various time instants of the test execution. Configurations marked "T0", "T1", "T2", "T3" and "T4" are applied at the points indicated in the Main behaviour description in Table 6.4.3.3.2-3.

Table 6.4.3.3.2-1: Time instances of cell power level and parameter changes for E-UTRA Cell 1 and Cell 2

	Parameter	Unit	Cell 1	Cell 2	Remark
T0	Cell-specific RS EPRE	dBm/15kHz	-85	OFF	
	Qrxlevmin	dBm	-106	-106	Default value
	Qrxlevminoffset	dB	0	0	Default value
	Qhyst	dB	0	0	Default value
	Srxlev*	dB	21	N/A	Cell 1 is the strongest cell
T1	Cell-specific RS EPRE	dBm/15kHz	-85	OFF	
	Srxlev*	dB	21	N/A	
T2	Cell-specific RS EPRE	dBm/15kHz	OFF	-85	
	Srxlev*	dB	N/A	21	
T3	Cell-specific RS EPRE	dBm/15kHz	-85	-91	
	Srxlev*	dB	21	15	
T4	Cell-specific RS EPRE	dBm/15kHz	-85	OFF	
	Srxlev*	dB	21	N/A	

Note: Srxlev is calculated in the UE

Table 6.4.3.3.2-2: Time instances of cell power level and parameter changes for UTRA Cell 5 and Cell 7

	Parameter	Unit	Cell 5	Cell 7	Remark
T0	CPICH_Ec	dBm/3.84 MHz	OFF	OFF	Camping on Cell 1 is guaranteed
	PCCPCH RSCP	dBm/1.28 MHz	OFF	OFF	Camping on Cell 1 is guaranteed
	Qrxlevmin (FDD)	dBm	-79	-79	Default value
	Qrxlevmin (TDD)	dBm	-81	-81	Default value
	Srxlev*	dB	N/A	N/A	
T1	CPICH_Ec	dBm/3.84 MHz	-60	-64	$Srxlev_{Cell\ 5} > 0$, for FDD
	PCCPCH RSCP	dBm/1.28 MHz	-62	-66	$Srxlev_{Cell\ 5} > 0$, for TDD
	Srxlev*	dB	19	15	Cell 5 becomes the suitable cell
T2	CPICH_Ec	dBm/3.84 MHz	OFF	OFF	
	PCCPCH RSCP	dBm/1.28 MHz	OFF	OFF	
	Srxlev*	dB	N/A	N/A	
T3	CPICH_Ec	dBm/3.84 MHz	OFF	-64	
	PCCPCH RSCP	dBm/1.28 MHz	OFF	-66	
	Srxlev*	dB	N/A	15	
T4	CPICH_Ec	dBm/3.84 MHz	-60	-64	$Srxlev_{Cell\ 5} > 0$, for FDD
	PCCPCH RSCP	dBm/1.28 MHz	-62	-66	$Srxlev_{Cell\ 5} > 0$, for TDD
	Srxlev*	dB	19	15	Cell 5 becomes the suitable cell

Note: Srxlev is calculated in the UE

Table 6.4.3.3-2-3: Main behaviour

St	Procedure	Message Sequence		TP	Verdict
		U - S	Message		
1	The SS changes Cell 5 and Cell 7 levels according to the row "T1" in table 6.4.3.3.2-2.	-	-	-	-
2	UE performs manual CSG ID selection and select Cell 5.	-	-	-	-
3-12	Steps 1 to 10 of the generic test procedure described in TS 36.508 subclause 6.4.2.8 are performed on Cell 5. NOTE: The UE performs a RAU procedure and the RRC connection is released.	-	-	-	-
13	The SS changes Cell 1, Cell 2, Cell 5 and Cell 7 levels according to the row "T2" in table 6.4.3.3.2-1 and table 6.4.3.3.2-2.	-	-	-	-
14-21	Steps 1 to 8 of the procedure described in TS 36.508 Table 6.4.2.7A-1 is performed on Cell 2. NOTE: The UE performs a TAU procedure and the RRC connection is released.	-	-	-	-
22	The SS changes Cell 1, Cell 2 and Cell 7 levels according to the row "T3" in table 6.4.3.3.2-1 and table 6.4.3.3.2-2.	-	-	-	-
23-28	Steps 1 to 6 of the procedure described in TS 36.508 subclause 6.4.2.7 is performed on Cell 1. NOTE: The UE performs a TAU procedure and the RRC connection is released.	-	-	-	-
29	The SS changes Cell 2 and Cell 5 levels according to the row "T4" in table 6.4.3.3.2-1 and table 6.4.3.3.2-2.	-	-	-	-
30-37	Check: Does the test result of steps 1 to 8 of generic test procedure in TS 36.508 subclause 6.4.2.8 indicate that the UE is camped on Cell 5 within 6 mins from "T4" to the time RRC CONNECTION REQUEST received by SS? NOTE: The UE performs a RAU procedure	-	-	1	-

6.4.3.3.3 Specific message contents

Table 6.4.3.3.3-1: SystemInformationBlockType6 for Cell 1 and Cell 2 (preamble and all steps, Table 6.4.3.3.2-3)

Derivation Path: 36.508 clause 4.4.3.3, Table 4.4.3.3-5			
Information Element	Value/remark	Comment	Condition
SystemInformationBlockType6 ::= SEQUENCE {			
carrierFreqListUTRA-FDD SEQUENCE (SIZE (1..maxUTRA-FDD-Carrier)) OF SEQUENCE {	1 entry	the first entry only	UTRA-FDD
cellReselectionPriority[1]	3	Lower priority than E-UTRA	
}			
carrierFreqListUTRA-TDD SEQUENCE (SIZE (1..maxUTRA-TDD-Carrier)) OF SEQUENCE {	1 entry	the first entry only	UTRA-TDD
cellReselectionPriority[1]	3	Lower priority than E-UTRA	
}			
}			

Condition	Explanation
UTRA-FDD	UTRA FDD cell environment
UTRA-TDD	UTRA TDD cell environment

Table 6.4.3.3.2: Master Information Block for Cell 5 (preamble and all steps, Table 6.4.3.3.2-3)

Derivation Path: 34.108 clause 6.1.0a.3			
Information Element	Value/remark	Comment	Condition
- CSG Indicator	Not present		

Table 6.4.3.3.3: System Information Block type 3 for Cell 5 (preamble and all steps, Table 6.4.3.3.2-3)

Derivation Path: 34.108 clause 6.1.0b			
Information Element	Value/remark	Comment	Condition
- CSG Identity	'000 0000 0000 0000 0000 0000 0010'B		
- CSG PSC Split Information			
- Start PSC	104		
- Number of PSCs	5		
- PSC Range 2 Offset	Not present		

Table 6.4.3.3.4: System Information Block type 19 for Cell 5 and Cell 7 (preamble and all steps, Table 6.4.3.3.2-3)

Derivation Path: 36.508 clause 4.4.4.1, Table 4.4.4.1-1			
Information Element	Value/remark	Comment	Condition
SysInfoType19 ::= SEQUENCE {			
Ultra-PriorityInfoList SEQUENCE {			
utra-ServingCell SEQUENCE {			
priority	3	Lower priority than E-UTRA	
}			
eutra-FrequencyAndPriorityInfoList SEQUENCE (SIZE (1..maxNumEUTRAFreqs)) OF SEQUENCE	1 entry	the first entry only	
priority[1]	4		
}			
}			

6.4.4 Inter-RAT cell reselection / From E-UTRA RRC_IDLE non-member hybrid cell to UTRA_Idle member hybrid cell

6.4.4.1 Test Purpose (TP)

(1)

```
with { UE in E-UTRA RRC_IDLE state on a non-member hybrid cell and UE's Allowed CSG list is not empty }
ensure that {
  when { a previously visited UTRA member hybrid cell becomes the strongest cell on its frequency }
  then { UE reselects the suitable UTRA member hybrid cell irrespective of its lower priority than EUTRA cell }
}
```

6.4.4.2 Conformance requirements

References: The conformance requirements covered in the present TC are specified in: TS 25.304, clause 5.6.1; TS 36.304, clauses 5.2.4.8.1 and 5.2.4.9; and TS 36.133, clauses 4.2.2.10 and 4.2.2.10.2.

[TS 25.304, clause 5.6.1]

In the UE on request of NAS, the AS shall scan all RF channels in the UTRA bands according to its capabilities to find available CSG IDs. On each carrier, the UE shall at least search for the strongest cell, read its system information and report available CSG ID(s) together with their "HNB name" (if broadcast) and PLMN(s) to the NAS. The search for available CSG IDs may be stopped on request of the NAS.

If NAS has selected a CSG ID and provided this selection to AS, the UE shall search for an acceptable or suitable cell belonging to the selected CSG ID to camp on.

[TS 36.304, clause 5.2.4.8.1]

In addition to normal cell reselection, the UE shall use an autonomous search function to detect at least previously visited allowed CSG cells on non-serving frequencies, including inter-RAT frequencies, according to the performance requirements specified in [10], when at least one CSG ID is included in the UE's CSG whitelist. The UE may also use autonomous search on the serving frequency. The UE shall disable the autonomous search function for CSG cells if the UE's CSG whitelist is empty.

NOTE: The UE autonomous search function, per UE implementation, determines when and/or where to search for allowed CSG cells.

If the UE detects one or more suitable CSG cells on different frequencies, then the UE shall reselect to one of the detected cells irrespective of the frequency priority of the cell the UE is currently camped on, if the concerned CSG cell is the highest ranked cell on that frequency.

[TS 36.304, clause 5.2.4.9]

In addition to normal cell reselection rules, the UE shall use an autonomous search function to detect at least previously visited hybrid cells whose CSG IDs are in the UE's CSG whitelist according to the performance requirements specified in [10]. The UE shall treat detected hybrid cells as CSG cells if the CSG ID of the hybrid cell is in the UE's CSG whitelist and as normal cells otherwise.

[TS 36.133, clause 4.2.2.10]

Reselection from non CSG to CSG cells may be performed using UE autonomous search as defined in [1] when at least one CSG ID is included in the UE's CSG whitelist. The requirements in this section are valid for reselection to CSG cells previously visited by the UE when the radio configuration parameters, including the carrier frequency and physical cell identity of the CSG cell, non CSG cell and other neighbour cells are unchanged from the most recent previous visit.

[TS 36.133, clause 4.2.2.10.2]

The UE shall perform search and reselection to an allowed inter-RAT UTRAN FDD CSG cell that has met CSG reselection criterion defined in [1] and that is in its whitelist, within 6 minutes in the conditions shown in table 4.2.2.10.2-1. There is no need for statistical testing of this requirement.

Table 4.2.2.10.2-1: Parameters for CSG inter-RAT UTRAN FDD reselection

Parameter	Unit	Cell 1	Cell 2
E-UARFCN ^{Note1}		Channel 1	N/A
UARFCN ^{Note1}		N/A	Channel 2
CSG indicator		False	True
Physical cell identity ^{Note1}		1	N/A
Primary scrambling code ^{Note1}		N/A	Scrambling code 2
CSG identity		Not sent	Sent (Already stored in UE whitelist from previous visit)
Propagation conditions		Static, non multipath	
CSG cell previously visited by UE		Yes	
PBCH_RA	dB	0	N/A
PBCH_RB	dB		
PSS_RA	dB		
SSS_RA	dB		
PCFICH_RB	dB		
PHICH_RA	dB		
PHICH_RB	dB		
PDCCH_RA	dB		
PDCCH_RB	dB		
PDSCH_RA	dB		
PDSCH_RB	dB		
OCNG_RA ^{Note 1}	dB		
OCNG_RB ^{Note 1}	dB		
Qrxlevmin	dBm		
N_{oc}	dBm/15 kHz	Off	
RSRP ^{Note2}	dBm/15 KHz	[≥TBD]	
CPICH_Ec ^{Note2}	dBm		[≥TBD]
CPICH_Ec/lor	dB		-10
PCCPCH_Ec/lor	dB		-12
SCCPCH_Ec/lor	dB		-12
AICH_Ec/lor	dB		-15
SCH_Ec/lor	dB		-15
PICH_Ec/lor	dB		-15
I_{oc}	dBm/3.84 MHz		Off
<p>Note 1: For this requirement to be applicable, the E-UARFCN and physical cell identity for cell 1 and the UARFCN and scrambling code for cell 2 shall be unchanged from when the CSG cell was visited previously.</p> <p>Note 2: Chosen to ensure that CSG autonomous search has a high probability of success on every attempt made by the UE.</p>			

6.4.4.3 Test description

6.4.4.3.1 Pre-test conditions

System Simulator:

- Cell 1 and Cell 2 are E-UTRAN cells and have different tracking areas according to table 6.0.1-2.
- Cell 5 and Cell 7 are UTRAN cells
- Cell 1 and Cell 7 are not CSG cells.
- Cell 2 and Cell 5 are hybrid cells.
- System information combination 11 as defined in TS 36.508 [18] clause 4.4.3.1 is used in E-UTRA Cell 2.
- System information combination 4 as defined in TS 36.508 [18] clause 4.4.3.1 is used in E-UTRA Cell 1.

UE:

- The UE's Allowed CSG list contains the CSG ID of Cell 5.

Preamble:

- The UE is in state Registered, Idle Mode (state 2) according to [18] in Cell 1.

6.4.4.3.2 Test procedure sequence

Table 6.4.4.3.2-1 & 6.4.4.3.2-2 illustrates the downlink power levels and other changing parameters to be applied for the cells at various time instants of the test execution. Configurations marked "T0", "T1", "T2", "T3", "T4" and "T5" are applied at the points indicated in the Main behaviour description in Table 6.4.4.3.2-3.

Table 6.4.4.3.2-1: Time instances of cell power level and parameter changes for E-UTRA Cell 1 and Cell 2

	Parameter	Unit	Cell 1	Cell 2	Remark
T0	Cell-specific RS EPRE	dBm/15kHz	-85	OFF	
	Qrxlevmin	dBm	-106	-106	Default value
	Qrxlevminoffset	dB	0	0	Default value
	Qhyst	dB	0	0	Default value
	Srxlev*	dB	21	N/A	Cell 1 is the strongest cell
T1	Cell-specific RS EPRE	dBm/15kHz	-91	-85	
	Srxlev*	dB	15	21	
T2	Cell-specific RS EPRE	dBm/15kHz	OFF	-85	
	Srxlev*	dB	N/A	21	
T3	Cell-specific RS EPRE	dBm/15kHz	-85	OFF	
	Srxlev*	dB	21	N/A	
T4	Cell-specific RS EPRE	dBm/15kHz	-91	-85	
	Srxlev*	dB	15	21	
T5	Cell-specific RS EPRE	dBm/15kHz	OFF	-85	
	Srxlev*	dB	N/A	21	
Note: Srxlev is calculated in the UE					

Table 6.4.4.3.2-2: Time instances of cell power level and parameter changes for UTRA Cell 5 and Cell 7

	Parameter	Unit	Cell 5	Cell 7	Remark
T0	CPICH_Ec	dBm/3.84 MHz	OFF	OFF	Camping on Cell 1 is guaranteed
	PCCPCH RSCP	dBm/1.28 MHz	OFF	OFF	Camping on Cell 1 is guaranteed
	Qrxlevmin (FDD)	dBm	-79	-79	Default value
	Qrxlevmin (TDD)	dBm	-81	-81	Default value
	Srxlev*	dB	N/A	N/A	
T1	CPICH_Ec	dBm/3.84 MHz	OFF	OFF	
	PCCPCH RSCP	dBm/1.28 MHz	OFF	OFF	
	Srxlev*	dB	N/A	N/A	
T2	CPICH_Ec	dBm/3.84 MHz	-60	-64	Srxlev _{Cell 5} > 0, for FDD
	PCCPCH RSCP	dBm/1.28 MHz	-62	-66	Srxlev _{Cell 5} > 0, for TDD
	Srxlev*	dB	19	15	Cell 5 becomes the suitable cell
T3	CPICH_Ec	dBm/3.84 MHz	OFF	OFF	
	PCCPCH RSCP	dBm/1.28 MHz	OFF	OFF	
	Srxlev*	dB	N/A	N/A	
T4	CPICH_Ec	dBm/3.84 MHz	OFF	-64	
	PCCPCH RSCP	dBm/1.28 MHz	OFF	-66	
	Srxlev*	dB	N/A	15	
T5	CPICH_Ec	dBm/3.84 MHz	-60	-64	Srxlev _{Cell 5} > 0, for FDD
	PCCPCH RSCP	dBm/1.28 MHz	-62	-66	Srxlev _{Cell 5} > 0, for TDD
	Srxlev*	dB	19	15	Cell 5 becomes the suitable cell
Note: Srxlev is calculated in the UE					

Table 6.4.4.3.2-3: Main behaviour

St	Procedure	Message Sequence		TP	Verdict
		U - S	Message		
1	The SS changes Cell 1 and Cell 2 levels according to the row "T1" in table 6.4.4.3.2-1.	-	-	-	-
2-8	Steps 1 to 6 of the procedure described in TS 36.508 subclause 6.4.2.7 is performed on Cell 2. NOTE: The UE performs a TAU procedure and the RRC connection is released.	-	-	-	-
9	The SS changes Cell 1, Cell 5 and Cell 7 levels according to the row "T2" in table 6.4.4.3.2-1 and table 6.4.4.3.2-2.	-	-	-	-
10	UE performs manual CSG ID selection and select Cell 5.	-	-	-	-
11-20	Steps 1 to 10 of the generic test procedure described in TS 36.508 subclause 6.4.2.8 are performed on Cell 5. NOTE: The UE performs a RAU procedure and the RRC connection is released.	-	-	-	-
21	The SS changes Cell 1, Cell 2, Cell 5 and Cell 7 levels according to the row "T3" in table 6.4.4.3.2-1 and table 6.4.4.3.2-2.	-	-	-	-
22-29	Steps 1 to 8 of the procedure described in TS 36.508 Table 6.4.2.7A-1 is performed on Cell 1. NOTE: The UE performs a TAU procedure and the RRC connection is released.	-	-	-	-
30	The SS changes Cell 1, Cell 2 and Cell 7 levels according to the row "T4" in table 6.4.4.3.2-1 and table 6.4.4.3.2-2.	-	-	-	-
31-36	Steps 1 to 6 of the procedure described in TS 36.508 subclause 6.4.2.7 is performed on Cell 2. NOTE: The UE performs a TAU procedure and the RRC connection is released.	-	-	-	-
37	The SS changes Cell 1 and Cell 5 levels according to the row "T5" in table 6.4.4.3.2-2.	-	-	-	-
38-45	Check: Does the test result of steps 1 to 8 of generic test procedure in TS 36.508 subclause 6.4.2.8 indicate that the UE is camped on Cell 5 within 6 mins from "T5" to the time RRC CONNECTION REQUEST received by SS? NOTE: The UE performs a RAU procedure	-	-	1	-

6.4.4.3.3 Specific message contents

Table 6.4.4.3.3-1: Conditions for table 6.4.4.3.3-2

Condition	Explanation
Cell 1	This condition applies to system information transmitted on Cell 1.
Cell 2	This condition applies to system information transmitted on Cell 2.

Table 6.4.4.3.3-2: SystemInformationBlockType1 for Cell 1 and Cell 2 (preamble and all steps, Table 6.4.4.3.2-3)

Derivation Path: 36.508 clause 4.4.3.2, Table 4.4.3.2-3			
Information Element	Value/remark	Comment	Condition
SystemInformationBlockType1 ::= SEQUENCE {			
cellAccessRelatedInfo SEQUENCE {			
csg-Indication	FALSE		
csg-Identity	Not present		Cell 1
csg-Identity	'000 0000 0000 0000 0000 0000 0011'B		Cell 2
}			
}			

Table 6.4.4.3.3-3: SystemInformationBlockType4 for Cell 2 (preamble and all steps, table 6.4.4.3.2-3)

Derivation Path: 36.508 clause 4.4.3.3, Table 4.4.3.3-3			
Information Element	Value/remark	Comment	Condition
SystemInformationBlockType4 ::= SEQUENCE {			
csg-PhysCellIdRange ::= SEQUENCE {			
start	4		
range	Not present	The UE shall apply value 1 in case the field is absent, in which case only the physical cell identity value indicated by start applies.	
}			
}			

Table 6.4.4.3.3-4: SystemInformationBlockType6 for Cell 1 and Cell 2 (preamble and all steps, Table 6.4.4.3.2-3)

Derivation Path: 36.508 clause 4.4.3.3, Table 4.4.3.3-5			
Information Element	Value/remark	Comment	Condition
SystemInformationBlockType6 ::= SEQUENCE {			
carrierFreqListUTRA-FDD SEQUENCE (SIZE (1..maxUTRA-FDD-Carrier)) OF SEQUENCE {	1 entry	the first entry only	UTRA-FDD
cellReselectionPriority[1]	3	Lower priority than E-UTRA	
}			
carrierFreqListUTRA-TDD SEQUENCE (SIZE (1..maxUTRA-TDD-Carrier)) OF SEQUENCE {	1 entry	the first entry only	UTRA-TDD
cellReselectionPriority[1]	3	Lower priority than E-UTRA	
}			
}			

Condition	Explanation
UTRA-FDD	UTRA FDD cell environment
UTRA-TDD	UTRA TDD cell environment

Table 6.4.4.3.3-5: Master Information Block for Cell 5 (preamble and all steps, Table 6.4.4.3.2-3)

Derivation Path: 34.108 clause 6.1.0a.3			
Information Element	Value/remark	Comment	Condition
- CSG Indicator	Not present		

Table 6.4.4.3.3-6: System Information Block type 3 for Cell 5 (preamble and all steps, Table 6.4.4.3.2-3)

Derivation Path: 34.108 clause 6.1.0b			
Information Element	Value/remark	Comment	Condition
- CSG Identity	'000 0000 0000 0000 0000 0000 0010'B		
- CSG PSC Split Information			
- Start PSC	104		
- Number of PSCs	5		
- PSC Range 2 Offset	Not present		

Table 6.4.4.3.3-7: System Information Block type 19 for Cell 5 and Cell 7 (preamble and all steps, Table 6.4.4.3.2-3)

Derivation Path: 36.508 clause 4.4.4.1, Table 4.4.4.1-1			
Information Element	Value/remark	Comment	Condition
SysInfoType19 ::= SEQUENCE {			
utra-PriorityInfoList SEQUENCE {			
utra-ServingCell SEQUENCE {			
priority	3	Lower priority than E-UTRA	
}			
utra-FrequencyAndPriorityInfoList SEQUENCE (SIZE (1..maxNumEUTRAFreqs)) OF SEQUENCE	1 entry	the first entry only	
priority[1]	4		
}			
}			

6.4.5 Inter-RAT cell reselection / From UTRA_Idle to E-UTRA RRC_IDLE member hybrid cell

6.4.5.1 Test Purpose (TP)

(1)

```
with { UE in UTRA IDLE state and UE's Allowed CSG list is not empty }
ensure that {
  when { a previously visited E-UTRA member hybrid cell becomes the strongest cell on its frequency }
  then { UE reselects the suitable E-UTRA member hybrid cell irrespective of its lower priority than UTRA cell }
}
```

6.4.5.2 Conformance requirements

References: The conformance requirements covered in the present TC are specified in: TS 25.304, clauses 5.2.6.4.1 and 5.2.6.5; TS 25.133, clauses 4.2.2.11 and 4.2.2.11.2; TS 36.304, clause 5.5.1.

[TS 25.304, clause 5.2.6.4.1]

In addition to normal cell reselection, the UE shall use an autonomous search function to detect at least previously visited allowed CSG cells on non-serving frequencies, including inter-RAT frequencies, according to the performance requirements specified in [10], when at least one CSG ID is included in the UE's CSG whitelist. The UE is required to perform autonomous search function in Idle, Cell_PCH and URA_PCH states. The UE shall disable the autonomous search function for CSG cells if the UE's CSG whitelist is empty. If "Dedicated CSG frequency(ies)" IE is present, the UE may use the autonomous search function only on these dedicated frequencies and on the other frequencies listed in the system information.

NOTE: The UE autonomous search function, per UE implementation, determines when and/or where to search for allowed CSG cells.

When the UE has no or an empty CSG whitelist, the UE may ignore cells with PSC in the stored range "CSG PSC Split Information" [4] reserved for CSG cells for intra-frequency and inter-frequency measurements and cell re-selections.

If the UE detects a suitable CSG cell on the same frequency it shall reselect this cell if the concerned CSG cell is the highest ranked cell, according to 5.2.6.1.4.

If the UE detects a suitable CSG cell on a different frequency it shall reselect this cell irrespective of the cell reselection rules applicable for the cell the UE is currently camped on, if the detected suitable CSG cell is the strongest cell on that frequency. If suitable CSG cells are detected on different frequencies and these are the strongest cells on their frequencies, then the UE shall reselect to any one of them.

If the UE detects one or more suitable CSG cell on another RAT, the UE shall reselect to one of them according to [18].

[TS 25.304, clause 5.2.6.5]

In addition to normal cell reselection rules, the UE shall use an autonomous search function to detect at least previously visited hybrid cells whose CSG IDs are in the UE's CSG whitelist according to the performance requirements specified in [10]. The UE shall treat detected hybrid cells as CSG cells if the CSG ID of the hybrid cell is in the UE's CSG whitelist and as normal cells otherwise.

[TS 36.304, clause 5.5.1]

In the UE on request of NAS, the AS shall scan all RF channels in the E-UTRA bands according to its capabilities to find available CSG IDs. On each carrier, the UE shall at least search for the strongest cell, read its system information and report available CSG ID(s) together with their "HNB name" (if broadcast) and PLMN(s) to the NAS. The search for available CSG IDs may be stopped on request of the NAS.

If NAS has selected a CSG ID and provided this selection to AS, the UE shall search for an acceptable or suitable cell belonging to the selected CSG ID to camp on.

[TS 25.133, clause 4.2.2.11]

Reselection from non CSG to CSG cells may be performed using UE autonomous search as defined in [1] when at least one CSG ID is included in the UE's CSG whitelist. The requirements in this section are valid for reselection to CSG cells previously visited by the UE when the radio configuration parameters, including the carrier frequency and physical cell identity of the CSG cell, non CSG cell and other neighbour cells are unchanged from the most recent previous visit.

[TS 25.133, clause 4.2.2.11.2]

The UE shall perform search and reselection to an allowed inter-RAT E-UTRA CSG cell that has met CSG reselection criterion defined in [1] and that is in its whitelist, within 6 minutes in the conditions shown in table 4.2.2.11.2-1. There is no need for statistical testing of this requirement.

Table 4.2.2.11.2-1: Parameters for CSG inter-RAT E-UTRA reselection

a) Parameter	a) Unit	a) Cell 1	a) Cell 2	
UARFCN ^{Note1}		Channel 1	N/A	
E-UARFCN ^{Note1}		N/A	Channel 2	
CSG indicator		False	True	
Primary scrambling code ^{Note1}		Scrambling code 1	N/A	
Physical cell identity ^{Note1}		N/A	2	
CSG identity		Not sent	Sent (Already stored in UE whitelist from previous visit)	
Propagation conditions		Static, non multipath		
CSG cell previously visited by UE		Yes		
CPICH_Ec ^{Note2}	dBm	[≥TBD]	N/A	
CPICH_Ec/lor	dB	-10		
PCCPCH_Ec/lor	dB	-12		
SCCPCH_Ec/lor	dB	-12		
AICH_Ec/lor	dB	-15		
SCH_Ec/lor	dB	-15		
PICH_Ec/lor	dB	-15		
I_{oc}	dBm/3.84 MHz	Off		
PBCH_RA	dB	N/A	0	
PBCH_RB	dB			
PSS_RA	dB			
SSS_RA	dB			
PCFICH_RB	dB			
PHICH_RA	dB			
PHICH_RB	dB			
PDCCH_RA	dB			
PDCCH_RB	dB			
PDSCH_RA	dB			
PDSCH_RB	dB			
OCNG_RA ^{Note 1}	dB			
OCNG_RB ^{Note 1}	dB			
Qrxlevmin	dBm			-140
N_{oc}	dBm/15 kHz			Off
RSRP ^{Note2}	dBm/15 KHz			[≥TBD]
<p>Note 1: For this requirement to be applicable, the UARFCN and scrambling code for cell 1 and the E-UARFCN and physical cell identity for cell 2 shall be unchanged from when the CSG cell was visited previously.</p> <p>Note 2: Chosen to ensure that CSG autonomous search has a high probability of success on every attempt made by the UE.</p>				

6.4.5.3 Test description

6.4.5.3.1 Pre-test conditions

System Simulator:

- Cell 1 and Cell 2 are E-UTRAN cells.
- Cell 5 and Cell 7 are UTRAN cells and have different routing areas.
- Cell 1, Cell 5 and Cell 7 are not CSG cells.
- Cell 2 is a hybrid cell.
- System information combination 11 as defined in TS 36.508 [18] clause 4.4.3.1 is used in E-UTRA Cell 2.
- System information combination 4 as defined in TS 36.508 [18] clause 4.4.3.1 is used in E-UTRA Cell 1.

UE:

- The UE's Allowed CSG list contains the CSG ID of Cell 2.

Preamble:

- The UE is in state Registered, Idle Mode (state 3 or 7) according to [5] in Cell 5.

6.4.5.3.2 Test procedure sequence

Table 6.4.5.3.2-1 & 6.4.5.3.2-2 illustrates the downlink power levels and other changing parameters to be applied for the cells at various time instants of the test execution. Configurations marked "T0", "T1", "T2", "T3" and "T4" are applied at the points indicated in the Main behaviour description in Table 6.4.5.3.2-3.

Table 6.4.5.3.2-1: Time instances of cell power level and parameter changes for E-UTRA Cell 1 and Cell 2

	Parameter	Unit	Cell 1	Cell 2	Remark
T0	Cell-specific RS EPRE	dBm/15kHz	-OFF	OFF	
	Qrxlevmin	dBm	-106	-106	Default value
	Qrxlevminoffset	dB	0	0	Default value
	Qhyst	dB	0	0	Default value
	Srxlev*	dB	N/A	N/A	
T1	Cell-specific RS EPRE	dBm/15kHz	-85	-79	$Srxlev_{Cell\ 2} > 0$
	Srxlev*	dB	21	27	Cell 2 becomes the suitable cell
T2	Cell-specific RS EPRE	dBm/15kHz	OFF	OFF	
	Srxlev*	dB	N/A	N/A	
T3	Cell-specific RS EPRE	dBm/15kHz	-85	OFF	
	Srxlev*	dB	21	N/A	
T4	Cell-specific RS EPRE	dBm/15kHz	-85	-79	$Srxlev_{Cell\ 2} > 0$
	Srxlev*	dB	21	27	Cell 2 becomes the suitable cell

Note: Srxlev is calculated in the UE

Table 6.4.5.3.2-2: Time instances of cell power level and parameter changes for UTRA Cell 5 and Cell 7

	Parameter	Unit	Cell 5	Cell 7	Remark
T0	CPICH_Ec	dBm/3.84 MHz	-60	OFF	Camping on Cell 5 is guaranteed
	PCCPCH RSCP	dBm/1.28 MHz	-62	OFF	Camping on Cell 5 is guaranteed
	Qrxlevmin (FDD)	dBm	-79	-79	Default value
	Qrxlevmin (TDD)	dBm	-81	-81	Default value
	Srxlev*	dB	19	N/A	Cell 5 is the strongest cell
T1	CPICH_Ec	dBm/3.84 MHz	-60	OFF	
	PCCPCH RSCP	dBm/1.28 MHz	-62	OFF	
	Srxlev*	dB	19	N/A	
T2	CPICH_Ec	dBm/3.84 MHz	OFF	-60	
	PCCPCH RSCP	dBm/1.28 MHz	OFF	-62	
	Srxlev*	dB	N/A	19	
T3	CPICH_Ec	dBm/3.84 MHz	-60	-64	
	PCCPCH RSCP	dBm/1.28 MHz	-62	-66	
	Srxlev*	dB	19	15	
T4	CPICH_Ec	dBm/3.84 MHz	-60	OFF	
	PCCPCH RSCP	dBm/1.28 MHz	-62	OFF	
	Srxlev*	dB	19	N/A	

Note: Srxlev is calculated in the UE

Table 6.4.5.3.2-3: Main behaviour

St	Procedure	Message Sequence		TP	Verdict
		U - S	Message		
1	The SS changes Cell 1 and Cell 2 levels according to the row "T1" in table 6.4.5.3.2-1.	-	-	-	-
2	UE performs manual CSG ID selection and select Cell 2.	-	-	-	-
3-24	Steps 1 to 22 of the generic test procedure described in TS 36.508 Table 6.4.2.7A-2 are performed on Cell 2.	-	-	-	-
25	The SS changes Cell 1, Cell 2, Cell 5 and Cell 7 levels according to the row "T2" in table 6.4.5.3.2-1 and table 6.4.5.3.2-2.	-	-	-	-
26-35	Steps 1 to 10 of the procedure described in TS 36.508 subclause 6.4.2.8 is performed on Cell 7. NOTE: The UE performs a RAU procedure and the RRC connection is released.	-	-	-	-
36	The SS changes Cell 1, Cell 5 and Cell 7 levels according to the row "T3" in table 6.4.5.3.2-1 and table 6.4.5.3.2-2.	-	-	-	-
37-46	Steps 1 to 10 of the procedure described in TS 36.508 subclause 6.4.2.8 is performed on Cell 5. NOTE: The UE performs a RAU procedure and the RRC connection is released.	-	-	-	-
47	The SS changes Cell 2 and Cell 7 levels according to the row "T4" in table 6.4.5.3.2-1 and table 6.4.5.3.2-2.	-	-	-	-
48-54	Check: Does the test result of steps 1 to 7 of generic test procedure in TS 36.508 Table 6.4.2.7A-1 indicate that the UE is camped on Cell 2 within 6 mins from "T4" to the time <i>RRCConnectionRequest</i> received by SS? NOTE: The UE performs a TAU procedure	-	-	1	-
-	At the end of this test procedure sequence, the UE is in end state E-UTRA connected (E2_T3440) according to TS 36.508.	-	-	-	-

6.4.5.3.3

Specific message contents

Table 6.4.5.3.3-1: Conditions for specific message contents in Table 6.4.5.3.3-3

Condition	Explanation
Cell 1	This condition applies to system information transmitted on Cell 1.
Cell 2	This condition applies to system information transmitted on Cell 2.

Table 6.4.5.3.3-2: System Information Block type 19 for Cell 5 and Cell 7 (preamble and all steps, Table 6.4.5.3.2-3)

Derivation Path: 36.508 clause 4.4.4.1, Table 4.4.4.1-1			
Information Element	Value/remark	Comment	Condition
SysInfoType19 ::= SEQUENCE {			
utra-PriorityInfoList SEQUENCE {			
utra-ServingCell SEQUENCE {			
priority	5	Higher priority than E-UTRA	
}			
eutra-FrequencyAndPriorityInfoList SEQUENCE (SIZE (1..maxNumEUTRAFreqs)) OF SEQUENCE	1 entry	the first entry only	
priority[1]	4		
}			
}			

Table 6.4.5.3.3-3: SystemInformationBlockType1 for Cell 1 and Cell 2 (preamble and all steps, Table 6.4.5.3.2-3)

Derivation Path: 36.508 Table 4.4.3.2-3			
Information Element	Value/remark	Comment	Condition
SystemInformationBlockType1 ::= SEQUENCE {			
cellAccessRelatedInfo SEQUENCE {			
csg-Indication	FALSE		
csg-Identity	Not present		Cell 1
csg-Identity	'000 0000 0000 0000 0000 0000 0010'B		Cell 2
}			
}			

Table 6.4.5.3.3-4: SystemInformationBlockType4 for Cell 2 (preamble and all steps, Table 6.4.5.3.2-3)

Derivation Path: 36.508 clause 4.4.3.3, Table 4.4.3.3-3			
Information Element	Value/remark	Comment	Condition
SystemInformationBlockType4 ::= SEQUENCE {			
csg-PhysCellIdRange ::= SEQUENCE {			
start	4		
range	Not present	The UE shall apply value 1 in case the field is absent, in which case only the physical cell identity value indicated by start applies.	
}			
}			

Table 6.4.5.3.3-5: SystemInformationBlockType6 for Cell 1 and Cell 2 (preamble and all steps, Table 6.4.5.3.2-3)

Derivation Path: 36.508 clause 4.4.3.3, Table 4.4.3.3-5			
Information Element	Value/remark	Comment	Condition
SystemInformationBlockType6 ::= SEQUENCE {			
carrierFreqListUTRA-FDD SEQUENCE (SIZE (1..maxUTRA-FDD-Carrier)) OF SEQUENCE {	1 entry	the first entry only	UTRA-FDD
cellReselectionPriority[1]	5	Higher priority than E-UTRA	
}			
carrierFreqListUTRA-TDD SEQUENCE (SIZE (1..maxUTRA-TDD-Carrier)) OF SEQUENCE {	1 entry	the first entry only	UTRA-TDD
cellReselectionPriority[1]	5	Higher priority than E-UTRA	
}			
}			

Condition	Explanation
UTRA-FDD	UTRA FDD cell environment
UTRA-TDD	UTRA TDD cell environment

6.4.6 Inter-RAT cell reselection / From UTRA CELL_PCH to E-UTRA RRC_IDLE member hybrid cell

6.4.6.1 Test Purpose (TP)

(1)

```
with { UE in UTRA Cell PCH state and UE's CSG whitelist is not empty }
ensure that {
  when { UE detects a suitable E-UTRA member hybrid cell that is not the strongest cell on that frequency }
  then { UE does not reselect to the E-UTRA member hybrid cell }
}
```

(2)

```
with { UE in UTRA Cell PCH state and UE's CSG whitelist is not empty }
ensure that {
  when { UE detects a suitable E-UTRA member hybrid cell previously visited }
  then { UE reselects the suitable previously visited E-UTRA member hybrid cell irrespective of the EUTRAN cell reselection priority }
}
```

6.4.6.2 Conformance requirements

References: The conformance requirements covered in the present TC are specified in: TS 25.304, 5.2.6.5, 5.2.6.4.1, TS 36.304 clause 5.2.4.9, 5.2.4.8.1, 5.2.4.6, 5.2.4.8.2, 5.2.4.1 and TS 25.133 clause 4.2.2.11.2.

[TS 25.304, clause 5.2.6.5]

In addition to normal cell reselection rules, the UE shall use an autonomous search function to detect at least previously visited hybrid cells whose CSG IDs are in the UE's CSG whitelist according to the performance requirements specified in [10]. The UE shall treat detected hybrid cells as CSG cells if the CSG ID of the hybrid cell is in the UE's CSG whitelist and as normal cells otherwise.

[TS 25.304, clause 5.2.6.4.1]

In addition to normal cell reselection, the UE shall use an autonomous search function to detect at least previously visited allowed CSG cells on non-serving frequencies, including inter-RAT frequencies, according to the performance requirements specified in [10], when at least one CSG ID is included in the UE's CSG whitelist. The UE is required to perform autonomous search function in Idle, Cell_PCH and URA_PCH states. The UE shall disable the autonomous search function for CSG cells if the UE's CSG whitelist is empty. If "Dedicated CSG frequency(ies) " IE is present, the

UE may use the autonomous search function only on these dedicated frequencies and on the other frequencies listed in the system information.

NOTE: The UE autonomous search function, per UE implementation, determines when and/or where to search for allowed CSG cells.

When the UE has no or an empty CSG whitelist, the UE may ignore cells with PSC in the stored range "CSG PSC Split Information" [4] reserved for CSG cells for intra-frequency and inter-frequency measurements and cell re-selections.

...

If the UE detects a suitable CSG cell on a different frequency it shall reselect this cell irrespective of the cell reselection rules applicable for the cell the UE is currently camped on, if the detected suitable CSG cell is the strongest cell on that frequency. If suitable CSG cells are detected on different frequencies and these are the strongest cells on their frequencies, then the UE shall reselect to any one of them.

If the UE detects one or more suitable CSG cell on another RAT, the UE shall reselect to one of them according to [18].

[TS 25.133, clause 4.2.2.11.2]

The UE shall perform search and reselection to an allowed inter-RAT E-UTRA CSG cell that has met CSG reselection criterion defined in [1] and that is in its whitelist, within 6 minutes in the conditions shown in table 4.2.2.11.2-1. There is no need for statistical testing of this requirement.

Table 4.2.2.11.2-1: Parameters for CSG inter-RAT E-UTRA reselection

Parameter	Unit	Cell 1	Cell 2	
UARFCN ^{Note1}		Channel 1	N/A	
E-UARFCN ^{Note1}		N/A	Channel 2	
CSG indicator		False	True	
Primary scrambling code ^{Note1}		Scrambling code 1	N/A	
Physical cell identity ^{Note1}		N/A	2	
CSG identity		Not sent	Sent (Already stored in UE whitelist from previous visit)	
Propagation conditions		Static, non multipath		
CSG cell previously visited by UE		Yes		
CPICH_Ec ^{Note2}	dBm	[≥TBD]	N/A	
CPICH_Ec/lor	dB	-10		
PCCPCH_Ec/lor	dB	-12		
SCCPCH_Ec/lor	dB	-12		
AICH_Ec/lor	dB	-15		
SCH_Ec/lor	dB	-15		
PICH_Ec/lor	dB	-15		
I_{oc}	dBm/3.84 MHz	Off	0	
PBCH_RA	dB	N/A		
PBCH_RB	dB			
PSS_RA	dB			
SSS_RA	dB			
PCFICH_RB	dB			
PHICH_RA	dB			
PHICH_RB	dB			
PDCCH_RA	dB			
PDCCH_RB	dB			
PDSCH_RA	dB			
PDSCH_RB	dB			
OCNG_RA ^{Note 1}	dB			
OCNG_RB ^{Note 1}	dB			
Qrxlevmin	dBm			-140
N_{oc}	dBm/15 kHz			Off
RSRP ^{Note2}	dBm/15 KHz			[≥TBD]
<p>Note 1: For this requirement to be applicable, the UARFCN and scrambling code for cell 1 and the E-UARFCN and physical cell identity for cell 2 shall be unchanged from when the CSG cell was visited previously</p> <p>Note 2: Chosen to ensure that CSG autonomous search has a high probability of success on every attempt made by UE</p>				

[TS 36.304, clause 5.2.4.9]

In addition to normal cell reselection rules, the UE shall use an autonomous search function to detect at least previously visited hybrid cells whose CSG IDs are in the UE's CSG whitelist according to the performance requirements specified in [10]. The UE shall treat detected hybrid cells as CSG cells if the CSG ID of the hybrid cell is in the UE's CSG whitelist and as normal cells otherwise.

[TS 36.304, clause 5.2.4.8.1]

In addition to normal cell reselection, the UE shall use an autonomous search function to detect at least previously visited allowed CSG cells on non-serving frequencies, including inter-RAT frequencies, according to the performance requirements specified in [10], when at least one CSG ID is included in the UE's CSG whitelist. The UE may also use autonomous search on the serving frequency. The UE shall disable the autonomous search function for CSG cells if the UE's CSG whitelist is empty.

NOTE: The UE autonomous search function, per UE implementation, determines when and/or where to search for allowed CSG cells.

If the UE detects one or more suitable CSG cells on different frequencies, then the UE shall reselect to one of the detected cells irrespective of the frequency priority of the cell the UE is currently camped on, if the concerned CSG cell is the highest ranked cell on that frequency.

If the UE detects a suitable CSG cell on the same frequency, it shall reselect to this cell as per normal reselection rules (5.2.4.6.).

[TS 36.304, clause 5.2.4.6]

The cell-ranking criterion R_s for serving cell and R_n for neighbouring cells is defined by:

$$R_s = Q_{\text{meas},s} + Q_{\text{Hyst}}$$

$$R_n = Q_{\text{meas},n} - Q_{\text{offset}}$$

where:

Q_{meas}	RSRP measurement quantity used in cell reselections.
Q_{offset}	For intra-frequency: Equals to $Q_{\text{offset},s,n}$, if $Q_{\text{offset},s,n}$ is valid, otherwise this equals to zero. For inter-frequency: Equals to $Q_{\text{offset},s,n}$ plus $Q_{\text{offset}_{\text{frequency}}}$, if $Q_{\text{offset},s,n}$ is valid, otherwise this equals to $Q_{\text{offset}_{\text{frequency}}}$.

The UE shall perform ranking of all cells that fulfil the cell selection criterion S , which is defined in 5.2.3.2, but may exclude all CSG cells that are known by the UE to be not allowed.

The cells shall be ranked according to the R criteria specified above, deriving $Q_{\text{meas},n}$ and $Q_{\text{meas},s}$ and calculating the R values using averaged RSRP results.

If a cell is ranked as the best cell the UE shall perform cell reselection to that cell. If this cell is found to be not-suitable, the UE shall behave according to subclause 5.2.4.4.

In all cases, the UE shall reselect the new cell, only if the following conditions are met:

- the new cell is better ranked than the serving cell during a time interval $T_{\text{reselection}_{\text{RAT}}}$;
- more than 1 second has elapsed since the UE camped on the current serving cell.

[TS 36.304, clause 5.2.4.8.2]

While camped on a suitable CSG cell, the UE shall apply the normal cell reselection rules as defined in subclause 5.2.4.

[TS 36.304, clause 5.2.4.1]

Absolute priorities of different E-UTRAN frequencies or inter-RAT frequencies may be provided to the UE in the system information, in the *RRConnectionRelease* message, or by inheriting from another RAT at inter-RAT cell (re)selection.

...

While the UE is camped on a suitable CSG cell, the UE shall always consider the current frequency to be the highest priority frequency (i.e. higher than the eight network configured values), irrespective of any other priority value allocated to this frequency.

6.4.6.3 Test description

6.4.6.3.1 Pre-test conditions

System Simulator:

- Cell 1 and Cell 2 are E-UTRAN Cells.
- Cell 5 is UTRAN Cell.

- Cell 1, Cell 5 are not CSG or Hybrid CSG cells.
- Cell 2 is Hybrid CSG cell.
- System information combination 4 as defined in TS 36.508 [18] clause 4.4.3.1 is used in E-UTRA cell 1.
- System information combination 11 as defined in TS 36.508 [18] clause 4.4.3.1 is used in E-UTRA cell 2.

UE:

- UE's CSG whitelist contains the CSG ID of Cell 2.

Preamble:

- Cell 2 is a previously visited cell.
- The UE is in state CELL_PCH (state 6-12) on Cell 5 according to [5].

6.4.6.3.2 Test procedure sequence

Table 6.4.6.3.2-1 and Table 6.4.6.3.2-2 illustrate the downlink power levels and other changing parameters to be applied for the cells at various time instants of the test execution. Row marked "T0" denotes the initial conditions, while rows marked "T1" and "T2" are to be applied subsequently. The exact instants on which these values shall be applied are described in the texts in this clause.

Table 6.4.6.3.2-1: Time instances of cell power level and parameter changes for E-UTRA cell

	Parameter	Unit	Cell 1	Cell 2	Remark
T0	Cell-specific RS EPRE	dBm/15kHz	"Off"	"Off"	Power level "Off" is defined in TS36.508 Table 6.2.2.1-1.
	Qrxlevmin	dBm	-106	-106	
T1	Cell-specific RS EPRE	dBm/15kHz	-85	-91	
	Srxlev*	dB	21	15	Srxlev = Cell-specific RS EPRE - qRxLevMinEUTRA
T2	Cell-specific RS EPRE	dBm/15kHz	-91	-85	
	Srxlev*	dB	15	21	Srxlev = Cell-specific RS EPRE - qRxLevMinEUTRA

Note: Srxlev is calculated in the UE

Table 6.4.6.3.2-2: Time instances of cell power level and parameter changes for UTRA cell

	Parameter	Unit	Cell 5	Remark
T0	CPICH_Ec	dBm/3.84 MHz	-60	
	P-CCPCH	dBm/1.28 MHz	-62	
	Qrxlevmin (FDD)	dBm	-79	Default value
	Qrxlevmin(TDD)	dBm	-81	Default value
	Srxlev*	dB	19	
T1	CPICH_Ec	dBm/3.84 MHz	-60	
	P-CCPCH	dBm/1.28 MHz	-62	
	Srxlev*	dB	19	
T2	CPICH_Ec	dBm/3.84 MHz	-60	
	P-CCPCH	dBm/1.28 MHz	-62	
	Srxlev*	dB	19	

Table 6.4.6.3.2-3: Main behaviour

St	Procedure	Message Sequence		TP	Verdict
		U - S	Message		
1	The SS changes Cell 1 and Cell 2 levels according to the row "T1" in table 6.4.6.3.2-1. (Note 1)	-	-	-	-
2	Check: Does the UE send an <i>RRCConnectionRequest</i> on Cell 2 within 6 minutes?	-	-	1	F
3	The SS changes Cell 1 and Cell 2 levels according to the row "T2" in table 6.4.6.3.2-1.	-	-	-	-
4-10	Check: Does the test result of steps 1 to 7 of the generic test procedure in TS 36.508 Table 6.4.2.7A-1 indicate that the UE is camped on E-UTRAN Cell 2 within 6 minutes from T2 to the time <i>RRCConnctionRequest</i> received by SS? NOTE: The UE performs a TAU procedure	-	-	2	-
-	At the end of this test procedure sequence, the UE is in end state E-UTRA connected (E2_T3440) according to TS 36.508.	-	-	-	-

Note 1: SS should not send any RRC message after UE has successfully proceed to CELL_PCH state in preamble.

6.4.6.3.3 Specific message contents

Table 6.4.6.3.3-1: Conditions for specific message contents in Table 6.4.6.3.3-2

Condition	Explanation
Cell 1	This condition applies to system information transmitted on Cell 1.
Cell 2	This condition applies to system information transmitted on Cell 2.

Table 6.4.6.3.3-2: *SystemInformationBlockType1* for Cell 1 and Cell 2 (preamble and all steps, Table 6.4.6.3.2-3)

Derivation Path: 36.508 Table 4.4.3.2-3			
Information Element	Value/remark	Comment	Condition
<i>SystemInformationBlockType1</i> ::= SEQUENCE {			
<i>csg-Indication</i>	FALSE		
<i>csg-Identity</i>	Not Present		Cell 1
<i>csg-Identity</i>	'000 0000 0000 0000 0000 0000 0001'B		Cell 2
}			

Table 6.4.6.3.3-3: *SystemInformationBlockType4* for Cell 2 (preamble and all steps, Table 6.4.6.3.2-3)

Derivation Path: 36.508 Table 4.4.3.3-3			
Information Element	Value/remark	Comment	Condition
<i>csg-PhysCellIdRange</i>			
Start	4		
Range	Not present		
}			

Table 6.4.6.3.3-4: System Information Block type 19 for Cell 5 (Pre-test conditions and all steps, Table 6.4.6.3.2-3)

Derivation Path: 36.508 clause 4.4.4.1, Table 4.4.4.1-1			
Information Element	Value/remark	Comment	Condition
SysInfoType19 ::= SEQUENCE {			
utra-PriorityInfoList SEQUENCE {			
utra-ServingCell SEQUENCE {			
Priority	5	Higher priority than E-UTRA	
}			
eutra-FrequencyAndPriorityInfoList SEQUENCE (SIZE (1..maxNumEUTRAFreqs)) OF SEQUENCE {	1 entry	the first entry only	
priority[1]	4		
}			
}			

Table 6.4.6.3.3-5: SystemInformationBlockType6 for Cell 1 and Cell 2 (Pre-test conditions and all steps, Table 6.4.6.3.2-3)

Derivation Path: 36.508 Table 4.4.3.3-5			
Information Element	Value/remark	Comment	Condition
SystemInformationBlockType6 ::= SEQUENCE {			
carrierFreqListUTRA-FDD SEQUENCE (SIZE (1..maxUTRA-FDD-Carrier)) OF SEQUENCE {	1 entry	the first entry only	UTRA-FDD
cellReselectionPriority[1]	5		
}			
carrierFreqListUTRA-TDD SEQUENCE (SIZE (1..maxUTRA-TDD-Carrier)) OF SEQUENCE {	1 entry	the first entry only	UTRA-TDD
cellReselectionPriority[1]	5		
}			
}			

Condition	Explanation
UTRA-FDD	UTRA FDD cell environment
UTRA-TDD	UTRA TDD cell environment

6.4.7 Inter-RAT cell reselection / From GSM_Idle/GPRS Packet_Idle to E-UTRA RRC_IDLE member hybrid cell

6.4.7.1 Test Purpose (TP)

(1)

```
with { UE in GSM/GPRS Registered state and no RR connection }
ensure that {
  when { Manual CSG ID selection is requested }
  then { UE select the suitable E-UTRAN CSG cell }
}
```

(2)

```
with { UE in GSM/GPRS Registered state and no RR connection and UE's Allowed CSG list is not empty }
ensure that {
  when { UE detects a suitable E-UTRA member hybrid cell previously visited }
  then { UE reselects the suitable previously visited E-UTRAN CSG cell irrespective of the EUTRAN cell reselection priority }
}
```

6.4.7.2 Conformance requirements

References: The conformance requirements covered in the present TC are specified in: TS 24.301, clause 5.5.3.2.4, TS 45.008, clause 6.6.7.1, TS 45.008, clause 6.6.7.2 and TS 36.304, clause 10.1.3.4.

[TS 24.301, clause 5.5.3.2.4]

If the UE has initiated the tracking area updating procedure due to manual CSG selection and receives a TRACKING AREA UPDATE ACCEPT message, and the UE sent the TRACKING AREA UPDATE REQUEST message in a CSG cell, the UE shall check if the CSG ID of the cell where the UE has sent the TRACKING AREA UPDATE REQUEST message is contained in the Allowed CSG list. If not, the UE shall add that CSG ID to the Allowed CSG list and the UE may add the HNB Name (if provided by lower layers) to the Allowed CSG list if the HNB Name is present in neither the Operator CSG list nor the Allowed CSG list.

[TS 45.008, clause 6.6.7.1a]

If a mobile station is a member of at least one Closed Subscriber Group then, in addition to normal cell reselection, the MS shall use an autonomous search function to detect hybrid cells. The autonomous search function shall at least detect previously visited hybrid cells whose CSG IDs are included in the CSG Whitelist of the MS.

NOTE: The autonomous search for hybrid cells does not imply that the MS needs to constantly check the CSG IDs of all cells it sees, and the impact on battery consumption should be minimised.

If a neighbour cell has been detected as a hybrid cell and the CSG ID of the hybrid cell is included in the CSG Whitelist of the MS, reselection to that cell shall follow the rules for CSG cells in subclause 6.6.7.1. Otherwise normal cell reselection rules (see subclause 6.6.5 and 6.6.6) shall apply.

[TS 45.008, clause 6.6.7.1]

If a mobile station is a member of at least one Closed Subscriber Group, i.e. at least one CSG ID is included in the MS's CSG Whitelist, then, in addition to normal cell reselection, the MS shall use an autonomous search function to detect UTRAN and/or E-UTRAN CSG cells. The autonomous search function shall at least detect previously visited allowed CSG cells.

NOTE 1: The autonomous search function is implementation dependent and controls when and/or where to search for allowed CSG cells.

...

If the strongest cell (see 3GPP TS 25.304 and 3GPP TS 36.304 for the definition of the strongest cell) which the MS has detected on a UTRAN or E-UTRAN frequency during a time interval $T_{\text{reselection}}$ is a suitable CSG cell (see 3GPP TS 25.304 and 3GPP TS 36.304 for suitability criteria for UTRAN and E-UTRAN CSG cells respectively), the MS shall reselect to this cell irrespective of the cell reselection rules applicable for the cell on which the MS is currently camped.

The following requirements are valid for reselection to allowed CSG cells previously visited by the MS when the radio configuration parameters, including the carrier frequency and PSC/PCI (whichever and if it is applicable) of the CSG cell, non CSG cell and other neighbour cells, are unchanged from the most recent previous visit. The autonomous search and cell re-selection to a previously visited allowed CSG cell shall meet the performance requirements defined as follows:

- the MS shall perform search and re-selection to a previously visited allowed UTRAN FDD CSG cell, that has met the CSG cell re-selection criterion defined above, within 6 minutes in the radio conditions specified for an UTRAN FDD CSG cell in 3GPP TS 36.133 in terms of parameters for CSG inter-RAT UTRAN FDD reselection; UARFCN and PSC shall be unchanged from the most recent previous visit of the UTRAN FDD CSG cell; Serving GSM cell at $RXLEV = -70$ dBm, with 6 GSM neighbours at $RXLEV = -75$ dBm;
- the MS shall perform search and re-selection to a previously visited allowed E-UTRAN CSG cell, that has met the CSG cell re-selection criterion defined above, within 6 minutes in the radio conditions specified for an E-UTRAN CSG cell in 3GPP TS 25.133 in terms of parameters for CSG inter-RAT E-UTRA reselection; E-UARFCN and PCI shall be unchanged from the most recent previous visit of the E-UTRAN CSG cell; Serving GSM cell at $RXLEV = -70$ dBm, with 6 GSM neighbours at $RXLEV = -75$ dBm.

NOTE 4: The above performance requirements are minimum requirements defined to ensure the testability of autonomous CSG search.

[TS 45.008, clause 6.6.7.2]

If NAS requests AS to search for available CSG IDs, the MS shall perform the search and report the results to NAS as described in 3GPP TS 25.304 for UTRAN and as described in 3GPP TS 36.304 for E-UTRAN.

If a CSG ID is manually selected by NAS, the MS shall behave as specified in 3GPP TS 25.304 or in 3GPP TS 36.304, depending on the RAT type of the selected CSG cell.

[TS 45.008, clause 10.1.3.4]

If a mobile station is a member of at least one Closed Subscriber Group, i.e. at least one CSG ID is included in the MS's CSG Whitelist, then, in addition to normal cell reselection, the MS shall use an autonomous search function to detect UTRAN and/or E-UTRAN CSG cells and hybrid cells. The autonomous search function shall at least detect previously visited allowed CSG cells and previously visited hybrid cells whose CSG IDs are included in the CSG Whitelist of the MS.

6.4.7.3 Test description

6.4.7.3.1 Pre-test conditions

System Simulator:

- Cell 1 and Cell 2 are E-UTRAN Cells.
- Cell 24 and Cell 25 are GERAN Cells.
- Cell 1, Cell 24 and Cell 25 are not CSG cells or hybrid cells.
- Cell 2 is E-UTRAN Hybrid Cell.
- Cell 24 and Cell 25 have different Routing Area.
- System information combination 5 as defined in TS 36.508 [18] clause 4.4.3.1 is used in E-UTRA cell 1.
- System information combination 14 as defined in TS 36.508 [18] clause 4.4.3.1 is used in E-UTRA cell 2.

UE:

- The UE's CSG whitelist contains the CSG ID of Cell 2.

Preamble:

- The UE is in state Switched OFF (state 1) according to [18].

6.4.7.3.2 Test procedure sequence

Tables 6.4.7.3.2-1 and 6.4.7.3.2-2 illustrates the downlink power levels and other changing parameters to be applied for the cells at various time instants of the test execution. Row marked "T0" denotes the initial conditions, while rows marked "T1", "T2", "T3" and "T4" are to be applied subsequently. The exact instants on which these values shall be applied are described in the texts in this clause.

Table 6.4.7.3.2-1: Time instances of cell power level and parameter changes for E-UTRA cell

	Parameter	Unit	Cell 1	Cell 2	Remark
T0	Cell-specific RS EPRE	dBm/15kHz	"Off"	"Off"	Power level "Off" is defined in TS36.508 Table 6.2.2.1-1.
	Qrxlevmin	dBm	-106	-106	
T1	Cell-specific RS EPRE	dBm/15kHz	-91	-85	
	Srxlev*	dB	15	21	$S_{rxlev} = \text{Cell-specific RS EPRE} - q_{rxLevMinEUTRA}$
T2	Cell-specific RS EPRE	dBm/15kHz	"Off"	"Off"	Power level "Off" is defined in TS 36.508 Table 6.2.2.1-1.
	Srxlev*	dB	"Off"	"Off"	$S_{nonServingCell, Cell7} > \text{Thresh}_{Cell7,high}$
T3	Cell-specific RS EPRE	dBm/15kHz	-85	"Off"	
T4	Cell-specific RS EPRE	dBm/15kHz	-91	-85	
	Srxlev*	dB	15	21	$S_{rxlev} = \text{Cell-specific RS EPRE} - q_{rxLevMinEUTRA}$

Note: Srxlev is calculated in the UE

Table 6.4.7.3.2-2: Time instances of cell power level and parameter changes for GERAN cell

	Parameter	Unit	Cell 24	Cell 25	Remark
T0	RF Signal Level	dBm	-80	"Off"	The power levels are such that camping on Cell 24 is guaranteed.
	RXLEV_ACCESS_MIN	dBm	-101	"Off"	
	C1*	dB	21	"Off"	
T1	RF Signal Level	dBm	-80	"Off"	
	RXLEV_ACCESS_MIN	dBm	-101	"Off"	
	C1*	dB	21	"Off"	
T2	RF Signal Level	dBm	"Off"	-80	The power levels are such that camping on Cell 25 is guaranteed.
	RXLEV_ACCESS_MIN	dBm	"Off"	-101	
	C1*	dB	"Off"	21	
T3	RF Signal Level	dBm	-80	-90	
	RXLEV_ACCESS_MIN	dBm	-101	-101	
	C1*	dB	21	11	
T4	RF Signal Level	dBm	-80	"Off"	
	RXLEV_ACCESS_MIN	dBm	-101	"Off"	
	C1*	dB	21	"Off"	

Note: C1 is calculated in the UE

Table 6.4.7.3.2-3: Main behaviour

St	Procedure	Message Sequence		TP	Verdict
		U - S	Message		
1	The UE is switched on.	-	-	-	-
2	Call the registration procedure described in TS 34.123-3 subclause 6.10.2.7.1.1 performed on Cell 24. NOTE: The UE performs registration and the RR connection is released.	-	-	-	-
3	The SS changes Cell 1 and Cell 2 levels according to the row "T1" in table 6.4.7.3.2-1.	-	-	-	-
4	The UE is made to perform manual CSG ID selection and select Cell 2.	-	-	-	-
5	Check: Does the test result of generic test procedure in TS 36.508 Table 6.4.2.7A-2 indicate that the UE is camped on E-UTRAN Cell 2?	-	-	1	-
6	The SS changes Cell 1, Cell 2, Cell 24 and Cell 25 levels according to row "T2" in table 6.4.7.3.2-1 and table 6.4.7.3.2-2.	-	-	-	-
7-17	Steps 1 to 11 of the Routing Area Update procedure described in TS 36.508 subclause 6.4.2.9 are performed on Cell 25. NOTE: The UE performs RAU and the RR connection is released.	-	-	-	-
18	The SS changes Cell 1, Cell 24 and Cell 25 levels according to row "T3" in table 6.4.7.3.2-1 and table 6.4.7.3.2-2.	-	-	-	-
19-29	Steps 1 to 11 of the Routing Area Update procedure described in TS 36.508 subclause 6.4.2.9 are performed on Cell 24. NOTE: The UE performs RAU and the RR connection is released.	-	-	-	-
30	The SS changes Cell 1, Cell 2 and Cell 25 level according to row "T4" in table 6.4.7.3.2-1 and table 6.4.7.3.2-2.	-	-	-	-
31	Check: Does the test result of generic test procedure in TS 36.508 Table 6.4.2.7A-1 indicate that the UE is camped on E-UTRAN Cell 2 within 6 mins?	-	-	2	-

6.4.7.3.3 Specific message contents

Table 6.4.7.3.3-1: *SystemInformationBlockType1* for Cell 2 (preamble and all steps, Table 6.4.7.3.2-3)

Derivation Path: 36.508 Table 4.4.3.2-3			
Information Element	Value/remark	Comment	Condition
SystemInformationBlockType1 ::= SEQUENCE {			
csg-Indication	FALSE		
csg-Identity	'000 0000 0000 0000 0000 0000 0001'B		
}			

Table 6.4.7.3.3-2: *SystemInformationBlockType4* for Cell 2 (preamble and all steps, Table 6.4.7.3.2-3)

Derivation Path: 36.508 Table 4.4.3.3-3			
Information Element	Value/remark	Comment	Condition
csg-PhysCellIdRange			
Start	4		
Range	Not present		
}			

Table 6.4.7.3.3-3: SYSTEM INFORMATION TYPE 2 Quarter for Cell 24 and Cell 25 (Pre-test conditions and all steps, Table 6.4.7.3.2-3)

Derivation Path: 36.508 clause 4.4.5, Table 4.4.5-1			
Information Element	Value/remark	Comment	Condition
SI 2QUATER REST OCTETS			
Additions in release 8	H		
Priority and E-UTRAN Parameters Description	1	Present	
Serving Cell Priority Parameters Description	1	Present	
GERAN_PRIORITY	5	Higher priority than E-UTRA	

Table 6.4.7.3.3-4: SystemInformationBlockType7 for Cell 1 and Cell 2 (Pre-test conditions and all steps, Table 6.4.7.3.2-3)

Derivation Path: 36.508 table 4.4.3.3-6			
Information Element	Value/remark	Comment	Condition
SystemInformationBlockType7 ::= SEQUENCE {			
t-ReselectionGERAN	7	INTEGER (0..7)	
speedDependentScalingParameters SEQUENCE {	Not present		
carrierFreqsInfoList SEQUENCE (SIZE (1..maxGNFG)) OF SEQUENCE {			
carrierFreqsGERAN SEQUENCE [1] {			
startingARFCN	Same as cell 24		
bandIndicator	Same as cell 24		
followingARFCNs CHOICE {			
equallySpacedARFCNs SEQUENCE {			
arfcn-Spacing	Same as cell 24		
numberOfFollowingARFCNs	Same as cell 24		
}			
}			
commonInfo SEQUENCE {			
cellReselectionPriority	5	Greater than EUTRA Freq	
ncc-Permitted	'1111111'B		
}			
carrierFreqsGERAN SEQUENCE [2] {			
startingARFCN	Same as cell 25		
bandIndicator	Same as cell 25		
followingARFCNs CHOICE {			
equallySpacedARFCNs SEQUENCE {			
arfcn-Spacing	Same as cell 25		
numberOfFollowingARFCNs	Same as cell 25		
}			
}			
commonInfo SEQUENCE {			
cellReselectionPriority	5	Greater than EUTRA Freq	
ncc-Permitted	'1111111'B		
}			
}			
}			

7 Layer 2

For all layer 2 test cases, default values for periodicBSR-Timer, retxBSR-Timer and phr-Config shall be taken according to the condition no_periodic_BSR_or_PHR as specified in TS 36.508 subclause 4.8.2.1.5 unless test case specific values are given in the test case.

In all MAC and RLC handover test cases during the execution of generic test procedure defined in [18] section 4.5.3A following specific message content should be used for RRC Connection Reconfiguration message transmitted at step 8 of the table 4.5.3.3-1 [18]

Table 7-1: PDCP-Config-DRB-AM

Information Element	Value/remark	Comment	Condition
PDCP-Config-DRB-AM ::= SEQUENCE {			
rlc-AM SEQUENCE {			
statusReportRequired	FALSE		
}			
}			

7.1 MAC

7.1.1 Mapping between logical channels and transport channels

7.1.1.1 CCCH mapped to UL SCH/ DL-SCH / Reserved Logical Channel ID

7.1.1.1.1 Test Purpose (TP)

(1)

```
with { UE in E-UTRA RRC_IDLE state and after transmitting a RRCConnectionRequest message }
ensure that {
  when { UE receives a MAC PDU on DL SCH and addressed to its T-CRNTI but including a reserved value
for LCID }
  then { UE discards the MAC PDU }
}
```

(2)

```
with { UE in E-UTRA RRC_IDLE state and after transmitting a RRCConnectionRequest message }
ensure that {
  when { UE receives a MAC PDU on DL SCH and addressed to its T-CRNTI with value '00000'B as LCID }
  then { UE forwards to upper layers the disassembled and demultiplexed SDU on logical channel
CCCH }
}
```

7.1.1.1.2 Conformance requirements

References: The conformance requirements covered in the current TC are specified in: TS 36.321, clause 5.11, 6.2.1 , 5.3.3 and 6.1.2.

[TS 36.321, clause 5.11]

When a MAC entity receives a MAC PDU for the UE's C-RNTI or Semi-Persistent Scheduling C-RNTI, containing reserved or invalid values, the MAC entity shall:

- discard the received PDU.

[TS 36.321, clause 6.2.1]

The MAC header is of variable size and consists of the following fields:

- LCID: The Logical Channel ID field identifies the logical channel instance of the corresponding MAC SDU or the type of the corresponding MAC control element or padding as described in tables 6.2.1-1 and 6.2.1-2 for the DL and UL-SCH respectively. There is one LCID field for each MAC SDU, MAC control element or padding included in the MAC PDU. The LCID field size is 5 bits;

...

Table 6.2.1-1: Values of LCID for DL-SCH

Index	LCID values
00000	CCCH
00001-01010	Identity of the logical channel
01011-11011	Reserved
11100	UE Contention Resolution Identity
11101	Timing Advance
11110	DRX Command
11111	Padding

[TS 36.321, clause 5.3.3]

The UE shall disassemble and demultiplex a MAC PDU as defined in subclause 6.1.2.

[TS 36.321, clause 6.1.2]

A MAC PDU consists of a MAC header, zero or more MAC Service Data Units (MAC SDU), zero, or more MAC control elements, and optionally padding; as described in Figure 6.1.2-3.

Both the MAC header and the MAC SDUs are of variable sizes.

A MAC PDU header consists of one or more MAC PDU sub-headers; each subheader corresponds to either a MAC SDU, a MAC control element or padding.

A MAC PDU subheader consists of the six header fields R/R/E/LCID/F/L but for the last subheader in the MAC PDU and for fixed sized MAC control elements. The last subheader in the MAC PDU and sub-headers for fixed sized MAC control elements consist solely of the four header fields R/R/E/LCID. A MAC PDU subheader corresponding to padding consists of the four header fields R/R/E/LCID.

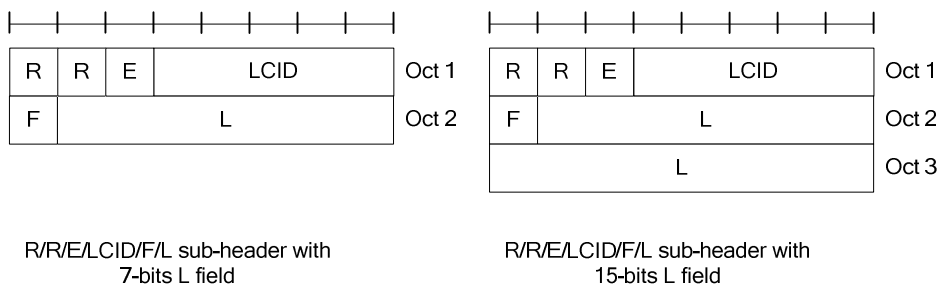
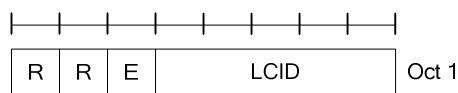

Figure 6.1.2-1: R/R/E/LCID/F/L MAC subheader



R/R/E/LCID sub-header

Figure 6.1.2-2: R/R/E/LCID MAC subheader

MAC PDU sub-headers have the same order as the corresponding MAC SDUs, MAC control elements and padding.

MAC control elements, are always placed before any MAC SDU.

Padding occurs at the end of the MAC PDU, except when single-byte or two-byte padding is required. Padding may have any value and the UE shall ignore it.

When single-byte or two-byte padding is required, one or two MAC PDU sub-headers corresponding to padding are placed at the beginning of the MAC PDU before any other MAC PDU subheader.

A maximum of one MAC PDU can be transmitted per TB per UE.

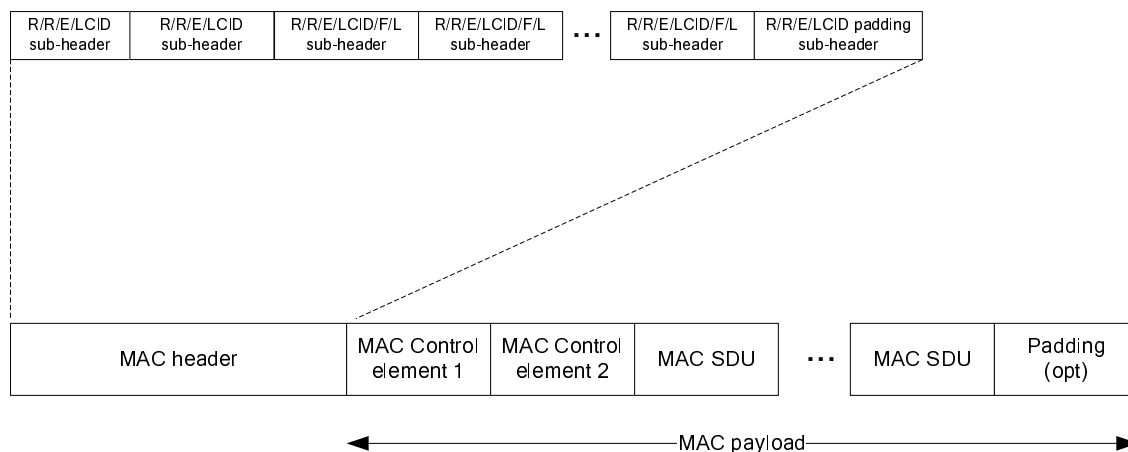

Figure 6.1.2-3: Example of MAC PDU consisting of MAC header, MAC control elements, MAC SDUs and padding

7.1.1.1.3 Test description

7.1.1.1.3.1 Pre-test conditions

System Simulator:

- Cell 1

UE:

None.

Preamble:

- The UE is in state Registered, Idle mode (state 2) according to [18].

7.1.1.1.3.2 Test procedure sequence

Table 7.1.1.1.3.2-1: Main behaviour

St	Procedure	Message Sequence		TP	Verdict
		U - S	Message		
	EXCEPTION: Steps 1 to 4 shall be repeated for decreasing reserved LCID values from 01011 to 11011.	-	-	-	-
1	The SS transmits a <i>Paging</i> message including a matched identity.	<--	-	-	-
2	The UE transmits an <i>RRCCoNNECTIONRequest</i> message.	-->	-	-	-
3	The SS Transmits a valid MAC PDU containing <i>RRCCoNNECTIONSetup</i> , and Contention Resolution Identity MAC Control Element except for LCID in MAC Header set to reserved value 11011 or lower (depending on iteration number).	<--	MAC PDU	-	-
	EXCEPTION: In parallel with step 4, UE may execute parallel behaviour defined in table 7.1.1.1.3.2-2	-	-	-	-
4	Check: For 5 seconds after Step3, does the UE transmit <i>RRCCoNNECTIONSetupComplete</i> message?	-->	<i>RRCCoNNECTIONSetupComplete</i>	1	F
5	The SS transmits a <i>Paging</i> message including a matched identity.	<--	-	-	-
6	The UE transmits an <i>RRCCoNNECTIONRequest</i> message.	-->	-	-	-
7	The SS transmits a valid MAC PDU containing <i>RRCCoNNECTIONSetup</i> , and Contention Resolution Identity MAC Control Element and LCID in MAC Header set correctly to CCCH 00000	<--	MAC PDU	-	-
8	Check: does the UE transmit an <i>RRCCoNNECTIONSetupComplete</i> message including SERVICE REQUEST message?	-->	<i>RRCCoNNECTIONSetupComplete</i>	2	P
9-12	Steps 6 to 9 of the generic radio bearer establishment procedure (TS 36.508 4.5.3.3-1) are executed to successfully complete the service request procedure.	-	-	-	-

Table 7.1.1.1.3.2-2: Parallel behaviour

St	Procedure	Message Sequence		TP	Verdict
		U - S	Message		
1	The UE transmits an <i>RRCCoNNECTIONRequest</i> message.	-->	-	-	-

7.1.1.1.3.3 Specific message contents

None.

7.1.1.2 DTCH or DCCH mapped to UL SCH/ DL-SCH / Reserved Logical Channel ID

7.1.1.2.1 Test Purpose (TP)

(1)

```

with { UE in E-UTRA RRC_Connected state with DRB [Logical channel ID 3] established }
ensure that {
  when { UE receives a MAC PDU on DL SCH and addressed to its CRNTI but including a reserved value for LCID }
  then { UE shall not forward the disassembled and demultiplexed SDU on the configured logical channels }
}

```

(2)

```

with { UE in E-UTRA RRC_IDLE state and after transmitting a RRCConnectionRequest message }
ensure that {
  when { UE receives a MAC PDU on DL SCH and addressed to its CRNTI with value '00011'B as LCID }
  then { UE shall forward the disassembled and demultiplexed SDU on the corresponding logical
channel }
}

```

7.1.1.2.2 Conformance requirements

References: The conformance requirements covered in the current TC are specified in: TS 36.321, clause 6.2.1, 5.3.3 and 6.1.2.

[TS 36.321, clause 6.2.1]

[Rel-8]

The MAC header is of variable size and consists of the following fields:

- LCID: The Logical Channel ID field identifies the logical channel instance of the corresponding MAC SDU or the type of the corresponding MAC control element or padding as described in tables 6.2.1-1 and 6.2.1-2 for the DL and UL-SCH respectively. There is one LCID field for each MAC SDU, MAC control element or padding included in the MAC PDU. The LCID field size is 5 bits;

...

Table 6.2.1-1: Values of LCID for DL-SCH

Index	LCID values
00000	CCCH
00001-01010	Identity of the logical channel
01011-11011	Reserved
11100	UE Contention Resolution Identity
11101	Timing Advance
11110	DRX Command
11111	Padding

[Rel-10]

The MAC header is of variable size and consists of the following fields:

- LCID: The Logical Channel ID field identifies the logical channel instance of the corresponding MAC SDU or the type of the corresponding MAC control element or padding as described in tables 6.2.1-1, 6.2.1-2 and 6.2.1-4 for the DL-SCH, UL-SCH and MCH respectively. There is one LCID field for each MAC SDU, MAC control element or padding included in the MAC PDU. In addition to that, one or two additional LCID fields are included in the MAC PDU, when single-byte or two-byte padding is required but cannot be achieved by padding at the end of the MAC PDU. The LCID field size is 5 bits;

...

Table 6.2.1-1 Values of LCID for DL-SCH

Index	LCID values
00000	CCCH
00001-01010	Identity of the logical channel
01011-11010	Reserved
11011	Activation/Deactivation
11100	UE Contention Resolution Identity
11101	Timing Advance Command
11110	DRX Command
11111	Padding

[TS 36.321, clause 5.3.3]

The UE shall disassemble and demultiplex a MAC PDU as defined in subclause 6.1.2.

[TS 36.321, clause 6.1.2]

A MAC PDU consists of a MAC header, zero or more MAC Service Data Units (MAC SDU), zero, or more MAC control elements, and optionally padding; as described in Figure 6.1.2-3.

Both the MAC header and the MAC SDUs are of variable sizes.

A MAC PDU header consists of one or more MAC PDU sub-headers; each subheader corresponds to either a MAC SDU, a MAC control element or padding.

A MAC PDU subheader consists of the six header fields R/R/E/LCID/F/L but for the last subheader in the MAC PDU and for fixed sized MAC control elements. The last subheader in the MAC PDU and sub-headers for fixed sized MAC control elements consist solely of the four header fields R/R/E/LCID. A MAC PDU subheader corresponding to padding consists of the four header fields R/R/E/LCID.

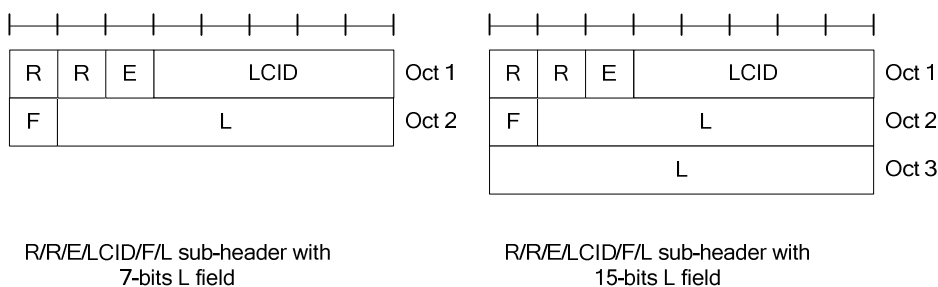

Figure 6.1.2-1: R/R/E/LCID/F/L MAC subheader

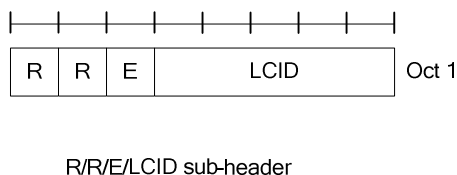

Figure 6.1.2-2: R/R/E/LCID MAC subheader

MAC PDU sub-headers have the same order as the corresponding MAC SDUs, MAC control elements and padding.

MAC control elements, are always placed before any MAC SDU.

Padding occurs at the end of the MAC PDU, except when single-byte or two-byte padding is required. Padding may have any value and the UE shall ignore it.

When single-byte or two-byte padding is required, one or two MAC PDU sub-headers corresponding to padding are placed at the beginning of the MAC PDU before any other MAC PDU subheader.

A maximum of one MAC PDU can be transmitted per TB per UE.

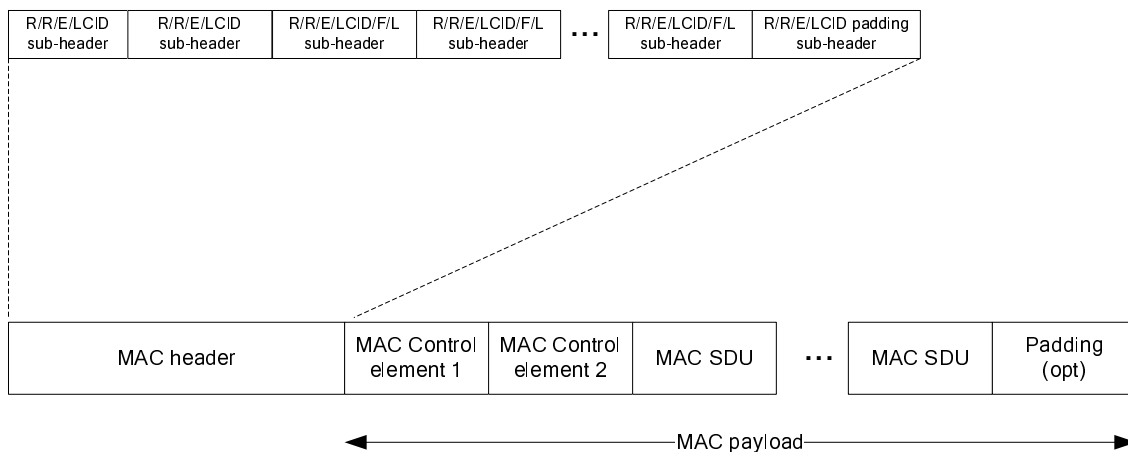

Figure 6.1.2-3: Example of MAC PDU consisting of MAC header, MAC control elements, MAC SDUs and padding

7.1.1.2.3 Test description

7.1.1.2.3.1 Pre-test conditions

System Simulator:

- Cell 1

UE:

None.

Preamble:

- The UE is in state Loopback Activated (state 4) according to [18].

NOTE: In the following, the established DRB is assumed to have Logical channel ID 3

7.1.1.2.3.2 Test procedure sequence

Table 7.1.1.2.3.2-1: Main behaviour

St	Procedure	Message Sequence		TP	Verdict
		U - S	Message		
	EXCEPTION: IF UE is Release 8 or Release 9, steps 1 and 2 are repeated for decreasing reserved LCID values from 01011 to 11011 ELSE IF UE is Release 10 onwards, steps 1 and 2 are repeated for decreasing reserved LCID values from 01011 to 11010.	-	-	-	-
1	The SS transmits a valid MAC PDU containing a RLC PDU except for LCID in MAC Header set to reserved value .	<--	MAC PDU	-	-
2	Check: does the UE transmit a Scheduling Request on PUCCH within 5 seconds after step 1?	-->	(SR)	1	F
3	The SS Transmits a valid MAC PDU containing RLC PDU with LCID in MAC Header set correctly to DRB 00011.	<--	MAC PDU	-	-
4	Check: does the UE transmit a Scheduling Request on PUCCH?	-->	(SR)	2	P
5	The SS sends an UL grant suitable for the loop back PDU to transmitted	<--	(UL Grant)	-	-
6	Check: does the UE transmit a MAC PDU with LCID set to DRB 00011?	-->	MAC PDU	2	P

7.1.1.2.3.3 Specific message contents

None.

7.1.2 RACH

7.1.2.1 Correct selection of RACH parameters / Random access preamble and PRACH resource explicitly signalled to the UE by RRC / Non-contention based random access procedure

7.1.2.1.1 Test Purpose (TP)

(1)

```
with { UE in E-UTRA RRC_CONNECTED state }
ensure that {
  when { SS sends an RRCConnectionReconfiguration message including RACH-ConfigDedicated information element }
  then { UE sends a prach preamble given in the RACH-ConfigDedicated on the target cell }
}
```

7.1.2.1.2 Conformance requirements

References: The conformance requirements covered in the current TC are specified in: TS 36.321, clauses 5.1.2 and 5.1.4.

[TS 36.321, clause 5.1.2]

The Random Access Resource selection procedure shall be performed as follows:

- If *ra-PreambleIndex* (Random Access Preamble) and *ra-PRACH-MaskIndex* (PRACH Mask Index) have been explicitly signalled and *ra-PreambleIndex* is not 000000:
 - the Random Access Preamble and the PRACH Mask Index are those explicitly signalled.

[TS 36.321, clause 5.1.4]

Once the Random Access Preamble is transmitted and regardless of the possible occurrence of a measurement gap, the UE shall monitor the PDCCH for Random Access Response(s) identified by the RA-RNTI defined below, in the RA Response window which starts at the subframe that contains the end of the preamble transmission [7] plus three subframes and has length *ra-ResponseWindowSize* subframes. The RA-RNTI associated with the PRACH in which the Random Access Preamble is transmitted, is computed as:

$$\text{RA-RNTI} = 1 + t_id + 10 * f_id$$

Where *t_id* is the index of the first subframe of the specified PRACH ($0 \leq t_id < 10$), and *f_id* is the index of the specified PRACH within that subframe, in ascending order of frequency domain ($0 \leq f_id < 6$). The UE may stop monitoring for Random Access Response(s) after successful reception of a Random Access Response containing Random Access Preamble identifiers that matches the transmitted Random Access Preamble.

- If a downlink assignment for this TTI has been received on the PDCCH for the RA-RNTI and the received TB is successfully decoded, the UE shall regardless of the possible occurrence of a measurement gap:

...

- if the Random Access Response contains a Random Access Preamble identifier corresponding to the transmitted Random Access Preamble (see subclause 5.1.3), the UE shall:
 - consider this Random Access Response reception successful;
 - process the received Timing Advance Command (see subclause 5.2);
 - indicate the *preambleInitialReceivedTargetPower* and the amount of power ramping applied to the latest preamble transmission to lower layers (i.e., $(\text{PREAMBLE_TRANSMISSION_COUNTER} - 1) * \text{powerRampingStep}$);
 - process the received UL grant value and indicate it to the lower layers;
 - if *ra-PreambleIndex* was explicitly signalled and it was not 000000 (i.e., not selected by MAC):
 - consider the Random Access procedure successfully completed.

7.1.2.1.3 Test description

7.1.2.1.3.1 Pre-test conditions

System Simulator:

- Cell 1 and Cell 2.

UE:

None.

Preamble:

- UE is in state Generic RB Established (state 3) according to [18] in cell 1.

7.1.2.1.3.2 Test procedure sequence

Table 7.1.2.1.3.2-1 illustrates the downlink power levels and other changing parameters to be applied for the cells at various time instants of the test execution. Row marked "T0" denotes the initial conditions after preamble, while columns marked "T1" is to be applied subsequently. The exact instants on which these values shall be applied are described in the texts in this clause.

Table 7.1.2.1.3.2-1: Time instances of cell power level and parameter changes

	Parameter	Unit	Cell 1	Cell 2	Remark
T0	Cell-specific RS EPRE	dBm/15k Hz	-85	-91	The power level values are such that measurement results for Cell 1 (M1) and Cell 2 (M2) satisfy exit condition for event A3 ($M2 < M1$).
T1	Cell-specific RS EPRE	dBm/15k Hz	-85	-79	The power level values are such that measurement results for Cell 1 (M1) and Cell 2 (M2) satisfy entry condition for event A3 ($M2 > M1$).

Table 7.1.2.1.3.2-2: Main behaviour

St	Procedure	Message Sequence		TP	Verdict
		U - S	Message		
0A	The SS transmits an <i>RRConnectionReconfiguration</i> message on Cell 1 to setup intra frequency measurement.	-	-	-	-
0B	The UE transmits an <i>RRConnectionReconfigurationComplete</i> message on Cell 1.	-	-	-	-
0C	The SS changes Cell 1 and Cell 2 parameters according to the row "T1" in table 7.1.2.1.3.2-1.	-	-	-	-
0D	The UE transmits a <i>MeasurementReport</i> message on Cell 1 to report event A3 with the measured RSRP, RSRQ value for Cell 2.	-	-	-	-
1	The SS transmits an <i>RRConnectionReconfiguration</i> message to order the UE to perform intra frequency handover to Cell 2, including explicit Random Access Preamble.	-	-	-	-
2	Check: Does the UE transmit Preamble on PRACH corresponding to <i>ra-PreambleIndex</i> in step 1?	-->	(PRACH Preamble)	1	P
3	The SS transmits Random Access Response on cell 2, with RAPID corresponding to <i>ra-PreambleIndex</i> in step 1	<--	Random Access Response	-	-
4	Check: Does the UE sends on cell 2, a MAC PDU containing <i>RRConnectionReconfigurationComplete</i> ?	-->	MAC PDU (<i>RRConnectionReconfigurationComplete</i>)	1	P
5	Check: Does the test result of generic procedure in TS 36.508 subclause 6.4.2.3 indicates that UE is in E-UTRA RRC_CONNECTED state in cell 2?	-	-	1	-

7.1.2.1.3.3 Specific message contents

Table 7.1.2.1.3.3-1: RRCConnectionReconfiguration (step 1, table 7.1.2.1.3.2-1)

Derivation Path: 36.508, Table 4.6.1-8, condition RBC-HO			
Information Element	Value/Remark	Comment	Condition
RRCConnectionReconfiguration ::= SEQUENCE {			
criticalExtensions CHOICE {			
c1 CHOICE{			
rrcConnectionReconfiguration-r8 SEQUENCE {			
mobilityControlInfo SEQUENCE {	MobilityControlInfo-HO		
targetPhysCellId	PhysicalCellIdentity of Cell 2 (see 36.508 clause 4.4.4.2)		
carrierFreq	Not present		
rach-ConfigDedicated SEQUENCE {			
ra-PreambleIndex	52 (see TS 36.211 Table 5.7.1-2)		FDD
ra-PreambleIndex	52 (see TS 36.211 Table 5.7.1-3)		TDD
ra-PRACH-MaskIndex	0	All	
}			
}			
}			
}			
}			
}			

7.1.2.2 Correct selection of RACH parameters / Random access preamble and PRACH resource explicitly signalled to the UE in PDCCH Order / Non-contention based random access procedure

7.1.2.2.1 Test Purpose (TP)

(1)

```
with { UE in E-UTRA RRC_CONNECTED state }
ensure that {
  when { PDCCH control command is received providing Random Access Preamble }
  then { UE sends a prach preamble given in the PDCCH Order }
}
```

(2)

```
with { UE in E-UTRA RRC_CONNECTED state and transmitted PRACH Preamble, after reception of PDCCH order }
ensure that {
  when { UE does not receive a matching Random Access response in ra-ResponseWindowSize (hence considers RACH attempt as failed) and PREAMBLE_TRANSMISSION_COUNTER is less than PREAMBLE_TRANS_MAX }
  then { UE retransmits the Preamble given in the PDCCH Order }
}
```

7.1.2.2.2 Conformance requirements

References: The conformance requirements covered in the current TC are specified in: TS 36.321, clauses 5.1.2 and 5.1.24.

[TS 36.321, clause 5.1.2]

The Random Access Resource selection procedure shall be performed as follows:

- If *ra-PreambleIndex* (Random Access Preamble) and *ra-PRACH-MaskIndex* (PRACH Mask Index) have been explicitly signalled and *ra-PreambleIndex* is not 000000:
- the Random Access Preamble and the PRACH Mask Index are those explicitly signalled.

[TS 36.321, clause 5.1.4]

Once the Random Access Preamble is transmitted and regardless of the possible occurrence of a measurement gap, the UE shall monitor the PDCCH for Random Access Response(s) identified by the RA-RNTI defined below, in the RA Response window which starts at the subframe that contains the end of the preamble transmission [7] plus three subframes and has length *ra-ResponseWindowSize* subframes. The RA-RNTI associated with the PRACH in which the Random Access Preamble is transmitted, is computed as:

$$\text{RA-RNTI} = 1 + t_id + 10 * f_id$$

Where *t_id* is the index of the first subframe of the specified PRACH ($0 \leq t_id < 10$), and *f_id* is the index of the specified PRACH within that subframe, in ascending order of frequency domain ($0 \leq f_id < 6$). The UE may stop monitoring for Random Access Response(s) after successful reception of a Random Access Response containing the Random Access Preamble identifiers that matches the transmitted Random Access Preamble.

- If a downlink assignment for this TTI has been received on the PDCCH for the RA-RNTI and the received TB is successfully decoded, the UE shall regardless of the possible occurrence of a measurement gap:

...

- if the Random Access Response contains a Random Access Preamble identifier corresponding to the transmitted Random Access Preamble (see subclause 5.1.3), the UE shall:
 - consider this Random Access Response reception successful;
 - process the received Timing Advance Command (see subclause 5.2);
 - indicate the *preambleInitialReceivedTargetPower* and the amount of power ramping applied to the latest preamble transmission to lower layers (i.e., $(\text{PREAMBLE_TRANSMISSION_COUNTER} - 1) * \text{powerRampingStep}$);
 - process the received UL grant value and indicate it to the lower layers;
 - if *ra-PreambleIndex* was explicitly signalled and it was not 000000 (i.e., not selected by MAC):
 - consider the Random Access procedure successfully completed.

...

If no Random Access Response is received within the RA Response window, or if none of all received Random Access Responses contains a Random Access Preamble identifier corresponding to the transmitted Random Access Preamble, the Random Access Response reception is considered not successful and the UE shall:

- increment *PREAMBLE_TRANSMISSION_COUNTER* by 1;
- If *PREAMBLE_TRANSMISSION_COUNTER* = *preambleTransMax* + 1:
 - indicate a Random Access problem to upper layers
 - if in this Random Access procedure, the Random Access Preamble was selected by MAC:
 - based on the back off parameter in the UE, select a random back off time according to a uniform distribution between 0 and the Back off Parameter Value;
 - delay the subsequent Random Access transmission by the back off time;
 - proceed to the selection of a Random Access Resource (see subclause 5.1.2).

7.1.2.2.3 Test description

7.1.2.2.3.1 Pre-test conditions

System Simulator:

- Cell 1

UE:

None.

Preamble:

- The UE is in state Generic RB Established (state 3) according to [18] in cell 1

7.1.2.2.3.2 Test procedure sequence

Table 7.1.2.2.3.2-1: Main behaviour

St	Procedure	Message Sequence		TP	Verdict
		U - S	Message		
1	The SS transmits a PDCCH order providing Random Access Preamble.	<--	(PDCCH Order)	-	-
2	Check: does the UE transmit a preamble on PRACH using the same preamble index as given in step 1?	-->	(PRACH Preamble)	1	P
3	Check: does the UE transmit a preamble on PRACH after <i>ra-ResponseWindowSize</i> using the same preamble index as given in step 1?	-->	(PRACH Preamble)	2	P
4	Check: does the UE transmit a preamble on PRACH after <i>ra-ResponseWindowSize</i> using the same preamble index as given in step 1?	-->	(PRACH Preamble)	2	P
5	Check: does the UE transmit a preamble on PRACH after <i>ra-ResponseWindowSize</i> using the same preamble index as given in step 1?	-->	(PRACH Preamble)	2	P
6	The SS transmits Random Access Response with RAPID corresponding to Preamble in step 1.	<--	Random Access Response	-	-
7	Check: does the test result of CALL generic procedure indicate that UE is in E-UTRA RRC_CONNECTED state?	-	-	2	-

7.1.2.2.3.3 Specific message contents

Table 7.1.2.2.3.3-1: SystemInformationBlockType2 (all steps, table 7.1.2.2.3.2-1)

Derivation Path: 36.508 clause 4.4.3.3, Table Nr. 4.4.3.3.-1			
Information Element	Value/Remark	Comment	Condition
SystemInformationBlockType2 ::= SEQUENCE {			
radioResourceConfigCommon SEQUENCE {			
rach-Configuration SEQUENCE {			
ra-SupervisionInformation SEQUENCE {			
preambleTransMax	N4	PREAMBLE_TRANS_MAX	
}			
}			
}			
}			

7.1.2.3 Correct selection of RACH parameters / Preamble selected by MAC itself / Contention based random access procedure

7.1.2.3.1 Test Purpose (TP)

(1)

```
with { UE in E-UTRA RRC_IDLE state }
ensure that {
  when { SS sends a Paging message to the UE and MAC PDU Size carrying CCCH PDU is less than
messageSizeGroupA }
  then { UE transmits a random access preamble using a preamble in group A of random access
preambles indicated in SIB2 }
```



```

    }

```

(2)

```

with { UE in E-UTRA RRC_IDLE state and has transmitted Msg3 }
ensure that {
  when { SS does not respond before contention resolution timer expiry }
  then { UE transmits a random access preamble using a preamble in the same group of random access
preambles as used for the first transmission of Msg3 }
}

```

(3)

```

with { UE in E-UTRA RRC_IDLE state and has transmitted Msg3 }
ensure that {
  when { SS does not respond before contention resolution timer expiry after more than
preambleTransMax transmissions from UE }
  then { UE transmits a random access preamble using a preamble in the same group of random access
preambles as used for the first transmission of Msg3 }
}

```

(4)

```

with { UE in E-UTRA RRC_IDLE state }
ensure that {
  when { UE has data available for transmission and the MAC PDU Size carrying this data is greater
than messageSizeGroupA }
  then { UE transmits a random access preamble using a preamble in group B of random access
preambles indicated in SIB2 }
}

```

7.1.2.3.2 Conformance requirements

References: The conformance requirements covered in the current TC are specified in: TS 36.321, clause 5.1.2 and 5.1.5.

[TS 36.321, clause 5.1.2]

The Random Access Resource selection procedure shall be performed as follows:

- If *ra-PreambleIndex* (*Random Access Preamble*) and *ra-PRACH-MaskIndex* (*PRACH Mask Index*) have been explicitly signalled and *ra-PreambleIndex* is not 000000:
 - ...
- else the Random Access Preamble shall be selected by the UE as follows:
 - If *Msg3* has not yet been transmitted, the UE shall:
 - if Random Access Preambles group B exists and if the potential message size (data available for transmission plus MAC header and, where required, MAC control elements) is greater than *messageSizeGroupA* and if the pathloss is less than $P_{\text{CMAX}} - \text{preambleInitialReceivedTargetPower} - \text{deltaPreambleMsg3} - \text{messagePowerOffsetGroupB}$, then:
 - select the Random Access Preambles group B;
 - else:
 - select the Random Access Preambles group A.
 - else, if *Msg3* is being retransmitted, the UE shall, the UE shall:
 - select the same group of Random Access Preambles as was used for the preamble transmission attempt corresponding to the first transmission of *Msg3*.
 - randomly select a Random Access Preamble within the selected group. The random function shall be such that each of the allowed selections can be chosen with equal probability;
 - set PRACH Mask Index to 0.

- determine the next available subframe containing PRACH permitted by the restrictions given by the *prach-ConfigIndex* and PRACH Mask Index (see subclause 7.3) and physical layer timing requirements [2] (a UE may take into account the possible occurrence of measurement gaps when determining the next available PRACH subframe);
- if the transmission mode is TDD and the PRACH Mask Index is equal to zero:
 - if *ra-PreambleIndex* was explicitly signalled and the signalled random access preamble ID was not 000000 (i.e., not selected by MAC):
 - randomly select, with equal probability, one PRACH from the PRACHs available in the determined subframe.
 - else:
 - randomly select, with equal probability, one PRACH from the PRACHs available in the determined subframe and the next two consecutive subframes.
- else:
 - determine a PRACH within the determined subframe in accordance with the requirements of the PRACH Mask Index.
- proceed to the transmission of the Random Access Preamble (see subclause 5.1.3).

[TS 36.321, clause 5.1.5]

Contention Resolution is based on either C-RNTI on PDCCH or UE Contention Resolution Identity on DL-SCH..

Once Msg3 is transmitted, the UE shall:

- start *mac-ContentionResolutionTimer* and restart *mac-ContentionResolutionTimer* at each HARQ retransmission;
- regardless of the possible occurrence of a measurement gap, monitor the PDCCH until *mac-ContentionResolutionTimer* expires or is stopped;
- ...
- if *mac-ContentionResolutionTimer* expires:
 - discard the Temporary C-RNTI;
 - consider the Contention Resolution not successful.
- if the Contention Resolution is considered not successful the UE shall:
 - flush the HARQ buffer used for transmission of the MAC PDU in the Msg3 buffer;
 - increment PREAMBLE_TRANSMISSION_COUNTER by 1;
 - If PREAMBLE_TRANSMISSION_COUNTER = *preambleTransMax* + 1:
 - indicate a Random Access problem to upper layers.
- ...
- proceed to the selection of a Random Access Resource (see subclause 5.1.2).

7.1.2.3.3 Test description

7.1.2.3.3.1 Pre-test conditions

System Simulator:

- Cell 1.
- System information set using parameters as specified in Table 7.1.2.3.3.3-1.

UE:

None.

Preamble:

- The UE is in state Registered, Idle mode, Test Mode Activated (State 2A) according to [18].

7.1.2.3.3.2 Test procedure sequence

Table 7.1.2.3.3.2-1: Main behaviour

St	Procedure	Message Sequence		TP	Verdict
		U - S	Message		
1	The SS transmits a Paging message including a matched identity.	-	-	-	-
2	Check: Does the UE transmit preamble on PRACH using a preamble in group A defined in SIB2 (<i>numberOfRA-Preambles</i> and <i>sizeOfRA-PreamblesGroupA</i>)?	-->	PRACH Preamble	1	P
3	Check: Does the UE transmit preamble on PRACH using a preamble in group A defined in SIB2 (<i>numberOfRA-Preambles</i> and <i>sizeOfRA-PreamblesGroupA</i>)?	-->	PRACH Preamble	1	P
4	Check: Does the UE transmit preamble on PRACH using a preamble in group A defined in SIB2 (<i>numberOfRA-Preambles</i> and <i>sizeOfRA-PreamblesGroupA</i>)?	-->	PRACH Preamble	1	P
5	The SS transmits Random Access Response with RAPID corresponding to the transmitted Preamble in step 4, including T-CRNTI and not including Back off Indicator sub header.	<--	Random Access Response	-	-
6	The UE transmits an <i>RRConnectionRequest</i> message.	-->	MAC PDU	-	-
7	Check: Does the UE transmit preamble on PRACH using a preamble belonging to group A?	-->	PRACH Preamble	2	P
8	Check: Does the UE continue to repeatedly transmit for 2s after step 2 a preamble belonging to group A? Note: 2s is the value of T300.	-->	PRACH Preamble	2, 3	P
9	The UE is in state Loopback Activated (state 4) according to [18] using parameters as specified in Table 7.1.2.3.3.3-2	-	-	-	-
10	The SS transmits a MAC PDU containing a PDCP SDU of size 320 bits[>208].	<--	MAC PDU	-	-
-	Exception: steps 11 and 12 are repeated <i>dsr-TransMax</i> times.	-	-	-	-
11	UE transmits a Scheduling Request.	-->	Scheduling Request	-	-
12	The SS does not allocate UL grant for the scheduling request in step 11.	-	-	-	-
13	Check: Does the UE transmit preamble on PRACH using a preamble in group B defined in SIB2 (<i>numberOfRA-Preambles</i> and <i>sizeOfRA-PreamblesGroupA</i>)?	-->	PRACH Preamble	4	P
14	Check: Does the UE transmit preamble on PRACH using a preamble in group B defined in SIB2 (<i>numberOfRA-Preambles</i> and <i>sizeOfRA-PreamblesGroupA</i>)?	-->	PRACH Preamble	4	P
15	Check: Does the UE transmit preamble on PRACH using a preamble in group B defined in SIB2 (<i>numberOfRA-Preambles</i> and <i>sizeOfRA-PreamblesGroupA</i>)?	-->	PRACH Preamble	4	P
16	The SS transmits Random Access Response with RAPID corresponding to the transmitted Preamble in step 15, including T-CRNTI and not including Back off Indicator sub header.	<--	Random Access Response	-	-
17	The UE transmits a MAC PDU with C-RNTI containing loop backed PDCP SDU	->	MAC PDU	-	-
18	The SS ignores the UL MAC PDU and does not allocate UL grant for the C-RNTI in step 17.	-	-	-	-
19	Check: Does the UE transmit preamble on PRACH using a preamble belonging to group B?	-->	PRACH Preamble	2	P

20	The SS transmits Random Access Response with RAPID corresponding to the transmitted Preamble in step 19	<--	Random Access Response	-	-
21	The UE transmits a MAC PDU containing loop backed PDCP SDU	-->	MAC PDU	-	-
22	SS sends PDCCH transmission for UE C-RNTI	-	-	-	-
Note: Size of RRCConnectionRequest message is 45 bits, octet aligned =48 bits. With 8 bits of MAC Header the minimum size of MAC PDU carrying RRCConnectionRequest is 56 bits.					

7.1.2.3.3.3 Specific message contents

Table 7.1.2.3.3.3-1: SystemInformationBlockType2 (all steps, table 7.1.2.3.3.2-1)

Derivation path: 36.508 clause 4.4.3.3, Table 4.4.3.3-1			
Information Element	Value/Remark	Comment	Condition
SystemInformationBlockType2 ::= SEQUENCE {			
radioResourceConfigCommon SEQUENCE {			
rach-Configuration SEQUENCE {			
preambleInformation SEQUENCE {			
numberOfRA-Preambles	n64		
preamblesGroupAConfig := {SEQUENCE {			
sizeOfRA-PreamblesGroupA	n28		
messageSizeGroupA	b208		
messagePowerOffsetGroupB	minusinfinity		
}			
}			
}			
}			
ue-TimersAndConstants SEQUENCE{			
t300	ms2000	T300	
}			
}			
}			
}			

Table 7.1.2.3.3.3-2: RLC-Config-DRB-AM

Derivation path: 36.508 clause 4.8.2.1.3.2, Table 4.8.2.1.3.2-1			
Information Element	Value/Remark	Comment	Condition
RLC-Config-DRB-AM ::= CHOICE {			
am SEQUENCE {			
ul-AM-RLC SEQUENCE {			
t-PollRetransmit	ms200		
}			
}			
}			

7.1.2.4 Random access procedure / Successful

7.1.2.4.1 Test Purpose (TP)

(1)

```
with { UE in E-UTRA RRC_IDLE state }
ensure that {
  when { The SS pages the UE with a matching identity }
  then { UE transmits a random access preamble in the next available Random Access occasion }
}
```

(2)

```
with { UE in E-UTRA RRC_IDLE state after transmission of a PRACH preamble }
ensure that {
  when { SS does not answer with a matching Random Access Response within ra-ResponseWindowSize }
```

```

    then { UE retransmits a PRACH preamble }
  }

```

(3)

```

with { SS transmits Random Access Response and UE send msg3 }
ensure that {
  when { SS ignores the RRCConnectionRequest and does not send any Response }
  then { UE select available PRACH resource to retransmits a PRACH preamble according to the
        timing requirement }
}

```

7.1.2.4.2 Conformance requirements

References: The conformance requirements covered in the current TC are specified in: TS 36.321, clause 5.1.2, 5.1.3 & 5.1.4.

[TS 36.321, clause 5.1.2]

The Random Access Resource selection procedure shall be performed as follows:

- If *ra-PreambleIndex* (Random Access Preamble) and *ra-PRACH-MaskIndex* (PRACH Mask Index) have been explicitly signalled and *ra-PreambleIndex* is not 000000:
 - the Random Access Preamble and the PRACH Mask Index are those explicitly signalled.
- else the Random Access Preamble shall be selected by the UE as follows:
 - If Msg3 has not yet been transmitted, the UE shall:
 - if Random Access Preambles group B exists and if the potential message size (data available for transmission plus MAC header and, where required, MAC control elements) is greater than *messageSizeGroupA* and if the pathloss is less than $P_{\text{CMAX}} - \text{preambleInitialReceivedTargetPower} - \text{deltaPreambleMsg3} - \text{messagePowerOffsetGroupB}$, then:
 - select the Random Access Preambles group B;
 - else:
 - select the Random Access Preambles group A.
 - else, if Msg3 is being retransmitted, the UE shall:
 - select the same group of Random Access Preambles as was used for the preamble transmission attempt corresponding to the first transmission of Msg3.
 - randomly select a Random Access Preamble within the selected group. The random function shall be such that each of the allowed selections can be chosen with equal probability;
 - set PRACH Mask Index to 0.
 - determine the next available subframe containing PRACH permitted by the restrictions given by the *prach-ConfigurationIndex* and the PRACH Mask Index (see subclause 7.3) (a UE may take into account the possible occurrence of measurement gaps when determining the next available PRACH subframe);
 - if the transmission mode is TDD and the PRACH Mask Index is equal to zero:
 - if *ra-PreambleIndex* was explicitly signalled and it was not 000000 (i.e., not selected by MAC):
 - randomly select, with equal probability, one PRACH from the PRACHs available in the determined subframe.
 - else:
 - randomly select, with equal probability, one PRACH from the PRACHs available in the determined subframe and the next two consecutive subframes.
 - else:

- determine a PRACH within the determined subframe in accordance with the requirements of the PRACH Mask Index.
- proceed to the transmission of the Random Access Preamble (see subclause 5.1.3).

[TS 36.321, clause 5.1.3]

The random-access procedure shall be performed as follows:

- set PREAMBLE_RECEIVED_TARGET_POWER to $preambleInitialReceivedTargetPower + DELTA_PREAMBLE + (PREAMBLE_TRANSMISSION_COUNTER - 1) * powerRampingStep$;
- instruct the physical layer to transmit a preamble using the selected PRACH, corresponding RA-RNTI, preamble index and PREAMBLE_RECEIVED_TARGET_POWER.

[TS 36.321, clause 5.1.4]

Once the Random Access Preamble is transmitted and regardless of the possible occurrence of a measurement gap, the UE shall monitor the PDCCH for Random Access Response(s) identified by the RA-RNTI defined below, in the RA Response window which starts at the subframe that contains the end of the preamble transmission [7] plus three subframes and has length $ra-ResponseWindowSize$ subframes. The RA-RNTI associated with the PRACH in which the Random Access Preamble is transmitted, is computed as:

$$RA-RNTI = t_{id} + f_{id} * 10$$

Where t_{id} is the index of the first subframe of the specified PRACH ($0 \leq t_{id} < 10$), and f_{id} is the index of the specified PRACH within that subframe, in ascending order of frequency domain ($0 \leq f_{id} < 6$). The UE may stop monitoring for Random Access Response(s) after successful reception of a Random Access Response containing Random Access Preamble identifiers that matches the transmitted Random Access Preamble.

- If a downlink assignment for this TTI has been received on the PDCCH for the RA-RNTI and the received TB is successfully decoded, the UE shall regardless of the possible occurrence of a measurement gap:
 - if the Random Access Response contains a Back off Indicator sub header:
 - set the back off parameter value in the UE as indicated by the BI field of the Back off Indicator sub header and Table 7.2-1.
 - else, set the back off parameter value in the UE to 0 ms.
- if the Random Access Response contains a Random Access Preamble identifier corresponding to the transmitted Random Access Preamble (see subclause 5.1.3), the UE shall:
 - consider this Random Access Response reception successful;
 - process the received Timing Advance Command (see subclause 5.2);
 - indicate the $preambleInitialReceivedTargetPower$ and the amount of power ramping applied to the latest preamble transmission to lower layers (i.e., $(PREAMBLE_TRANSMISSION_COUNTER - 1) * powerRampingStep$);
 - process the received UL grant value and indicate it to the lower layers;
 - if $ra-PreambleIndex$ was explicitly signalled and it was not 000000 (i.e., not selected by MAC):
 - consider the Random Access procedure successfully completed.
 - else, if the Random Access Preamble was selected by UE MAC:
 - set the Temporary C-RNTI to the value received in the Random Access Response message no later than at the time of the first transmission corresponding to the UL grant provided in the Random Access Response message;
 - if this is the first successfully received Random Access Response within this Random Access procedure:

- if the transmission is not being made for the CCCH logical channel, indicate to the Multiplexing and assembly entity to include a C-RNTI MAC control element in the subsequent uplink transmission;
- obtain the MAC PDU to transmit from the "Multiplexing and assembly" entity and store it in the Msg3 buffer.

NOTE: When an uplink transmission is required, e.g., for contention resolution, the eNB should not provide a grant smaller than 56 bits in the Random Access Response.

NOTE: If within a Random Access procedure, an uplink grant provided in the Random Access Response for the same group of Random Access Preambles has a different size than the first uplink grant allocated during that Random Access procedure, the UE behaviour is not defined.

If no Random Access Response is received within the RA Response window, or if none of all received Random Access Responses contains a Random Access Preamble identifier corresponding to the transmitted Random Access Preamble, the Random Access Response reception is considered not successful and the UE shall:

- increment PREAMBLE_TRANSMISSION_COUNTER by 1;
- If PREAMBLE_TRANSMISSION_COUNTER = *preambleTransMax* + 1:
 - indicate a Random Access problem to upper layers.

...

- proceed to the selection of a Random Access Resource (see subclause 5.1.2).

TS 36.321, clause 6.1.5

A MAC PDU consists of a MAC header and one or more MAC Random Access Responses (MAC RAR) and optionally padding as described in figure 6.1.5-4.

The MAC header is of variable size.

A MAC PDU header consists of one or more MAC PDU sub-headers; each subheader corresponding to a MAC RAR except for the Backoff Indicator sub-header. If included, the Back off Indicator sub-header is only included once and is the first sub-header included within the MAC PDU header.

A MAC RAR consists of the four fields R/Timing Advance Command/UL Grant/Temporary C-RNTI (as described in figure 6.1.5-3).

Padding may occur after the last MAC RAR. Presence and length of padding is implicit based on TB size, size of MAC header and number of RARs.

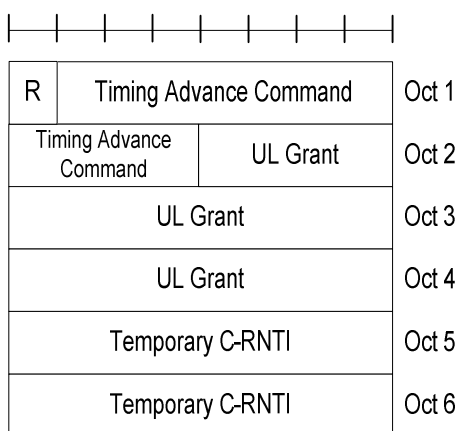

Figure 6.1.5-3: MAC RAR

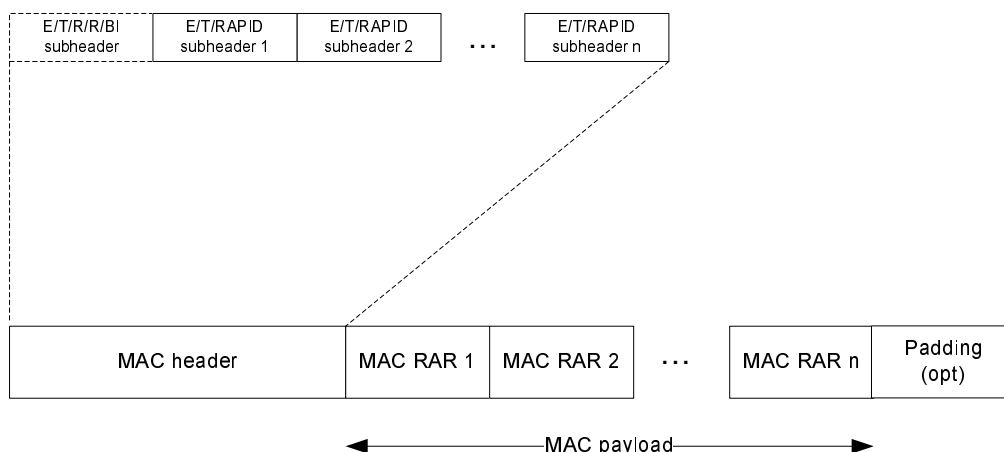

Figure 6.1.5-4: Example of MAC PDU consisting of a MAC header and MAC RARs

[TS 36.213, clause 6.1]

For the L1 random access procedure, UE's uplink transmission timing after a random access preamble transmission is as follows.

- a. If a PDCCH with associated RA-RNTI is detected in subframe n , and the corresponding DL-SCH transport block contains a response to the transmitted preamble sequence, the UE shall, according to the information in the response, transmit an UL-SCH transport block in the first subframe $n + k_1$, $k_1 \geq 6$, if the UL delay field in section 6.2 is set to zero. The UE shall postpone the PUSCH transmission to the next available UL subframe if the field is set to 1.

[TS 36.213, clause 6.2]

The higher layers indicate the 20-bit UL Grant to the physical layer, as defined in [8]. This is referred to the Random Access Response Grant in the physical layer. The content of these 20 bits starting with the MSB and ending with the LSB are as follows:

- Hopping flag – 1 bit
- Fixed size resource block assignment – 10 bits
- Truncated modulation and coding scheme – 4 bits
- TPC command for scheduled PUSCH – 3 bits
- UL delay – 1 bit
- CQI request – 1 bit

...

The UL delay applies for both TDD and FDD and this field can be set to 0 or 1 to indicate whether the delay of PUSCH is introduced as shown in section 6.1.1.

7.1.2.4.3.1 Pre-test conditions

System Simulator:

- Cell 1
- System information are set according to table 7.1.2.4.3.3-1

UE:

None.

Preamble:

- The UE is in state Registered, Idle mode (state 2) according to [18].

7.1.2.4.3.2 Test procedure sequence

Table 7.1.2.4.3.2-1: Main behaviour

St	Procedure	Message Sequence		TP	Verdict
		U - S	Message		
1	The SS transmits a Paging message including a matched identity.	-	-	-	-
2	Check: does the UE transmit a preamble on PRACH, in frame number X, subframe number 2, 5, 8 (FDD)/2,3,8(TDD)?	-->	PRACH Preamble	1	P
3	Check: does the UE transmit a preamble on PRACH, in frame number X+1 or X+2, subframe number 2, 5, 8 (FDD)/ 2,3,8 (TDD)?	-->	PRACH Preamble	1,2	P
4	Check: does the UE transmit a preamble on PRACH, in frame number X+2, X+3 or X+4, subframe number 2, 5, 8 (FDD)/ 2,3,8 (TDD)?	-->	PRACH Preamble	1,2	P
5	The SS transmits a Random Access Response with not-matching RA-Id, including T-CRNTI and not including Back off Indicator sub header.	<--	Random Access Response	-	-
6	Check: does the UE transmit a preamble on PRACH in frame number X+4, X+5 or X+6, subframe number 2, 5, 8 (FDD)/ 2,3,8 (TDD)?	-->	PRACH Preamble	1,2	P
7	The SS transmits Random Access Response with RAPID corresponding to the transmitted Preamble in step 6, including T-CRNTI and UL grant and not including Back off Indicator sub header. The UL delay bit in the UL grant field is set to 0	<--	Random Access Response	-	-
8	The UE transmits an <i>RRCCoNNECTIONRequest</i> message.	-->	-	-	-
9	The SS ignores the <i>RRCCoNNECTIONRequest</i> message and does not send any response.	-	-	-	-
10	UE waits for <i>mac-ContentResolutionTimer</i> expire.	-	-	-	-
11	Check: does the UE transmit preamble on PRACH using a preamble in subframe number 2,5,8 for FDD and subframe number 2,3 or 8 for TDD?	-->	PRACH Preamble	3	P
12	The SS transmits Random Access Response with RAPID corresponding to the transmitted Preamble in step 11, including T-CRNTI and not including Back off Indicator sub header.	<--	Random Access Response	-	-
13	The UE transmits an <i>RRCCoNNECTIONRequest</i> message.	-->	-	-	-
14	The SS Transmits a valid MAC PDU containing <i>RRCCoNNECTIONSetup</i> , and including 'UE Contention Resolution Identity' MAC control element with matching 'Contention Resolution Identity'	<--	MAC PDU	-	-
15	The UE transmits an <i>RRCCoNNECTIONSetupComplete</i> message.	-->	-	-	-
16-19	Steps 6 to 9 of the generic radio bearer establishment procedure (TS 36.508 4.5.3.3-1) are executed to successfully complete the service request procedure.	-	-	-	-

7.1.2.4.3.3 Specific message contents

Table 7.1.2.4.3.3-1: SystemInformationBlockType2 (all steps, table 7.1.2.4.3.2-1)

Derivation path: 36.508 table 4.4.3.3.-1			
Information Element	Value/Remark	Comment	Condition
SystemInformationBlockType2 ::= SEQUENCE {			
radioResourceConfigCommon SEQUENCE {			
rach-Configuration SEQUENCE {			
ra-SupervisionInformation SEQUENCE {			
mac-ContentionResolutionTimer	Sf48	Timer for contention resolution is 48 subframes	
ra-ResponseWindowSize	sf10		
}			
}			
prach-Configuration SEQUENCE {			
prach-ConfigInfo SEQUENCE {			
prach-ConfigurationIndex	10	As per table 5.7.1-2 of 36.211, this results in PRACH preamble transmission start in any frame numbers and sub-frame number 2, 5, 8	FDD
prach-ConfigurationIndex	9	As per table 5.7.1-4 of 36.211, this results in PRACH preamble transmission with frequency resource index=0; occurring in any radio frames; resource is located in sub frame number 2,3 ,8 Note 1	TDD
}			
}			
}			
}			
}			
Note 1: 36.508, Table 4.4.3.2-3 specifies tdd-Configuration-> subframeAssignment as sa1.			

7.1.2.5 Random access procedure / MAC PDU containing multiple RARs

7.1.2.5.1 Test Purpose (TP)

(1)

```

with { UE in E-UTRA RRC_IDLE state and transmitted PRACH preamble }
ensure that {

  when { UE receives during TTI window [RA_WINDOW_BEGIN-RA_WINDOW_END] MAC PDU containing multiple
RAR's but none of the subheaders contains a RAPID corresponding to the UE }
    then { UE transmits a random access preamble in the next available Random Access occasion }
}

```

(2)

```

with { UE in E-UTRA RRC_IDLE state and transmitted PRACH preamble }
ensure that {

  when { UE receives during TTI window [RA_WINDOW_BEGIN-RA_WINDOW_END] MAC PDU containing multiple
RAR's and one of the subheaders contains a RAPID corresponding to the UE }
}

```

```

then { UE transmits MAC PDU containing RRCConnectionRequest }
}

```

7.1.2.5.2 Conformance requirements

References: The conformance requirements covered in the current TC are specified in: TS 36.321, clause 5.1.3 and 5.1.4.

[TS 36.321, clause 5.1.3]

The random-access procedure shall be performed as follows:

- set PREAMBLE_RECEIVED_TARGET_POWER to $preambleInitialReceivedTargetPower + DELTA_PREAMBLE + (PREAMBLE_TRANSMISSION_COUNTER - 1) * powerRampingStep$;
- instruct the physical layer to transmit a preamble using the selected PRACH resource, corresponding RA-RNTI, preamble index and PREAMBLE_RECEIVED_TARGET_POWER.

[TS 36.321, clause 5.1.4]

Once the Random Access Preamble is transmitted and regardless of the possible occurrence of a measurement gap, the UE shall monitor the PDCCH for Random Access Response(s) identified by the RA-RNTI defined below, in the RA Response window which starts at the subframe that contains the end of the preamble transmission [7] plus three subframes and has length *ra-ResponseWindowSize* subframes. The RA-RNTI associated with the PRACH in which the Random Access Preamble is transmitted, is computed as:

$$RA-RNTI = 1 + t_id + 10 * f_id$$

Where *t_id* is the index of the first subframe of the specified PRACH ($0 \leq t_id < 10$), and *f_id* is the index of the specified PRACH within that subframe, in ascending order of frequency domain ($0 \leq f_id < 6$). The UE may stop monitoring for Random Access Response(s) after successful reception of a Random Access Response containing the Random Access Preamble identifiers that matches the transmitted Random Access Preamble.

- If a downlink assignment for this TTI has been received on the PDCCH for the RA-RNTI and the received TB is successfully decoded, the UE shall regardless of the possible occurrence of a measurement gap:
 - if the Random Access Response contains a Back off Indicator sub header:
 - set the back off parameter value in the UE as indicated by the BI field of the Back off Indicator sub header and Table 7.2-1.
 - else, set the back off parameter value in the UE to 0 ms.
- if the Random Access Response contains a Random Access Preamble identifier corresponding to the transmitted Random Access Preamble (see subclause 5.1.3), the UE shall:
 - consider this Random Access Response reception successful;
 - process the received Timing Advance Command (see subclause 5.2);
 - indicate the *preambleInitialReceivedTargetPower* and the amount of power ramping applied to the latest preamble transmission to lower layers (i.e., $(PREAMBLE_TRANSMISSION_COUNTER - 1) * powerRampingStep$);
 - process the received UL grant value and indicate it to the lower layers;
 - if *ra-PreambleIndex* was explicitly signalled and it was not 000000 (i.e., not selected by MAC):
 - consider the Random Access procedure successfully completed.
 - else, if the Random Access Preamble was selected by UE MAC:
 - set the Temporary C-RNTI to the value received in the Random Access Response message no later than at the time of the first transmission corresponding to the UL grant provided in the Random Access Response message;

- if this is the first successfully received Random Access Response within this Random Access procedure:
 - if the transmission is not being made for the CCCH logical channel, indicate to the Multiplexing and assembly entity to include a C-RNTI MAC control element in the subsequent uplink transmission;
 - obtain the MAC PDU to transmit from the "Multiplexing and assembly" entity and store it in the Msg3 buffer.

NOTE: When an uplink transmission is required, e.g., for contention resolution, the eNB should not provide a grant smaller than 56 bits in the Random Access Response.

NOTE: If within a Random Access procedure, an uplink grant provided in the Random Access Response for the same group of Random Access Preambles has a different size than the first uplink grant allocated during that Random Access procedure, the UE behaviour is not defined.

If no Random Access Response is received within the RA Response window, or if none of all received Random Access Responses contains a Random Access Preamble identifier corresponding to the transmitted Random Access Preamble, the Random Access Response reception is considered not successful and the UE shall:

- increment PREAMBLE_TRANSMISSION_COUNTER by 1;
- If PREAMBLE_TRANSMISSION_COUNTER = *preambleTransMax* + 1:
 - indicate a Random Access problem to upper layers.

...

- proceed to the selection of a Random Access Resource (see subclause 5.1.2).

7.1.2.5.3 Test description

7.1.2.5.3.1 Pre-test conditions

System Simulator:

- Cell 1

UE:

None.

Preamble:

- The UE is in state Registered, Idle mode (state 2) according to [18].

7.1.2.5.3.2 Test procedure sequence

Table 7.1.2.5.3.2-1: Main behaviour

St	Procedure	Message Sequence		TP	Verdict
		U - S	Message		
1	The SS transmits a Paging message including a matched identity.	<--	-	-	-
2	Check: Does the UE transmit a preamble on PRACH?	-->	PRACH Preamble	1	P
3	The SS transmits a MAC PDU addressed to UE RA-RNTI, containing multiple RAR's but none of the MAC sub headers contains a matching RAPID	<--	Random Access Response	-	-
-	EXCEPTION: In parallel with step 4, parallel behaviour defined in table 7.1.2.5.3.2-2 is executed	-	-	-	-
4	Check: Does the UE re-transmit a preamble on PRACH?	-->	PRACH Preamble	1	P
5	The SS transmits a MAC PDU addressed to UE RA-RNTI, containing multiple RAR's one of the MAC sub headers contains a matching RAPID	<--	Random Access Response	-	-
6	Check: Does the UE transmit a MAC PDU containing RRCConnectionRequest message?	-->	MAC PDU (RRCConnectionRequest)	2	P
7	The SS sends a MAC PDU containing matching Contention Resolution Identity MAC control element	<--	MAC Control PDU	-	-
7A	SS transmit RRCConnectionSetup message	<--	-	-	-
8	The UE transmit RRCConnectionSetupComplete message including SERVICE REQUEST message.	-->	-	-	-
9-12	Steps 6 to 9 of the generic radio bearer establishment procedure (TS 36.508 4.5.3.3-1) are executed to successfully complete the service request procedure.	-	-	-	-

Table 7.1.2.5.3.2-2: Parallel behaviour

St	Procedure	Message Sequence		TP	Verdict
		U - S	Message		
1	Check: Does the UE transmit an RRCConnectionRequest message.	-->	MAC PDU (RRCConnectionRequest)	1	F

7.1.2.5.3.3 Specific message contents

None.

7.1.2.6 Maintenance of uplink time alignment

7.1.2.6.1 Test Purpose (TP)

(1)

```
with { UE in E-UTRA RRC_IDLE state and having initiated a random access procedure }
ensure that {
  when { The SS transmits a Timing Advance Command in a Random Access Response message }
  then { the UE applies the received Timing Advance value in the next transmitted MAC PDU }
}
```

(2)

```
with { UE in E-UTRA RRC_CONNECTED state }
ensure that {
```

```

when { Timing Advance Command MAC control element is received and UE has pending data during the
period the timeAlignmentTimer is running }
  then { UE does not send any Random Access Preamble, but Scheduling Requests to request
transmission of data while timeAlignmentTimer is running }
}

```

(3)

```

with { UE in E-UTRA RRC_CONNECTED state }
ensure that {
  when { timeAlignmentTimer has expired or is not running and UL transmission is required }
    then { UE triggers a RA Procedure }
}

```

7.1.2.6.2 Conformance requirements

References: The conformance requirements covered in the current TC are specified in: TS 36.321 clause 5.2.

[TS 36.321 clause 5.2]

The UE has a configurable timer *timeAlignmentTimer* which is used to control how long the UE is considered uplink time aligned.

The UE shall:

- when a Timing Advance Command MAC control element is received:
 - apply the Timing Advance Command;
 - start or restart *timeAlignmentTimer*.
- when a Timing Advance Command is received in a Random Access Response message:
 - if the Random Access Preamble was not selected by UE MAC:
 - apply the Timing Advance Command;
 - start or restart *timeAlignmentTimer*.
 - else, if the *timeAlignmentTimer* is not running:
 - apply the Timing Advance Command;
 - start *timeAlignmentTimer*;
 - when the contention resolution is considered not successful as described in subclause 5.1.5, stop *timeAlignmentTimer*.
 - else:
 - ignore the received Timing Advance Command.
- when *timeAlignmentTimer* expires:
 - flush all HARQ buffers;
 - notify RRC to release PUCCH/SRS;
 - clear any configured downlink assignments and uplink grants.

7.1.2.6.3 Test description

7.1.2.6.3.1 Pre-test condition

System Simulator:

- Cell 1

UE:

None.

Preamble:

- The generic procedure to get UE in state Registered, Idle mode, UE Test Mode Activated (State 2a) according to TS 36.508 clause 4.5 is executed.

7.1.2.6.3.2 Test procedure sequence

Table 7.1.2.6.3.2-1: Main behaviour

St	Procedure	Message Sequence		TP	Verdict
		U – S	Message		
1	SS pages the UE	<--	-	-	-
2	SS respond to UE Random Access request by a Random Access Response with TA field within message set to 600(FDD) or 160(TDD) (Note 2).	<--	MAC PDU(Random Access Response (TA=600))	-	-
3	Check: Does UE send an <i>RRCCONNECTIONREQUEST</i> message in the first scheduled UL transmission using the Timing Advance value sent by the SS in step 2?	-->	MAC PDU (<i>RRCCONNECTIONREQUEST</i>)	1	P
4	The SS transmits a valid MAC PDU containing "UE Contention Resolution Identity" MAC control element with matching "Contention Resolution Identity" and RA Procedure considered a success.	<--	MAC PDU (UE Contention Resolution Identity)	-	-
5	The SS sends an <i>RRCCONNECTIONSETUP</i> message.	<--	MAC PDU	-	-
6	Check: Does the UE transmit an <i>RRCCONNECTIONSETUPCOMPLETE</i> ?	-->	MAC PDU (<i>RRCCONNECTIONSETUPCOMPLETE</i>)	1	P
7	The generic procedure to get UE in test state Loopback Activated (State 4) according to TS 36.508 clause 4.5 is executed with UL SDU size set to '0' (no data returned in uplink) using parameters as specified in Table 7.1.2.6.3.3-1	-	-	-	-
8	SS transmits Timing Advance command. SS does not send any subsequent alignments.	<--	MAC PDU (Timing Advance Command MAC Control Element)	-	-
9	After 600ms ($0.8 \times \text{timeAlignmentTimer}$) SS sends a MAC PDU containing a RLC PDU with SN=0 and poll bit set to trigger UE to transmit a status report in uplink. SS does not respond to any scheduling requests or Random Access Preambles from the UE.	<--	MAC PDU	-	-
10	Check: For $0.2 \times \text{timeAlignmentTimer}$ does UE transmit Scheduling Requests, but no Random Access Preamble message? (Note 1)	-->	SR	2	P
11	Void	-	-	-	-
12	Check: Does the UE transmit a Random Access Preamble?	-->	Random Access Preamble	3	P
13	SS responds with a valid Random Access Response	<--	MAC PDU (Random Access Response (Temporary C-RNTI))	-	-
14	Check: Does the UE transmit a MAC PDU with C-RNTI containing RLC STATUS PDU for the acknowledgement of the DL Data with the Temporary C-RNTI set to the value received in the Random Access Response message??	-->	MAC PDU(RLC STATUS PDU (ACK_SN =1))	3	P
15	The SS Transmits a PDCCH transmission addressed to the C-RNTI stored in the UE and contains an UL grant for a new transmission	<--	-	-	-
Note 1	A conformant UE correctly applies Timing Advance Command MAC Control and restarts <i>timeAlignmentTimer</i> , causing the uplink to stay in sync for a period equal to the received Time Alignment Value.				
Note 2	For FDD, T_A value of 600 has been chosen arbitrarily in the middle of the range 0 to 1282 and corresponds to 0.3125 ms (timing advance in ms = $1000 \times N_{TA} \times T_s$ where $N_{TA} = T_A \times 16$ and $T_s = 1/(15000 \times 2048)$ seconds according to TS 36.213 and TS 36.211). For TDD, T_A value of 160 has been chosen and corresponds to 0.1036 ms (timing advance in ms = $1000 \times (N_{TA} + N_{TA_offset}) \times T_s$ where $N_{TA} = T_A \times 16$, $N_{TA_offset} = 624T_s$, and $T_s = 1/(15000 \times 2048)$ seconds according to TS 36.213 and TS 36.211).				

7.1.2.6.3.3 Specific Message Contents

Table 7.1.2.6.3.3-1: SchedulingRequest-Configuration (RRCConnectionReconfiguration, step 7 table 7.1.2.6.3.2-1)

Derivation Path: 36.508 clause 4.6.3-20			
Information Element	Value/remark	Comment	Condition
SchedulingRequest-Configuration ::= CHOICE {			
setup SEQUENCE {			
dsr-TransMax	n64	Max value allowed	
}			
}			

7.1.2.7 MAC contention resolution / Temporary C-RNTI

7.1.2.7.1 Test Purpose (TP)

(1)

```
with { UE in E-UTRA RRC_IDLE state and after transmitting a RRCConnectionRequest message }
ensure that {
  when { SS does not send any MAC PDU including 'UE Contention Resolution Identity' MAC control
element before contention resolution timer expires }
    then { UE re-transmits RRCConnectionRequest }
}
```

(2)

```
with { UE in E-UTRA RRC_IDLE state and after transmitting a RRCConnectionRequest message }
ensure that {
  when { SS transmits a valid MAC PDU containing RRCConnectionSetup, but not including 'UE
Contention Resolution Identity' MAC control element }
    then { UE re-transmits RRCConnectionRequest }
}
```

(3)

```
with { UE in E-UTRA RRC_IDLE state and after transmitting a RRCConnectionRequest message }
ensure that {
  when { SS transmits a valid MAC PDU containing RRCConnectionSetup, including 'UE Contention
Resolution Identity' MAC control element but with un-matched 'Contention Resolution Identity' }
    then { UE re-transmits RRCConnectionRequest }
}
```

(4)

```
with { UE in E-UTRA RRC_IDLE state and after transmitting a RRCConnectionRequest message }
ensure that {
  when { SS transmits a valid MAC PDU containing a RRCConnectionSetup, including 'UE Contention
Resolution Identity' MAC control element and matching 'Contention Resolution Identity' }
    then { UE transmits a RRCConnectionSetupComplete message }
}
```

7.1.2.7.2 Conformance requirements

References: The conformance requirements covered in the current TC are specified in: TS 36.321, clause 5.1.5.

[TS 36.321, clause 5.1.5]

Contention Resolution is based on either C-RNTI on PDCCH or UE Contention Resolution Identity on DL-SCH..

Once Msg3 is transmitted, the UE shall:

- start *mac-ContentionResolutionTimer* and restart *mac-ContentionResolutionTimer* at each HARQ retransmission;
- regardless of the possible occurrence of a measurement gap, monitor the PDCCH until *mac-ContentionResolutionTimer* expires or is stopped;

- if notification of a reception of a PDCCH transmission is received from lower layers, the UE shall:

...

- else if the CCCH SDU was included in Msg3 and the PDCCH transmission is addressed to its Temporary C-RNTI:
 - if the MAC PDU is successfully decoded:
 - stop *mac-ContentionResolutionTimer*;
 - if the MAC PDU contains a UE Contention Resolution Identity MAC control element; and
 - if the UE Contention Resolution Identity included in the MAC control element matches the CCCH SDU transmitted in Msg3:
 - consider this Contention Resolution successful and finish the disassembly and demultiplexing of the MAC PDU;
 - set the C-RNTI to the value of the Temporary C-RNTI;
 - discard the Temporary C-RNTI;
 - consider this Random Access procedure successfully completed.
 - else
 - discard the Temporary C-RNTI;
 - consider this Contention Resolution not successful and discard the successfully decoded MAC PDU.
 - if *mac-ContentionResolutionTimer* expires:
 - discard the Temporary C-RNTI;
 - consider the Contention Resolution not successful.
 - if the Contention Resolution is considered not successful the UE shall:
 - flush the HARQ buffer used for transmission of the MAC PDU in the Msg3 buffer;
 - increment `PREAMBLE_TRANSMISSION_COUNTER` by 1;
 - If `PREAMBLE_TRANSMISSION_COUNTER = preambleTransMax + 1`:
 - indicate a Random Access problem to upper layers.
 - based on the back off parameter in the UE, select a random back off time according to a uniform distribution between 0 and the Back off Parameter Value;
 - delay the subsequent Random Access transmission by the back off time;
 - proceed to the selection of a Random Access Resource (see subclause 5.1.2).

7.1.2.7.3 Test description

7.1.2.7.3.1 Pre-test conditions

System Simulator:

- Cell 1

UE:

None.

Preamble:

- The UE is in state Registered, Idle mode (state 2) according to [18].

7.1.2.7.3.2 Test procedure sequence

Table 7.1.2.7.3.2-1: Main behaviour

St	Procedure	Message Sequence		TP	Verdict
		U - S	Message		
1	The SS transmits a Paging message including a matched identity.	<--	-	1	-
2	The UE transmits a MAC PDU containing an <i>RRCCoNNECTIONRequest</i> message.	-->	MAC PDU	1	-
3	Check: For time equal to 'Contention Resolution Timer', does UE send a PRACH preamble?	-->	PRACH preamble	1	F
4	Check: does the UE transmit a MAC PDU containing an <i>RRCCoNNECTIONRequest</i> message?	-->	MAC PDU (<i>RRCCoNNECTIONRequest</i>)	1	P
-	EXCEPTION: In parallel with steps 5 to 8, the parallel behaviour in table 7.1.2.7.3.2-2 is running.	-	-	-	-
5	The SS Transmits a valid MAC PDU containing <i>RRCCoNNECTIONSetup</i> , but not including 'UE Contention Resolution Identity' MAC control element	<--	MAC PDU (<i>RRCCoNNECTIONSetup</i>)	2	-
6	Check: does the UE transmit a MAC PDU containing an <i>RRCCoNNECTIONRequest</i> message?	-->	MAC PDU (<i>RRCCoNNECTIONRequest</i>)	2	P
7	The SS Transmits a valid MAC PDU containing <i>RRCCoNNECTIONSetup</i> , and including 'UE Contention Resolution Identity' MAC control element but with un matched 'Contention Resolution Identity'	<--	MAC PDU	3	-
8	Check: does the UE transmit a MAC PDU containing an <i>RRCCoNNECTIONRequest</i> message?	-->	MAC PDU	3	P
9	The SS Transmits a valid MAC PDU containing <i>RRCCoNNECTIONSetup</i> , and including 'UE Contention Resolution Identity' MAC control element with matching 'Contention Resolution Identity'	<--	MAC PDU	4	-
10	Check: does the UE transmit a MAC PDU containing an <i>RRCCoNNECTIONSetupComplete</i> message including SERVICE REQUEST message?	-->	MAC PDU (<i>RRCCoNNECTIONSetupComplete</i>)	4	P
11-14	Steps 6 to 9 of the generic radio bearer establishment procedure (TS 36.508 4.5.3.3-1) are executed to successfully complete the service request procedure.	-	-	-	-

Table 7.1.2.7.3.2-2: Parallel behaviour

St	Procedure	Message Sequence		TP	Verdict
		U - S	Message		
1	Check: UE transmits a MAC PDU containing an <i>RRCCoNNECTIONSetupComplete</i> message indicating acceptance of <i>RRCCoNNECTIONSetup</i> message?	-->	MAC PDU (<i>RRCCoNNECTIONSetupComplete</i>)	2,3	F

7.1.2.7.3.3 Specific message contents

7.1.2.7.3.3-1: SystemInformationBlockType2 (all steps, table 7.1.2.7.3.2-1)

Derivation path: 36.508 table 4.4.3.3-1

Information Element	Value/Remark	Comment	Condition
SystemInformationBlockType2 ::= SEQUENCE {			
radioResourceConfigCommon SEQUENCE {			
rach-Configuration SEQUENCE {			
ra-SupervisionInformation SEQUENCE {			
preambleTransMax	N10	Max value	
mac-ContentionResolutionTimer	sf64	Max value	
}			
}			
}			
}			

7.1.2.8 MAC contention resolution / C-RNTI

7.1.2.8.1 Test Purpose (TP)

(1)

```

with { UE in E-UTRA RRC_CONNECTED state and after transmitting a
RRCCONNECTIONRECONFIGURATIONCOMPLETE message for a handover without dedicated preamble }
ensure that {
  when { The SS does not schedule any PDCCH transmission addressed to UE C-RNTI before Contention
resolution timer expiry }
    then { The UE retransmits the RRCCONNECTIONRECONFIGURATIONCOMPLETE message }
}

```

(2)

```

with { UE in E-UTRA RRC_CONNECTED state and after transmitting a
RRCCONNECTIONRECONFIGURATIONCOMPLETE message for a handover without dedicated preamble }
ensure that {
  when { UE receive PDCCH transmission addressed to its C-RNTI before Contention resolution timer
expiry }
    then { The UE does not retransmit the RRCCONNECTIONRECONFIGURATIONCOMPLETE message }
}

```

7.1.2.8.2 Conformance requirements

References: The conformance requirements covered in the current TC are specified in: TS 36.321, clause 5.1.5.

[TS 36.321, clause 5.1.5]

Contention Resolution is based on either C-RNTI on PDCCH or UE Contention Resolution Identity on DL-SCH..

Once Msg3 is transmitted, the UE shall:

- start *mac-ContentionResolutionTimer* and restart *mac-ContentionResolutionTimer* at each HARQ retransmission;
- regardless of the possible occurrence of a measurement gap, monitor the PDCCH until *mac-ContentionResolutionTimer* expires or is stopped;
- if notification of a reception of a PDCCH transmission is received from lower layers, the UE shall:
 - if the C-RNTI MAC control element was included in Msg3:
 - if the Random Access procedure was initiated by the MAC sublayer itself and the PDCCH transmission is addressed to the C-RNTI and contains an UL grant for a new transmission; or
 - if the Random Access procedure was initiated by a PDCCH order and the PDCCH transmission is addressed to the C-RNTI:
 - consider this Contention Resolution successful;

- stop *mac-ContentionResolutionTimer*;
- discard the Temporary C-RNTI;
- consider this Random Access procedure successfully completed.

...

- else
 - discard the Temporary C-RNTI;
 - consider this Contention Resolution not successful and discard the successfully decoded MAC PDU.
- if *mac-ContentionResolutionTimer* expires:
 - discard the Temporary C-RNTI;
 - consider the Contention Resolution not successful.
- if the Contention Resolution is considered not successful the UE shall:
 - flush the HARQ buffer used for transmission of the MAC PDU in the Msg3 buffer;
 - increment PREAMBLE_TRANSMISSION_COUNTER by 1;
 - If PREAMBLE_TRANSMISSION_COUNTER = *preambleTransMax* + 1:
 - indicate a Random Access problem to upper layers.
 - based on the back off parameter in the UE, select a random back off time according to a uniform distribution between 0 and the Back off Parameter Value;
 - delay the subsequent Random Access transmission by the back off time;
 - proceed to the selection of a Random Access Resource (see subclause 5.1.2).

7.1.2.8.3 Test description

7.1.2.8.3.1 Pre-test conditions

System Simulator:

- Cell 1 and Cell 2
- System information as in table 7.1.2.8.3.3-1.

UE:

None.

Preamble:

- The UE is in state Generic RB Established (state 3) according to [18] on cell 1.

7.1.2.8.3.2 Test procedure sequence

Table 7.1.2.8.3.2-0 illustrates the downlink power levels and other changing parameters to be applied for the cells at various time instants of the test execution. The exact instants on which these values shall be applied are described in the texts in this clause.

Table 7.1.2.8.3.2-0: Time instances of cell power level and parameter changes

	Parameter	Unit	Cell 1	Cell 2
T1	Cell-specific RS EPRE	dBm/15k Hz	-85	-79

Table 7.1.2.8.3.2-1: Main behaviour

St	Procedure	Message Sequence		TP	Verdict
		U - S	Message		
0	The SS changes Cell 1 and Cell 2 level according to the row "T1" in table 7.1.2.8.3.2-0	-	-	-	-
1	The SS transmits a MAC PDU containing an <i>RRCConnectionReconfiguration</i> message to order the UE to perform intra frequency handover to Cell 2, not including explicit Random Access Preamble.	<--	MAC PDU	-	-
2	The UE transmits on cell 2 a MAC PDU containing <i>RRCConnectionReconfigurationComplete</i> , including C-RNTI MAC control element. SS is configured to not transmit RLC ACK for this transmission.	-->	MAC PDU	-	-
3	SS Does not schedule any PDCCH transmission for UE C-RNTI	-	-	-	-
4	Check: does the UE transmit a PRACH preamble within time equal to 'Contention Resolution Timer'?	-->	(PRACH preamble)	1	F
5	Check: does the UE transmit on cell 2 a MAC PDU containing <i>RRCConnectionReconfigurationComplete with RLC SN 0</i> , including C-RNTI MAC control element?	-->	MAC PDU (<i>RLC SN = 0</i>)	1	P
6	SS sends PDCCH transmission for UE C-RNTI	<--	-	-	-
7	Check: does the UE transmit MAC PDU containing <i>RRCConnectionReconfigurationComplete with RLC SN 0</i> within the next 2s?	-->	MAC PDU (<i>RLC SN = 0</i>)	2	F
8	Check: does the test result of CALL generic procedure indicate that the UE is in E-UTRA RRC_CONNECTED state on Cell 2?	-	-	2	-

7.1.2.8.3.3 Specific message contents

Table 7.1.2.8.3.3-1: *SystemInformationBlockType2* (all steps, Table 7.1.2.8.3.2-1)

Derivation path: 36.508 table 4.4.3.3-1			
Information Element	Value/Remark	Comment	Condition
<i>SystemInformationBlockType2</i> ::= SEQUENCE {			
<i>radioResourceConfigCommon</i> SEQUENCE {			
<i>rach-Configuration</i> SEQUENCE {			
<i>ra-SupervisionInformation</i> SEQUENCE {			
<i>preambleTransMax</i>	N10	Max value	
<i>mac-ContentionResolutionTimer</i>	sf64	Max value	
}			
}			
}			
}			

Table 7.1.2.8.3.3-2: RRCConnectionReconfiguration (step 1, Table 7.1.2.8.3.2-1)

Derivation path: 36.508 table 4.6.1-6, condition RBC-HO			
Information Element	Value/Remark	Comment	Condition
RRCConnectionReconfiguration ::= SEQUENCE {			
criticalExtensions CHOICE {			
c1 CHOICE{			
rrcConnectionReconfiguration-r8 SEQUENCE {			
mobilityControllInformation SEQUENCE {	MobilityControllInformatio n-HO		
targetCellIdentity	PhysicalCellIdentity of Cell 2 (see 36.508 clause 4.4.4.2)		
eutra-CarrierFreq	Not present		
}			
}			
}			
}			
}			

7.1.2.9 MAC back off indicator

7.1.2.9.1 Test Purpose (TP)

(1)

```
with { UE in E-UTRA RRC_IDLE state and having initiated a random access procedure }
ensure that {
  when { SS sends a Random Access Response including a Backoff Indicator and the Random Access
Preamble identifier is different from the value received from the UE }
    then { UE triggers RA preamble after a random time between 0 and the indicated Backoff parameter
}
}
```

(2)

```
with { UE in E-UTRA RRC_IDLE state and having initiated a random access procedure }
ensure that {
  when { SS sends a Random Access Response containing Backoff Indicator and a Random Access Preamble
identifier with the same value as received from the UE }
    then { UE stores Backoff Indicator and sends a RRC connection request in the first scheduled UL
transmission }
}
```

(3)

```
with { UE in E-UTRA RRC_IDLE state and having initiated a random access procedure }
ensure that {
  when { UE receives a Contention Resolution failure }
    then { UE triggers RA preamble after random time between 0 and the UE stored Backoff parameter }
}
```

7.1.2.9.2 Conformance requirements

References: The conformance requirements covered in the current TC are specified in: TS 36.321, clauses 5.1.4, 5.1.5 and 7.2.

[TS 36.321 clause 5.1.4]

- If a downlink assignment for this TTI has been received on the PDCCH for the RA-RNTI and the received TB is successfully decoded, the UE shall regardless of the possible occurrence of a measurement gap:
 - if the Random Access Response contains a Back off Indicator sub header:
 - set the back off parameter value in the UE as indicated by the BI field of the Back off Indicator sub header and Table 7.2-1.

- else, set the back off parameter value in the UE to 0 ms.

...

If no Random Access Response is received within the RA Response window, or if none of all received Random Access Responses contains a Random Access Preamble identifier corresponding to the transmitted Random Access Preamble, the Random Access Response reception is considered not successful and the UE shall:

...

- if in this Random Access procedure, the Random Access Preamble was selected by MAC:
 - based on the backoff parameter in the UE, select a random backoff time according to a uniform distribution between 0 and the Backoff Parameter Value;
 - delay the subsequent Random Access transmission by the backoff time;

[TS 36.321 clause 5.1.5]

- if the Contention Resolution is considered not successful the UE shall:
 - flush the HARQ buffer used for transmission of the MAC PDU in the Msg3 buffer;
 - increment PREAMBLE_TRANSMISSION_COUNTER by 1;
 - If PREAMBLE_TRANSMISSION_COUNTER = $preambleTransMax + 1$:
 - indicate a Random Access problem to upper layers.
 - based on the backoff parameter in the UE, select a random backoff time according to a uniform distribution between 0 and the Backoff Parameter Value;
 - delay the subsequent Random Access transmission by the backoff time;
 - proceed to the selection of a Random Access Resource (see subclause 5.1.2).

[TS 36.321 clause 7.2]

Back off Parameter values are presented in Table 7.2-1.

Table 7.2-1: Backoff Parameter values

Index	Backoff Parameter value (ms)
0	0
1	10
2	20
3	30
4	40
5	60
6	80
7	120
8	160
9	240
10	320
11	480
12	960
13	Reserved
14	Reserved
15	Reserved

The reserved values of the backoff parameter if received by the current release version UEs shall be taken as 960 ms.

7.1.2.9.3 Test description

7.1.2.9.3.1 Pre-test conditions

System Simulator:

- Cell 1

UE:

None.

Preamble:

- The UE is in state Registered, Idle Mode (state 2) according to [18].

Table 7.1.2.9.3.1-1: Void

7.1.2.9.3.2 Test procedure sequence

Table 7.1.2.9.3.2-1: Back off Parameter values.

x: Index	y: Back off Parameter value (ms)
1	10
2	20
3	30
4	40
5	60
6	80
7	120
8	160
9	240
10	320
11	480
12	960
13	960
14	960
15	960

Table 7.1.2.9.3.2-2: Main behaviour

St	Procedure	Message Sequence		TP	Verdict
		U - S	Message		
-	EXCEPTION: Steps 1 to 5e are repeated for values of 'x' and 'y' according to table 7.1.2.9.3.2-1	-	-	-	-
1	SS pages the UE	<--	-	-	-
2	UE sends a Random Access Preamble	-->	Random Access Preamble	-	-
3	SS sends a Random Access Response with the back off parameter set to value Index field 'x' and with the Random Access Preamble identifier different from the value received from the UE in the Random Access Preamble. The SS sets Timer_T1 to the Back off value 'y' associated with the Index value 'x' and starts Timer_T1.	<--	Random Access Response(BI, RAPID)	-	-
4	Check: Does UE send a Random Access Preamble while Timer_T1 is running?	-->	Random Access Preamble	1	P
5	The SS transmits Random Access Response with RAPID corresponding to the transmitted Preamble in step 4, including T-CRNTI and not including Back off Indicator sub header	<--	Random Access Response	-	-
5A	The UE transmits an <i>RRCCoalitionRequest</i> message.	-->	-	-	-
5B	The SS Transmits a valid MAC PDU	<--	MAC PDU	-	-

	containing <i>RRConnectionSetup</i> , and including 'UE Contention Resolution Identity' MAC control element with matching 'Contention Resolution Identity'		(<i>RRConnectionSetup</i>)		
5C	The UE transmits an <i>RRConnectionSetupComplete</i> message.	-->	-	-	-
5D	SS transmits SERVICE REJECT message with EMM cause "Congestion" to complete the procedure Note: The EMM cause chosen is just for convenience, to ensure that UE will abort the procedure without side effects.	<--	-	-	-
5E	The SS transmits an <i>RRConnectionRelease</i> message to release RRC connection and move to RRC_IDLE.	<--	-	-	-
	EXCEPTION: Steps 6 to 20 are repeated for values of 'x' and 'y' according to table 7.1.2.9.3.2-1	-	-	-	-
6	SS pages the UE	<--	-	-	-
7	UE sends a Random Access Preamble	-->	Random Access Preamble	-	-
8	SS sends Random Access Response with a back off parameter set to value Index field 'x' and the Random Access Preamble identifier value set to the same value as received from the UE in the Random Access Preamble.	<--	Random Access Response(BI, RAPID)	-	-
9	Check: Does UE sends an <i>RRConnectionRequest</i> in the grant associated to the Random Access Response received in step 8?	-->	MAC PDU (<i>RRConnectionRequest</i>)	2	P
10	The SS sends a Contention Resolution Failure. The SS sets Timer_T1 to the Back off value 'y' associated with the Index value 'x' and starts Timer_T1.	<--	MAC Control PDU (Unmatching UE Contention Resolution Identity)	-	-
11	Check: Does UE send a Random Access Preamble while Timer_T1 is running?	-->	Random Access Preamble	3	P
12	The SS transmits Random Access Response with RAPID corresponding to the transmitted Preamble in step 11, including T-CRNTI and not including Back off Indicator sub header	<--	Random Access Response	-	-
13	The UE transmits an <i>RRConnectionRequest</i> message.	-->	-	-	-
14	The SS Transmits a valid MAC PDU containing <i>RRConnectionSetup</i> , and including 'UE Contention Resolution Identity' MAC control element with matching 'Contention Resolution Identity'	<--	MAC PDU (<i>RRConnectionSetup</i>)	-	-
15	The UE transmits an <i>RRConnectionSetupComplete</i> message.	-->	-	-	-
16-19	Steps 6 to 9 of the generic radio bearer establishment procedure (TS 36.508 4.5.3.3-1) are executed to successfully complete the service request procedure.	-	-	-	-
20	The SS transmits an <i>RRConnectionRelease</i> message to release RRC connection and move to RRC_IDLE.	<--	-	-	-

7.1.2.9.3.3 Specific Message Contents

None

7.1.3 DL-SCH data transfer

7.1.3.1 Correct handling of DL assignment / Dynamic case

7.1.3.1.1 Test Purpose (TP)

(1)

```
with { UE in E-UTRA RRC_CONNECTED state }
ensure that {
  when { UE receives downlink assignment on the PDCCH for the UE's C-RNTI and receives data in the
associated subframe and UE performs HARQ operation }
  then { UE sends a HARQ feedback on the HARQ process }
}
```

(2)

```
with { UE in E-UTRA RRC_CONNECTED state }
ensure that {
  when { UE receives downlink assignment on the PDCCH with a C-RNTI unknown by the UE and data is
available in the associated subframe }
  then { UE does not send any HARQ feedback on the HARQ process }
}
```

7.1.3.1.2 Conformance requirements

References: The conformance requirements covered in the present TC are specified in: 3GPP TS 36.321 clause 5.3.1

[TS 36.321, clause 5.3.1]

Downlink assignments transmitted on the PDCCH indicate if there is a transmission on the DL-SCH for a particular UE and provide the relevant HARQ information.

When the UE has a C-RNTI, Semi-Persistent Scheduling C-RNTI, or Temporary C-RNTI, the UE shall for each TTI during which it monitors PDCCH:

- if a downlink assignment for this TTI has been received on the PDCCH for the UE's C-RNTI, or Temporary C-RNTI:
 - if this is the first downlink assignment for this Temporary C-RNTI:
 - consider the NDI to have been toggled.
 - if the downlink assignment is for UE's C-RNTI and if the previous downlink assignment indicated to the HARQ entity of the same HARQ process was either a downlink assignment received for the UE's Semi-Persistent Scheduling C-RNTI or a configured downlink assignment:
 - consider the NDI to have been toggled regardless of the value of the NDI.
- indicate the presence of a downlink assignment and deliver the associated HARQ information to the HARQ entity for this TTI.

7.1.3.1.3 Test description

7.1.3.1.3.1 Pre-test conditions

System Simulator:

- Cell 1
- RRC Connection Reconfiguration (preamble: Table 4.5.3.3-1, step 8) using parameters as specified in Table 7.1.3.1.3.3-1

UE:

None.

Preamble:

- The generic procedure to get UE in test state Loopback Activated (State 4) according to TS 36.508 clause 4.5 is executed, with all the parameters as specified in the procedure except that the RLC SDU size is set to return no data in uplink.

7.1.3.1.3.2 Test procedure sequence

Table 7.1.3.1.3.2-1: Main behaviour

St	Procedure	Message Sequence		TP	Verdict
		U - S	Message		
1	SS transmits a downlink assignment including the C-RNTI assigned to the UE	<--	(PDCCH (C-RNTI))	-	-
2	SS transmits in the indicated downlink assignment a RLC PDU in a MAC PDU.	<--	MAC PDU	-	-
3	Check: Does the UE transmit an HARQ ACK on PUCCH?	-->	HARQ ACK	1	P
4	SS transmits a downlink assignment to including a C-RNTI different from the assigned to the UE	<--	(PDCCH (unknown C-RNTI))	-	-
5	SS transmits in the indicated downlink assignment a RLC PDU in a MAC PDU.	<--	MAC PDU	-	-
6	Check: Does the UE send any HARQ ACK on PUCCH?	-->	HARQ ACK	2	F

NOTE 1: For TDD, the timing of ACK/NACK is not constant as FDD, see Table 10.1-1 of TS 36.213.

7.1.3.1.3.3 Specific Message Contents

Table 7.1.3.1.3.3-1: RRCConnectionReconfiguration (preamble: Table 4.5.3.3-1, step 8)

Derivation path: 36.508 table 4.8.2.1.5-1			
Information Element	Value/Remark	Comment	Condition
RRCCConnectionReconfiguration ::= SEQUENCE {			
criticalExtensions CHOICE {			
c1 CHOICE{			
rrcConnectionReconfiguration-r8 SEQUENCE {			
RadioResourceConfigDedicated SEQUENCE {			
mac-MainConfig CHOICE {			
timeAlignmentTimerDedicated	Infinity		
}			
}			
}			
}			
}			
}			

Table 7.1.3.1.3.3-2: Void

Table 7.1.3.1.3.3-3: Void

7.1.3.2 Correct handling of DL assignment / Semi-persistent case

7.1.3.2.1 Test Purpose (TP)

(1)

```

with { UE in E-UTRA RRC_Connected state with DRB established and sps-Configuration in DL is enabled
}
ensure that {
  when { UE receives a DL assignment addressed to its stored SPS-CRNTI in SF-Num y and with NDI set
as 0 }
  then { UE starts receiving DL MAC PDU in SF-Nums y+n*[semiPersistSchedIntervalDL] where 'n' is
positive integer starting at zero }
}

```

(2)

```

with { UE in E-UTRA RRC_Connected state with DRB established and stored DL SPS assignment to receive
MAC PDU at SF-Num  $y+n*[semiPersistSchedIntervalDL]$  }
ensure that {

  when { UE receives a DL assignment addressed to its SPS-CRNTI in SF-Num  $p$  and with NDI set as 0,
  where  $p!= y+n*[semiPersistSchedIntervalDL]$  }
  then { UE starts receiving DL MAC PDU in SF-Nums  $p+n*[semiPersistSchedIntervalDL]$  and stops
  receiving DL MAC PDU at SF-Nums  $y+n*[semiPersistSchedIntervalDL]$  where 'n' is positive integer
  starting at zero }
}

```

(3)

```

with { UE in E-UTRA RRC_Connected state with DRB established and stored DL SPS assignment to receive
MAC PDU at SF-Num  $p+n*[semiPersistSchedIntervalDL]$  }
ensure that {

  when { UE receives a DL assignment [for retransmission] addressed to its SPS-CRNTI in SF-Num  $z$  and
  with NDI set as 1, where  $z!= p+n*[semiPersistSchedIntervalDL]$  }
  then { UE receives MAC PDU in SF-Num  $z$  as per the new grant for SPS-CRNTI }
}

```

(4)

```

with { UE in E-UTRA RRC_Connected state with DRB established and stored DL SPS assignment to receive
MAC PDU at SF-Num  $y+n*[semiPersistSchedIntervalDL]$  }
ensure that {

  when { UE receives a DL assignment addressed to its CRNTI in SF-Num  $p$ , such that  $p!=
y+n*[semiPersistSchedIntervalDL]$  }
  then { UE receives MAC PDU in SF-Num  $p$  as per assignment addressed to its C-RNTI }
}

```

(5)

```

with { UE in E-UTRA RRC_Connected state with DRB established and stored DL SPS grant to receive MAC
PDU at SF-Num  $z+n*[semiPersistSchedIntervalDL]$  }
ensure that {

  when { UE receives a RRCConnectionReconfiguration including sps-Configuration with sps-
ConfigurationDL set as 'disable' and hence resulting in DL SPS grant deactivation }
  then { UE deletes the stored sps-Configuration DL parameters and stops receiving DL MAC PDU's as
per stored SPS assignment in SF-Num  $z+n*[semiPersistSchedIntervalDL]$  }
}

```

(6)

```

with { UE in E-UTRA RRC_Connected state with DRB established and stored DL SPS assignment to receive
MAC PDU at SF-Num  $z+n*[semiPersistSchedIntervalDL]$  }
ensure that {

  when { UE receives a PDCCH [for DL SPS explicit release according to Table 9.2-1A in TS 36.213]
addressed to its SPS C-RNTI in SF-Num  $p$  and with NDI set as 0, where  $p!=
z+n*[semiPersistSchedIntervalDL]$  }
  then { UE sends an ACK to SS and releases the configured SPS assignment and stops receiving MAC
PDU in SF-Num  $z+n*[semiPersistSchedIntervalDL]$  as per assignment addressed to its SPS C-RNTI }
}

```

NOTE: SF-Num = $[10*SFN + subframe]$ modulo 10240.

7.1.3.2.2 Conformance requirements

References: The conformance requirements covered in the current TC are specified in: TS 36.321 clause 5.3.1, 5.10 & 5.10.1, 36.331 clause 5.3.10.5, 36.300 clause 11.1.1 and 36.213 clause 9.2.

[TS 36.321, clause 5.3.1]

Downlink assignments transmitted on the PDCCH indicate if there is a transmission on the DL-SCH for a particular UE and provide the relevant HARQ information.

When the UE has a C-RNTI, Semi-Persistent Scheduling C-RNTI, or Temporary C-RNTI, the UE shall for each TTI during which it monitors PDCCH:

- if a downlink assignment for this TTI has been received on the PDCCH for the UE's C-RNTI, or Temporary C-RNTI:
 - if this is the first downlink assignment for this Temporary C-RNTI:
 - consider the NDI to have been toggled.
 - if the downlink assignment is for UE's C-RNTI and if the previous downlink assignment indicated to the HARQ entity of the same HARQ process was either a downlink assignment received for the UE's Semi-Persistent Scheduling C-RNTI or a configured downlink assignment:
 - consider the NDI to have been toggled regardless of the value of the NDI.
 - indicate the presence of a downlink assignment and deliver the associated HARQ information to the HARQ entity for this TTI.
- else, if a downlink assignment for this TTI has been received on the PDCCH for the UE's Semi-Persistent Scheduling C-RNTI:
 - if the NDI in the received HARQ information is 1:
 - consider the NDI not to have been toggled;
 - indicate the presence of a downlink assignment and deliver the associated HARQ information to the HARQ entity for this TTI.
 - else, if the NDI in the received HARQ information is 0:
 - if PDCCH contents indicate SPS release:
 - clear the configured downlink assignment (if any);
 - if *timeAlignmentTimer* is running:
 - instruct the physical layer to transmit a positive acknowledgement.
 - else:
 - store the downlink assignment and the associated HARQ information as configured downlink assignment;
 - initialise (if not active) or re-initialise (if already active) the configured downlink assignment to start in this TTI and to recur according to rules in subclause 5.10.1;
 - set the HARQ Process ID to the HARQ Process ID associated with this TTI;
 - consider the NDI bit to have been toggled;
 - indicate the presence of a configured downlink assignment and deliver the stored HARQ information to the HARQ entity for this TTI.
 - else, if a downlink assignment for this TTI has been configured and there is no measurement gap in this TTI:
 - instruct the physical layer to receive, in this TTI, transport block on the DL-SCH according to the configured downlink assignment and to deliver it to the HARQ entity;
 - set the HARQ Process ID to the HARQ Process ID associated with this TTI;
 - consider the NDI bit to have been toggled;
 - indicate the presence of a configured downlink assignment and deliver the stored HARQ information to the HARQ entity for this TTI.

For downlink assignments received on the PDCCH for the UE's Semi-Persistent Scheduling C-RNTI and for configured downlink assignments, the HARQ Process ID associated with this TTI is derived from the following equation:

HARQ Process ID = $\lfloor \text{floor}(\text{CURRENT_TTI}/(\text{Downlink Semi-Persistent Scheduling Interval})) \rfloor$ modulo Number of Configured SPS Processes,

where $\text{CURRENT_TTI} = [(\text{SFN} * 10) + \text{subframe number}]$, Downlink Semi-Persistent Scheduling Interval is the periodicity of semi-persistent scheduling signalled via RRC and Number of Configured SPS Processes is the number of HARQ processes allocated for semi-persistent scheduling signalled via RRC.

[TS 36.321, clause 5.10]

When Semi-Persistent Scheduling is enabled by upper layer, the following information is provided:

- Semi-Persistent Scheduling C-RNTI;
- Uplink Semi-Persistent Scheduling Interval *semiPersistSchedIntervalUL* and number of empty transmissions before implicit release *implicitReleaseAfter*, if Semi-Persistent Scheduling is enabled for the uplink;
- Whether *twoIntervalsConfig* is enabled or disabled for uplink, only for TDD;
- Downlink Semi-Persistent Scheduling Interval *semiPersistSchedIntervalDL* and number of configured HARQ processes for Semi-Persistent Scheduling *numberOfConfSPS-Processes*, if Semi-Persistent Scheduling is enabled for the downlink;

When Semi-Persistent Scheduling for uplink or downlink is disabled by RRC, the corresponding configured grant or configured assignment shall be discarded.

[TS 36.321, clause 5.10.1]

After a Semi-Persistent downlink assignment is configured, the UE shall consider that the assignment recurs in each subframe for which:

- $(10 * \text{SFN} + \text{subframe}) = [(10 * \text{SFN}_{\text{start time}} + \text{subframe}_{\text{start time}}) + N * (\text{Downlink Semi-Persistent Scheduling Interval})]$ modulo 10240, for all $N > 0$.

Where $\text{SFN}_{\text{start time}}$ and $\text{subframe}_{\text{start time}}$ are the SFN and subframe, respectively, at the time the configured downlink assignment were (re-)initialised.

[TS 36.331, clause 5.3.10.5]

The UE shall:

- 1> reconfigure the semi-persistent scheduling in accordance with the received *sps-Config*:

[TS 36.300, clause 11.1.1]

In addition, E-UTRAN can allocate semi-persistent downlink resources for the first HARQ transmissions to UEs:

- RRC defines the periodicity of the semi-persistent downlink grant;
- PDCCH indicates whether the downlink grant is a semi-persistent one i.e. whether it can be implicitly reused in the following TTIs according to the periodicity defined by RRC.

When required, retransmissions are explicitly signalled via the PDCCH(s). In the sub-frames where the UE has semi-persistent downlink resource, if the UE cannot find its C-RNTI on the PDCCH(s), a downlink transmission according to the semi-persistent allocation that the UE has been assigned in the TTI is assumed. Otherwise, in the sub-frames where the UE has semi-persistent downlink resource, if the UE finds its C-RNTI on the PDCCH(s), the PDCCH allocation overrides the semi-persistent allocation for that TTI and the UE does not decode the semi-persistent resources.

[TS 36.213, clause 9.2]

A UE shall validate a Semi-Persistent Scheduling assignment PDCCH only if all the following conditions are met:

- the CRC parity bits obtained for the PDCCH payload are scrambled with the Semi-Persistent Scheduling C-RNTI
- the new data indicator field is set to '0'. In case of DCI formats 2 and 2A, the new data indicator field refers to the one for the enabled transport block.

Validation is achieved if all the fields for the respective used DCI format are set according to Table 9.2-1 or Table 9.2-1A.

If validation is achieved, the UE shall consider the received DCI information accordingly as a valid semi-persistent activation or release.

If validation is not achieved, the received DCI format shall be considered by the UE as having been received with a non-matching CRC.

Table 9.2-1: Special fields for Semi-Persistent Scheduling Activation PDCCH Validation

	DCI format 0	DCI format 1/1A	DCI format 2/2A
TPC command for scheduled PUSCH	set to '00'	N/A	N/A
Cyclic shift DM RS	set to '000'	N/A	N/A
Modulation and coding scheme and redundancy version	MSB is set to '0'	N/A	N/A
HARQ process number	N/A	FDD: set to '000' TDD: set to '0000'	FDD: set to '000' TDD: set to '0000'
Modulation and coding scheme	N/A	MSB is set to '0'	For the enabled transport block: MSB is set to '0'
Redundancy version	N/A	set to '00'	For the enabled transport block: set to '00'

Table 9.2-1A: Special fields for Semi-Persistent Scheduling Release PDCCH Validation

	DCI format 0	DCI format 1A
TPC command for scheduled PUSCH	set to '00'	N/A
Cyclic shift DM RS	set to '000'	N/A
Modulation and coding scheme and redundancy version	set to '11111'	N/A
Resource block assignment and hopping resource allocation	Set to all '1's	N/A
HARQ process number	N/A	FDD: set to '000' TDD: set to '0000'
Modulation and coding scheme	N/A	set to '11111'
Redundancy version	N/A	set to '00'
Resource block assignment	N/A	Set to all '1's

7.1.3.2.3 Test description

7.1.3.2.3.1 Pre-test conditions

System Simulator:

- Cell 1

UE:

None.

Preamble:

- The UE is in state Loopback Activated (state 4) according to [18].
- The condition SRB2-DRB(1,1) is used for step 8 in 4.5.3A.3 according to [18].
- The UL RLC SDU size is set to not return any data.

7.1.3.2.3.2 Test procedure sequence

Table 7.1.3.2.3.2-1: Main behaviour

St	Procedure	Message Sequence		TP	Verdict
		U - S	Message		
1	The SS Transmits a DL assignment using UE's SPS C-RNTI in SF-Num 'Y', NDI=0	<--	(DL SPS Grant)	-	-
2	The SS transmits in SF-Num 'Y', a DL MAC PDU containing a RLC PDU (DL-SQN=0)on UM DRB	<--	MAC PDU	-	-
3	Check: Does the UE transmit a HARQ ACK?	-->	HARQ ACK	1	P
4	The SS transmits in SF-Num 'Y+X(semiPersistSchedIntervalDL)', a DL MAC PDU containing a RLC PDU (DL-SQN=1)on DRB	<--	MAC PDU	-	-
5	Check: Does the UE transmit a HARQ ACK?	-->	HARQ ACK	1	P
6	The SS Transmits a DL assignment using UE's SPS C-RNTI in SF-Num 'P', NDI=0; (Where $Y+X < P < Y+2X$)	<--	(DL SPS Grant)	-	-
7	The SS transmits in SF-Num 'P', a DL MAC PDU containing a RLC PDU (DL-SQN=2)on UM DRB	<--	MAC PDU	-	-
8	Check: Does the UE transmit a HARQ ACK?	-->	HARQ ACK	2	P
9	The SS transmits in SF-Num 'Y+2X', a DL MAC PDU containing a RLC PDU (DL-SQN=3)on UM DRB	<--	MAC PDU	-	-
10	Check: Does the UE transmit a HARQ Feedback?	-->	HARQ ACK/NACK	2	F
10A	The SS Transmits a DL assignment using UE's C-RNTI in SF-Num 'P+X(semiPersistSchedIntervalDL)', NDI=0	<--	(DL Grant)	-	-
11	The SS transmits in SF-Num 'P+X(semiPersistSchedIntervalDL)', a DL MAC PDU containing a RLC PDU (DL-SQN=3)on UM DRB;	<--	MAC PDU	-	-
12	Void	-	-	-	-
13	Void	-	-	-	-
14	Void	-	-	-	-
15	Check: Does the UE transmit a HARQ ACK?	-->	HARQ ACK	4	P
16	The SS transmits in SF-Num 'P+2X(semiPersistSchedIntervalDL)', a DL MAC PDU containing a RLC PDU (DL-SQN=4)on UM DRB	<--	MAC PDU	-	-
17	Check: Does the UE transmit a HARQ ACK?	-->	HARQ ACK	1	P
18	The SS Transmits a DL assignment using UE's SPS C-RNTI in SF-Num in SF-Num 'P+3X(semiPersistSchedIntervalDL)' . (Note 1a)	<--	(DL SPS Grant)	-	-
19	The SS transmits in SF-Num 'P+3X(semiPersistSchedIntervalDL)', a DL MAC PDU containing 1 RLC PDU's (DL-SQN=5)on UM DRB;Note 1	<--	MAC PDU	-	-
19A	Check: Does the UE transmit a HARQ NACK?	-->	HARQ NACK		
	EXCEPTION: Step 19b and 19c shall be repeated until HARQ retransmission count = 3 is reached for MAC PDU at step 19 (Note 1b).				
19b	The SS Transmits a DL assignment using UE's SPS C-RNTI in SF-Num 'Z', NDI=1; Where $(P+3X < Z < P+4X)$; The DL HARQ process is same as in step 11	<--	(DL SPS Grant)		
19c	The SS re-transmits in SF-Num 'Z', a DL MAC	<--	MAC PDU		

	PDU containing a RLC PDU (DL-SQN=5) on UM DRB; (Note 1a)				
	EXCEPTION: Up to 3 HARQ NACK from the UE should be allowed at step 20 (Note 1b).				
20	Check: Does the UE transmit a HARQ ACK?	-->	HARQ ACK	3	P
21	The SS Transmits a PDCCH [for DL SPS explicit release] using UE's SPS C-RNTI in SF-Num 'Q', NDI=0; Where $(P+3X < Q < P+4X)$.	<--	PDCCH [for DL SPS explicit release]	-	-
22	Check: Does the UE transmit a HARQ ACK?	-->	HARQ ACK	6	P
23	The SS transmits in SF-Num 'P+5X(semiPersistSchedIntervalDL)', a DL MAC PDU containing 1 RLC PDU's (DL-SQN=6) on UM DRB;	<--	MAC PDU	-	-
24	Check: Does the UE transmit a HARQ Feedback?	-->	HARQ ACK/NACK	6	F
25	The SS Transmits a DL assignment using UE's SPS C-RNTI in SF-Num 'P+6X', NDI=0	<--	(DL SPS Grant)	-	-
26	The SS transmits in SF-Num 'P+6X', a DL MAC PDU containing a RLC PDU (DL-SQN=6) on UM DRB	<--	MAC PDU	-	-
27	Check: Does the UE transmit a HARQ ACK?	-->	HARQ ACK	1	P
28	Void	-	-	-	-
29	Void	-	-	-	-
30	SS Transmits RRCConnectionReconfiguration to disable SPS-ConfigurationDL	-	-	-	-
31	The UE transmits RRCConnectionReconfigurationComplete	-->	-	-	-
32	The SS transmits in SF-Num 'P+8X(semiPersistSchedIntervalDL)', a DL MAC PDU containing 1 RLC PDU's (DL-SQN=7) on UM DRB;	<--	MAC PDU	-	-
33	Check: Does the UE transmit a HARQ Feedback?	-->	HARQ ACK/NACK	5	F
Note 1:	The DL assignment for C-RNTI and hence the size of MAC PDU is different in size than stored SPS C-RNTI DL assignment in step 6. This assures UE is receiving DSCH data as per DL assignment for C-RNTI and not as per stored grant for SPS C-RNTI.				
Note 1a:	SS should transmit this PDU using $I_{TBS}=6$, $N_{PRB}=1$, see TS 36.213 Table 7.1.7.2.1-1. This will result in TBSsize of 328 and having coding rate more than 1.				
Note 1b:	The value 4 for the maximum number of HARQ retransmissions has been chosen based on an assumption that, given the radio conditions used in this test case, a UE soft combiner implementation should have sufficient retransmissions to be able to successfully decode the data in its soft buffer.				
Note 2:	For TDD, the subframe number for 'Y', 'P', 'Z' and 'Q' should be '0', '4', '5' and '9' respectively based on TDD configuration 1.				

7.1.3.2.3.3 Specific message contents

Table 7.1.3.2.3.3-1: RRCConnectionReconfiguration. RadioResourceConfigDedicated (Preamble)

Derivation path: 36.508 table 4.6.3-16			
Information Element	Value/remark	Comment	Condition
RadioResourceConfigDedicated ::= SEQUENCE {			
sps-Configuration ::= SEQUENCE {			
semiPersistSchedC-RNTI	'FFF0'H		
sps-ConfigurationDL ::= CHOICE {			
enable SEQUENCE {			
semiPersistSchedIntervalDL	sf40	40 Subframe	
numberOfConfSPS-Processes	8		FDD
numberOfConfSPS-Processes	7	Max DL HARQ processes is 7 considering TDD configuration 1.	TDD
n1Pucch-AN-Persistent	0		
}			
}			
sps-ConfigurationUL	Not Present		
}			
}			

Table 7.1.3.2.3.3-2: RRCConnectionReconfiguration. RadioResourceConfigDedicated (step 30 of table 7.1.3.2.3.2-1)

Derivation path: 36.508 table 4.6.3-16			
Information Element	Value/remark	Comment	Condition
RadioResourceConfigDedicated ::= SEQUENCE {			
sps-Configuration ::= SEQUENCE {			
semiPersistSchedC-RNTI	Not Present		
sps-ConfigurationDL ::= CHOICE {			
disable	NULL		
}			
sps-ConfigurationUL	Not Present		
}			
}			

Table 7.1.3.2.3.3-3: RRCConnectionReconfiguration (preamble: Table 4.5.3.3-1, step 8)

Derivation path: 36.508 table 4.8.2.1.5-1			
Information Element	Value/Remark	Comment	Condition
RRCConnectionReconfiguration ::= SEQUENCE {			
criticalExtensions CHOICE {			
c1 CHOICE {			
rrcConnectionReconfiguration-r8 SEQUENCE {			
RadioResourceConfigDedicated SEQUENCE {			
mac-MainConfig CHOICE {			
drx-Config CHOICE {			pc_FeatrGr p_5 AND DRX_S
setup SEQUENCE {			
onDurationTimer	psf40		
}			
}			
timeAlignmentTimerDedicated	Infinity		
}			
}			
}			

Condition	Explanation
DRX_S	Used for DRX configuration with small DRX cycle length

7.1.3.3 MAC PDU header handling

7.1.3.3.1 Test Purpose (TP)

(1)

```
with { UE in E-UTRA RRC_CONNECTED state }
ensure that {
  when { UE receives a MAC PDU containing an AMD PDU that is larger than 128 bytes with padding at
the end }
  then { UE successfully decodes the MAC PDU and forward to higher layer }
}
```

(2)

```
with { UE in E-UTRA RRC_CONNECTED state }
ensure that {
  when { UE receives a MAC PDU containing an AMD PDU that is smaller than 128 bytes with padding at
the end }
  then { UE successfully decodes the MAC PDU and forward to higher layer }
}
```

(3)

```
with { UE in E-UTRA RRC_CONNECTED state }
ensure that {
  when { UE receives a MAC PDU containing an single AMD PDU with no padding }
  then { UE successfully decodes the MAC PDU and forward to higher layer }
}
```

(4)

```
with { UE in E-UTRA RRC_CONNECTED state }
ensure that {
  when { UE receives a MAC PDU containing multiple MAC SDUs each containing an AMD PDU and no
padding }
  then { UE successfully decodes the MAC PDU and forwards the AMD PDUs to higher layer }
}
```

7.1.3.3.2 Conformance requirements

References: The conformance requirements covered in the present TC are specified in: 3GPP TS 36.321 clauses 6.1.2 and 6.2.1.

[TS 36.321, clause 6.1.2]

A MAC PDU consists of a MAC header, zero or more MAC Service Data Units (MAC SDU), zero, or more MAC control elements, and optionally padding; as described in Figure 6.1.2-3.

Both the MAC header and the MAC SDUs are of variable sizes.

A MAC PDU header consists of one or more MAC PDU sub-headers; each sub header corresponding to either a MAC SDU, a MAC control element or padding.

A MAC PDU sub header consists of the six header fields R/R/E/LCID/F/L but for the last sub header in the MAC PDU and for fixed sized MAC control elements. The last sub header in the MAC PDU and sub-headers for fixed sized MAC control elements consist solely of the four header fields R/R/E/LCID. It follows that a MAC PDU sub header corresponding to padding consists of the four header fields R/R/E/LCID.

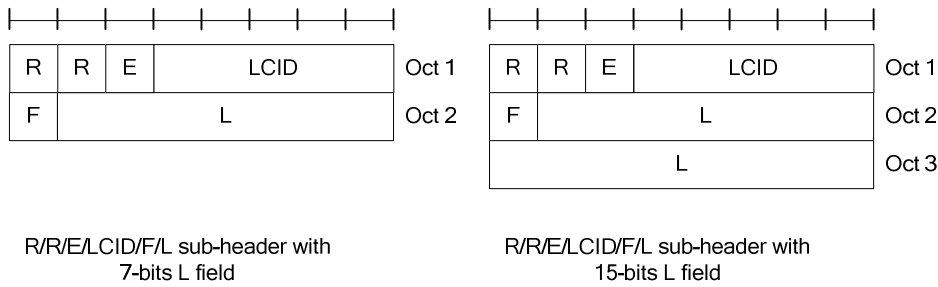

Figure 6.1.2-1: R/R/E/LCID/F/L MAC sub header

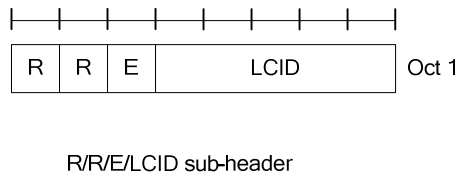

Figure 6.1.2-2: R/R/E/LCID MAC sub header

MAC PDU sub-headers have the same order as the corresponding MAC SDUs, MAC control elements and padding.

MAC control elements, are always placed before any MAC SDU.

Padding occurs at the end of the MAC PDU, except when single-byte or two-byte padding is required. Padding may have any value and the UE shall ignore it. When padding is performed at the end of the MAC PDU, zero or more padding bytes are allowed.

When single-byte or two-byte padding is required, one or two MAC PDU sub-headers corresponding to padding are placed at the beginning of the MAC PDU before any other MAC PDU subheader. A maximum of one MAC PDU can be transmitted per TB per UE.

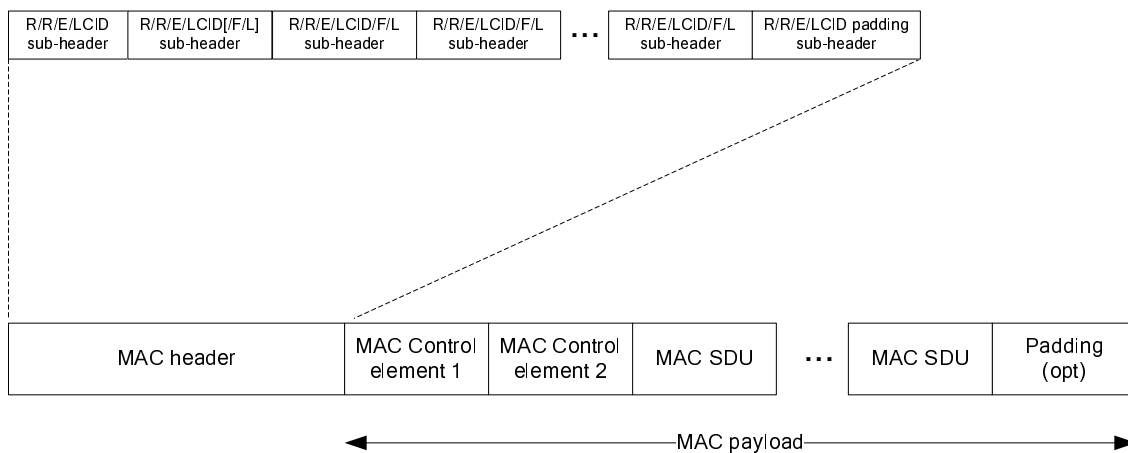

Figure 6.1.2-3: Example of MAC PDU consisting of MAC header, MAC control elements, MAC SDUs and padding

[TS 36.321, clause 6.2.1]

The MAC header is of variable size and consists of the following fields:

- LCID: The Logical Channel ID field identifies the logical channel instance of the corresponding MAC SDU or the type of the corresponding MAC control element or padding as described in tables 6.2.1-1 and 6.2.1-2 for the DL and UL-SCH respectively. There is one LCID field for each MAC SDU, MAC control element or padding

included in the MAC PDU. In addition to that, one or two additional LCID fields are included in the MAC PDU, when single-byte or two-byte padding is required but cannot be achieved by padding at the end of the MAC PDU. The LCID field size is 5 bits;

- L: The Length field indicates the length of the corresponding MAC SDU or MAC control element in bytes. There is one L field per MAC PDU sub header except for the last sub header and sub-headers corresponding to fixed-sized MAC control elements. The size of the L field is indicated by the F field;
- F: The Format field indicates the size of the Length field as indicated in table 6.2.1-3. There is one F field per MAC PDU sub header except for the last sub header and sub-headers corresponding to fixed-sized MAC control elements. The size of the F field is 1 bit. If the size of the MAC SDU or MAC control element is less than 128 bytes, the UE shall set the value of the F field to 0, otherwise the UE shall set it to 1;
- E: The Extension field is a flag indicating if more fields are present in the MAC header or not. The E field is set to "1" to indicate another set of at least R/R/E/LCID fields. The E field is set to "0" to indicate that either a MAC SDU, a MAC control element or padding starts at the next byte;
- R: Reserved bits, set to "0".

The MAC header and sub-headers are octet aligned.

Table 6.2.1-1: Values of LCID for DL-SCH

Index	LCID values
00000	CCCH
00001-01010	Identity of the logical channel
01011-11011	Reserved
11100	UE Contention Resolution Identity
11101	Timing Advance Command
11110	DRX Command
11111	Padding

Table 6.2.1-2: Values of LCID for UL-SCH

Index	LCID values
00000	CCCH
00001-01010	Identity of the logical channel
01011-11001	Reserved
11010	Power Headroom Report
11011	C-RNTI
11100	Truncated BSR
11101	Short BSR
11110	Long BSR
11111	Padding

Table 6.2.1-3: Values of F field:

Index	Size of Length field (in bits)
0	7
1	15

7.1.3.3.3 Test description

7.1.3.3.3.1 Pre-test conditions

System Simulator:

- Cell 1

UE:

None.

Preamble:

- The UE is in state Loopback Activated (state 4) according to [18].
- The UL RLC SDU size is set to not return any data.

7.1.3.3.3.2 Test procedure sequence

Table 7.1.3.3.3.2-1: Main behaviour

St	Procedure	Message Sequence		TP	Verdict
		U - S	Message		
1	The SS transmits a MAC PDU containing a RLC SDU of 130 bytes in an AMD PDU (SN=0) with polling field 'P' set to '1' and 5 bytes of padding. The MAC header contains two MAC sub-headers where the first MAC sub-header is a 3-byte R/R/E/LCID/F/L MAC sub-header with 'E' field set to '1', the 'F' set to '1', the 'LCID' field set to '00011' and the 'L' field set to '132' bytes. The second MAC sub-header is a padding control 1byte R/R/E/LCID MAC sub-header with 'E' field set to '0' and 'LCID' field set to '11111'.	<--	MAC PDU (R/R/E/LCID/F/L MAC sub-header (E='1', LCID='00011', F='1', L='132'), MAC R/R/E/LCID MAC sub-header (E='0', LCID='11111'), 132 bytes MAC SDU and 5 bytes padding)	-	-
2	Check: Does the UE transmit a MAC PDU containing an RLC STATUS PDU acknowledging the reception of the AMD PDU in step 1?	-->	MAC PDU (RLC STATUS PDU (ACK_SN '1'))	1	P
3	The SS transmits a MAC PDU containing a RLC SDU of 40 bytes in an AMD PDU(SN=1) with polling field 'P' set to '1'and 4 bytes of padding. The MAC header contains two MAC sub-headers where the first MAC sub-header is a 2-byte R/R/E/LCID/F/L MAC sub-header with 'E' field set to '1', the 'F' set to '0', the 'LCID' field set to '00011' and the 'L' field set to '42' bytes. The second MAC sub-header is a padding control 1byte R/R/E/LCID MAC sub-header with 'E' field set to '0' and 'LCID' field set to '11111'.	<--	MAC PDU (R/R/E/LCID/F/L MAC sub-header (E='1', LCID='00011', F='0', L='42'), R/R/E/LCID MAC sub-header (E='0', LCID='11111'), 42 bytes MAC SDU and 4 bytes padding)	-	-
4	Check: Does the UE transmit a MAC PDU containing an RLC STATUS PDU acknowledging the reception of the AMD PDU in step 3?	-->	MAC PDU (RLC STATUS PDU (ACK_SN '2'))	2	P
5	The SS transmits a MAC PDU containing a MAC SDU with a RLC SDU of 130 bytes in an AMD PDU(SN=2) with polling field 'P' set to '1'. The MAC header contains one R/R/E/LCID MAC sub-header with 'E' field set to '0' and the 'LCID' field set to '00011'.	<--	MAC PDU (R/R/E/LCID MAC sub-header (E='0', LCID='00011'), 132 bytes MAC SDU)	-	-
6	Check: Does the UE transmit a MAC PDU containing an RLC STATUS PDU acknowledging the reception of the AMD PDU in step 5?	-->	MAC PDU (RLC STATUS PDU (ACK_SN '3'))	3	P
7	The SS transmits a MAC PDU containing one MAC SDU containing a RLC SDU of size 128 bytes in an AMD PDU (SN=3) and five MAC SDUs each containing a RLC SDU of 41 bytes in an AMD PDU (SN=4 to 8) in an AMD PDU with the polling field 'P' set to '1' in the last AMD PDU. The MAC header contains six MAC sub-headers where the first MAC sub-header contains a 3 byte R/R/E/LCID/F/L MAC sub-header with 'E' field set to '1', 'LCID' field set to '00011', 'F' field set to '1' and the 'L' field set to '130'. The second to fifth MAC sub-header are two byte R/R/E/LCID/F/L MAC sub-headers with 'E' field set to '1', 'LCID' field set to '00011', 'F' field set to '0' and the 'L' field set to '43' bytes. The sixth MAC sub-header is a one byte R/R/E/LCID MAC sub-header with 'E' field set to '0' and the 'LCID' field set to '00011'.	<--	MAC PDU (R/R/E/LCID/L MAC sub-header (E='1', LCID='00011', F='1', L='130'), 4 x R/R/E/LCID/L MAC sub-header (E='1', LCID='00011', F='0', L='43'), R/R/E/LCID MAC sub-header (E='0', LCID='00011'), 130 bytes MAC SDU, 5 x 43 bytes MAC SDUs)	4	-

8	Check: Does the UE transmit a MAC PDU containing an RLC STATUS PDU acknowledging the reception of the AMD PDUs in step 7?	-->	MAC PDU (RLC STATUS PDU (ACK_SN '9'))	4	P
---	---	-----	---------------------------------------	---	---

7.1.3.3.3.3 Specific Message Contents

Table 7.1.2.9.3.3-1: SystemInformationBlockType2 (all steps, table 7.1.2.3.3.2-1)

Derivation path: 36.508 clause 4.4.3.3, Table 4.4.3.3-1			
Information Element	Value/Remark	Comment	Condition
SystemInformationBlockType2 ::= SEQUENCE {			
radioResourceConfigCommon SEQUENCE {			
rach-Configuration SEQUENCE {			
preambleInformation SEQUENCE {			
numberOfRA-Preambles	n64		
preamblesGroupAConfig := {SEQUENCE {			
sizeOfRA-PreamblesGroupA	n28		
messageSizeGroupA	b208		
messagePowerOffsetGroupB	minusinfinity		
}			
}			
}			
}			
ue-TimersAndConstants SEQUENCE{			
t300	ms1500	T300	
}			
}			
}			
}			
}			

7.1.3.4 Correct HARQ process handling / DCCH and DTCH

7.1.3.4.1 Test Purpose (TP)

(1)

```
with { UE in E-UTRA RRC_CONNECTED state with DRB established }
ensure that {
  when { the UE receives a MAC PDU for DRB and decode fails }
  then { the UE transmits a NACK for the corresponding HARQ process }
}
```

(2)

```
with { UE in E-UTRA RRC_CONNECTED state with DRB established }
ensure that {
  when { the UE receives a MAC PDU retransmission for DRB, and results in successful decode}
  then { the UE transmits an ACK for the corresponding HARQ process and delivers data to upper layers }
}
```

7.1.3.4.2 Conformance requirements

References: The conformance requirements covered in the current TC are specified in: TS 36.321, clause 5.3.2.1 & 5.3.2.2.

[TS 36.321, clause 5.3.2.1]

There is one HARQ entity at the UE which maintains a number of parallel HARQ processes. Each HARQ process is associated with a HARQ process identifier. The HARQ entity directs HARQ information and associated TBs received on the DL-SCH to the corresponding HARQ processes (see subclause 5.3.2.2).

The number of DL HARQ processes is specified in [2], clause 7.

When the physical layer is configured for spatial multiplexing [2], one or two TBs are expected per subframe and they are associated with the same HARQ process. Otherwise, one TB is expected per subframe.

The UE shall:

- If a downlink assignment has been indicated for this TTI:
 - allocate the TBs received from the physical layer and the associated HARQ information to the HARQ process indicated by the associated HARQ information.
- If a downlink assignment has been indicated for the broadcast HARQ process:
 - allocate the received TB to the broadcast HARQ process.

NOTE: In case of BCCH a dedicated broadcast HARQ process is used.

[TS 36.321, clause 5.3.2.2]

For each subframe where a transmission takes place for the HARQ process, one or two (in case of spatial multiplexing) TBs and the associated HARQ information are received from the HARQ entity.

For each received TB and associated HARQ information, the HARQ process shall:

- if the NDI, when provided, has been toggled compared to the value of the previous received transmission corresponding to this TB; or
- if the HARQ process is equal to the broadcast process and if this is the first received transmission for the TB according to the system information schedule indicated by RRC; or
- if this is the very first received transmission for this TB (i.e. there is no previous NDI for this TB):
 - consider this transmission to be a new transmission.
- else:
 - consider this transmission to be a retransmission.

The UE then shall:

- if this is a new transmission
 - replace the data currently in the soft buffer for this TB with the received data.
- else if this is a retransmission:
 - if the data has not yet been successfully decoded:
 - combine the received data with the data currently in the soft buffer for this TB.
 - if the TB size is different from the last valid TB size signalled for this TB:
 - the UE may replace the data currently in the soft buffer for this TB with the received data.
- attempt to decode the data in the soft buffer for this TB;
- if the data in the soft buffer was successfully decoded for this TB:
 - if the HARQ process is equal to the broadcast process, deliver the decoded MAC PDU to upper layers.
 - else if this is the first successful decoding of the data in the soft buffer for this TB:
 - deliver the decoded MAC PDU to the disassembly and demultiplexing entity.
 - generate a positive acknowledgement (ACK) of the data in this TB.
- else:
 - generate a negative acknowledgement (NACK) of the data in this TB.

- if the HARQ process is associated with a transmission indicated with a Temporary C-RNTI and the Contention Resolution is not successful (see subclause 5.1.5); or
- if the HARQ process is equal to the broadcast process; or
- - if *timeAlignmentTimer* is stopped or expired:
 - do not indicate the generated positive or negative acknowledgement to the physical layer.
- else:
 - indicate the generated positive or negative acknowledgement for this TB to the physical layer.

The UE shall ignore NDI received in all downlink assignments on PDCCH for its Temporary C-RNTI when determining if NDI on PDCCH for its C-RNTI has been toggled compared to the value in the previous transmission.

7.1.3.4.3 Test description

7.1.3.4.3.1 Pre-test conditions

System Simulator:

- Cell 1
- RRC Connection Reconfiguration (preamble: Table 4.5.3.3-1, step 8) using parameters as specified in Table 7.1.3.4.3.3-1

UE:

None.

Preamble:

- The UE is in state Loopback Activated (state 4) according to [18].

7.1.3.4.3.2 Test procedure sequence

Table 7.1.3.4.3.2-1: Main behaviour

St	Procedure	Message Sequence		TP	Verdict
		U - S	Message		
-	EXCEPTION: Steps 1 to 7 are run 8[FDD]/7[TDD] times using test parameter values as given for each iteration in table 7.1.3.4.3.2.-2.	-	-	-	-
1	The SS indicates a new transmission on PDCCH and transmits a MAC PDU (containing an RLC PDU), with content set so that UE could not successfully decode the data from its soft buffer. The AMD PDU contains a full RLC SDU. (Note 1)	<--	MAC PDU	1	-
2	Check: Does the UE transmit a HARQ NACK?	-->	HARQ NACK		P
	EXCEPTION: Step 3 shall be repeated till HARQ ACK is received at step 4 or until HARQ retransmission count = 4 is reached for MAC PDU at step 3 (Note 2).				
3	The SS indicates a retransmission on PDCCH and transmits the same MAC PDU like step 1 (Note 1).	<--	MAC PDU	-	-
	EXCEPTION: Up to 3 HARQ NACK from the UE should be allowed at step 4 (Note 2).				
4	Check: Does the UE send a HARQ ACK?	-->	HARQ ACK	2	P
5	UE transmit a Scheduling Request on PUCCH	-->	(SR)	-	-
6	The SS sends an UL grant suitable for the loop back PDU to transmitted	<--	(UL Grant)	-	-
7	The UE transmit a MAC PDU containing the loop back PDU corresponding to step 1 and 3	-->	MAC PDU	-	-
Note 1: SS should transmit this PDU using $I_{TBS}=6$, $N_{PRB}=1$, see TS 36.213 Table 7.1.7.2.1-1. This will result in TBSsize of 328 and having coding rate more than 1. Note 2: The value 4 for the maximum number of HARQ retransmissions has been chosen based on an assumption that, given the radio conditions used in this test case, a UE soft combiner implementation should have sufficient retransmissions to be able to successfully decode the data in its soft buffer.					

Table 7.1.3.4.3.2-2: Test Parameters

Iteration	DL HARQ process (X)
1	0
2	1
3	2
4	3
5	4
6	5
7	6
8	7[only for FDD]
Note: The maximum DL HARQ process is 7 for TDD configuration 1.	

7.1.3.4.3.3 Specific message contents

Table 7.1.3.4.3.3-1: RRCConnectionReconfiguration (preamble: Table 4.5.3.3-1, step 8)

Derivation path: 36.508 table 4.8.2.1.5-1			
Information Element	Value/Remark	Comment	Condition
RRCConnectionReconfiguration ::= SEQUENCE {			
criticalExtensions CHOICE {			
c1 CHOICE{			
rrcConnectionReconfiguration-r8 SEQUENCE {			
RadioResourceConfigDedicated SEQUENCE {			
mac-MainConfig CHOICE {			
timeAlignmentTimerDedicated	Infinity		
}			
}			
}			
}			
}			
}			
}			

7.1.3.5 Correct HARQ process handling / CCCH

7.1.3.5.1 Test Purpose (TP)

(1)

```
with { UE in E-UTRA RRC_IDLE state with RRC connection establishment procedure initiated }
ensure that {
  when { UE receives a MAC PDU addressed to RA-RNTI }
  then { UE does not transmit ACK/NACK for the corresponding HARQ process }
}
```

(2)

```
with { UE in E-UTRA RRC_IDLE state with RRC connection establishment procedure initiated }
ensure that {
  when { UE receives a MAC PDU addressed to T-CRNTI without UE Contention Resolution Identity
  matching the one included in the RRCConnectionRequest message }
  then { UE does not transmit a ACK/NACK for the corresponding HARQ process }
}
```

(3)

```
with { UE in E-UTRA RRC_IDLE state with RRC connection establishment procedure initiated }
ensure that {
  when { UE receives a MAC PDU addressed to T-CRNTI and cannot decode properly }
  then { UE does not transmits a NACK for the corresponding HARQ }
}
```

(4)

```
with { UE in E-UTRA RRC_IDLE state with RRC connection establishment procedure initiated }
ensure that {
  when { UE receives a MAC PDU addressed to T-CRNTI with UE Contention Resolution Identity matching
  the one included in the RRCConnectionRequest message }
  then { UE transmits an ACK for the corresponding HARQ process and delivers data to upper layers }
}
```

7.1.3.5.2 Conformance requirements

References: The conformance requirements covered in the current TC are specified in: TS 36.321, clause 5.3.2.1 and 5.3.2.2.

[TS 36.321, clause 5.3.2.1]

There is one HARQ entity at the UE which maintains a number of parallel HARQ processes. Each HARQ process is associated with a HARQ process identifier. The HARQ entity directs HARQ information and associated TBs received on the DL-SCH to the corresponding HARQ processes (see subclause 5.3.2.2).

The number of DL HARQ processes is specified in [2], clause 7.

When the physical layer is configured for spatial multiplexing [2], one or two TBs are expected per subframe and they are associated with the same HARQ process. Otherwise, one TB is expected per subframe.

The UE shall:

- If a downlink assignment has been indicated for this TTI:
 - allocate the TBs received from the physical layer and the associated HARQ information to the HARQ process indicated by the associated HARQ information.
- If a downlink assignment has been indicated for the broadcast HARQ process:
 - allocate the received TB to the broadcast HARQ process.

NOTE: In case of BCCH a dedicated broadcast HARQ process is used.

[TS 36.321, clause 5.3.2.2]

For each subframe where a transmission takes place for the HARQ process, one or two (in case of spatial multiplexing) TBs and the associated HARQ information are received from the HARQ entity.

For each received TB and associated HARQ information, the HARQ process shall:

- if the NDI, when provided, has been toggled compared to the value of the previous received transmission corresponding to this TB; or
- if the HARQ process is equal to the broadcast process and if this is the first received transmission for the TB according to the system information schedule indicated by RRC; or
- if this is the very first received transmission for this TB (i.e. there is no previous NDI for this TB):
 - consider this transmission to be a new transmission.
- else:
 - consider this transmission to be a retransmission.

The UE then shall:

- if this is a new transmission
 - replace the data currently in the soft buffer for this TB with the received data.
- if a retransmission is indicated for this TB:
 - if the data has not yet been successfully decoded:
 - combine the received data with the data currently in the soft buffer for this TB.
 - if the TB size is different from the last valid TB size signalled for this TB:
 - the UE may replace the data currently in the soft buffer for this TB with the received data.
- attempt to decode the data in the soft buffer for this TB;
- if the data in the soft buffer was successfully decoded for this TB:
 - if the HARQ process is equal to the broadcast process:
 - deliver the decoded MAC PDU to upper layers.
 - else if this is the first successful decoding of the data in the soft buffer for this TB:

- deliver the decoded MAC PDU to the disassembly and demultiplexing entity.
- generate a positive acknowledgement (ACK) of the data in this TB.
- else:
 - generate a negative acknowledgement (NACK) of the data in this TB.
- if the HARQ process is associated with a transmission indicated with a Temporary C-RNTI and a UE the Contention Resolution Identity match is not indicated successful (see subclause 5.1.5); or
- if the HARQ process is equal to the broadcast process; or
- if *timeAlignmentTimer* is stopped or expired:
 - do not indicate the generated positive or negative acknowledgement to the physical layer.
- else:
 - indicate the generated positive or negative acknowledgement for this TB to the physical layer.

The UE shall ignore NDI received in all downlink assignments on PDCCH for its Temporary C-RNTI when determining if NDI on PDCCH for its C-RNTI has been toggled compared to the value in the previous transmission.

7.1.3.5.3 Test description

7.1.3.5.3.1 Pre-test conditions

System Simulator:

- Cell 1
- System information taking into account parameters in table 7.1.3.5.3.3-1

UE:

None.

Preamble:

- The UE is in state Registered, Idle mode state (state 2) according to [18].

7.1.3.5.3.2 Test procedure sequence

Table 7.1.3.5.3.2-1: Main behaviour

St	Procedure	Message Sequence		TP	Verdict
		U - S	Message		
1	The SS transmits a Paging message including a matched identity.	<--	-	-	-
2	The UE transmits Preamble on PRACH	-->	PRACH Preamble	-	-
3	The SS transmits Random Access Response with matching RA-Id and including T-CRNTI. The CRC is calculated in such a way, it will result in CRC error on UE side	<--	Random Access Response	-	-
4	Check: does the UE transmit a HARQ ACK/NACK?	-->	HARQ ACK/NACK	1	F
5	The UE transmits Preamble on PRACH	-->	PRACH Preamble	-	-
6	The SS transmits Random Access Response with matching RA-Id and including T-CRNTI. The CRC is calculated in such a way, it will result in CRC pass on UE side.	<--	Random Access Response	-	-
7	Check: does the UE transmit a HARQ ACK/NACK?	-->	HARQ ACK/NACK	1	F
8	The UE transmits a MAC PDU containing an <i>RRCCoNNECTIONRequest</i> message.	-->	MAC PDU	-	-
9	The SS transmits a valid MAC PDU containing <i>RRCCoNNECTIONSetup</i> , and including 'UE Contention Resolution Identity' MAC control element with not matching 'Contention Resolution Identity'.	<--	MAC PDU	-	-
10	Check: does the UE transmit a HARQ ACK/NACK?	-->	HARQ ACK/NACK	2	F
11	The UE transmits Preamble on PRACH	-->	PRACH Preamble	-	-
12	The SS transmits Random Access Response with matching RA-Id and including T-CRNTI.	<--	Random Access Response	-	-
13	The UE transmits a MAC PDU containing an <i>RRCCoNNECTIONRequest</i> message.	-->	MAC PDU	-	-
14	The SS transmits a valid MAC PDU containing <i>RRCCoNNECTIONSetup</i> , and including 'UE Contention Resolution Identity' MAC control element with matching 'Contention Resolution Identity'. The CRC is calculated in such a way that it will result in CRC error on UE side	<--	MAC PDU	-	-
15	Check: Does UE transmit a HARQ NACK?	-->	HARQ NACK	3	F
16	The UE transmits Preamble on PRACH	-->	PRACH Preamble	-	-
17	The SS transmits Random Access Response with matching RA-Id and including T-CRNTI.	<--	Random Access Response	-	-
18	The UE transmits a MAC PDU containing an <i>RRCCoNNECTIONRequest</i> message.	-->	MAC PDU	-	-
19	The SS transmits the same MAC PDU like in step 14, but the CRC is calculated in such a way that it will result in CRC pass on UE side	<--	MAC PDU	-	-
20	Check: does the UE transmit a HARQ ACK?	-->	HARQ ACK	4	P
21	The UE transmits a MAC PDU containing an <i>RRCCoNNECTIONSetupComplete</i> message including SERVICE REQUEST message indicating acceptance of <i>RRCCoNNECTIONSetup</i> message	-->	MAC PDU	-	-
22-25	Steps 6 to 9 of the generic radio bearer establishment procedure (TS 36.508 4.5.3.3-1) are executed to successfully complete the service request procedure.	-	-	-	-

7.1.3.5.3.3 Specific message contents

Table 7.1.3.5.3.3-1: SystemInformationBlockType2 (all steps, table 7.1.3.5.3.2-1)

Derivation path: 36.508 table 4.4.3.3-1			
Information Element	Value/Remark	Comment	Condition
SystemInformationBlockType2 ::= SEQUENCE {			
radioResourceConfigCommon SEQUENCE {			
rach-Configuration SEQUENCE {			
ra-SupervisionInformation SEQUENCE {			
preambleTransMax	n8		
mac-ContentionResolutionTimer	sf64	Max Value	
}			
}			
prach-Configuration SEQUENCE {			
prach-ConfigInfo SEQUENCE {			
prach-ConfigurationIndex	1	As per table 5.7.1-2 of 36.211, this results in PRACH preamble transmission start in even frame numbers and sub-frame number 4	FDD
prach-ConfigurationIndex	0	As per table 5.7.1-4 of 36.211, this results in PRACH preamble transmission with frequency resource index=0; occurring in even radio frames; resource is located in first half frame and sub frame number 3 Note 1	TDD
}			
}			
}			
ue-TimersAndConstants SEQUENCE{			
t300	ms2000	T300	
}			
}			

7.1.3.6 Correct HARQ process handling / BCCH

7.1.3.6.1 Test Purpose (TP)

(1)

```

with { UE in E-UTRA RRC_CONNECTED state }
ensure that {
  when { UE receives a MAC PDU addressed to SI-RNTI }
  then { UE does not send any ACK/NACK for the corresponding dedicated HARQ process }
}

```

7.1.3.6.2 Conformance requirements

References: The conformance requirements covered in the current TC are specified in: TS 36.321, clause 5.3.2.1 & 5.3.2.2.

[TS 36.321, clause 5.3.2.1]

There is one HARQ entity at the UE which maintains a number of parallel HARQ processes. Each HARQ process is associated with a HARQ process identifier. The HARQ entity directs HARQ information and associated TBs received on the DL-SCH to the corresponding HARQ processes (see subclause 5.3.2.2).

The number of DL HARQ processes is specified in [2], clause 7.

When the physical layer is configured for spatial multiplexing [2], one or two TBs are expected per subframe and they are associated with the same HARQ process. Otherwise, one TB is expected per subframe.

The UE shall:

- If a downlink assignment has been indicated for this TTI:
 - allocate the TBs received from the physical layer and the associated HARQ information to the HARQ process indicated by the associated HARQ information.
- If a downlink assignment has been indicated for the broadcast HARQ process:
 - allocate the received TB to the broadcast HARQ process.

NOTE: In case of BCCH a dedicated broadcast HARQ process is used.

[TS 36.321, clause 5.3.2.2]

For each subframe where a transmission takes place for the HARQ process, one or two (in case of spatial multiplexing) TBs and the associated HARQ information are received from the HARQ entity.

For each received TB and associated HARQ information, the HARQ process shall:

- if the NDI, when provided, has been toggled compared to the value of the previous received transmission corresponding to this TB; or
- if the HARQ process is equal to the broadcast process and if the physical layer indicates a new transmission for the TB according to the system information schedule indicated by RRC; or
- if this is the very first received transmission for this TB (i.e. there is no previous NDI for this TB):
 - consider this transmission to be a new transmission.
- else:
 - consider this transmission to be a retransmission.

The UE then shall:

- if this is a new transmission:
 - replace the data currently in the soft buffer for this TB with the received data.
- else if this is a retransmission:
 - if the data has not yet been successfully decoded:
 - combine the received data with the data currently in the soft buffer for this TB.
 - if the TB size is different from the last valid TB size signalled for this TB:
 - the UE may replace the data currently in the soft buffer for this TB with the received data.
- attempt to decode the data in the soft buffer for this TB;
- if the data in the soft buffer was successfully decoded for this TB:
 - if the HARQ process is equal to the broadcast process:
 - deliver the decoded MAC PDU to upper layers.
 - else if this is the first successful decoding of the data in the soft buffer for this TB:

- deliver the decoded MAC PDU to the disassembly and demultiplexing entity.
- generate a positive acknowledgement (ACK) of the data in this TB.
- else:
 - generate a negative acknowledgement (NACK) of the data in this TB.
- if the HARQ process is associated with a transmission indicated with a Temporary C-RNTI and the Contention Resolution is not yet successful (see subclause 5.1.5); or
- if the HARQ process is equal to the broadcast process; or
- if *timeAlignmentTimer* is stopped or expired:
 - do not indicate the generated positive or negative acknowledgement to the physical layer.
- else:
 - indicate the generated positive or negative acknowledgement for this TB to the physical layer.

The UE shall ignore NDI received in all downlink assignments on PDCCH for its Temporary C-RNTI when determining if NDI on PDCCH for its C-RNTI has been toggled compared to the value in the previous transmission.

7.1.3.6.3 Test description

7.1.3.6.3.1 Pre-test conditions

System Simulator:

- Cell 1

UE:

- None.

Preamble:

- The UE is in state Loopback Activated (state 4) according to [18].
- RRC Connection Reconfiguration (Preamble: Table 4.5.3.3-1) using parameters as specified in Table 7.1.3.6.3-4

7.1.3.6.3.2 Test procedure sequence

Table 7.1.3.6.3.2-1: Main behaviour

St	Procedure	Message Sequence		TP	Verdict
		U - S	Message		
A	The SS transmits a <i>Paging</i> message including the <i>systemInfoModification</i> . (Note 1)	-	-	-	-
1	The SS transmits an updated system information with SI-RNTI addressed in L1/L2 header at the start of the modification period. CRC is calculated in such a way, it will result in CRC fail on UE side. Dedicated HARQ process for broadcast is used.	<--	-	-	-
2	Check: Does the UE transmit a HARQ ACK/NACK? (Note 2 and 3)	-->	HARQ ACK/NACK	1	F
3	Void	-	-	-	-
4	Void	-	-	-	-
5	Void	-	-	-	-
6	After 100ms of step 2, the SS transmits an updated system information [contents same as in step 1] with SI-RNTI addressed in L1/L2 header. CRC is calculated in such a way, it will result in CRC pass on UE side. Dedicated HARQ process for broadcast is used.	-	-	-	-
7	Check: Does the UE transmit an ACK/NACK? (Note 2 and 4)	->	HARQ ACK/NACK	1	F
8	SS is configured to not allocate UL Grants on Scheduling Request	-	-	-	-
9	The SS Transmits MAC PDU containing a RLC PDU	<--	MAC PDU	-	-
10	The UE transmits a HARQ ACK	-->	HARQ ACK	-	-
11	Check: Does the UE transmit PRACH Preamble, using PRACH resources as in new SI?	-->	PRACH Preamble	1	P
12	The SS transmits Random Access Response	<--	Random Access Response	-	-
13	The UE transmits a MAC PDU with C-RNTI containing loop backed RLC PDU	-->	MAC PDU	-	-
14	SS sends PDCCH transmission for UE C-RNTI to complete contention resolution.	-	-	-	-
Note 1:	To guarantee that the UE will receive at least one Paging in the Modification Period preceding the SysInfo change, SS should send the Paging message in every eligible PO in this Modification Period.				
Note 2:	When requested to check HARQ feedback for the dedicated broadcast HARQ process, the SS shall assume the same PUCCH reception requirement as specified in TS 36.213 section 10 for a normal HARQ process.				
Note 3:	For duration of 100ms, the SS should check HARQ NACK for all broadcast SIBs. This duration is sufficient to ensure that SS transmits few times SIBs with CRC corruption.				
Note 4:	For duration of 5020ms (5120 - 100), the SS should check HARQ ACK for all broadcast SIBs. 5120ms is the system information modification period calculated based on the default values of parameters specified in TS 36.508.(modification period = modificationPeriodCoeff * defaultPagingCycle, and in TS 36.508, modificationPeriodCoeff=4 and defaultPagingCycle=128radio frames).				

7.1.3.6.3.3 Specific message contents

Table 7.1.3.6.3.3-1: SystemInformationBlockType2 (steps 1 and 6 of table 7.1.3.6.3.2-1)

Derivation path: 36.508 table 4.4.3.3-1			
Information Element	Value/Remark	Comment	Condition
SystemInformationBlockType2 ::= SEQUENCE {			
radioResourceConfigCommon SEQUENCE {			
prach-Config SEQUENCE {			
rootSequenceIndex	20 ($u = 2$, Value different than default in TS 36.508)		FDD
rootSequenceIndex	2 ($u = 2$, Value different than default in TS 36.508)	rootSequenceIndex should take value from table of 5.7.2-5 in TS 36.211 since, the PRACH format 4 is used as default for testing for TDD.	TDD
}			
}			
}			

Table 7.1.3.6.3.3-2: Paging (step A, 5 of table 7.1.3.6.3.2-1)

Derivation path: 36.508 table 4.6.1-7			
Information Element	Value/Remark	Comment	Condition
Paging ::= SEQUENCE {			
pagingRecordList	Not present		
systemInfoModification	true		
etws-Indication	Not present		
nonCriticalExtension SEQUENCE {}	Not present		
}			

Table 7.1.3.6.3.3-3: SystemInformationBlockType1 (step 1 of table 7.1.3.6.3.2-1)

Derivation Path: 36.508 clause 4.4.3.2			
Information Element	Value/remark	Comment	Condition
SystemInformationBlockType1 ::= SEQUENCE {			
systemInfoValueTag	1		
}			

Table 7.1.3.6.3.3-4: RRCConnectionReconfiguration (Preamble)

Derivation path: 36.508 table 4.8.2.1.5-1			
Information Element	Value/Remark	Comment	Condition
RRCConnectionReconfiguration ::= SEQUENCE {			
criticalExtensions CHOICE {			
c1 CHOICE{			
rrcConnectionReconfiguration-r8 SEQUENCE {			
RadioResourceConfigDedicated SEQUENCE {			
mac-MainConfig CHOICE {			
timeAlignmentTimerDedicated	Infinity		
}			
}			
}			
}			
}			

7.1.3.7 MAC padding

7.1.3.7.1 Test Purpose (TP)

(1)

```
with { UE in E-UTRA RRC_CONNECTED state }
ensure that {
  when { UE is receiving RLC PDUs in MAC PDUs with padding greater than 2 bytes }
  then { UE acknowledges reception of the RLC PDUs }
}
```

(2)

```
with { UE in E-UTRA RRC_CONNECTED state }
ensure that {
  when { UE is receiving RLC PDUs in MAC PDUs with padding equal to or less than 2 bytes }
  then { UE acknowledges reception of the RLC PDUs }
}
```

(3)

```
with { UE in E-UTRA RRC_CONNECTED state }
ensure that {
  when { SS is transmitting a MAC control Timing Advance PDU with padding equal to or less than 2
  bytes and no Data MAC PDU sub-headers followed by transmitting a RLC PDU }
  then { UE acknowledges reception of the RLC PDU using the new Timing Advance }
}
```

7.1.3.7.2 Conformance requirements

References: The conformance requirements covered in the current TC are specified in: TS 36.321, clause 6.1.2.

[TS 36.321 clause 6.1.2]

Padding occurs at the end of the MAC PDU, except when single-byte or two-byte padding is required. Padding may have any value and the UE shall ignore it. When padding is performed at the end of the MAC PDU, zero or more padding bytes are allowed.

When single-byte or two-byte padding is required, one or two MAC PDU subheaders corresponding to padding are placed at the beginning of the MAC PDU before any other MAC PDU subheader.

A maximum of one MAC PDU can be transmitted per TB per UE.

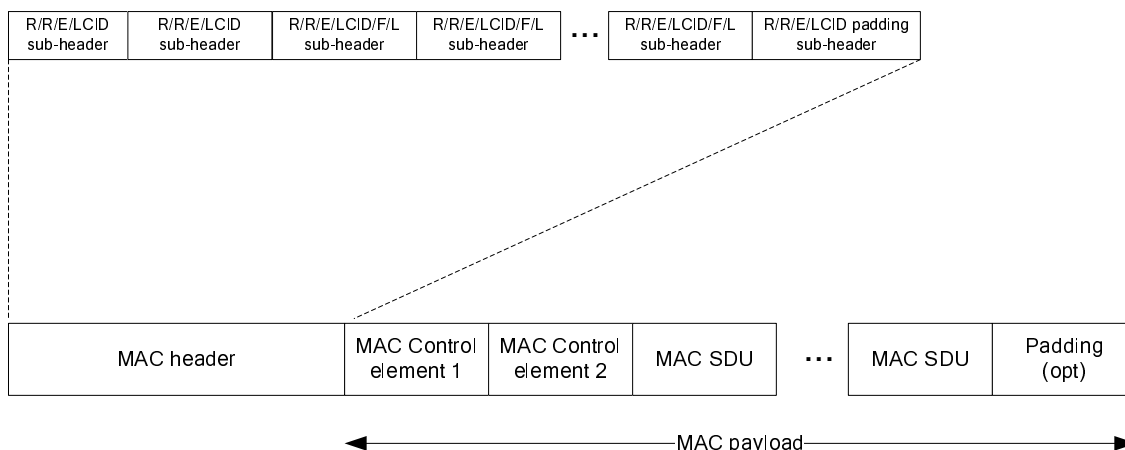

Figure 6.1.2-3: Example of MAC PDU consisting of MAC header, MAC control elements, MAC SDUs and padding

7.1.3.7.3 Test description

7.1.3.7.3.1 Pre-test conditions

System Simulator:

- Cell 1

UE:

None.

Preamble:

- The UE is in state Loopback Activated (state 4) according to [18].
- The UL RLC SDU size is set to not return any data.

7.1.3.7.3.2 Test procedure sequence

Table 7.1.3.7.3.2-1: Main behaviour

St	Procedure	Message Sequence		TP	Verdict
		U - S	Message		
1	The SS transmits a MAC PDU containing an RLC SDU in an AMD PDU with polling field 'P' set to '1'. The MAC SDU payload is set 8 bytes smaller than the TB size allocated in the DL Assignment minus AMD PDU and MAC headers. SS adds a 7-byte padding at the end of the MAC PDU and inserts a MAC padding sub-header after the MAC SDU sub-header.	<--	MAC PDU(AMD PDU, 7-byte padding)	-	-
2	Check: Does the UE transmit an RLC STATUS PDU with ACK_SN field equal to 1?	-->	RLC STATUS PDU (ACK_SN '1')	1	P
3	The SS transmits a MAC PDU containing an RLC SDU in an AMD PDU with polling field 'P' set to '1'. The MAC SDU payload is set to 1-byte smaller than the TB size allocated in the DL Assignment minus AMD PDU and MAC headers. SS adds a 1 byte padding by inserting a MAC PDU sub-header before first Data MAC PDU sub-header.	<--	MACPDU(AMD PDU, one byte padding)	-	-
4	Check: Does the UE transmit an RLC STATUS PDU with ACK_SN field equal to 2?	-->	MAC PDU(RLC STATUS PDU (ACK_SN =2))	2	P
5	The SS sets the downlink assignment for TBS of '16-bits'	-	-	-	-
6	The SS transmits a Timing Advance without any additional padding. Start Timer_1 = Time Alignment timer value.	<--	MAC Control PDU(Timing Advance)	-	-
7	The SS sets the downlink assignment for TBS of '24-bits'	-	-	-	-
8	The SS waits a time period equal to 0.5 of Timer_1 value and configures a MAC PDU that consists of only a Control MAC PDU sub header (8-bits). Transmit another Timing Advance MAC PDU (8-bits) which leaves 1-byte padding. The SS does not transmit any subsequent timing alignment. Restart Timer_1 = Time Alignment timer value	<--	MAC Control Element (Timing Advance) + 1-byte padding	-	-
9	The SS waits a time period equal to 0.7 of Timer_1.	-	-	-	-
9A	SS transmits MAC PDU containing one RLC SDU in an AMD PDU with polling field 'P' set to '1'.	<--	MAC PDU(AMD PDU (SN=2, P=1))	-	-
10	Check: Does the UE transmit an RLC STATUS PDU acknowledging the reception of the RLC PDU in step 9 with new Timing Advance?	-->	MAC PDU(RLC STATUS PDU (ACK_SN =3))	3	P

7.1.3.7.3.3 Specific Message Contents

None.

7.1.3.8 Void

7.1.3.9 MAC reset / DL

7.1.3.9.1 Test Purpose (TP)

(1)

```
with { UE in E-UTRA RRC_CONNECTED state }
ensure that {
  when { UE MAC is reset, due to handover to a new cell }
  then { UE flushes DL HARQ buffer }
}
```

(2)

```
with { UE in E-UTRA RRC_CONNECTED state }
ensure that {
  when { UE MAC is reset, due to handover to a new cell }
  then { UE considers the next transmission for each DL HARQ process as very first }
}
```

7.1.3.9.2 Conformance requirements

References: The conformance requirements covered in the current TC are specified in: TS 36.321, clause 5.9.

[TS 36.321 clause 5.9]

If a reset of the MAC entity is requested by upper layers, the UE shall:

- initialize B_j for each logical channel to zero;
- stop (if running) all timers;
- consider the *timeAlignmentTimer* as expired and perform the corresponding actions in subclause 5.2;
- set the NDIs for all uplink HARQ processes to the value 0;
- stop, if any, ongoing RACH procedure;
- discard explicitly signalled ra-PreambleIndex and ra-PRACH-MaskIndex, if any;
- flush Msg3 buffer;
- cancel, if any, triggered Scheduling Request procedure;
- cancel, if any, triggered Buffer Status Reporting procedure;
- cancel, if any, triggered Power Headroom Reporting procedure;
- flush the soft buffers for all DL HARQ processes;
- for each DL HARQ process, consider the next received transmission for a TB as the very first;
- release, if any, Temporary C-RNTI.

7.1.3.9.3 Test description

7.1.3.9.3.1 Pre-test conditions

System Simulator:

- Cell 1 and Cell 2

UE:

None.

Preamble:

- The UE is in state Loopback Activated (state 4) in Cell 1 according to [18] using parameters as specified in Table 7.1.3.9.3.3-3.

7.1.3.9.3.2 Test procedure sequence

Table 7.1.3.9.3.2-1 illustrates the downlink power levels and other changing parameters to be applied for the cells at various time instants of the test execution. Row marked "T0" denotes the initial conditions, while columns marked "T1" is to be applied subsequently. The exact instants on which these values shall be applied are described in the texts in this clause.

Table 7.1.3.9.3.2-1: Time instances of cell power level and parameter changes

	Parameter	Unit	Cell 1	Cell 2	Remark
T0	Cell-specific RS EPRE	dBm/15KHz	-85	Off	
T1	Cell-specific RS EPRE	dBm/15KHz	-85	-79	

Table 7.1.3.9.3.3-2 illustrates the specific message content of RRC Connection Reconfiguration message during preamble.

Table 7.1.3.9.3.2-2: Main behaviour

St	Procedure	Message Sequence		TP	Verdict
		U - S	Message		
1	The SS changes Cell 2 power level according to the row "T1" in table 7.1.3.9.3.2-1	-	-	-	-
2	The SS transmits a MAC PDU containing one RLC SDU on DRB, but the CRC is calculated in such a way that it will result in CRC error on UE side.	<--	MAC PDU (1 RLC SDU of 40 bytes on DRB)	-	-
3	The UE transmit a HARQ NACK	-->	HARQ NACK	-	-
4	Void	-	-	-	-
5	The SS transmits an <i>RRCCONNECTIONRECONFIGURATION</i> message to order the UE to perform intra frequency handover to Cell 2	<--	-	-	-
6	The UE transmits on Cell 2, <i>RRCCONNECTIONRECONFIGURATIONCOMPLETE</i>	-->	-	-	-
7	Check: For 100 ms, does the UE transmit any HARQ NACK?	-->	HARQ NACK	1	F
8	The SS transmits a MAC PDU containing RLC SDU on DRB. The HARQ Process and NDI on PDCCH is same as in step 2. The SS shall ensure that the HARQ process used at step 2 will not be used in between steps 4 and 7.	<--	MAC PDU (1 RLC SDU of 40 bytes on DRB)	-	-
9	Check: Does the UE transmit a scheduling request?	-->	(SR)	2	P
10	The SS allocates UL Grant sufficient for one RLC SDU to be loop backed in a TTI, and NDI indicates new transmission	<--	Uplink Grant	-	-
11	The UE transmits a MAC PDU including one RLC SDU	-->	MAC PDU	-	-

7.1.3.9.3.3 Specific Message Contents

Table 7.1.3.9.3.3-1: RRCConnectionReconfiguration (step 5, table 7.1.3.9.3.2-2)

Derivation Path: 36.508, Table 4.6.1-8, condition HO			
Information Element	Value/Remark	Comment	Condition
RRCConnectionReconfiguration ::= SEQUENCE {			
criticalExtensions CHOICE {			
c1 CHOICE{			
rrcConnectionReconfiguration-r8 SEQUENCE {			
mobilityControlInfo SEQUENCE {	MobilityControlInfo-HO		
targetPhysCellId	PhysicalCellIdentity of Cell 2 (see 36.508 clause 4.6.5)		
carrierFreq	Not present		
}			
}			
}			
}			
}			

Table 7.1.3.9.3.3-2: RRCConnectionReconfiguration (preamble: Table 4.5.3.3-1, step 8)

Derivation path: 36.508 table 4.8.2.1.5-1			
Information Element	Value/Remark	Comment	Condition
RRCConnectionReconfiguration ::= SEQUENCE {			
criticalExtensions CHOICE {			
c1 CHOICE{			
rrcConnectionReconfiguration-r8 SEQUENCE {			
RadioResourceConfigDedicated SEQUENCE {			
mac-MainConfig CHOICE {			
timeAlignmentTimerDedicated	Infinity		
}			
}			
}			
}			
}			

Table 7.1.3.9.3.3-3: RLC-Config-DRB-AM {RRCConnectionReconfiguration (preamble: Table 4.5.3.3-1, step 8)}

Derivation path: 36.508 clause 4.8.2.1.3.2, Table 4.8.2.1.3.2-1			
Information Element	Value/Remark	Comment	Condition
RLC-Config-DRB-AM ::= CHOICE {			
am SEQUENCE {			
ul-AM-RLC SEQUENCE {			
t-PollRetransmit	ms250		
}			
}			
}			

7.1.3.10

7.1.3.11 CA / Correct HARQ process handling / DCCH and DTCH / Pcell and Scell

7.1.3.11.1 CA / Correct HARQ process handling / DCCH and DTCH / Pcell and Scell / Intra-band Contiguous CA

7.1.3.11.1.1 Test Purpose (TP)

(1)

```
with { UE in E-UTRA RRC_CONNECTED state with SCell activated }
ensure that {
  when { the UE receives a MAC PDU for DRB and decode fails }
  then { the UE transmits a NACK for the corresponding HARQ process within HARQ entity }
}
```

(2)

```
with { UE in E-UTRA RRC_CONNECTED state with SCell activated }
ensure that {
  when { the UE receives a MAC PDU retransmission for DRB, and results in successful decode }
  then { the UE transmits an ACK for the corresponding HARQ process within HARQ entity and
delivers data to upper layers }
}
```

7.1.3.11.1.2 Conformance requirements

References: The conformance requirements covered in the current TC are specified in: TS 36.321, clause 5.3.2.1.

[TS 36.321, clause 5.3.2.1]

There is one HARQ entity at the UE for each Serving Cell which maintains a number of parallel HARQ processes. Each HARQ process is associated with a HARQ process identifier. The HARQ entity directs HARQ information and associated TBs received on the DL-SCH to the corresponding HARQ processes (see subclause 5.3.2.2).

The number of DL HARQ processes per HARQ entity is specified in [2], clause 7.

When the physical layer is configured for downlink spatial multiplexing [2], one or two TBs are expected per subframe and they are associated with the same HARQ process. Otherwise, one TB is expected per subframe.

The UE shall:

- If a downlink assignment has been indicated for this TTI:
 - allocate the TB(s) received from the physical layer and the associated HARQ information to the HARQ process indicated by the associated HARQ information.
- If a downlink assignment has been indicated for the broadcast HARQ process:
 - allocate the received TB to the broadcast HARQ process.

NOTE: In case of BCCH a dedicated broadcast HARQ process is used.

7.1.3.11.1.3 Test description

7.1.3.11.1.3.1 Pre-test conditions

System Simulator:

- Cell 1 (PCell) and Cell 3(SCell)
- Cell 3 is an Active SCell according to [18] cl. 6.3.4
- RRC Connection Reconfiguration (preamble: Table 4.5.3.3-1, step 8) using parameters as specified in Table 7.1.3.11.1.3.3-1 and 7.1.3.11.1.3.3-2.

UE:

None.

Preamble:

- The UE is in state Loopback Activated (state 4) on Cell 1 according to [18].

7.1.3.11.1.3.2 Test procedure sequence

Table 7.1.3.11.1.3.2-1: Time instances of cell power level and parameter changes

	Parameter	Unit	Cell 1	Cell 3
T0	Cell-specific RS EPRE	dBm/15k Hz	-85	-85

Table 7.1.3.11.1.3.2-2: Main behaviour

St	Procedure	Message Sequence		TP	Verdict
		U - S	Message		
1	The SS transmits an <i>RRConnectionReconfiguration</i> message containing a <i>sCellToAddModList</i> on Cell 1 with SCell (Cell 3) addition.	<--	<i>RRConnectionReconfiguration</i>	-	-
2	The UE transmit an <i>RRConnectionReconfigurationComplete</i> message.	-->	<i>RRConnectionReconfigurationComplete</i>	-	-
3	The SS transmits Activation MAC control element to activate SCell (Cell 3).	<--	MAC PDU (Activation (C ₁ =1))	-	-
4	The SS indicates a new transmission on PDCCH of CC ₁ and transmits a MAC PDU (containing an RLC PDU with SN=0), with content set so that UE could not successfully decode the data from its soft buffer. (Note 1)	<--	MAC PDU (CC ₁)	-	-
5	Check: Does the UE transmit a HARQ NACK for the DL data corresponding DL CC ₁ ?	-->	HARQ NACK (CC ₁)	1	P
-	EXCEPTION: Step 6 shall be repeated till HARQ ACK is received at step 7 or until HARQ retransmission count = 4 is reached for MAC PDU at step 7 (Note 2).	-	-	-	-
6	The SS indicates a retransmission on PDCCH of CC ₁ and transmits the same MAC PDU like step 4 (Note 1).	<--	MAC PDU (CC ₁)	-	-
	EXCEPTION: Up to 3 HARQ NACK from the UE should be allowed at step 7 (Note 2).	-	-	-	-
7	Check: Does the UE send a HARQ ACK for the DL data corresponding to DL CC ₁ ?	-->	HARQ ACK (CC ₁)	2	P
8	The UE transmit a Scheduling Request on PUCCH	-->	(SR)	-	-
9	The SS sends an UL grant suitable for transmitting loop back PDU on Cell 1.	<--	(UL Grant)	-	-
10	The UE transmit a MAC PDU containing the loop back PDU corresponding to step 4 and 6	-->	MAC PDU	-	-
10a	The SS transmits a MAC PDU containing RLC status PDU acknowledging reception of RLC PDU in step 10	<--	MAC PDU (CC ₁)	-	-
11	The SS indicates a new transmission on PDCCH of CC ₂ and transmits a MAC PDU (containing an RLC PDU with SN=1), with content set so that UE could not successfully decode the data from its soft buffer. (Note 1)	<--	MAC PDU (CC ₂)	-	-
12	Check: Does the UE transmit a HARQ NACK for the DL data corresponding to DL CC ₂ ?	-->	HARQ NACK (CC ₂)	1	P
-	EXCEPTION: Step 13 shall be repeated till HARQ ACK is received at step 14 or until HARQ retransmission count = 4 is reached for MAC PDU at step 14 (Note 2).	-	-	-	-
13	The SS indicates a retransmission on PDCCH of CC ₂ and transmits the same MAC PDU like step 11 (Note 1).	<--	MAC PDU (CC ₂)	-	-
	EXCEPTION: Up to 3 HARQ NACK from the UE should be allowed at step 14 (Note 2).	-	-	-	-
14	Check: Does the UE send a HARQ ACK for the DL data corresponding to DL CC ₂ ?	-->	HARQ ACK (CC ₂)	2	P
15	UE transmit a Scheduling Request on PUCCH	-->	(SR)	-	-
16	The SS sends an UL grant suitable for transmitting loop back PDU on Cell 1.	<--	(UL Grant)	-	-
17	The UE transmit a MAC PDU containing the loop back PDU corresponding to step 11 and 13	-->	MAC PDU	-	-
17a	The SS transmits a MAC PDU containing RLC status PDU acknowledging reception of RLC PDU in step 17	<--	MAC PDU (CC ₁)	-	-

-	EXCEPTION: Steps 18 to 21 are run 8 [FDD]/7 [TDD] times using test parameter values as given for each iteration in table 7.1.3.11. 1.3.2-4. (Note 6).	-	-	-	-
18	The SS indicates new transmissions on PDCCHs of CC ₁ and CC ₂ and transmits a MAC PDU (containing an RLC PDU) on both CCs respectively with contents set so that UE could not successfully decode the data from its soft buffers. (Note 1) (Note 6).	<--	MAC PDU (CC ₁) and MAC PDU (CC ₂)	-	-
19	Check: Does the UE transmit HARQ NACK for the DL data corresponding to DL CC ₁ and CC ₂ respectively?	-->	HARQ NACK (CC ₁ and CC ₂)	1	P
-	EXCEPTION: In parallel with steps 20 to 21, the parallel behaviour in table 7.1.3.11.1.3.2-3 is running.	-	-	-	-
-	EXCEPTION: Step 20 shall be repeated till HARQ ACK is received at step 21 for the data corresponding both DL CC ₁ and DL CC ₂ or until HARQ retransmission count = 4 is reached for MAC PDUs at step 21 (Note 2).	-	-	-	-
20	The SS indicates retransmissions on PDCCHs of CC ₁ and CC ₂ and transmits the same MAC PDUs like step 18 (Note 1)(Note 3).	<--	MAC PDU (CC ₁) and MAC PDU(CC ₂)	-	-
-	EXCEPTION: Up to 3 HARQ NACK per CC from the UE should be allowed at step 21 (Note 2).	-	-	-	-
21	Check: Does the UE send a HARQ ACKs for the DL data corresponding to DL CC ₁ and DL CC ₂ (Note 7)?	-->	HARQ ACK (CC ₁) and HARQ ACK (CC ₂)	2	P
<p>Note 1: SS should transmit this PDU using $I_{TBS}=6$, $N_{PRB}=1$, see TS 36.213 Table 7.1.7.2.1-1. This will result in TBSize of 328 and having coding rate more than 1.</p> <p>Note 2: The value 4 for the maximum number of HARQ retransmissions has been chosen based on an assumption that, given the radio conditions used in this test case, a UE soft combiner implementation should have sufficient retransmissions to be able to successfully decode the data in its soft buffer.</p> <p>Note 3: Retransmission is done only for the DL CCs, for which HARQ NACK was received.</p> <p>Note 4: Void.</p> <p>Note 5: CC₁ corresponds to Pcell (Cell 1) and CC₂ corresponds to Scell (Cell 3).</p> <p>Note 6: At each iteration RLC PDU SN is incremented by 1 such that RLC PDUs with SN = 2, 4, 6, 8, 10 (and 12) are being transmitted on CC₁ whereas RLC PDUs with SN = 3, 5, 7, 9, 11 (and 13) on CC₂.</p> <p>Note 7: HARQ ACKs are expected only for those CCs for which retransmission was done in step 20.</p>					

Table 7.1.3.11.1.3.2-3: Parallel behaviour

St	Procedure	Message Sequence		TP	Verdict
		U – S	Message		
1	The UE transmit a Scheduling Request on PUCCH	-->	(SR)	-	-
2	Wait for 30ms to ensure HARQ processes for both CCs are finished.	-	-	-	-
3	The SS allocates UL Grant sufficient for two RLC SDU to be loop backed on Cell 1.	<--	(UL Grant)	-	-
4	The UE transmits a MAC PDU including two RLC SDU corresponding to step 18 in table 7.1.3.11.1.3.2-2.	-->	MAC PDU	-	-
5	The SS transmits a MAC PDU containing RLC status PDU acknowledging reception of RLC PDUs in step 4	<--	MAC PDU (CC ₁)	-	-

Table 7.1.3.11.1.3.2-4: Test Parameters

Iteration	DL HARQ process (X)
1	0
2	1
3	2
4	3
5	4
6	5
7	6
8	7[only for FDD]

Note: The maximum DL HARQ process is 7 for TDD configuration 1.

7.1.3.11.1.3.3 Specific message contents

Table 7.1.3.11.1.3.3-1: RRCConnectionReconfiguration (preamble)

Derivation path: 36.508 Table 4.8.2.1.5-1			
Information Element	Value/Remark	Comment	Condition
RRCConnectionReconfiguration ::= SEQUENCE {			
criticalExtensions CHOICE {			
c1 CHOICE{			
rrcConnectionReconfiguration-r8 SEQUENCE {			
RadioResourceConfigDedicated SEQUENCE {			
mac-MainConfig SEQUENCE {			
timeAlignmentTimerDedicated	Infinity		
}			
}			
}			
}			
}			
}			

Table 7.1.3.11.1.3.3-2: SchedulingRequest-Configuration (preamble)

Derivation Path: 36.508 clause 4.6.3-20			
Information Element	Value/remark	Comment	Condition
SchedulingRequest-Configuration ::= CHOICE {			
setup SEQUENCE {			
dsr-TransMax	n8		
}			
}			

Table 7.1.3.11.1.3.3-3: RRCConnectionReconfiguration (step 2, Table 7.1.3.11. 1.3.2-2)

Derivation Path: 36.508 Table 4.6.1-8, condition SCell_AddMod

Table 7.1.3.11.1.3.3-4: SCellToAddMod-r10 (Table 7.1.3.11.3.3-3)

Derivation Path: 36.508, Table 4.6.3-19D			
Information Element	Value/remark	Comment	Condition
SCellToAddMod-r10 ::= SEQUENCE {			
sCellIndex-r10	1		
cellIdentification-r10 SEQUENCE {			
physCellId-r10	PhysicalCellIdentity of Cell 3		
dl-CarrierFreq-r10	Same downlink EARFCN as used for Cell 3		
}			
}			

7.1.3.11.2 CA / Correct HARQ process handling / DCCH and DTCH / Pcell and SCell / Inter-band CA

The scope and description of the present TC is the same as test case 7.1.3.11.1 with the following differences:

- CA configuration: Inter-band CA replaces Intra-band Contiguous CA
- Cells configuration: Cell 10 replaces Cell 3
- Cell 10 is an Active SCell according to [18] cl. 6.3.4.

7.1.3.12 TDD additional special subframe configuration / Special subframe pattern 9/7 / CRS based transmission scheme

7.1.3.12.1 Test Purpose (TP)

(1)

```
with { UE in E-UTRA TDD RRC_CONNECTED state }
ensure that {
  when { UE is configured with tdd-Config-v1130 equalling to ssp9 for normal cyclic prefix which is
  configured in UL-CyclicPrefixLength equalling to len1, network schedules and transmits PDSCH data in
  DwPTS }
  then { UE sends ACK to the network after successfully receive and decode the data }
}
```

(2)

```
with { UE in E-UTRA TDD RRC_CONNECTED state }
ensure that {
  when { UE is configured with tdd-Config-v1130 equalling to ssp7 for extended cyclic prefix which
  is configured in UL-CyclicPrefixLength equalling to len2, network schedules and transmits PDSCH data
  in DwPTS }
  then { UE sends ACK to the network after successfully receive and decode the data }
}
```

7.1.3.12.2 Conformance requirements

References: The conformance requirements covered in the present TC are specified in: TS 36.211 clause 4.2, TS 36.213 clause 7.1.7, TS 36.306 clause 4.3.4.21 and TS 36.331 clause 6.3.2.

[TS 36.211, clause 4.2]

Frame structure type 2 is applicable to TDD. Each radio frame of length $T_f = 307200 \cdot T_s = 10$ ms consists of two half-frames of length $153600 \cdot T_s = 5$ ms each. Each half-frame consists of five subframes of length $30720 \cdot T_s = 1$ ms. The supported uplink-downlink configurations are listed in Table 4.2-2 where, for each subframe in a radio frame, “D” denotes the subframe is reserved for downlink transmissions, “U” denotes the subframe is reserved for uplink transmissions and “S” denotes a special subframe with the three fields DwPTS, GP and UpPTS. The length of DwPTS and UpPTS is given by Table 4.2-1 subject to the total length of DwPTS, GP and UpPTS being equal to $30720 \cdot T_s = 1$ ms. Each subframe i is defined as two slots, $2i$ and $2i+1$ of length $T_{\text{slot}} = 15360 \cdot T_s = 0.5$ ms in each subframe.

Uplink-downlink configurations with both 5 ms and 10 ms downlink-to-uplink switch-point periodicity are supported.

In case of 5 ms downlink-to-uplink switch-point periodicity, the special subframe exists in both half-frames.

In case of 10 ms downlink-to-uplink switch-point periodicity, the special subframe exists in the first half-frame only.

Subframes 0 and 5 and DwPTS are always reserved for downlink transmission. UpPTS and the subframe immediately following the special subframe are always reserved for uplink transmission.

In case multiple cells are aggregated, the UE may assume that the guard period of the special subframe in the different cells have an overlap of at least $1456 \cdot T_s$.

In case multiple cells with different uplink-downlink configurations are aggregated and the UE is not capable of simultaneous reception and transmission in the aggregated cells, the following constraints apply:

- if the subframe in the primary cell is a downlink subframe, the UE shall not transmit any signal or channel on a secondary cell in the same subframe
- if the subframe in the primary cell is an uplink subframe, the UE is not expected to receive any downlink transmissions on a secondary cell in the same subframe
- if the subframe in the primary cell is a special subframe and the same subframe in a secondary cell is a downlink subframe, the UE is not expected to receive PDSCH/EPDCCH/PMCH/PRS transmissions in the secondary cell in the same subframe, and the UE is not expected to receive any other signals on the secondary cell in OFDM symbols that overlaps with the guard period or UpPTS in the primary cell.

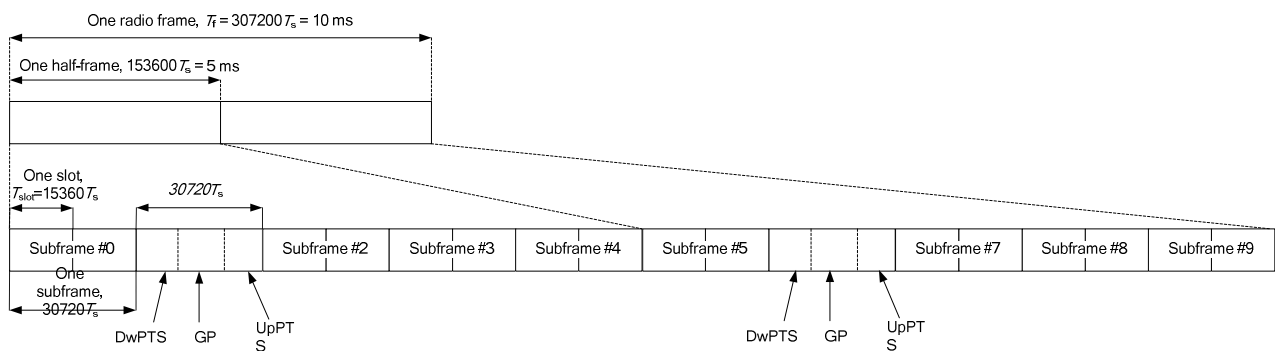

Figure 4.2-1: Frame structure type 2 (for 5 ms switch-point periodicity)

Table 4.2-1: Configuration of special subframe (lengths of DwPTS/GP/UpPTS)

Special subframe configuration	Normal cyclic prefix in downlink			Extended cyclic prefix in downlink		
	DwPTS	UpPTS		DwPTS	UpPTS	
		Normal cyclic prefix in uplink	Extended cyclic prefix in uplink		Normal cyclic prefix in uplink	Extended cyclic prefix in uplink
0	$6592 \cdot T_s$	$2192 \cdot T_s$	$2560 \cdot T_s$	$7680 \cdot T_s$	$2192 \cdot T_s$	$2560 \cdot T_s$
1	$19760 \cdot T_s$			$20480 \cdot T_s$		
2	$21952 \cdot T_s$			$23040 \cdot T_s$		
3	$24144 \cdot T_s$			$25600 \cdot T_s$		
4	$26336 \cdot T_s$	$4384 \cdot T_s$	$5120 \cdot T_s$	$7680 \cdot T_s$	$4384 \cdot T_s$	$5120 \cdot T_s$
5	$6592 \cdot T_s$			$20480 \cdot T_s$		
6	$19760 \cdot T_s$			$23040 \cdot T_s$		
7	$21952 \cdot T_s$			$12800 \cdot T_s$		
8	$24144 \cdot T_s$			-	-	-
9	$13168 \cdot T_s$			-	-	-

[TS 36.213, clause 7.1.7]

To determine the modulation order and transport block size(s) in the physical downlink shared channel, the UE shall first

- read the 5-bit “modulation and coding scheme” field (I_{MCS}) in the DCI

and second if the DCI CRC is scrambled by P-RNTI, RA-RNTI, or SI-RNTI then

- for DCI format 1A:
 - set the Table 7.1.7.2.1-1 column indicator N_{PRB} to N_{PRB}^{1A} from Section 5.3.3.1.3 in [4]
- for DCI format 1C:
 - use Table 7.1.7.2.3-1 for determining its transport block size.

else

- set N'_{PRB} to the total number of allocated PRBs based on the procedure defined in Section 7.1.6.

if the transport block is transmitted in DwPTS of the special subframe in frame structure type 2, then

- for special subframe configuration 9 with normal cyclic prefix or special subframe configuration 7 with extended cyclic prefix:

- set the Table 7.1.7.2.1-1 column indicator $N_{PRB} = \max \left\{ \left\lfloor N'_{PRB} \times 0.375 \right\rfloor, 1 \right\}$,

- for other special subframe configurations:

- set the Table 7.1.7.2.1-1 column indicator $N_{PRB} = \max \left\{ \left\lfloor N'_{PRB} \times 0.75 \right\rfloor, 1 \right\}$,

else, set the Table 7.1.7.2.1-1 column indicator $N_{PRB} = N'_{PRB}$.

The UE may skip decoding a transport block in an initial transmission if the effective channel code rate is higher than 0.930, where the effective channel code rate is defined as the number of downlink information bits (including CRC bits) divided by the number of physical channel bits on PDSCH. If the UE skips decoding, the physical layer indicates to higher layer that the transport block is not successfully decoded. For the special subframe configurations 0 and 5 with normal downlink CP or configurations 0 and 4 with extended downlink CP, shown in Table 4.2-1 of [3], there shall be no PDSCH transmission in DwPTS of the special subframe.

[TS 36.306, clause 4.3.4.21]

This field defines whether the UE supports TDD special subframe as specified in [TS 36.211]. It is mandatory for UEs of this release of the specification.

[TS 36.331, clause 6.3.2]

The IE *TDD-Config* is used to specify the TDD specific physical channel configuration.

TDD-Config information element

```
-- ASN1START
TDD-Config ::=
    subframeAssignment          SEQUENCE {
        ENUMERATED {
            sa0, sa1, sa2, sa3, sa4, sa5, sa6},
        specialSubframePatterns SEQUENCE {
            ENUMERATED {
                ssp0, ssp1, ssp2, ssp3, ssp4, ssp5, ssp6, ssp7,
                ssp8}
            }
    }

TDD-Config-v1130 ::=
    specialSubframePatterns-v1130 SEQUENCE {
        ENUMERATED {ssp7, ssp9}
    }
-- ASN1END
```

-- ASN1STOP

<i>TDD-Config</i> field descriptions
<p>specialSubframePatterns Indicates Configuration as in TS 36.211 [21, table 4.2-1] where <i>ssp0</i> points to Configuration 0, <i>ssp1</i> to Configuration 1 etc. Value <i>ssp7</i> points to Configuration 7 for extended cyclic prefix and value <i>ssp9</i> points to Configuration 9 for normal cyclic prefix. E-UTRAN signals <i>ssp7</i> only when setting <i>specialSubframePatterns</i> (without suffix i.e. the version defined in REL-8) to <i>ssp4</i>. E-UTRAN signals value <i>ssp9</i> only when setting <i>specialSubframePatterns</i> (without suffix) to <i>ssp5</i>. If <i>specialSubframePatterns-v1130</i> is present, the UE shall ignore <i>specialSubframePatterns</i> (without suffix).</p>
<p>subframeAssignment Indicates DL/UL subframe configuration where <i>sa0</i> point to Configuration 0, <i>sa1</i> to Configuration 1 etc. as specified in TS 36.211 [21, table 4.2-2]. E-UTRAN configures the same value for serving cells residing on same frequency band.</p>

7.1.3.12.3 Test description

7.1.3.12.3.1 Pre-test conditions

System Simulator:

- Cell 1 and Cell 2

UE:

None.

Preamble:

- The UE is in state Loopback Activated (state 4) in Cell 1 according to [18] using parameters as specified in section 7.1.3.12.3.3.

7.1.3.12.3.2 Test procedure sequence

Table 7.1.3.12.3.2-1 illustrates the downlink power levels and other changing parameters to be applied for the cells at various time instants of the test execution. Row marked "T0" denotes the initial conditions, while columns marked "T1" is to be applied subsequently. The exact instants on which these values shall be applied are described in the texts in this clause.

Table 7.1.3.12.3.2-1: Time instances of cell power level and parameter changes

	Parameter	Unit	Cell 1	Cell 2	Remark
T0	Cell-specific RS EPRE	dBm/15Khz	-85	-91	
T1	Cell-specific RS EPRE	dBm/15Khz	-85	-79	

Table 7.1.3.12.3.2-1: Main behaviour

St	Procedure	Message Sequence		TP	Verdict
		U - S	Message		
1	The SS indicates a new transmission on PDCCH and transmits a MAC PDU in SF-Num 1 or 6 where the DwPTS belongs to.	<--	MAC PDU	-	-
2	Check: Does the UE transmit a HARQ ACK?	-->	HARQ ACK	1	P
3	The UE transmits a Scheduling Request on PUCCH	-->	(SR)	-	-
4	The SS sends an UL grant suitable for the loop back PDU to be transmitted	<--	(UL Grant)	-	-
5	The UE transmits a MAC PDU containing the loop back PDU corresponding to step 1	-->	MAC PDU	-	-
6	The SS changes Cell 2 power level according to the row "T1" in table 7.1.3.12.3.2-1	-	-	-	-
7	The SS transmits an <i>RRCCONNECTIONRECONFIGURATION</i> message to order the UE to perform intra frequency handover to Cell 2 with special subframe pattern 7 for extended CP configured.	<--	-	-	-
8	The UE transmits on Cell 2, <i>RRCCONNECTIONRECONFIGURATIONCOMPLETE</i>	-->	-	-	-
9	The SS indicates a new transmission on PDCCH and transmits a MAC PDU in SF-Num 1 or 6 where the DwPTS belongs to.	<--	MAC PDU	-	-
10	Check: Does the UE transmit a HARQ ACK?	-->	HARQ ACK	2	P
11	The UE transmits a Scheduling Request on PUCCH	-->	(SR)	-	-
12	The SS sends an UL grant suitable for the loop back PDU to be transmitted	<--	(UL Grant)	-	-
13	The UE transmits a MAC PDU containing the loop back PDU corresponding to step 9	-->	MAC PDU	-	-

7.1.3.12.3.3 Specific message contents

Table 7.1.3.12.3.3-1: SystemInformationBlockType1 for Cell 1 (preamble, Table 7.1.3.12.3.2-1)

Derivation Path: 36.508 clause 4.4.3.2, Table 4.4.3.2-3			
Information Element	Value/remark	Comment	Condition
SystemInformationBlockType1 ::= SEQUENCE {			
tdd-Config SEQUENCE {			TDD
subframeAssignment	sa1		
specialSubframePatterns	ssp5		
}			
nonCriticalExtension SEQUENCE {			
nonCriticalExtension SEQUENCE {			
nonCriticalExtension SEQUENCE {			
tdd-Config-v1130 SEQUENCE {			
specialSubframePatterns-v1130	ssp9		
}			
nonCriticalExtension	Not present		
}			
}			
}			

Table 7.1.3.12.3.3-2: SystemInformationBlockType2 for Cell 1 (preamble, table 7.1.3.12.3.2-1)

Derivation path: 36.508 clause 4.4.3.3, Table 4.4.3.3-1			
Information Element	Value/Remark	Comment	Condition
SystemInformationBlockType2 ::= SEQUENCE {			
radioResourceConfigCommon SEQUENCE {			
ul-CyclicPrefixLength	len1		
}			
}			

Table 7.1.3.12.3.3-3: RRCConnectionReconfiguration (preamble: Table 4.5.3.3-1, step 8)

Derivation path: 36.508 table 4.8.2.1.5-1			
Information Element	Value/Remark	Comment	Condition
RRCConnectionReconfiguration ::= SEQUENCE {			
criticalExtensions CHOICE {			
c1 CHOICE {			
rrcConnectionReconfiguration-r8 SEQUENCE {			
RadioResourceConfigDedicated SEQUENCE {			
mac-MainConfig CHOICE {			
timeAlignmentTimerDedicated	Infinity		
}			
}			
}			
}			
}			
}			

Table 7.1.3.12.3.3-4: SystemInformationBlockType1 for Cell 2 (from step6, Table 7.1.3.12.3.2-1)

Derivation Path: 36.508 clause 4.4.3.2, Table 4.4.3.2-3			
Information Element	Value/remark	Comment	Condition
SystemInformationBlockType1 ::= SEQUENCE {			
tdd-Config SEQUENCE {			TDD
subframeAssignment	sa1		
specialSubframePatterns	ssp4		
}			
nonCriticalExtension SEQUENCE {			
nonCriticalExtension SEQUENCE {			
nonCriticalExtension SEQUENCE {			
tdd-Config-v1130 SEQUENCE {			
specialSubframePatterns-v1130	ssp7		
}			
}			
}	Not present		
}			
}			

Table 7.1.3.12.3.3-5: SystemInformationBlockType2 for Cell 2 (from step6, table 7.1.3.12.3.2-1)

Derivation path: 36.508 clause 4.4.3.3, Table 4.4.3.3-1			
Information Element	Value/Remark	Comment	Condition
SystemInformationBlockType2 ::= SEQUENCE {			
radioResourceConfigCommon SEQUENCE {			
ul-CyclicPrefixLength	len2		
}			
}			

Table 7.1.3.12.3.3-6: RRCConnectionReconfiguration (step 7, table 7.1.3.12.3.2-1)

Derivation Path: 36.508, Table 4.6.1-8, condition HO

Table 7.1.3.12.3.3-7: MobilityControlInfo (Table 7.1.3.12.3.3-6)

Derivation Path: 36.331 clause 4.6.5-1			
Information Element	Value/remark	Comment	Condition
MobilityControlInfo ::= SEQUENCE {			
targetPhysCellId	PhysicalCellId of Cell 2		
carrierFreq SEQUENCE {			
dl-CarrierFreq	Same downlink EARFCN as used for Cell 2		
ul-CarrierFreq	Not present		TDD
}			
carrierBandwidth SEQUENCE {			
dl-Bandwidth	Same downlink system bandwidth as used for Cell 2		
ul-Bandwidth	Not present		TDD
}			
radioResourceConfigCommon SEQUENCE {			
antennaInfoCommon SEQUENCE {			
antennaPortsCount	an1		
}			
tdd-Config SEQUENCE {			
subframeAssignment	sa1		
specialSubframePatterns	ssp4		
}			
ul-CyclicPrefixLength	len2		
tdd-Config-v1130 SEQUENCE {			
specialSubframePatterns-v1130	ssp7		
}			
}			
}			

7.1.3.13 TDD additional special subframe configuration / Special subframe pattern 9/7 / UE-specific reference signals based transmission scheme

7.1.3.13.1 Test Purpose (TP)

(1)

```

with { UE in E-UTRA TDD RRC_CONNECTED state }
ensure that {
  when { UE is configured with tdd-Config-v1130 equalling to ssp9 for normal cyclic prefix which is
  configured in UL-CyclicPrefixLength equalling to len1 under tm8 transmission mode, network uses DCI
  format 2B for PDSCH scheduling and transmits PDSCH data in DwPTS }
  then { UE sends ACK to the network after UE successfully receives and decodes the data }
}

```

(2)

```

with { UE in E-UTRA TDD RRC_CONNECTED state }
ensure that {
  when { UE is configured with tdd-Config-v1130 equalling to ssp7 for extended cyclic prefix which
  is configured in UL-CyclicPrefixLength equalling to len2 under tm7 transmission mode, network uses
  DCI format 1 for PDSCH scheduling and transmits PDSCH data in DwPTS }
  then { UE sends ACK to the network after UE successfully receives and decodes the data }
}

```

7.1.3.13.2 Conformance requirements

References: The conformance requirements covered in the present TC are specified in: TS 36.211 clause 4.2, TS 36.213 clause 6.10.3.2 and clause 7.1.7, TS 36.306 clause 4.3.4.21 and TS 36.331 clause 6.3.2.

[TS 36.211, clause 4.2]

Frame structure type 2 is applicable to TDD. Each radio frame of length $T_f = 307200 \cdot T_s = 10$ ms consists of two half-frames of length $153600 \cdot T_s = 5$ ms each. Each half-frame consists of five subframes of length $30720 \cdot T_s = 1$ ms. The supported uplink-downlink configurations are listed in Table 4.2-2 where, for each subframe in a radio frame, “D” denotes the subframe is reserved for downlink transmissions, “U” denotes the subframe is reserved for uplink transmissions and “S” denotes a special subframe with the three fields DwPTS, GP and UpPTS. The length of DwPTS and UpPTS is given by Table 4.2-1 subject to the total length of DwPTS, GP and UpPTS being equal to $30720 \cdot T_s = 1$ ms. Each subframe i is defined as two slots, $2i$ and $2i + 1$ of length $T_{slot} = 15360 \cdot T_s = 0.5$ ms in each subframe.

Uplink-downlink configurations with both 5 ms and 10 ms downlink-to-uplink switch-point periodicity are supported.

In case of 5 ms downlink-to-uplink switch-point periodicity, the special subframe exists in both half-frames.

In case of 10 ms downlink-to-uplink switch-point periodicity, the special subframe exists in the first half-frame only.

Subframes 0 and 5 and DwPTS are always reserved for downlink transmission. UpPTS and the subframe immediately following the special subframe are always reserved for uplink transmission.

In case multiple cells are aggregated, the UE may assume that the guard period of the special subframe in the different cells have an overlap of at least $1456 \cdot T_s$.

In case multiple cells with different uplink-downlink configurations are aggregated and the UE is not capable of simultaneous reception and transmission in the aggregated cells, the following constraints apply:

- if the subframe in the primary cell is a downlink subframe, the UE shall not transmit any signal or channel on a secondary cell in the same subframe
- if the subframe in the primary cell is an uplink subframe, the UE is not expected to receive any downlink transmissions on a secondary cell in the same subframe
- if the subframe in the primary cell is a special subframe and the same subframe in a secondary cell is a downlink subframe, the UE is not expected to receive PDSCH/EPDCCH/PMCH/PRS transmissions in the secondary cell in the same subframe, and the UE is not expected to receive any other signals on the secondary cell in OFDM symbols that overlaps with the guard period or UpPTS in the primary cell.

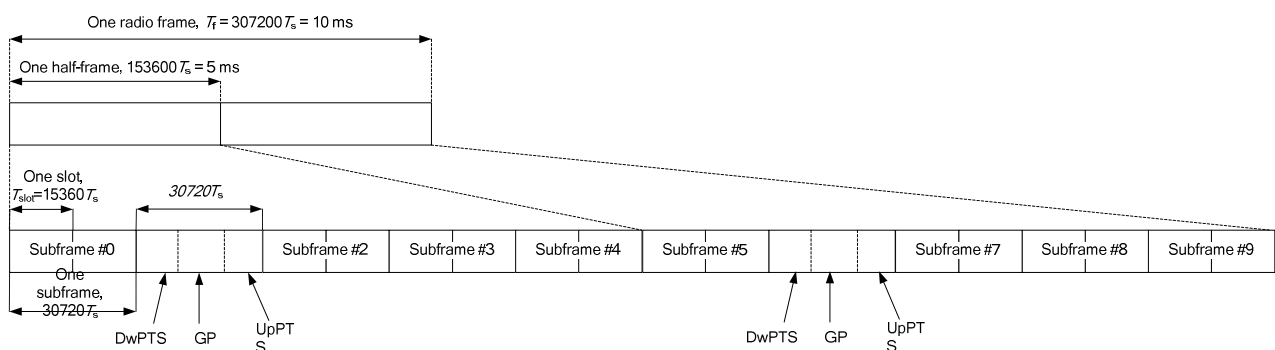

Figure 4.2-1: Frame structure type 2 (for 5 ms switch-point periodicity)

Table 4.2-1: Configuration of special subframe (lengths of DwPTS/GP/UpPTS).

Special subframe configuration	Normal cyclic prefix in downlink			Extended cyclic prefix in downlink		
	DwPTS	UpPTS		DwPTS	UpPTS	
		Normal cyclic prefix in uplink	Extended cyclic prefix in uplink		Normal cyclic prefix in uplink	Extended cyclic prefix in uplink
0	$6592 \cdot T_s$	$2192 \cdot T_s$	$2560 \cdot T_s$	$7680 \cdot T_s$	$2192 \cdot T_s$	$2560 \cdot T_s$
1	$19760 \cdot T_s$			$20480 \cdot T_s$		
2	$21952 \cdot T_s$			$23040 \cdot T_s$		
3	$24144 \cdot T_s$			$25600 \cdot T_s$		
4	$26336 \cdot T_s$			$7680 \cdot T_s$	$4384 \cdot T_s$	$5120 \cdot T_s$
5	$6592 \cdot T_s$	$20480 \cdot T_s$				
6	$19760 \cdot T_s$	$23040 \cdot T_s$				
7	$21952 \cdot T_s$	$12800 \cdot T_s$				
8	$24144 \cdot T_s$	-	-	-		
9	$13168 \cdot T_s$	-	-	-	-	

[TS 36.213, clause 6.10.3.2]

...

For antenna ports $p = 7$, $p = 8$ or $p = 7, 8, \dots, v + 6$, in a physical resource block with frequency-domain index n_{PRB} assigned for the corresponding PDSCH transmission, a part of the reference signal sequence $r(m)$ shall be mapped to complex-valued modulation symbols $a_{k,l}^{(p)}$ in a subframe according to

Normal cyclic prefix:

$$a_{k,l}^{(p)} = w_p(l') \cdot r(3 \cdot l' \cdot N_{\text{RB}}^{\text{max,DL}} + 3 \cdot n_{\text{PRB}} + m')$$

where

$$w_p(i) = \begin{cases} \bar{w}_p(i) & (m' + n_{\text{PRB}}) \bmod 2 = 0 \\ \bar{w}_p(3-i) & (m' + n_{\text{PRB}}) \bmod 2 = 1 \end{cases}$$

$$k = 5m' + N_{\text{sc}}^{\text{RB}} n_{\text{PRB}} + k'$$

$$k' = \begin{cases} 1 & p \in \{7, 8, 11, 13\} \\ 0 & p \in \{9, 10, 12, 14\} \end{cases}$$

$$l = \begin{cases} l' \bmod 2 + 2 & \text{if in a special subframe with configuration 3, 4, 8 or 9 (see Table 4.2-1)} \\ l' \bmod 2 + 2 + 3 \lfloor l' / 2 \rfloor & \text{if in a special subframe with configuration 1, 2, 6, or 7 (see Table 4.2-1)} \\ l' \bmod 2 + 5 & \text{if not in a special subframe} \end{cases}$$

$$l' = \begin{cases} 0, 1, 2, 3 & \text{if } n_s \bmod 2 = 0 \text{ and in a special subframe with configuration 1, 2, 6, or 7 (see Table 4.2-1)} \\ 0, 1 & \text{if } n_s \bmod 2 = 0 \text{ and not in special subframe with configuration 1, 2, 6, or 7 (see Table 4.2-1)} \\ 2, 3 & \text{if } n_s \bmod 2 = 1 \text{ and not in special subframe with configuration 1, 2, 6, or 7 (see Table 4.2-1)} \end{cases}$$

$$m' = 0, 1, 2$$

The sequence $\bar{w}_p(i)$ is given by Table 6.10.3.2-1.

Table 6.10.3.2-1: The sequence $\overline{w}_p(i)$ for normal cyclic prefix.

Antenna port p	$\left[\overline{w}_p(0) \quad \overline{w}_p(1) \quad \overline{w}_p(2) \quad \overline{w}_p(3) \right]$
7	$[+1 \quad +1 \quad +1 \quad +1]$
8	$[+1 \quad -1 \quad +1 \quad -1]$
9	$[+1 \quad +1 \quad +1 \quad +1]$
10	$[+1 \quad -1 \quad +1 \quad -1]$
11	$[+1 \quad +1 \quad -1 \quad -1]$
12	$[-1 \quad -1 \quad +1 \quad +1]$
13	$[+1 \quad -1 \quad -1 \quad +1]$
14	$[-1 \quad +1 \quad +1 \quad -1]$

Extended cyclic prefix:

$$a_{k,l}^{(p)} = w_p(l' \bmod 2) \cdot r(4 \cdot l' \cdot N_{\text{RB}}^{\text{max,DL}} + 4 \cdot n_{\text{PRB}} + m')$$

where

$$w_p(i) = \begin{cases} \overline{w}_p(i) & m' \bmod 2 = 0 \\ \overline{w}_p(1-i) & m' \bmod 2 = 1 \end{cases}$$

$$k = 3m' + N_{\text{sc}}^{\text{RB}} n_{\text{PRB}} + k'$$

$$k' = \begin{cases} 1 & \text{if } n_s \bmod 2 = 0 \text{ and } p \in \{7,8\} \\ 2 & \text{if } n_s \bmod 2 = 1 \text{ and } p \in \{7,8\} \end{cases}$$

$$l = l' \bmod 2 + 4$$

$$l' = \begin{cases} 0,1 & \text{if } n_s \bmod 2 = 0 \text{ and in a special subframe with configuration 1, 2, 3, 5 or 6 (see Table 4.2 - 1)} \\ 0,1 & \text{if } n_s \bmod 2 = 0 \text{ and not in a special subframe} \\ 2,3 & \text{if } n_s \bmod 2 = 1 \text{ and not in a special subframe} \end{cases}$$

$$m' = 0,1,2,3$$

The sequence $\overline{w}_p(i)$ is given by Table 6.10.3.2-2.

Table 6.10.3.2-2: The sequence $\overline{w}_p(i)$ for extended cyclic prefix.

Antenna port p	$\left[\overline{w}_p(0) \quad \overline{w}_p(1) \right]$
7	$[+1 \quad +1]$
8	$[-1 \quad +1]$

For extended cyclic prefix, UE-specific reference signals are not supported on antenna ports 9 to 14.

Resource elements (k, l) used for transmission of UE-specific reference signals to one UE on any of the antenna ports in the set S , where $S = \{7,8,11,13\}$ or $S = \{9,10,12,14\}$ shall

- not be used for transmission of PDSCH on any antenna port in the same slot, and
- not be used for UE-specific reference signals to the same UE on any antenna port other than those in S in the same slot.

Figure 6.10.3.2-3 illustrates the resource elements used for UE-specific reference signals for normal cyclic prefix for antenna ports 7, 8, 9 and 10. Figure 6.10.3.2-4 illustrates the resource elements used for UE-specific reference signals for extended cyclic prefix for antenna ports 7, 8.

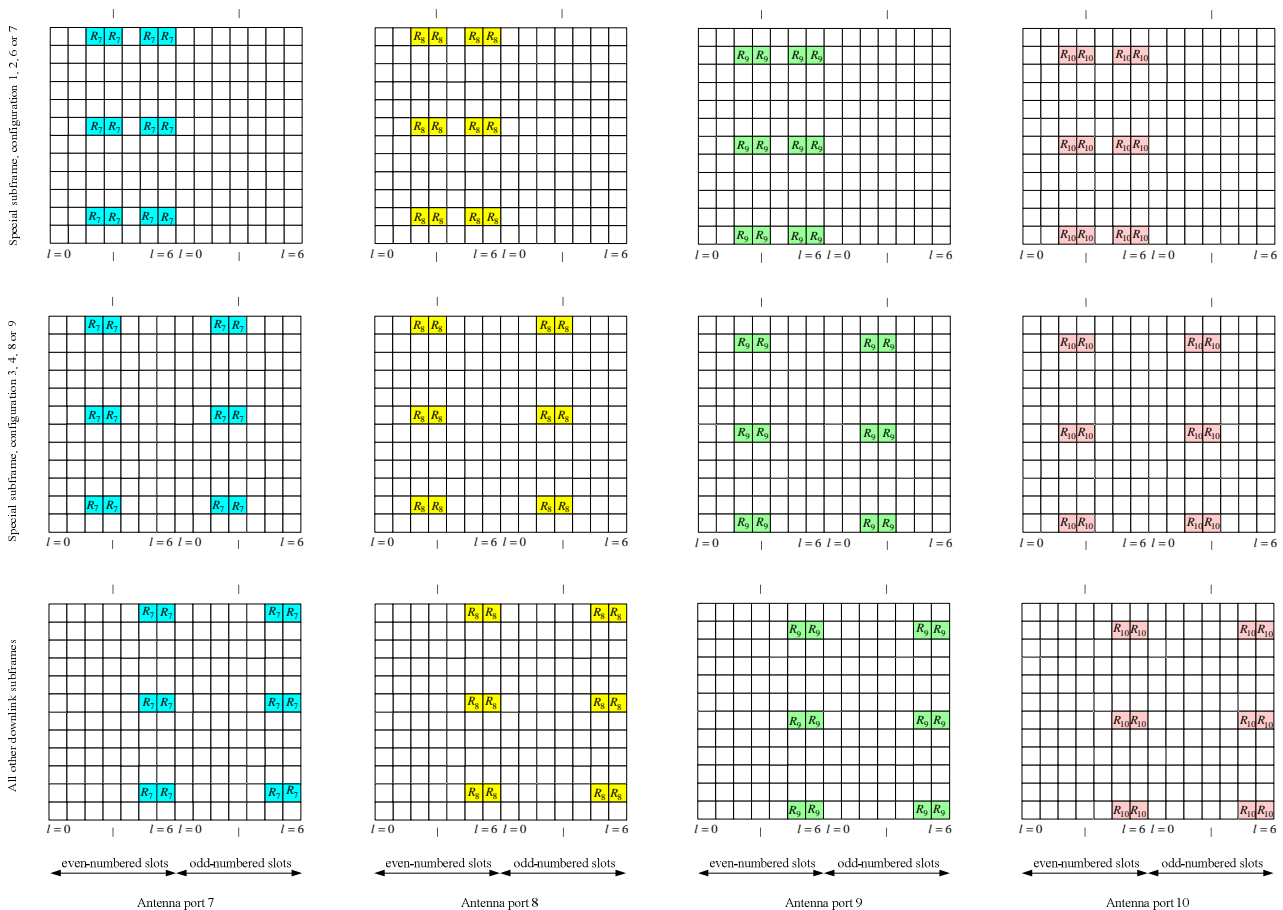

Figure 6.10.3.2-3: Mapping of UE-specific reference signals, antenna ports 7, 8, 9 and 10 (normal cyclic prefix)

[TS 36.213, clause 7.1]

...

For frame structure type 2,

- the UE is not expected to receive PDSCH resource blocks transmitted on antenna port 5 in any subframe in which the number of OFDM symbols for PDCCH with normal CP is equal to four;
- the UE is not expected to receive PDSCH resource blocks transmitted on antenna port 5 in the two PRBs to which a pair of VRBs is mapped if either one of the two PRBs overlaps in frequency with a transmission of PBCH in the same subframe;
- the UE is not expected to receive PDSCH resource blocks transmitted on antenna port 7, 8, 9, 10, 11, 12, 13 or 14 in the two PRBs to which a pair of VRBs is mapped if either one of the two PRBs overlaps in frequency with a transmission of primary or secondary synchronisation signals in the same subframe;
- with normal CP configuration, the UE is not expected to receive PDSCH on antenna port 5 for which distributed VRB resource allocation is assigned in the special subframe with configuration #1 or #6;
- the UE is not expected to receive PDSCH on antenna port 7 for which distributed VRB resource allocation is assigned;
- with normal cyclic prefix, the UE is not expected to receive PDSCH resource blocks transmitted on antenna port 5 in DwPTS when the UE is configured with special subframe configuration 9.

- The UE may skip decoding the transport block(s) if it does not receive all assigned PDSCH resource blocks. If the UE skips decoding, the physical layer indicates to higher layer that the transport block(s) are not successfully decoded.

If a UE is configured by higher layers to decode PDCCH with CRC scrambled by the C-RNTI, the UE shall decode the PDCCH and any corresponding PDSCH according to the respective combinations defined in Table 7.1-5. The scrambling initialization of PDSCH corresponding to these PDCCHs is by C-RNTI.

If a UE is configured by higher layers to decode EPDCCH with CRC scrambled by the C-RNTI, the UE shall decode the EPDCCH and any corresponding PDSCH according to the respective combinations defined in Table 7.1-5A. The scrambling initialization of PDSCH corresponding to these EPDCCHs is by C-RNTI.

If the UE is configured with the carrier indicator field for a given serving cell and, if the UE is configured by higher layers to decode PDCCH/EPDCCH with CRC scrambled by the C-RNTI, then the UE shall decode PDSCH of the serving cell indicated by the carrier indicator field value in the decoded PDCCH/EPDCCH.

When a UE configured in transmission mode 3, 4, 8, 9 or 10 receives a DCI Format 1A assignment, it shall assume that the PDSCH transmission is associated with transport block 1 and that transport block 2 is disabled.

When a UE is configured in transmission mode 7, scrambling initialization of UE-specific reference signals corresponding to these PDCCHs/EPDCCHs is by C-RNTI.

The UE does not support transmission mode 8 if extended cyclic prefix is used in the downlink.

When a UE is configured in transmission mode 9 or 10, in the subframes indicated by the higher layer parameter *mbsfn-SubframeConfigList* except in subframes for the serving cell

- indicated by higher layers to decode PMCH or,
- configured by higher layers to be part of a positioning reference signal occasion and the positioning reference signal occasion is only configured within MBSFN subframes and the cyclic prefix length used in subframe #0 is normal cyclic prefix,

the UE shall upon detection of a PDCCH with CRC scrambled by the C-RNTI with DCI format 1A/2C/2D intended for the UE or, upon detection of an EPDCCH with CRC scrambled by the C-RNTI with DCI format 1A/2C/2D intended for the UE, decode the corresponding PDSCH in the same subframe.

A UE configured in transmission mode 10 can be configured with scrambling identities, $n_{ID}^{DMRS,i}$, $i = 0,1$ by higher layers for UE-specific reference signal generation as defined in Section 6.10.3.1 of [3] to decode PDSCH according to a detected PDCCH/EPDCCH with CRC scrambled by the C-RNTI with DCI format 2D intended for the UE.

Table 7.1-5: PDCCH and PDSCH configured by C-RNTI

Transmission mode	DCI format	Search Space	Transmission scheme of PDSCH corresponding to PDCCH
Mode 1	DCI format 1A	Common and UE specific by C-RNTI	Single-antenna port, port 0 (see subclause 7.1.1)
	DCI format 1	UE specific by C-RNTI	Single-antenna port, port 0 (see subclause 7.1.1)
Mode 2	DCI format 1A	Common and UE specific by C-RNTI	Transmit diversity (see subclause 7.1.2)
	DCI format 1	UE specific by C-RNTI	Transmit diversity (see subclause 7.1.2)
Mode 3	DCI format 1A	Common and UE specific by C-RNTI	Transmit diversity (see subclause 7.1.2)
	DCI format 2A	UE specific by C-RNTI	Large delay CDD (see subclause 7.1.3) or Transmit diversity (see subclause 7.1.2)
Mode 4	DCI format 1A	Common and UE specific by C-RNTI	Transmit diversity (see subclause 7.1.2)
	DCI format 2	UE specific by C-RNTI	Closed-loop spatial multiplexing (see subclause 7.1.4) or Transmit diversity (see subclause 7.1.2)
Mode 5	DCI format 1A	Common and UE specific by C-RNTI	Transmit diversity (see subclause 7.1.2)
	DCI format 1D	UE specific by C-RNTI	Multi-user MIMO (see subclause 7.1.5)
Mode 6	DCI format 1A	Common and UE specific by C-RNTI	Transmit diversity (see subclause 7.1.2)
	DCI format 1B	UE specific by C-RNTI	Closed-loop spatial multiplexing (see subclause 7.1.4) using a single transmission layer
Mode 7	DCI format 1A	Common and UE specific by C-RNTI	If the number of PBCH antenna ports is one, Single-antenna port, port 0 is used (see subclause 7.1.1), otherwise Transmit diversity (see subclause 7.1.2)
	DCI format 1	UE specific by C-RNTI	Single-antenna port, port 5 (see subclause 7.1.1)
Mode 8	DCI format 1A	Common and UE specific by C-RNTI	If the number of PBCH antenna ports is one, Single-antenna port, port 0 is used (see subclause 7.1.1), otherwise Transmit diversity (see subclause 7.1.2)
	DCI format 2B	UE specific by C-RNTI	Dual layer transmission, port 7 and 8 (see subclause 7.1.5A) or single-antenna port, port 7 or 8 (see subclause 7.1.1)
Mode 9	DCI format 1A	Common and UE specific by C-RNTI	Non-MBSFN subframe: If the number of PBCH antenna ports is one, Single-antenna port, port 0 is used (see subclause 7.1.1), otherwise Transmit diversity (see subclause 7.1.2) MBSFN subframe: Single-antenna port, port 7 (see subclause 7.1.1)
	DCI format 2C	UE specific by C-RNTI	Up to 8 layer transmission, ports 7-14 (see subclause 7.1.5B) or single-antenna port, port 7 or 8 (see subclause 7.1.1)
Mode 10	DCI format 1A	Common and UE specific by C-RNTI	Non-MBSFN subframe: If the number of PBCH antenna ports is one, Single-antenna port, port 0 is used (see subclause 7.1.1), otherwise Transmit diversity (see subclause 7.1.2) MBSFN subframe: Single-antenna port, port 7 (see subclause 7.1.1)
	DCI format 2D	UE specific by C-RNTI	Up to 8 layer transmission, ports 7-14 (see subclause 7.1.5B) or single-antenna port, port 7 or 8 (see subclause 7.1.1)

[TS 36.306, clause 4.3.4.21]

This field defines whether the UE supports TDD special subframe as specified in [TS 36.211]. It is mandatory for UEs of this release of the specification.

[TS 36.331, clause 6.3.2]

The IE *TDD-Config* is used to specify the TDD specific physical channel configuration.

TDD-Config information element

```
-- ASN1START
TDD-Config ::=
    subframeAssignment          SEQUENCE {
                                ENUMERATED {
                                    sa0, sa1, sa2, sa3, sa4, sa5, sa6},
                                specialSubframePatterns
                                ENUMERATED {
                                    ssp0, ssp1, ssp2, ssp3, ssp4, ssp5, ssp6, ssp7,
                                    ssp8}
                                }
TDD-Config-v1130 ::=
    specialSubframePatterns-v1130 SEQUENCE {
                                ENUMERATED {ssp7, ssp9}
                                }
-- ASN1STOP
```

TDD-Config field descriptions	
specialSubframePatterns	Indicates Configuration as in TS 36.211 [21, table 4.2-1] where <i>ssp0</i> points to Configuration 0, <i>ssp1</i> to Configuration 1 etc. Value <i>ssp7</i> points to Configuration 7 for extended cyclic prefix and value <i>ssp9</i> points to Configuration 9 for normal cyclic prefix. E-UTRAN signals <i>ssp7</i> only when setting <i>specialSubframePatterns</i> (without suffix i.e. the version defined in REL-8) to <i>ssp4</i> . E-UTRAN signals value <i>ssp9</i> only when setting <i>specialSubframePatterns</i> (without suffix) to <i>ssp5</i> . If <i>specialSubframePatterns-v1130</i> is present, the UE shall ignore <i>specialSubframePatterns</i> (without suffix).
subframeAssignment	Indicates DL/UL subframe configuration where <i>sa0</i> point to Configuration 0, <i>sa1</i> to Configuration 1 etc. as specified in TS 36.211 [21, table 4.2-2]. E-UTRAN configures the same value for serving cells residing on same frequency band.

7.1.3.13.3 Test description

7.1.3.13.3.1 Pre-test conditions

System Simulator:

- Cell 1 and Cell 2

UE:

None.

Preamble:

- The UE is in state Loopback Activated (state 4) in Cell 1 according to [18] using parameters as specified in section 7.1.3.13.3.3.

7.1.3.13.3.2 Test procedure sequence

Table 7.1.3.13.3.2-1 illustrates the downlink power levels and other changing parameters to be applied for the cells at various time instants of the test execution. Row marked "T0" denotes the initial conditions, while columns marked "T1" is to be applied subsequently. The exact instants on which these values shall be applied are described in the texts in this clause.

Table 7.1.3.13.3.2-1: Time instances of cell power level and parameter changes

	Parameter	Unit	Cell 1	Cell 2	Remark
T0	Cell-specific RS EPRE	dBm/15Khz	-85	-91	
T1	Cell-specific RS EPRE	dBm/15Khz	-85	-79	

Table 7.1.3.13.3.2-1: Main behaviour

St	Procedure	Message Sequence		TP	Verdict
		U - S	Message		
1	The SS indicates a new transmission on PDCCH by using DCI format 2B and transmits a MAC PDU in SF-Num 1 or 6 where the DwPTS belongs to.	<--	MAC PDU	-	-
2	Check: Does the UE transmit a HARQ ACK?	-->	HARQ ACK	1	P
3	The UE transmits a Scheduling Request on PUCCH	-->	(SR)	-	-
4	The SS sends an UL grant suitable for the loop back PDU to be transmitted	<--	(UL Grant)	-	-
5	The UE transmits a MAC PDU containing the loop back PDU corresponding to step 1	-->	MAC PDU	-	-
6	The SS changes Cell 2 power level according to the row "T1" in table 7.1.3.13.3.2-1	-	-	-	-
7	The SS transmits an <i>RRConnectionReconfiguration</i> message to order the UE to perform intra frequency handover to Cell 2 with special subframe pattern 7 for extended CP and tm7 configured.	<--	-	-	-
8	The UE transmits on Cell 2, <i>RRConnectionReconfigurationComplete</i>	-->	-	-	-
9	The SS indicates a new transmission on PDCCH by using DCI format 1 and transmits a MAC PDU in SF-Num 1 or 6 where the DwPTS belongs to.	<--	MAC PDU	-	-
10	Check: Does the UE transmit a HARQ ACK?	-->	HARQ ACK	2	P
11	The UE transmits a Scheduling Request on PUCCH	-->	(SR)	-	-
12	The SS sends an UL grant suitable for the loop back PDU to be transmitted	<--	(UL Grant)	-	-
13	The UE transmits a MAC PDU containing the loop back PDU corresponding to step 1 and 6	-->	MAC PDU	-	-

7.1.3.13.3.3 Specific message contents

Table 7.1.3.13.3.3-1: SystemInformationBlockType1 for Cell 1 (preamble, Table 7.1.3.13.3.2-1)

Derivation Path: 36.508 clause 4.4.3.2, Table 4.4.3.2-3			
Information Element	Value/remark	Comment	Condition
SystemInformationBlockType1 ::= SEQUENCE {			
tdd-Config SEQUENCE {			TDD
subframeAssignment	sa1		
specialSubframePatterns	ssp5		
}			
nonCriticalExtension SEQUENCE {			
nonCriticalExtension SEQUENCE {			
nonCriticalExtension SEQUENCE {			
tdd-Config-v1130 SEQUENCE {			
specialSubframePatterns-v1130	ssp9		
}			
nonCriticalExtension	Not present		
}			
}			
}			

Table 7.1.3.13.3.3-2: SystemInformationBlockType2 for Cell 1 (preamble, table 7.1.3.13.3.2-1)

Derivation path: 36.508 clause 4.4.3.3, Table 4.4.3.3-1			
Information Element	Value/Remark	Comment	Condition
SystemInformationBlockType2 ::= SEQUENCE {			
radioResourceConfigCommon SEQUENCE {			
ul-CyclicPrefixLength	len1		
}			
}			

Table 7.1.3.13.3.3-3: RRCConnectionReconfiguration (preamble: Table 4.5.3.3-1, step 8)

Derivation path: 36.508 table 4.8.2.1.5-1			
Information Element	Value/Remark	Comment	Condition
RRCConnectionReconfiguration ::= SEQUENCE {			
criticalExtensions CHOICE {			
c1 CHOICE {			
rrcConnectionReconfiguration-r8 SEQUENCE {			
RadioResourceConfigDedicated SEQUENCE {			
mac-MainConfig CHOICE {			
timeAlignmentTimerDedicated	Infinity		
}			
}			
}			
}			
}			
}			

Table 7.1.3.13.3.3-4: PhysicalConfigDedicated-DEFAULT (preamble: Table 4.5.3.3-1, step 8)

Derivation Path: 36.331 clause 6.3.2			
Information Element	Value/remark	Comment	Condition
PhysicalConfigDedicated-DEFAULT ::= SEQUENCE {			
antennaInfo CHOICE {			
explicitValue SEQUENCE {			2TX
transmissionMode	tm8-v920		
ue-TransmitAntennaSelection CHOICE {			
Release	NULL		
}			
}			
}			

Table 7.1.3.13.3.3-5: SystemInformationBlockType1 for Cell 2 (from step6, Table 7.1.3.13.3.2-1)

Derivation Path: 36.508 clause 4.4.3.2, Table 4.4.3.2-3			
Information Element	Value/remark	Comment	Condition
SystemInformationBlockType1 ::= SEQUENCE {			
tdd-Config SEQUENCE {			TDD
subframeAssignment	sa1		
specialSubframePatterns	ssp4		
}			
nonCriticalExtension SEQUENCE {			
nonCriticalExtension SEQUENCE {			
nonCriticalExtension SEQUENCE {			
tdd-Config-v1130 SEQUENCE {			
specialSubframePatterns-v1130	ssp7		
}			
nonCriticalExtension	Not present		
}			
}			
}			

Table 7.1.3.13.3.3-6: SystemInformationBlockType2 for Cell 2 (from step6, table 7.1.3.13.3.2-1)

Derivation path: 36.508 clause 4.4.3.3, Table 4.4.3.3-1			
Information Element	Value/Remark	Comment	Condition
SystemInformationBlockType2 ::= SEQUENCE {			
radioResourceConfigCommon SEQUENCE {			
ul-CyclicPrefixLength	len2		
}			
}			

Table 7.1.3.13.3.3-7: RRCConnectionReconfiguration (step 7, table 7.1.3.13.3.2-1)

Derivation Path: 36.508, Table 4.6.1-8, condition HO
--

Table 7.1.3.13.3.3-8: MobilityControllInfo (Table 7.1.3.13.3.3-7)

Derivation Path: 36.331 clause 4.6.5-1			
Information Element	Value/remark	Comment	Condition
MobilityControllInfo ::= SEQUENCE {			
targetPhysCellId	PhysicalCellIdentity of Cell 2		
carrierFreq SEQUENCE {			
dl-CarrierFreq	Same downlink EARFCN as used for Cell 2		
ul-CarrierFreq	Not present		TDD
}			
carrierBandwidth SEQUENCE {			
dl-Bandwidth	Same downlink system bandwidth as used for Cell 2		
ul-Bandwidth	Not present		TDD
}			
radioResourceConfigCommon SEQUENCE {			
tdc-Config SEQUENCE {			
subframeAssignment	sa1		
specialSubframePatterns	ssp4		
}			
ul-CyclicPrefixLength	len2		
tdc-Config-v1130 SEQUENCE {			
specialSubframePatterns-v1130	ssp7		
}			
}			
}			

Table 7.1.3.13.3.3-9: PhysicalConfigDedicated-DEFAULT (Table 7.1.3.13.3.3-7)

Derivation Path: 36.508 clause 4.8.2.1, Table 4.8.2.1.6-1, condition RBC-HO			
Information Element	Value/remark	Comment	Condition
PhysicalConfigDedicated-DEFAULT ::= SEQUENCE {			
antennaInfo CHOICE {			
explicitValue SEQUENCE {			2TX
transmissionMode	tm7		
ue-TransmitAntennaSelection CHOICE {			
Release	NULL		
}			
}			
}			

7.1.3.14 Correct handling of DL assignment / Dynamic case / EPDCCH

7.1.3.14.1 Test Purpose (TP)

(1)

```
with { UE in E-UTRA RRC_CONNECTED state with EPDCCH in localized transmission type }
ensure that {
  when { UE receives downlink assignment on the EPDCCH for the UE's C-RNTI and receives data in the
associated subframe and UE performs HARQ operation }
  then { UE sends a HARQ feedback on the HARQ process }
}
```

(2)

```
with { UE in E-UTRA RRC_CONNECTED state and EPDCCH in localized transmission type }
ensure that {
  when { UE receives downlink assignment on the EPDCCH with a C-RNTI unknown by the UE and data is
available in the associated subframe }
  then { UE does not send any HARQ feedback on the HARQ process }
}
```

(3)

```

with { UE in E-UTRA RRC_CONNECTED state }
ensure that {
  when { EPDCCH is configured with distributed transmission type and UE receives downlink assignment
on the EPDCCH for the UE's C-RNTI and receives data in the associated subframe and UE performs HARQ
operation }
  then { UE sends a HARQ feedback on the HARQ process }
}

```

(4)

```

with { UE in E-UTRA RRC_CONNECTED state }
ensure that {
  when { EPDCCH is configured with distributed transmission type and UE receives downlink assignment
on the EPDCCH with a C-RNTI unknown by the UE and data is available in the associated subframe }
  then { UE does not send any HARQ feedback on the HARQ process }
}

```

7.1.3.14.2 Conformance requirements

References: The conformance requirements covered in the present TC are specified in: 3GPP TS 36.321 clauses 3.1 and 5.3.1. Unless otherwise stated these are Rel-11 requirements.

[36.321, clause 3.1]

PDCCH: Refers to the PDCCH [7], EPDCCH (in subframes when configured) or, for an RN with R-PDCCH configured and not suspended, to the R-PDCCH.

[TS 36.321, clause 5.3.1]

Downlink assignments transmitted on the PDCCH indicate if there is a transmission on the DL-SCH for a particular UE and provide the relevant HARQ information.

When the UE has a C-RNTI, Semi-Persistent Scheduling C-RNTI, or Temporary C-RNTI, the UE shall for each TTI during which it monitors PDCCH:

- if a downlink assignment for this TTI has been received on the PDCCH for the UE's C-RNTI, or Temporary C-RNTI:
 - if this is the first downlink assignment for this Temporary C-RNTI:
 - consider the NDI to have been toggled.
 - if the downlink assignment is for UE's C-RNTI and if the previous downlink assignment indicated to the HARQ entity of the same HARQ process was either a downlink assignment received for the UE's Semi-Persistent Scheduling C-RNTI or a configured downlink assignment:
 - consider the NDI to have been toggled regardless of the value of the NDI.
- indicate the presence of a downlink assignment and deliver the associated HARQ information to the HARQ entity for this TTI.

7.1.3.14.3 Test description

7.1.3.14.3.1 Pre-test conditions

System Simulator:

- Cell 1
- RRC Connection Reconfiguration (preamble: Table 4.5.3.3-1, step 8) using parameters as specified in Table 7.1.3.1.3.3-1

UE:

None.

Preamble:

- The generic procedure to get UE in test state Loopback Activated (State 4) according to TS 36.508 clause 4.5 is executed, with all the parameters as specified in the procedure except that the RLC SDU size is set to return no data in uplink.

7.1.3.14.3.2 Test procedure sequence

Table 7.1.3.14.3.2-1: Main behaviour

St	Procedure	Message Sequence		TP	Verdict
		U - S	Message		
1	SS transmits a downlink assignment including the C-RNTI assigned to the UE	<--	(EPDCCH (C-RNTI))	-	-
2	SS transmits in the indicated downlink assignment a RLC PDU in a MAC PDU.	<--	MAC PDU	-	-
3	Check: Does the UE transmit an HARQ ACK on PUCCH?	-->	HARQ ACK	1	P
4	SS transmits a downlink assignment to including a C-RNTI different from the assigned to the UE	<--	(EPDCCH (unknown C-RNTI))	-	-
5	SS transmits in the indicated downlink assignment a RLC PDU in a MAC PDU.	<--	MAC PDU	-	-
6	Check: Does the UE send any HARQ ACK/ NACK on PUCCH?	-->	HARQ ACK/ NACK	2	F
7	SS sends RRCConnectionReconfiguration to configure EPDCCH in distributed transmission mode	-	-	-	-
8	SS transmits a downlink assignment including the C-RNTI assigned to the UE	<--	(EPDCCH (C-RNTI))	-	-
9	SS transmits in the indicated downlink assignment a RLC PDU in a MAC PDU.	<--	MAC PDU	-	-
10	Check: Does the UE transmit an HARQ ACK on PUCCH?	-->	HARQ ACK	3	P
11	SS transmits a downlink assignment to including a C-RNTI different from the assigned to the UE	<--	(EPDCCH (unknown C-RNTI))	-	-
12	SS transmits in the indicated downlink assignment a RLC PDU in a MAC PDU.	<--	MAC PDU	-	-
13	Check: Does the UE send any HARQ ACK/ NACK on PUCCH?	-->	HARQ ACK/ NACK	4	F

NOTE 1: For TDD, the timing of ACK/NACK is not constant as FDD, see Table 10.1-1 of TS 36.213.

7.1.3.14.3.3 Specific Message Contents

Table 7.1.3.14.3.3-1: MAC-MainConfig-RBC (preamble: Table 4.5.3.3-1, step 8)

Derivation path: 36.508 table 4.8.2.1.5-1			
Information Element	Value/Remark	Comment	Condition
MAC-MainConfig-RBC ::= SEQUENCE {			
timeAlignmentTimerDedicated	Infinity		
}			

Table 7.1.3.14.3.3-2: PhysicalConfigDedicated (Preamble and step 7)

Derivation Path: 36.508 clause 4.8.2.1.6, Table 4.8.2.1.6-1 with condition ePDCCH

Table 7.1.3.14.3.3-3: EPDCCH-Config-r11 (Preamble)

Derivation Path: 36.508 clause 4.6.3, Table 4.6.3-2B			
Information Element	Value/remark	Comment	Condition
EPDCCH-Config-r11 ::= SEQUENCE{			
config-r11 CHOICE {			
setup SEQUENCE {			
subframePatternConfig-r11 CHOICE {			
setup SEQUENCE {			
subframePattern-r11 CHOICE {			
subframePatternFDD-r10	FFS		FDD
subframePatternTDD-r10 CHOICE {			TDD
subframeConfig1-5-r10	FFS		
subframeConfig0-r10	FFS		
subframeConfig6-r10	FFS		
}			
}			
}			
}			
startSymbol-r11	3		
setConfigToAddModList-r11 SEQUENCE	1 entry		
(SIZE(1..maxEPDCCH-Set-r11)) OF SEQUENCE {			
setConfigId-r11[1]	0		
transmissionType-r11[1]	localised		
resourceBlockAssignment-r11[1] SEQUENCE{			
numberPRB-Pairs-r11	n8		
resourceBlockAssignment-r11	FFS		
}			
dmrs-ScramblingSequenceInt-r11[1]	FFS		
pucch-ResourceStartOffset-r11[1]	FFS		
re-MappingQCL-ConfigListId-r11[1]	Not present		
}			
}			
}			
}			
}			

Table 7.1.3.14.3.3-4: EPDCCH-Config-r11 (Table 7.1.3.14.3.2-1, step 7)

Derivation Path: 36.508 clause 4.6.3, Table 4.6.3-2B			
Information Element	Value/remark	Comment	Condition
EPDCCH-Config-r11 ::= SEQUENCE{			
config-r11 CHOICE {			
setup SEQUENCE {			
subframePatternConfig-r11 CHOICE {			
setup SEQUENCE {			
subframePattern-r11 CHOICE {			
subframePatternFDD-r10	FFS		FDD
subframePatternTDD-r10 CHOICE {			TDD
subframeConfig1-5-r10	FFS		
subframeConfig0-r10	FFS		
subframeConfig6-r10	FFS		
}			
}			
}			
}			
startSymbol-r11	Not present	PCFICH indicate	
setConfigToAddModList-r11 SEQUENCE (SIZE(1..maxEPDCCH-Set-r11)) OF SEQUENCE {	2 entries	2 non-overlapping distributed sets	
setConfigId-r11[1]	0		
transmissionType-r11[1]	distributed		
resourceBlockAssignment-r11[1] SEQUENCE{			
numberPRB-Pairs-r11	n4		
resourceBlockAssignment-r11	FFS		
}			
dmrs-ScramblingSequenceInt-r11[1]	FFS		
pucch-ResourceStartOffset-r11[1]	FFS		
re-MappingQCL-ConfigListId-r11[1]	Not present		
setConfigId-r11[2]	1		
transmissionType-r11[2]	distributed		
resourceBlockAssignment-r11[2] SEQUENCE{			
numberPRB-Pairs-r11	n8		
resourceBlockAssignment-r11	FFS		
}			
dmrs-ScramblingSequenceInt-r11[2]	FFS		
pucch-ResourceStartOffset-r11[2]	FFS		
re-MappingQCL-ConfigListId-r11[2]	Not present		
}			
}			

7.1.3.15 Correct handling of DL assignment / Semi-persistent case / EPDCCH

7.1.3.15.1 Test Purpose (TP)

(1)

```
with { UE in E-UTRA RRC_Connected state with DRB established and sps-Configuration in DL is enabled
and EPDCCH in localized transmission mode }
ensure that {
  when { UE receives a DL assignment addressed to its stored SPS-CRNTI in SF-Num y and with NDI set
as 0 }
    then { UE starts receiving DL MAC PDU in SF-Nums y+n*[semiPersistSchedIntervalDL] where 'n' is
positive integer starting at zero }
}
```

(2)

```
with { UE in E-UTRA RRC_Connected state with DRB established and stored DL SPS assignment to receive
MAC PDU at SF-Num y+n*[semiPersistSchedIntervalDL] and EPDCCH in localized transmission mode }
ensure that {
  when { UE receives a DL assignment addressed to its SPS-CRNTI in SF-Num p and with NDI set as 0,
where p!= y+n*[semiPersistSchedIntervalDL] }
```

```

    then { UE starts receiving DL MAC PDU in SF-Nums p+n*[semiPersistSchedIntervalDL] and stops
receiving DL MAC PDU at SF-Nums y+n*[semiPersistSchedIntervalDL] where 'n' is positive integer
starting at zero }
}

```

(3)

```

with { UE in E-UTRA RRC_Connected state with DRB established and stored DL SPS assignment to receive
MAC PDU at SF-Num p+n*[semiPersistSchedIntervalDL] and EPDCCH in localized transmission mode }
ensure that {
    when { UE receives a DL assignment [for retransmission] addressed to its SPS-CRNTI in SF-Num z and
with NDI set as 1, where z!= p+n*[semiPersistSchedIntervalDL] }
        then { UE receives MAC PDU in SF-Num z as per the new grant for SPS-CRNTI }
}

```

(4)

```

with { UE in E-UTRA RRC_Connected state with DRB established and stored DL SPS assignment to receive
MAC PDU at SF-Num y+n*[semiPersistSchedIntervalDL] and EPDCCH in localized transmission mode }
ensure that {
    when { UE receives a DL assignment addressed to its CRNTI in SF-Num p, such that p!=
y+n*[semiPersistSchedIntervalDL] }
        then { UE receives MAC PDU in SF-Num p as per assignment addressed to its C-RNTI }
}

```

(5)

```

with { UE in E-UTRA RRC_Connected state with DRB established and stored DL SPS grant to receive MAC
PDU at SF-Num z+n*[semiPersistSchedIntervalDL] and EPDCCH in localized transmission mode }
ensure that {
    when { UE receives a RRCConnectionReconfiguration including sps-Configuration with sps-
ConfigurationDL set as 'disable' and hence resulting in DL SPS grant deactivation }
        then { UE deletes the stored sps-Configuration DL parameters and stops receiving DL MAC PDU's as
per stored SPS assignment in SF-Num z+n*[semiPersistSchedIntervalDL] }
}

```

(6)

```

with { UE in E-UTRA RRC_Connected state with DRB established and stored DL SPS assignment to receive
MAC PDU at SF-Num z+n*[semiPersistSchedIntervalDL] and EPDCCH in localized transmission mode }
ensure that {
    when { UE receives a EPDCCH [for DL SPS explicit release according to Table 9.2-1A in TS 36.213]
addressed to its SPS C-RNTI in SF-Num p and with NDI set as 0, where p!=
z+n*[semiPersistSchedIntervalDL] }
        then { UE sends an ACK to SS and releases the configured SPS assignment and stops receiving MAC
PDU in SF-Num z+n*[semiPersistSchedIntervalDL] as per assignment addressed to its SPS C-RNTI }
}

```

(7)

```

with { UE in E-UTRA RRC_Connected state with DRB established and sps-Configuration in DL is enabled
}
ensure that {
    when { EPDCCH is configured with distributed transmission type and UE receives a DL assignment
addressed to its stored SPS-CRNTI in SF-Num y and with NDI set as 0 }
        then { UE starts receiving DL MAC PDU in SF-Nums y+n*[semiPersistSchedIntervalDL] where 'n' is
positive integer starting at zero }
}

```

(8)

```

with { UE in E-UTRA RRC_Connected state with DRB established and stored DL SPS assignment to receive
MAC PDU at SF-Num y+n*[semiPersistSchedIntervalDL] }
ensure that {
    when { EPDCCH is configured with distributed transmission type and UE receives a DL assignment
addressed to its SPS-CRNTI in SF-Num p and with NDI set as 0, where p!=
y+n*[semiPersistSchedIntervalDL] }
        then { UE starts receiving DL MAC PDU in SF-Nums p+n*[semiPersistSchedIntervalDL] and stops
receiving DL MAC PDU at SF-Nums y+n*[semiPersistSchedIntervalDL] where 'n' is positive integer
starting at zero }
}

```

(9)

```

with { UE in E-UTRA RRC_Connected state with DRB established and stored DL SPS assignment to receive
MAC PDU at SF-Num p+n*[semiPersistSchedIntervalDL] }
ensure that {
  when { EPDCCH is configured with distributed transmission type and UE receives a DL assignment
[for retransmission] addressed to its SPS-CRNTI in SF-Num z and with NDI set as 1, where z!=
p+n*[semiPersistSchedIntervalDL] }
  then { UE receives MAC PDU in SF-Num z as per the new grant for SPS-CRNTI }
}

```

(10)

```

with { UE in E-UTRA RRC_Connected state with DRB established and stored DL SPS assignment to receive
MAC PDU at SF-Num y+n*[semiPersistSchedIntervalDL] }
ensure that {
  when { EPDCCH is configured with distributed transmission type and UE receives a DL assignment
addressed to its CRNTI in SF-Num p, such that p!= y+n*[semiPersistSchedIntervalDL] }
  then { UE receives MAC PDU in SF-Num p as per assignment addressed to its C-RNTI }
}

```

(11)

```

with { UE in E-UTRA RRC_Connected state with DRB established and stored DL SPS grant to receive MAC
PDU at SF-Num z+n*[semiPersistSchedIntervalDL] }
ensure that {
  when { EPDCCH is configured with distributed transmission type and UE receives a
RRCConnectionReconfiguration including sps-Configuration with sps-ConfigurationDL set as 'disable'
and hence resulting in DL SPS grant deactivation }
  then { UE deletes the stored sps-Configuration DL parameters and stops receiving DL MAC PDU's as
per stored SPS assignment in SF-Num z+n*[semiPersistSchedIntervalDL] }
}

```

(12)

```

with { UE in E-UTRA RRC_Connected state with DRB established and stored DL SPS assignment to receive
MAC PDU at SF-Num z+n*[semiPersistSchedIntervalDL] }
ensure that {
  when { EPDCCH is configured with distributed transmission type and UE receives a ePDCCH [for DL
SPS explicit release according to Table 9.2-1A in TS 36.213] addressed to its SPS C-RNTI in SF-Num p
and with NDI set as 0, where p!= z+n*[semiPersistSchedIntervalDL] }
  then { UE sends an ACK to SS and releases the configured SPS assignment and stops receiving MAC
PDU in SF-Num z+n*[semiPersistSchedIntervalDL] as per assignment addressed to its SPS C-RNTI }
}

```

NOTE: SF-Num = [10*SFN + subframe] modulo 10240.

7.1.3.15.2 Conformance requirements

References: The conformance requirements covered in the current TC are specified in: TS 36.321 clause 5.3.1, 5.10 & 5.10.1, 36.331 clause 5.3.10.5, 36.300 clause 11.1.1 and 36.213 clause 9.2. Unless otherwise stated these are Rel-11 requirements.

[TS 36.321, clause 5.3.1]

Downlink assignments transmitted on the PDCCH indicate if there is a transmission on the DL-SCH for a particular UE and provide the relevant HARQ information.

When the UE has a C-RNTI, Semi-Persistent Scheduling C-RNTI, or Temporary C-RNTI, the UE shall for each TTI during which it monitors PDCCH:

- if a downlink assignment for this TTI has been received on the PDCCH for the UE's C-RNTI, or Temporary C-RNTI:
 - if this is the first downlink assignment for this Temporary C-RNTI:
 - consider the NDI to have been toggled.
- if the downlink assignment is for UE's C-RNTI and if the previous downlink assignment indicated to the HARQ entity of the same HARQ process was either a downlink assignment received for the UE's Semi-Persistent Scheduling C-RNTI or a configured downlink assignment:

- consider the NDI to have been toggled regardless of the value of the NDI.
- indicate the presence of a downlink assignment and deliver the associated HARQ information to the HARQ entity for this TTI.
- else, if a downlink assignment for this TTI has been received on the PDCCH for the UE's Semi-Persistent Scheduling C-RNTI:
 - if the NDI in the received HARQ information is 1:
 - consider the NDI not to have been toggled;
 - indicate the presence of a downlink assignment and deliver the associated HARQ information to the HARQ entity for this TTI.
 - else, if the NDI in the received HARQ information is 0:
 - if PDCCH contents indicate SPS release:
 - clear the configured downlink assignment (if any);
 - if *timeAlignmentTimer* is running:
 - instruct the physical layer to transmit a positive acknowledgement.
 - else:
 - store the downlink assignment and the associated HARQ information as configured downlink assignment;
 - initialise (if not active) or re-initialise (if already active) the configured downlink assignment to start in this TTI and to recur according to rules in subclause 5.10.1;
 - set the HARQ Process ID to the HARQ Process ID associated with this TTI;
 - consider the NDI bit to have been toggled;
 - indicate the presence of a configured downlink assignment and deliver the stored HARQ information to the HARQ entity for this TTI.
- else, if a downlink assignment for this TTI has been configured and there is no measurement gap in this TTI:
 - instruct the physical layer to receive, in this TTI, transport block on the DL-SCH according to the configured downlink assignment and to deliver it to the HARQ entity;
 - set the HARQ Process ID to the HARQ Process ID associated with this TTI;
 - consider the NDI bit to have been toggled;
 - indicate the presence of a configured downlink assignment and deliver the stored HARQ information to the HARQ entity for this TTI.

For downlink assignments received on the PDCCH for the UE's Semi-Persistent Scheduling C-RNTI and for configured downlink assignments, the HARQ Process ID associated with this TTI is derived from the following equation:

$$\text{HARQ Process ID} = [\text{floor}(\text{CURRENT_TTI}/(\text{Downlink Semi-Persistent Scheduling Interval}))] \text{ modulo Number of Configured SPS Processes,}$$

where $\text{CURRENT_TTI} = [(\text{SFN} * 10) + \text{subframe number}]$, Downlink Semi-Persistent Scheduling Interval is the periodicity of semi-persistent scheduling signalled via RRC and Number of Configured SPS Processes is the number of HARQ processes allocated for semi-persistent scheduling signalled via RRC.

[TS 36.321, clause 5.10]

When Semi-Persistent Scheduling is enabled by upper layer, the following information is provided:

- Semi-Persistent Scheduling C-RNTI;

- Uplink Semi-Persistent Scheduling Interval *semiPersistSchedIntervalUL* and number of empty transmissions before implicit release *implicitReleaseAfter*, if Semi-Persistent Scheduling is enabled for the uplink;
- Whether *twoIntervalsConfig* is enabled or disabled for uplink, only for TDD;
- Downlink Semi-Persistent Scheduling Interval *semiPersistSchedIntervalDL* and number of configured HARQ processes for Semi-Persistent Scheduling *numberOfConfSPS-Processes*, if Semi-Persistent Scheduling is enabled for the downlink;

When Semi-Persistent Scheduling for uplink or downlink is disabled by RRC, the corresponding configured grant or configured assignment shall be discarded.

[TS 36.321, clause 5.10.1]

After a Semi-Persistent downlink assignment is configured, the UE shall consider that the assignment recurs in each subframe for which:

- $(10 * SFN + \text{subframe}) = [(10 * SFN_{\text{start time}} + \text{subframe}_{\text{start time}}) + N * (\text{Downlink Semi-Persistent Scheduling Interval})] \text{ modulo } 10240$, for all $N > 0$.

Where $SFN_{\text{start time}}$ and $\text{subframe}_{\text{start time}}$ are the SFN and subframe, respectively, at the time the configured downlink assignment were (re-)initialised.

[TS 36.331, clause 5.3.10.5]

The UE shall:

- 1> reconfigure the semi-persistent scheduling in accordance with the received *sps-Config*:

[TS 36.300, clause 11.1.1]

In addition, E-UTRAN can allocate semi-persistent downlink resources for the first HARQ transmissions to UEs:

- RRC defines the periodicity of the semi-persistent downlink grant;
- PDCCH indicates whether the downlink grant is a semi-persistent one i.e. whether it can be implicitly reused in the following TTIs according to the periodicity defined by RRC.

When required, retransmissions are explicitly signalled via the PDCCH(s). In the sub-frames where the UE has semi-persistent downlink resource, if the UE cannot find its C-RNTI on the PDCCH(s), a downlink transmission according to the semi-persistent allocation that the UE has been assigned in the TTI is assumed. Otherwise, in the sub-frames where the UE has semi-persistent downlink resource, if the UE finds its C-RNTI on the PDCCH(s), the PDCCH allocation overrides the semi-persistent allocation for that TTI and the UE does not decode the semi-persistent resources.

[TS 36.213, clause 9.2]

A UE shall validate a Semi-Persistent Scheduling assignment PDCCH only if all the following conditions are met:

- the CRC parity bits obtained for the PDCCH payload are scrambled with the Semi-Persistent Scheduling C-RNTI
- the new data indicator field is set to '0'. In case of DCI formats 2, 2A, 2B, 2C and 2D, the new data indicator field refers to the one for the enabled transport block.

A UE shall validate a Semi-Persistent Scheduling assignment EPDCCH only if all the following conditions are met:

- the CRC parity bits obtained for the EPDCCH payload are scrambled with the Semi-Persistent Scheduling C-RNTI
- the new data indicator field is set to '0'. In case of DCI formats 2, 2A, 2B, 2C and 2D, the new data indicator field refers to the one for the enabled transport block.

Validation is achieved if all the fields for the respective used DCI format are set according to Table 9.2-1 or Table 9.2-1A.

If validation is achieved, the UE shall consider the received DCI information accordingly as a valid semi-persistent activation or release.

If validation is not achieved, the received DCI format shall be considered by the UE as having been received with a non-matching CRC.

Table 9.2-1: Special fields for Semi-Persistent Scheduling Activation PDCCH/EPDCCH Validation

	DCI format 0	DCI format 1/1A	DCI format 2/2A/2B/2C/2D
TPC command for scheduled PUSCH	set to '00'	N/A	N/A
Cyclic shift DM RS	set to '000'	N/A	N/A
Modulation and coding scheme and redundancy version	MSB is set to '0'	N/A	N/A
HARQ process number	N/A	FDD: set to '000' TDD: set to '0000'	FDD: set to '000' TDD: set to '0000'
Modulation and coding scheme	N/A	MSB is set to '0'	For the enabled transport block: MSB is set to '0'
Redundancy version	N/A	set to '00'	For the enabled transport block: set to '00'

Table 9.2-1A: Special fields for Semi-Persistent Scheduling Release PDCCH/EPDCCH Validation

	DCI format 0	DCI format 1A
TPC command for scheduled PUSCH	set to '00'	N/A
Cyclic shift DM RS	set to '000'	N/A
Modulation and coding scheme and redundancy version	set to '11111'	N/A
Resource block assignment and hopping resource allocation	Set to all '1's	N/A
HARQ process number	N/A	FDD: set to '000' TDD: set to '0000'
Modulation and coding scheme	N/A	set to '11111'
Redundancy version	N/A	set to '00'
Resource block assignment	N/A	Set to all '1's

7.1. 3.15.3 Test description

7.1.3.15.3.1 Pre-test conditions

System Simulator:

- Cell 1

UE:

None.

Preamble:

- The UE is in state Loopback Activated (state 4) according to [18].
- The condition SRB2-DRB(1,1) is used for step 8 in 4.5.3A.3 according to [18].
- The UL RLC SDU size is set to not return any data.

7.1.3.15.3.2 Test procedure sequence

Table 7.1.3.15.3.2-1: Main behaviour

St	Procedure	Message Sequence		TP	Verdict
		U - S	Message		
1	The SS Transmits a DL assignment using UE's SPS C-RNTI in SF-Num 'Y', NDI=0	<--	(DL SPS Grant)	-	-
2	The SS transmits in SF-Num 'Y', a DL MAC PDU containing a RLC PDU (DL-SQN=0)on UM DRB	<--	MAC PDU	-	-
3	Check: Does the UE transmit a HARQ ACK?	-->	HARQ ACK	1	P
4	The SS transmits in SF-Num 'Y+X(semiPersistSchedIntervalDL)', a DL MAC PDU containing a RLC PDU (DL-SQN=1)on DRB	<--	MAC PDU	-	-
5	Check: Does the UE transmit a HARQ ACK?	-->	HARQ ACK	1	P
6	The SS Transmits a DL assignment using UE's SPS C-RNTI in SF-Num 'P', NDI=0; (Where $Y+X < P < Y+2X$)	<--	(DL SPS Grant)	-	-
7	The SS transmits in SF-Num 'P', a DL MAC PDU containing a RLC PDU (DL-SQN=2)on UM DRB	<--	MAC PDU	-	-
8	Check: Does the UE transmit a HARQ ACK?	-->	HARQ ACK	2	P
9	The SS transmits in SF-Num 'Y+2X', a DL MAC PDU containing a RLC PDU (DL-SQN=3)on UM DRB	<--	MAC PDU	-	-
10	Check: Does the UE transmit a HARQ Feedback?	-->	HARQ ACK/NACK	2	F
10A	The SS Transmits a DL assignment using UE's C-RNTI in SF-Num 'P+X(semiPersistSchedIntervalDL)', NDI=0	<--	(DL Grant)	-	-
11	The SS transmits in SF-Num 'P+X(semiPersistSchedIntervalDL)', a DL MAC PDU containing a RLC PDU (DL-SQN=3)on UM DRB;	<--	MAC PDU	-	-
12	Check: Does the UE transmit a HARQ ACK?	-->	HARQ ACK	4	P
13	The SS transmits in SF-Num 'P+2X(semiPersistSchedIntervalDL)', a DL MAC PDU containing a RLC PDU (DL-SQN=4)on UM DRB	<--	MAC PDU	-	-
14	Check: Does the UE transmit a HARQ ACK?	-->	HARQ ACK	1	P
15	The SS Transmits a DL assignment using UE's SPS C-RNTI in SF-Num in SF-Num 'P+3X(semiPersistSchedIntervalDL)' . (Note 1a)	<--	(DL SPS Grant)	-	-
16	The SS transmits in SF-Num 'P+3X(semiPersistSchedIntervalDL)', a DL MAC PDU containing 1 RLC PDU's (DL-SQN=5)on UM DRB; Note 1	<--	MAC PDU	-	-
16A	Check: Does the UE transmit a HARQ NACK?	-->	HARQ NACK		
	EXCEPTION: Step 19b and 19c shall be repeated until HARQ retransmission count = 3 is reached for MAC PDU at step 19 (Note 1b).				
16b	The SS Transmits a DL assignment using UE's SPS C-RNTI in SF-Num 'Z', NDI=1; Where $(P+3X < Z < P+4X)$; The DL HARQ process is same as in step 11	<--	(DL SPS Grant)		
16c	The SS re-transmits in SF-Num 'Z', a DL MAC PDU containing a RLC PDU (DL-SQN=5)on UM DRB; (Note 1a)	<--	MAC PDU		
	EXCEPTION: Up to 3 HARQ NACK from the UE should be allowed at step 20 (Note 1b).				
17	Check: Does the UE transmit a HARQ ACK?	-->	HARQ ACK	3	P
18	The SS Transmits a EPDCCH [for DL SPS	<--	EPDCCH [for DL SPS explicit	-	-

	explicit release] using UE's SPS C-RNTI in SF-Num 'Q', NDI=0; Where $(P+3X < Q < P+4X)$.		release]		
19	Check: Does the UE transmit a HARQ ACK?	-->	HARQ ACK	6	P
20	The SS transmits in SF-Num 'P+5X(semiPersistSchedIntervalDL)', a DL MAC PDU containing 1 RLC PDU's (DL-SQN=6)on UM DRB;	<--	MAC PDU	-	-
21	Check: Does the UE transmit a HARQ Feedback?	-->	HARQ ACK/NACK	6	F
22	The SS Transmits a DL assignment using UE's SPS C-RNTI in SF-Num 'P+6X', NDI=0	<--	(DL SPS Grant)	-	-
23	The SS transmits in SF-Num 'P+6X', a DL MAC PDU containing a RLC PDU (DL-SQN=6)on UM DRB	<--	MAC PDU	-	-
24	Check: Does the UE transmit a HARQ ACK?	-->	HARQ ACK	1	P
25	SS Transmits RRCConnectionReconfiguration to disable SPS-ConfigurationDL	-	-	-	-
26	The UE transmits RRCConnectionReconfigurationComplete	-->	-	-	-
27	The SS transmits in SF-Num 'P+8X(semiPersistSchedIntervalDL)', a DL MAC PDU containing 1 RLC PDU's (DL-SQN=7) on UM DRB	<--	MAC PDU	-	-
28	Check: Dose the UE transmit a HARQ Feedback?	-->	HARQ ACK/NACK	5	F
29	SS sends RRCConnectionReconfiguration to configure EPDCCH in distributed transmission mode	-	-	-	-
30	The SS Transmits a DL assignment using UE's SPS C-RNTI in SF-Num 'Y', NDI=0	<--	(DL SPS Grant)	-	-
31	The SS transmits in SF-Num 'Y', a DL MAC PDU containing a RLC PDU (DL-SQN=0)on UM DRB	<--	MAC PDU	-	-
32	Check: Does the UE transmit a HARQ ACK?	-->	HARQ ACK	7	P
33	The SS transmits in SF-Num 'Y+X(semiPersistSchedIntervalDL)', a DL MAC PDU containing a RLC PDU (DL-SQN=1)on DRB	<--	MAC PDU	-	-
34	Check: Does the UE transmit a HARQ ACK?	-->	HARQ ACK	7	P
35	The SS Transmits a DL assignment using UE's SPS C-RNTI in SF-Num 'P', NDI=0; (Where $Y+X < P < Y+2X$)	<--	(DL SPS Grant)	-	-
36	The SS transmits in SF-Num 'P', a DL MAC PDU containing a RLC PDU (DL-SQN=2)on UM DRB	<--	MAC PDU	-	-
37	Check: Does the UE transmit a HARQ ACK?	-->	HARQ ACK	8	P
38	The SS transmits in SF-Num 'Y+2X', a DL MAC PDU containing a RLC PDU (DL-SQN=3)on UM DRB	<--	MAC PDU	-	-
39	Check: Does the UE transmit a HARQ Feedback?	-->	HARQ ACK/NACK	8	F
39A	The SS Transmits a DL assignment using UE's C-RNTI in SF-Num 'P+X(semiPersistSchedIntervalDL)', NDI=0	<--	(DL Grant)	-	-
40	The SS transmits in SF-Num 'P+X(semiPersistSchedIntervalDL)', a DL MAC PDU containing a RLC PDU (DL-SQN=3)on UM DRB;	<--	MAC PDU	-	-
41	Check: Does the UE transmit a HARQ ACK?	-->	HARQ ACK	10	P
42	The SS transmits in SF-Num 'P+2X(semiPersistSchedIntervalDL)', a DL MAC PDU containing a RLC PDU (DL-SQN=4)on UM DRB	<--	MAC PDU	-	-
43	Check: Does the UE transmit a HARQ ACK?	-->	HARQ ACK	7	P
44	The SS Transmits a DL assignment using UE's SPS C-RNTI in SF-Num in SF-Num 'P+3X(semiPersistSchedIntervalDL)' . (Note	<--	(DL SPS Grant)	-	-

	1a)				
45	The SS transmits in SF-Num 'P+3X(semiPersistSchedIntervalDL)', a DL MAC PDU containing 1 RLC PDU's (DL-SQN=5)on UM DRB; Note 1	<--	MAC PDU	-	-
45A	Check: Does the UE transmit a HARQ NACK?	-->	HARQ NACK		
	EXCEPTION: Step 19b and 19c shall be repeated until HARQ retransmission count = 3 is reached for MAC PDU at step 19 (Note 1b).				
45b	The SS Transmits a DL assignment using UE's SPS C-RNTI in SF-Num 'Z', NDI=1; Where (P+3X < Z < P+4X); The DL HARQ process is same as in step 11	<--	(DL SPS Grant)		
45c	The SS re-transmits in SF-Num 'Z', a DL MAC PDU containing a RLC PDU (DL-SQN=5)on UM DRB; (Note 1a)	<--	MAC PDU		
	EXCEPTION: Up to 3 HARQ NACK from the UE should be allowed at step 20 (Note 1b).				
46	Check: Does the UE transmit a HARQ ACK?	-->	HARQ ACK	9	P
47	The SS Transmits a EPDCCH [for DL SPS explicit release] using UE's SPS C-RNTI in SF-Num 'Q', NDI=0; Where (P+3X< Q <P+4X).	<--	EPDCCH [for DL SPS explicit release]	-	-
48	Check: Does the UE transmit a HARQ ACK?	-->	HARQ ACK	12	P
49	The SS transmits in SF-Num 'P+5X(semiPersistSchedIntervalDL)', a DL MAC PDU containing 1 RLC PDU's (DL-SQN=6)on UM DRB	<--	MAC PDU	-	-
50	Check: Does the UE transmit a HARQ Feedback?	-->	HARQ ACK/NACK	12	F
51	The SS Transmits a DL assignment using UE's SPS C-RNTI in SF-Num 'P+6X', NDI=0	<--	(DL SPS Grant)	-	-
52	The SS transmits in SF-Num 'P+6X', a DL MAC PDU containing a RLC PDU (DL-SQN=6)on UM DRB	<--	MAC PDU	-	-
53	Check: Does the UE transmit a HARQ ACK?	-->	HARQ ACK	7	P
54	SS Transmits RRCConnectionReconfiguration to disable SPS-ConfigurationDL	-	-	-	-
55	The UE transmits RRCConnectionReconfigurationComplete	-->	-	-	-
56	The SS transmits in SF-Num 'P+8X(semiPersistSchedIntervalDL)', a DL MAC PDU containing 1 RLC PDU's (DL-SQN=7) on UM DRB	<--	MAC PDU	-	-
57	Check: Dose the UE transmit a HARQ Feedback?	-->	HARQ ACK/NACK	11	F
Note 1:	The DL assignment for C-RNTI and hence the size of MAC PDU is different in size than stored SPS C-RNTI DL assignment in step 6. This assures UE is receiving DSCH data as per DL assignment for C-RNTI and not as per stored grant for SPS C-RNTI.				
Note 1a:	SS should transmit this PDU using $I_{TBS}=6$, $N_{PRB}=1$, see TS 36.213 Table 7.1.7.2.1-1. This will result in TBSsize of 328 and having coding rate more than 1.				
Note 1b:	The value 4 for the maximum number of HARQ retransmissions has been chosen based on an assumption that, given the radio conditions used in this test case, a UE soft combiner implementation should have sufficient retransmissions to be able to successfully decode the data in its soft buffer.				
Note 2:	For TDD, the subframe number for 'Y', 'P', 'Z' and 'Q' should be '0', '4', '5' and '9' respectively based on TDD configuration 1.				

7.1.3.15.3.3 Specific message contents

Table 7.1.3.15.3.3-1: RadioResourceConfigDedicated (Preamble)

Derivation path: 36.508 table 4.6.3-16			
Information Element	Value/remark	Comment	Condition
RadioResourceConfigDedicated ::= SEQUENCE {			
mac-MainConfig CHOICE {			
explicitValue SEQUENCE{			
drx-Config CHOICE {			pc_FeatrGrp_5 AND DRX_S
setup SEQUENCE {			
onDurationTimer	psf40		
}			
}			
timeAlignmentTimerDedicated	Infinity		
}			
sps-Config ::= SEQUENCE {			
semiPersistSchedC-RNTI	'FFF0'H		
sps-ConfigurationDL ::= CHOICE{			
enable SEQUENCE {			
semiPersistSchedIntervalDL	sf40	40 Subframe	
numberOfConfSPS-Processes	8		FDD
numberOfConfSPS-Processes	7	Max DL HARQ processes is 7 considering TDD configuration 1.	TDD
n1Pucch-AN-Persistent	0		
}			
}			
sps-ConfigurationUL	Not Present		
}			
}			

Condition	Explanation
DRX_S	Used for DRX configuration with small DRX cycle length

Table 7.1.3.15.3.3-2: PhysicalConfigDedicated (Preamble in Table 4.5.3.3-1 step 8, and step 29 in Table 7.1.3.15.3.2-1)

Derivation Path: 36.508 clause 4.8.2.1.6, Table 4.8.2.1.6-1 with condition ePDCCH

Table 7.1.3.15.3.3-3: RadioResourceConfigDedicated (step 25 and 54 of table 7.1.3.15.3.2-1)

Derivation path: 36.508 table 4.6.3-16			
Information Element	Value/remark	Comment	Condition
RadioResourceConfigDedicated ::= SEQUENCE {			
sps-Configuration ::= SEQUENCE {			
semiPersistSchedC-RNTI	Not Present		
sps-ConfigurationDL ::= CHOICE{			
disable	NULL		
}			
sps-ConfigurationUL	Not Present		
}			
}			

Table 7.1.3.15.3.3-4: EPDCCH-SetConfig-r11 (preamble: Table 4.5.3.3-1, step 8)

Derivation Path: 36.508 clause 4.6.3, Table 4.6.3-2B			
Information Element	Value/remark	Comment	Condition
EPDCCH-Config-r11 ::= SEQUENCE{			
config-r11 CHOICE {			
setup SEQUENCE {			
subframePatternConfig-r11 CHOICE {			
setup SEQUENCE {			
subframePattern-r11 CHOICE {			
subframePatternFDD-r10	FFS		FDD
subframePatternTDD-r10 CHOICE {			TDD
subframeConfig1-5-r10	FFS		
}			
}			
}			
}			
startSymbol-r11	3		
setConfigToAddModList-r11 SEQUENCE (SIZE(1..maxEPDCCH-Set-r11)) OF SEQUENCE {	1 entry		
setConfigId-r11[1]	0		
transmissionType-r11[1]	localised		
resourceBlockAssignment-r11[1] SEQUENCE{			
numberPRB-Pairs-r11	n8		
resourceBlockAssignment-r11	FFS		
}			
dmrs-ScramblingSequenceInt-r11[1]	FFS		
pucch-ResourceStartOffset-r11[1]	FFS		
re-MappingQCL-ConfigListId-r11[1]	Not present		
}			
}			
}			
}			
}			

Table 7.1.3.15.3.3-5: EPDCCH-Config-r11 (Table 7.1.3.15.3.2-1, step 29)

Derivation Path: 36.508 clause 4.6.3, Table 4.6.3-2B			
Information Element	Value/remark	Comment	Condition
EPDCCH-Config-r11 ::= SEQUENCE{			
config-r11 CHOICE {			
setup SEQUENCE {			
subframePatternConfig-r11 CHOICE {			
setup SEQUENCE {			
subframePattern-r11 CHOICE {			
subframePatternFDD-r10	FFS		FDD
subframePatternTDD-r10 CHOICE {			TDD
subframeConfig1-5-r10	FFS		
}			
}			
}			
}			
startSymbol-r11	Not present	PCFICH indicate	
setConfigToAddModList-r11 SEQUENCE	2 entries	2 non-overlapping	
(SIZE(1..maxEPDCCH-Set-r11)) OF SEQUENCE {		distributed sets	
setConfigId-r11[1]	0		
transmissionType-r11[1]	distributed		
resourceBlockAssignment-r11[1] SEQUENCE{			
numberPRB-Pairs-r11	n4		
resourceBlockAssignment-r11	FFS		
}			
dmrs-ScramblingSequenceInt-r11[1]	FFS		
pucch-ResourceStartOffset-r11[1]	FFS		
re-MappingQCL-ConfigListId-r11[1]	Not present		
setConfigId-r11[2]	1		
transmissionType-r11[2]	distributed		
resourceBlockAssignment-r11[2] SEQUENCE{			
numberPRB-Pairs-r11	n8		
resourceBlockAssignment-r11	FFS		
}			
dmrs-ScramblingSequenceInt-r11[2]	FFS		
pucch-ResourceStartOffset-r11[2]	FFS		
re-MappingQCL-ConfigListId-r11[2]	Not present		
}			
}			
}			
}			

7.1.4 UL-SCH data transfer

7.1.4.1 Correct handling of UL assignment / Dynamic case

7.1.4.1.1 Test Purpose (TP)

(1)

```
with { UE in E-UTRA RRC_CONNECTED state }
ensure that {
  when { UE receives for a TTI an uplink grant with valid C-RNTI }
  then { UE transmits data and associated HARQ information to the HARQ entity for this TTI }
}
```

7.1.4.1.2 Conformance requirements

References: The conformance requirements covered in the present TC are specified in: 3GPP TS 36.321 clause 5.4.1.

[TS 36.321, clause 5.4.1]

In order to transmit on the UL-SCH the UE must have a valid uplink grant (except for non-adaptive HARQ retransmissions) which it may receive dynamically on the PDCCH or in a Random Access Response or which may be

configured semi-persistently. To perform requested transmissions, the MAC layer receives HARQ information from lower layers.

When *timeAlignmentTimer* is running and the UE has a C-RNTI, Semi-Persistent Scheduling C-RNTI, or Temporary C-RNTI, the UE shall for each TTI :

- if an uplink grant for this TTI has been received in a Random Access Response:
 - set NDI to the value 0 and consider the NDI to have been toggled.
 - if an uplink grant for this TTI has been received on the PDCCH for the UE's C-RNTI or Temporary C-RNTI; or
- if an uplink grant for this TTI has been received in a Random Access Response:
 - if the uplink grant is for UE's C-RNTI and if the previous uplink grant delivered to the HARQ entity for the same HARQ process was either an uplink grant received for the UE's Semi-Persistent Scheduling C-RNTI or a configured uplink grant:
- consider the NDI to have been toggled regardless of the value of the NDI.
 - deliver the uplink grant and the associated HARQ information to the HARQ entity for this TTI.
- else, if an uplink grant for this TTI has been received on the PDCCH for the UE's Semi-Persistent C-RNTI:
 - if the NDI in the received HARQ information is 1:
 - consider the NDI not to have been toggled;
 - indicate a valid uplink grant and the associated HARQ information to the HARQ entity for this TTI.

...

NOTE 1: The period of configured uplink grants is expressed in TTIs.

NOTE 2: If the UE receives both a grant in a Random Access Response and a grant for its C-RNTI or Semi persistent scheduling C-RNTI requiring transmissions in the same UL subframe, the UE may choose to continue with either the grant for its RA-RNTI or the grant for its C-RNTI or Semi persistent scheduling C-RNTI.

NOTE 3: When a configured uplink grant is indicated during a measurement gap and indicates an UL-SCH transmission during a measurement gap, the UE processes the grant but does not transmit on UL-SCH.

7.1.4.1.3 Test description

7.1.4.1.3.1 Pre-test conditions

System Simulator:

- Cell 1

UE:

None.

Preamble:

- The UE is in state Loopback Activated (state 4) according to [18].

7.1.4.1.3.2 Test procedure sequence

Table 7.1.4.1.3.2-1: Main behaviour

St	Procedure	Message Sequence		TP	Verdict
		U - S	Message		
1	The SS ignores scheduling requests and does not allocate any uplink grant.	-	-	-	-
2	SS transmits a MAC PDU including a RLC SDU	<--	MAC PDU	1	-
3	Void	-->	-	-	-
-	EXCEPTION: Step 4 runs in parallel with behaviour in table 7.1.4.1.3.2-2	-	-	-	-
4	The SS is configured for Uplink Grant Allocation Type 2. For 400 ms SS transmits an UL Grant every 10 ms, allowing the UE to return the RLC SDU as received in step 2, on PDCCH, but with the C-RNTI different from the C-RNTI assigned to the UE. Note 1.	<--	(UL Grant (unknown C-RNTI))	-	-
5	Check: Does the UE transmit a MAC PDU corresponding to grant in step 4?	-->	MAC PDU	1	F
6	The SS is configured for Uplink Grant Allocation Type 2. SS transmits an UL Grant, allowing the UE to return the RLC SDU as received in step 2, on PDCCH with the C-RNTI assigned to the UE.	<--	(UL Grant (C-RNTI))	-	-
7	Check: Does the UE transmit a MAC PDU corresponding to grant in step 6?	-->	MAC PDU	1	P
Note 1: Note 400 ms corresponding to 40 frames is selected to be sufficiently large than loop back delay and small than the time needed for Scheduling Request to be repeated $\text{dsr-TransMax times}(\{64-1\} * 20 \text{ milliseconds})$.					

Table 7.1.4.1.3.2-2: Parallel behaviour

St	Procedure	Message Sequence		TP	Verdict
		U - S	Message		
1	UE transmits a Scheduling Request.	-->	(SR)	-	-

7.1.4.1.3.3 Specific message contents.

Table 7.1.4.1.3.3-1: SchedulingRequest-Configuration to be used in RRCConnectionReconfiguration in preamble

Derivation Path: 36.508 clause 4.6.3-20			
Information Element	Value/remark	Comment	Condition
SchedulingRequest-Configuration ::= CHOICE {			
setup SEQUENCE {			
dsr-TransMax	n64	Max value allowed	
}			
}			

Table 7.1.4.1.3.3-2: *RRCConnectionReconfiguration* (preamble: Table 4.5.3.3-1, step 8)

Derivation path: 36.508 table 4.8.2.1.5-1			
Information Element	Value/Remark	Comment	Condition
RRCConnectionReconfiguration ::= SEQUENCE {			
criticalExtensions CHOICE {			
c1 CHOICE{			
rrcConnectionReconfiguration-r8 SEQUENCE {			
RadioResourceConfigDedicated SEQUENCE {			
mac-MainConfig CHOICE {			
timeAlignmentTimerDedicated	Infinity		
}			
}			
}			
}			
}			

7.1.4.2 Correct handling of UL assignment / Semi-persistent case

7.1.4.2.1 Test Purpose (TP)

(1)

```
with { UE in E-UTRA RRC_Connected state with DRB established and sps-Configuration in UL is enabled }
ensure that {
  when { UE receives a UL grant addressed to its stored SPS-CRNTI in SF-Num y and with NDI set as 0 }
  then { UE starts transmitting UL MAC PDU in SF-Num F1 }
```

(2)

```
with { UE in E-UTRA RRC_Connected state with DRB established and stored UL SPS grant to transmit MAC PDU at SF-Num F1 }
ensure that {
  when { UE receives a UL grant addressed to its SPS-CRNTI in SF-Num-frame p and with NDI set as 0,
  where p+4!=F1(FDD) or p+k(p)!=F1(TDD) }
  then { UE starts transmitting UL MAC PDU in SF-Num F2 and stops transmitting UL MAC PDU at SF-Num F1 }
```

(3)

```
with { UE in E-UTRA RRC_Connected state with DRB established and stored UL SPS grant to transmit MAC PDU at SF-Num F1 }
ensure that {
  when { UE receives a UL grant [for retransmission] addressed to its SPS-CRNTI in SF-Num z and with NDI set as 1, for the corresponding HARQ Process, where z+4!=F1(FDD) or z+k(z)!=F1(TDD) }
  then { UE re-transmits MAC PDU in SF-Num z+4(FDD) or z+k(z)(TDD) as per the new grant for SPS-CRNTI }
```

(4)

```
with { UE in E-UTRA RRC_Connected state with DRB established and stored UL SPS grant to transmit MAC PDU at SF-Num F3 }
ensure that {
  when { UE receives a UL grant addressed to its CRNTI in SF-Num p, such that in SF-Num p+4=F3(FDD) or p+k(p)=F3(TDD) }
  then { UE transmits MAC PDU in SF-Num p+4(FDD) or p+k(p)(TDD) as per grant addressed to its CRNTI }
```

(5)

```
with { UE in E-UTRA RRC_Connected state with DRB established and stored UL SPS grant to transmit MAC PDU at SF-Num F3 }
```

```

ensure that {
  when { UE receives a RRCConnectionReconfiguration including sps-Configuration with sps-
ConfigurationUL set as 'disable' and hence resulting in UL SPS grant deactivation }
  then { UE deletes the stored sps-Configuration UL parameters and stops transmitting UL MAC PDU's
as per stored SPS grant in SF-Num F3 }
}

```

(6)

```

with { UE in E-UTRA RRC_Connected state with DRB established and configured UL SPS grant }
ensure that {
  when { UE transmits 'implicitReleaseAfter' MAC PDU's on SPS-Grant containing zero MAC SDU }
  then { UE clears configured SPS grant }
}

```

(7)

```

with { UE in E-UTRA RRC_Connected state with DRB established and stored UL SPS grant to transmit MAC
PDU at SF-Num F3 }
ensure that {
  when { UE receives a PDCCH [for UL SPS explicit release according to Table 9.2-1A in TS 36.213]
addressed to its SPS C-RNTI in SF-Num p and with NDI set as 0, where p+4!=F3 (FDD) or p+k(p)!=F3 (TDD)
}
  then { UE releases the configured SPS grant and stops transmitting UL MAC PDU in SF-Num F3 as
per grant addressed to its SPS C-RNTI }
}

```

NOTE: SF-Num = [10*SFN + subframe] modulo 10240.

NOTE 2: The value of the k(y), k(p), k(z) is k value determined according to the table 8-2 in the TS 36.213, given that UL grant is in subframe y, p, z.

NOTE 3: The Subframe_Offset(y+k(y)), Subframe_Offset(p+k(p)), Subframe_Offset(z+k(z)) is subframe_offset value determined according to the clause 5.10.2 in the TS36.321, given the position of initial Semi-Persistent grant on subframe y+k(y), p+k(p), z+k(z).

NOTE 4: To simplify the TP description, following abbreviations are defined:

For FDD:

$$F1 = y+4+n*[\text{semiPersistSchedIntervalUL}]$$

$$F2 = p+4+n*[\text{semiPersistSchedIntervalUL}]$$

$$F3 = z+4+n*[\text{semiPersistSchedIntervalUL}]$$

For TDD:

$$F1 = y+k(y)+n*[\text{semiPersistSchedIntervalUL}] + \text{Subframe_Offset}(y+k(y))*(n \text{ modulo } 2)$$

$$F2 = p+k(p)+n*[\text{semiPersistSchedIntervalUL}] + \text{Subframe_Offset}(p+k(p))*(n \text{ modulo } 2)$$

$$F3 = z+k(z)+n*[\text{semiPersistSchedIntervalUL}] + \text{Subframe_Offset}(z+k(z))*(n \text{ modulo } 2)$$

$$n \geq 0$$

7.1.4.2.2 Conformance requirements

References: The conformance requirements covered in the current TC are specified in: TS 36.321 clause 5.4.1, 5.10, 5.10.2, 7.4, 36.331 clause 5.3.10.5, 36.213 clause 8, 9.2 and 36.300 clause 11.1.2.

[TS 36.321, clause 5.4.1]

In order to transmit on the UL-SCH the UE must have a valid uplink grant (except for non-adaptive HARQ retransmissions) which it may receive dynamically on the PDCCH or in a Random Access Response or which may be configured semi-persistently. To perform requested transmissions, the MAC layer receives HARQ information from lower layers.

When *timeAlignmentTimer* is running and the UE has a C-RNTI, Semi-Persistent Scheduling C-RNTI, or Temporary C-RNTI, the UE shall for each TTI:

- if an uplink grant for this TTI has been received in a Random Access Response:
 - set NDI to the value 0 and consider the NDI to have been toggled.
- if an uplink grant for this TTI has been received on the PDCCH for the UE's C-RNTI or Temporary C-RNTI; or
- if an uplink grant for this TTI has been received in a Random Access Response:
 - if the uplink grant is for UE's C-RNTI and if the previous uplink grant delivered to the HARQ entity for the same HARQ process was the uplink grant is for UE's C-RNTI and if the previous uplink grant delivered to the HARQ entity for the same HARQ process was either an uplink grant received for the UE's Semi-Persistent Scheduling C-RNTI or a configured uplink grant:
 - consider the NDI to have been toggled regardless of the value of the NDI.
 - deliver the uplink grant and the associated HARQ information to the HARQ entity for this TTI.
- else, if an uplink grant for this TTI has been received on the PDCCH for the UE's Semi-Persistent Scheduling C-RNTI:
 - if the NDI in the received HARQ information is 1:
 - consider the NDI not to have been toggled;
 - deliver the uplink grant and the associated HARQ information to the HARQ entity for this TTI.
 - else if the NDI in the received HARQ information is 0:
 - if PDCCH contents indicate SPS release:
 - clear the configured uplink grant (if any).
 - else:
 - store the uplink grant and the associated HARQ information as configured uplink grant;
 - initialise (if not active) or re-initialise (if already active) the configured uplink grant to start in this TTI and to recur according to rules in subclause 5.10.2;
 - consider the NDI bit to have been toggled;
 - deliver the configured uplink grant and the associated HARQ information to the HARQ entity for this TTI.
- else, if an uplink grant for this TTI has been configured:
 - consider the NDI bit to have been toggled;
 - deliver the configured uplink grant, and the associated HARQ information to the HARQ entity for this TTI.

NOTE 1: The period of configured uplink grants is expressed in TTIs.

NOTE 2: If the UE receives both a grant in a Random Access Response and a grant for its C-RNTI or Semi persistent scheduling C-RNTI requiring transmissions in the same UL subframe, the UE may choose to continue with either the grant for its RA-RNTI or the grant for its C-RNTI or Semi persistent scheduling C-RNTI.

NOTE 3: When a configured uplink grant is indicated during a measurement gap and indicates an UL-SCH transmission during a measurement gap, the UE processes the grant but does not transmit on UL-SCH.

[TS 36.321, clause 5.10]

When Semi-Persistent Scheduling is enabled by RRC, the following information is provided:

- Semi-Persistent Scheduling C-RNTI;
- Uplink Semi-Persistent Scheduling Interval *semiPersistSchedIntervalUL* and number of empty transmissions before implicit release *implicitReleaseAfter*, if Semi-Persistent Scheduling is enabled for the uplink;

- Whether *twoIntervalsConfig* is enabled or disabled for uplink, only for TDD;
- Downlink Semi-Persistent Scheduling Interval *semiPersistSchedIntervalDL* and number of configured HARQ processes for Semi-Persistent Scheduling *numberOfConfSPS-Processes*, if Semi-Persistent Scheduling is enabled for the downlink;

When Semi-Persistent Scheduling for uplink or downlink is disabled by RRC, the corresponding configured grant or configured assignment shall be discarded.

[TS 36.321, clause 5.10.2]

After a Semi-Persistent Scheduling uplink grant is configured, the UE shall:

- if *twoIntervalsConfig* is enabled by upper layer;
 - set the *Subframe_Offset* according to Table 7.4-1.
- else:
 - set *Subframe_Offset* to 0.
- consider that the grant recurs in each subframe for which:
 - $(10 * SFN + \text{subframe}) = [(10 * SFN_{\text{start time}} + \text{subframe}_{\text{start time}}) + N * \text{semiPersistSchedIntervalUL} + \text{Subframe_Offset} * (N \text{ modulo } 2)] \text{ modulo } 10240$, for all $N > 0$.

Where $SFN_{\text{start time}}$ and $\text{subframe}_{\text{start time}}$ are the SFN and subframe, respectively, at the time the configured uplink grant were (re-)initialised.

The UE shall clear the configured uplink grant immediately after *implicitRelease* after number of consecutive new MAC PDUs each containing zero MAC SDUs have been provided by the Multiplexing and Assembly entity, on the Semi-Persistent Scheduling resource.

NOTE 4: Retransmissions for Semi-Persistent Scheduling can continue after clearing the configured uplink grant.

[TS 36.321, clause 7.4]

Subframe_Offset values are presented in Table 7.4-1.

Table 7.4-1: Subframe_Offset values

TDD UL/DL configuration	Position of initial Semi-Persistent grant	Subframe_Offset value (ms)
0	N/A	0
1	Subframes 2 and 7	1
	Subframes 3 and 8	-1
2	Subframe 2	5
	Subframe 7	-5
3	Subframes 2 and 3	1
	Subframe 4	-2
4	Subframe 2	1
	Subframe 3	-1
5	N/A	0
6	N/A	0

[TS 36.331, clause 5.3.10.5]

The UE shall:

- 1> reconfigure the semi-persistent scheduling in accordance with the received *sps-Config*:

[TS 36.213, clause 8]

...

For TDD UL/DL configurations 1 and 6 and subframe bundling operation, the UE shall upon detection of a PDCCH with DCI format 0 in subframe n intended for the UE, and/or a PHICH transmission intended for the UE in subframe $n-l$

with l given in Table 8-2a, adjust the corresponding first PUSCH transmission in the bundle in subframe $n+k$, with k given in Table 8-2, according to the PDCCH and PHICH information.

...

Table 8-2 k for TDD configurations 0-6

TDD UL/DL Configuration	DL subframe number n									
	0	1	2	3	4	5	6	7	8	9
0	4	6				4	6			
1		6			4		6			4
2				4					4	
3	4								4	4
4									4	4
5									4	
6	7	7				7	7			5

...

[TS 36.213, clause 9.2]

A UE shall validate a Semi-Persistent Scheduling assignment PDCCH only if all the following conditions are met:

- the CRC parity bits obtained for the PDCCH payload are scrambled with the Semi-Persistent Scheduling C-RNTI
- the new data indicator field is set to '0'. In case of DCI formats 2 and 2A, the new data indicator field refers to the one for the enabled transport block.

Validation is achieved if all the fields for the respective used DCI format are set according to Table 9.2-1 or Table 9.2-1A.

If validation is achieved, the UE shall consider the received DCI information accordingly as a valid semi-persistent activation or release.

If validation is not achieved, the received DCI format shall be considered by the UE as having been received with a non-matching CRC.

Table 9.2-1: Special fields for Semi-Persistent Scheduling Activation PDCCH Validation

	DCI format 0	DCI format 1/1A	DCI format 2/2A
TPC command for scheduled PUSCH	set to '00'	N/A	N/A
Cyclic shift DM RS	set to '000'	N/A	N/A
Modulation and coding scheme and redundancy version	MSB is set to '0'	N/A	N/A
HARQ process number	N/A	FDD: set to '000' TDD: set to '0000'	FDD: set to '000' TDD: set to '0000'
Modulation and coding scheme	N/A	MSB is set to '0'	For the enabled transport block: MSB is set to '0'
Redundancy version	N/A	set to '00'	For the enabled transport block: set to '00'

Table 9.2-1A: Special fields for Semi-Persistent Scheduling Release PDCCH Validation

	DCI format 0	DCI format 1A
TPC command for scheduled PUSCH	set to '00'	N/A
Cyclic shift DM RS	set to '000'	N/A
Modulation and coding scheme and redundancy version	set to '11111'	N/A
Resource block assignment and hopping resource allocation	Set to all '1's	N/A
HARQ process number	N/A	FDD: set to '000' TDD: set to '0000'
Modulation and coding scheme	N/A	set to '11111'
Redundancy version	N/A	set to '00'
Resource block assignment	N/A	Set to all '1's

[TS 36.300, clause 11.1.2]

In addition, E-UTRAN can allocate a semi-persistent uplink resource for the first HARQ transmissions and potentially retransmissions to UEs:

- RRC defines the periodicity of the semi-persistent uplink grant;
- PDCCH indicates whether the uplink grant is a semi-persistent one i.e. whether it can be implicitly reused in the following TTIs according to the periodicity defined by RRC.

In the sub-frames where the UE has semi-persistent uplink resource, if the UE cannot find its C-RNTI on the PDCCH(s), an uplink transmission according to the semi-persistent allocation that the UE has been assigned in the TTI can be made. The network performs decoding of the pre-defined PRBs according to the pre-defined MCS. Otherwise, in the sub-frames where the UE has semi-persistent uplink resource, if the UE finds its C-RNTI on the PDCCH(s), the PDCCH allocation overrides the persistent allocation for that TTI and the UE's transmission follows the PDCCH allocation, not the semi-persistent allocation. Retransmissions are either implicitly allocated in which case the UE uses the semi-persistent uplink allocation, or explicitly allocated via PDCCH(s) in which case the UE does not follow the semi-persistent allocation.

7.1.4.2.3 Test description

7.1.4.2.3.1 Pre-test conditions

System Simulator:

- Cell 1

UE:

None.

Preamble:

- The UE is in state Loopback Activated (state 4) according to [18].
- The condition SRB2-DRB(1,1) is used for step 8 in 4.5.3A.3 according to [18].
- The loop back size is set in such a way that one RLC SDU in DL shall result in 1 RLC SDU's in UL of same size.

7.1.4.2.3.2 Test procedure sequence

Table 7.1.4.2.3.2-1: Main behaviour

St	Procedure	Message Sequence		TP	Verdict
		U - S	Message		
0A	SS transmits RRCConnectionReconfiguration to configure UL SPS	<--	-	-	-
0B	The UE transmits RRCConnectionReconfigurationComplete	-->	-	-	-
1	The SS transmits a DL MAC PDU containing 10 RLC SDU's on UM DRB.	<--	MAC PDU	-	-
2	The UE transmits a Scheduling Request, indicating that loop back PDUs are ready for transmission in UL RLC	-->	(SR)	-	-
3	The SS transmits an UL Grant using UE's SPS C-RNTI in SF-Num '4', NDI=0, allowing the UE to transmit one loop back PDU per MAC PDU.	<--	(UL SPS Grant)	-	-
4	Check: Does the UE transmit a MAC PDU in SF-Num '8' as per grant in step 3?	-->	MAC PDU	1	P
5	The SS transmits a HARQ ACK	<--	HARQ ACK	-	-
6	Check: Does the UE transmit a MAC PDU in SF-Num '48(FDD)/47(TDD)' as per grant in step 3?	-->	MAC PDU	1	P
7	The SS transmits a HARQ ACK	<--	HARQ ACK	-	-
8	The SS Transmits an UL Grant using UE's SPS C-RNTI in SF-Num '64', NDI=0 and allowing the UE to transmit two loop back PDUs per MAC PDU.	<--	(UL SPS Grant)	-	-
9	Check: Does the UE transmit a MAC PDU in SF-Num '68' as per grant in step 8?	-->	MAC PDU	2	P
10	The SS transmits a HARQ ACK	<--	HARQ ACK	-	-
11	Check: Does the UE transmit a MAC PDU in SF-Num '88' as per grant in step 3?	-->	MAC PDU	2	F
12	Check: Does the UE transmit a MAC PDU in SF-Num '108(FDD)/107(TDD)' as per grant in step 8?	-->	MAC PDU	2	P
13	The SS transmits a HARQ ACK	<--	HARQ ACK	-	-
14	The SS Transmits an UL Grant using UE's SPS C-RNTI in SF-Num '120 (FDD)/124(TDD)', NDI=1; the UL HARQ process is the same as in step 12	<--	(UL SPS Grant)	-	-
15	Check: Does the UE transmit in SF-Num '124 (FDD)/128 (TDD)' a MAC PDU as in step 12?	-->	MAC PDU	3	P
16	The SS transmits a HARQ ACK	<--	HARQ ACK	-	-
17	Check: Does the UE transmit a MAC PDU in SF-Num '148' as per grant in step 8?	-->	MAC PDU	1	P
18	The SS transmits a HARQ ACK	<--	HARQ ACK	-	-
19	The SS Transmits an UL Grant using UE's C-RNTI in SF-Num '164(FDD)/161(TDD)'; allowing UE to transmit a MAC PDU containing two RLC SDU's	<--	(UL Grant)	-	-
20	Check: Does the UE transmit a MAC PDU in SF-Num '168(FDD)/167(TDD)' as per grant in step 19?	-->	MAC PDU	4	P
21	The SS transmits a HARQ ACK	<--	HARQ ACK	-	-
22	The SS transmits a PDCCH [for UL SPS explicit release] using UE's SPS C-RNTI in SF-Num '180' with NDI=0.	<--	PDCCH [for UL SPS explicit release]	-	-
23	Check: Does the UE transmit a MAC PDU in SF-Num '188' as per grant in step 8 containing zero MAC SDU?	-->	MAC PDU	7	F
24	The SS transmits an UL Grant using UE's SPS C-RNTI in SF-Num '399', NDI=0, transmit one loop back PDU per MAC PDU	<--	(UL SPS Grant)	-	-
25	Check: Does the UE transmit a MAC PDU in SF-Num '403' as per grant in step 24	-->	MAC PDU	1	P

	containing zero MAC SDU?				
26	The SS transmits a HARQ ACK	<--	HARQ ACK	-	-
27	Check: Does the UE transmit a MAC PDU in SF-Num '443 (FDD)/442 (TDD)' as per grant in step 24 containing zero MAC SDU?	-->	MAC PDU	1	P
28	The SS transmits a HARQ ACK	<--	HARQ ACK	-	-
29	Check: Does the UE transmit a MAC PDU in SF-Num '483' as per grant in step 24?	-->	MAC PDU	6	F
30	The SS Transmits an UL Grant using UE's SPS C-RNTI in SF-Num '604', NDI=0, transmit one loop back PDU per MAC PDU.	<--	(UL SPS Grant)	-	-
31	Check: Does the UE transmit a MAC PDU in SF-Num '608' as per grant in step 30 containing zero MAC SDU?	-->	MAC PDU	1	P
32	The SS transmits a HARQ ACK	<--	HARQ ACK	-	-
33	SS Transmits <i>RRCCONNECTIONRECONFIGURATION</i> to disable SPS-ConfigurationUL.	<--	-	-	-
34	The UE transmits <i>RRCCONNECTIONRECONFIGURATIONCOMPLETE</i>	-->	-	-	-
35	The SS transmits a DL MAC PDU containing 1 RLC SDU	<--	MAC PDU	-	-
36	Void	-	-	-	-
37	Check: Does the UE transmit a MAC PDU in SF-Num '648 (FDD)/647 (TDD)' as per grant in step 30?	-->	MAC PDU	5	F

7.1.4.2.3.3 Specific message contents

Table 7.1.4.2.3.3-1: *RRCCONNECTIONRECONFIGURATION*. RadioResourceConfigDedicated (Step 0A)

Derivation path: 36.508 table 4.6.3-16			
Information Element	Value/remark	Comment	Condition
RadioResourceConfigDedicated ::= SEQUENCE {			
sps-Configuration ::= SEQUENCE {			
semiPersistSchedC-RNTI	'FFF0'H		
sps-ConfigurationDL	Not Present		
sps-ConfigurationUL ::= CHOICE {			
enable SEQUENCE {			
semiPersistSchedIntervalUL	sf40	40 Subframe	
implicitReleaseAfter	e2		
p0-Persistent	Not Present		
twoIntervalConfig	Not Present		FDD
twoIntervalConfig	true		TDD
}			
}			
}			
}			

Table 7.1.4.2.3.3-2: *RRCCONNECTIONRECONFIGURATION*. RadioResourceConfigDedicated (step 33 of table 7.1.4.2.3.2-1)

Derivation path: 36.508 table 4.6.3-16			
Information Element	Value/remark	Comment	Condition
RadioResourceConfigDedicated ::= SEQUENCE {			
sps-Configuration ::= SEQUENCE {			
semiPersistSchedC-RNTI	Not Present		
sps-ConfigurationDL	Not Present		
sps-ConfigurationUL ::= CHOICE {			
disable	NULL		
}			
}			
}			

Table 7.1.4.2.3.3-3: *RRCConnectionReconfiguration* (preamble: Table 4.5.3.3-1, step 8)

Derivation path: 36.508 table 4.8.2.1.5-1			
Information Element	Value/Remark	Comment	Condition
RRCConnectionReconfiguration ::= SEQUENCE {			
criticalExtensions CHOICE {			
c1 CHOICE{			
rrcConnectionReconfiguration-r8 SEQUENCE {			
RadioResourceConfigDedicated SEQUENCE {			
mac-MainConfig CHOICE {			
drx-Config CHOICE {			pc_FeatrGr p_5 AND DRX_S
setup SEQUENCE {			
onDurationTimer	psf40		
}			
}			
}			
}			
}			
}			
}			

Condition	Explanation
DRX_S	Used for DRX configuration with small DRX cycle length

7.1.4.3 Logical channel prioritization handling

7.1.4.3.1 Test Purpose (TP)

(1)

```
with { UE in E-UTRA RRC_CONNECTED state }
ensure that {
  when { sending data on the uplink }
  then { UE serves the logical channels according to their priority and configured PBR }
}
```

7.1.4.3.2 Conformance requirements

References: The conformance requirements covered in the present TC are specified in: 3GPP TS 36.321 clauses 5.4.3.1.

[TS 36.321, clause 5.4.3.1]

The Logical Channel Prioritization procedure is applied when a new transmission is performed.

RRC controls the scheduling of uplink data by signalling for each logical channel: *priority* where an increasing *priority* value indicates a lower priority level, *prioritisedBitRate* which sets the Prioritized Bit Rate (PBR), *bucketSizeDuration* which sets the Bucket Size Duration (BSD).

The UE shall maintain a variable B_j for each logical channel j . B_j shall be initialized to zero when the related logical channel is established, and incremented by the product $PBR \times TTI$ duration for each TTI, where PBR is Prioritized Bit Rate of logical channel j . However, the value of B_j can never exceed the bucket size and if the value of B_j is larger than the bucket size of logical channel j , it shall be set to the bucket size. The bucket size of a logical channel is equal to $PBR \times BSD$, where PBR and BSD are configured by upper layers.

The UE shall perform the following Logical Channel Prioritization procedure when a new transmission is performed:

- The UE shall allocate resources to the logical channels in the following steps:
 - Step 1: All the logical channels with $B_j > 0$ are allocated resources in a decreasing priority order. If the PBR of a radio bearer is set to “infinity”, the UE shall allocate resources for all the data that is available for transmission on the radio bearer before meeting the PBR of the lower priority radio bearer(s);
 - Step 2: the UE shall decrement B_j by the total size of MAC SDUs served to logical channel j in Step 1

NOTE: The value of B_j can be negative.

- Step 3: if any resources remain, all the logical channels are served in a strict decreasing priority order (regardless of the value of B_j) until either the data for that logical channel or the UL grant is exhausted, whichever comes first. Logical channels configured with equal priority should be served equally.
- The UE shall also follow the rules below during the scheduling procedures above:
 - the UE should not segment an RLC SDU (or partially transmitted SDU or retransmitted RLC PDU) if the whole SDU (or partially transmitted SDU or retransmitted RLC PDU) fits into the remaining resources;
 - if the UE segments an RLC SDU from the logical channel, it shall maximize the size of the segment to fill the grant as much as possible;
 - UE should maximise the transmission of data.

The UE shall not transmit data for a logical channel corresponding to a radio bearer that is suspended (the conditions for when a radio bearer is considered suspended are defined in [8]).

For the Logical Channel Prioritization procedure, the UE shall take into account the following relative priority in decreasing order:

- MAC control element for C-RNTI or data from UL-CCCH;
- MAC control element for BSR, with exception of BSR included for padding;
- MAC control element for PHR;
- data from any Logical Channel, except data from UL-CCCH;
- MAC control element for BSR included for padding.

7.1.4.3.3 Test description

7.1.4.3.3.1 Pre-test conditions

System Simulator:

- Cell 1

UE:

None

Preamble:

- The UE is in state Loopback Activated (state 4) according to [18] with the exceptions listed in table 7.1.4.3.3.1-2 applicable for the configured UM DRBs and table 7.1.4.3.3.1-3 for SR configuration.
- The condition SRB2-DRB(1,3) is used for step 8 in 4.5.3A.3 according to [18].
- The 3 UM DRBs are configured according to table 7.1.4.3.3.1-1.

Table 7.1.4.3.3.1-1: Priority, PBR and Bucket Delay settings

DRB	priority	prioritizedBitRate (kbytes/s)	bucketSizeDuration (ms)
DRB1	6	8	100
DRB2	7	16	100
DRB3	8	32	100

Table 7.1.4.3.3.1-2: PDCP Settings

Parameter	Value
Discard_Timer	ms1500

Table 7.1.4.3.3.1-3: SchedulingRequest-Config

Derivation Path: 36.508 Table 4.6.3-20			
Information Element	Value/remark	Comment	Condition
dsr-TransMax	n16		

7.1.4.3.3.2 Test procedure sequence

Table 7.1.4.3.3.2-1: Main behaviour

St	Procedure	Message Sequence		TP	Verdict
		U - S	Message		
-	EXCEPTION: Steps 0 to 4 are run 4 times using the parameters specified for each run in table 7.1.4.3.3.2-3.	-	-	-	-
0	Void	-	-	-	-
1	The SS transmits N1 320-octet RLC SDUs on DRB1, N2 320-octet RLC SDUs on DRB2, and N3 320-octet RLC SDUs on DRB3.	<--	(RLC SDUs)	-	-
-	EXCEPTION: In parallel to the event described in step 2 the events specified in Table 7.1.4.3.3.2-2 shall take place.	-	-	-	-
2	The SS is configured for Uplink Grant Allocation Type 2. 150 ms after Step 1 (Note1), for a duration of T2, the SS transmits an UL grant of D octets every T1.	<--	(UL grants)	-	-
3	Check: are the total number of octets of the UL RLC SDUs received at the SS for each DRB as follows? - the total number of octets received for DRB1 is D1 octets +/- 10% - the total number of octets received for DRB2 is D2 octets +/- 10% - the total number of octets received for DRB3 is D3 octets +/- 10%	-	-	1	P
4	The SS re-establishes the RLC for each RB at the UE by sending an RRCConnectionReconfiguration for intra-cell handover with SR configuration set as per Table 7.1.4.3.3.1-3.	-	-	-	-
Note 1: This wait time will ensure that a) all octets have been completely received by the UE on all 3 DRBs before the first UL grant is received and b) the Bj's for each logical channel have reached their maximum value i.e. the bucket size of the corresponding logical channel before the first UL grant is received.					

Table 7.1.4.3.3.2-2: Parallel behaviour

St	Procedure	Message Sequence		TP	Verdict
		U - S	Message		
1	Check: Does the UE transmit the RLC SDUs back to the SS?	-->	-	1	P

Table 7.1.4.3.3.2-3: Test parameter values

Parameter	First run	Second run	Third run	Fourth run
N1 (SDUs)	13	13	7	104
N2 (SDUs)	25	25	50	25
N3 (SDUs)	50	50	50	50
D (octets)	1143	573	1143	1143
T1 (ms)	20	20	20	10
T2 (ms)	500	700	500	500
D1 (octets)	4160	4160	2240	33000 (Note 1)
D2 (octets)	8000	8000	10260 (Note 1)	8000
D3 (octets)	16000	7790 (Note 1)	16000	16000
Note 1: It is calculated from the following equation for the case of the least header size. $(D1 + D2 + D3) = (D - 3) * T2 / T1$				

NOTE: the numbers above and the test procedure assume that the UE has a loopback buffer of at least 57280 octets.

7.1.4.3.3.3 Specific message contents

Table 7.1.4.3.3.3-1: *RRCConnectionReconfiguration* (step 4, table 7.1.4.3.3.2-1)

Derivation Path: 36.508 table 4.6.1-8: <i>RRCConnectionReconfiguration</i> , condition HO			
Information Element	Value/remark	Comment	Condition
<i>RRCConnectionReconfiguration</i> ::= SEQUENCE {			
criticalExtensions CHOICE {			
c1 CHOICE{			
rrcConnectionReconfiguration-r8 SEQUENCE {			
mobilityControlInfo SEQUENCE {			
targetPhysCellId	Set to the physical cell identity of cell 1		
carrierFreq	Not present		
}			
}			
}			
}			
}			

7.1.4.4 Correct handling of MAC control information / Scheduling requests and PUCCH

7.1.4.4.1 Test Purpose (TP)

(1)

```
with { UE in E-UTRA RRC_CONNECTED state }
```

```
ensure that {
  when { PUCCH is configured and UE has UL data available for transmission and UE has no UL-SCH
resources available and SR_COUNTER is less than dsr-TransMax }
  then { the UE transmits a SR on every available PUCCH until resources are granted }
}
```

(2)

```
with { UE in E-UTRA RRC_CONNECTED state and has pending SR(s) }
ensure that {
  when { UE receives an UL grant for a new transmission }
  then { UE cancels all pending SR(s) }
}
```

7.1.4.4.2 Conformance requirements

References: The conformance requirements covered in the current TC are specified in: TS 36.321, clause 5.4.4.

[TS 36.321, clause 5.4.4]

The Scheduling Request (SR) is used for requesting UL-SCH resources for new transmission.

When an SR is triggered, it shall be considered as pending until it is cancelled.

If an SR is triggered and there is no other SR pending, the UE shall set the SR_COUNTER to 0.

As long as one SR is pending, the UE shall for each TTI:

- if no UL-SCH resources are available for a transmission in this TTI:
 - if the UE has no valid PUCCH resource for SR configured in any TTI: initiate a Random Access procedure (see subclause 5.1) and cancel all pending SRs;
 - else if the UE has a valid PUCCH resource for SR configured for this TTI and if this TTI is not part of a measurement gap:
 - if SR_COUNTER < *dscr-TransMax*:
 - increment SR_COUNTER by 1;
 - instruct the physical layer to signal the SR on PUCCH;
 - else:
 - notify RRC to release PUCCH/SRS;
 - clear any configured downlink assignments and uplink grants;
 - initiate a Random Access procedure (see subclause 5.1) and cancel all pending SRs.
- else if UL-SCH resources for new transmission are granted in this TTI, cancel all pending SR(s).

7.1.4.4.3.1 Pre-test conditions

System Simulator:

- - Cell 1
- RRC Connection Reconfiguration (preamble: Table 4.5.3.3-1, step 8) using parameters as specified in Table 7.1.4.4.3.3-1

UE:

None.

Preamble:

- The UE is in state Loopback Activated (state 4) according to [18].

Table 7.1.4.4.3.1-1: RLC settings

Parameter	Value
t-PollRetransmit	250 ms

7.1.4.4.3.2 Test procedure sequence

Table 7.1.4.4.3.2-1: Main behaviour

St	Procedure	Message Sequence		TP	Verdict
		U - S	Message		
1	The SS transmits a MAC PDU containing 10 MAC SDUs each containing a RLC SDU	<--	MAC PDU (containing 10 MAC SDUs)	-	-
-	EXCEPTION: Step 2 runs in parallel with behaviour in table 7.1.4.4.3.2-2.	-	-	-	-
2	Check: Does the UE transmit 6 Scheduling Requests separately on 6 consecutively available PUCCHs? (Note 1)	-->	(SR)	1	P
3	The SS is configured for Uplink Grant Allocation Type 3. The SS transmits an UL grant to allocate UL-SCH resources that are enough to transmit MAC PDU containing 10 MAC SDUs	<--	(UL Grant)	-	-
4	Check: Does the UE transmit a MAC PDU containing 10 RLC PDUs?	-->	MAC PDU (containing 10 MAC SDUs)	1	P
5	Check: 1 second does the UE transmit a Scheduling Request in the next 100ms?	-->	(SR)	1,2	F
Note 1: The UE repeats the scheduling requests on every available PUCCH as long as SR_COUNTER < dsr-TransMax and there is UL data available for transmission and there are no resources available to transmit it. At the reception of first Scheduling Request from the UE, SS will be scheduled to transmit a grant after 100ms. Hence SS will receive 6 Scheduling Requests as sr-ConfigIndex = 30.					

Table 7.1.4.4.3.2-2: Parallel behaviour

St	Procedure	Message Sequence		TP	Verdict
		U - S	Message		
1	Check: Does the UE transmit a MAC PDU?	-->	MAC PDU	1	F

7.1.4.4.3.3 Specific Message Contents

Table 7.1.4.4.3.3-1: SchedulingRequest-Configuration to be used in RRCConnectionReconfiguration in preamble

Derivation Path: 36.508 clause 4.6.3-20			
Information Element	Value/remark	Comment	Condition
SchedulingRequest-Configuration ::= CHOICE {			
enable SEQUENCE {			
dsr-TransMax	n64		
}			
}			

7.1.4.4.3.3 Specific Message Contents

None.

7.1.4.5 Correct handling of MAC control information / Scheduling requests and random access procedure

7.1.4.5.1 Test Purpose (TP)

(1)

```

with { The UE is in E-UTRA RRC_CONNECTED state and no PUCCH resource for SR is configured }
ensure that {
  when { UE has UL data available for transmission, UE has no UL-SCH resources available and time
alignment timer expires }
  then { the UE initiates the random access procedure }
}

```

(2)

```

with { The UE in E-UTRA RRC_CONNECTED state )
ensure that {
  when { PUCCH Configured and UE has UL data available for transmission and UE has no UL-SCH
resources available and SR_COUNTER becomes equal to dss-TransMax }
  then { the UE transmits a PRACH Preamble to initiate a Random Access procedure }

:}

```

7.1.4.5.2 Conformance requirements

References: The conformance requirements covered in the current TC are specified in: TS 36.321 , clause 5.4.4.

[TS 36.321 clause 5.4.4]

The Scheduling Request (SR) is used for requesting UL-SCH resources for new transmission.

When an SR is triggered, it shall be considered as pending until it is cancelled.

If an SR is triggered and there is no other SR pending, the UE shall set the SR_COUNTER to 0.

As long as one SR is pending, the UE shall for each TTI:

- if no UL-SCH resources are available for a transmission in this TTI:
 - if the UE has no valid PUCCH resource for SR configured in any TTI: initiate a Random Access procedure (see subclause 5.1) and cancel all pending SRs;
 - else if the UE has a valid PUCCH resource for SR configured for this TTI and if this TTI is not part of a measurement gap:
 - if SR_COUNTER < *dss-TransMax*:
 - increment SR_COUNTER by 1;
 - instruct the physical layer to signal the SR on PUCCH;
 - else:
 - notify RRC to release PUCCH/SRS;
 - clear any configured downlink assignments and uplink grants;
 - initiate a Random Access procedure (see subclause 5.1) and cancel all pending SRs.- else if UL-SCH resources for new transmission are granted in this TTI, cancel all pending SR(s).

7.1.4.5.3 Test description

7.1.4.5.3.1 Pre-test conditions

System Simulator:

- Cell 1

UE:

None.

Preamble:

- The UE is in state Loopback Activated (state 4) according to [18].

7.1.4.5.3.2 Test procedure sequence

Table 7.1.4.5.3.2-1: Main behaviour

St	Procedure	Message Sequence		TP	Verdict
		U - S	Message		
1	The SS transmits a MAC PDU containing a Timing Advance Command MAC Control Element, but does not send any subsequent alignments.	<--	MAC PDU (Timing Advance Command)	-	-
1A	The SS transmits a MAC PDU containing a MAC SDU	<--	MAC PDU (MAC SDU)	-	-
-	EXCEPTION: Step 2B is repeated less than 64 times (<i>dsr-TransMax</i>)	-	-	-	-
2B	The UE may transmit Scheduling Requests before time alignment timer expires. The SS shall not respond to the Scheduling Requests in this step. (Note 5)	-->	(SR)	-	-
2	Check: does the UE transmit a preamble on PRACH? (Note 1)	-->	(PRACH Preamble)	1	P
3	The SS transmits a Random Access Response including an UL grant to enable UE to transmit C-RNTI MAC Control Element and the MAC SDU as received in step 1A.	<--	Random Access Response	-	-
4	The UE transmit a MAC PDU including a C-RNTI MAC Control Element and a MAC SDU. (Note 2)	-->	MAC PDU (C-RNTI control element, MAC SDU)	-	-
5	The SS sends PDCCH transmission for UE C-RNTI	<--	-	-	-
5A	The SS transmits <i>RRConnectionReconfiguration</i> containing a <i>radioResourceConfiguration</i> with a physical channel reconfiguration	<--		-	-
-	EXCEPTION: Steps 5A1 to 5A4 are optionally executed. (Note 6)	-		-	-
5A 1	The UE transmits a preamble on PRACH. (Note 6)	-->	(PRACH Preamble)	-	-
5A 2	The SS transmits a Random Access Response including an UL grant of 7 bytes. (Note 7)	<--	Random Access Response	-	-
5A 3	The UE transmit a MAC PDU including a C-RNTI MAC Control Element	-->	-	-	-
5A 4	The SS sends PDCCH transmission for UE C-RNTI of 5 bytes (Note 9)	<--	-	-	-
5B	The UE transmits a Scheduling Request on PUCCH. (Note 8)	-->	(SR)	-	-
5C	The SS transmits an UL grant to enable UE to transmit the <i>RRConnectionReconfigurationComplete</i> message. (Note 10)	<--	(UL Grant)	-	-
5D	The UE transmits <i>RRConnectionReconfigurationComplete</i> message.	-->	-	-	-
5E	Void	-	-	-	-
6	The SS ignores any Scheduling Requests from the UE.	-	-	-	-
7	The SS transmits a MAC PDU containing one MAC SDU containing a RLC SDU	<--	MAC PDU MAC SDU)	-	-
-	EXCEPTION: Step 8 shall be repeated 8 times.	-	-	-	-
8	The UE transmits a Scheduling Request on PUCCH (Note 3)	-->	(SR)	-	-
9	Check: does the UE transmit a preamble on PRACH? (Note 4)	-->	(PRACH Preamble)	2	P
10	The SS transmits a Random Access Response including an UL grant to enable UE to transmit C-RNTI MAC Control Element and the MAC SDU as received in step 7.	<--	Random Access Response	-	-

11	The UE transmit a MAC PDU including a C-RNTI MAC Control Element and a MAC SDU. (Note 2)	-->	MAC PDU (C-RNTI control element, MAC SDU)	-	-
12	The SS sends PDCCH transmission for UE C-RNTI	<--	-	-	-
<p>Note 1: When UL time alignment timer expires in the UE then "UL synchronization" is lost and the UE initiates a Random Access Procedure.</p> <p>Note 2: The UE transmission of the MAC PDU ensures that the random access procedure was successful.</p> <p>Note 3: The UE repeats the scheduling requests as long as SR_COUNTER < <i>dsr-TransMax</i> and there is data in the transmission buffer and there are no resources available to transmit it.</p> <p>Note 4: Reception of PRACH Preamble by the SS verifies that UE has initiated a Random Access procedure triggered by SR_COUNTER having reached <i>dsr-TransMax</i>.</p> <p>Note 5: In step 2B, SR repetition of 63 times (<i>dsr-TransMax</i> (64)) will take at least 63*20 = 1260 ms which is much larger than TA timer 750ms.</p> <p>Note 6: RLC status PDU may trigger the UE to transmit PRACH Preamble.</p> <p>Note 7: UL grant of 56 bits (ITBS=4, NPRB=1, see TS 36.213 Table 7.1.7.2.1-1) is chosen to allow the UE to transmit C-RNTI MAC Control Element but not allowing the UE to transmit RRCConnectionReconfiguration Complete. 7 bytes allow transmission of C-RNTI + Short BSR or C-RNTI + STATUS PDU.</p> <p>Note 8: If RRCConnectionReconfigurationComplete was not ready for transmission in step 5A3 then SR is triggered when RRC message arrives in the transmission buffer. Otherwise (RRCConnectionReconfigurationComplete was ready for the transmission in step 5A3) the SR is triggered because expiry of the retxBSR-Timer.</p> <p>Note 9: 5 bytes are assigned so that STATUS PDU can be included if it was not transmitted by the UE in step 5A3 (see Note 7) (5 bytes assignment allow transmission of Short BSR + STATUS PDU)</p> <p>Note 10: STATUS PDU is included if optional test steps 5A1 to 5A4 were not executed.</p>					

7.1.4.5.3.3 Specific Message Contents

Table 7.1.4.5.3.3-1: SchedulingRequest-Config to be used in RRCConnectionReconfiguration (preamble, Table 7.1.4.5.3.2-1)

Derivation Path: 36.508 clause 4.6.3-20			
Information Element	Value/remark	Comment	Condition
SchedulingRequest-Config-DEFAULT ::= CHOICE {			
setup SEQUENCE {			
dsr-TransMax	n64		
}			
}			

Table 7.1.4.5.3.3-2: RRCConnectionReconfiguration (step 5A, Table 7.1.4.5.3.2-1)

Derivation Path: 36.331 clause 6.2.2			
Information Element	Value/remark	Comment	Condition
RRCConnectionReconfiguration ::= SEQUENCE {			
rrc-TransactionIdentifier	RRC-TransactionIdentifier-DL		
criticalExtensions CHOICE {			
c1 CHOICE {			
rrcConnectionReconfiguration-r8 SEQUENCE {			
measConfig	Not present		
mobilityControlInfo	Not present		
dedicatedInfoNASList	Not present		
radioResourceConfigDedicated	RadioResourceConfigDedicated-Step5a		
securityConfigHO	Not present		
nonCriticalExtension SEQUENCE {	Not present		
}			
}			
}			
}			

Table 7.1.4.5.3.3-3: RadioResourceConfigDedicated-Step5A (Table 7.1.4.5.3.3-2)

Derivation Path: 36.331 clause 6.3.2			
Information Element	Value/remark	Comment	Condition
RadioResourceConfigDedicated-HO ::= SEQUENCE {			
srb-ToAddModList	Not present		
drb-ToAddModList	Not present		
drb-ToReleaseList	Not present		
mac-MainConfig	Not present		
sps-Config	Not present		
physicalConfigDedicated	PhysicalConfigDedicated-Step5a		
}			

Table 7.1.4.5.3.3-4: PhysicalConfigDedicated-Step5A (Table 7.1.4.5.3.3-3)

Derivation Path: 36.331 clause 6.3.2			
Information Element	Value/remark	Comment	Condition
PhysicalConfigDedicated-DEFAULT ::= SEQUENCE {			
pdsch-ConfigDedicated	Not present		
pucch-ConfigDedicated	Not present		
pusch-ConfigDedicated	Not present		
uplinkPowerControlDedicated	Not present		
tpc-PDCCH-ConfigPUCCH	Not present		
tpc-PDCCH-ConfigPUSCH	Not present		
cqi-ReportConfig	CQI-ReportConfig-DEFAULT using condition CQI_PERIODIC	See subclause 4.6.3 of 36.508	
soundingRS-LU-ConfigDedicated	SoundingRS-ULI-ConfigDedicated-DEFAULT	See subclause 4.6.3 of 36.508	
antennaInfo	Not present		
schedulingRequestConfig	SchedulingRequest-Config-Config-Step5a		
}			

Table 7.1.4.5.3.3-5: SchedulingRequest-Config-Step5A (Table 7.1.4.5.3.3-4)

Derivation Path: 36.508 clause 4.6.3-20			
Information Element	Value/remark	Comment	Condition
SchedulingRequest-Config ::= CHOICE {			
enable SEQUENCE {			
dsr-TransMax	n8		
}			
}			

Table 7.1.4.5.3.3-6: MAC-MainConfig-RBC in RRCConnectionReconfiguration(preamble)

Derivation Path: 36.508 table 4.8.2.1.5-1			
Information Element	Value/remark	Comment	Condition
MAC-MainConfigRBC ::= SEQUENCE {			
ul-SCH-Configuration SEQUENCE {			
retxBSR-Timer	sf320		
}			
}			

7.1.4.6 Correct handling of MAC control information / Buffer status / UL data arrive in the UE Tx buffer and retransmission of BSR / Regular BSR

7.1.4.6.1 Test Purpose (TP)

(1)

```
with ( UE in E-UTRA RRC_CONNECTED state )
ensure that {
  when { UL data arrives in the UE transmission buffer and the data belongs to a logical channel
with higher priority than those for which data is already available for transmission and the new
logical channel and the existing logical channels belongs to the different LCG }
  then { UE Reports a Long Buffer Status Reporting (BSR) }
}
```

(2)

```
with ( UE in E-UTRA RRC_CONNECTED state )
ensure that {
  when { UL data arrives in the UE transmission buffer and there is no data available for
transmission for any of the logical channels which belong to a LCG }
  then { UE Reports a Short Buffer Status Reporting (BSR) }
}
```

(3)

```
with ( UE in E-UTRA RRC_CONNECTED state )
ensure that {
  when { UL data arrives in the UE transmission buffer and the data belongs to a logical channel
with higher priority than those for which data is already available for transmission and the new
logical channel and existing logical channels belong to the same LCG }
  then { UE Reports a Short Buffer Status Reporting (BSR) }
}
```

(4)

```
with ( UE in E-UTRA RRC_CONNECTED state )
ensure that {
  when { RETX_BSR_TIMER expires and only one LCG has data available for transmission }
  then { UE triggers a regular BSR and Reports a Short Buffer Status Reporting (BSR) }
}
```

(5)

```
with (UE in E-UTRA RRC_CONNECTED state)
ensure that {
  when { a Regular BSR has been triggered and UE has pending data for transmission and UE has only
resources to send either BSR report or data }
  then { UE transmits the BSR report }
}
```

(6)

```
with ( UE in E-UTRA RRC_CONNECTED state )
ensure that {
  when { UE determines that a BSR has been triggered since the last transmission of a BSR and UE has
no UL resources allocated for new transmission for this TTI }
  then { UE transmits a scheduling request }
}
```

(7)

```
with (UE in E-UTRA RRC_CONNECTED state)
ensure that {
  when { a Regular BSR has been triggered and UE has pending data on several logical channels for
transmission and UE has only UL resources to send all pending data available for transmission, but
UL grant is not sufficient to additionally accommodate the BSR MAC control element}
  then { UE cancels the triggered BSR report and transmits the UL data}
}
```

(8)

```
with (UE in E-UTRA RRC_CONNECTED state)
```

```

ensure that {
  when { a Regular BSR has been triggered and UE has pending data on several logical channels for
  transmission and UE has UL resources to send all pending data including BSR }
  then { UE transmits the UL data and reports buffer status reporting (BSR) that indicates there
  is no more data in the buffer}
}

```

7.1.4.6.2 Conformance requirements

References: The conformance requirements covered in the current TC are specified in: TS 36.321, clause 5.4.3.1, 5.4.5, 6.1.2, 6.1.3.1 and 6.2.1 and in TS 36.323 clause 4.5.

[TS 36.321 clause 5.4.3.1]

For the Logical Channel Prioritization procedure, the UE shall take into account the following relative priority in decreasing order:

- MAC control element for C-RNTI or data from UL-CCCH;
- MAC control element for BSR, with exception of BSR included for padding;
- MAC control element for PHR;
- data from any Logical Channel, except data from UL-CCCH;
- MAC control element for BSR included for padding.

[TS 36.321 clause 5.4.4]

The Scheduling Request (SR) is used for requesting UL-SCH resources for new transmission.

[TS 36.321 clause 5.4.5]

The Buffer Status reporting procedure is used to provide the serving eNB with information about the amount of data available for transmission in the UL buffers of the UE. RRC controls BSR reporting by configuring the two timers *periodicBSR-Timer* and *retxBSR-Timer* and by, for each logical channel, optionally signalling *logicalChannelGroup* which allocates the logical channel to an LCG [8].

For the Buffer Status reporting procedure, the UE shall consider all radio bearers which are not suspended and may consider radio bearers which are suspended.

A Buffer Status Report (BSR) shall be triggered if any of the following events occur:

- UL data, for a logical channel which belongs to a LCG, becomes available for transmission in the RLC entity or in the PDCP entity (the definition of what data shall be considered as available for transmission is specified in [3] and [4] respectively) and either the data belongs to a logical channel with higher priority than the priorities of the logical channels which belong to any LCG and for which data is already available for transmission, or there is no data available for transmission for any of the logical channels which belong to a LCG, in which case the BSR is referred below to as "Regular BSR";
- UL resources are allocated and number of padding bits is equal to or larger than the size of the Buffer Status Report MAC control element plus its subheader, in which case the BSR is referred below to as "Padding BSR";
- *retxBSR-Timer* expires and the UE has data available for transmission for any of the logical channels which belong to a LCG, in which case the BSR is referred below to as "Regular BSR";
- *periodicBSR-Timer* expires, in which case the BSR is referred below to as "Periodic BSR".

For Regular and Periodic BSR:

- if more than one LCG has data available for transmission in the TTI where the BSR is transmitted: report Long BSR;
- else report Short BSR.

For Padding BSR:

- if the number of padding bits is equal to or larger than the size of the Short BSR plus its subheader but smaller than the size of the Long BSR plus its subheader:
 - if more than one LCG has data available for transmission in the TTI where the BSR is transmitted: report Truncated BSR of the LCG with the highest priority logical channel with data available for transmission;
 - else report Short BSR.
- else if the number of padding bits is equal to or larger than the size of the Long BSR plus its subheader, report Long BSR.

If the Buffer Status reporting procedure determines that at least one BSR has been triggered and not cancelled:

- if the UE has UL resources allocated for new transmission for this TTI:
 - instruct the Multiplexing and Assembly procedure to generate a BSR MAC control element;
 - start or restart *periodicBSR-Timer* except when the BSR is a Truncated BSR;
 - start or restart *retxBSR-Timer*.
- else if a Regular BSR has been triggered:
 - a Scheduling Request shall be triggered.

A MAC PDU shall contain at most one MAC BSR control element, even when multiple events trigger a BSR by the time a BSR can be transmitted in which case the Regular BSR and the Periodic BSR shall have precedence over the padding BSR.

The UE shall restart *retxBSR-Timer* upon indication of a grant for transmission of new data on UL-SCH.

All triggered BSRs shall be cancelled in case the UL grant can accommodate all pending data available for transmission but is not sufficient to additionally accommodate the BSR MAC control element plus its subheader. All triggered BSRs shall be cancelled when a BSR is included in a MAC PDU for transmission.

[TS 36.321 clause 6.1.2]

MAC control elements are always placed before any MAC SDU.

[TS 36.321 clause 6.1.3.1]

Buffer Status Report (BSR) MAC control elements consist of either:

- Short BSR and Truncated BSR format: one LCG ID field and one corresponding Buffer Size field (figure 6.1.3.1-1); or
- Long BSR format: four Buffer Size fields, corresponding to LCG IDs #0 through #3 (figure 6.1.3.1-2).

The BSR formats are identified by MAC PDU subheaders with LCIDs as specified in table 6.2.1.-1.

The fields LCG ID and Buffer Size are defined as follow:

- LCG ID: The Logical Channel Group ID field identifies the group of logical channel(s) which buffer status is being reported. The length of the field is 2 bits;
- Buffer Size: The Buffer Size field identifies the total amount of data available across all logical channels of a logical channel group after the MAC PDU has been built. The amount of data is indicated in number of bytes. It shall include all data that is available for transmission in the RLC layer and in the PDCP layer; the definition of what data shall be considered as available for transmission is specified in [3] and [4] respectively. The size of the RLC and MAC headers are not considered in the buffer size computation. The length of this field is 6 bits. The values taken by the Buffer Size field are shown in Table 6.1.3.1-1.

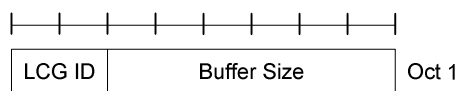

Figure 6.1.3.1-1: Short BSR and Truncated BSR MAC control element

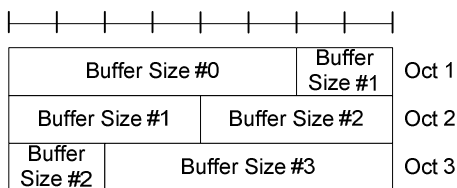

Figure 6.1.3.1-2: Long BSR MAC control element

Table 6.1.3.1-1: Buffer size levels for BSR

Index	Buffer Size (BS) value [bytes]	Index	Buffer Size (BS) value [bytes]
0	BS = 0	32	1132 < BS <= 1326
1	0 < BS <= 10	33	1326 < BS <= 1552
2	10 < BS <= 12	34	1552 < BS <= 1817
3	12 < BS <= 14	35	1817 < BS <= 2127
4	14 < BS <= 17	36	2127 < BS <= 2490
5	17 < BS <= 19	37	2490 < BS <= 2915
6	19 < BS <= 22	38	2915 < BS <= 3413
7	22 < BS <= 26	39	3413 < BS <= 3995
8	26 < BS <= 31	40	3995 < BS <= 4677
9	31 < BS <= 36	41	4677 < BS <= 5476
10	36 < BS <= 42	42	5476 < BS <= 6411
11	42 < BS <= 49	43	6411 < BS <= 7505
12	49 < BS <= 57	44	7505 < BS <= 8787
13	57 < BS <= 67	45	8787 < BS <= 10287
14	67 < BS <= 78	46	10287 < BS <= 12043
15	78 < BS <= 91	47	12043 < BS <= 14099
16	91 < BS <= 107	48	14099 < BS <= 16507
17	107 < BS <= 125	49	16507 < BS <= 19325
18	125 < BS <= 146	50	19325 < BS <= 22624
19	146 < BS <= 171	51	22624 < BS <= 26487
20	171 < BS <= 200	52	26487 < BS <= 31009
21	200 < BS <= 234	53	31009 < BS <= 36304
22	234 < BS <= 274	54	36304 < BS <= 42502
23	274 < BS <= 321	55	42502 < BS <= 49759
24	321 < BS <= 376	56	49759 < BS <= 58255
25	376 < BS <= 440	57	58255 < BS <= 68201
26	440 < BS <= 515	58	68201 < BS <= 79846
27	515 < BS <= 603	59	79846 < BS <= 93479
28	603 < BS <= 706	60	93479 < BS <= 109439
29	706 < BS <= 826	61	109439 < BS <= 128125
30	826 < BS <= 967	62	128125 < BS <= 150000
31	967 < BS <= 1132	63	BS > 150000

[TS 36.321 clause 6.2.1]

Table 6.2.1-2: Values of LCID for UL-SCH

Index	LCID values
00000	CCCH
00001-01010	Identity of the logical channel
01011-11001	Reserved
11010	Power Headroom Report
11011	C-RNTI
11100	Truncated BSR
11101	Short BSR
11110	Long BSR
11111	Padding

[TS 36.323 clause 4.5]

For the purpose of MAC buffer status reporting, the UE shall consider the following as data available for transmission in the PDCP layer:

For SDUs for which no PDU has been submitted to lower layers:

- the SDU itself, if the SDU has not yet been processed by PDCP, or
- the PDU (control or data) if the SDU has been processed by PDCP.

7.1.4.6.3 Test description

7.1.4.6.3.1 Pre-test conditions

System Simulator :

- Cell 1
- RRC Connection Reconfiguration (preamble: Table 4.5.3.3-1, step 8) using parameters as specified in Table 7.1.4.6.3.3-1

UE:

None.

Preamble:

- The UE is in state Loopback Activated (state 4) according to [18].
- The condition SRB2-DRB(3,0) is used for step 8 in 4.5.3A.3 according to [18].
- 3 AM DRBS are configured with the following parameters:

Table 7.1.4.6.3.1-1: Logical Channel Configuration Settings

Parameter	Value DRB1	Value DRB2	Value DRB3
LogicalChannel-Identity	3	4	5
Priority	8	7	6
prioritizedBitRate	0 kB/s	0 kB/s	0 kB/s
logicalChannelGroup	2 (LCG ID#2)	2 (LCG ID#2)	1 (LCG ID#1)

7.1.4.6.3.2 Test procedure sequence

Table 7.1.4.6.3.2-1: Main behaviour

St	Procedure	Message Sequence		TP	Verdict
		U - S	Message		
1	The SS ignores scheduling requests and does not allocate any uplink grant.	-	-	-	-
2	The SS transmits a MAC PDU containing two RLC SDUs of size 10 bytes on LC 3	<--	MAC PDU (2 RLC SDUs on LC 3)	-	-
3	SS allocates an UL Grant of 32 bits. (Note 1)	<--	(UL Grant, 32 bits)	-	-
4	Check: Does the UE transmit a Short BSR with 'LCG ID' field set to '2' and 'Buffer size' field set to value '6' or bigger? (Note 2)	-->	MAC PDU (MAC Short BSR (LCG ID='2', Buffer Size='6' or bigger))	2,5	P
5	Wait for retxBSR-Timer expiry on UE side.	-	-	-	-
6	Check: Does the UE transmit a scheduling request?	-->	(SR)	6	P
7	The SS respond to the scheduling request in step 6 by an UL Grant of 32 bits. (Note 1)	<--	(UL Grant, 32 bits)	-	-
8	Check: Does the UE transmit a Short BSR with 'LCG ID' field set to '2' and 'Buffer size' field set to value '6' or bigger? (Note 2)	-->	MAC PDU (MAC Short BSR (LCG ID='2', Buffer Size='6' or bigger))	4,5	P
9	The SS transmits a MAC PDU containing one RLC SDUs of size 10 bytes on LC 4	<--	MAC PDU (1 RLC SDUs on LC 4)	-	-
10	Check: Does the UE transmit a scheduling request?	-->	(SR)	6	P
11	The SS respond to the scheduling request in step 10 by an UL Grant of 32 bits. (Note 1)	<--	(UL Grant, 32 bits)	-	-
12	Check: Does the UE transmit a Short BSR with 'LCG ID' field set to '2' and 'Buffer size#1' field set to value '8' or bigger? (Note 2)	-->	MAC PDU (MAC Short BSR (LCG ID='2', Buffer Size='8' or bigger))	3,5	P
13	The SS transmits a MAC PDU containing two RLC SDUs of size 4 bytes on LC 5	<--	MAC PDU (2 RLC SDUs on LC 5)	-	-
14	Check: Does the UE transmit a scheduling request?	-->	(SR)	6	P
15	The SS respond to the scheduling request in step 14 by one UL Grant of 32 bits. (Note 1)	<--	(UL Grant, 32 bits)	-	-
16	Check: Does the UE transmit a Long BSR with 'Buffer size#1' field set to value '1', 'Buffer size#2' field set to value '8' or bigger? (Note 3)	-->	MAC PDU (MAC Long BSR (Buffer size#1='1' or bigger, Buffer size#2='8' or bigger))	1,5	P
17	Wait for retxBSR-Timer expiry on the UE side.	-	-	-	-
18	Check: Does the UE transmit a scheduling request?	-->	(SR)	6	P
19	SS allocates an UL Grant of 424 bits. (Note 4)	<--	(UL Grant, 424 bits)	-	-
20	Check: Does the UE transmit a MAC PDU including five RLC SDUs and not including any BSR? (Note 5)	-->	MAC PDU (SDU subheader, AMD PDU header and 2 RLC SDUs on LC 3, SDU subheader, AMD PDU header and 1 RLC SDUs on LC 4, SDU subheader, AMD PDU header and 2 RLC SDUs on LC 5)	7	P
21	The SS transmits a MAC PDU containing two MAC SDUs, the first containing a 8 byte RLC SDU with LCID set to '00011' and the second containing a 7 byte RLC SDU with LCID set to '00101'.	<--	MAC PDU (MAC sub-header (E='1', LCID='00011', F='0', L='10'), MAC sub-header (E='0', LCID='00101'), AMD PDU, AMD PDU)	-	-
22	The UE sends Scheduling Request	-->	(SR)	-	-
23	The SS transmits an uplink grant of size 256 bits. (Note 6)	<--	(UL grant)	-	-
24	Check: Does the UE return a MAC PDU of length 256 bits including 2 RLC SDUs, Padding and Short BSR or LongBSR with Buffer size(s) set to '0'? (Note 5) (Note 7)	-->	MAC PDU (Short BSR MAC sub-header (E='1', LCID='11101', MAC sub-header (E='1', F='0'), MAC sub-header (E='1', F='0'), padding MAC sub-header (E='0', LCID='11111'), Short BSR (Buffer Size='0'), AMD PDU, AMD PDU, padding)	8	P

			Or MAC PDU (Long BSR MAC sub-header (E='1', LCID='11101', MAC sub-header (E='1', F='0'), MAC sub-header (E='1', F='0'), F='0'), padding MAC sub-header (E='0', LCID='11111'), LongBSR (Buffer Size='0'), AMD PDU, AMD PDU, padding)		
25	SS transmits an RLC STATUS PDU to acknowledge correctly received data(LCID='00011')	<--	RLC STATUS PDU (ACK_SN=1)		
26	SS transmits an RLC STATUS PDU to acknowledge correctly received data(LCID='00101')	<--	RLC STATUS PDU (ACK_SN=1)		
<p>Note 1: 32 bits enables UE to transmit a MAC PDU with a MAC BSR header and a Short BSR (1 bytes) or a Long BSR (3 byte).</p> <p>Note 2: UE triggers a Short BSR of type "Regular BSR" to report buffer status for one LCG for that TTI. The UE should not send any of the received RLC SDUs (segmented) due to Regular BSR has higher priority than U-plane logical channels.</p> <p>Note 3: UE triggers and transmit a Long BSR of type "Regular BSR". The UL grant would be enough for UE to transmit one RLC SDU as received in step 8, but Regular BSR has higher priority than U-plane logical channels.</p> <p>Note 4: The UE has 38 bytes of user data (received in steps 2, 9 and 13) in the transmission buffer. 424 bits enables UE to transmit user data in MAC PDU with 2 bytes SDU subheader for LC 3, 2 bytes SDU subheader for LC 4 and 1 byte SDU subheader for LC 5, 24 bytes MAC SDU for LC 3 (2 RLC SDUs, 10 bytes each and 4 bytes AMD PDU header), 12 bytes MAC SDU for LC 4 (1 RLC SDU, 10 bytes and 2 bytes AMD PDU header), 12 bytes MAC SDU for LC 5 (2 RLC SDUs, 4 bytes each and 4 bytes AMD PDU header) equals to 424 bits (53 bytes).</p> <p>Note 5: The MAC SDUs for the different logical channels may be in any order in the MAC PDU.</p> <p>Note 6: UL grant of 256 bits ($I_{TBS}=6$, $N_{PRB}=3$, TS 36.213 Table 7.1.7.2.1-1) is chosen to enable UE to transmit two MAC SDUs of size 10 and 9 bytes in a MAC PDU (8 bytes RLC SDU + 2 bytes AMD PDU header + 7 bytes RLC SDU+ 2 bytes AMD PDU header) + 1 byte Short BSR+6 byte padding + one byte BSR header+ 2 x 2 bytes MAC sub-header (7 bit LI) + one byte padding MAC sub-header (R/R/E/LCID) = 32bytes = 256 bits) or UL grant of 256 bits ($I_{TBS}=6$, $N_{PRB}=3$, TS 36.213 Table 7.1.7.2.1-1) is chosen to enable UE to transmit two MAC SDUs of size 10 and 9 bytes in a MAC PDU (8 bytes RLC SDU + 2 bytes AMD PDU header + 7 bytes RLC SDU+ 2 bytes AMD PDU header) + 3 byte LongBSR + 4 byte padding + one byte BSR header+ 2 x 2 bytes MAC sub-header (7 bit LI) + one byte padding MAC sub-header (R/R/E/LCID) = 32bytes = 256 bits).</p> <p>Note 7: It is left up to UE implementation whether ShortBSR or LongBSR is reported.</p>					

7.1.4.6.3.3 Specific Message Contents

Table 7.1.4.6.3.3-1: RRCConnectionReconfiguration (preamble: Table 4.5.3.3-1, step 8)

Derivation path: 36.508 table 4.8.2.1.5-1			
Information Element	Value/Remark	Comment	Condition
RRCConnectionReconfiguration ::= SEQUENCE {			
criticalExtensions CHOICE {			
c1 CHOICE{			
rrcConnectionReconfiguration-r8 SEQUENCE {			
RadioResourceConfigDedicated SEQUENCE {			
mac-MainConfig CHOICE {			
Explicit SEQUENCE {			
ul-SCH-Config SEQUENCE {			
maxHARQ-Tx	n5		
periodicBSR-Timer	Infinity		
retxBSR-Timer	sf320		
ttiBundling	FALSE		
}			
}			
}			
}			
}			
}			
}			
}			
}			
}			

7.1.4.7 Correct handling of MAC control information / Buffer Status / UL resources are allocated / Padding BSR

7.1.4.7.1 Test Purpose (TP)

(1)

```

with { UE in E-UTRA RRC_CONNECTED state }
ensure that {
  when { UE transmits a MAC PDU and the number of padding bits is equal to or larger than the size
of a Short BSR plus its subheader but smaller than the size of a Long BSR plus its subheader and the
UE has available data for transmission from more than one LCG in the TTI where the BSR is
transmitted }
  then { UE reports a Truncated BSR of the LCG with the highest priority logical channel with data
available for transmission }
}

```

(2)

```

with { UE in E-UTRA RRC_CONNECTED state }
ensure that {
  when { UE transmits a MAC PDU and the number of padding bits is equal to or larger than the size
of a Short BSR plus its subheader but smaller than the size of a Long BSR plus its subheader and the
UE has available data for transmission from only one LCG in the TTI where the BSR is transmitted }
  then { UE reports a Short BSR }
}

```

(3)

```

with { UE in E-UTRA RRC_CONNECTED state }
ensure that {
  when { UE transmits a MAC PDU and the number of padding bits is equal to or larger than the size of
a Long BSR plus its subheader }
  then { UE reports a long BSR }
}

```

7.1.4.7.2 Conformance requirements

References: The conformance requirements covered in the current TC are specified in: TS 36.321, clause 5.4.3.1, 5.4.5, 6.1.2, 6.1.3.1 and 6.2.1 and in TS 36.323, clause 4.5.

[TS 36.321 clause 5.4.3.1]

For the Logical Channel Prioritization procedure, the UE shall take into account the following relative priority in decreasing order:

- MAC control element for C-RNTI or data from UL-CCCH;
- MAC control element for BSR, with exception of BSR included for padding;
- MAC control element for PHR;
- data from any Logical Channel, except data from UL-CCCH;
- MAC control element for BSR included for padding.

[TS 36.321 clause 5.4.5]

The Buffer Status reporting procedure is used to provide the serving eNB with information about the amount of data available for transmission in the UL buffers of the UE. RRC controls BSR reporting by configuring the two timers *periodicBSR-Timer* and *retxBSR-Timer* and by, for each logical channel, optionally signalling *logicalChannelGroup* which allocates the logical channel to an LCG [8].

For the Buffer Status reporting procedure, the UE shall consider all radio bearers which are not suspended and may consider radio bearers which are suspended.

A Buffer Status Report (BSR) shall be triggered if any of the following events occur:

...

- UL resources are allocated and number of padding bits is equal to or larger than the size of the Buffer Status Report MAC control element plus its subheader, in which case the BSR is referred below to as "Padding BSR";

...

For padding BSR:

- if the number of padding bits is equal to or larger than the size of the Short BSR plus its sub header but smaller than the size of the Long BSR plus its subheader:
 - if more than one LCG has data available for transmission in the TTI where the BSR is transmitted: report Truncated BSR of the LCG with the highest priority logical channel with data available for transmission;
 - else report Short BSR.
- else if the number of padding bits is equal to or larger than the size of the Long BSR plus its sub header, report Long BSR.

If the Buffer Status reporting procedure determines that at least one BSR has been triggered and not cancelled:

- if the UE has UL resources allocated for new transmission for this TTI:
 - instruct the Multiplexing and Assembly procedure to generate a BSR MAC control element;
 - start or restart the *periodicBSR-Timer* except when the BSR is a Truncated BSR;
 - start or restart *retxBSR-Timer*.
- else if a Regular BSR has been triggered:
 - a Scheduling Request shall be triggered.

A MAC PDU shall contain at most one MAC BSR control element, even when multiple events trigger a BSR by the time a BSR can be transmitted in which case the Regular BSR and the Periodic BSR shall have precedence over the padding BSR.

The UE shall restart *retxBSR-Timer* upon indication of a grant for transmission of new data on UL-SCH.

All triggered BSRs shall be cancelled in case the UL grant can accommodate all pending data available for transmission but is not sufficient to additionally accommodate the BSR MAC control element plus its subheader. All triggered BSRs shall be cancelled when a BSR is included in a MAC PDU for transmission.

[TS 36.321 clause 6.1.2]

MAC control elements are always placed before any MAC SDU.

[TS 36.321 clause 6.1.3.1]

Buffer Status Report (BSR) MAC control elements consist of either:

- Short BSR and Truncated BSR format: one LCG ID field and one corresponding Buffer Size field (figure 6.1.3.1-1); or
- Long BSR format: four Buffer Size fields, corresponding to LCG IDs #0 through #3 (figure 6.1.3.1-2).

The BSR formats are identified by MAC PDU sub headers with LCIDs as specified in table 6.2.1-2.

The fields LCG ID and Buffer Size are defined as follow:

- LCG ID: The Logical Channel Group ID field identifies the group of logical channel(s) which buffer status is being reported. The length of the field is 2 bits;
- Buffer Size: The Buffer Size field identifies the total amount of data available across all logical channels of a logical channel group after the MAC PDU has been built. The amount of data is indicated in number of bytes. It shall include all data that is available for transmission in the RLC layer and in the PDCP layer; the definition of what data shall be considered as available for transmission is specified in [3] and [4] respectively. The size of the RLC and MAC headers are not considered in the buffer size computation. The length of this field is 6 bits. The values taken by the Buffer Size field are shown in Table 6.1.3.1-1.

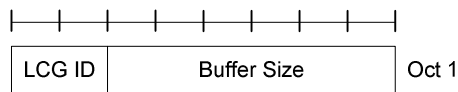

Figure 6.1.3.1-1: Short BSR and Truncated BSR MAC control element

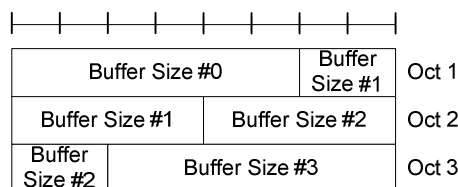

Figure 6.1.3.1-2: Long BSR MAC control element

[TS 36.321 clause 6.2.1]

Table 6.2.1-2: Values of LCID for UL-SCH

Index	LCID values
00000	CCCH
00001-01010	Identity of the logical channel
01011-11001	Reserved
11010	Power Headroom Report
11011	C-RNTI
11100	Truncated BSR
11101	Short BSR
11110	Long BSR
11111	Padding

[TS 36.323 clause 4.5]

For the purpose of MAC buffer status reporting, the UE shall consider PDCP Control PDUs, as well as the following as data available for transmission in the PDCP layer:

For SDUs for which no PDU has been submitted to lower layers:

- the SDU itself, if the SDU has not yet been processed by PDCP, or
- the PDU (control or data) if the SDU has been processed by PDCP.

7.1.4.7.3 Test description

7.1.4.7.3.1 Pre-test conditions

System Simulator:

- Cell 1
- RRC Connection Reconfiguration (preamble: Table 4.5.3.3-1, step 8) using parameters as specified in Table 7.1.4.7.3.3-1

UE:

None.

Preamble:

- The UE is in state Loopback Activated (state 4) according to [18].
- The condition SRB2-DRB(2,0) is used for step 8 in 4.5.3A.3 according to [18].
- 2 AM DRBS are configured with the parameters specified in table 7.1.4.7.1-1.

Table 7.1.4.7.1-1: Logical Channel Configuration Settings

Parameter	DRB1	DRB2
LogicalChannel-Identity	3	4
Priority	7	6
prioritizedBitRate	0kbs	0kbs
logicalChannelGroup	2 (LCG ID#2)	1 (LCG ID#1)

7.1.4.7.3.2 Test procedure sequence

Table 7.1.4.7.3.2-1: Main behaviour

St	Procedure	Message Sequence		TP	Verdict
		U - S	Message		
1	The SS ignores scheduling requests and does not allocate any uplink grant.	-	-	-	-
-	EXCEPTION: Step 2 shall be repeated for 2 times	-	-	-	-
2	The SS transmits a MAC PDU including an RLC SDU of size 12 bytes on logical channel 4.	<--	MAC PDU (RLC SDU on LC 4)	-	-
3	The SS transmits a MAC PDU including an RLC SDU of size 12 bytes on logical channel 3.	<--	MAC PDU (RLC SDU on LC 3)	-	-
4	UE transmits a Scheduling Request on PUCCH.	-->	(SR)	-	-
5	The SS sends an uplink grant of size 32 bits. (Note 1)	<--	(UL grant)	-	-
6	The UE transmit a Long BSR report	-->	MAC PDU (Long BSR header (LCID='11110'), Long BSR)	-	-
7	The SS is configured for Uplink Grant Allocation Type 3. The SS sends an uplink grant of size 136 bits. (Note 2)	<--	(UL grant)	-	-
8	Check: Does UE transmit a MAC PDU containing an RLC SDU and a Truncated BSR indicating pending data ('Buffer size' field > '0') for logicalChannelGroup 1 ('LCG ID' field set to '01')?	-->	MAC PDU (Truncated BSR header (LCID='11100'), Truncated BSR(LCG ID ='01', Buffer size>'0'), RLC SDU)	1	P
9	Void	-	-	-	-
10	The SS is configured for Uplink Grant Allocation Type 3. The SS sends an uplink grant of size 136 bits (Note 2)	<--	(UL grant)	-	-
11	Check: Does UE transmit a MAC PDU containing an RLC SDU and with a Short BSR indicating pending data ('Buffer size' field > '0') for logicalChannelGroup 2 ('LCG ID' field ='10')?	-->	MAC PDU (Short BSR header(LCID='11101'), Short BSR(LCG ID ='10', Buffer size>'0'), RLC SDU)	2	P
12	Void	-	-	-	-
13	Void	-	-	-	-
14	The SS is configured for Uplink Grant Allocation Type 3. The SS sends an uplink grant of size 152 bits. (Note 3)	<--	(UL grant)	-	-
15	Check: Does UE transmit a MAC PDU containing a RLC SDU and a Long BSR?	-->	MAC PDU (Long BSR header (LCID='11110'), Long BSR), RLC SDU)	3	P
<p>Note 1: SS transmit an UL grant of 32 bits ($I_{TBS}=0$, $N_{PRB}=2$, TS 36.213 Table 7.1.7.2.1-1) to allow UE to transmit a Regular BSR triggered by the new data received logicalChannelGroup 1 and 2 in steps 2 and 3. This to enable testing of Padding BSR which has lower priority than Regular BSR.</p> <p>Note 2: UL grant of 136 bits ($I_{TBS}=9$, $N_{PRB}=1$, TS 36.213 Table 7.1.7.2.1-1) is chosen such that the MAC PDU padding bits will be equal to or larger than the size of Short/Truncated BSR and smaller than Long BSR. RLC SDU size is 12 bytes, size of AMD PDU header is 2 bytes, size of MAC header is 2 bytes (1 byte for MAC SDU sub-header using R/R/E/LCID for last sub header and 1 byte for BSR sub-header) and size of Short BSR/Truncated BSR is one byte, i.e. setting UL grant to 17 bytes (136 bits) enable UE to include Short/Truncated BSR.</p> <p>Note 3: UL grant of 152 bits ($I_{TBS}=0$, $N_{PRB}=6$, TS 36.213 Table 7.1.7.2.1-1) is chosen such that the MAC PDU padding bits will be equal to or larger than the size of Long BSR. RLC SDU size is 12 bytes, size of AMD PDU header is 2 bytes, size of MAC header is 2 bytes (1 byte for MAC SDU sub-header using R/R/E/LCID for last sub header and 1 byte for BSR sub-header) and size of Long BSR is 3 bytes, i.e. setting UL grant to 19 bytes (152 bits) enable UE to include padding Long BSR.</p>					

7.1.4.7.3.3 Specific Message Contents

None

7.1.4.7a Correct handling of MAC control information / Buffer Status / UL resources are allocated / Cancellation of Padding BSR

7.1.4.7a.1 Test Purpose (TP)

(1)

```
with { UE in E-UTRA RRC_CONNECTED state }
ensure that {
  when { UE has transmitted a MAC PDU with a Regular BSR and padding such that a padding BSR is
  triggered AND UE has remaining data causing continuous data transmission while periodicBSR-Timer is
  running without causing any Regular BSR or padding BSR to be triggered }
  then { UE reports a Periodic BSR }
}
```

7.1.4.7a.2 Conformance requirements

References: The conformance requirements covered in the current TC are specified in: TS 36.321, clause 5.4.3.1, 5.4.5, 6.1.2, 6.1.3.1 and 6.2.1 and in TS 36.323, clause 4.5.

[TS 36.321 clause 5.4.3.1]

For the Logical Channel Prioritization procedure, the UE shall take into account the following relative priority in decreasing order:

- MAC control element for C-RNTI or data from UL-CCCH;
- MAC control element for BSR, with exception of BSR included for padding;
- MAC control element for PHR;
- data from any Logical Channel, except data from UL-CCCH;
- MAC control element for BSR included for padding.

[TS 36.321 clause 5.4.5]

The Buffer Status reporting procedure is used to provide the serving eNB with information about the amount of data available for transmission in the UL buffers of the UE. RRC controls BSR reporting by configuring the two timers *periodicBSR-Timer* and *retxBSR-Timer* and by, for each logical channel, optionally signalling *logicalChannelGroup* which allocates the logical channel to an LCG [8].

For the Buffer Status reporting procedure, the UE shall consider all radio bearers which are not suspended and may consider radio bearers which are suspended.

A Buffer Status Report (BSR) shall be triggered if any of the following events occur:

- UL data, for a logical channel which belongs to a LCG, becomes available for transmission in the RLC entity or in the PDCP entity (the definition of what data shall be considered as available for transmission is specified in [3] and [4] respectively) and either the data belongs to a logical channel with higher priority than the priorities of the logical channels which belong to any LCG and for which data is already available for transmission, or there is no data available for transmission for any of the logical channels which belong to a LCG, in which case the BSR is referred below to as "Regular BSR";
- UL resources are allocated and number of padding bits is equal to or larger than the size of the Buffer Status Report MAC control element plus its subheader, in which case the BSR is referred below to as "Padding BSR";
- *retxBSR-Timer* expires and the UE has data available for transmission for any of the logical channels which belong to a LCG, in which case the BSR is referred below to as "Regular BSR";
- *periodicBSR-Timer* expires, in which case the BSR is referred below to as "Periodic BSR".

For Regular and Periodic BSR:

- if more than one LCG has data available for transmission in the TTI where the BSR is transmitted: report Long BSR;

- else report Short BSR.

For padding BSR:

- if the number of padding bits is equal to or larger than the size of the Short BSR plus its sub header but smaller than the size of the Long BSR plus its subheader:
 - if more than one LCG has data available for transmission in the TTI where the BSR is transmitted: report Truncated BSR of the LCG with the highest priority logical channel with data available for transmission;
 - else report Short BSR.
- else if the number of padding bits is equal to or larger than the size of the Long BSR plus its sub header, report Long BSR.

If the Buffer Status reporting procedure determines that at least one BSR has been triggered and not cancelled:

- if the UE has UL resources allocated for new transmission for this TTI:
 - instruct the Multiplexing and Assembly procedure to generate a BSR MAC control element;
 - start or restart the *periodicBSR-Timer* except when the BSR is a Truncated BSR;
 - start or restart *retxBSR-Timer*.
- else if a Regular BSR has been triggered:
 - a Scheduling Request shall be triggered.

A MAC PDU shall contain at most one MAC BSR control element, even when multiple events trigger a BSR by the time a BSR can be transmitted in which case the Regular BSR and the Periodic BSR shall have precedence over the padding BSR.

The UE shall restart *retxBSR-Timer* upon indication of a grant for transmission of new data on UL-SCH.

All triggered BSRs shall be cancelled in case the UL grant can accommodate all pending data available for transmission but is not sufficient to additionally accommodate the BSR MAC control element plus its subheader. All triggered BSRs shall be cancelled when a BSR is included in a MAC PDU for transmission.

[TS 36.321 clause 6.1.2]

MAC control elements are always placed before any MAC SDU.

[TS 36.321 clause 6.1.3.1]

Buffer Status Report (BSR) MAC control elements consist of either:

- Short BSR and Truncated BSR format: one LCG ID field and one corresponding Buffer Size field (figure 6.1.3.1-1); or
- Long BSR format: four Buffer Size fields, corresponding to LCG IDs #0 through #3 (figure 6.1.3.1-2).

The BSR formats are identified by MAC PDU sub headers with LCIDs as specified in table 6.2.1.-2.

The fields LCG ID and Buffer Size are defined as follow:

- LCG ID: The Logical Channel Group ID field identifies the group of logical channel(s) which buffer status is being reported. The length of the field is 2 bits;
- Buffer Size: The Buffer Size field identifies the total amount of data available across all logical channels of a logical channel group after the MAC PDU has been built. The amount of data is indicated in number of bytes. It shall include all data that is available for transmission in the RLC layer and in the PDCP layer; the definition of what data shall be considered as available for transmission is specified in [3] and [4] respectively. The size of the RLC and MAC headers are not considered in the buffer size computation. The length of this field is 6 bits. The values taken by the Buffer Size field are shown in Table 6.1.3.1-1.

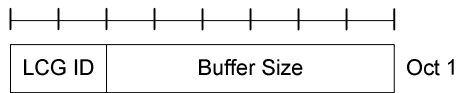

Figure 6.1.3.1-1: Short BSR and Truncated BSR MAC control element

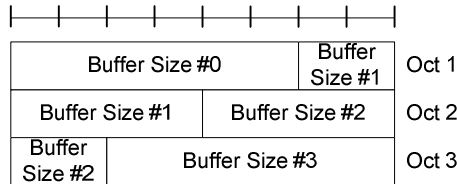

Figure 6.1.3.1-2: Long BSR MAC control element

[TS 36.321 clause 6.2.1]

Table 6.2.1-2: Values of LCID for UL-SCH

Index	LCID values
00000	CCCH
00001-01010	Identity of the logical channel
01011-11001	Reserved
11010	Power Headroom Report
11011	C-RNTI
11100	Truncated BSR
11101	Short BSR
11110	Long BSR
11111	Padding

[TS 36.323 clause 4.5]

For the purpose of MAC buffer status reporting, the UE shall consider PDCP Control PDUs, as well as the following as data available for transmission in the PDCP layer:

For SDUs for which no PDU has been submitted to lower layers:

- the SDU itself, if the SDU has not yet been processed by PDCP, or
- the PDU (control or data) if the SDU has been processed by PDCP.

7.1.4.7a.3 Test description

7.1.4.7a.3.1 Pre-test conditions

System Simulator:

- Cell 1
- RRC Connection Reconfiguration (preamble: Table 4.5.3.3-1, step 8) using parameters as specified in Tables 7.1.4.7a.3.3-1-3.

UE:

None.

Preamble:

- The UE is in state Loopback Activated (state 4) according to [18].
- The condition SRB2-DRB(3,0) is used for step 8 in 4.5.3A.3 according to [18].
- 3 AM DRBS are configured with the parameters specified in table 7.1.4.7a.1-1.

Table 7.1.4.7a.1-1: Logical Channel Configuration Settings

Parameter	Value DRB1	Value DRB2	Value DRB3
LogicalChannel-Identity	3	4	5
Priority	8	7	6
prioritizedBitRate	0 kB/s	0 kB/s	0 kB/s
logicalChannelGroup	2 (LCG ID#2)	1 (LCG ID#1)	1 (LCG ID#1)

7.1.4.7a.3.2 Test procedure sequence

Table 7.1.4.7a.3.2-1: Main behaviour

St	Procedure	Message Sequence		TP	Verdict
		U - S	Message		
1	The SS ignores scheduling requests and does not allocate any uplink grant.	-	-	-	-
2	The SS transmits a MAC PDU including an RLC SDU of size 11 bytes on logical channel 5.	<--	MAC PDU (RLC SDU on LC 5)	-	-
-	EXCEPTION: Step 3 shall be repeated 4 times	-	-	-	-
3	The SS transmits a MAC PDU including an RLC SDU of size 10 bytes on logical channel 4.	<--	MAC PDU (RLC SDU on LC 4)	-	-
-	EXCEPTION: Step 4 shall be repeated 5 times	-	-	-	-
4	The SS transmits a MAC PDU including an RLC SDU of size 10 bytes on logical channel 3.	<--	MAC PDU (RLC SDU on LC 3)	-	-
5	Void	-	-	-	-
6	60 ms after step 4, the SS sends an uplink grant of size 176 bits. (Note 1)	<--	(UL grant)	-	-
7	The UE transmits a longBSR triggered by a Regular BSR report	-->	MAC PDU (Long BSR header (LCID='11110'), MAC SDU header, Long BSR, RLC SDU, padding)	-	-
8	20 ms after step 4, the SS sends an uplink grant of 104 bits for every 5 th uplink TTI 10 times. (Note 2)	-	-	-	-
-	EXCEPTION: In parallel with step 9, the parallel behaviour in table 7.1.4.7a.3.2-2 is running until the periodic BSR is received in step 9.	-	-	-	-
9	Check: Does UE transmit a MAC PDU containing a periodic BSR? (Note 3 and Note 4)	-->	MAC PDU (Long BSR header, MAC SDU header, Long BSR RLC SDU segment) or MAC PDU (Short BSR header, MAC SDU header, Short BSR RLC SDU segment)	1	P
-	EXCEPTION: In parallel with step 10, the parallel behaviour in table 7.1.4.7a.3.2-3 is running. Step 10 shall occur at least once. (Note 4)	-	-	-	-
10	CHECK: Does UE transmit a MAC PDU containing a MAC SDU	-->	MAC PDU (RLC SDU segments)	1	P
Note 1:	UL grant of 176 bits ($I_{TBS}=3$, $N_{PRB}=3$, TS 36.213 Table 7.1.7.2.1-1) is chosen such that the MAC PDU padding bits (padding header + padding payload) will be equal to or larger to trigger a padding BSR (Short BSR), i.e. 2 bytes or more (one byte for BSR sub-header and 1 bytes for a Short BSR). RLC SDU size is 11 bytes, size of AMD PDU header is 2 bytes, size of MAC header is 4 bytes (1 byte for BSR sub header, 2 byte for MAC SDU sub-header using R/R/E/LCID/F/L and 1 byte for R/R/E padding sub header) and size of Long BSR (Regular BSR) is 3 bytes and padding is 2 bytes, i.e. setting UL grant to 22 bytes (176 bits). The remaining 3 bytes would have enabled the UE to segment a second RLC SDU if the RLC SDU belongs to the same logical channel. However, as there is only one RLC SDU available for transmission for LC5 (highest priority) then would the UE have to add a second MAC SDU to transmit a segment of an additional RLC SDU from LC4. This would require 4 bytes or more and the UE will instead add 3 bytes of padding, which will trigger a padding BSR.				
Note 2:	UL grant of 104 bits ($I_{TBS}=3$, $N_{PRB}=2$, TS 36.213 Table 7.1.7.2.1-1) is chosen such that UE is able to transmit a MAC PDU that fits exactly a PDCP SDU to enable periodic BSR to be triggered when periodicBSR-Timer expires. RLC SDU size is 10 bytes, size of AMD PDU header is 2 bytes and size of MAC header is 1 byte (1 byte for MAC SDU sub-header using R/R/E/LCID for last sub header), i.e. setting UL grant to 13 bytes (104 bits). The UL grant is sent by the SS 10 times (every 5 th TTI) to enable UE to transmit the remaining 9 RLC SDUs and at least one periodic BSR,				
Note 3:	The Periodic BSR is triggered by the expiry of the periodicBSR-Timer (32 sub-frames, see Table 7.1.4.7a.3.3-1) and verifies that the triggered padding BSR in step 7 in Table 7.1.4.7a.3.2-1 is cancelled by the UE. If the UE would not have cancelled the triggered padding BSR then would the UE reset the periodicBSR-Timer after each transmission causing the timer to not expire.				
Note 4:	If UE has cancelled the triggered padding BSR in step 7 in Table 7.1.4.7a.3.2-1 then the <i>periodicBSR</i> -				

Timer will expire before all data in the transmission buffer has been sent by the UE. This verifies that the received BSR report in step 9 is triggered by a periodic BSR report and not due to a regular or padding BSR.

Table 7.1.4.7a.3.2-2: Parallel behaviour

St	Procedure	Message Sequence		TP	Verdict
		U - S	Message		
1	UE transmits a MAC PDU containing an RLC SDU	-->	MAC PDU (RLC SDU)	-	-

Table 7.1.4.7a.3.2-3: Parallel behaviour

St	Procedure	Message Sequence		TP	Verdict
		U - S	Message		
1	UE transmits a MAC PDU containing an RLC SDU	-->	MAC PDU (<i>Long BSR header, ,MAC SDU header, Long BSR RLC SDU segment</i>) or MAC PDU (<i>Short BSR header, ,MAC SDU header, Short BSR RLC SDU segment</i>)	-	-

7.1.4.7a.3.3 Specific Message Contents

Table 7.1.4.7a.3.3-1: RRCConnectionReconfiguration (preamble: Table 4.5.3.3-1, step 8)

Derivation path: 36.508 table 4.8.2.1.5-1			
Information Element	Value/Remark	Comment	Condition
RRCConnectionReconfiguration ::= SEQUENCE {			
criticalExtensions CHOICE {			
c1 CHOICE{			
rrcConnectionReconfiguration-r8 SEQUENCE {			
RadioResourceConfigDedicated SEQUENCE {			
mac-MainConfig CHOICE {			
Explicit SEQUENCE {			
ul-SCH-Config SEQUENCE {			
maxHARQ-Tx	n5		
periodicBSR-Timer	Sf32	32 subframes	
retxBSR-Timer	sf320		
ttiBundling	FALSE		
}			
}			
}			
}			
}			
}			

Table 7.1.4.7a.3.3-2: SchedulingRequest-Configuration (preamble: Table 4.5.3.3-1, step 8)

Derivation Path: 36.508 clause 4.6.3-20			
Information Element	Value/remark	Comment	Condition
SchedulingRequest-Configuration ::= CHOICE {			
setup SEQUENCE {			
dsr-TransMax	n64	Max value allowed	
}			
}			

Table 7.1.4.7a.3.3-3: RLC-Config-DRB-AM (preamble: Table 4.5.3.3-1, step 8)

Derivation path: 36.508 clause 4.8.2.1.3.2, Table 4.8.2.1.3.2-1			
Information Element	Value/Remark	Comment	Condition
RLC-Config-DRB-AM ::= CHOICE {			
am SEQUENCE {			
ul-AM-RLC SEQUENCE {			
t-PollRetransmit	ms500		
}			
}			
}			

7.1.4.8 Correct handling of MAC control information / Buffer status / Periodic BSR timer expires

7.1.4.8.1 Test Purpose (TP)

(1)

```
with { UE in E-UTRA RRC_CONNECTED state }
ensure that {
  when { periodicBSR-Timer expires and more than one LCG has buffered data in a TTI }
  then { UE triggers a Periodic BSR and reports Long BSR }
}
```

(2)

```
with { UE in E-UTRA RRC_CONNECTED state }
ensure that {
  when { periodicBSR-Timer expires and one LCG has buffered data in a TTI }
  then { UE triggers a Periodic BSR and reports Short BSR and restarts the periodicBSR-Timer }
}
```

7.1.4.8.2 Conformance requirements

References: The conformance requirements covered in the current TC are specified in: TS 36.321, clause 5.4.5, 6.1.2, 6.1.3.1 and 6.2.1; TS 36.323 clause 4.5.

[TS 36.321 clause 5.4.5]

The Buffer Status reporting procedure is used to provide the serving eNB with information about the amount of data available for transmission in the UL buffers of the UE. RRC controls BSR reporting by configuring the two timers *periodicBSR-Timer* and *retxBSR-Timer* and by, for each logical channel, optionally signalling *logicalChannelGroup* which allocates the logical channel to an LCG [8].

For the Buffer Status reporting procedure, the UE shall consider all radio bearers which are not suspended and may consider radio bearers which are suspended.

A Buffer Status Report (BSR) shall be triggered if any of the following events occur:

...

- *periodicBSR-Timer* expires, in which case the BSR is referred below to as "Periodic BSR".

For Regular and Periodic BSR:

- if more than one LCG has data available for transmission in the TTI where the BSR is transmitted: report Long BSR;
- else report Short BSR.

...

If the Buffer Status reporting procedure determines that at least one BSR has been triggered and not cancelled:

- if the UE has UL resources allocated for new transmission for this TTI:
 - instruct the Multiplexing and Assembly procedure to generate a BSR MAC control element;
 - start or restart the *periodicBSR-Timer* except when the BSR is a Truncated BSR;
 - start or restart *retxBSR-Timer*.

A MAC PDU shall contain at most one MAC BSR control element, even when multiple events trigger a BSR by the time a BSR can be transmitted in which case the Regular BSR and the Periodic BSR shall have precedence over the padding BSR.

The UE shall restart *retxBSR-Timer* upon indication of a grant for transmission of new data on UL-SCH.

All triggered BSRs shall be cancelled in case the UL grant can accommodate all pending data available for transmission but is not sufficient to additionally accommodate the BSR MAC control element plus its subheader. All triggered BSRs shall be cancelled when a BSR is included in a MAC PDU for transmission.

[TS 36.321 clause 6.1.2]

MAC control elements are always placed before any MAC SDU.

[TS 36.321 clause 6.1.3.1]

Buffer Status Report (BSR) MAC control elements consist of either:

- Short BSR and Truncated BSR format: one LCG ID field and one corresponding Buffer Size field (figure 6.1.3.1-1); or
- Long BSR format: four Buffer Size fields, corresponding to LCG IDs #0 through #3 (figure 6.1.3.1-2).

The BSR formats are identified by MAC PDU sub headers with LCIDs as specified in table 6.2.1.-2.

The fields LCG ID and Buffer Size are defined as follow:

- LCG ID: The Logical Channel Group ID field identifies the group of logical channel(s) which buffer status is being reported. The length of the field is 2 bits;
- Buffer Size: The Buffer Size field identifies the total amount of data available across all logical channels of a logical channel group after the MAC PDU has been built. The amount of data is indicated in number of bytes. It shall include all data that is available for transmission in the RLC layer and in the PDCP layer; the definition of what data shall be considered as available for transmission is specified in [3] and [4] respectively. The size of the RLC and MAC headers are not considered in the buffer size computation. The length of this field is 6 bits. The values taken by the Buffer Size field are shown in Table 6.1.3.1-1.

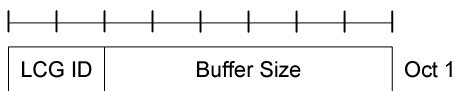

Figure 6.1.3.1-1: Short BSR and Truncated BSR MAC control element

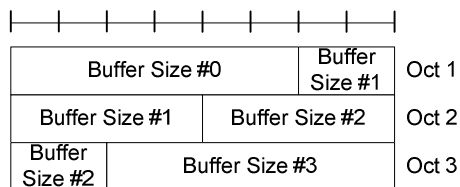

Figure 6.1.3.1-2: Long BSR MAC control element

[TS 36.321 clause 6.2.1]

Table: 6.2.1-2 Values of LCID for UL-SCH

Index	LCID values
00000	CCCH
00001-01010	Identity of the logical channel
01011-11001	Reserved
11010	Power Headroom Report
11011	C-RNTI
11100	Truncated BSR
11101	Short BSR
11110	Long BSR
11111	Padding

[TS 36.323 clause 4.5]

For the purpose of MAC buffer status reporting, the UE shall consider PDCP Control PDUs, as well as the following as data available for transmission :

For SDUs for which no PDU has been submitted to lower layers:

- the SDU itself, if the SDU has not yet been processed by PDCP, or
- the PDU if the SDU has been processed by PDCP.

7.1.4.8.3 Test description

7.1.4.8.3.1 Pre-test conditions

System Simulator:

- Cell 1
- RRC Connection Reconfiguration (preamble: Table 4.5.3.3-1, step 8) using parameters as specified in Table 7.1.4.8.3.3-1

UE:

None.

Preamble;

- The UE is in state Loopback Activated (state 4) according to [18].
- The condition SRB2-DRB(2,0) is used for step 8 in 4.5.3A.3 according to [18].
- 2 AM DRBS are configured with the parameters specified in table 7.1.4.8.1-1.

Table 7.1.4.8.1-1: Logical Channel Configuration Settings

Parameter	DRB1	DRB2
LogicalChannel-Identity	3	4
priority	7	6
prioritizedBitRate	0kbs	0kbs
logicalChannelGroup	2	1

7.1.4.8.3.2 Test procedure sequence

Table 7.1.4.8.3.2-1: Main behaviour

St	Procedure	Message Sequence		TP	Verdict
		U – S	Message		
1	The SS ignores scheduling requests and does not allocate any uplink grant.	-	-	-	-
2	The SS transmits a MAC PDU containing an RLC PDU on logical channel 4 (LCG ID 1), which contains 1 RLC SDU of size 14 bytes.	<--	MAC PDU (RLC PDU)		
3	The SS is configured for Uplink Grant Allocation Type 2. The SS sends an uplink grant of size 32 bits. (Note 2)	<--	(UL grant)	-	-
4	The UE transmits a short BSR report. (Note 6)	-->	MAC PDU ((LCID='11101', LCG ID='01', Buffer size index > 0)	-	-
-	EXCEPTION: Steps 5 to 6 shall be repeated two times (Note 4)	-	-	-	-
5	Wait for periodicBSR-Timer expiry.	-	-	-	-
5A	The SS sends an uplink grant of size 32 bits	-	-	-	-
6	Check: Does UE transmit a MAC PDU containing a Short BSR with 'LCG ID' field set to '01' (logicalChannelGroup 1) and Buffer Size Index > 0?	-->	MAC PDU (LCID='11101', LCG ID='01', Buffer Size index > 0)	2	P
7	Void				
8	The SS transmits a MAC PDU containing an RLC PDU on logical channel 3 (LCG ID 2), which contains 1 RLC SDU of size 14 bytes.	<--	MAC PDU (RLC PDU)	-	-
8A	The SS sends an uplink grant of size 32 bits (Note 3)	<--	(UL grant)	-	-
8B	The UE transmits a long BSR report with 'Buffer size#1' (LCG ID=1) and 'Buffer size#2' (LCG ID=2) fields set to value > '0'	-->	MAC PDU (('Buffer size#1 index' > 0, 'Buffer size#2 index=' > 0')	-	-
9	Void				
-	EXCEPTION: Step 9A to 10 shall be repeated twice. (Note 5)	-	-	-	-
10	Check: Does UE transmit a MAC PDU containing a Long BSR with 'Buffer size#1' (LCG ID=1) and 'Buffer size#2' (LCG ID=2) fields set to value > '0'?	-->	MAC PDU	1	P
10 A	The SS is configured for Uplink Grant Allocation Type 3. The SS transmits 1 UL grant of size 328 bits to enable the UE to loopback RLC SDU on LCG ID = 1 and LCG = 2. (Note 7)			-	-
11	The UE transmits MAC PDU containing the remaining RLC SDUs as sent by the SS in steps 2 and 8.	-->	MAC PDU	-	-
<p>Note 1: Void</p> <p>Note 2: SS transmits an UL grant of 32 bits ($I_{TBS}=0$, $N_{PRB}=2$, TS 36.213 Table 7.1.7.2.1-1) to allow UE to transmit a Regular BSR triggered by the new data received logicalChannelGroup 1 in step 2.</p> <p>Note 3: SS transmits an UL grant of 32 bits ($I_{TBS}=0$, $N_{PRB}=2$, TS 36.213 Table 7.1.7.2.1-1) to allow UE to transmit a Regular BSR triggered by the new data received logicalChannelGroup 2 in step 8.</p> <p>Note 4: One short BSR due to first expiry of <i>periodicBSR-Timer</i> and one short BSR due to second expiry of <i>periodicBSR-Timer</i>.</p> <p>Note 5: One long BSR due to expiry of <i>periodicBSR-Timer</i> and one long BSR due to second expiry of <i>periodicBSR-Timer</i>.</p> <p>Note 6: The UE starts <i>periodicBSR-Timer</i>.</p> <p>Note 7: SS transmits an UL grant of 328 bits ($I_{TBS}=7$, $N_{PRB}=3$, TS 36.213 Table 7.1.7.2.1-1) to allow UE to transmit RLC SDU on LCG =1 (14 bytes) and LCG = 2 (14 bytes) and a minimum MAC header of 3 bytes.</p>					

7.1.4.8.3.3 Specific Message Contents

Table 7.1.4.8.3.3-1: *RRCConnectionReconfiguration* (preamble: Table 4.5.3.3-1, step 8)

Derivation path: 36.508 table 4.8.2.1.5-1			
Information Element	Value/Remark	Comment	Condition
RRCConnectionReconfiguration ::= SEQUENCE {			
criticalExtensions CHOICE {			
c1 CHOICE{			
rrcConnectionReconfiguration-r8 SEQUENCE {			
RadioResourceConfigDedicated SEQUENCE {			
mac-MainConfig CHOICE {			
explicit SEQUENCE {			
ul-SCH-Config SEQUENCE {			
maxHARQ-Tx	n5		
periodicBSR-Timer	sf10		
retxBSR-Timer	sf10240		
ttiBundling	FALSE		
}			
}			
}			
}			
}			
}			
}			
}			
}			
}			

7.1.4.9 Void

7.1.4.10 MAC padding

7.1.4.10.1 Test Purpose (TP)

(1)

```
with { UE in E-UTRA RRC_CONNECTED state }
ensure that {
  when { UE is to transmit a MAC PDU with padding exceeding 2 bytes }
  then { Padding goes to the end of the MAC PDU }
}
```

(2)

```
with { UE in E-UTRA RRC_CONNECTED state }
ensure that {
  when { UE is to transmit a MAC PDU with single-byte padding and there is a data MAC PDU sub-header present }
  then { UE is inserting padding MAC PDU subheader before any other MAC PDU sub-header }
}
```

(3)

```
with { UE in E-UTRA RRC_CONNECTED state }
ensure that {
  when { UE is to transmit a MAC PDU with two-byte padding and there is a data MAC PDU sub-header }
  then { UE is inserting two padding MAC PDU subheaders before any other MAC PDU sub-header or one padding MAC PDU subheader as a last MAC PDU subheader }
}
```

(4)

```
with { UE in E-UTRA RRC_CONNECTED state }
ensure that {
  when { UE is to transmit a MAC PDU with single-byte padding and there is no data MAC PDU sub-header but a MAC Control element is present }
  then { UE is inserting a padding MAC PDU subheader before any other MAC PDU sub-header }
}
```

(5)

```

with { UE in E-UTRA RRC_CONNECTED state }
ensure that {
  when { UE is to transmit a MAC PDU with two-byte padding and there is no data MAC PDU sub-header
but a MAC Control element is present}
  then { UE is inserting two padding MAC PDU subheaders before any other MAC PDU sub-header or one
padding MAC PDU subheader as a last MAC PDU subheader and one byte padding at the end of the MAC PDU
}
}
    
```

7.1.4.10.2 Conformance requirements

References: The conformance requirements covered in the current TC are specified in TS 36.321, clause 6.1.2.

[TS 36.321 clause 6.1.2]

Padding occurs at the end of the MAC PDU, except when single-byte or two-byte padding is required. Padding may have any value and the UE shall ignore it. When padding is performed at the end of the MAC PDU, zero or more padding bytes are allowed.

When single-byte or two-byte padding is required, one or two MAC PDU subheaders corresponding to padding are placed at the beginning of the MAC PDU before any other MAC PDU subheader.

A maximum of one MAC PDU can be transmitted per TB per UE.

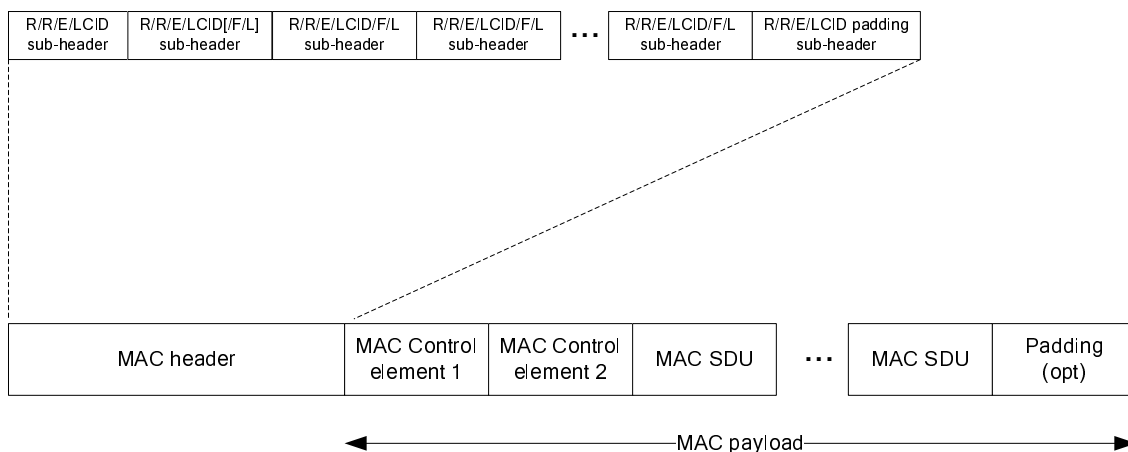

Figure 6.1.2-3: Example of MAC PDU consisting of MAC header, MAC control elements, MAC SDUs and padding

7.1.4.10.3 Test description

7.1.4.10.3.1 Pre-test conditions

System Simulator:

- Cell 1

UE:

None.

Preamble:

- The UE is in state Loopback Activated (state 4) according to [18].

7.1.4.10.3.2 Test procedure sequence

Table 7.1.4.10.3.3.2-1: Main behaviour

St	Procedure	Message Sequence		TP	Verdict
		U - S	Message		
1	The SS ignores scheduling requests and does not allocate any uplink grant.	-	-	-	-
2	The SS transmits a MAC PDU with 10 bytes MAC SDU.	<--	MAC PDU(AMD PDU)	-	-
3	The UE transmits a Scheduling Request on PUCCH.	-	(SR)	-	-
4	The SS transmits an uplink grant of size 176 bits. (Note 1)	<--	(UL grant)	-	-
5	Check: Does the UE transmit a MAC PDU with a MAC SDU of length 10 bytes and where the last MAC sub-header has the Extension field 'E' set to '0' and the Logical Channel ID field 'LCID' set to '11111'?	-->	MAC PDU (BSR sub-header, MAC SDU sub-header, Padding MAC sub-header (E='0', LCID='11111'), Short BSR, MAC SDU, padding)	1	P
6	The SS transmits a MAC PDU with 13 bytes MAC SDU.	<--	MAC PDU(AMD PDU)	-	-
7	The UE transmits a Scheduling Request on PUCCH.	-	(SR)	-	-
8	The SS transmits an uplink grant of size 120 bits. (Note 2)	<--	(UL grant)	-	-
9	Check: Does the UE transmit a MAC PDU with a MAC SDU of length 13 bytes and with a padding MAC sub-header, with Extension field 'E' is set to '1' and the Logical Channel ID field 'LCID' is set to '11111', inserted before the MAC SDU sub-header?	-->	MAC PDU (Padding MAC-sub-header (E='1', LCID='11111'), MAC SDU sub-header, MAC SDU)	2	P
10	The SS transmits a MAC PDU with 10 bytes MAC SDU.	<--	MAC PDU (AMD PDU)	-	-
11	The UE transmits a Scheduling Request on PUCCH.	-	(SR)	-	-
12	The SS transmits an uplink grant of size 120 bits. (Note 3)	<--	(UL grant)	-	-
13	Check: Does the UE transmit a MAC PDU with two padding MAC sub-headers, with Extension field 'E' is set to '1' and the Logical Channel ID field 'LCID' is set to '11111', inserted before the BSR sub-header and the MAC SDU sub-header Or a MAC PDU with BSR sub-header with Extension field 'E' is set to '1' and MAC SDU sub-header (R/R/E/LCID/F/L) inserted before the Padding MAC sub-header?	-->	MAC PDU (Padding MAC-sub-header#1 (E='1', LCID='11111'), Padding MAC-sub-header#2 (E='1', LCID='11111'), BSR sub-header, MAC SDU sub-header, Short BSR, MAC-SDU) Or MAC PDU(BSR sub-header, MAC SDU sub-header, Padding MAC-sub-header(E='0', LCID='11111'), Short BSR, MAC-SDU)	3	P
14	The SS transmits a Timing Advance command and does not send any subsequent timing alignments. Start Timer_T1 = Time Alignment timer value on SS.	<--	MAC PDU (Timing Advance Command)	-	-
15	40 to 50 TTI before Timer_T1 expires the SS transmits a MAC PDU containing an RLC AMD PDU.	<--	MAC PDU (AMD PDU)	-	-
16	The SS ignores scheduling requests and waits until the UE transmits a preamble on PRACH.	-->	(PRACH preamble)	-	-
17	The SS transmits a Random Access Response, with an UL Grant of 56-bits. (Note 4)	<--	Random Access Response	-	-
18	Check: Does the UE transmit a MAC PDU with a BSR sub-header (8-bits), a Control sub-header (8-bits) , a short BSR (8-bits) and a C-RNTI MAC Control Element (16-bits) ? (Note 6)	-->	MAC PDU (BSR sub-header, MAC Control sub-header, Padding MAC sub-header (E='0', LCID='11111'), Short BSR, C-RNTI control element, padding) Or MAC PDU (Padding MAC-sub-header#1	-	-

			(E='1', LCID='11111'), Padding MAC-sub-header#2 (E='1', LCID='11111'), BSR sub-header, MAC Control sub-header, Short BSR, C-RNTI control element)		
19	The SS transmits an UL grant of 24 bits. (Note 5)	<--	(UL grant)	-	-
19 A	Check: Does the UE transmit a MAC PDU with a padding MAC sub header with Extension field 'E' is set to '1' and 'LCID' field set to '11111' (8-bits) inserted before a BSR sub-header (8bits) and a short BSR (8 bits)?	-->	MAC PDU (Padding MAC-sub-header (E='1', LCID='11111'), BSR sub-header, Short BSR)	4	P
20	The SS transmits an uplink grant enabling UE to transmit loop back PDU.	<--	(UL grant)	-	-
21	The UE transmits Loop back PDU.	-->	MAC PDU(AMD PDU)	-	-
Note 1:	UL grant of 176 bits ($I_{TBS}=3$, $N_{PRB}=3$, see TS 36.213 Table 7.1.7.2.1-1) is chosen such that the MAC PDU padding will be larger than 2 bytes. RLC SDU size is 8 bytes, size of AMD PDU header is 2 bytes, size of MAC header is 4 bytes (2 bytes for MAC SDU sub-header using 7-bit LI, 1 byte for BSR sub-header and 1 byte for padding MAC sub-header) and size of Short BSR is 1 byte, equals to 120 bits (15 bytes) and resulting into 56 bits padding.				
Note 2:	UL grant of 120 bits ($I_{TBS}=0$, $N_{PRB}=5$, see TS 36.213 Table 7.1.7.2.1-1) is chosen such that the MAC PDU padding will be a single byte. RLC SDU size is 11 bytes, size of AMD PDU header is 2 bytes and size of MAC header is 1 byte for MAC SDU sub-header, equals to 112 bits (14 bytes) and resulting into 1 single byte padding.				
Note 3:	UL grant of 120 bits ($I_{TBS}=0$, $N_{PRB}=5$, see TS 36.213 Table 7.1.7.2.1-1) is chosen such that the MAC PDU padding will be equal to 2 bytes. RLC SDU size is 8 bytes, size of AMD PDU header is 2 bytes, size of MAC header is 4 bytes (1 bytes for MAC SDU sub-header, 1 byte for Short BSR sub-header and 2 bytes for padding MAC sub-header) and size of Short BSR is 1 byte, equals to 120 bits (15 bytes) and resulting no padding at the end of the MAC PDU.				
Note 4:	UL grant of 56 bits ($I_{TBS}=0$, $N_{PRB}=3$, see TS 36.213 Table 7.1.7.2.1-1) is as 36.321 clause 5.1.4 states that the eNB should not provide a grant smaller than 56 bits in the Random Access Response.				
Note 5:	UL grant of 24 bits ($I_{TBS}=1$, $N_{PRB}=1$, see TS 36.213 Table 7.1.7.2.1-1) is chosen such that the MAC PDU padding will be equal to a single byte.				
Note 6:	The order of short BSR and C-RNTI control element is not restricted, i.e. the short BSR can be placed before the C-RNTI control element and vice versa. The same applies for the related sub-headers.				

7.1.4.10.3.3 Specific Message Contents

None.

7.1.4.11 Correct HARQ process handling

7.1.4.11.1 Test Purpose (TP)

(1)

```
with { UE in E-UTRA RRC_CONNECTED state with DRB established }
ensure that {
  when { UE receives an UL Grant with toggled NDI and has data available for transmission }
  then { UE transmits a new MAC PDU using redundancy version 0 }
}
```

(2)

```
with { UE in E-UTRA RRC_CONNECTED state with DRB established and having transmitted a MAC PDU less
than maxHARQ-Tx times }
ensure that {
  when { UE receives a NACK and no uplink grant is included for the next TTI corresponding to the
HARQ process }
  then { UE performs non-adaptive retransmission of the MAC PDU with redundancy version toggled by
one of the last (re)transmission [0,2,3,1 order] }
}
```

(3)

```

with { UE in E-UTRA RRC_CONNECTED state with DRB established and having transmitted a MAC PDU less
than maxHARQ-Tx times }
ensure that {
  when { UE receives an uplink grant on PDCCH for the next TTI corresponding to the HARQ process
with old NDI [not toggled], irrespective of ACK/NACK is received for previous (re)transmission }
  then { UE performs an adaptive retransmission of the MAC PDU with redundancy version as received
on PDCCH }
}

```

(4)

```

with { UE in E-UTRA RRC_CONNECTED state with DRB established and having transmitted a MAC PDU less
than maxHARQ-Tx times }
ensure that {
  when { UE receives an ACK and no uplink grant is included for the next TTI corresponding to the
HARQ process }
  then { UE does not retransmit the MAC PDU }
}

```

(5)

```

with { UE in E-UTRA RRC_CONNECTED state with DRB established and having transmitted a MAC PDU
maxHARQ-Tx times }
ensure that {
  when { UE receives an uplink grant on PDCCH for the next TTI corresponding to the HARQ process
with not toggled NDI }
  then { UE does not retransmit the MAC PDU but transmit a MAC Padding PDU }
}

```

(6)

```

with { UE in E-UTRA RRC_CONNECTED state with DRB established and having transmitted a MAC PDU less
than maxHARQ-Tx times }
ensure that {
  when { UE receives an uplink grant on PDCCH for the next TTI corresponding to the HARQ process
with toggled NDI, and data are not available for transmission }
  then { UE transmits any MAC Padding PDU }
}

```

(7)

```

with { UE in E-UTRA RRC_CONNECTED state with DRB established and having transmitted a MAC PDU
maxHARQ-Tx times }
ensure that {
  when { UE receives a NACK and no uplink grant is included for the next TTI corresponding to the
HARQ process }
  then { UE does not transmit any MAC PDU }
}

```

7.1.4.11.2 Conformance requirements

References: The conformance requirements covered in the current TC are specified in: TS 36.321, clause 5.4.2.1 & 5.4.2.2.

[TS 36.321, clause 5.4.2.1]

There is one HARQ entity at the UE, which maintains a number of parallel HARQ processes allowing transmissions to take place continuously while waiting for the feedback on the successful or unsuccessful reception of previous transmissions.

The number of parallel HARQ processes is specified in [2], clause 8.

At a given TTI, if an uplink grant is indicated for the TTI, the HARQ entity identifies the HARQ process for which a transmission should take place. It also routes the received feedback (ACK/NACK information), MCS and resource, relayed by the physical layer, to the appropriate HARQ process.

If TTI bundling is configured, the parameter TTI_BUNDLE_SIZE provides the number of TTIs of a TTI bundle. TTI bundling operation relies on the HARQ entity for invoking the same HARQ process for each transmission that is part of

the same bundle. Within a bundle HARQ retransmissions are non-adaptive and triggered without waiting for feedback from previous transmissions according to TTI_BUNDLE_SIZE. The feedback for a bundle is only received for the last TTI of the bundle (i.e. the TTI corresponding to TTI_BUNDLE_SIZE), regardless of whether a transmission in that TTI takes place or not (e.g. when a measurement gap occurs). A retransmission of a TTI bundle is also a TTI bundle.

For transmission of Msg3 during Random Access (see section 5.1.5) TTI bundling does not apply. For each TTI, the HARQ entity shall:

- identify the HARQ process associated with this TTI;
- if an uplink grant has been indicated for this TTI:
 - if the received grant was not addressed to a Temporary C-RNTI on PDCCH and if the NDI provided in the associated HARQ information has been toggled compared to the value in the previous transmission of this HARQ process; or
 - if the uplink grant was received on PDCCH for the C-RNTI and the HARQ buffer of the identified process is empty; or-if the uplink grant was received in a Random Access Response:
 - if there is a MAC PDU in the Msg3 buffer and the uplink grant was received in a Random Access Response:
 - obtain the MAC PDU to transmit from the Msg3 buffer.
 - else:
 - obtain the MAC PDU to transmit from the "Multiplexing and assembly" entity;
 - deliver the MAC PDU and the uplink grant and the HARQ information to the identified HARQ process;
 - instruct the identified HARQ process to trigger a new transmission.
- else:
 - deliver the uplink grant and the HARQ information (redundancy version) to the identified HARQ process;
 - instruct the identified HARQ process to generate an adaptive retransmission.
- else, if the HARQ buffer of the HARQ process corresponding to this TTI is not empty:
- instruct the identified HARQ process to generate a non-adaptive retransmission.

When determining if NDI has been toggled compared to the value in the previous transmission UE shall ignore NDI received in all uplink grants on PDCCH for its Temporary C-RNTI.

[TS 36.321, clause 5.4.2.2]

Each HARQ process is associated with a HARQ buffer.

Each HARQ process shall maintain a state variable CURRENT_TX_NB, which indicates the number of transmissions that have taken place for the MAC PDU currently in the buffer, and a state variable HARQ_FEEDBACK, which indicates the HARQ feedback for the MAC PDU currently in the buffer. When the HARQ process is established, CURRENT_TX_NB shall be initialized to 0.

The sequence of redundancy versions is 0, 2, 3, 1. The variable CURRENT_IRV is an index into the sequence of redundancy versions. This variable is up-dated modulo 4.

New transmissions are performed on the resource and with the MCS indicated on PDCCH or Random Access Response. Adaptive retransmissions are performed on the resource and, if provided, with the MCS indicated on PDCCH. Non-adaptive retransmission is performed on the same resource and with the same MCS as was used for the last made transmission attempt,

The UE is configured with a Maximum number of HARQ transmissions and a Maximum number of Msg3 HARQ transmissions by RRC: *maxHARQ-Tx* and *maxHARQ-Msg3Tx* respectively. For transmissions on all HARQ processes and all logical channels except for transmission of a MAC PDU stored in the Msg3 buffer, the maximum number of transmissions shall be set to *maxHARQ-Tx*. For transmission of a MAC PDU stored in the Msg3 buffer, maximum number of transmissions shall be set to *maxHARQ-Msg3Tx*.

When the HARQ feedback is received for this TB, the HARQ process shall:

- set HARQ_FEEDBACK to the received value.

If the HARQ entity requests a new transmission, the HARQ process shall:

- set CURRENT_TX_NB to 0;
- set CURRENT_IRV to 0;
- store the MAC PDU in the associated HARQ buffer;
- store the uplink grant received from the HARQ entity;
- set HARQ_FEEDBACK to NACK;
- generate a transmission as described below.

If the HARQ entity requests a retransmission, the HARQ process shall:

- increment CURRENT_TX_NB by 1;
- if the HARQ entity requests an adaptive retransmission:
 - store the uplink grant received from the HARQ entity;
 - set CURRENT_IRV to the index corresponding to the redundancy version value provided in the HARQ information;
- set HARQ_FEEDBACK to NACK;
- generate a transmission as described below.
- else if the HARQ entity requests a non-adaptive retransmission:
 - if HARQ_FEEDBACK = NACK:
 - generate a transmission as described below.

NOTE: When receiving a HARQ ACK alone, the UE keeps the data in the HARQ buffer.

NOTE: When no UL-SCH transmission can be made due to the occurrence of a measurement gap, no HARQ feedback can be received and a non-adaptive retransmission follows.

To generate a transmission, the HARQ process shall:

- if there is no measurement gap at the time of the transmission and, in case of retransmission, the retransmission does not collide with a transmission for a MAC PDU obtained from the Msg3 buffer:
- instruct the physical layer to generate a transmission according to the stored uplink grant with the redundancy version corresponding to the CURRENT_IRV value;
- increment CURRENT_IRV by 1;
- if there is a measurement gap at the time of the HARQ feedback reception for this transmission and if the MAC PDU was not obtained from the Msg3 buffer:
 - set HARQ_FEEDBACK to ACK at the time of the HARQ feedback reception for this transmission.

After performing above actions, the HARQ process then shall:

- if CURRENT_TX_NB = maximum number of transmissions - 1:
 - flush the HARQ buffer.

7.1.4.11.3 Test description

7.1.4.11.3.1 Pre-test conditions

System Simulator:

- Cell 1
- System information takes into account the parameters in table 7.1.2.11.3.1-1.

UE:

None.

Preamble:

- The UE is in state Loopback Activated (state 4) according to [18] using parameters as specified in Table 7.1.4.11.3.3-1 and 7.1.4.11.3.3-2.
- The loop back size is set in such a way that one RLC SDU in DL shall result in 1 RLC SDU's in UL.
- No UL Grant is allocated; PUCCH is in synchronised state for sending Scheduling Requests.

7.1.4.11.3.2 Test procedure sequence

Table 7.1.4.11.3.2-1: Main behaviour

St	Procedure	Message Sequence		TP	Verdict
		U - S	Message		
1	The SS Transmits a valid MAC PDU containing RLC PDU	<--	MAC PDU	-	-
2	Void	-	-	-	-
3	The SS is configured for Uplink Grant Allocation Type 3. The SS allocates an UL Grant for one HARQ process X, sufficient for one RLC SDU to be loop backed in a TTI, and NDI indicates new transmission	<--	Uplink Grant	-	-
4	Check: Does the UE transmit a MAC PDU including one RLC SDU, in HARQ process X, redundancy version 0? (Note 1)	-->	MAC PDU	1	P
5	The SS transmits a NACK	<--	HARQ NACK	-	-
6	Check: Does the UE retransmit the MAC PDU for HARQ process X, redundancy version 2? (Note 1)	-->	MAC PDU	2	P
7	The SS transmits a NACK	<--	HARQ NACK	-	-
8	Check: Does the UE retransmit the MAC PDU for HARQ process X, redundancy version 3? (Note 1)	-->	MAC PDU	2	P
9	The SS transmits a NACK	<--	HARQ NACK	-	-
10	Check: Does the UE retransmit the MAC PDU for HARQ process X, redundancy version 1? (Note 1)	-->	MAC PDU	2	P
11	The SS transmits a NACK	<--	HARQ NACK	-	-
12	Check: Does the UE retransmit the MAC PDU for HARQ process X, redundancy version 0? (Note 1)	-->	MAC PDU	2	P
13	Void	-	-	-	-
14	Void	-	-	-	-
15	The SS transmits an ACK	<--	HARQ ACK	-	-
16	Check: Does the UE retransmit the MAC PDU for HARQ process X?	-->	MAC PDU	4	F
17	The SS transmits an UL grant corresponding to TTI for HARQ process X, with NDI not toggled and redundancy version to be used as '1'	<--	Uplink Grant	-	-
18	Check: Does the UE retransmit the MAC PDU in for HARQ process X, using redundancy version 1? (Note 1)	-->	MAC PDU	3	P
19	The SS transmits a NACK	<--	HARQ NACK	-	-
20	The SS transmits an UL grant corresponding to next TTI for HARQ process X, with NDI not toggled and redundancy version to be used as '3'	<--	Uplink Grant	-	-
21	Check: Does the UE retransmit the MAC PDU for HARQ process X, using next redundancy version 3? (Note 1)	-->	MAC PDU	3	P
22	The SS transmits a NACK	<--	HARQ NACK	-	-
23	Check: Does the UE retransmit the MAC PDU in the next TTIs corresponding to HARQ process X?	-->	MAC PDU	7	F
24	The SS transmits an UL grant corresponding to TTI for HARQ process X, with NDI not toggled	<--	Uplink Grant	-	-
	EXCEPTION: In parallel with step 25, UE executes parallel behaviour defined in table 7.1.4.11.3.2-2	-	-	-	-
25	Check: Does the UE retransmit the MAC PDU	-->	MAC PDU	5	F

	in the next TTIs corresponding to HARQ process X?				
25 A	The SS transmits an RLC STATUS PDU to the UE	<--	RLC STATUS PDU (ACK_SN=1)	-	-
26	The SS transmits a valid MAC PDU containing RLC PDU	<--	MAC PDU	-	-
27	Void	-	-	-	-
28	The SS is configured for Uplink Grant Allocation Type 3. The SS allocates UL Grant for one HARQ process Y, sufficient for one RLC SDU to be loop backed in a TTI, and NDI indicates new transmission	<--	Uplink Grant	-	-
29	Check: Does the UE transmit a MAC PDU including one RLC SDU, in HARQ process Y, redundancy version 0? (Note 1)	-->	MAC PDU	1	P
30	The SS is configured for Uplink Grant Allocation Type 3. The SS allocates UL Grant for one HARQ process Y, sufficient for one RLC SDU to be loop backed in a TTI, and NDI indicates new transmission	<--	Uplink Grant	-	-
	EXCEPTION: In parallel with step 31, UE executes parallel behaviour defined in table 7.1.4.11.3.2-2.	-	-	-	-
31	Check: Does the UE retransmit the MAC PDU in the next TTIs corresponding to HARQ process Y?	-->	MAC PDU	6	F
32	The SS transmits an RLC STATUS PDU to the UE	<--	RLC STATUS PDU (ACK_SN=2)	-	-
Note 1: Transmission of a UL MAC PDU with a specific redundancy version by the UE is implicitly tested by receiving the UL MAC PDU correctly at SS.					

Table 7.1.4.11.3.2-2: Parallel behaviour

St	Procedure	Message Sequence		TP	Verdict
		U - S	Message		
1	The UE transmits a MAC Padding PDU	-->	MAC PDU	-	-

7.1.4.11.3.3 Specific message contents

Table 7.1.4.11.3.3-1: MAC-MainConfig {RRCConnectionReconfiguration (preamble: Table 4.5.3.3-1, step 8)}

Derivation path: 36.508 table 4.8.2.1.5-1			
Information Element	Value/remark	Comment	Condition
MAC-MainConfig-RBC ::= SEQUENCE {			
ul-SCH-Config SEQUENCE {			
maxHARQ-Tx	n8		
}			
}			

Table 7.1.4.11.3.3-2: RLC-Config-DRB-AM {*RRCConnectionReconfiguration* (preamble: Table 4.5.3.3-1, step 8)}

Derivation path: 36.508 clause 4.8.2.1.3.2, Table 4.8.2.1.3.2-1			
Information Element	Value/Remark	Comment	Condition
RLC-Config-DRB-AM ::= CHOICE {			
am SEQUENCE {			
ul-AM-RLC SEQUENCE {			
t-PollRetransmit	ms250		
}			
}			
}			

7.1.4.12 MAC reset / UL

7.1.4.12.1 Test Purpose (TP)

(1)

```
with(UE in E-UTRA RRC_CONNECTED state, with Scheduling Request procedure triggered)
ensure that {
  when{ UE MAC is reset, due to handover to a new cell }
  then { UE cancels Scheduling Request procedure }
}
```

(2)

```
with ( UE in E-UTRA RRC_CONNECTED state )
ensure that {
  when{ UE MAC is reset, due to handover to a new cell }
  then { UE flushes UL HARQ buffer }
}
```

(3)

```
with (UE in E-UTRA RRC_CONNECTED state )
ensure that {
  when{ UE MAC is reset, due to handover to a new cell }
  then { UE Considers the next transmission for each UL HARQ process as very first }
}
```

7.1.4.12.2 Conformance requirements

References: The conformance requirements covered in the current TC are specified in: TS 36.321, clause 5.9.

[TS 36.321 clause 5.9]

If a reset of the MAC entity is requested by upper layers, the UE shall:

- initialize B_j for each logical channel to zero;
- stop (if running) all timers;
- consider *timeAlignmentTimer* as expired and perform the corresponding actions in subclause 5.2;
- stop, if any, ongoing RACH procedure;
- discard explicitly signalled *ra-PreambleIndex* and *ra-PRACH-MaskIndex*, if any;
- flush Msg3 buffer;
- cancel, if any, triggered Scheduling Request procedure;
- cancel, if any, triggered Buffer Status Reporting procedure;
- cancel, if any, triggered Power Headroom Reporting procedure;
- flush the soft buffers for all DL HARQ processes;

- for each DL HARQ process, consider the next received transmission for a TB as the very first transmission;
- release, if any, Temporary C-RNTI.

7.1.4.12.3 Test description

7.1.4.12.3.1 Pre-test conditions

System Simulator:

- Cell 1 and Cell 2

UE:

None.

Preamble:

- The UE is in state Loopback Activated (state 4) in Cell 1 according to [18].
- The condition SRB2-DRB(1,1) is used for step 8 in 4.5.3A.3 according to [18].

7.1.4.12.3.2 Test procedure sequence

Table 7.1.4.12.3.2-1 illustrates the downlink power levels and other changing parameters to be applied for the cells at various time instants of the test execution. Row marked "T0" denotes the initial conditions, while columns marked "T1" is to be applied subsequently. The exact instants on which these values shall be applied are described in the texts in this clause.

Table 7.1.4.12.3.2-1: Time instances of cell power level and parameter changes

	Parameter	Unit	Cell 1	Cell 2	Remark
T0	Cell-specific RS EPRE	dBm/15Khz	-85	Off	
T1	Cell-specific RS EPRE	dBm/15Khz	-91	-85	
T2	Cell-specific RS EPRE	dBm/15Khz	-85	-91	

Table 7.1.4.12.3.2-2: Main behaviour

St	Procedure	Message Sequence		TP	Verdict
		U - S	Message		
1	The SS ignores scheduling requests and does not allocate any uplink grant.	-	-	-	-
2	The SS transmits a MAC PDU containing one RLC SDU on LC 4	<--	MAC PDU (1 RLC SDU of 40 bytes on DRB)	-	-
3	The UE transmit a scheduling request	-->	(SR)	-	-
4	Wait for 50ms [Discard timer] to expire at UE.	-	-	-	-
5	The SS changes power level according to the row "T1" in table 7.1.4.12.3.2-1	-	-	-	-
6	The SS transmits an <i>RRCCONNECTIONRECONFIGURATION</i> message to order the UE to perform intra frequency handover to Cell 2.	<--	-	-	-
7	The UE transmits on cell 2, <i>RRCCONNECTIONRECONFIGURATIONCOMPLETE</i>	-->	-	-	-
8	Check: For 2 seconds, if UE transmits a scheduling request?	-->	(SR)	1	F
9	The SS transmits a MAC PDU containing RLC SDU on LC 4	<--	MAC PDU (1 RLC SDU of 40 bytes on DRB)	-	-
10	The UE transmit a scheduling request	-->	(SR)	-	-
11	The SS allocate UL Grant sufficient for one RLC SDU to be loop backed in a TTI, and NDI indicates new transmission	<--	Uplink Grant	-	-
12	The UE transmit a MAC PDU including one RLC SDU	-->	MAC PDU	-	-
13	The SS transmits a NACK	<--	HARQ NACK	-	-
13	The SS changes power level according to the row "T2" in table 7.1.4.12.3.2-1	-	-	-	-
14	The SS transmits an <i>RRCCONNECTIONRECONFIGURATION</i> message to order the UE to perform intra frequency handover to Cell 1	<--	-	-	-
15	The UE transmits on cell 1, <i>RRCCONNECTIONRECONFIGURATIONCOMPLETE</i>	-->	-	-	-
16	Check: For 2 seconds, does UE transmit MAC PDU containing Loop Back PDU?	-->	MAC PDU (1 RLC SDU of 40 bytes on DRB)	2	F
17	The SS transmits a MAC PDU containing RLC SDU on LC 4	<--	MAC PDU (1 RLC SDU of 40 bytes on DRB)	-	-
18	The UE transmit a scheduling request	-->	(SR)	-	-
19	The SS allocate UL Grant sufficient for one RLC SDU to be loop backed in a TTI, and NDI indicates new transmission	<--	Uplink Grant	-	-
20	Check: Does UE transmit a MAC PDU including one RLC SDU?	-->	MAC PDU	3	P

7.1.4.12.3.3 Specific Message Contents

Table 7.1. 4.12.3.3-1: MAC-MainConfiguration {RRCCONNECTIONRECONFIGURATION (preamble)}

Derivation path: 36.508 table 4.8.2.1.5-1			
Information Element	Value/remark	Comment	Condition
MAC-MainConfiguration-RBC ::= SEQUENCE {			
ul-SCH-Configuration SEQUENCE {			
maxHARQ-Tx	n28		
}			
}			

Table 7.1.4.12.3.3-2: PDCP-Configuration-DRB-UM {RRCConnectionReconfiguration (preamble)}

Derivation Path: 36.508 clause 4.8.2.1.2.1-1			
Information Element	Value/remark	Comment	Condition
PDCP-Configuration-DRB-UM ::= SEQUENCE {			
discardTimer	ms50	Lowest value	
}			

Table 7.1.4.12.3.3-3: SchedulingRequest-Configuration {RRCConnectionReconfiguration (preamble)}

Derivation Path: 36.508 clause 4.6.3-20			
Information Element	Value/remark	Comment	Condition
SchedulingRequest-Configuration ::= CHOICE {			
enable SEQUENCE {			
dsr-TransMax	n64	Max value allowed	
}			
}			

Table 7.1.4.12.3.3-4: RRCConnectionReconfiguration (step 6, table 7.1.4.12.3.2-2)

Derivation Path: 36.508, Table 4.6.1-6, condition RBC-HO			
Information Element	Value/Remark	Comment	Condition
RRCConnectionReconfiguration ::= SEQUENCE {			
criticalExtensions CHOICE {			
c1 CHOICE{			
rrcConnectionReconfiguration-r8 SEQUENCE {			
mobilityControllInformation SEQUENCE {	MobilityControllInformatio n-HO		
targetCellIdentity	PhysicalCellIdentity of Cell 2 (see 36.508 clause 4.4.4.2)		
eutra-CarrierFreq	Not present		
}			
}			
}			
}			

Table 7.1.4.12.3.3-5: RRCConnectionReconfiguration (step 14, table 7.1.4.12.3.2-2)

Derivation Path: 36.508, Table 4.6.1-6, condition RBC-HO			
Information Element	Value/Remark	Comment	Condition
RRCConnectionReconfiguration ::= SEQUENCE {			
criticalExtensions CHOICE {			
c1 CHOICE{			
rrcConnectionReconfiguration-r8 SEQUENCE {			
mobilityControllInformation SEQUENCE {	MobilityControllInformatio n-HO		
targetCellIdentity	PhysicalCellIdentity of Cell 1 (see 36.508 clause 4.4.4.2)		
eutra-CarrierFreq	Not present		
}			
}			
}			
}			

7.1.4.13 MAC PDU header handling

7.1.4.13.1 Test Purpose (TP)

(1)

```
with { UE in E-UTRA RRC_CONNECTED state }
ensure that {
  when { UE has a MAC SDU to be transmitted that is less smaller 128 bytes }
  then { UE sets F field to 0 }
}
```

(2)

```
with { UE in E-UTRA RRC_CONNECTED state }
ensure that {
  when { UE has a MAC SDU to be transmitted that is larger than 128 bytes }
  then { UE sets F field to 1 }
}
```

(3)

```
with { UE in E-UTRA RRC_CONNECTED state }
ensure that {
  when { UE inserts a R/R/E/LCID field in the MAC header and there is a subsequent R/R/E/LCID field
to be inserted }
  then { UE sets E field to 1 }
}
```

(4)

```
with { UE in E-UTRA RRC_CONNECTED state }
ensure that {
  when { UE inserts a R/R/E/LCID field in the MAC header and a MAC SDU or a MAC control element
starts at the next byte }
  then { UE sets E field to 0 }
}
```

(5)

```
with { UE in E-UTRA RRC_CONNECTED state }
ensure that {
  when { UE inserts the last MAC sub-header in the MAC PDU }
  then { UE inserts a MAC sub-header consist solely of the four header fields R/R/E/LCID }
}
```

(6)

```
with { UE in E-UTRA RRC_CONNECTED state }
ensure that {
  when { UE inserts padding at the end of a MAC PDU }
  then { UE inserts the last MAC sub-header as a padding MAC subheader consisting solely of the
four header fields R/R/E/LCID with LCID set to Padding }
}
```

7.1.4.13.2 Conformance requirements

References: The conformance requirements covered in the present TC are specified in: 3GPP TS 36.321 clause 6.1.2 and 6.2.1.

[TS 36.321, clause 6.1.2]

A MAC PDU consists of a MAC header, zero or more MAC Service Data Units (MAC SDU), zero, or more MAC control elements, and optionally padding; as described in Figure 6.1.2-3.

Both the MAC header and the MAC SDUs are of variable sizes.

A MAC PDU header consists of one or more MAC PDU sub-headers; each sub header corresponding to either a MAC SDU, a MAC control element or padding.

A MAC PDU sub header consists of the six header fields R/R/E/LCID/F/L but for the last sub header in the MAC PDU and for fixed sized MAC control elements. The last sub header in the MAC PDU and sub-headers for fixed sized MAC control elements consist solely of the four header fields R/R/E/LCID. A MAC PDU subheader corresponding to padding consists of the four header fields R/R/E/LCID.

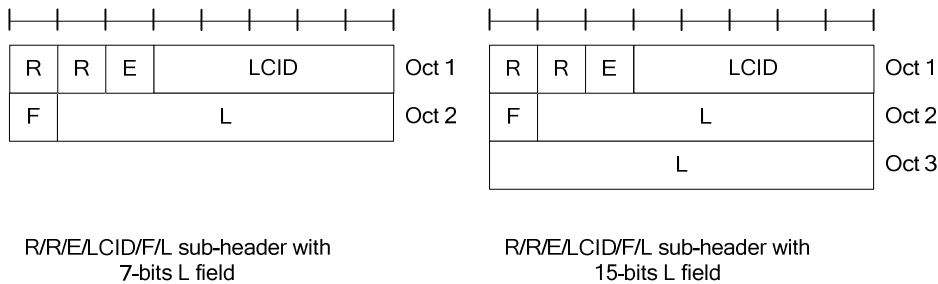

Figure 6.1.2-1: R/R/E/LCID/F/L MAC sub header

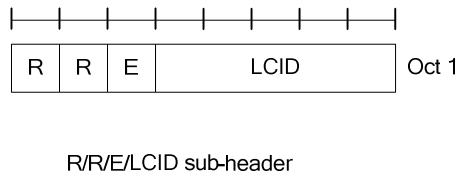

Figure 6.1.2-2: R/R/E/LCID MAC sub header

MAC PDU sub-headers have the same order as the corresponding MAC SDUs, MAC control elements and padding.

MAC control elements are always placed before any MAC SDU.

Padding occurs at the end of the MAC PDU, except when single-byte or two-byte padding is required. Padding may have any value and the UE shall ignore it. When padding is performed at the end of the MAC PDU, zero or more padding bytes are allowed.

When single-byte or two-byte padding is required, one or two MAC PDU subheaders corresponding to padding are placed at the beginning of the MAC PDU before any other MAC PDU subheader.

A maximum of one MAC PDU can be transmitted per TB per UE.

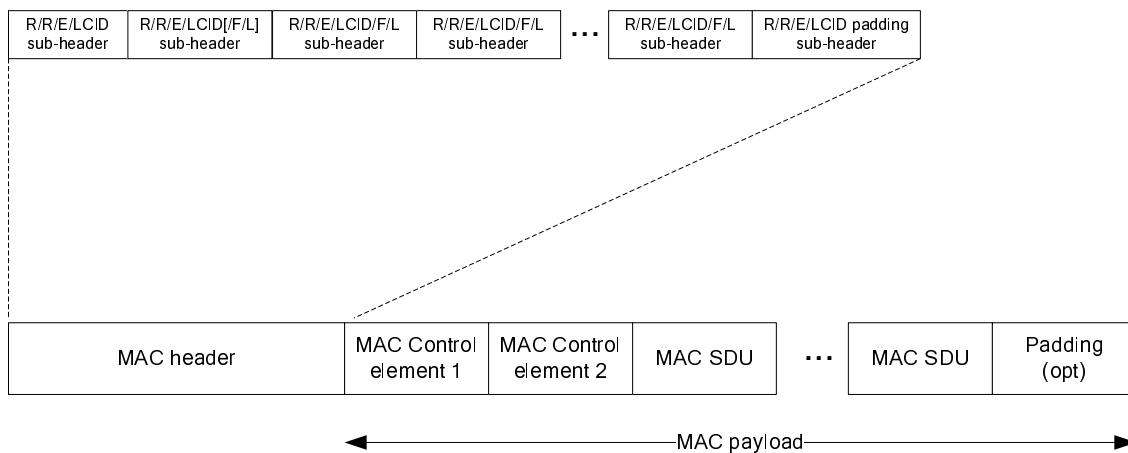

Figure 6.1.2-3: Example of MAC PDU consisting of MAC header, MAC control elements, MAC SDUs and padding

[TS 36.321, clause 6.2.1]

The MAC header is of variable size and consists of the following fields:

- LCID: The Logical Channel ID field identifies the logical channel instance of the corresponding MAC SDU or the type of the corresponding MAC control element or padding as described in tables 6.2.1-1 and 6.2.1-2 for the DL and UL-SCH respectively. There is one LCID field for each MAC SDU, MAC control element or padding included in the MAC PDU. In addition to that, one or two additional LCID fields are included in the MAC PDU, when single-byte or two-byte padding is required but cannot be achieved by padding at the end of the MAC PDU. The LCID field size is 5 bits;
- L: The Length field indicates the length of the corresponding MAC SDU or MAC control element in bytes. There is one L field per MAC PDU sub header except for the last sub header and sub-headers corresponding to fixed-sized MAC control elements. The size of the L field is indicated by the F field;
- F: The Format field indicates the size of the Length field as indicated in table 6.2.1-3. There is one F field per MAC PDU sub header except for the last sub header and sub-headers corresponding to fixed-sized MAC control elements. The size of the F field is 1 bit. If the size of the MAC SDU or MAC control element is less than 128 bytes, the UE shall set the value of the F field to 0, otherwise the UE shall set it to 1;
- E: The Extension field is a flag indicating if more fields are present in the MAC header or not. The E field is set to "1" to indicate another set of at least R/R/E/LCID fields. The E field is set to "0" to indicate that either a MAC SDU, a MAC control element or padding starts at the next byte;
- R: Reserved bits, set to "0".

The MAC header and sub-headers are octet aligned.

...

Table 6.2.1-2: Values of LCID for UL-SCH

Index	LCID values
00000	CCCH
00001-01010	Identity of the logical channel
01011-11001	Reserved
11010	Power Headroom Report
11011	C-RNTI
11100	Truncated BSR
11101	Short BSR
11110	Long BSR
11111	Padding

...

Table 6.2.1-3: Values of F field:

Index	Size of Length field (in bits)
0	7
1	15

7.1.4.13.3 Test description

7.1.4.13.3.1 Pre-test conditions

System Simulator:

- Cell 1

UE:

None.

Preamble:

- The UE is in state Loopback Activated (state 4) according to [18].
- The condition SRB2-DRB(2,0) is used for step 8 in 4.5.3A.3 according to [18].

- 2 AM DRBs are configured with the parameters specified in table 7.1.4.13.3.1-1.

Table 7.1.4.13.3.1-1: Logical Channel Configuration Settings

Parameter	DRB1	DRB2
LogicalChannel-Identity	3	4
Priority	7	6
prioritizedBitRate	0kbs	0kbs
logicalChannelGroup	2	1

7.1.4.13.3.2 Test procedure sequence

Table 7.1.4.13.3.2-1: Main behaviour

St	Procedure	Message Sequence		TP	Verdict
		U - S	Message		
1	The SS ignores scheduling requests and does not allocate any uplink grant.	-	-	-	-
2	The SS transmits a MAC PDU containing a MAC SDU of size 127 bytes (RLC SDU of size 125 bytes + AMD PDU header 2 bytes) with the Logical Channel ID field 'LCID' set to '00011', and 1 Byte Padding in the associated MAC SDU sub-header.	<--	MAC PDU (MAC sub-header (LCID='00011'), AMD PDU)	-	-
3	The UE sends Scheduling Request	-->	(SR)	-	-
4	The SS transmits an uplink grant of size 1096 bits. (Note 1)	<--	(UL grant)	-	-
5	Check: does the UE transmit a MAC PDU with a MAC SDU sub-header with Logical Channel ID field 'LCID' set to '00011', Format field 'F' set to '0' and Length field 'L' set to '127'? (Note 6)	-->	MAC PDU (MAC sub-header (LCID='00011', F='0', L='127' bytes), AMD PDU)	1	P
5a	The SS transmits an RLC STATUS PDU to acknowledge correctly received data	<--	RLC STATUS PDU (ACK_SN=1)	-	-
6	The SS transmits a MAC PDU containing a MAC SDU of size 128 bytes (RLC SDU of 126 bytes + AMD PDU header 2 bytes) with the Logical Channel ID field 'LCID' set to '00011'.	<--	MAC PDU (MAC sub-header (LCID='00011'), AMD PDU)	-	-
7	The UE send Scheduling Request	-->	(SR)	-	-
8	The SS transmits an uplink grant of size 1096 bits. (Note 2)	<--	(UL grant)	-	-
9	Check: Does the UE transmit a MAC PDU with a MAC SDU sub-header with Format field 'F' set to '1' and Logical Channel ID field 'LCID' set to '00011'? (Note 6)	-->	MAC PDU (MAC sub-header (LCID='00011', F='1', L=128), AMD PDU)	2	P
10	The SS transmits an RLC STATUS PDU to acknowledge correctly received data	<--	RLC STATUS PDU (ACK_SN=2)	-	-
11	The SS transmits a MAC PDU containing two MAC SDUs, the first containing a 9 byte RLC SDU with LCID set to '00011' and the second containing s 6 byte RLC SDU with LCID set to '00100'.	<--	MAC PDU (MAC sub-header (E='1', LCID='00011', F='0', L='11'), MAC sub-header (E='0', LCID='00100'), AMD PDU, AMD PDU)	-	-
12	The UE sends Scheduling Request	-->	(SR)	-	-
13	The SS transmits an uplink grant of size 176 bits. (Note 3)	<--	(UL grant)	-	-
14	Check: Does the UE return a MAC PDU of length 176 bits containing two MAC sub-headers where the first MAC sub-header have the Expansion bit 'E' set to '1' and the second MAC sub-header has the Expansion bit 'E' set to '0' and no length field? (Note 5)	-->	MAC PDU (MAC sub-header (E='1', (LCID='00011', L='11) or (LCID='00100',L='8), MAC sub-header (E='0', no Length field present), AMD PDU, AMD PDU)	3,4, 5	P
15	SS transmits an RLC STATUS PDU to acknowledge correctly received data(LCID='00011')	<--	RLC STATUS PDU (ACK_SN=3)	-	-
16	SS transmits an RLC STATUS PDU to acknowledge correctly received data(LCID='00100')	<--	RLC STATUS PDU (ACK_SN=1)	-	-
17	The SS transmits a MAC PDU containing two MAC SDUs, the first containing a 8 byte RLC SDU with LCID set to '00011' and the second containing a 7 byte RLC SDU with LCID set to '00100'.	<--	MAC PDU (MAC sub-header (E='1', LCID='00011', F='0', L='10'), MAC sub-header (E='0', LCID='00100'), AMD PDU, AMD PDU)	-	-
18	The UE sends Scheduling Request	-->	(SR)	-	-
19	The SS transmits an uplink grant of size 256 bits. (Note 4)	<--	(UL grant)	-	-
20	Check: Does the UE return a MAC PDU of length 256 bits containing four MAC sub-	-->	MAC PDU (Long BSR MAC sub-header (E='1', LCID='11110',	3,4, 6	P

	headers where the first three MAC sub-header have the Expansion bit 'E' set to '1' and the last MAC sub-header has the Expansion bit 'E' set to '0' and the LCID field set to '11111'? (Note 5) (Note 7)		MAC sub-header (E='1', F='0'), MAC sub-header (E='1', F='0'), F='0'), padding MAC sub-header (E='0', LCID='11111'), Long BSR, AMD PDU, AMD PDU, padding) Or MAC PDU (Short BSR MAC sub- header (E='1', LCID='11101', MAC sub-header (E='1', F='0'), MAC sub-header (E='1', F='0'), F='0'), padding MAC sub-header (E='0', LCID='11111'), Short BSR, AMD PDU, AMD PDU, padding)		
21	SS transmits an RLC STATUS PDU to acknowledge correctly received data(LCID='00011')	<--	RLC STATUS PDU (ACK_SN=4)		
22	SS transmits an RLC STATUS PDU to acknowledge correctly received data(LCID='00100')	<--	RLC STATUS PDU (ACK_SN=2)		
Note 1:	UL grant of 1096 bits ($I_{TBS}=8$, $N_{PRB}=8$, TS 36.213 Table 7.1.7.2.1-1) is chosen to enable UE to transmit a MAC SDU of size 127 bytes in a MAC PDU (125 bytes RLC SDU size + 2 bytes AMD PDU header + 2 bytes MAC header (7 bit LI) = 129 bytes = 1032 bits < 1096 bits.				
Note 2:	UL grant of 1096 bits ($I_{TBS}=8$, $N_{PRB}=8$, TS 36.213 Table 7.1.7.2.1-1) is chosen to enable UE to transmit a MAC SDU of size 128 bytes in a MAC PDU (126 bytes RLC SDU size + 2 bytes AMD PDU header + 3 bytes MAC header (15 bit LI) = 131 bytes = 1048 bits < 1096 bits.				
Note 3:	UL grant of 176 bits ($I_{TBS}=1$, $N_{PRB}=5$, TS 36.213 Table 7.1.7.2.1-1) is chosen to enable UE to transmit two MAC SDUs, one of size 11 and one of size 8 bytes, in a MAC PDU (9 bytes RLC SDU + 2 bytes AMD PDU header + 6 bytes RLC SDU + 2 bytes AMD PDU header + 2 bytes MAC sub-header (7 bit LI) + one byte MAC sub-header (R/R/E/LCID) = 22 bytes = 176 bits)				
Note 4:	UL grant of 256 bits ($I_{TBS}=6$, $N_{PRB}=3$, TS 36.213 Table 7.1.7.2.1-1) is chosen to enable UE to transmit two MAC SDUs of size 10 and 9 bytes in a MAC PDU (8 bytes RLC SDU + 2 bytes AMD PDU header + 7 bytes RLC SDU+ 2 bytes AMD PDU header) + 3 byte Long BSR+4 byte padding + one byte BSR header+ 2 x 2 bytes MAC sub-header (7 bit LI) + one byte padding MAC sub-header (R/R/E/LCID) = 32bytes = 256 bits) or (8 bytes RLC SDU + 2 bytes AMD PDU header + 7 bytes RLC SDU+ 2 bytes AMD PDU header) + 1 byte Short BSR+6 byte padding + one byte BSR header+ 2 x 2 bytes MAC sub-header (7 bit LI) + one byte padding MAC sub-header (R/R/E/LCID) = 32bytes = 256 bits)				
Note 5:	MAC SDU for LCID 3 and 4 can come in any order				
Note 6:	At this step UE shall include a BSR and report it on any of the configured Logical Channel Groups: 0 (SRB2), 1 (DRB2) and 2 (DRB1),				
Note 7:	It is left up to UE implementation whether ShortBSR or LongBSR is reported.				

7.1.4.13.3.3 Specific Message Contents

None.

7.1.4.14 Correct HARQ process handling / TTI bundling

7.1.4.14.1 Test Purpose (TP)

(1)

```
with { UE in E-UTRA RRC_CONNECTED state with DRB established and TTI bundling configured }
ensure that {
  when { UE receives an UL Grant with toggled NDI and has data available for transmission }
  then { UE transmits a new MAC PDU and non-adaptive retransmissions for 3 additional consecutive
UL subframes }
}
```

(2)

```
with { UE in E-UTRA RRC_CONNECTED state with DRB established, TTI bundling configured and having
transmitted a MAC PDU less than maxHARQ-Tx times }
ensure that {
  when { UE receives a NACK and no uplink grant is included for the next TTI corresponding to the
bundled HARQ process }
  then { UE performs non-adaptive retransmissions of the MAC PDU for 4 consecutive UL subframes }
}
```

(3)

```

with { UE in E-UTRA RRC_CONNECTED state with DRB established, TTI bundling configured and having
transmitted a MAC PDU less than maxHARQ-Tx times }
ensure that {
  when { UE receives an uplink grant on PDCCH for the next TTI corresponding to the HARQ process
with old NDI, irrespective of ACK/NACK is received for previous (re)transmission }
  then { UE performs an adaptive retransmission of the MAC PDU with redundancy version as received
on PDCCH in first UL subframe and non-adaptive retransmissions in 3 additional consecutive UL
subframes }
}

```

(4)

```

with { UE in E-UTRA RRC_CONNECTED state with DRB established and having transmitted a MAC PDU less
than maxHARQ-Tx times }
ensure that {
  when { UE receives an ACK and no uplink grant is included for the next TTI corresponding to the
HARQ process }
  then { UE does not retransmit the TTI Bundle }
}

```

7.1.4.14.2 Conformance requirements

References: The conformance requirements covered in the current TC are specified in: TS 36.321, clause 5.4.2.1, 5.4.2.2 & 7.5, TS 36.213 clause 8, 8.3, 8.6.1 & 9.1.2.

[TS 36.321, clause 5.4.2.1]

There is one HARQ entity at the UE, which maintains a number of parallel HARQ processes allowing transmissions to take place continuously while waiting for HARQ the feedback on the successful or unsuccessful reception of previous transmissions.

The number of parallel HARQ processes is specified in [2], clause 8.

At a given TTI, if an uplink grant is indicated for the TTI, the HARQ entity identifies the HARQ process for which a transmission should take place. It also routes the received HARQ feedback (ACK/NACK information), MCS and resource, relayed by the physical layer, to the appropriate HARQ process.

When TTI bundling is configured, the parameter TTI_BUNDLE_SIZE provides the number of TTIs of a TTI bundle. TTI bundling operation relies on the HARQ entity for invoking the same HARQ process for each transmission that is part of the same bundle. Within a bundle HARQ retransmissions are non-adaptive and triggered without waiting for feedback from previous transmissions according to TTI_BUNDLE_SIZE. The HARQ feedback of a bundle is only received for the last TTI of the bundle (i.e. the TTI corresponding to TTI_BUNDLE_SIZE), regardless of whether a transmission in that TTI takes place or not (e.g. when a measurement gap occurs). A retransmission of a TTI bundle is also a TTI bundle.

For transmission of Msg3 during Random Access (see section 5.1.5) TTI bundling does not apply.

For each TTI, the HARQ entity shall:

- identify the HARQ process associated with this TTI;
- if an uplink grant has been indicated for this TTI:
 - if the received grant was not addressed to a Temporary C-RNTI on PDCCH and if the NDI provided in the associated HARQ information has been toggled compared to the value in the previous transmission of this HARQ process; or
 - if the uplink grant was received on PDCCH for the C-RNTI and the HARQ buffer of the identified process is empty; or
 - if the uplink grant was received in a Random Access Response:
 - if there is a MAC PDU in the Msg3 buffer and the uplink grant was received in a Random Access Response:
 - obtain the MAC PDU to transmit from the Msg3 buffer.

- else:
 - obtain the MAC PDU to transmit from the "Multiplexing and assembly" entity;
 - deliver the MAC PDU and the uplink grant and the HARQ information to the identified HARQ process;
 - instruct the identified HARQ process to trigger a new transmission.
- else:
 - deliver the uplink grant and the HARQ information (redundancy version) to the identified HARQ process;
 - instruct the identified HARQ process to generate an adaptive retransmission.
- else, if the HARQ buffer of the HARQ process corresponding to this TTI is not empty:
 - instruct the identified HARQ process to generate a non-adaptive retransmission.

When determining if NDI has been toggled compared to the value in the previous transmission UE shall ignore NDI received in all uplink grants on PDCCH for its Temporary C-RNTI.

[TS 36.321, clause 5.4.2.2]

Each HARQ process is associated with a HARQ buffer.

Each HARQ process shall maintain a state variable `CURRENT_TX_NB`, which indicates the number of transmissions that have taken place for the MAC PDU currently in the buffer, and a state variable `HARQ_FEEDBACK`, which indicates the HARQ feedback for the MAC PDU currently in the buffer. When the HARQ process is established, `CURRENT_TX_NB` shall be initialized to 0.

The sequence of redundancy versions is 0, 2, 3, 1. The variable `CURRENT_IRV` is an index into the sequence of redundancy versions. This variable is up-dated modulo 4.

New transmissions are performed on the resource and with the MCS indicated on PDCCH or Random Access Response. Adaptive retransmissions are performed on the resource and, if provided, with the MCS indicated on PDCCH. Non-adaptive retransmission is performed on the same resource and with the same MCS as was used for the last made transmission attempt.

The UE is configured with a Maximum number of HARQ transmissions and a Maximum number of Msg3 HARQ transmissions by RRC: `maxHARQ-Tx` and `maxHARQ-Msg3Tx` respectively. For transmissions on all HARQ processes and all logical channels except for transmission of a MAC PDU stored in the Msg3 buffer, the maximum number of transmissions shall be set to `maxHARQ-Tx`. For transmission of a MAC PDU stored in the Msg3 buffer, the maximum number of transmissions shall be set to `maxHARQ-Msg3Tx`.

When the HARQ feedback is received for this TB, the HARQ process shall:

- set `HARQ_FEEDBACK` to the received value.

If the HARQ entity requests a new transmission, the HARQ process shall:

- set `CURRENT_TX_NB` to 0;
- set `CURRENT_IRV` to 0;
- store the MAC PDU in the associated HARQ buffer;
- store the uplink grant received from the HARQ entity;
- set `HARQ_FEEDBACK` to NACK;
- generate a transmission as described below.

If the HARQ entity requests a retransmission, the HARQ process shall:

- increment `CURRENT_TX_NB` by 1;
- if the HARQ entity requests an adaptive retransmission:

- store the uplink grant received from the HARQ entity;
- set CURRENT_IRV to the index corresponding to the redundancy version value provided in the HARQ information;
- set HARQ_FEEDBACK to NACK;
- generate a transmission as described below.
- else if the HARQ entity requests a non-adaptive retransmission:
 - if HARQ_FEEDBACK = NACK:
 - generate a transmission as described below.

NOTE 1: When receiving a HARQ ACK alone, the UE keeps the data in the HARQ buffer.

NOTE 2: When no UL-SCH transmission can be made due to the occurrence of a measurement gap, no HARQ feedback can be received and a non-adaptive retransmission follows.

To generate a transmission, the HARQ process shall:

- if the MAC PDU was obtained from the Msg3 buffer; or
- if there is no measurement gap at the time of the transmission and, in case of retransmission, the retransmission does not collide with a transmission for a MAC PDU obtained from the Msg3 buffer in this TTI:
 - instruct the physical layer to generate a transmission according to the stored uplink grant with the redundancy version corresponding to the CURRENT_IRV value;
 - increment CURRENT_IRV by 1;
 - if there is a measurement gap at the time of the HARQ feedback reception for this transmission and if the MAC PDU was not obtained from the Msg3 buffer:
 - set HARQ_FEEDBACK to ACK at the time of the HARQ feedback reception for this transmission.

After performing above actions, the HARQ process then shall:

- if CURRENT_TX_NB = maximum number of transmissions – 1:
 - flush the HARQ buffer;

[TS 36.321, clause 7.5]

The parameter TTI_BUNDLE_SIZE is 4.

[TS 36.213, clause 8]

For FDD, there shall be 8 HARQ processes in the uplink for non-subframe bundling operation, i.e. normal HARQ operation, and 4 HARQ processes in the uplink for subframe bundling operation. The subframe bundling operation is configured by the parameter *tTiBundling* provided by higher layers.

In case higher layers configure the use of subframe bundling for FDD and TDD, the subframe bundling operation is only applied to UL-SCH, such that four consecutive uplink subframes are used.

...

For FDD and subframe bundling operation, the UE shall upon detection of a PDCCH with DCI format 0 in subframe n intended for the UE, and/or a PHICH transmission in subframe $n-5$ intended for the UE, adjust the corresponding first PUSCH transmission in the bundle in subframe $n+4$ according to the PDCCH and PHICH information.

...

For TDD UL/DL configurations 1 and 6 and subframe bundling operation, the UE shall upon detection of a PDCCH with DCI format 0 in subframe n intended for the UE, and/or a PHICH transmission intended for the UE in subframe $n-l$ with l given in Table 8-2a, adjust the corresponding first PUSCH transmission in the bundle in subframe $n+k$, with k given in Table 8-2, according to the PDCCH and PHICH information.

...

Table 8-2: k for TDD configurations 0-6

TDD UL/DL Configuration	DL subframe number n									
	0	1	2	3	4	5	6	7	8	9
0	4	6				4	6			
1		6			4		6			4
2				4					4	
3	4								4	4
4									4	4
5									4	
6	7	7				7	7			5

Table 8-2a: l for TDD configurations 0, 1 and 6

TDD UL/DL Configuration	DL subframe number n									
	0	1	2	3	4	5	6	7	8	9
0	9	6				9	6			
1		2			3		2			3
6	5	5				6	6			8

[TS 36.213, clause 8.3]

For Frame Structure type 1, an ACK/NACK received on the PHICH assigned to a UE in subframe i is associated with the PUSCH transmission in subframe $i-4$.

For Frame Structure type 2 UL/DL configuration 1-6, an ACK/NACK received on the PHICH assigned to a UE in subframe i is associated with the PUSCH transmission in the subframe $i-k$ as indicated by the following table 8.3-1.

...

Table 8.3-1 k for TDD configurations 0-6

TDD UL/DL Configuration	DL subframe number i									
	0	1	2	3	4	5	6	7	8	9
0	7	4				7	4			
1		4			6		4			6
2				6					6	
3	6								6	6
4									6	6
5									6	
6	6	4				7	4			6

[TS 36.213, clause 8.6.1]

For $0 \leq I_{MCS} \leq 28$, the modulation order (Q_m) is determined as follows:

...

- If the parameter *ttiBundling* provided by higher layers is set to *TRUE*, then the resource allocation size is restricted to $N_{PRB} \leq 3$ and the modulation order is set to $Q_m = 2$.

[TS 36.213, clause 9.1.2]

For scheduled PUSCH transmissions in subframe n , a UE shall determine the corresponding PHICH resource in subframe $n + k_{PHICH}$, where k_{PHICH} is always 4 for FDD and is given in table 9.1.2-1 for TDD. For subframe bundling operation, the corresponding PHICH resource is associated with the last subframe in the bundle.

Table 9.1.2-1: k_{PHICH} for TDD

TDD UL/DL	UL subframe index n

Configuration	0	1	2	3	4	5	6	7	8	9
0			4	7	6			4	7	6
1			4	6				4	6	
2			6					6		
3			6	6	6					
4			6	6						
5			6							
6			4	6	6			4	7	

7.1.4.14.3 Test description

7.1.4.14.3.1 Pre-test conditions

System Simulator:

- Cell 1

UE:

None.

Preamble:

- The UE is in state Loopback Activated (state 4) according to [18].
- The condition SRB2-DRB(1,1) is used for step 8 in 4.5.3A.3 according to [18].
- No UL Grant is allocated; PUCCH is in synchronised state for sending Scheduling Requests.

7.1.4.14.3.2 Test procedure sequence

Table 7.1.4.14.3.2-1: Main behaviour

St	Procedure	Message Sequence		TP	Verdict
		U - S	Message		
0A	SS Transmits RRCConnectionReconfiguration to configure TTI bundling	<--	-	-	-
0B	The UE transmits RRCConnectionReconfigurationComplete	-->	-	-	-
1	The SS Transmits a valid MAC PDU containing RLC PDU of size 312 bits on UM Bearer.	<--	MAC PDU	-	-
2	The UE transmits a Scheduling Request	-->	Scheduling Request	-	-
3	The SS allocates an UL Grant of 328 bits with NDI indicating new transmission (i.e. Nprb=3 and Imcs=7)(Note 1)	<--	Uplink Grant	-	-
4	Check: Does the UE transmit a MAC PDU including one RLC SDU, with redundancy version 0, 'k' subframes after step 3? (Note 3)	-->	MAC PDU	1	P
5	Check: Does UE repeat non-adaptive retransmission of MAC PDU in step 4, for 3 consecutive UL subframes with redundancy version 2, 3 and 1 respectively? (Note 3)	-->	MAC PDU	1	P
6	The SS transmits a NACK, 'kk' subframes after last transmission in step 5.	<--	HARQ NACK	-	-
7	Check: Does the UE make non-adaptive retransmissions of the MAC PDU 'm' subframes after NACK in step 6, for 4 consecutive UL subframes with redundancy version 0, 2, 3 and 1 respectively? (Note 3)	-->	MAC PDU	2	P
8	The SS transmits an ACK, 'kk' subframes after last transmission in step 7.	<--	HARQ ACK	-	-
9	The SS allocates an UL Grant with NDI indicating retransmission, start redundancy version =2[i.e. Nprb=3 and Imcs=30], 'l' subframes after ACK in step 8.	<--	Uplink Grant	-	-
10	Check: Does the UE perform an adaptive retransmission of the MAC PDU 'k' subframes after grant in step 9, using redundancy version 2? (Note 3)	-->	MAC PDU	3	P
11	Check: Does UE repeat non-adaptive retransmission of MAC PDU in step 10, for 3 consecutive UL sub-frames with redundancy version 3, 1 and 0 respectively? (Note 3)	-->	MAC PDU	3	P
12	The SS transmits an ACK, 'kk' subframes after last transmission in step 11.	<--	HARQ ACK	-	-
13	Check: Does the UE make any retransmissions of the MAC PDU 'm' subframes after ACK in step 12, for 4 consecutive UL subframes?	-->	MAC PDU	4	F
<p>Note 1: In step3, for TDD, the subframe number of allocating UL grant should be selected from {'1', '4', '6', '9'} based on TDD default UL/DL configuration 1.</p> <p>Note 2: For FDD value of 'k', 'kk' is 4, 'l' is 5 and 'm' is 9. For TDD UL/DL configuration 1, values of 'k', 'l', 'm' and 'kk' are given in table 7.1.4.14.3.2-2.</p> <p>Note 3: Transmission of a UL MAC PDU with a specific redundancy version by the UE is implicitly tested by receiving the UL MAC PDU correctly at SS.</p>					

Table 7.1.4.14.3.2-2: Values for parameter 'k', 'l', 'm' and 'kk' in Main behaviour.

Parameter	DL sub-frame number <i>n</i>									
	0	1	2	3	4	5	6	7	8	9
k		6			4		6			4
l		3			2		3			2
m		7			8		7			8
kk			4	6				4	6	

7.1.4.14.3.3 Specific message contents

Table 7.1.4.14.3.3-1: MAC-MainConfig-RBC in *RRCConnectionReconfiguration*(Step 0A)

Derivation Path: 36.508 table 4.8.2.1.5-1			
Information Element	Value/remark	Comment	Condition
MAC-MainConfigRBC ::= SEQUENCE {			
ul-SCH-Configuration SEQUENCE {			
maxHARQ-Tx	n28	Max value allowed	
periodicBSR-Timer	Infinity		
retxBSR-Timer	sf10240		
ttiBundling	TRUE		
}			
}			

7.1.4.15 UE power headroom reporting / Periodic reporting

7.1.4.15.1 Test Purpose (TP)

(1)

```
with { UE in E-UTRA RRC_CONNECTED state with DRB established, periodic power headroom reporting
configured }
ensure that {
  when { periodicPHR-Timer is configured in RRCConnectionReconfiguration procedure }
  then { UE transmits a MAC PDU containing Power Headroom MAC Control Element }
}
```

(2)

```
with { UE in E-UTRA RRC_CONNECTED state with DRB established, periodic power headroom reporting
configured }
ensure that {
  when { periodicPHR-Timer expires and UL resources allocated for new transmission }
  then { UE transmits a MAC PDU containing Power Headroom MAC Control Element }
}
```

(3)

```
with { UE in E-UTRA RRC_CONNECTED state with DRB established }
ensure that {
  when { power headroom reporting is disabled }
  then { UE stops transmitting Power Headroom MAC Control Element }
}
```

7.1.4.15.2 Conformance requirements

References: The conformance requirements covered in the current TC are specified in: TS 36.321 clause 5.4.6 and 6.1.3.6, 36.331.

[TS 36.321, clause 5.4.6]

The Power Headroom reporting procedure is used to provide the serving eNB with information about the difference between the nominal UE maximum transmit power and the estimated power for UL-SCH transmission. The reporting period, delay and mapping of Power Headroom are defined in subclause 9.1.8 of 3GPP TS 36.133 [9]. RRC controls Power Headroom reporting by configuring the two timers *periodicPHR-Timer* and *prohibitPHR-Timer*, and by signalling *dl-PathlossChange* which sets the change in measured downlink pathloss to trigger a PHR [8].

A Power Headroom Report (PHR) shall be triggered if any of the following events occur:

- the *prohibitPHR-Timer* expires or has expired and the path loss has changed more than *dl-PathlossChange* dB since the transmission of a PHR when UE has UL resources for new transmission;
- *periodicPHR-Timer* expires;
- upon configuration and reconfiguration of the power headroom reporting functionality by upper layers [8], which is not used to disable the function.

If the UE has UL resources allocated for new transmission for this TTI:

- if it is the first UL resource allocated for a new transmission since the last MAC reset, start *periodicPHR-Timer*.
- if the Power Headroom reporting procedure determines that at least one PHR has been triggered since the last transmission of a PHR r this is the first time that a PHR is triggered, and;
- if the allocated UL resources can accommodate a PHR MAC control element plus its subheader as a result of logical channel prioritization:
 - obtain the value of the power headroom from the physical layer;
 - instruct the Multiplexing and Assembly procedure to generate and transmit a PHR MAC control element based on the value reported by the physical layer;
 - start or restart *periodicPHR-Timer*;
 - start or restart *prohibitPHR-Timer*;
 - cancel all triggered PHR(s).

[TS 36.321, clause 6.1.3.6]

The Power Headroom MAC control element is identified by a MAC PDU sub header with LCID as specified in table 6.2.1-2. It has a fixed size and consists of a single octet defined as follows (figure 6.1.3.6-1):

- R: reserved bit, set to "0";
- Power Headroom(PH): this field indicates the power headroom level. The length of the field is 6 bits. The reported PH and the corresponding power headroom levels are shown in Table 6.1.3.6-1 below (the corresponding measured values in dB can be found in subclause 9.1.8.4 of [19])

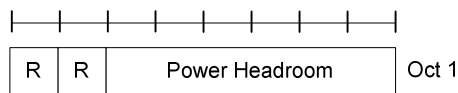

Figure 6.1.3.6-1: Power Headroom MAC control element

Table 6.1.3.6-1: Power Headroom levels for PHR

PH	Power Headroom Level
0	POWER_HEADROOM_0
1	POWER_HEADROOM_1
2	POWER_HEADROOM_2
3	POWER_HEADROOM_3
...	...
60	POWER_HEADROOM_60
61	POWER_HEADROOM_61
62	POWER_HEADROOM_62
63	POWER_HEADROOM_63

7.1.4.15.3 Test description

7.1.4.15.3.1 Pre-test conditions

System Simulator:

- Cell 1

UE:

None.

Preamble:

- The UE is in state Generic RB Established (state 3) on Cell 1 according to [18].

7.1.4.15.3.2 Test procedure sequence

Table 7.1.4.15.3.2-1: Main behaviour

St	Procedure	Message Sequence		TP	Verdict
		U - S	Message		
1	The SS is configured for Uplink Grant Allocation Type 2. The SS transmits UL grant for the UE at every TTI for FDD and every 5ms in a DL subframe for TDD.	-->	-	-	-
2	The SS transmits an <i>RRCCONNECTIONRECONFIGURATION</i> message to provide Power Headroom parameters	<--	-	-	-
3	Check: does the UE transmit a MAC PDU containing Power Headroom MAC Control Element?	-->	MAC PDU	1	P
4	The UE transmits an <i>RRCCONNECTIONRECONFIGURATIONCOMPLETE</i> message to confirm the setup of Power Headroom parameters.	-->	-	-	-
5	Check: does the UE transmit a MAC PDU containing Power Headroom MAC Control Element 200ms after step 3?	-->	MAC PDU	2	P
6	The SS transmits an <i>RRCCONNECTIONRECONFIGURATION</i> message to disable Power Headroom reporting	<--	-	-	-
7	The UE transmits an <i>RRCCONNECTIONRECONFIGURATIONCOMPLETE</i> message to confirm the disabling of Power Headroom parameters	-->	-	-	-
8	Check: for 2 seconds, does the UE transmit a MAC PDU containing Power Headroom MAC Control Element?	-->	MAC PDU	3	F

Note: Steps 3 and 4 can happen in 2 MAC PDU's, or may be combined in one MAC PDU.

7.1.4.15.3.3 Specific message contents

Table 7.1.4.15.3.3-1: RRCConnectionReconfiguration (step 2, Table 7.1.4.15.3.2-1)

Derivation path: 36.508 table 4.6.1-8			
Information Element	Value/Remark	Comment	Condition
RRCConnectionReconfiguration ::= SEQUENCE {			
criticalExtensions CHOICE {			
c1 CHOICE{			
rrcConnectionReconfiguration-r8 SEQUENCE {			
RadioResourceConfigDedicated SEQUENCE {			
mac-MainConfig CHOICE {			
explicitValue SEQUENCE {			
phr-Config CHOICE {			
setup SEQUENCE {			
periodicPHR-Timer	sf200		
prohibitPHR-Timer	sf1000		
dl-PathlossChange	infinity		
}			
}			
}			
}			
}			
}			
}			
}			
}			
}			
}			
}			

Table 7.1.4.15.3.3-2: RRCConnectionReconfiguration (step 6, Table 7.1.4.15.3.2-1)

Derivation path: 36.508 table 4.6.1-8			
Information Element	Value/Remark	Comment	Condition
RRCConnectionReconfiguration ::= SEQUENCE {			
criticalExtensions CHOICE {			
c1 CHOICE{			
rrcConnectionReconfiguration-r8 SEQUENCE {			
RadioResourceConfigDedicated SEQUENCE {			
mac-MainConfig CHOICE {			
explicitValue SEQUENCE {			
phr-Config CHOICE {			
release	NULL		
}			
}			
}			
}			
}			
}			
}			
}			
}			
}			

7.1.4.16 UE power headroom reporting / DL pathloss change reporting

7.1.4.16.1 Test Purpose (TP)

(1)

```

with { UE in E-UTRA RRC_Connected state with DRB established, Power headroom reporting for dl-
PathlossChange configured }
ensure that {
  when { the DL Pathloss has changed more than dl-PathlossChange dB and prohibitPHR-Timer is running
}
  then { UE does not transmit a MAC PDU containing Power Headroom MAC Control Element }
}

```

(2)

```

with { UE in E-UTRA RRC_Connected state with DRB established, Power headroom reporting for dl-
PathlossChange configured }
ensure that {
  when { prohibitPHR-Timer expires and power headroom report is triggered due to DL Pathloss change
}
  then { UE transmits a MAC PDU containing Power Headroom MAC Control Element }
}

```

7.1.4.16.2 Conformance requirements

References: The conformance requirements covered in the current TC are specified in: TS 36.321 clause 5.4.6 and 6.1.3.6

[TS 36.321, clause 5.4.6]

The Power Headroom reporting procedure is used to provide the serving eNB with information about the difference between the nominal UE maximum transmit power and the estimated power for UL-SCH transmission. The reporting period, delay and mapping of Power Headroom are defined in subclause 9.1.8 of [9]. RRC controls Power Headroom reporting by configuring the two timers *periodicPHR-Timer* and *prohibitPHR-Timer*, and by signalling *dl-PathlossChange* which sets the change in measured downlink pathloss to trigger a PHR [8].

A Power Headroom Report (PHR) shall be triggered if any of the following events occur:

- *prohibitPHR-Timer* expires or has expired and the path loss has changed more than *dl-PathlossChange* dB since the transmission of a PHR when UE has UL resources for new transmission;
- *periodicPHR-Timer* expires;
- upon configuration or reconfiguration of the power headroom reporting functionality by upper layers [8], which is not used to disable the function.

If the UE has UL resources allocated for new transmission for this TTI:

- if it is the first UL resource allocated for a new transmission since the last MAC reset, start *periodicPHR-Timer*;
- if the Power Headroom reporting procedure determines that at least one PHR has been triggered since the last transmission of a PHR or this is the first time that a PHR is triggered, and;
- if the allocated UL resources can accommodate a PHR MAC control element plus its subheader as a result of logical channel prioritization:
 - obtain the value of the power headroom from the physical layer;
 - instruct the Multiplexing and Assembly procedure to generate and transmit a PHR MAC control element based on the value reported by the physical layer;
 - start or restart *periodicPHR-Timer*;
 - start or restart *prohibitPHR-Timer*;
 - cancel all triggered PHR(s).

[TS 36.321, clause 6.1.3.6]

The Power Headroom MAC control element is identified by a MAC PDU sub header with LCID as specified in table 6.2.1-1. It has a fixed size and consists of a single octet defined as follows (figure 6.1.3.6-1):

- R: reserved bit, set to "0";
- Power Headroom (PH): this field indicates the power headroom level. The length of the field is 6 bits. The reported PH and the corresponding power headroom levels are shown in Table 6.1.3.6.1-1 below (the corresponding measured values in dB can be found in subclause 9.1.8.4 of [17]).

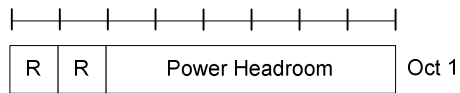

Figure 6.1.3.6-1: Power Headroom MAC control element

Table 6.1.3.6-1: Power Headroom levels for PHR

PH	Power Headroom Level
0	POWER_HEADROOM_0
1	POWER_HEADROOM_1
2	POWER_HEADROOM_2
3	POWER_HEADROOM_3
...	...
60	POWER_HEADROOM_60
61	POWER_HEADROOM_61
62	POWER_HEADROOM_62
63	POWER_HEADROOM_63

7.1.4.16.3 Test description

7.1.4.16.3.1 Pre-test conditions

System Simulator:

- Cell 1

UE:

None.

Preamble:

- The UE is in state Generic RB Established (state 3) on Cell 1 according to [18].

7.1.4.16.3.2 Test procedure sequence

Table 7.1.4.16.3.2-1: Main behaviour

St	Procedure	Message Sequence		TP	Verdict
		U - S	Message		
1	The SS is configured for Uplink Grant Allocation Type 2. SS is configured to transmit UL grant for UE at every TTI for FDD, and every 5ms in a DL subframe for TDD.	-	-	-	-
2	The SS transmits an <i>RRConnectionReconfiguration</i> message to provide Power Headroom parameters	<--	<i>RRConnectionReconfiguration</i>	-	-
3	The UE transmits an <i>RRConnectionReconfigurationComplete</i> message to confirm the setup of Power Headroom parameters.	-->	-	-	-
4	Wait for T1= 10% of <i>prohibitPHR-Timer</i> .	-	-	-	-
5	Reduce SS power level so as to cause a DL_Pathloss change at UE by 5dB.	-	-	-	-
6	Check: for 80% of <i>prohibitPHR-Timer</i> since step 3, does the UE transmit a MAC PDU containing Power Headroom MAC Control Element?	-->	MAC PDU	1	F
7	Check: after <i>prohibitPHR-Timer</i> after step 3, does the UE transmit a MAC PDU containing Power Headroom MAC Control Element?	-->	MAC PDU	2	P
8	Increase SS power level so as to cause a DL_Pathloss change at UE by 5dB.	-	-	-	-
9	Check: for 80% of <i>prohibitPHR-Timer</i> since step 7, does the UE transmit a MAC PDU containing Power Headroom MAC Control Element?	-->	MAC PDU	1	F
10	Check: after <i>prohibitPHR-Timer</i> after step 7, does the UE transmit a MAC PDU containing Power Headroom MAC Control Element?	-->	MAC PDU	2	P
Note: Steps 3 in main behaviour and step 1 in parallel behaviour can happen in 2 MAC PDU's, or may be combined in one MAC PDU.					

Table 7.1.4.16.3.2-2: Parallel behaviour

St	Procedure	Message Sequence		TP	Verdict
		U - S	Message		
1	The UE transmits a MAC PDU containing Power Headroom MAC Control Element.	-->	MAC PDU	-	-

7.1.4.16.3.3 Specific message contents

Table 7.1.4.16.3.3-1: RRCConnectionReconfiguration (step 2, Table 7.1.4.16.3.2-1)

Derivation path: 36.508 table 4.6.1-8			
Information Element	Value/Remark	Comment	Condition
RRCConnectionReconfiguration ::= SEQUENCE {			
criticalExtensions CHOICE {			
c1 CHOICE{			
rrcConnectionReconfiguration-r8 SEQUENCE {			
RadioResourceConfigDedicated SEQUENCE {			
mac-MainConfig CHOICE {			
explicitValue SEQUENCE {			
phr-Config CHOICE {			
setup SEQUENCE {			
periodicPHR-Timer	infinity		
prohibitPHR-Timer	sf1000		
dl-PathlossChange	dB3		
}			
}			
}			
}			
}			
}			
}			
}			
}			
}			
}			
}			
}			
}			
}			
}			

7.1.4.17

7.1.4.18 CA / Correct handling of MAC control information / Buffer Status / UL data arrive in the UE Tx buffer / Extended buffer size

7.1.4.18.1 Test Purpose (TP)

(1)

```

with { UE in E-UTRA RRC_CONNECTED state with DRB established, and ExtendedBSR-Size is configured in RRCConnectionReconfiguration procedure }
ensure that {
  when { UL data arrives in the UE transmission buffer }
  then { UE transmits a MAC PDU containing 'Buffer Status Report' MAC control element with Extended Buffer size }
}

```

7.1.4.18.2 Conformance requirements

References: The conformance requirements covered in the current TC are specified in: TS36.321, clause 5.4.3 ,5.4.5 and 6.1.3.1.

[36.321, clause 5.4.3.1]

...

For the Logical Channel Prioritization procedure, the UE shall take into account the following relative priority in decreasing order:

- MAC control element for C-RNTI or data from UL-CCCH;
- MAC control element for BSR, with exception of BSR included for padding;
- MAC control element for PHR or Extended PHR;
- data from any Logical Channel, except data from UL-CCCH;
- MAC control element for BSR included for padding.

...

[36.321, clause 5.4.5]

...

A MAC PDU shall contain at most one MAC BSR control element, even when multiple events trigger a BSR by the time a BSR can be transmitted in which case the Regular BSR and the Periodic BSR shall have precedence over the padding BSR.

The UE shall restart *retxBSR-Timer* upon indication of a grant for transmission of new data on any UL-SCH.

All triggered BSRs shall be cancelled in case the UL grant(s) in this subframe can accommodate all pending data available for transmission but is not sufficient to additionally accommodate the BSR MAC control element plus its subheader. All triggered BSRs shall be cancelled when a BSR is included in a MAC PDU for transmission.

The UE shall transmit at most one Regular/Periodic BSR in a TTI. If the UE is requested to transmit multiple MAC PDUs in a TTI, it may include a padding BSR in any of the MAC PDUs which do not contain a Regular/Periodic BSR.

All BSRs transmitted in a TTI always reflect the buffer status after all MAC PDUs have been built for this TTI. Each LCG shall report at the most one buffer status value per TTI and this value shall be reported in all BSRs reporting buffer status for this LCG.

NOTE: A Padding BSR is not allowed to cancel a triggered Regular/Periodic BSR. A Padding BSR is triggered for a specific MAC PDU only and the trigger is cancelled when this MAC PDU has been built.

[36.321, clause 6.1.3.1]

Buffer Status Report (BSR) MAC control elements consist of either:

- Short BSR and Truncated BSR format: one LCG ID field and one corresponding Buffer Size field (figure 6.1.3.1-1); or
- Long BSR format: four Buffer Size fields, corresponding to LCG IDs #0 through #3 (figure 6.1.3.1-2).

The BSR formats are identified by MAC PDU subheaders with LCIDs as specified in table 6.2.1-2.

The fields LCG ID and Buffer Size are defined as follow:

- LCG ID: The Logical Channel Group ID field identifies the group of logical channel(s) which buffer status is being reported. The length of the field is 2 bits;
- Buffer Size: The Buffer Size field identifies the total amount of data available across all logical channels of a logical channel group after all MAC PDUs for the TTI have been built. The amount of data is indicated in number of bytes. It shall include all data that is available for transmission in the RLC layer and in the PDCP layer; the definition of what data shall be considered as available for transmission is specified in [3] and [4] respectively. The size of the RLC and MAC headers are not considered in the buffer size computation. The length of this field is 6 bits. If *extendedBSR-Sizes* is not configured, the values taken by the Buffer Size field are shown in Table 6.1.3.1-1. If *extendedBSR-Sizes* is configured, the values taken by the Buffer Size field are shown in Table 6.1.3.1-2.

...

Table 6.1.3.1-2: Extended Buffer size levels for BSR

Index	Buffer Size (BS) value [bytes]	Index	Buffer Size (BS) value [bytes]
0	BS = 0	32	4940 < BS ≤ 6074
1	0 < BS ≤ 10	33	6074 < BS ≤ 7469
2	10 < BS ≤ 13	34	7469 < BS ≤ 9185
3	13 < BS ≤ 16	35	9185 < BS ≤ 11294
4	16 < BS ≤ 19	36	11294 < BS ≤ 13888
5	19 < BS ≤ 23	37	13888 < BS ≤ 17077
6	23 < BS ≤ 29	38	17077 < BS ≤ 20999
7	29 < BS ≤ 35	39	20999 < BS ≤ 25822
8	35 < BS ≤ 43	40	25822 < BS ≤ 31752
9	43 < BS ≤ 53	41	31752 < BS ≤ 39045
10	53 < BS ≤ 65	42	39045 < BS ≤ 48012
11	65 < BS ≤ 80	43	48012 < BS ≤ 59039
12	80 < BS ≤ 98	44	59039 < BS ≤ 72598
13	98 < BS ≤ 120	45	72598 < BS ≤ 89272
14	120 < BS ≤ 147	46	89272 < BS ≤ 109774
15	147 < BS ≤ 181	47	109774 < BS ≤ 134986
16	181 < BS ≤ 223	48	134986 < BS ≤ 165989
17	223 < BS ≤ 274	49	165989 < BS ≤ 204111
18	274 < BS ≤ 337	50	204111 < BS ≤ 250990
19	337 < BS ≤ 414	51	250990 < BS ≤ 308634
20	414 < BS ≤ 509	52	308634 < BS ≤ 379519
21	509 < BS ≤ 625	53	379519 < BS ≤ 466683
22	625 < BS ≤ 769	54	466683 < BS ≤ 573866
23	769 < BS ≤ 945	55	573866 < BS ≤ 705666
24	945 < BS ≤ 1162	56	705666 < BS ≤ 867737
25	1162 < BS ≤ 1429	57	867737 < BS ≤ 1067031
26	1429 < BS ≤ 1757	58	1067031 < BS ≤ 1312097
27	1757 < BS ≤ 2161	59	1312097 < BS ≤ 1613447
28	2161 < BS ≤ 2657	60	1613447 < BS ≤ 1984009
29	2657 < BS ≤ 3267	61	1984009 < BS ≤ 2439678
30	3267 < BS ≤ 4017	62	2439678 < BS ≤ 3000000
31	4017 < BS ≤ 4940	63	BS > 3000000

7.1.4.18.3 Test description

7.1.4.18.3.1 Pre-test conditions

System Simulator:

- Cell 1

UE:

None.

Preamble:

- The UE is in state Loopback Activated (state 4) according to [18].
- The condition SRB2-DRB (1, 0) is used for step 8 in 4.5.3A.3 according to [18].

7.1.4.18.3.2 Definition of system information messages

Table 7.1.4.18.3.2-1: Main behaviour

St	Procedure	Message Sequence		TP	Verdict
		U - S	Message		
1	Void	-	-	-	-
2	Void	-	-	-	-
3	The SS transmits a MAC PDU containing an RLC SDU of size 60 bytes.	<--	MAC PDU(RLC SDU)	-	-
4	The UE transmit a scheduling request.	-->	(SR)	-	-
5	The SS respond to the scheduling request in step 4 by an UL Grant of 32 bits.	<--	(UL Grant, 32 bits)	-	-
6	Check: Does The UE transmit a short BSR with 'Buffer size' field set to '10'?	-->	MAC PDU (MAC Short BSR (Buffer Size='10'))	1	P
7	The SS is configured for Uplink Grant Allocation Type 3. The SS sends an uplink grant of size 520 bits.	<--	(UL grant)	-	-
8	UE transmits a MAC PDU containing a RLC SDU.	-->	MAC PDU(RLC SDU)	-	-

7.1.4.18.3.3 Specific message contents

Table 7.1.4.18.3.3-1: RRCConnectionReconfiguration (Preamble)

Derivation path: 36.508 table 4.6.1-8			
Information Element	Value/Remark	Comment	Condition
RRCConnectionReconfiguration ::= SEQUENCE {			
criticalExtensions CHOICE {			
c1 CHOICE{			
rrcConnectionReconfiguration-r8 SEQUENCE {			
RadioResourceConfigDedicated SEQUENCE {			
mac-MainConfig-v1020 CHOICE {			
extendedBSR-Sizes-r10	Setup		
}			
}			
}			
}			
}			

7.1.4.19 CA / UE power headroom reporting / SCell activation and DL pathloss change reporting / Extended PHR

7.1.4.19.1 CA / UE power headroom reporting / SCell activation and DL pathloss change reporting / Extended PHR / Intra-band Contiguous CA

7.1.4.19.1 Test Purpose (TP)

(1)

```
with { UE in E-UTRA RRC_Connected state with DRB established, Extended Power headroom reporting and an SCell with uplink addition configured }
ensure that {
  when { UE receives an Activation MAC Control Element activating the SCell }
  then { UE transmits a MAC PDU containing Extended Power Headroom MAC Control Element }
}
```

(2)

```
with { UE in E-UTRA RRC_Connected state with DRB established, Extended Power headroom reporting for DL_Pathloss change configured }
ensure that {
  when { the DL Pathloss changes and prohibitPHR-Timer is running }
  then { UE does not transmit a MAC PDU containing Extended Power Headroom MAC Control Element }
}
```

(3)

```

with { UE in E-UTRA RRC_Connected state with DRB established, Extended Power headroom reporting for
DL_Pathloss change configured }
ensure that {
  when { prohibitPHR-Timer expires and extended power headroom report is triggered due to DL
Pathloss change }
  then { UE transmits a MAC PDU containing Extended Power Headroom MAC Control Element }
}

```

7.1.4.19.1.2 Conformance requirements

References: The conformance requirements covered in the current TC are specified in: TS 36.321 clause 5.4.6 and 6.1.3.6a

[TS 36.321, clause 5.4.6]

The Power Headroom reporting procedure is used to provide the serving eNB with information about the difference between the nominal UE maximum transmit power and the estimated power for UL-SCH transmission per activated Serving Cell and also with information about the difference between the nominal UE maximum power and the estimated power for UL-SCH and PUCCH transmission on PCell.

The reporting period, delay and mapping of Power Headroom are defined in subclause 9.1.8 of [9]. RRC controls Power Headroom reporting by configuring the two timers *periodicPHR-Timer* and *prohibitPHR-Timer*, and by signalling *dl-PathlossChange* which sets the change in measured downlink pathloss and the required power backoff due to power management (as allowed by P-MPRc [10]) to trigger a PHR [8].

A Power Headroom Report (PHR) shall be triggered if any of the following events occur:

- *prohibitPHR-Timer* expires or has expired and the path loss has changed more than *dl-PathlossChange* dB for at least one activated Serving Cell which is used as a pathloss reference since the last transmission of a PHR when the UE has UL resources for new transmission;
- *periodicPHR-Timer* expires;
- upon configuration or reconfiguration of the power headroom reporting functionality by upper layers [8], which is not used to disable the function;
- activation of an SCell with configured uplink.
- *prohibitPHR-Timer* expires or has expired, when the UE has UL resources for new transmission, and the following is true in this TTI for any of the active Serving Cells with configured uplink:
 - there are UL resources allocated for transmission or there is a PUCCH transmission on this cell, and the required power backoff due to power management (as allowed by P-MPRc [10]) for this cell has changed more than *dl-PathlossChange* dB since the last transmission of a PHR when the UE had UL resources allocated for transmission or PUCCH transmission on this cell.

NOTE: The UE should avoid triggering a PHR when the required power backoff due to power management decreases only temporarily (e.g. for up to a few tens of milliseconds) and it should avoid reflecting such temporary decrease in the values of $P_{\text{CMAX},c}/\text{PH}$ when a PHR is triggered by other triggering conditions.

If the UE has UL resources allocated for new transmission for this TTI:

- if it is the first UL resource allocated for a new transmission since the last MAC reset, start *periodicPHR-Timer*;
- if the Power Headroom reporting procedure determines that at least one PHR has been triggered since the last transmission of a PHR or this is the first time that a PHR is triggered, and;
- if the allocated UL resources can accommodate a PHR MAC control element plus its subheader if *extendedPHR* is not configured, or the Extended PHR MAC control element plus its subheader if *extendedPHR* is configured, as a result of logical channel prioritization:
 - if *extendedPHR* is configured:
 - for each activated Serving Cell with configured uplink:

- obtain the value of the Type 1 power headroom;
- if the UE has UL resources allocated for transmission on this Serving Cell for this TTI:
 - obtain the value for the corresponding $P_{\text{CMAX},c}$ field from the physical layer;
- if *simultaneousPUCCH-PUSCH* is configured:
 - obtain the value of the Type 2 power headroom for the PCell;
 - if the UE has a PUCCH transmission in this TTI:
 - obtain the value for the corresponding $P_{\text{CMAX},c}$ field from the physical layer;
- instruct the Multiplexing and Assembly procedure to generate and transmit an Extended PHR MAC control element as defined in subclause 6.1.3.6a based on the values reported by the physical layer;
- else:
 - obtain the value of the Type 1 power headroom from the physical layer;
 - instruct the Multiplexing and Assembly procedure to generate and transmit a PHR MAC control element as defined in subclause 6.1.3.6 based on the value reported by the physical layer;
- start or restart *periodicPHR-Timer*;
- start or restart *prohibitPHR-Timer*;
- cancel all triggered PHR(s).

[TS 36.321, clause 6.1.3.6a]

The Extended Power Headroom MAC control element is identified by a MAC PDU subheader with LCID as specified in table 6.2.1-2. It has a variable size and is defined in Figure 6.1.3.6a-2. When Type 2 PH is reported, the octet containing the Type 2 PH field is included first after the octet indicating the presence of PH per SCell and followed by an octet containing the associated $P_{\text{CMAX},c}$ field (if reported). Then follows in ascending order based on the *ServCellIndex* [8] an octet with the Type 1 PH field and an octet with the associated $P_{\text{CMAX},c}$ field (if reported), for the PCell and for each SCell indicated in the bitmap.

The Extended Power Headroom MAC Control Element is defined as follows:

- C_i : this field indicates the presence of a PH field for the SCell with *SCellIndex* i as specified in [8]. The C_i field set to "1" indicates that a PH field for the SCell with *SCellIndex* i is reported. The C_i field set to "0" indicates that a PH field for the SCell with *SCellIndex* i is not reported;
- R: reserved bit, set to "0";
- V: this field indicates if the PH value is based on a real transmission or a reference format. For Type 1 PH, V=0 indicates real transmission on PUSCH and V=1 indicates that a PUSCH reference format is used. For Type 2 PH, V=0 indicates real transmission on PUCCH and V=1 indicates that a PUCCH reference format is used. Furthermore, for both Type 1 and Type 2 PH, V=0 indicates the presence of the associated $P_{\text{CMAX},c}$ field, and V=1 indicates that the associated $P_{\text{CMAX},c}$ field is omitted;
- Power Headroom (PH): this field indicates the power headroom level. The length of the field is 6 bits. The reported PH and the corresponding power headroom levels are shown in Table 6.1.3.6-1 (the corresponding measured values in dB can be found in subclause 9.1.8.4 of [9]);
- P: this field indicates whether the UE applies power backoff due to power management (as allowed by P-MPR [10]). The UE shall set P=1 if the corresponding $P_{\text{CMAX},c}$ field would have had a different value if no power backoff due to power management had been applied;
- $P_{\text{CMAX},c}$: if present, this field indicates the $P_{\text{CMAX},c}$ or $\tilde{P}_{\text{CMAX},c}$ [2] used for calculation of the preceding PH field. The reported $P_{\text{CMAX},c}$ and the corresponding nominal UE transmit power levels are shown in Table 6.1.3.6a-1 (the corresponding measured values in dBm can be found in subclause 9.6.1 of [9]).

Figure 6.1.3.6a-1: Void

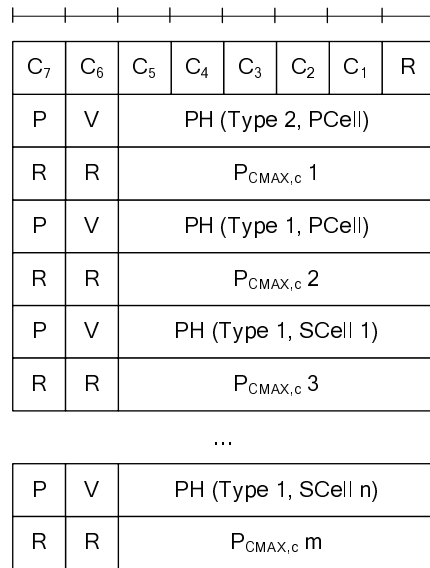

Figure 6.1.3.6a-2: Extended Power Headroom MAC Control Element

Table 6.1.3.6a-1: Nominal UE transmit power level for Extended PHR

P _{CMAX,c}	Nominal UE transmit power level
0	PCMAX_C_00
1	PCMAX_C_01
2	PCMAX_C_02
...	...
61	PCMAX_C_61
62	PCMAX_C_62
63	PCMAX_C_63

7.1.4.19.1.3 Test description

7.1.4.19.1.3.1 Pre-test conditions

System Simulator:

- Cell 1 is the PCell, Cell 3 is the SCell to be added
- Cell 3 is an Active SCell according to [18] cl. 6.3.4

UE:

None.

Preamble:

- The UE is in state Generic RB Established (state 3) on Cell 1 according to [18].

7.1.4.19.1.3.2 Test procedure sequence

Table 7.1.4.19.1.3.2-1: Main behaviour

St	Procedure	Message Sequence		TP	Verdict
		U - S	Message		
1	The SS transmits an <i>RRCCONNECTIONRECONFIGURATION</i> message with SCell (Cell 3) addition	<--	<i>RRCCONNECTIONRECONFIGURATION</i>	-	-
2	The UE transmits an <i>RRCCONNECTIONRECONFIGURATIONCOMPLETE</i> message to confirm SCell (Cell 3) addition.	-->	<i>RRCCONNECTIONRECONFIGURATIONCOMPLETE</i>	-	-
3	The SS is configured for Uplink Grant Allocation Type 2. SS is configured to transmit UL grant for UE at every TTI for FDD, and every 5ms in a DL subframe for TDD.	-	-	-	-
4	The SS transmits an <i>RRCCONNECTIONRECONFIGURATION</i> message to provide Extended Power Headroom parameters	<--	<i>RRCCONNECTIONRECONFIGURATION</i>	-	-
	EXCEPTION: In parallel with step 5, UE executes parallel behaviour defined in table 7.1.4.19.1.3.2-2	-	-	-	-
5	The UE transmits an <i>RRCCONNECTIONRECONFIGURATIONCOMPLETE</i> message to confirm the setup of Extended Power Headroom parameters	-->	<i>RRCCONNECTIONRECONFIGURATIONCOMPLETE</i>	-	-
6	The SS transmits an Activation MAC control element to activate SCell (Cell 3).	<--	MAC PDU (Activation (C ₁ =1))	-	-
7	Check: Does the UE transmit a MAC PDU containing Extended Power Headroom MAC Control Element?	-->	MAC PDU	1	P
8	Wait for T1= 10% of <i>prohibitPHR-Timer</i> .	-	-	-	-
9	Reduce the PCell (Cell 1) power level so as to cause a DL_Pathloss change at UE by 5dB.	-	-	-	-
10	Check: for 80% of <i>prohibitPHR-Timer</i> since step 7, does the UE transmit a MAC PDU containing Extended Power Headroom MAC Control Element?	-->	MAC PDU	2	F
11	Check: after <i>prohibitPHR-Timer</i> after step 7, does the UE transmit a MAC PDU containing Extended Power Headroom MAC Control Element?	-->	MAC PDU	3	P
12	Increase the PCell (Cell 1) power level so as to cause a DL_Pathloss change at UE by 5dB.	-	-	-	-
13	Check: for 80% of <i>prohibitPHR-Timer</i> since step 11, does the UE transmit a MAC PDU containing Extended Power Headroom MAC Control Element?	-->	MAC PDU	2	F
14	Check: after <i>prohibitPHR-Timer</i> after step 11, does the UE transmit a MAC PDU containing Extended Power Headroom MAC Control Element?	-->	MAC PDU	3	P
15	Reduce the SCell (Cell 3) power level so as to cause a DL_Pathloss change at UE by 5dB.	-	-	-	-
16	Check: for 80% of <i>prohibitPHR-Timer</i> since step 14, does the UE transmit a MAC PDU containing Extended Power Headroom MAC Control Element?	-->	MAC PDU	2	F
17	Check: after <i>prohibitPHR-Timer</i> after step 14, does the UE transmit a MAC PDU containing Extended Power Headroom MAC Control Element?	-->	MAC PDU	3	P
18	Increase the SCell (Cell 3) power level so as to cause a DL_Pathloss change at UE by 5dB.	-	-	-	-
19	Check: for 80% of <i>prohibitPHR-Timer</i> since step 17, does the UE transmit a MAC PDU	-->	MAC PDU	2	F

	containing Extended Power Headroom MAC Control Element?				
20	Check: after <i>prohibitPHR-Timer</i> after step 17, does the UE transmit a MAC PDU containing Extended Power Headroom MAC Control Element?	-->	MAC PDU	3	P

Table 7.1.4.19.1.3.2-2: Parallel behaviour

St	Procedure	Message Sequence		TP	Verdict
		U - S	Message		
1	The UE transmits a MAC PDU containing Extended Power Headroom MAC Control Element.	-->	MAC PDU	-	-

7.1.4.19.1.3.3 Specific message contents

Table 7.1.4.19.1.3.3-1: RRCConnectionReconfiguration (step 4, Table 7.1.4.19.1.3.2-1)

Derivation path: 36.508 table 4.6.1-8 condition SCell_AddMod			
Information Element	Value/Remark	Comment	Condition
RRCConnectionReconfiguration ::= SEQUENCE {			
criticalExtensions CHOICE {			
c1 CHOICE{			
rrcConnectionReconfiguration-r8 SEQUENCE {			
RadioResourceConfigDedicated SEQUENCE {			
mac-MainConfig CHOICE {			
explicitValue SEQUENCE {			
phr-Config CHOICE {			
setup SEQUENCE {			
periodicPHR-Timer	infinity		
prohibitPHR-Timer	sf1000		
dl-PathlossChange	dB3		
}			
}			
}			
mac-MainConfig-v1020 SEQUENCE {			
extendedPHR-r10	setup		
}			
}			
}			
}			
}			
}			

7.1.4.19.2 CA / UE power headroom reporting / SCell activation and DL pathloss change reporting / Extended PHR / Inter-band CA

The scope and description of the present TC is the same as test case 7.1.4.19.1 with the following differences:

- CA configuration: Inter-band CA replaces Intra-band Contiguous CA
- Cells configuration: Cell 10 replaces Cell 3
- Cell 10 is an Active SCell according to [18] cl. 6.3.4.

7.1.4.20 CA / Correct handling of MAC control information / Buffer status

7.1.4.20.1 CA / Correct handling of MAC control information / Buffer status / Intra-band Contiguous CA

7.1.4.20.1.1 Test Purpose (TP)

(1)

```
with { UE in E-UTRA RRC_CONNECTED state with SCell configured and activated }
ensure that {
  when { UL data arrives in the UE transmission buffer and UE is scheduled to transmit on both PCell
and SCell in a TTI }
    then { UE transmits two MAC PDUs in a TTI, and one of the MAC PDU includes a Regular BSR,
another MAC PDU includes a padding BSR }
}
```

(2)

```
with { UE in E-UTRA RRC_CONNECTED state }
ensure that {
  when { UE transmits a MAC PDU and the number of padding bits is equal to or larger than the size of
a Long BSR plus its subheader }
    then { UE reports a long BSR }
}
```

(3)

```
with { UE in E-UTRA RRC_CONNECTED state with SCell configured and activated }
ensure that {
  when { periodicBSR-Timer expires and UE is scheduled to transmit on both PCell and SCell in a TTI
}
    then { UE transmits two MAC PDUs in a TTI, and one of the MAC PDU includes a Periodic BSR,
another MAC PDU includes a padding BSR }
}
```

7.1.4.20.1.2 Conformance requirements

References: The conformance requirements covered in the current TC are specified in: TS 36.321, clause 5.4.3.1 and 5.4.5.

[TS 36.321 clause 5.4.3.1]

For the Logical Channel Prioritization procedure, the UE shall take into account the following relative priority in decreasing order:

- MAC control element for C-RNTI or data from UL-CCCH;
- MAC control element for BSR, with exception of BSR included for padding;
- MAC control element for PHR or Extended PHR;
- data from any Logical Channel, except data from UL-CCCH;
- MAC control element for BSR included for padding.

NOTE: When the UE is requested to transmit multiple MAC PDUs in one TTI, steps 1 to 3 and the associated rules may be applied either to each grant independently or to the sum of the capacities of the grants. Also the order in which the grants are processed is left up to UE implementation. It is up to the UE implementation to decide in which MAC PDU a MAC control element is included when UE is requested to transmit multiple MAC PDUs in one TTI.

[TS 36.321 clause 5.4.5]

The Buffer Status reporting procedure is used to provide the serving eNB with information about the amount of data available for transmission in the UL buffers of the UE. RRC controls BSR reporting by configuring the two timers *periodicBSR-Timer* and *retxBSR-Timer* and by, for each logical channel, optionally signalling *logicalChannelGroup* which allocates the logical channel to an LCG [8].

For the Buffer Status reporting procedure, the UE shall consider all radio bearers which are not suspended and may consider radio bearers which are suspended.

A Buffer Status Report (BSR) shall be triggered if any of the following events occur:

- UL data, for a logical channel which belongs to a LCG, becomes available for transmission in the RLC entity or in the PDCP entity (the definition of what data shall be considered as available for transmission is specified in [3] and [4] respectively) and either the data belongs to a logical channel with higher priority than the priorities of the logical channels which belong to any LCG and for which data is already available for transmission, or there is no data available for transmission for any of the logical channels which belong to a LCG, in which case the BSR is referred below to as "Regular BSR";
- UL resources are allocated and number of padding bits is equal to or larger than the size of the Buffer Status Report MAC control element plus its subheader, in which case the BSR is referred below to as "Padding BSR";
- *retxBSR-Timer* expires and the UE has data available for transmission for any of the logical channels which belong to a LCG, in which case the BSR is referred below to as "Regular BSR";
- *periodicBSR-Timer* expires, in which case the BSR is referred below to as "Periodic BSR".

For Regular and Periodic BSR:

- if more than one LCG has data available for transmission in the TTI where the BSR is transmitted: report Long BSR;
- else report Short BSR.

For Padding BSR:

- if the number of padding bits is equal to or larger than the size of the Short BSR plus its subheader but smaller than the size of the Long BSR plus its subheader:
 - if more than one LCG has data available for transmission in the TTI where the BSR is transmitted: report Truncated BSR of the LCG with the highest priority logical channel with data available for transmission;
 - else report Short BSR.
- else if the number of padding bits is equal to or larger than the size of the Long BSR plus its subheader, report Long BSR.

If the Buffer Status reporting procedure determines that at least one BSR has been triggered and not cancelled:

- if the UE has UL resources allocated for new transmission for this TTI:
 - instruct the Multiplexing and Assembly procedure to generate the BSR MAC control element(s);
 - start or restart *periodicBSR-Timer* except when all the generated BSRs are Truncated BSRs;
 - start or restart *retxBSR-Timer*.
- else if a Regular BSR has been triggered:
 - if an uplink grant is not configured or the Regular BSR was not triggered due to data becoming available for transmission for a logical channel for which logical channel SR masking (*logicalChannelSR-Mask*) is setup by upper layers:
 - a Scheduling Request shall be triggered.

A MAC PDU shall contain at most one MAC BSR control element, even when multiple events trigger a BSR by the time a BSR can be transmitted in which case the Regular BSR and the Periodic BSR shall have precedence over the padding BSR.

The UE shall restart *retxBSR-Timer* upon indication of a grant for transmission of new data on any UL-SCH.

All triggered BSRs shall be cancelled in case the UL grant(s) in this subframe can accommodate all pending data available for transmission but is not sufficient to additionally accommodate the BSR MAC control element plus its subheader. All triggered BSRs shall be cancelled when a BSR is included in a MAC PDU for transmission.

The UE shall transmit at most one Regular/Periodic BSR in a TTI. If the UE is requested to transmit multiple MAC PDUs in a TTI, it may include a padding BSR in any of the MAC PDUs which do not contain a Regular/Periodic BSR.

All BSRs transmitted in a TTI always reflect the buffer status after all MAC PDUs have been built for this TTI. Each LCG shall report at the most one buffer status value per TTI and this value shall be reported in all BSRs reporting buffer status for this LCG.

NOTE: A Padding BSR is not allowed to cancel a triggered Regular/Periodic BSR. A Padding BSR is triggered for a specific MAC PDU only and the trigger is cancelled when this MAC PDU has been built.

7.1.4.20.1.3 Test description

7.1.4.20.1.3.1 Pre-test conditions

System Simulator :

- Cell 1(PCell), Cell 3 (SCell)
- Cell 3 is an Active SCell according to [18] cl. 6.3.4.
- RRC Connection Reconfiguration (preamble: Table 4.5.3.3-1, step 8) using parameters as specified in Table 7.1.4.20.1.3.3-1

UE:

None.

Preamble:

- The UE is in state Loopback Activated (state 4) according to [18].
- The condition SRB2-DRB(2,0) is used for step 8 in 4.5.3A.3 according to [18].
- 2 AM DRBS are configured with the parameters specified in table 7.1.4.20.1-1.

Table 7.1.4.20.1-1: Logical Channel Configuration Settings

Parameter	DRB1	DRB2
LogicalChannel-Identity	3	4
Priority	7	6
prioritizedBitRate	0kbs	0kbs
logicalChannelGroup	2 (LCG ID#2)	1 (LCG ID#1)

7.1.4.20.1.3.2 Test procedure sequence

Table 7.1.4.20.1.3.2-1: Main behaviour

St	Procedure	Message Sequence		TP	Verdict
		U - S	Message		
1	The SS transmits an <i>RRCCConnectionReconfiguration</i> message with SCell (Cell 3) addition	<--	<i>RRCCConnectionReconfiguration</i>	-	-
2	The UE transmits an <i>RRCCConnectionReconfigurationComplete</i> message to confirm SCell (Cell 3) addition.	-->	<i>RRCCConnectionReconfigurationComplete</i>	-	-
3	The SS transmits an Activation MAC control element to activate SCell (Cell 3).	<--	MAC PDU (Activation (C ₁ =1))	-	-
-	EXCEPTION: Steps 4 and 5 shall be repeated for 2 times	-	-	-	-
4	The SS transmits a MAC PDU including an RLC SDU of size 12 bytes.	<--	MAC PDU (RLC SDU on LC3)	-	-
5	The SS transmits a MAC PDU including an RLC SDU of size 12 bytes.	<--	MAC PDU (RLC SDU on LC4)	-	-
6	UE transmits a Scheduling Request on PUCCH.	-->	(SR)	-	-
7	The SS sends two uplink grants with same size of 136 bits for Cell 1 and Cell 3 in the same TTI (Note2)	<--	(UL grant)	-	-
8	Check: Does the UE transmit a MAC PDU containing an RLC SDU and a short BSR and another MAC PDU containing an RLC SDU and a padding BSR in a TTI?	-->	MAC PDU (Short BSR header (LCID='11101'), MAC sub-header (E='0', F='0'), Short BSR, AMD PDU), MAC PDU (Short BSR header (LCID='11101'), MAC sub-header (E='0', F='0'), Short BSR, AMD PDU)	1	P
8a	The SS transmits a MAC PDU containing RLC status PDU acknowledging reception of RLC PDUs in step 8	<--	MAC PDU	-	-
9	The SS sends two uplink grants with same size of 152 bits for both Cell 1 and Cell 3 in the same TTI (Note 3)	<--	(UL grant)	-	-
10	Check: Does the UE transmit two MAC PDUs, both containing an RLC SDU and a long padding BSR in a TTI?	-->	MAC PDU (Long BSR header (LCID='11110'), MAC sub-header, Long BSR, RLC SDU) MAC PDU (Long BSR header (LCID='11110'), Long BSR, RLC SDU)	2	P
10a	The SS transmits a MAC PDU containing RLC status PDU acknowledging reception of RLC PDUs in step 10	<--	MAC PDU	-	-
-	EXCEPTION: Steps 11 and 12 shall be repeated for 2 times	-	-	-	-
11	The SS transmits a MAC PDU including an RLC SDU of size 12 bytes.	<--	MAC PDU (RLC SDU on LC3)	-	-
12	The SS transmits a MAC PDU including an RLC SDU of size 12 bytes.	<--	MAC PDU (RLC SDU on LC4)	-	-
13	UE transmits a Scheduling Request on PUCCH.	-->	(SR)	-	-
14	The SS is configured for Uplink Grant Allocation Type 2. The SS sends an uplink grant of size 32 bits.(Note 1)	<--	(UL grant)	-	-
15	The UE transmits a long BSR report with 'Buffer size#1' (LCG ID=1) and 'Buffer size#2' (LCG ID=2) fields set to value > '0'	-->	MAC PDU (('Buffer size#1 index' > 0, 'Buffer size#2 index=' >0')	-	-
16	Wait for periodicBSR-Timer expiry.	-	-	-	-
17	The SS sends two uplink grants with same size of 136 bits for Cell 1 and Cell 3 in the same TTI (Note2)	<--	(UL grant)	-	-

18	Check: Does UE transmit a MAC PDU containing a Short BSR with 'LCG ID' field set to '10' (logicalChannelGroup 1) and Buffer Size Index > 0 and another MAC PDU containing an RLC SDU and a padding BSR in a TTI?	-->	MAC PDU (Short BSR header (LCID='11101'), Short BSR, (LCG ID= '10', Buffer Size index > 0), AMD PDU) MAC PDU (Short BSR, (LCID='11101'),MAC sub-header, Short BSR,AMD PDU)	3	P
18a	The SS transmits a MAC PDU containing RLC status PDU acknowledging reception of RLC PDUs in step 18	<--	MAC PDU	-	-
19	The SS sends two uplink grants with same size of 152 bits for both Cell 1 and Cell 3 in the same TTI (Note 3)	<--	(UL grant)	-	-
20	Check: Does the UE transmit two MAC PDUs, both containing an RLC SDU and a long padding BSR in a TTI??	-->	MAC PDU (Long BSR header (LCID='11110'), Long BSR, RLC SDU) MAC PDU (Long BSR header (LCID='11110'), Long BSR, RLC SDU)	2	P
21	The SS transmits a MAC PDU containing RLC status PDU acknowledging reception of RLC PDUs in step 21	<--	MAC PDU	-	-
<p>Note 1: SS transmit an UL grant of 32 bits ($I_{TBS}=0$, $N_{PRB}=2$, TS 36.213 Table 7.1.7.2.1-1) to allow UE to transmit a Regular BSR triggered by the new data received logicalChannelGroup 1 and 2 in steps 2 and 3. This to enable testing of Padding BSR which has lower priority than Regular BSR.</p> <p>Note 2: UL grant of 136 bits ($I_{TBS}=9$, $N_{PRB}=1$, TS 36.213 Table 7.1.7.2.1-1) is chosen such that the MAC PDU padding bits will be equal to or larger than the size of Short/Truncated BSR and smaller than Long BSR. RLC SDU size is 12 bytes, size of AMD PDU header is 2 bytes, size of MAC header is 2 bytes (1 byte for MAC SDU sub-header using R/R/E/LCID for last sub header and 1 byte for BSR sub-header) and size of Short BSR/Truncated BSR is one byte, i.e. setting UL grant to 17 bytes (136 bits) enable UE to include Short/Truncated BSR.</p> <p>Note 3: UL grant of 152 bits ($I_{TBS}=0$, $N_{PRB}=6$, TS 36.213 Table 7.1.7.2.1-1) is chosen such that the MAC PDU padding bits will be equal to or larger than the size of Long BSR. RLC SDU size is 12 bytes, size of AMD PDU header is 2 bytes, size of MAC header is 2 bytes (1 byte for MAC SDU sub-header using R/R/E/LCID for last sub header and 1 byte for BSR sub-header) and size of Long BSR is 3 bytes, i.e. setting UL grant to 19 bytes (152 bits) enable UE to include padding Long BSR.</p>					

7.1.4.20.1.3.3 Specific Message Contents

Table 7.1.4.20.1.3.3-1: RRCConnectionReconfiguration (preamble: Table 4.5.3.3-1, step 8)

Derivation path: 36.508 table 4.8.2.1.5-1			
Information Element	Value/Remark	Comment	Condition
RRCConnectionReconfiguration ::= SEQUENCE {			
criticalExtensions CHOICE {			
c1 CHOICE{			
rrcConnectionReconfiguration-r8 SEQUENCE {			
RadioResourceConfigDedicated SEQUENCE {			
mac-MainConfig CHOICE {			
explicit SEQUENCE {			
ul-SCH-Config SEQUENCE {			
maxHARQ-Tx	n5		
periodicBSR-Timer	sf10		
retxBSR-Timer	sf10240		
ttiBundling	FALSE		
}			
}			
}			
}			
}			
}			
}			

7.1.4.20.2 CA / Correct handling of MAC control information / Buffer status / Inter-band CA

The scope and description of the present TC is the same as test case 7.1.4.20.1 with the following differences:

- CA configuration: Inter-band CA replaces Intra-band Contiguous CA
- Cells configuration: Cell 10 replaces Cell 3
- Cell 10 is an Active SCell according to [18] cl. 6.3.4

7.1.4.21 CA / UE power headroom reporting / Extended PHR

7.1.4.21.1 Test Purpose (TP)

(1)

```
with { UE in E-UTRA RRC_CONNECTED state with DRB established Extended PHR reporting configured }
ensure that {
  when { periodicPHR-Timer is configured in RRCConnectionReconfiguration procedure }
  then { UE transmits a MAC PDU containing Extended Power Headroom MAC Control Element }
}
```

(2)

```
with { UE in E-UTRA RRC_CONNECTED state with DRB established, Extended PHR reporting configured }
ensure that {
  when { periodicPHR-Timer expires and UL resources allocated for new transmission }
  then { UE transmits a MAC PDU containing Extended Power Headroom MAC Control Element }
}
```

(3)

```
with { UE in E-UTRA RRC_CONNECTED state with DRB established }
ensure that {
  when { Extended power headroom reporting is disabled }
  then { UE stops transmitting Extended Power Headroom MAC Control Element }
}
```

7.1.4.21.2 Conformance requirements

References: The conformance requirements covered in the current TC are specified in: TS 36.321 clause 5.4.6 and 6.1.3.6a.

[TS 36.321, clause 5.4.6]

The Power Headroom reporting procedure is used to provide the serving eNB with information about the difference between the nominal UE maximum transmit power and the estimated power for UL-SCH transmission per activated Serving Cell and also with information about the difference between the nominal UE maximum power and the estimated power for UL-SCH and PUCCH transmission on PCell.

The reporting period, delay and mapping of Power Headroom are defined in subclause 9.1.8 of [9]. RRC controls Power Headroom reporting by configuring the two timers *periodicPHR-Timer* and *prohibitPHR-Timer*, and by signalling *dl-PathlossChange* which sets the change in measured downlink pathloss and the required power backoff due to power management (as allowed by P-MPRc [10]) to trigger a PHR [8].

A Power Headroom Report (PHR) shall be triggered if any of the following events occur:

- *prohibitPHR-Timer* expires or has expired and the path loss has changed more than *dl-PathlossChange* dB for at least one activated Serving Cell which is used as a pathloss reference since the last transmission of a PHR when the UE has UL resources for new transmission;
- *periodicPHR-Timer* expires;
- upon configuration or reconfiguration of the power headroom reporting functionality by upper layers [8], which is not used to disable the function;
- activation of an SCell with configured uplink.

- *prohibitPHR-Timer* expires or has expired, when the UE has UL resources for new transmission, and the following is true in this TTI for any of the active Serving Cells with configured uplink:
 - there are UL resources allocated for transmission or there is a PUCCH transmission on this cell, and the required power backoff due to power management (as allowed by P-MPR_c [10]) for this cell has changed more than *dl-PathlossChange* dB since the last transmission of a PHR when the UE had UL resources allocated for transmission or PUCCH transmission on this cell.

NOTE: The UE should avoid triggering a PHR when the required power backoff due to power management decreases only temporarily (e.g. for up to a few tens of milliseconds) and it should avoid reflecting such temporary decrease in the values of $P_{\text{CMAX},c}/\text{PH}$ when a PHR is triggered by other triggering conditions.

If the UE has UL resources allocated for new transmission for this TTI:

- if it is the first UL resource allocated for a new transmission since the last MAC reset, start *periodicPHR-Timer*;
- if the Power Headroom reporting procedure determines that at least one PHR has been triggered since the last transmission of a PHR or this is the first time that a PHR is triggered, and;
- if the allocated UL resources can accommodate a PHR MAC control element plus its subheader if *extendedPHR* is not configured, or the Extended PHR MAC control element plus its subheader if *extendedPHR* is configured, as a result of logical channel prioritization:
 - if *extendedPHR* is configured:
 - for each activated Serving Cell with configured uplink:
 - obtain the value of the Type 1 power headroom;
 - if the UE has UL resources allocated for transmission on this Serving Cell for this TTI:
 - obtain the value for the corresponding $P_{\text{CMAX},c}$ field from the physical layer;
 - if simultaneousPUCCH-PUSCH is configured:
 - obtain the value of the Type 2 power headroom for the PCell;
 - if the UE has a PUCCH transmission in this TTI:
 - obtain the value for the corresponding $P_{\text{CMAX},c}$ field from the physical layer;
 - instruct the Multiplexing and Assembly procedure to generate and transmit an Extended PHR MAC control element as defined in subclause 6.1.3.6a based on the values reported by the physical layer;
 - else:
 - obtain the value of the Type 1 power headroom from the physical layer;
 - instruct the Multiplexing and Assembly procedure to generate and transmit a PHR MAC control element as defined in subclause 6.1.3.6 based on the value reported by the physical layer;
 - start or restart *periodicPHR-Timer*;
 - start or restart *prohibitPHR-Timer*;
 - cancel all triggered PHR(s).

[TS 36.321, clause 6.1.3.6a]

The Extended Power Headroom MAC control element is identified by a MAC PDU subheader with LCID as specified in table 6.2.1-2. It has a variable size and is defined in Figure 6.1.3.6a-2. When Type 2 PH is reported, the octet containing the Type 2 PH field is included first after the octet indicating the presence of PH per SCell and followed by an octet containing the associated $P_{\text{CMAX},c}$ field (if reported). Then follows in ascending order based on the *ServCellIndex* [8] an octet with the Type 1 PH field and an octet with the associated $P_{\text{CMAX},c}$ field (if reported), for the PCell and for each SCell indicated in the bitmap.

The Extended Power Headroom MAC Control Element is defined as follows:

- C_i : this field indicates the presence of a PH field for the SCell with $SCellIndex$ i as specified in [8]. The C_i field set to "1" indicates that a PH field for the SCell with $SCellIndex$ i is reported. The C_i field set to "0" indicates that a PH field for the SCell with $SCellIndex$ i is not reported;
- R: reserved bit, set to "0";
- V: this field indicates if the PH value is based on a real transmission or a reference format. For Type 1 PH, V=0 indicates real transmission on PUSCH and V=1 indicates that a PUSCH reference format is used. For Type 2 PH, V=0 indicates real transmission on PUCCH and V=1 indicates that a PUCCH reference format is used. Furthermore, for both Type 1 and Type 2 PH, V=0 indicates the presence of the associated $P_{CMAX,c}$ field, and V=1 indicates that the associated $P_{CMAX,c}$ field is omitted;
- Power Headroom (PH): this field indicates the power headroom level. The length of the field is 6 bits. The reported PH and the corresponding power headroom levels are shown in Table 6.1.3.6-1 (the corresponding measured values in dB can be found in subclause 9.1.8.4 of [9]);
- P: this field indicates whether the UE applies power backoff due to power management (as allowed by P-MPR [10]). The UE shall set P=1 if the corresponding $P_{CMAX,c}$ field would have had a different value if no power backoff due to power management had been applied;
- $P_{CMAX,c}$: if present, this field indicates the $P_{CMAX,c}$ or $\tilde{P}_{CMAX,c}$ [2] used for calculation of the preceding PH field. The reported $P_{CMAX,c}$ and the corresponding nominal UE transmit power levels are shown in Table 6.1.3.6a-1 (the corresponding measured values in dBm can be found in subclause 9.6.1 of [9]).

Figure 6.1.3.6a-1: Void

C_7	C_6	C_5	C_4	C_3	C_2	C_1	R	
P	V	PH (Type 2, PCell)						
R	R	$P_{CMAX,c}$ 1						
P	V	PH (Type 1, PCell)						
R	R	$P_{CMAX,c}$ 2						
P	V	PH (Type 1, SCell 1)						
R	R	$P_{CMAX,c}$ 3						
...								
P	V	PH (Type 1, SCell n)						
R	R	$P_{CMAX,c}$ m						

Figure 6.1.3.6a-2: Extended Power Headroom MAC Control Element

Table 6.1.3.6a-1: Nominal UE transmit power level for Extended PHR

$P_{\text{CMAX},c}$	Nominal UE transmit power level
0	PCMAX_C_00
1	PCMAX_C_01
2	PCMAX_C_02
...	...
61	PCMAX_C_61
62	PCMAX_C_62
63	PCMAX_C_63

7.1.4.15.3 Test description

7.1.4.21.3.1 Pre-test conditions

System Simulator:

- Cell 1

UE:

None.

Preamble:

- The UE is in state Generic RB Established (state 3) on Cell 1 according to [18].

7.1.4.21.3.2 Test procedure sequence

Table 7.1.4.21.3.2-1: Main behaviour

St	Procedure	Message Sequence		TP	Verdict
		U - S	Message		
1	The SS is configured for Uplink Grant Allocation Type 2. The SS transmits UL grant for the UE at every TTI for FDD and every 5ms in a DL subframe for TDD.	-->	-	-	-
2	The SS transmits an <i>RRCCONNECTIONRECONFIGURATION</i> message to provide Extended Power Headroom parameters	<--	-	-	-
3	Check: does the UE transmit a MAC PDU containing Extended Power Headroom MAC Control Element?	-->	MAC PDU	1	P
4	The UE transmits an <i>RRCCONNECTIONRECONFIGURATIONCOMPLETE</i> message to confirm the setup of Extended Power Headroom parameters.	-->	-	-	-
5	Check: does the UE transmit a MAC PDU containing Extended Power Headroom MAC Control Element 200ms after step 3?	-->	MAC PDU	2	P
6	The SS transmits an <i>RRCCONNECTIONRECONFIGURATION</i> message to disable Extended Power Headroom reporting	<--	-	-	-
7	The UE transmits an <i>RRCCONNECTIONRECONFIGURATIONCOMPLETE</i> message to confirm the disabling of Extended Power Headroom parameters	-->	-	-	-
8	Check: for 2 seconds, does the UE transmit a MAC PDU containing Power Headroom MAC Control Element?	-->	MAC PDU	3	F

Note: Steps 3 and 4 can happen in 2 MAC PDU's, or may be combined in one MAC PDU.

7.1.4.21.3.3 Specific message contents

Table 7.1.4.21.3.3-1: RRCConnectionReconfiguration (step 2, Table 7.1.4.21.3.2-1)

Derivation path: 36.508 table 4.6.1-8			
Information Element	Value/Remark	Comment	Condition
RRCConnectionReconfiguration ::= SEQUENCE {			
criticalExtensions CHOICE {			
c1 CHOICE{			
rrcConnectionReconfiguration-r8 SEQUENCE {			
RadioResourceConfigDedicated SEQUENCE {			
mac-MainConfig CHOICE {			
explicitValue SEQUENCE {			
phr-Confign CHOICE {			
setup SEQUENCE {			
periodicPHR-Timer	sf200		
prohibitPHR-Timer	sf1000		
dl-PathlossChange	infinity		
}			
}			
mac-MainConfig-v1020 SEQUENCE {			
extendedPHR-r10	setup		
}			
}			
}			
}			
}			
}			
}			
}			
}			

Table 7.1.4.21.3.3-2: RRCConnectionReconfiguration (step 6, Table 7.1.4.21.3.2-1)

Derivation path: 36.508 table 4.6.1-8			
Information Element	Value/Remark	Comment	Condition
RRCConnectionReconfiguration ::= SEQUENCE {			
criticalExtensions CHOICE {			
c1 CHOICE{			
rrcConnectionReconfiguration-r8 SEQUENCE {			
RadioResourceConfigDedicated SEQUENCE {			
mac-MainConfig CHOICE {			
explicitValue SEQUENCE {			
phr-Config CHOICE {			
release	NULL		
}			
}			
}			
}			
}			
}			
}			
}			
}			

7.1.4.22 Correct HARQ process handling / UL MIMO

7.1.4.22.1 Test Purpose (TP)

(1)

```

with { UE in E-UTRA RRC_CONNECTED state with DRB established and UL MIMO configured }
ensure that {
  when { UE receives one uplink grant (DCI format 4) with toggled NDI and two transport blocks
enabled, and has data available for transmission }
  then { UE transmits two new MAC PDUs both using redundancy version 0 for two HARQ processes in a
TTI }

```

}

(2)

```

with { UE in E-UTRA RRC_CONNECTED state with DRB established and having transmitted two MAC PDUs
less than maxHARQ-Tx times }
ensure that {
  when { UE receives NACKs for two HARQ processes and no uplink grant is included for the next TTI
corresponding to the two HARQ processes }
  then { UE performs non-adaptive retransmission of the two MAC PDUs with redundancy version
toggled by one of the last (re)transmission [0,2,3,1 order] }
}

```

(3)

```

with { UE in E-UTRA RRC_CONNECTED state with DRB established and having transmitted two MAC PDUs
less than maxHARQ-Tx times }
ensure that {
  when { UE receives NACK for one of the HARQ process and ACK for another HARQ process and no uplink
grant is included for the next TTI corresponding to the HARQ processes }
  then { UE performs non-adaptive retransmission of the MAC PDU with redundancy version toggled by
one of the last (re)transmission [0,2,3,1 order] for the HARQ process that receives NACK and does
not retransmit any MAC PDUs for another HARQ process that receives ACK }
}

```

(4)

```

with { UE in E-UTRA RRC_CONNECTED state with DRB established and having transmitted two MAC PDUs
less than maxHARQ-Tx times }
ensure that {
  when { UE receives an uplink grant on PDCCH for the next TTI corresponding to the two HARQ
processes with old NDI [not toggled] for one HARQ process and with toggled NDI for another HARQ
process, irrespective of ACK/NACK is received for previous (re)transmission }
  then { UE performs an adaptive retransmission of the MAC PDU with redundancy version as received
on PDCCH for HARQ process with old NDI and transmits a new MAC PDU for HARQ process with new NDI }
}

```

(5)

```

with { UE in E-UTRA RRC_CONNECTED state with DRB established and having transmitted two MAC PDU less
than maxHARQ-Tx times }
ensure that {
  when { UE receives ACKs and no uplink grant is included for the next TTI corresponding to the two
HARQ processes }
  then { UE does not retransmit any MAC PDUs for the two HARQ processes }
}

```

7.1.4.22.2 Conformance requirements

References: The conformance requirements covered in the current TC are specified in: TS 36.321, clause 5.4.2.1 & 5.4.2.2; TS 36.212, clause 5.3.3.1.8.

[TS 36.321, clause 5.4.2.1]

There is one HARQ entity at the UE for each Serving Cell with configured uplink, which maintains a number of parallel HARQ processes allowing transmissions to take place continuously while waiting for the HARQ feedback on the successful or unsuccessful reception of previous transmissions.

The number of parallel HARQ processes per HARQ entity is specified in [2], clause 8.

When the physical layer is configured for uplink spatial multiplexing [2], there are two HARQ processes associated with a given TTI. Otherwise there is one HARQ process associated with a given TTI.

At a given TTI, if an uplink grant is indicated for the TTI, the HARQ entity identifies the HARQ process(es) for which a transmission should take place. It also routes the received HARQ feedback (ACK/NACK information), MCS and resource, relayed by the physical layer, to the appropriate HARQ process(es).

When TTI bundling is configured, the parameter TTI_BUNDLE_SIZE provides the number of TTIs of a TTI bundle. TTI bundling operation relies on the HARQ entity for invoking the same HARQ process for each transmission that is part of the same bundle. Within a bundle HARQ retransmissions are non-adaptive and triggered without waiting for

feedback from previous transmissions according to TTI_BUNDLE_SIZE. The HARQ feedback of a bundle is only received for the last TTI of the bundle (i.e the TTI corresponding to TTI_BUNDLE_SIZE), regardless of whether a transmission in that TTI takes place or not (e.g. when a measurement gap occurs). A retransmission of a TTI bundle is also a TTI bundle. TTI bundling is not supported when the UE is configured with one or more SCells with configured uplink.

TTI bundling is not supported for RN communication with the E-UTRAN in combination with an RN subframe configuration.

For transmission of Msg3 during Random Access (see section 5.1.5) TTI bundling does not apply.

For each TTI, the HARQ entity shall:

- identify the HARQ process(es) associated with this TTI, and for each identified HARQ process:
 - if an uplink grant has been indicated for this process and this TTI:
 - if the received grant was not addressed to a Temporary C-RNTI on PDCCH and if the NDI provided in the associated HARQ information has been toggled compared to the value in the previous transmission of this HARQ process; or
 - if the uplink grant was received on PDCCH for the C-RNTI and the HARQ buffer of the identified process is empty; or
 - if the uplink grant was received in a Random Access Response:
 - if there is a MAC PDU in the Msg3 buffer and the uplink grant was received in a Random Access Response:
 - obtain the MAC PDU to transmit from the Msg3 buffer.
 - else:
 - obtain the MAC PDU to transmit from the "Multiplexing and assembly" entity;
 - deliver the MAC PDU and the uplink grant and the HARQ information to the identified HARQ process;
 - instruct the identified HARQ process to trigger a new transmission.
 - else:
 - deliver the uplink grant and the HARQ information (redundancy version) to the identified HARQ process;
 - instruct the identified HARQ process to generate an adaptive retransmission.
 - else, if the HARQ buffer of this HARQ process is not empty:
 - instruct the identified HARQ process to generate a non-adaptive retransmission.

When determining if NDI has been toggled compared to the value in the previous transmission UE shall ignore NDI received in all uplink grants on PDCCH for its Temporary C-RNTI.

[TS 36.321, clause 5.4.2.2]

Each HARQ process is associated with a HARQ buffer.

Each HARQ process shall maintain a state variable CURRENT_TX_NB, which indicates the number of transmissions that have taken place for the MAC PDU currently in the buffer, and a state variable HARQ_FEEDBACK, which indicates the HARQ feedback for the MAC PDU currently in the buffer. When the HARQ process is established, CURRENT_TX_NB shall be initialized to 0.

The sequence of redundancy versions is 0, 2, 3, 1. The variable CURRENT_IRV is an index into the sequence of redundancy versions. This variable is up-dated modulo 4.

New transmissions are performed on the resource and with the MCS indicated on PDCCH or Random Access Response. Adaptive retransmissions are performed on the resource and, if provided, with the MCS indicated on PDCCH. Non-adaptive retransmission is performed on the same resource and with the same MCS as was used for the last made transmission attempt.

The UE is configured with a Maximum number of HARQ transmissions and a Maximum number of Msg3 HARQ transmissions by RRC: *maxHARQ-Tx* and *maxHARQ-Msg3Tx* respectively. For transmissions on all HARQ processes and all logical channels except for transmission of a MAC PDU stored in the Msg3 buffer, the maximum number of transmissions shall be set to *maxHARQ-Tx*. For transmission of a MAC PDU stored in the Msg3 buffer, the maximum number of transmissions shall be set to *maxHARQ-Msg3Tx*.

When the HARQ feedback is received for this TB, the HARQ process shall:

- set HARQ_FEEDBACK to the received value.

If the HARQ entity requests a new transmission, the HARQ process shall:

- set CURRENT_TX_NB to 0;
- set CURRENT_IRV to 0;
- store the MAC PDU in the associated HARQ buffer;
- store the uplink grant received from the HARQ entity;
- set HARQ_FEEDBACK to NACK;
- generate a transmission as described below.

If the HARQ entity requests a retransmission, the HARQ process shall:

- increment CURRENT_TX_NB by 1;
- if the HARQ entity requests an adaptive retransmission:
 - store the uplink grant received from the HARQ entity;
 - set CURRENT_IRV to the index corresponding to the redundancy version value provided in the HARQ information;
 - set HARQ_FEEDBACK to NACK;
 - generate a transmission as described below.
- else if the HARQ entity requests a non-adaptive retransmission:
 - if HARQ_FEEDBACK = NACK:
 - generate a transmission as described below.

NOTE 1: When receiving a HARQ ACK alone, the UE keeps the data in the HARQ buffer.

NOTE 2: When no UL-SCH transmission can be made due to the occurrence of a measurement gap, no HARQ feedback can be received and a non-adaptive retransmission follows.

To generate a transmission, the HARQ process shall:

- if the MAC PDU was obtained from the Msg3 buffer; or
- if there is no measurement gap at the time of the transmission and, in case of retransmission, the retransmission does not collide with a transmission for a MAC PDU obtained from the Msg3 buffer in this TTI:
 - instruct the physical layer to generate a transmission according to the stored uplink grant with the redundancy version corresponding to the CURRENT_IRV value;
 - increment CURRENT_IRV by 1;

- if there is a measurement gap at the time of the HARQ feedback reception for this transmission and if the MAC PDU was not obtained from the Msg3 buffer:
 - set HARQ_FEEDBACK to ACK at the time of the HARQ feedback reception for this transmission.

After performing above actions, the HARQ process then shall:

- if CURRENT_TX_NB = maximum number of transmissions – 1:
 - flush the HARQ buffer.

[TS 36.212, clause 5.3.3.1.8]

DCI format 4 is used for the scheduling of PUSCH in one UL cell with multi-antenna port transmission mode,

The following information is transmitted by means of the DCI format 4:

- Carrier indicator – 0 or 3 bits. The field is present according to the definitions in [3].

- Resource block assignment -

$$\max \left(\left\lceil \log_2(N_{RB}^{UL}(N_{RB}^{UL} + 1)/2) \right\rceil, \left\lceil \log_2 \left(\left(\left\lceil \frac{N_{RB}^{UL}}{P+1} \right\rceil \right) \right) \right\rceil \right)$$
 bits,
 - where P is the UL RBG size as defined in section 8.1.2 of [3]
 - For resource allocation type 0:
 - The $\left\lceil \log_2(N_{RB}^{UL}(N_{RB}^{UL} + 1)/2) \right\rceil$ LSBs provide the resource allocation in the UL subframe as defined in section 8.1.1 of [3]
 - For resource allocation type 1:
 - The $\left\lceil \log_2 \left(\left(\left\lceil \frac{N_{RB}^{UL}}{P+1} \right\rceil \right) \right) \right\rceil$ LSBs provide the resource allocation in the UL subframe as defined in section 8.1.2 of [3]
- TPC command for scheduled PUSCH – 2 bits as defined in section 5.1.1.1 of [3]
- Cyclic shift for DM RS and OCC index – 3 bits as defined in section 5.5.2.1.1 of [2]
- UL index – 2 bits as defined in sections 5.1.1.1, 7.2.1, 8 and 8.4 of [3] (this field is present only for TDD operation with uplink-downlink configuration 0)
- Downlink Assignment Index (DAI) – 2 bits as defined in section 7.3 of [3] (this field is present only for TDD operation with uplink-downlink configurations 1-6)
- CSI request – 1 or 2 bits as defined in section 7.2.1 of [3]. The 2-bit field only applies to UEs that are configured with more than one DL cell.
- SRS request – 2 bits as defined in section 8.2 of [3]
- Resource allocation type – 1 bit as defined in section 8.1 of [3]

In addition, for transport block 1:

- Modulation and coding scheme and redundancy version – 5 bits as defined in section 8.6 of [3]
- New data indicator – 1 bit

In addition, for transport block 2:

- Modulation and coding scheme and redundancy version – 5 bits as defined in section 8.6 of [3]

- New data indicator – 1 bit

Precoding information and number of layers: number of bits as specified in Table 5.3.3.1.8-1. Bit field as shown in Table 5.3.3.1.8-2 and Table 5.3.3.1.8-3. Note that TPMI for 2 antenna ports indicates which codebook index is to be used in Table 5.3.3A.2-1 of [2], and TPMI for 4 antenna ports indicates which codebook index is to be used in Table 5.3.3A.2-2, Table 5.3.3A.2-3, Table 5.3.3A.2-4 and Table 5.3.3A.2-5 of [2]. If both transport blocks are enabled, transport block 1 is mapped to codeword 0; and transport block 2 is mapped to codeword 1. In case one of the transport blocks is disabled, the transport block to codeword mapping is specified according to Table 5.3.3.1.5-2. For a single enabled codeword, indices 24 to 39 in Table 5.3.3.1.8-3 are only supported for retransmission of the corresponding transport block if that transport block has previously been transmitted using two layers.

Table 5.3.3.1.8-1: Number of bits for precoding information

Number of antenna ports at UE	Number of bits for precoding information
2	3
4	6

Table 5.3.3.1.8-2: Content of precoding information field for 2 antenna ports

One codeword: Codeword 0 enabled Codeword 1 disabled		Two codewords: Codeword 0 enabled Codeword 1 enabled	
Bit field mapped to index	Message	Bit field mapped to index	Message
0	1 layer: TPMI=0	0	2 layers: TPMI=0
1	1 layer: TPMI=1	1-7	reserved
2	1 layer: TPMI=2		
...	...		
5	1 layer: TPMI=5		
6-7	reserved		

Table 5.3.3.1.8-3: Content of precoding information field for 4 antenna ports

One codeword: Codeword 0 enabled Codeword 1 disabled		Two codewords: Codeword 0 enabled Codeword 1 enabled	
Bit field mapped to index	Message	Bit field mapped to index	Message
0	1 layer: TPMI=0	0	2 layers: TPMI=0
1	1 layer: TPMI=1	1	2 layers: TPMI=1
...
23	1 layer: TPMI=23	15	2 layers: TPMI=15
24	2 layers: TPMI=0	16	3 layers: TPMI=0
25	2 layers: TPMI=1	17	3 layers: TPMI=1
...
39	2 layers: TPMI=15	27	3 layers: TPMI=11
40-63	reserved	28	4 layers: TPMI=0
		29 - 63	Reserved

If the number of information bits in format 4 is equal to the payload size for DCI format 1, 2, 2A, 2B or 2C associated with the configured DL transmission mode in the same serving cell, one zero bit shall be appended to format 4.

7.1.4.22.3 Test description

7.1.4.22.3.1 Pre-test conditions

System Simulator:

- Cell 1

- System information takes into account the parameters in table 7.1.2.11.3.1-1.

UE:

UE with two transmit antenna connectors in closed-loop spatial multiplexing scheme

Preamble:

- The UE is in state Loopback Activated (state 4) according to [18] using parameters as specified in Table 7.1.4.22.3.3-1 and 7.1.4.22.3.3-2.
- The loop back size is set in such a way that one RLC SDU in DL shall result in 1 RLC SDU's in UL.
- No UL Grant is allocated; PUCCH is in synchronised state for sending Scheduling Requests.

7.1.4.22.3.2 Test procedure sequence

Table 7.1.4.22.3.2-1: Main behaviour

St	Procedure	Message Sequence		TP	Verdict
		U - S	Message		
1	The SS transmits one MAC PDU including two RLC SDUs	<--	MAC PDU (2 RLC SDUs)	-	-
2	The SS transmits one UL Grant sufficient for transmitting loop back two RLC SDUs for two HARQ process X and Y, and both NDI indicate new transmission.	<--	Uplink Grant DCI: (DCI Format 4, redundancy version#1= 0, redundancy version#2= 0)	-	-
3	Check: Does the UE transmit two MAC PDUs both including one RLC SDU in HARQ process X and Y in a TTI, both redundancy version 0? (Note 1)	-->	Transport block 1: MAC PDU Transport block 2: MAC PDU	1	P
4	The SS transmits two NACKs for HARQ process X and Y	<--	HARQ NACK#X HARQ NACK#Y	-	-
5	Check: Does the UE retransmit the MAC PDUs for HARQ process X and Y, redundancy version 2? (Note 1)	-->	Transport block 1: MAC PDU Transport block 2: MAC PDU	2	P
6	The SS transmits a NACK for HARQ process X and ACK for HARQ process Y	<--	HARQ NACK#X HARQ ACK#Y	-	-
7	Check: Does the UE retransmit the MAC PDU for HARQ process X, redundancy version 3? (Note 1)	-->	Transport block 1: MAC PDU	3	P
8	The SS transmits ACK for HARQ process X	<--	HARQ ACK#X	-	-
9	Check: Does the UE retransmit the MAC PDUs for HARQ process X and Y?	-->	Transport block 1: MAC PDU Transport block 2: MAC PDU	5	F
10	The SS transmits one MAC PDU including one RLC SDU	<--	MAC PDU (1 RLC SDU)	-	-
11	The SS transmits one UL grant for HARQ process X and Y, with NDI not toggled and redundancy version to be used as '1' for process X, with NDI toggled and redundancy version to be used as '3' for process Y	<--	Uplink Grant	-	-
12	Check: Does the UE retransmit the MAC PDU for HARQ process X using redundancy version 1 and transmit a new MAC PDU sent by SS in step 10 for HARQ process Y using redundancy version 3? (Note 1)	-->	Transport block 1: MAC PDU (redundancy version 1) Transport block 2: MAC PDU (redundancy version 3)	4	P

Note 1: Transmission of a UL MAC PDU with a specific redundancy version by the UE is implicitly tested by receiving the UL MAC PDU correctly at SS.

7.1.4.22.3.3 Specific message contents

Table 7.1.4.22.3.3-1: MAC-MainConfig {RRCConnectionReconfiguration (preamble: Table 4.5.3.3-1, step 8)}

Derivation path: 36.508 table 4.8.2.1.5-1			
Information Element	Value/remark	Comment	Condition
MAC-MainConfig-RBC ::= SEQUENCE {			
ul-SCH-Config SEQUENCE {			
maxHARQ-Tx	n6		
}			
}			

Table 7.1.4.22.3.3-2: RLC-Config-DRB-AM {RRCConnectionReconfiguration (preamble: Table 4.5.3.3-1, step 8)}

Derivation path: 36.508 clause 4.8.2.1.3.2, Table 4.8.2.1.3.2-1			
Information Element	Value/Remark	Comment	Condition
RLC-Config-DRB-AM ::= CHOICE {			
am SEQUENCE {			
ul-AM-RLC SEQUENCE {			
t-PollRetransmit	ms250		
}			
}			
}			

7.1.5 PUSCH Hopping

7.1.5.1 Inter-TTI PUSCH hopping by uplink grant

7.1.5.1.1 Test Purpose (TP)

(1)

```

with { UE in E-UTRA RRC_CONNECTED state and 'Hopping-mode' is set to 'InterSubFrame' }
ensure that {
  when { UE receives for a TTI an uplink grant with 'Hopping flag' set as 1, 'NUL_hop' bits indicating
  Type 1 PUSCH Hopping }
  then { UE transmits UL data on resource blocks as per type 1 PUSCH hopping }
}

```

7.1.5.1.2 Conformance requirements

References: The conformance requirements covered in the present TC are specified in: 3GPP TS 36.212 clause 5.3.3.1.1 and 36.213 clause 8.4, 8.4.1 & 8.4.2.

[TS 36.212, clause 5.3.3.1.1]

DCI format 0 is used for the scheduling of PUSCH.

The following information is transmitted by means of the DCI format 0:

- Flag for format0/format1A differentiation – 1 bit, where value 0 indicates format 0 and value 1 indicates format 1A
- Hopping flag – 1 bit as defined in section 8.4 of [3]
- Resource block assignment and hopping resource allocation – $\left\lceil \log_2 (N_{RB}^{UL} (N_{RB}^{UL} + 1) / 2) \right\rceil$ bits
 - For PUSCH hopping:
 - N_{UL_hop} MSB bits are used to obtain the value of $\tilde{n}_{PRB}(i)$ as indicated in subclause [8.4] of [3]

- $\left(\left\lceil \log_2(N_{RB}^{UL}(N_{RB}^{UL} + 1)/2) \right\rceil - N_{UL_hop} \right)$ bits provide the resource allocation of the first slot in the UL subframe

- For non-hopping PUSCH:

- $\left(\left\lceil \log_2(N_{RB}^{UL}(N_{RB}^{UL} + 1)/2) \right\rceil \right)$ bits provide the resource allocation in the UL subframe as defined in section 8.1 of [3]

[TS 36.213, clause 8.4]

The UE shall perform PUSCH frequency hopping if the single bit frequency hopping (FH) field in a corresponding PDCCH with DCI format 0 is set to 1 otherwise no PUSCH frequency hopping is performed.

A UE performing PUSCH frequency hopping shall determine its PUSCH resource allocation (RA) for the first slot of a subframe (S_I) including the lowest index PRB ($n_{PRB}^{S_I}(n)$) in subframe n from the resource allocation field in the latest PDCCH with DCI format 0 for the same transport block. If there is no PDCCH for the same transport block, the UE shall determine its hopping type based on

- the hopping information in the most recent semi-persistent scheduling assignment PDCCH, when the initial PUSCH for the same transport block is semi-persistently scheduled or
- the random access response grant for the same transport block, when the PUSCH is initiated by the random access response grant.

The resource allocation field in DCI format 0 excludes either 1 or 2 bits used for hopping information as indicated by Table 8.4-1 below where the number of PUSCH resource blocks is defined as

$$N_{RB}^{PUSCH} = \begin{cases} N_{RB}^{UL} - \tilde{N}_{RB}^{HO} - (N_{RB}^{UL} \bmod 2) & \text{Type 1 PUSCH hopping} \\ N_{RB}^{UL} & \text{Type 2 } N_{sb} = 1 \text{ PUSCH hopping} \\ N_{RB}^{UL} - \tilde{N}_{RB}^{HO} & \text{Type 2 } N_{sb} > 1 \text{ PUSCH hopping} \end{cases}$$

For type 1 and type 2 PUSCH hopping, $\tilde{N}_{RB}^{HO} = N_{RB}^{HO} + 1$ if N_{RB}^{HO} is an odd number where N_{RB}^{HO} defined in [3].

$\tilde{N}_{RB}^{HO} = N_{RB}^{HO}$ in other cases. The size of the resource allocation field in DCI format 0 after excluding either 1 or 2 bits shall be $y = \left\lceil \log_2(N_{RB}^{UL}(N_{RB}^{UL} + 1)/2) \right\rceil - N_{UL_hop}$, where $N_{UL_hop} = 1$ or 2 bits. The number of contiguous RBs that can be assigned to a type-1 hopping user is limited to $\lfloor 2^y / N_{RB}^{UL} \rfloor$. The number of contiguous RBs that can be assigned to a type-2 hopping user is limited to $\min(\lfloor 2^y / N_{RB}^{UL} \rfloor, \lfloor N_{RB}^{PUSCH} / N_{sb} \rfloor)$, where the number of sub-bands N_{sb} is given by higher layers.

A UE performing PUSCH frequency hopping shall use one of two possible PUSCH frequency hopping types based on the hopping information. PUSCH hopping type 1 is described in section 8.4.1 and type 2 is described in section 8.4.2.

Table 8.4-1: Number of Hopping Bits N_{UL_hop} vs. System Bandwidth

System BW N_{RB}^{UL}	#Hopping bits for 2nd slot RA (N_{UL_hop})
6-49	1
50-110	2

The parameter *Hopping-mode* provided by higher layers determines if PUSCH frequency hopping is “inter-subframe” or “intra and inter-subframe”.

[TS 36.213, clause 8.4.1]

For PUSCH hopping type 1 the hopping bit or bits indicated in Table 8.4-1 determine $\tilde{n}_{PRB}(i)$ as defined in Table 8.4-2.

The lowest index PRB (n_{PRB}^{S1}) of the 1st slot RA in subframe i is defined as $n_{PRB}^{S1}(i) = \tilde{n}_{PRB}^{S1}(i) + \tilde{N}_{RB}^{HO} / 2$, where $n_{PRB}^{S1}(i) = RB_{START}$, and RB_{START} is obtained from the uplink scheduling grant as in Section 8.4 and Section 8.1.

The lowest index PRB ($n_{PRB}(i)$) of the 2nd slot RA in subframe i is defined as $n_{PRB}(i) = \tilde{n}_{PRB}(i) + \tilde{N}_{RB}^{HO} / 2$.

The set of physical resource blocks to be used for PUSCH transmission are L_{CRBs} contiguously allocated resource blocks from PRB index n_{PRB}^{S1} for the 1st slot, and from PRB index $n_{PRB}(i)$ for the 2nd slot, respectively, where L_{CRBs} is obtained from the uplink scheduling grant as in Section 8.4 and Section 8.1.

If the *Hopping-mode* is "inter-subframe", the 1st slot RA is applied to even CURRENT_TX_NB, and the 2nd slot RA is applied to odd CURRENT_TX_NB, where CURRENT_TX_NB is defined in [8].

[TS 36.213, clause 8.4.2]

Table 8.4-2: PDCCH DCI Format 0 Hopping Bit Definition

System BW N_{RB}^{UL}	Number of Hopping bits	Information in hopping bits	$\tilde{n}_{PRB}(i)$
6 – 49	1	0	$\left(\left\lfloor N_{RB}^{PUSCH} / 2 \right\rfloor + \tilde{n}_{PRB}^{S1}(i) \right) \bmod N_{RB}^{PUSCH}$,
		1	Type 2 PUSCH Hopping
50 – 110	2	00	$\left(\left\lfloor N_{RB}^{PUSCH} / 4 \right\rfloor + \tilde{n}_{PRB}^{S1}(i) \right) \bmod N_{RB}^{PUSCH}$
		01	$\left(- \left\lfloor N_{RB}^{PUSCH} / 4 \right\rfloor + \tilde{n}_{PRB}^{S1}(i) \right) \bmod N_{RB}^{PUSCH}$
		10	$\left(\left\lfloor N_{RB}^{PUSCH} / 2 \right\rfloor + \tilde{n}_{PRB}^{S1}(i) \right) \bmod N_{RB}^{PUSCH}$
		11	Type 2 PUSCH Hopping

7.1.5.1.3 Test description

7.1.5.1.3.1 Pre-test conditions

System Simulator

- Cell 1

UE:

None.

Preamble:

- The UE is in state Loopback Activated (state 4) according to [18].

7.1.5.1.3.2 Test procedure sequence

Table 7.1.5.1.3.2-1: Main behaviour

St	Procedure	Message Sequence		TP	Verdict
		U - S	Message		
1	The SS ignores scheduling requests and does not allocate any uplink grant. Exception: Steps 2 to 5 are executed as per table 7.1.5.1.3.2-2	-	-	-	-
2	SS transmits a MAC PDU including 8 (FDD)/4(TDD) RLC SDU's	<--	MAC PDU	-	-
3	The SS waits for 60 ms Exception: Steps 4 and 5 are repeated such that UE sends data in 8 ([FDD)/4(TDD) consecutive UL TTI's.	-	-	-	-
4	The SS is configured for Uplink Grant Allocation Type 2. SS transmits an UL Grant, allowing the UE to return 1 RLC SDU as received in step 2. Hopping flag' set as 1, all bits in 'N _{UL_hop} ' are set as per table 7.1.5.3.2-2 for various execution runs	<--	(UL Grant (C-RNTI))	-	-
5	Check: Does the UE transmit a MAC PDU corresponding to grant in step 4?	-	-	1	P
Note 1: Steps 4 and 5 are repeated for 8 times corresponding to 8 sub frames for FDD and 4 for default TDD configuration 1.					
Note 2: The grant allocated in step 4 is such that the loop back PDU's are received in 8 (FDD)/4(TDD) UL TTI's					

Table 7.1.5.1.3.2-2: Bandwidth dependent parameters

System BW	Number of Hopping bits	Execution Counter K	Information in hopping bits
5 MHz	1	1	0
10/20 MHz	2	1	00
		2	01
		3	10

7.1.5.1.3.3 Specific message contents.

None

7.1.5.2 Predefined intra-TTI PUSCH hopping (N_{sb}=1)

7.1.5.2.1 Test Purpose (TP)

(1)

```

with { UE in E-UTRA RRC_CONNECTED state, number of sub bands 'N-sb' is set to 1 and 'Hopping-mode'
is set to 'intraAndInterSubFrame' }
ensure that {
  when { UE receives for a TTI an uplink grant with 'Hopping flag' set as 1, 'NUL_hop' bits all set to
1 (Type 2 predefined hopping) }
  then { UE transmits data with predefined, intra-TTI PUSCH hopping }
}
    
```

7.1.5.2.2 Conformance requirements

References: The conformance requirements covered in the present TC are specified in: 3GPP TS 36.211 clause 5.3.4 , 36.212 clause 5.3.3.1.1 and 36.213 clause 8.4, 8.4.2.

[TS 36.211, clause 5.3.4]

If uplink frequency-hopping with predefined hopping pattern is enabled, the set of physical resource blocks to be used for transmission in slot n_s is given by the scheduling grant together with a predefined pattern according to

$$\begin{aligned} \tilde{n}_{\text{PRB}}(n_s) &= (\tilde{n}_{\text{VRB}} + f_{\text{hop}}(i) \cdot N_{\text{RB}}^{\text{sb}} + ((N_{\text{RB}}^{\text{sb}} - 1) - 2(\tilde{n}_{\text{VRB}} \bmod N_{\text{RB}}^{\text{sb}})) \cdot f_m(i)) \bmod (N_{\text{RB}}^{\text{sb}} \cdot N_{\text{sb}}) \\ i &= \begin{cases} \lfloor n_s/2 \rfloor & \text{inter-subframe hopping} \\ n_s & \text{intra and inter-subframe hopping} \end{cases} \\ n_{\text{PRB}}(n_s) &= \begin{cases} \tilde{n}_{\text{PRB}}(n_s) & N_{\text{sb}} = 1 \\ \tilde{n}_{\text{PRB}}(n_s) + \lceil N_{\text{RB}}^{\text{HO}}/2 \rceil & N_{\text{sb}} > 1 \end{cases} \\ \tilde{n}_{\text{VRB}} &= \begin{cases} n_{\text{VRB}} & N_{\text{sb}} = 1 \\ n_{\text{VRB}} - \lceil N_{\text{RB}}^{\text{HO}}/2 \rceil & N_{\text{sb}} > 1 \end{cases} \end{aligned}$$

where n_{VRB} is obtained from the scheduling grant as described in Section 8.1 in [4]. The parameter *pusch-HoppingOffset*, $N_{\text{RB}}^{\text{HO}}$, is provided by higher layers.. The size $N_{\text{RB}}^{\text{sb}}$ of each sub-band is given by,

$$N_{\text{RB}}^{\text{sb}} = \begin{cases} N_{\text{RB}}^{\text{UL}} & N_{\text{sb}} = 1 \\ \lfloor (N_{\text{RB}}^{\text{UL}} - N_{\text{RB}}^{\text{HO}} - N_{\text{RB}}^{\text{HO}} \bmod 2) / N_{\text{sb}} \rfloor & N_{\text{sb}} > 1 \end{cases}$$

where the number of sub-bands N_{sb} is given by higher layers. The function $f_m(i) \in \{0,1\}$ determines whether mirroring is used or not. The parameter *Hopping-mode* provided by higher layers determines if hopping is “inter-subframe” or “intra and inter-subframe”.

The hopping function $f_{\text{hop}}(i)$ and the function $f_m(i)$ are given by

$$\begin{aligned} f_{\text{hop}}(i) &= \begin{cases} 0 & N_{\text{sb}} = 1 \\ (f_{\text{hop}}(i-1) + \sum_{k=i-10+1}^{i-10+9} c(k) \times 2^{k-(i-10+1)}) \bmod N_{\text{sb}} & N_{\text{sb}} = 2 \\ (f_{\text{hop}}(i-1) + \left(\sum_{k=i-10+1}^{i-10+9} c(k) \times 2^{k-(i-10+1)} \right) \bmod (N_{\text{sb}} - 1) + 1) \bmod N_{\text{sb}} & N_{\text{sb}} > 2 \end{cases} \\ f_m(i) &= \begin{cases} i \bmod 2 & N_{\text{sb}} = 1 \text{ and intra and inter-subframe hopping} \\ \text{CURRENT_TX_NB} \bmod 2 & N_{\text{sb}} = 1 \text{ and inter-subframe hopping} \\ c(i-10) & N_{\text{sb}} > 1 \end{cases} \end{aligned}$$

where $f_{\text{hop}}(-1) = 0$ and the pseudo-random sequence $c(i)$ is given by section 7.2 and CURRENT_TX_NB indicates the transmission number for the transport block transmitted in slot n_s as defined in [8]. The pseudo-random sequence generator shall be initialised with $c_{\text{init}} = N_{\text{ID}}^{\text{cell}}$ for FDD and $c_{\text{init}} = 2^9 \cdot (n_f \bmod 4) + N_{\text{ID}}^{\text{cell}}$ for TDD at the start of each frame.

[TS 36.212, clause 5.3.3.1.1]

DCI format 0 is used for the scheduling of PUSCH.

The following information is transmitted by means of the DCI format 0:

- Flag for format0/format1A differentiation – 1 bit, where value 0 indicates format 0 and value 1 indicates format 1A
- Hopping flag – 1 bit as defined in section 8.4 of [3]
- Resource block assignment and hopping resource allocation – $\lceil \log_2(N_{\text{RB}}^{\text{UL}}(N_{\text{RB}}^{\text{UL}} + 1)/2) \rceil$ bits
- For PUSCH hopping:

- N_{UL_hop} MSB bits are used to obtain the value of $\tilde{n}_{PRB}(i)$ as indicated in subclause [8.4] of [3]
- $\left(\left\lceil \log_2(N_{RB}^{UL}(N_{RB}^{UL} + 1)/2) \right\rceil - N_{UL_hop} \right)$ bits provide the resource allocation of the first slot in the UL subframe

- For non-hopping PUSCH:

- $\left(\left\lceil \log_2(N_{RB}^{UL}(N_{RB}^{UL} + 1)/2) \right\rceil \right)$ bits provide the resource allocation in the UL subframe as defined in section 8.1 of [3]

[TS 36.213, clause 8.4]

The UE shall perform PUSCH frequency hopping if the single bit frequency hopping (FH) field in a corresponding PDCCH with DCI format 0 is set to 1 otherwise no PUSCH frequency hopping is performed.

A UE performing PUSCH frequency hopping shall determine its PUSCH resource allocation (RA) for the first slot of a subframe ($S1$) including the lowest index PRB ($n_{PRB}^{S1}(n)$) in subframe n from the resource allocation field in the latest PDCCH with DCI format 0 for the same transport block. If there is no PDCCH for the same transport block, the UE shall determine its hopping type based on

- the hopping information in the most recent semi-persistent scheduling assignment PDCCH, when the initial PUSCH for the same transport block is semi-persistently scheduled or
- the random access response grant for the same transport block, when the PUSCH is initiated by the random access response grant.

The resource allocation field in DCI format 0 excludes either 1 or 2 bits used for hopping information as indicated by Table 8.4-1 below where the number of PUSCH resource blocks is defined as

$$N_{RB}^{PUSCH} = \begin{cases} N_{RB}^{UL} - \tilde{N}_{RB}^{HO} - (N_{RB}^{UL} \bmod 2) & \text{Type 1 PUSCH hopping} \\ N_{RB}^{UL} & \text{Type 2 } N_{sb} = 1 \text{ PUSCH hopping} \\ N_{RB}^{UL} - \tilde{N}_{RB}^{HO} & \text{Type 2 } N_{sb} > 1 \text{ PUSCH hopping} \end{cases}$$

For type 1 and type 2 PUSCH hopping, $\tilde{N}_{RB}^{HO} = N_{RB}^{HO} + 1$ if N_{RB}^{HO} is an odd number where N_{RB}^{HO} defined in [3].

$\tilde{N}_{RB}^{HO} = N_{RB}^{HO}$ in other cases. The size of the resource allocation field in DCI format 0 after excluding either 1 or 2 bits shall be $y = \left\lceil \log_2(N_{RB}^{UL}(N_{RB}^{UL} + 1)/2) \right\rceil - N_{UL_hop}$, where $N_{UL_hop} = 1$ or 2 bits. The number of contiguous RBs that can be assigned to a type-1 hopping user is limited to $\lfloor 2^y / N_{RB}^{UL} \rfloor$. The number of contiguous RBs that can be assigned to a type-2 hopping user is limited to $\min(\lfloor 2^y / N_{RB}^{UL} \rfloor, \lfloor N_{RB}^{PUSCH} / N_{sb} \rfloor)$, where the number of sub-bands N_{sb} is given by higher layers.

A UE performing PUSCH frequency hopping shall use one of two possible PUSCH frequency hopping types based on the hopping information. PUSCH hopping type 1 is described in section 8.4.1 and type 2 is described in section 8.4.2.

Table 8.4-1: Number of Hopping Bits N_{UL_hop} vs. System Bandwidth

System BW N_{RB}^{UL}	#Hopping bits for 2nd slot RA (N_{UL_hop})
6-49	1
50-110	2

The parameter *Hopping-mode* provided by higher layers determines if PUSCH frequency hopping is “inter-subframe” or “intra and inter-subframe”.

[TS 36.213, clause 8.4.2]

In PUSCH hopping type 2 the set of physical resource blocks to be used for transmission in slot n_s is given by the scheduling grant together with a predefined pattern according to [3] section 5.3.4. If the system frame number is not acquired by the UE yet, the UE shall not transmit PUSCH with type-2 hopping and $N_{sb} > 1$ for TDD, where N_{sb} is defined in [3].

Table 8.4-2: PDCCH DCI Format 0 Hopping Bit Definition

System BW N_{RB}^{UL}	Number of Hopping bits	Information in hopping bits	$\tilde{n}_{PRB}(i)$
6 – 49	1	0	$\left(\left\lfloor N_{RB}^{PUSCH} / 2 \right\rfloor + \tilde{n}_{PRB}^{S1}(i) \right) \bmod N_{RB}^{PUSCH}$,
		1	Type 2 PUSCH Hopping
50 – 110	2	00	$\left(\left\lfloor N_{RB}^{PUSCH} / 4 \right\rfloor + \tilde{n}_{PRB}^{S1}(i) \right) \bmod N_{RB}^{PUSCH}$
		01	$\left(- \left\lfloor N_{RB}^{PUSCH} / 4 \right\rfloor + \tilde{n}_{PRB}^{S1}(i) \right) \bmod N_{RB}^{PUSCH}$
		10	$\left(\left\lfloor N_{RB}^{PUSCH} / 2 \right\rfloor + \tilde{n}_{PRB}^{S1}(i) \right) \bmod N_{RB}^{PUSCH}$
		11	Type 2 PUSCH Hopping

7.1.5.2.3 Test description

7.1.5.2.3.1 Pre-test conditions

System Simulator

- Cell 1

UE:

None.

Preamble:

- The UE is in state Loopback Activated (state 4) according to [18].

7.1.5.2.3.2 Test procedure sequence

Table 7.1.5.2.3.2-1: Main behaviour

St	Procedure	Message Sequence		TP	Verdict
		U - S	Message		
1	The SS ignores scheduling requests and does not allocate any uplink grant.	-	-	-	-
2	SS transmits a MAC PDU including 8 (FDD)/4(TDD) RLC SDU's	<--	MAC PDU	-	-
3	The SS waits for 60 ms	-	-	-	-
	Exception: Steps 4 and 5 are repeated such that UE sends data in 8 ((FDD)/4(TDD) consecutive UL TTI's.				
4	The SS is configured for Uplink Grant Allocation Type 2. SS transmits an UL Grant, allowing the UE to return 1 RLC SDU as received in step 2. Hopping flag' set as 1, all bits in ' N_{UL_hop} ' are set to 1.	<--	(UL Grant (C-RNTI))	-	-
5	Check: Does the UE transmit a MAC PDU corresponding to grant in step 4?	-->	MAC PDU	1	P

Note 1: steps 4 and 5 are repeated for 8 times corresponding to 8 sub frames for FDD and 4 for default TDD configuration 1.
 Note 2: The grant allocated in step 4 is such that the loop back PDU's are received in 8 (FDD)/4(TDD) UL TTI's

7.1.5.2.3.3 Specific message contents.

Table 7.1.5.2.3.3-1: SystemInformationBlockType2(preamble)

Derivation Path: 36.508 Table 4.4.3.3-1			
Information Element	Value/remark	Comment	Condition
SystemInformationBlockType2 ::= SEQUENCE {			
radioResourceConfigCommon SEQUENCE {	RadioResourceCo nfigCommonSIB- DEFAULT-7152		
}			

Table 7.1.5.2.3.3-2: RadioResourceConfigCommonSIB-DEFAULT-7152(Table 7.1.5.2.3.3-1)

Derivation Path: 36.508 Table 4.6.3-14			
Information Element	Value/remark	Comment	Condition
RadioResourceConfigCommonSIB-DEFAULT-7152 ::= SEQUENCE {			
pusch-Config	PUSCH-ConfigCommon- DEFAULT-7152		
}			

Table 7.1.5.2.3.3-3: PUSCH-ConfigCommon-DEFAULT-7152(Table 7.1.5.2.3.3-2)

Derivation Path: 36.508 table 4.6.3-10			
Information Element	Value/remark	Comment	Condition
PUSCH-ConfigCommon-DEFAULT-7152 ::= SEQUENCE {			
pusch-ConfigBasic SEQUENCE {			
n-SB	1	Default value	
hoppingMode	intraAndInterSubFrame		
pusch-HoppingOffset	See subclause 4.6.8[36.508]	Default value	
}			
}			

7.1.5.3 Predefined intra-TTI PUSCH hopping ($N_{sb}=2/3/4$)

7.1.5.3.1 Test Purpose (TP)

(1)

```

with { UE in E-UTRA RRC_CONNECTED state, number of sub bands 'N-sb' is set to 2/3/4 and 'Hopping-
mode' is set to 'intraAndInterSubFrame' }
ensure that {
  when { UE receives for a TTI an uplink grant with 'Hopping flag' set as 1, 'NUL_hop' bits all set to
1(Type 2 predefined hopping) }
  then { UE transmits data with predefined, inter-TTI PUSCH hopping}
}

```

7.1.5.3.2 Conformance requirements

Same Conformance requirements as in clause 7.1.5.2.2

7.1.5.3.3 Test description

7.1.5.3.3.1 Pre-test conditions

System Simulator

- Cell 1

UE:

None.

Preamble:

- The UE is in state Registered, Idle mode, Test Mode Activated (State 2A) according to [18].

7.1.5.3.3.2 Test procedure sequence

Table 7.1.5.3.3.2-1: Main behaviour

St	Procedure	Message Sequence		TP	Verdict
		U - S	Message		
	EXCEPTION: Step 0 to 7 are repeated for execution counter k=1 to 3				
0	The SS transmits a Paging message in a paging occasion including a <i>systemInfoModification</i> .	<--	<i>Paging</i>	-	-
0a	From the beginning of the next modification period the SS transmits a modified <i>SystemInformationBlockType2</i> as specified.	-	-	-	-
1	The UE is brought to state Loopback Activated (state 4) according to [18]	-	-	-	-
2	The SS ignores scheduling requests and does not allocate any uplink grant.	-	-	-	-
3	SS transmits a MAC PDU including a RLC SDU	<--	MAC PDU	1	-
4	The SS waits for 60 ms		-	-	-
5	The SS is configured for Uplink Grant Allocation Type 2. SS transmits an UL Grant, allowing the UE to return the RLC SDU as received in step 2. Hopping flag' set as 1, 'N _{UL_hop} ' is set to 1.	<--	(UL Grant (C-RNTI))	-	-
6	Check: Does the UE transmit a MAC PDU corresponding to grant in step 4?	-	-	1	P
7	The SS releases the RRC connection	-	-	-	-

7.1.5.3.3.3 Specific message contents.

Table 7.1.5.3.3.3-1: SystemInformationBlockType2 (Step 0 of Table 7.1.5.3.3.2-1)

Derivation Path: 36.331 clause 6.3.1			
Information Element	Value/remark	Comment	Condition
SystemInformationBlockType2 ::= SEQUENCE {			
ac-BarringInfo SEQUENCE {}	Not present		
radioResourceConfigCommon SEQUENCE {}	RadioResourceCo nfigCommonSIB- DEFAULT-7153		
}			

Table 7.1.5.3.3.3-2: RadioResourceConfigCommonSIB-DEFAULT-7153

Derivation Path: 36.508 Table 4.6.3-14			
Information Element	Value/remark	Comment	Condition
RadioResourceConfigCommonSIB-DEFAULT-7153 ::= SEQUENCE {			
pusch-Config	PUSCH-ConfigCommon- DEFAULT-7153		
}			

Table 7.1.5.3.3.3-3: PUSCH-ConfigCommon-DEFAULT-7153

Derivation Path: 36.508 table 4.6.3-10			
Information Element	Value/remark	Comment	Condition
PUSCH-ConfigCommon-DEFAULT-7153 ::= SEQUENCE {			
pusch-ConfigBasic SEQUENCE {			
n-SB	2		Execution counter k =1
n-SB	3		Execution counter k =2
n-SB	4		Execution counter k =3
hoppingMode	intraAndInterSubFrame		
pusch-HoppingOffset	See subclause 4.6.8	Default value	
enable64QAM	FALSE	Default value	
}			
}			

7.1.5.4 Predefined inter-TTI PUSCH hopping (N_{sb}=1)

7.1.5.4.1 Test Purpose (TP)

(1)

```

with { UE in E-UTRA RRC_CONNECTED state, number of sub bands 'N-sb' is set to 1 and 'Hopping-mode'
is set to 'interSubFrame' }
ensure that {
  when { UE receives for a TTI an uplink grant with 'Hopping flag' set as 1, 'NUL_hop' bits all set to
1 (Type 2 predefined hopping) }
  then { UE transmits data with predefined, inter-TTI PUSCH hopping }
}
with { UE in E-UTRA RRC_CONNECTED state, number of sub bands 'N-sb' is set to 1, 'Hopping-mode' is
set to 'interSubFrame' has transmitted a transport block with predefined, inter-TTI PUSCH hopping }
ensure that {
  when { UE has to make a non adaptive retransmission) }
  then { UE transmits data with predefined, inter-TTI PUSCH hopping }
}

```

7.1.5.4.2 Conformance requirements

Same Conformance requirements as in clause 7.1.5.2.2

7.1.5.4.3 Test description

7.1.5.4.3.1 Pre-test conditions

Same Pre-test conditions as in clause 7.1.5.2.3.1

7.1.5.4.3.2 Test procedure sequence

Table 7.1.5.4.3.2-1: Main behaviour

St	Procedure	Message Sequence		TP	Verdict
		U - S	Message		
1	The SS ignores scheduling requests and does not allocate any uplink grant.	-	-	-	-
2	SS transmits a MAC PDU including a RLC SDU	<--	MAC PDU	1	-
3	The SS waits for 60 ms.	-	-	-	-
4	The SS is configured for Uplink Grant Allocation Type 2. SS transmits an UL Grant, allowing the UE to return the RLC SDU as received in step 2. Hopping flag' set as 1, all bits in ' N_{UL_hop} ' are set to 1.	<--	(UL Grant (C-RNTI))	-	-
5	Check: Does the UE transmit a MAC PDU corresponding to grant in step 4?	-	MAC PDU	1	P
6	The SS transmits a HARQ NACK	<--	HARQ NACK	-	-
7	Check: Does the UE transmit a MAC PDU corresponding to grant in step 4, for same HARQ process as in step 5?	-->	MAC PDU	2	P
8	The SS transmits a HARQ NACK	<--	HARQ NACK	-	-
9	Check: Does the UE transmit a MAC PDU corresponding to grant in step 4, for same HARQ process as in step 7?	-->	MAC PDU	2	P
10	The SS transmits a HARQ NACK	<--	HARQ NACK	-	-
11	Check: Does the UE transmit a MAC PDU corresponding to grant in step 4, for same HARQ process as in step 9?	-->	MAC PDU	2	P
12	The SS transmits an HARQ ACK	<--	HARQ ACK	-	-

Note: 4 HARQ transmissions is selected to be less than MaxHARQ-Tx (=5)

7.1.5.4.3.3 Specific message contents.

None

7.1.5.5 Predefined inter-TTI PUSCH hopping ($N_{sb}=2/3/4$)

7.1.5.5.1 Test Purpose (TP)

(1)

```

with { UE in E-UTRA RRC_CONNECTED state, number of sub bands 'N-sb' is set to 2/3/4 and 'Hopping-
mode' is set to 'interSubFrame' }
ensure that {
  when { UE receives for a TTI an uplink grant with 'Hopping flag' set as 1, ' $N_{UL\_hop}$ ' bits are all
set to 1(Type 2 predefined hopping) }
  then { UE transmits data with predefined, inter-TTI PUSCH hopping}
}

```

7.1.5.5.2 Conformance requirements

Same Conformance requirements as in clause 7.1.5.2.2

7.1.5.5.3 Test description

7.1.5.5.3.1 Pre-test conditions

Same Pre-test conditions as in clause 7.1.5.3.3.1

7.1.5.5.3.2 Test procedure sequence

Same Test procedure sequence as in table 7.1.5.3.3.2-1

7.1.5.5.3.3 Specific message contents.

Table 7.1.5.5.3.3-1: SystemInformationBlockType2 (Step 0 of Table 7.1.5.3.3.2-1)

Derivation Path: 36.331 clause 6.3.1			
Information Element	Value/remark	Comment	Condition
SystemInformationBlockType2 ::= SEQUENCE {			
ac-BarringInfo SEQUENCE {	Not present		
radioResourceConfigCommon SEQUENCE {	RadioResourceCo nfigCommonSIB- DEFAULT-7155		
}			

Table 7.1.5.5.3.3-2: RadioResourceConfigCommonSIB-DEFAULT-7155

Derivation Path: 36.508 Table 4.6.3-14			
Information Element	Value/remark	Comment	Condition
RadioResourceConfigCommonSIB-DEFAULT-7155 ::= SEQUENCE {			
pusch-Config	PUSCH-ConfigCommon- DEFAULT-7155		
}			

Table 7.1.5.5.3.3-3: PUSCH-ConfigCommon-DEFAULT-7155

Derivation Path: 36.508 table 4.6.3-10			
Information Element	Value/remark	Comment	Condition
PUSCH-ConfigCommon-DEFAULT-7155 ::= SEQUENCE {			
pusch-ConfigBasic SEQUENCE {			
n-SB	2		Execution counter k =1
n-SB	3		Execution counter k =2
n-SB	4		Execution counter k =3
hoppingMode	interSubFrame	Default value	
pusch-HoppingOffset	See subclause 4.6.8	Default value	
enable64QAM	FALSE	Default value	
}			
}			

7.1.6 DRX operation

7.1.6.1 DRX operation / Short cycle not configured / Parameters configured by RRC

7.1.6.1.1 Test Purpose (TP)

(1)

```

with { UE in CONNECTED mode }
ensure that {
  when { Long DRX cycle is configured and [(SFN * 10) + subframe number] modulo (LongDRX-Cycle) =
drxStartOffset }
    then { UE starts the OnDurationTimer and monitors the PDCCH for OnDurationTimer PDCCH-subframes
  }
}

```

(2)

```

with { UE in CONNECTED mode }
ensure that {
  when { Long DRX cycle is configured and a new DL transmission is indicated on the PDCCH during
Active Time }

```

```

    then { UE starts or restarts the Drx-InactivityTimer and monitors the PDCCH for Drx-
    InactivityTimer PDCCH sub-frames starting from the next PDCCH sub-frame of the PDCCH sub-frame where
    the DL new transmission was indicated }
  }

```

(3)

```

with { UE in CONNECTED mode }
ensure that {
  when { Long DRX cycle is configured and if a HARQ RTT Timer expires in this subframe and the data
  in the soft buffer of the corresponding HARQ process was not successfully decoded }
  then { UE starts the drx-RetransmissionTimer for the corresponding HARQ process and monitors the
  PDCCH for drx-RetransmissionTimer consecutive PDCCH-subframes }
}

```

(4)

```

with { UE in CONNECTED mode }
ensure that {
  when { Long DRX cycle is configured and an uplink grant for a pending HARQ retransmission can
  occur in this subframe }
  then { UE monitors the PDCCH in this subframe }
}

```

7.1.6.1.2 Conformance requirements

References: The conformance requirements covered in the current TC are specified in: TS 36.321, clauses 3.1 and 5.7.

[TS 36.321, clause 3.1]

Active Time: Time related to DRX operation, as defined in subclause 5.7, during which the UE monitors the PDCCH in PDCCH-subframes.

...

DRX Cycle: Specifies the periodic repetition of the On Duration followed by a possible period of inactivity (see figure 3.1-1 below).

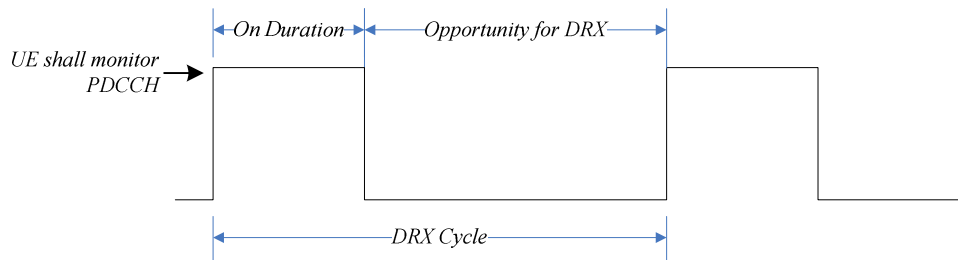

Figure 3.1-1: DRX Cycle

drx-InactivityTimer: Specifies the number of consecutive PDCCH-subframe(s) after successfully decoding a PDCCH indicating an initial UL or DL user data transmission for this UE.

drx-RetransmissionTimer: Specifies the maximum number of consecutive PDCCH-subframe(s) for as soon as a DL retransmission is expected by the UE.

drxShortCycleTimer: Specifies the number of consecutive subframe(s) the UE shall follow the short DRX cycle.

drxStartOffset: Specifies the subframe where the DRX Cycle starts.

...

HARQ RTT Timer: This parameter specifies the minimum amount of subframe(s) before a DL HARQ retransmission is expected by the UE.

...

onDurationTimer: Specifies the number of consecutive PDCCH-subframe(s) at the beginning of a DRX Cycle.

PDCCH-subframe: For FDD UE operation, this represents any subframe; for TDD, only downlink subframes and subframes including DwPTS.

[TS 36.321, clause 5.7]

The UE may be configured by RRC with a DRX functionality that controls the UE's PDCCH monitoring activity for the UE's C-RNTI, TPC-PUCCH-RNTI, TPC-PUSCH-RNTI and Semi-Persistent Scheduling C-RNTI (if configured). When in RRC_CONNECTED, if DRX is configured, the UE is allowed to monitor the PDCCH discontinuously using the DRX operation specified in this subclause; otherwise the UE monitors the PDCCH continuously. When using DRX operation, the UE shall also monitor PDCCH according to requirements found in other subclauses of this specification. RRC controls DRX operation by configuring the timers *onDurationTimer*, *drx-InactivityTimer*, *drx-RetransmissionTimer* (one per DL HARQ process except for the broadcast process), the *longDRX-Cycle*, the value of the *drxStartOffset* and optionally the *drxShortCycleTimer* and *shortDRX-Cycle*. A HARQ RTT timer per DL HARQ process (except for the broadcast process) is also defined (see subclause 7.7).

When a DRX cycle is configured, the Active Time includes the time while:

- *onDurationTimer* or *drx-InactivityTimer* or *drx-RetransmissionTimer* or *mac-ContentionResolutionTimer* (as described in subclause 5.1.5) is running; or
- a Scheduling Request sent on PUCCH is pending (as described in subclause 5.4.4); or
- an uplink grant for a pending HARQ retransmission can occur and there is data in the corresponding HARQ buffer; or
- a PDCCH indicating a new transmission addressed to the C-RNTI of the UE has not been received after successful reception of a Random Access Response for the explicitly signalled preamble (as described in subclause 5.1.4).

When DRX is configured, the UE shall for each subframe:

- If the Short DRX Cycle is used and $[(SFN * 10) + \text{subframe number}] \bmod (shortDRX-Cycle) = (drxStartOffset) \bmod (shortDRX-Cycle)$; or
- if the Long DRX Cycle is used and $[(SFN * 10) + \text{subframe number}] \bmod (LongDRX-Cycle) = drxStartOffset$:
 - start *onDurationTimer*.
- if a HARQ RTT Timer expires in this subframe and the data in the soft buffer of the corresponding HARQ process was not successfully decoded:
 - start the *drx-RetransmissionTimer* for the corresponding HARQ process.
- if a DRX Command MAC control element is received:
 - stop *onDurationTimer*;
 - stop *drx-InactivityTimer*.
- if *drx-InactivityTimer* expires or a DRX Command MAC control element is received in this subframe:
 - if the short DRX cycle is configured:
 - start or restart *drxShortCycleTimer*;
 - use the Short DRX Cycle.
 - else:
 - use the Long DRX cycle.
- if *drxShortCycleTimer* expires in this subframe:

- use the long DRX cycle.
- during the Active Time, for a PDCCH-subframe if the subframe is not required for uplink transmission for half-duplex FDD UE operation and if the subframe is not part of a configured measurement gap:
 - monitor the PDCCH;
 - if the PDCCH indicates a DL transmission or if a DL assignment has been configured for this subframe:
 - start the HARQ RTT Timer for the corresponding HARQ process;
 - stop the *drx-RetransmissionTimer* for the corresponding HARQ process.
 - if the PDCCH indicates a new transmission (DL or UL):
 - start or restart *drx-InactivityTimer*.
- when not in Active Time, CQI/PMI/RI on PUCCH and SRS shall not be reported.

Regardless of whether the UE is monitoring PDCCH or not the UE receives and transmits HARQ feedback when such is expected.

NOTE: A UE may optionally choose to not send CQI/PMI/RI reports on PUCCH and/or SRS transmissions for up to 4 subframes following a PDCCH indicating a new transmission (UL or DL) received in the last subframe of active time. The choice not to send CQI/PMI/RI reports on PUCCH and/or SRS transmissions is not applicable for subframes where *onDurationTimer* is running.

7.1.6.1.3 Test description

7.1.6.1.3.1 Pre-test conditions

System Simulator:

- Cell 1

UE:

None.

Preamble:

- The UE is in state Loopback Activated (state 4) according to [18] configured to return no data in UL.

7.1.6.1.3.2 Test procedure sequence

For FDD, $NormalSF(\text{current SFN}, \text{current subframe number}, y) = y$; For TDD, $NormalSF(\text{current SFN}, \text{current subframe number}, y)$ counts the minimum number of normal subframes needed to cover y number of PDCCH-subframes until next PDCCH-subframe available, starting from current subframe number on current SFN. For example at step 1, *drxStartOffset* can point to UL or DL subframe for TDD. If it points to a UL subframe, $NormalSF(\text{current SFN}, \text{current subframe number}, 0)$ counts the number of normal subframes until reach the first DL/special subframe available. If *drxStartOffset* points to a DL subframe, $NormalSF(\text{current SFN}, \text{current subframe number}, 0) = 0$.

For example at step 13, assuming *drxStartOffset* points to subframe number 0 at frame number A , $NormalSF(A, 0, \text{onDurationTimer}-2)$ is first added, which counts 18 PDCCH-subframes/30 normal subframes in this case. The current subframe becomes subframe number 0 at frame number $A+3$. Secondly, *HARQ RTT timer* is added, which is 11 normal subframes. The current subframe becomes subframe number 1 at frame number $A+4$. To further add in $NormalSF(A+4, 1, \text{drx-RetransmissionTimer}-1)$, which is to counts 5 PDCCH-subframes/9 normal subframes, the current subframe is subframe number 0 at frame number $A+5$.

Table 7.1.6.1.3.2-1: Main Behaviour

St	Procedure	Message Sequence		TP	Verdict
		U - S	Message		
0A	SS Transmits RRCConnectionReconfiguration to configure specific DRX parameters	<--	-	-	-
0B	The UE transmits RRCConnectionReconfigurationComplete	-->	-	-	-
1	In the first PDCCH sub frame when the OnDurationTimer is running, the SS indicates the transmission of a DL MAC PDU on the PDCCH. i.e., on the subframe with the subframe number = $[\text{csfn1} + \text{NormalSF}(\text{SFN1}, \text{csfn1}, 0)]$ modulo 10, and system frame number = $\text{SFN1} + \text{floor}([\text{csfn1} + \text{NormalSF}(\text{SFN1}, \text{csfn1}, 0)]/10)$; where $[(\text{SFN1} * 10) + \text{csfn1}]$ modulo (LongDRX-Cycle) = drxStartOffset	<--	MAC PDU	-	-
2	Check: Does the UE transmit a HARQ ACK for the DL MAC PDU in Step 1?	-->	HARQ ACK	1	P
3	At least drx-InactivityTimer PDCCH-sub frames after the transmission of the MAC PDU in Step 1 has been indicated (This means the next DRX cycle or later after Step 1) in the last PDCCH sub frame while the onDurationTimer is still running, the SS indicates the transmission a DL MAC PDU on the PDDCH. (Note 4). i.e., on the subframe with the subframe number = $[\text{csfn2} + \text{NormalSF}(\text{SFN2}, \text{csfn2}, \text{onDurationTimer}-1)]$ modulo 10, and system frame number = $\text{SFN2} + \text{floor}([\text{csfn2} + \text{NormalSF}(\text{SFN2}, \text{csfn2}, \text{onDurationTimer}-1)]/10)$; where $[(\text{SFN2} * 10) + \text{csfn2}]$ modulo (LongDRX-Cycle) = drxStartOffset	<--	MAC PDU	-	-
4	Check: Does the UE transmit a HARQ ACK for the DL MAC PDU in Step 3?	-->	HARQ ACK	1	P
5	drx-InactivityTimer PDCCH-subframes after the transmission of the MAC PDU transmitted in step 3 was indicated on the PDCCH, the SS indicates the transmission of a DL MAC PDU on the PDCCH. (Note 4) i.e. on the subframe with the subframe number = $[\text{csfn2} + \text{NormalSF}(\text{SFN2}, \text{csfn2}, \text{onDurationTimer} + \text{drx-InactivityTimer}-1)]$ modulo 10, and system frame number = $\text{SFN2} + \text{floor}([\text{csfn2} + \text{NormalSF}(\text{SFN2}, \text{csfn2}, \text{onDurationTimer} + \text{drx-InactivityTimer}-1)]/10)$	<--	MAC PDU	-	-
6	Check: Does the UE transmit a HARQ ACK for the DL MAC PDU in Step 5?	-->	HARQ ACK	2	P
7	At least drx-InactivityTimer PDCCH sub frames after the transmission of the MAC PDU in Step 5 has been indicated (This means the next DRX cycle or later after Step 3) and 1 PDCCH sub-frame before the OnDurationTimer expires, the SS indicates the transmission of a DL MAC PDU on the PDDCH. The DL MAC PDU transmitted is invalid. (Note 1, Note 4) i.e., on the subframe with the subframe number = $[\text{csfn3} + \text{NormalSF}(\text{SFN3}, \text{csfn3}, \text{onDurationTimer}-2)]$ mod 10, and system	<--	Invalid MAC PDU	-	-

	frame number = $SFN3 + \text{floor}([\text{csfn3} + \text{NormalSF}(SFN3, \text{csfn3}, \text{onDurationTimer-2})]/10)$; where $[(SFN3 * 10) + \text{csfn3}] \text{ modulo } (\text{LongDRX-Cycle}) = \text{drxStartOffset}$				
8	Check: Does the UE transmit a HARQ NACK for the DL MAC PDU in Step 7?	-->	HARQ NACK	1	P
9	In the first PDCCH sub frame when the Drx-RetransmissionTimer for the MAC PDU in Step 7 is started, the SS indicates the transmission of a DL MAC PDU on the PDCCH. i.e., on the subframe with the subframe number = $[\text{csfn4} + \text{NormalSF}(SFN4, \text{csfn4}, 0)] \text{ modulo } 10$, and system frame number = $SFN4 + \text{floor}([\text{csfn4} + \text{NormalSF}(SFN4, \text{csfn4}, 0)]/10)$; where $\text{csfn4} = [\text{csfn3} + \text{NormalSF}(SFN3, \text{csfn3}, \text{onDurationTimer-2}) + \text{HARQ RTT timer}] \text{ modulo } 10$ and $SFN4 = SFN3 + \text{floor}([\text{csfn3} + \text{NormalSF}(SFN3, \text{csfn3}, \text{onDurationTimer-2}) + \text{HARQ RTT timer}]/10)$ For TDD the HARQ RTT timer is the HARQ RTT timer for the DL transmission in Step 7.	<--	MAC PDU	-	-
10	Check: Does the UE transmit a HARQ ACK for the DL MAC PDU in Step 9?	-->	HARQ ACK	3	P
11	At least drx-InactivityTimer PDCCH sub frames after the transmission of the DL MAC PDU in Step 9 has been indicated (This means the next DRX cycle or later after Step 9) and 1 PDCCH sub-frame before the OnDurationTimer expires, the SS indicates the transmission of DL MAC PDU on the PDCCH. The DL MAC PDU transmitted is invalid(Note 1, Note 4) i.e., on the subframe with the subframe number = $[\text{csfn5} + \text{NormalSF}(SFN5, \text{csfn5}, \text{onDurationTimer-2})] \text{ modulo } 10$ and system frame number = $SFN5 + \text{floor}([\text{csfn5} + \text{NormalSF}(SFN5, \text{csfn5}, \text{onDurationTimer-2})]/10)$; where $[(SFN5 * 10) + \text{csfn5}] \text{ modulo } (\text{LongDRX-Cycle}) = \text{drxStartOffset}$	<--	Invalid MAC PDU	-	-
12	Check: Does the UE transmit a HARQ NACK for the DL MAC PDU in Step 11?	-->	HARQ NACK	1	P
13	In the last PDCCH sub frame when the drx-RetransmissionTimer for MAC PDU in Step 11 is still running, the SS indicates the transmission of a DL MAC PDU on the PDCCH. i.e. on the subframe with subframe number = $[\text{csfn6} + \text{NormalSF}(SFN6, \text{csfn6}, \text{drx-RetransmissionTimer} - 1)] \text{ modulo } 10$ and the system frame number = $SFN6 + \text{floor}([\text{csfn6} + \text{NormalSF}(SFN6, \text{csfn6}, \text{drx-RetransmissionTimer} - 1)]/10)$; where the $\text{csfn6} = [\text{csfn5} + \text{NormalSF}(SFN5, \text{csfn5}, \text{onDurationTimer-2}) + \text{HARQ RTT timer}] \text{ modulo } 10$ and $SFN6 = SFN5 + \text{floor}([\text{csfn5} + \text{NormalSF}(SFN5, \text{csfn5}, \text{onDurationTimer-2}) + \text{HARQ RTT timer}]/10)$; For TDD the HARQ RTT timer is the HARQ RTT timer for the DL transmission in Step 11.	<--	MAC PDU	-	-
14	Check: Does the UE transmit a HARQ ACK for	-->	HARQ ACK	3	P

	the DL MAC PDU in Step 13?				
15	<p>The SS is configured for Uplink Grant Allocation Type 2. At least drx-InactivityTimer PDCCH sub frames after the transmission of the DL MAC PDU in Step 13 has been indicated in the last sub-frame when the onDurationTimer is still running (This means the next DRX cycle or later after Step 7), the SS indicates an UL grant to the UE on the PDCCH. (Note 4)</p> <p>i.e., on the subframe with the subframe number = $[\text{csfn7} + \text{NormalSF}(\text{SFN7}, \text{csfn7}, \text{onDurationTimer}-1)] \bmod 10$ and system frame number = $\text{SFN7} + \text{floor}([\text{csfn7} + \text{NormalSF}(\text{SFN7}, \text{csfn7}, \text{onDurationTimer}-1)]/10)$; where $[(\text{SFN7} * 10) + \text{csfn7}] \bmod 10 = \text{drxStartOffset}$</p>	<--	UL grant on PDCCH	-	-
16	Check: Does the UE transmit a Buffer Status Report on the UL indicating an empty buffer?	-->	Buffer Status Report MAC control element	-	-
17	<p>X sub frames after the sub frame in which the UL grant was indicated on the PDCCH for the UL MAC PDU sent in the previous step the SS indicates the transmission of a DL MAC PDU on the PDCCH.</p> <p><i>X is the number of sub frames required to do a retransmission of the UL MAC PDU transmitted in the previous Step maxHARQ-Tx -1 times (for FDD this is 8x maxHARQ-Tx sub frames, for TDD this is 10x maxHARQ-Tx sub frames considering the default configuration 1.).</i></p>	<--	MAC PDU	-	-
18	Check: Does the UE transmit a HARQ ACK for the DL MAC PDU in Step 17?	-->	HARQ ACK	4	P
<p>Note 1: Invalid MAC PDU is a MAC PDU that fails the CRC check.</p> <p>Note 2: All the DL MAC PDU are transmitted with the NDI set on the PDCCH.</p> <p>Note 3: Timer tolerances for the MAC DRX related timers measured in subframes or PDCCH subframes is 0. These timers are: drx-InactivityTimer, drx-RetransmissionTimer, HARQ RTT Timer.</p> <p>Note 4: The drx-InactivityTimer is started in the next PDCCH sub-frame of the PDCCH sub-frame where DL new transmission is indicated.</p>					

7.1.6.1.3.3 Specific message contents

Table 7.1.6.1.3.3-1: specific Parameters in *RRCConnectionReconfiguration* (step 0A of table 7.1.6.1.3.2-1)

Derivation Path: 36.508 Table 4.6.1-8			
Information Element	Value/remark	Comment	Condition
measConfig	Not present		
mobilityControlInfo	Not present		
dedicatedInfoNASList	Not present		
radioResourceConfigDedicated::= SEQUENCE {			
srb-ToAddModList	Not present		
drb-ToAddModList	Not present		
drb-ToReleaseList	Not present		
mac-MainConfig CHOICE {			
explicitValue::= SEQUENCE {			
ul-SCH-Config SEQUENCE {			
maxHARQ-Tx	n5		
retxBSR-Timer	sf10240		
ttiBundling	FALSE		
}			
drx-Config CHOICE {			
setup SEQUENCE {			
onDurationTimer	psf20		
drx-InactivityTimer	psf6		
drx-RetransmissionTimer	psf6		
longDRX-CycleStartOffset CHOICE {			
sf640	4		
}			
shortDRX	Not present		
}			
timeAlignmentTimerDedicated	infinity		
phr-Config CHOICE {			
release	NULL		
}			
}			
}			

7.1.6.2 DRX Operation / Short cycle not configured / DRX command MAC control element reception

7.1.6.2.1 Test Purpose (TP)

(1)

```
with { UE in CONNECTED mode }
ensure that {
  when { long DRX cycle is configured and a DRX Command MAC control element is received }
  then { UE successfully decodes the MAC control PDU }
}
```

(2)

```
with { UE in CONNECTED mode }
ensure that {
  when { long DRX cycle is configured and the HARQ RTT Timer is running and a DRX Command MAC control element is received }
  then { UE continues running the HARQ RTT timer }
}
```

(3)

```
with { UE in CONNECTED mode }
ensure that {
```

```

when { long DRX cycle is configured and the drx-RetransmissionTimer is running and a DRX Command
MAC control element is received }
  then { UE continues running the drx-RetransmissionTimer and monitors the PDCCH }
  }

```

7.1.6.2.2 Conformance requirements

References: The conformance requirements covered in the current TC are specified in: TS 36.321, clauses 3.1 and 5.7.

[TS 36.321, clause 3.1]

Active Time: Time related to DRX operation, as defined in subclause 5.7, during which the UE monitors the PDCCH in PDCCH-subframes.

...

DRX Cycle: Specifies the periodic repetition of the On Duration followed by a possible period of inactivity (see figure 3.1-1 below).

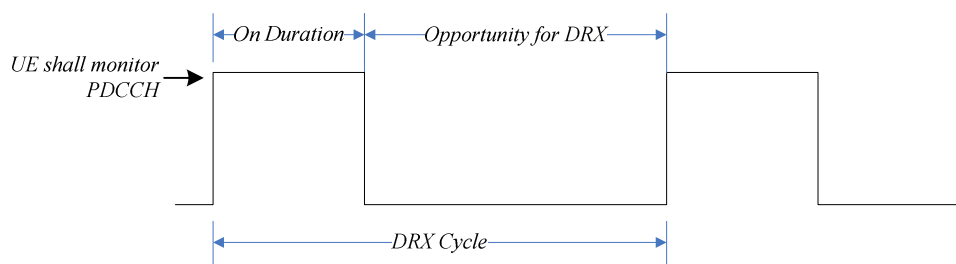

Figure 3.1-1: DRX Cycle

drx-InactivityTimer: Specifies the number of consecutive PDCCH-subframe(s) after successfully decoding a PDCCH indicating an initial UL or DL user data transmission for this UE.

drx-RetransmissionTimer: Specifies the maximum number of consecutive PDCCH-subframe(s) for as soon as a DL retransmission is expected by the UE.

drxShortCycleTimer: Specifies the number of consecutive subframe(s) the UE shall follow the short DRX cycle.

drxStartOffset: Specifies the subframe where the DRX Cycle starts.

...

HARQ RTT Timer: This parameter specifies the minimum amount of subframe(s) before a DL HARQ retransmission is expected by the UE.

...

onDurationTimer: Specifies the number of consecutive PDCCH-subframe(s) at the beginning of a DRX Cycle.

PDCCH-subframe: For FDD UE operation, this represents any subframe; for TDD, only downlink subframes and subframes including DwPTS.

[TS 36.321, clause 5.7]

- if a HARQ RTT Timer expires in this subframe and the data in the soft buffer of the corresponding HARQ process was not successfully decoded:
 - start the *drx-RetransmissionTimer* for the corresponding HARQ process.
- if a DRX Command MAC control element is received:
 - stop *onDurationTimer*;
 - stop *drx-InactivityTimer*.

- if *drx-InactivityTimer* expires or a DRX Command MAC control element is received in this subframe:
 - if the short DRX cycle is configured:
 - start or restart *drxShortCycleTimer*;
 - use the Short DRX Cycle.
 - else:
 - use the Long DRX cycle.
- if *drxShortCycleTimer* expires in this subframe:
 - use the long DRX cycle.
- during the Active Time, for a PDCCH-subframe except if the subframe is required for uplink transmission for half-duplex FDD UE operation and except if the subframe is part of a configured measurement gap:
 - monitor the PDCCH;
 - if the PDCCH indicates a DL transmission or if a DL assignment has been configured for this subframe:
 - start the HARQ RTT Timer for the corresponding HARQ process;
 - stop the *drx-RetransmissionTimer* for the corresponding HARQ process.
 - if the PDCCH indicates a new transmission (DL or UL):
 - start or restart *drx-InactivityTimer*.
- when not in Active Time, CQI/PMI/RI on PUCCH and SRS shall not be reported.

Regardless of whether the UE is monitoring PDCCH or not the UE receives and transmits HARQ feedback when such is expected.

7.1.6.2.3 Test description

7.1.6.2.3.1 Pre-test conditions

System Simulator:

- Cell 1

UE:

None.

Preamble:

- The UE is in state Loopback Activated (state 4) according to [18] configured to return no data in UL.

7.1.6.2.3.2 Test procedure sequence

The definition of *NormalSF*(current SFN,current subframe number,y) can be found in clause 7.1.6.1.3.2.

Table 7.1.6.2.3.2-1: Main Behaviour

St	Procedure	Message Sequence		TP	Verdict
		U - S	Message		
0A	SS Transmits RRCConnectionReconfiguration to configure specific DRX parameters	<--	-	-	-
0B	The UE transmits RRCConnectionReconfigurationComplete	-->	-	-	-
1	In a PDCCH sub frame which is X PDCCH sub frames before the PDCCH sub-frame in which the onDurationTimer expires, with $drx\text{-}InactivityTimer < X <$ the number of PDCCH subframes encapsulated by HARQ RTT timer, the SS indicates the transmission of a DL MAC PDU on the PDCCH. The SS transmits an invalid MAC PDU.(Note 1) i.e., on the subframe with the subframe number $csfn2 = [csfn1 + NormalSF(SFN1, csfn1, onDurationTimer - 1 - X)] \text{ modulo } 10$, and the system frame number $SFN2 = SFN1 + \text{floor}([csfn1 + NormalSF(SFN1, csfn1, onDurationTimer - 1 - X)]/10)$; and $[(SFN1 * 10) + csfn1] \text{ modulo } (Long\ DRX\ Cycle) = drxStartOffset$.	<--	MAC PDU	-	-
2	Check: Does the UE transmit a HARQ NACK for the DL MAC PDU in Step 1?	-->	HARQ NACK	1	P
3	In a PDCCH sub frames before the onDurationTimer expires, the SS indicates the transmission of a DL MAC PDU on the PDCCH. The SS transmits a DL MAC PDU with DRX MAC Control element. UE successfully decodes the MAC PDU. i.e., on the subframe with the subframe number $csfn3 = [csfn1 + NormalSF(SFN1, csfn1, onDurationTimer - 1 - X + Y)] \text{ modulo } 10$, and the system frame number $SFN3 = SFN1 + \text{floor}([csfn1 + NormalSF(SFN1, csfn1, onDurationTimer - 1 - X + Y)]/10)$; and $0 < Y < X$	<--	MAC PDU(DRX MAC Control element)	-	-
4	Check: Does the UE transmit a HARQ ACK for the DL MAC PDU in Step 3?	-->	HARQ ACK	1	P
5	In the PDCCH sub frame when the drx-RetransmissionTimer for the MAC PDU indicated in Step 1 on the PDCCH is started the SS indicates the transmission of a DL MAC PDU. The SS transmits an invalid MAC PDU.(Note 1) i.e., on the subframe with the subframe number $csfn5 = [csfn4 + NormalSF(SFN4, csfn4, 0)] \text{ modulo } 10$, and the system frame number $SFN5 = SFN4 + \text{floor}([csfn4 + NormalSF(SFN4, csfn4, 0)]/10)$; where $csfn4 = [csfn2 + HARQ\ RTT\ Timer] \text{ modulo } 10$, and the $SFN4 = SFN2 + \text{floor}([csfn2 + HARQ\ RTT\ Timer]/10)$; For TDD the HARQ RTT timer is the HARQ RTT timer for the DL transmission in Step 1	<--	MAC PDU	-	-
6	Check: Does the UE transmit a HARQ NACK for the DL MAC PDU in Step 5?	-->	HARQ NACK	2,3	P
7	Z PDCCH sub frames, where $Z > drx\text{-}InactivityTimer$, before the PDCCH sub-frame in which the drx-RetransmissionTimer for the DL MAC PDU in	<--	MAC PDU(DRX MAC Control element)	-	-

	<p>Step 5 expires, the SS indicates the transmission of a DL MAC PDU. The SS transmits a DL MAC PDU with DRX MAC Control element.</p> <p>i.e., on the subframe with the subframe number = $[\text{csfn6} + \text{NormalSF}(\text{SFN6}, \text{csfn6}, \text{drx-RetransmissionTimer} - Z)] \text{ modulo } 10$, and the system frame number = $\text{SFN6} + \text{floor}([\text{csfn6} + \text{NormalSF}(\text{SFN6}, \text{csfn6}, \text{drx-RetransmissionTimer} - Z)]/10)$; where $\text{csfn6} = [\text{csfn5} + \text{HARQ RTT Timer}] \text{ modulo } 10$, and the $\text{SFN6} = \text{SFN5} + \text{floor}([\text{csfn5} + \text{HARQ RTT Timer}]/10)$;</p> <p>For TDD the HARQ RTT timer is the HARQ RTT timer for the DL transmission in Step 5.</p>				
8	<p>Check: Does the UE transmit a HARQ ACK for the DL MAC PDU in Step 7?</p>	-->	HARQ ACK	2,3,1	P
9	<p>In the last sub frame when the Drx-RetransmissionTimer for the DL MAC PDU indicated on the PDCCH in Step 5 is still running, the SS indicates the transmission of a DL MAC PDU.</p> <p>i.e., on the subframe with the subframe number = $[\text{csfn6} + \text{NormalSF}(\text{SFN6}, \text{csfn6}, \text{drx-RetransmissionTimer} - 1)] \text{ modulo } 10$, and the system frame number = $\text{SFN6} + \text{floor}([\text{csfn6} + \text{NormalSF}(\text{SFN6}, \text{csfn6}, \text{drx-RetransmissionTimer} - 1)]/10)$;</p>	<--	MAC PDU	-	-
10	<p>Check: Does the UE transmit a HARQ ACK for the DL MAC PDU in Step 9?</p>	-->	HARQ ACK	2,3	P
<p>Note 1: Invalid MAC PDU is a MAC PDU that fails the CRC check. Note 2: All DL MAC PDUs are transmitted with the NDI set on the PDCCH. Note 3: Timer tolerances for the MAC DRX related timers measured in subframes or PDCCH subframes is 0. These timers are: drx-InactivityTimer, drx-RetransmissionTimer, HARQ RTT Timer.</p>					

7.1.6.2.3.3 Specific message contents

Table 7.1.6.2.3.3-1: specific Parameters in RRCConnectionReconfiguration (step 0A of table 7.1.6.2.3.2-1)

Derivation Path: 36. 508 Table 4.6.1-8			
Information Element	Value/remark	Comment	Condition
measConfig	Not present		
mobilityControlInfo	Not present		
dedicatedInfoNASList	Not present		
radioResourceConfigDedicated ::= SEQUENCE {			
srb-ToAddModList	Not present		
drb-ToAddModList	Not present		
drb-ToReleaseList	Not present		
mac-MainConfig CHOICE {			
explicitValue ::= SEQUENCE {			
ul-SCH-Config SEQUENCE {			
maxHARQ-Tx	n5		
retxBSR-Timer	sf10240		
ttiBundling	FALSE		
}			
drx-Config CHOICE {			
setup SEQUENCE {			
onDurationTimer	psf20		
drx-InactivityTimer	psf6		
drx-RetransmissionTimer	psf6		
longDRX-CycleStartOffset CHOICE {			
sf640	4		
}			
shortDRX	Not present		
}			
timeAlignmentTimerDedicated	infinity		
phr-Config CHOICE {			
release	NULL		
}			
}			

7.1.7 Transport block size selection

7.1.7.0 Specific configurations

The configurations defined in table 7.1.7.0-1 is used after step 7 of table 4.5.3.3-1 [18] in the preamble and in all steps in the main behaviour of the test cases in clause 7.1.7.

Table 7.1.7.0-1: Power allocation for OFDM symbols and reference signals, single SS Tx antenna

Physical Channel	EPRE Ratio	Comment
PBCH	PBCH_RA = 0 dB	
	PBCH_RB = 0 dB	
PSS	PSS_RA = 0 dB	
SSS	SSS_RA = 0 dB	
PCFICH	PCFICH_RB = 0 dB	
PDCCH	PDCCH_RA = 0 dB	
	PDCCH_RB = 0 dB	
PDSCH	PDSCH_RA = 0 dB	
	PDSCH_RB = 0 dB	
PHICH	PHICH_RB = 0 dB	

The configurations defined in table 7.1.7.0-2 is used in step 8 of table 4.5.3.3-1 [18] in the preamble of the test cases in clause 7.1.7.

Table 7.1.7.0-2: PDSCH-ConfigDedicated-DEFAULT

Derivation Path: 36.508 Table 4.6.3-6			
Information Element	Value/remark	Comment	Condition
PDSCH-ConfigDedicated-DEFAULT ::= SEQUENCE			
{			
p-a	dB0		1TX
	dB-3		2TX
}			

7.1.7.1 DL-SCH transport block size selection

7.1.7.1.1 DL-SCH transport block size selection / DCI format 1 / RA type 0

7.1.7.1.1.1 Test Purpose (TP)

(1)

```

with { UE in E-UTRA RRC_CONNECTED state }
ensure that {
  when { UE on PDCCH receives DCI format 1 indicating Resource Allocation Type 0, a resource block
assignment correspondent to  $N_{PRB}$  physical resource blocks and a modulation and coding scheme  $I_{MCS}$ 
}
  then { UE decodes the received transport block of size correspondent to the read  $N_{PRB}$  and  $I_{MCS}$ 
and forwards it to higher layers }
}

```

7.1.7.1.1.2 Conformance requirements

References: The conformance requirements covered in the current TC are specified in: TS 36.212, clause 5.3.3.1.2; TS 36.213, clauses 7.1.6.1, 7.1.7, 7.1.7.1, 7.1.7.2 and 7.1.7.2.1; and TS 36.306 clause 4.1.

[TS 36.212 clause 5.3.3.1.2]

DCI format 1 is used for the scheduling of one PDSCH codeword.

The following information is transmitted by means of the DCI format 1:

- Resource allocation header (resource allocation type 0 / type 1) – 1 bit as defined in section 7.1.6 of [3]

If downlink bandwidth is less than or equal to 10 PRBs, there is no resource allocation header and resource allocation type 0 is assumed.

- Resource block assignment:

- For resource allocation type 0 as defined in section 7.1.6.1 of [3]:

- $\lceil N_{RB}^{DL} / P \rceil$ bits provide the resource allocation

...

where the value of P depends on the number of DL resource blocks as indicated in section 7.1.6 of [3]

- Modulation and coding scheme – 5 bits as defined in section 7.1.7 of [3]

If the number of information bits in format 1 is equal to that for format 0/1A, one bit of value zero shall be appended to format 1.

If the number of information bits in format 1 belongs to one of the sizes in Table 5.3.3.1.2-1, one or more zero bit(s) shall be appended to format 1 until the payload size of format 1 does not belong to one of the sizes in Table 5.3.3.1.2-1 and not equal to that of format 0/1A.

Table 5.3.3.1.2-1: Ambiguous Sizes of Information Bits

{12, 14, 16, 20, 24, 26, 32, 40, 44, 56}

[TS 36.213 clause 7.1.6.1]

In resource allocations of type 0, resource block assignment information includes a bitmap indicating the resource block groups (RBGs) that are allocated to the scheduled UE where a RBG is a set of consecutive physical resource blocks (PRBs). Resource block group size (P) is a function of the system bandwidth as shown in Table 7.1.6.1-1. The total number of RBGs (N_{RBG}) for downlink system bandwidth of $N_{\text{RB}}^{\text{DL}}$ PRBs is given by $N_{\text{RBG}} = \lceil N_{\text{RB}}^{\text{DL}} / P \rceil$ where $\lfloor N_{\text{RB}}^{\text{DL}} / P \rfloor$ of the RBGs are of size P and if $N_{\text{RB}}^{\text{DL}} \bmod P > 0$ then one of the RBGs is of size $N_{\text{RB}}^{\text{DL}} - P \cdot \lfloor N_{\text{RB}}^{\text{DL}} / P \rfloor$. The bitmap is of size N_{RBG} bits with one bitmap bit per RBG such that each RBG is addressable. The RBGs shall be indexed in the order of increasing frequency and non-increasing RBG sizes starting at the lowest frequency. The order of RBG to bitmap bit mapping is in such way that RBG 0 to RBG $N_{\text{RBG}} - 1$ are mapped to MSB to LSB of the bitmap. The RBG is allocated to the UE if the corresponding bit value in the bitmap is 1, the RBG is not allocated to the UE otherwise.

Table 7.1.6.1-1: Type 0 Resource Allocation RBG Size vs. Downlink System Bandwidth

System Bandwidth	RBG Size
$N_{\text{RB}}^{\text{DL}}$	(P)
≤ 10	1
11 – 26	2
27 – 63	3
64 – 110	4

[TS 36.213 clause 7.1.7]

To determine the modulation order and transport block size(s) in the physical downlink shared channel, the UE shall first

- read the 5-bit “modulation and coding scheme” field (I_{MCS}) in the DCI

and second if the DCI CRC is scrambled by P-RNTI, RA-RNTI, or SI-RNTI then

...

else

- set the Table 7.1.7.2.1-1 column indicator N'_{PRB} to the total number of allocated PRBs based on the procedure defined in Section 7.1.6.

if the transport block is transmitted in DwPTS of the special subframe in frame structure type 2, then

$$\text{set the Table 7.1.7.2.1-1 column indicator } N_{\text{PRB}} = \max \left\{ \left\lfloor N'_{\text{PRB}} \times 0.75 \right\rfloor, 1 \right\},$$

else, set the Table 7.1.7.2.1-1 column indicator $N_{\text{PRB}} = N'_{\text{PRB}}$.

The UE may skip decoding a transport block in an initial transmission if the effective channel code rate is higher than 0.930, where the effective channel code rate is defined as the number of downlink information bits (including CRC bits) divided by the number of physical channel bits on PDSCH. If the UE skips decoding, the physical layer indicates to higher layer that the transport block is not successfully decoded. For the special subframe configurations 0 and 5 with normal CP or configurations 0 and 4 with extended CP, shown in table 4.2-1 [3], there shall be no PDSCH transmission in DwPTS of the special subframe.

[TS 36.213 clause 7.1.7.1]

The UE shall use $Q_m = 2$ if the DCI CRC is scrambled by P-RNTI, RA-RNTI, or SI-RNTI, otherwise, the UE shall use I_{MCS} and Table 7.1.7.1-1 to determine the modulation order (Q_m) used in the physical downlink shared channel.

Table 7.1.7.1-1: Modulation and TBS index table for PDSCH

MCS Index I_{MCS}	Modulation Order Q_m	TBS Index I_{TBS}
0	2	0
1	2	1
2	2	2
3	2	3
4	2	4
5	2	5
6	2	6
7	2	7
8	2	8
9	2	9
10	4	9
11	4	10
12	4	11
13	4	12
14	4	13
15	4	14
16	4	15
17	6	15
18	6	16
19	6	17
20	6	18
21	6	19
22	6	20
23	6	21
24	6	22
25	6	23
26	6	24
27	6	25
28	6	26
29	2	reserved
30	4	
31	6	

[TS 36.213 clause 7.1.7.2]

If the DCI CRC is scrambled by P-RNTI, RA-RNTI, or SI-RNTI then

- for DCI format 1A:
 - the UE shall set the TBS index (I_{TBS}) equal to I_{MCS} and determine its TBS by the procedure in Section 7.1.7.2.1.

...

else

- for $0 \leq I_{MCS} \leq 28$, the UE shall first determine the TBS index (I_{TBS}) using I_{MCS} and Table 7.1.7.1-1 except if the transport block is disabled in DCI formats 2 and 2A as specified below. For a transport block that is not mapped to two-layer spatial multiplexing, the TBS is determined by the procedure in Section 7.1.7.2.1. For a transport block that is mapped to two-layer spatial multiplexing, the TBS is determined by the procedure in Section 7.1.7.2.2.
- for $29 \leq I_{MCS} \leq 31$, the TBS is assumed to be as determined from DCI transported in the latest PDCCH for the same transport block using $0 \leq I_{MCS} \leq 28$. If there is no latest PDCCH for the same transport block

using $0 \leq I_{\text{MCS}} \leq 28$, and if the initial PDSCH for the same transport block is semi-persistently scheduled, the TBS shall be determined from the most recent semi-persistent scheduling assignment PDCCH.

- In DCI formats 2 and 2A a transport block is disabled if $I_{\text{MCS}} = 0$ and if $rv_{\text{idx}} = 1$ otherwise the transport block is enabled.

The NDI and HARQ process ID, as signalled on PDCCH, and the TBS, as determined above, shall be delivered to higher layers.

[TS 36.213 clause 7.1.7.2.1]

For $1 \leq N_{\text{PRB}} \leq 110$, the TBS is given by the $(I_{\text{TBS}}, N_{\text{PRB}})$ entry of Table 7.1.7.2.1-1.

Table 7.1.7.2.1-1: Transport block size table (dimension 27x110)

I_{TBS}	N_{PRB}									
	1	2	3	4	5	6	7	8	9	10
0	16	32	56	88	120	152	176	208	224	256
1	24	56	88	144	176	208	224	256	328	344
2	32	72	144	176	208	256	296	328	376	424
3	40	104	176	208	256	328	392	440	504	568
4	56	120	208	256	328	408	488	552	632	696
5	72	144	224	328	424	504	600	680	776	872
6	328	176	256	392	504	600	712	808	936	1032
7	104	224	328	472	584	712	840	968	1096	1224
8	120	256	392	536	680	808	968	1096	1256	1384
9	136	296	456	616	776	936	1096	1256	1416	1544
10	144	328	504	680	872	1032	1224	1384	1544	1736
11	176	376	584	776	1000	1192	1384	1608	1800	2024
12	208	440	680	904	1128	1352	1608	1800	2024	2280
13	224	488	744	1000	1256	1544	1800	2024	2280	2536
14	256	552	840	1128	1416	1736	1992	2280	2600	2856
15	280	600	904	1224	1544	1800	2152	2472	2728	3112
16	328	632	968	1288	1608	1928	2280	2600	2984	3240
17	336	696	1064	1416	1800	2152	2536	2856	3240	3624
18	376	776	1160	1544	1992	2344	2792	3112	3624	4008
19	408	840	1288	1736	2152	2600	2984	3496	3880	4264
20	440	904	1384	1864	2344	2792	3240	3752	4136	4584
21	488	1000	1480	1992	2472	2984	3496	4008	4584	4968
22	520	1064	1608	2152	2664	3240	3752	4264	4776	5352
23	552	1128	1736	2280	2856	3496	4008	4584	5160	5736
24	584	1192	1800	2408	2984	3624	4264	4968	5544	5992
25	616	1256	1864	2536	3112	3752	4392	5160	5736	6200
26	712	1480	2216	2984	3752	4392	5160	5992	6712	7480
I_{TBS}	N_{PRB}									
	11	12	13	14	15	16	17	18	19	20
0	288	328	344	376	392	424	456	488	504	536
1	376	424	456	488	520	568	600	632	680	712
2	472	520	568	616	648	696	744	776	840	872
3	616	680	744	808	872	904	968	1032	1096	1160
4	776	840	904	1000	1064	1128	1192	1288	1352	1416
5	968	1032	1128	1224	1320	1384	1480	1544	1672	1736
6	1128	1224	1352	1480	1544	1672	1736	1864	1992	2088
7	1320	1480	1608	1672	1800	1928	2088	2216	2344	2472
8	1544	1672	1800	1928	2088	2216	2344	2536	2664	2792
9	1736	1864	2024	2216	2344	2536	2664	2856	2984	3112
10	1928	2088	2280	2472	2664	2792	2984	3112	3368	3496
11	2216	2408	2600	2792	2984	3240	3496	3624	3880	4008
12	2472	2728	2984	3240	3368	3624	3880	4136	4392	4584
13	2856	3112	3368	3624	3880	4136	4392	4584	4968	5160
14	3112	3496	3752	4008	4264	4584	4968	5160	5544	5736
15	3368	3624	4008	4264	4584	4968	5160	5544	5736	6200
16	3624	3880	4264	4584	4968	5160	5544	5992	6200	6456
17	4008	4392	4776	5160	5352	5736	6200	6456	6712	7224
18	4392	4776	5160	5544	5992	6200	6712	7224	7480	7992
19	4776	5160	5544	5992	6456	6968	7224	7736	8248	8504
20	5160	5544	5992	6456	6968	7480	7992	8248	8760	9144
21	5544	5992	6456	6968	7480	7992	8504	9144	9528	9912
22	5992	6456	6968	7480	7992	8504	9144	9528	10296	10680
23	6200	6968	7480	7992	8504	9144	9912	10296	11064	11448
24	6712	7224	7992	8504	9144	9912	10296	11064	11448	12216
25	6968	7480	8248	8760	9528	10296	10680	11448	12216	12576
26	8248	8760	9528	10296	11064	11832	12576	13536	14112	14688
I_{TBS}	N_{PRB}									
	21	22	23	24	25	26	27	28	29	30
0	568	600	616	648	680	712	744	776	776	808
1	744	776	808	872	904	936	968	1000	1032	1064

2	936	968	1000	1064	1096	1160	1192	1256	1288	1320
3	1224	1256	1320	1384	1416	1480	1544	1608	1672	1736
4	1480	1544	1608	1736	1800	1864	1928	1992	2088	2152
5	1864	1928	2024	2088	2216	2280	2344	2472	2536	2664
6	2216	2280	2408	2472	2600	2728	2792	2984	2984	3112
7	2536	2664	2792	2984	3112	3240	3368	3368	3496	3624
8	2984	3112	3240	3368	3496	3624	3752	3880	4008	4264
9	3368	3496	3624	3752	4008	4136	4264	4392	4584	4776
10	3752	3880	4008	4264	4392	4584	4776	4968	5160	5352
11	4264	4392	4584	4776	4968	5352	5544	5736	5992	5992
12	4776	4968	5352	5544	5736	5992	6200	6456	6712	6712
13	5352	5736	5992	6200	6456	6712	6968	7224	7480	7736
14	5992	6200	6456	6968	7224	7480	7736	7992	8248	8504
15	6456	6712	6968	7224	7736	7992	8248	8504	8760	9144
16	6712	7224	7480	7736	7992	8504	8760	9144	9528	9912
17	7480	7992	8248	8760	9144	9528	9912	10296	10296	10680
18	8248	8760	9144	9528	9912	10296	10680	11064	11448	11832
19	9144	9528	9912	10296	10680	11064	11448	12216	12576	12960
20	9912	10296	10680	11064	11448	12216	12576	12960	13536	14112
21	10680	11064	11448	12216	12576	12960	13536	14112	14688	15264
22	11448	11832	12576	12960	13536	14112	14688	15264	15840	16416
23	12216	12576	12960	13536	14112	14688	15264	15840	16416	16992
24	12960	13536	14112	14688	15264	15840	16416	16992	17568	18336
25	13536	14112	14688	15264	15840	16416	16992	17568	18336	19080
26	15264	16416	16992	17568	18336	19080	19848	20616	21384	22152
I_{TBS}	N_{PRB}									
	31	32	33	34	35	36	37	38	39	40
0	840	872	904	936	968	1000	1032	1032	1064	1096
1	1128	1160	1192	1224	1256	1288	1352	1384	1416	1416
2	1384	1416	1480	1544	1544	1608	1672	1672	1736	1800
3	1800	1864	1928	1992	2024	2088	2152	2216	2280	2344
4	2216	2280	2344	2408	2472	2600	2664	2728	2792	2856
5	2728	2792	2856	2984	3112	3112	3240	3368	3496	3496
6	3240	3368	3496	3496	3624	3752	3880	4008	4136	4136
7	3752	3880	4008	4136	4264	4392	4584	4584	4776	4968
8	4392	4584	4584	4776	4968	4968	5160	5352	5544	5544
9	4968	5160	5160	5352	5544	5736	5736	5992	6200	6200
10	5544	5736	5736	5992	6200	6200	6456	6712	6712	6968
11	6200	6456	6712	6968	6968	7224	7480	7736	7736	7992
12	6968	7224	7480	7736	7992	8248	8504	8760	8760	9144
13	7992	8248	8504	8760	9144	9144	9528	9912	9912	10296
14	8760	9144	9528	9912	9912	10296	10680	11064	11064	11448
15	9528	9912	10296	10296	10680	11064	11448	11832	11832	12216
16	9912	10296	10680	11064	11448	11832	12216	12216	12576	12960
17	11064	11448	11832	12216	12576	12960	13536	13536	14112	14688
18	12216	12576	12960	13536	14112	14112	14688	15264	15264	15840
19	13536	13536	14112	14688	15264	15264	15840	16416	16992	16992
20	14688	14688	15264	15840	16416	16992	16992	17568	18336	18336
21	15840	15840	16416	16992	17568	18336	18336	19080	19848	19848
22	16992	16992	17568	18336	19080	19080	19848	20616	21384	21384
23	17568	18336	19080	19848	19848	20616	21384	22152	22152	22920
24	19080	19848	19848	20616	21384	22152	22920	22920	23688	24496
25	19848	20616	20616	21384	22152	22920	23688	24496	24496	25456
26	22920	23688	24496	25456	25456	26416	27376	28336	29296	29296
I_{TBS}	N_{PRB}									
	41	42	43	44	45	46	47	48	49	50
0	1128	1160	1192	1224	1256	1256	1288	1320	1352	1384
1	1480	1544	1544	1608	1608	1672	1736	1736	1800	1800
2	1800	1864	1928	1992	2024	2088	2088	2152	2216	2216
3	2408	2472	2536	2536	2600	2664	2728	2792	2856	2856
4	2984	2984	3112	3112	3240	3240	3368	3496	3496	3624
5	3624	3752	3752	3880	4008	4008	4136	4264	4392	4392
6	4264	4392	4584	4584	4776	4776	4968	4968	5160	5160
7	4968	5160	5352	5352	5544	5736	5736	5992	5992	6200

8	5736	5992	5992	6200	6200	6456	6456	6712	6968	6968
9	6456	6712	6712	6968	6968	7224	7480	7480	7736	7992
10	7224	7480	7480	7736	7992	7992	8248	8504	8504	8760
11	8248	8504	8760	8760	9144	9144	9528	9528	9912	9912
12	9528	9528	9912	9912	10296	10680	10680	11064	11064	11448
13	10680	10680	11064	11448	11448	11832	12216	12216	12576	12960
14	11832	12216	12216	12576	12960	12960	13536	13536	14112	14112
15	12576	12960	12960	13536	13536	14112	14688	14688	15264	15264
16	13536	13536	14112	14112	14688	14688	15264	15840	15840	16416
17	14688	15264	15264	15840	16416	16416	16992	17568	17568	18336
18	16416	16416	16992	17568	17568	18336	18336	19080	19080	19848
19	17568	18336	18336	19080	19080	19848	20616	20616	21384	21384
20	19080	19848	19848	20616	20616	21384	22152	22152	22920	22920
21	20616	21384	21384	22152	22920	22920	23688	24496	24496	25456
22	22152	22920	22920	23688	24496	24496	25456	25456	26416	27376
23	23688	24496	24496	25456	25456	26416	27376	27376	28336	28336
24	25456	25456	26416	26416	27376	28336	28336	29296	29296	30576
25	26416	26416	27376	28336	28336	29296	29296	30576	31704	31704
26	30576	30576	31704	32856	32856	34008	35160	35160	36696	36696
I_{TBS}	N_{PRB}									
	51	52	53	54	55	56	57	58	59	60
0	1416	1416	1480	1480	1544	1544	1608	1608	1608	1672
1	1864	1864	1928	1992	1992	2024	2088	2088	2152	2152
2	2280	2344	2344	2408	2472	2536	2536	2600	2664	2664
3	2984	2984	3112	3112	3240	3240	3368	3368	3496	3496
4	3624	3752	3752	3880	4008	4008	4136	4136	4264	4264
5	4584	4584	4776	4776	4776	4968	4968	5160	5160	5352
6	5352	5352	5544	5736	5736	5992	5992	5992	6200	6200
7	6200	6456	6456	6712	6712	6712	6968	6968	7224	7224
8	7224	7224	7480	7480	7736	7736	7992	7992	8248	8504
9	7992	8248	8248	8504	8760	8760	9144	9144	9144	9528
10	9144	9144	9144	9528	9528	9912	9912	10296	10296	10680
11	10296	10680	10680	11064	11064	11448	11448	11832	11832	12216
12	11832	11832	12216	12216	12576	12576	12960	12960	13536	13536
13	12960	13536	13536	14112	14112	14688	14688	14688	15264	15264
14	14688	14688	15264	15264	15840	15840	16416	16416	16992	16992
15	15840	15840	16416	16416	16992	16992	17568	17568	18336	18336
16	16416	16992	16992	17568	17568	18336	18336	19080	19080	19848
17	18336	19080	19080	19848	19848	20616	20616	20616	21384	21384
18	19848	20616	21384	21384	22152	22152	22920	22920	23688	23688
19	22152	22152	22920	22920	23688	24496	24496	25456	25456	25456
20	23688	24496	24496	25456	25456	26416	26416	27376	27376	28336
21	25456	26416	26416	27376	27376	28336	28336	29296	29296	30576
22	27376	28336	28336	29296	29296	30576	30576	31704	31704	32856
23	29296	29296	30576	30576	31704	31704	32856	32856	34008	34008
24	31704	31704	32856	32856	34008	34008	35160	35160	36696	36696
25	32856	32856	34008	34008	35160	35160	36696	36696	37888	37888
26	37888	37888	39232	40576	40576	40576	42368	42368	43816	43816
I_{TBS}	N_{PRB}									
	61	62	63	64	65	66	67	68	69	70
0	1672	1736	1736	1800	1800	1800	1864	1864	1928	1928
1	2216	2280	2280	2344	2344	2408	2472	2472	2536	2536
2	2728	2792	2856	2856	2856	2984	2984	3112	3112	3112
3	3624	3624	3624	3752	3752	3880	3880	4008	4008	4136
4	4392	4392	4584	4584	4584	4776	4776	4968	4968	4968
5	5352	5544	5544	5736	5736	5736	5992	5992	5992	6200
6	6456	6456	6456	6712	6712	6968	6968	6968	7224	7224
7	7480	7480	7736	7736	7992	7992	8248	8248	8504	8504
8	8504	8760	8760	9144	9144	9144	9528	9528	9528	9912
9	9528	9912	9912	10296	10296	10296	10680	10680	11064	11064
10	10680	11064	11064	11448	11448	11448	11832	11832	12216	12216
11	12216	12576	12576	12960	12960	13536	13536	13536	14112	14112
12	14112	14112	14112	14688	14688	15264	15264	15264	15840	15840
13	15840	15840	16416	16416	16992	16992	16992	17568	17568	18336

14	17568	17568	18336	18336	18336	19080	19080	19848	19848	19848
15	18336	19080	19080	19848	19848	20616	20616	20616	21384	21384
16	19848	19848	20616	20616	21384	21384	22152	22152	22152	22920
17	22152	22152	22920	22920	23688	23688	24496	24496	24496	25456
18	24496	24496	24496	25456	25456	26416	26416	27376	27376	27376
19	26416	26416	27376	27376	28336	28336	29296	29296	29296	30576
20	28336	29296	29296	29296	30576	30576	31704	31704	31704	32856
21	30576	31704	31704	31704	32856	32856	34008	34008	35160	35160
22	32856	34008	34008	34008	35160	35160	36696	36696	36696	37888
23	35160	35160	36696	36696	37888	37888	37888	39232	39232	40576
24	36696	37888	37888	39232	39232	40576	40576	42368	42368	42368
25	39232	39232	40576	40576	40576	42368	42368	43816	43816	43816
26	45352	45352	46888	46888	48936	48936	48936	51024	51024	52752
I_{TBS}	N_{PRB}									
	71	72	73	74	75	76	77	78	79	80
0	1992	1992	2024	2088	2088	2088	2152	2152	2216	2216
1	2600	2600	2664	2728	2728	2792	2792	2856	2856	2856
2	3240	3240	3240	3368	3368	3368	3496	3496	3496	3624
3	4136	4264	4264	4392	4392	4392	4584	4584	4584	4776
4	5160	5160	5160	5352	5352	5544	5544	5544	5736	5736
5	6200	6200	6456	6456	6712	6712	6712	6968	6968	6968
6	7480	7480	7736	7736	7736	7992	7992	8248	8248	8248
7	8760	8760	8760	9144	9144	9144	9528	9528	9528	9912
8	9912	9912	10296	10296	10680	10680	10680	11064	11064	11064
9	11064	11448	11448	11832	11832	11832	12216	12216	12576	12576
10	12576	12576	12960	12960	12960	13536	13536	13536	14112	14112
11	14112	14688	14688	14688	15264	15264	15840	15840	15840	16416
12	16416	16416	16416	16992	16992	17568	17568	17568	18336	18336
13	18336	18336	19080	19080	19080	19848	19848	19848	20616	20616
14	20616	20616	20616	21384	21384	22152	22152	22152	22920	22920
15	22152	22152	22152	22920	22920	23688	23688	23688	24496	24496
16	22920	23688	23688	24496	24496	24496	25456	25456	25456	26416
17	25456	26416	26416	26416	27376	27376	27376	28336	28336	29296
18	28336	28336	29296	29296	29296	30576	30576	30576	31704	31704
19	30576	30576	31704	31704	32856	32856	32856	34008	34008	34008
20	32856	34008	34008	34008	35160	35160	35160	36696	36696	36696
21	35160	36696	36696	36696	37888	37888	39232	39232	39232	40576
22	37888	39232	39232	40576	40576	40576	42368	42368	42368	43816
23	40576	40576	42368	42368	43816	43816	43816	45352	45352	45352
24	43816	43816	45352	45352	45352	46888	46888	46888	48936	48936
25	45352	45352	46888	46888	46888	48936	48936	48936	51024	51024
26	52752	52752	55056	55056	55056	55056	57336	57336	57336	59256
I_{TBS}	N_{PRB}									
	81	82	83	84	85	86	87	88	89	90
0	2280	2280	2280	2344	2344	2408	2408	2472	2472	2536
1	2984	2984	2984	3112	3112	3112	3240	3240	3240	3240
2	3624	3624	3752	3752	3880	3880	3880	4008	4008	4008
3	4776	4776	4776	4968	4968	4968	5160	5160	5160	5352
4	5736	5992	5992	5992	5992	6200	6200	6200	6456	6456
5	7224	7224	7224	7480	7480	7480	7736	7736	7736	7992
6	8504	8504	8760	8760	8760	9144	9144	9144	9144	9528
7	9912	9912	10296	10296	10296	10680	10680	10680	11064	11064
8	11448	11448	11448	11832	11832	12216	12216	12216	12576	12576
9	12960	12960	12960	13536	13536	13536	13536	14112	14112	14112
10	14112	14688	14688	14688	14688	15264	15264	15264	15840	15840
11	16416	16416	16992	16992	16992	17568	17568	17568	18336	18336
12	18336	19080	19080	19080	19080	19848	19848	19848	20616	20616
13	20616	21384	21384	21384	21384	22152	22152	22152	22920	22920
14	22920	23688	23688	24496	24496	24496	25456	25456	25456	25456
15	24496	25456	25456	25456	26416	26416	26416	27376	27376	27376
16	26416	26416	27376	27376	27376	28336	28336	28336	29296	29296
17	29296	29296	30576	30576	30576	30576	31704	31704	31704	32856
18	31704	32856	32856	32856	34008	34008	34008	35160	35160	35160
19	35160	35160	35160	36696	36696	36696	37888	37888	37888	39232

20	37888	37888	39232	39232	39232	40576	40576	40576	42368	42368
21	40576	40576	42368	42368	42368	43816	43816	43816	45352	45352
22	43816	43816	45352	45352	45352	46888	46888	46888	48936	48936
23	46888	46888	46888	48936	48936	48936	51024	51024	51024	51024
24	48936	51024	51024	51024	52752	52752	52752	52752	55056	55056
25	51024	52752	52752	52752	55056	55056	55056	55056	57336	57336
26	59256	59256	61664	61664	61664	63776	63776	63776	66592	66592
I_{TBS}	N_{PRB}									
	91	92	93	94	95	96	97	98	99	100
0	2536	2536	2600	2600	2664	2664	2728	2728	2728	2792
1	3368	3368	3368	3496	3496	3496	3496	3624	3624	3624
2	4136	4136	4136	4264	4264	4264	4392	4392	4392	4584
3	5352	5352	5352	5544	5544	5544	5736	5736	5736	5736
4	6456	6456	6712	6712	6712	6968	6968	6968	6968	7224
5	7992	7992	8248	8248	8248	8504	8504	8760	8760	8760
6	9528	9528	9528	9912	9912	9912	10296	10296	10296	10296
7	11064	11448	11448	11448	11448	11832	11832	11832	12216	12216
8	12576	12960	12960	12960	13536	13536	13536	13536	14112	14112
9	14112	14688	14688	14688	15264	15264	15264	15264	15840	15840
10	15840	16416	16416	16416	16992	16992	16992	16992	17568	17568
11	18336	18336	19080	19080	19080	19080	19848	19848	19848	19848
12	20616	21384	21384	21384	21384	22152	22152	22152	22920	22920
13	23688	23688	23688	24496	24496	24496	25456	25456	25456	25456
14	26416	26416	26416	27376	27376	27376	28336	28336	28336	28336
15	28336	28336	28336	29296	29296	29296	29296	30576	30576	30576
16	29296	30576	30576	30576	30576	31704	31704	31704	31704	32856
17	32856	32856	34008	34008	34008	35160	35160	35160	35160	36696
18	36696	36696	36696	37888	37888	37888	37888	39232	39232	39232
19	39232	39232	40576	40576	40576	40576	42368	42368	42368	43816
20	42368	42368	43816	43816	43816	45352	45352	45352	46888	46888
21	45352	46888	46888	46888	46888	48936	48936	48936	48936	51024
22	48936	48936	51024	51024	51024	51024	52752	52752	52752	55056
23	52752	52752	52752	55056	55056	55056	55056	57336	57336	57336
24	55056	57336	57336	57336	57336	59256	59256	59256	61664	61664
25	57336	59256	59256	59256	61664	61664	61664	61664	63776	63776
26	66592	68808	68808	68808	71112	71112	71112	73712	73712	75376
I_{TBS}	N_{PRB}									
	101	102	103	104	105	106	107	108	109	110
0	2792	2856	2856	2856	2984	2984	2984	2984	2984	3112
1	3752	3752	3752	3752	3880	3880	3880	4008	4008	4008
2	4584	4584	4584	4584	4776	4776	4776	4776	4968	4968
3	5992	5992	5992	5992	6200	6200	6200	6200	6456	6456
4	7224	7224	7480	7480	7480	7480	7736	7736	7736	7992
5	8760	9144	9144	9144	9144	9528	9528	9528	9528	9528
6	10680	10680	10680	10680	11064	11064	11064	11448	11448	11448
7	12216	12576	12576	12576	12960	12960	12960	12960	13536	13536
8	14112	14112	14688	14688	14688	14688	15264	15264	15264	15264
9	15840	16416	16416	16416	16416	16992	16992	16992	16992	17568
10	17568	18336	18336	18336	18336	18336	19080	19080	19080	19080
11	20616	20616	20616	21384	21384	21384	21384	22152	22152	22152
12	22920	23688	23688	23688	23688	24496	24496	24496	24496	25456
13	26416	26416	26416	26416	27376	27376	27376	27376	28336	28336
14	29296	29296	29296	29296	30576	30576	30576	30576	31704	31704
15	30576	31704	31704	31704	31704	32856	32856	32856	34008	34008
16	32856	32856	34008	34008	34008	34008	35160	35160	35160	35160
17	36696	36696	36696	37888	37888	37888	39232	39232	39232	39232
18	40576	40576	40576	40576	42368	42368	42368	42368	43816	43816
19	43816	43816	43816	45352	45352	45352	46888	46888	46888	46888
20	46888	46888	48936	48936	48936	48936	48936	51024	51024	51024
21	51024	51024	51024	52752	52752	52752	52752	55056	55056	55056
22	55056	55056	55056	57336	57336	57336	57336	59256	59256	59256
23	57336	59256	59256	59256	59256	61664	61664	61664	61664	63776
24	61664	61664	63776	63776	63776	63776	66592	66592	66592	66592
25	63776	63776	66592	66592	66592	66592	68808	68808	68808	71112

26	75376	75376	75376	75376	75376	75376	75376	75376	75376	75376
----	-------	-------	-------	-------	-------	-------	-------	-------	-------	-------

[TS 36.306 clause 4.1]

The field *ue-Category* defines a combined uplink and downlink capability. The parameters set by the UE Category are defined in subclause 4.2. Tables 4.1-1 and 4.1-2 define the downlink and, respectively, uplink physical layer parameter values for each UE Category.

Table 4.1-1: Downlink physical layer parameter values set by the field *ue-Category*

UE Category	Maximum number of DL-SCH transport block bits received within a TTI	Maximum number of bits of a DL-SCH transport block received within a TTI	Total number of soft channel bits	Maximum number of supported layers for spatial multiplexing in DL
Category 1	10296	10296	250368	1
Category 2	51024	51024	1237248	2
Category 3	102048	75376	1237248	2
Category 4	150752	75376	1827072	2
Category 5	299552	149776	3667200	4

Table 4.1-2: Uplink physical layer parameter values set by the field *ue-Category*

UE Category	Maximum number of bits of an UL-SCH transport block transmitted within a TTI	Support for 64QAM in UL
Category 1	5160	No
Category 2	25456	No
Category 3	51024	No
Category 4	51024	No
Category 5	75376	Yes

7.1.7.1.1.3 Test description

7.1.7.1.1.3.1 Pre-test conditions

System Simulator:

- Cell 1.
- Uplink and downlink bandwidth set to the maximum bandwidth for the E-UTRA Band under test as specified in Table 5.6.1-1 in [31] (to enable testing of N_{PRB} up to maximum value). For Band 18, Band 19 and Band 25, based on industry requirement, uplink and downlink bandwidth set to 10MHz.

UE:

None.

Preamble:

- The UE is in state Loopback Activated (state 4) according to [18].

7.1.7.1.1.3.2 Test procedure sequence

Table 7.1.7.1.1.3.2-1: Maximum TB_{size} for different UE categories

UE Category	Maximum number of bits of a DL-SCH transport block received within a TTI
Category 1	10296
Category 2	51024
Category 3	75376
Category 4	75376
Category 5	149776

Table 7.1.7.1.1.3.2-2: Number of downlink PDCP SDUs and PDCP SDU size used as test data

TB _{size} [bits]	Number of PDCP SDUs	PDCP SDU size [bits] See note 1
$104 \leq TB_{size} \leq 12096$ note 2	1	$8 * \text{FLOOR}((TB_{size} - 96)/8)$
$12097 \leq TB_{size} \leq 24128$	2	$8 * \text{FLOOR}((TB_{size} - 128)/16)$
$24129 \leq TB_{size} \leq 36152$	3	$8 * \text{FLOOR}((TB_{size} - 152)/24)$
$36153 \leq TB_{size} \leq 48184$	4	$8 * \text{FLOOR}((TB_{size} - 184)/32)$
$48185 \leq TB_{size} \leq 60208$	5	$8 * \text{FLOOR}((TB_{size} - 208)/40)$
$60209 \leq TB_{size} \leq 72240$	6	$8 * \text{FLOOR}((TB_{size} - 240)/48)$
$TB_{size} > 72240$	7	$8 * \text{FLOOR}((TB_{size} - 264)/56)$

Note 1. Each PDCP SDU is limited to 1500 octets (to keep below maximum SDU size of ESM as specified in TS 24.301 clause 9.9.4.12).

The PDCP SDU size of each PDCP SDU is

PDCP SDU size = (TB_{size} – N*PDCP header size - AMD PDU header size - MAC header size – Size of Timing Advance – RLC Status PDU size) / N, where

PDCP header size is 16 bits for the RLC AM and 12-bit SN case;
 AMD PDU header size is $\text{CIEL}[(16+(N-1)*12)/8]$ bytes which includes 16 standard AM header and (N-1) Length indicators; and

MAC header size = 40 bits as MAC header size can be

- 1) R/R/E/LCID MAC subheader (8 bits for Timing Advance) + R/R/E/LCID MAC subheader (16 bits for MAC SDU for RLC Status PDU) + R/R/E/LCID MAC subheader (8 bits for MAC SDU) = for AMD PDU 8 + 8 + 16 + bits = 32 bits
- Or
- 2) R/R/E/LCID MAC subheader (8 bits for Timing Advance) + R/R/E/LCID MAC subheader (24 bits for MAC SDU for AMD PDU, Note: Length can be of 2 bytes depending upon the size of AMD PDU) + R/R/E/LCID MAC subheader (8 bits for MAC SDU for RLC Status PDU) + = 8+24 + 8 bits = 40 bits

Therefore Maximum MAC header size can be 40 bits

Size of Timing Advance MAC CE is 8 bits (if no Timing Advance and/or RLC status needs to be sent, padding will occur instead)

RLC Status PDU size = 16 bits

This gives:

PDCP SDU size = $8 * \text{FLOOR}((TB_{size} - N * 16 - 8 * \text{CIEL}((16+(N-1)*12)/8) - 64)/(8 * N))$ bits

Note 2: According to TS 36.213 Table 7.1.7.2.1-1 and the final PDCP SDU size formula in Note 1, the smallest TB_{size} that can be tested is 104 bits.

Table 7.1.7.1.1.3.2-2a: Bandwidth Dependent Parameters

Max Bandwidth	Max N_{PRB}	Allowed N_{PRB} Values
10 Mhz	50	2, 3, 5, 6, 8, 9, 11, 12, 14, 15, 17, 18, 20, 21, 23, 24, 26, 27, 29, 30, 32, 33, 35, 36, 38, 39, 41, 42, 44, 45, 47, 48, 50
15 Mhz	75	3, 4, 7, 8, 11, 12, 15, 16, 19, 20, 23, 24, 27, 28, 31, 32, 35, 36, 39, 40, 43, 44, 47, 48, 51, 52, 55, 56, 59, 60, 63, 64, 67, 68, 71, 72, 75
20 Mhz	100	4, 8, 12, 16, 20, 24, 28, 32, 36, 40, 44, 48, 52, 56, 60, 64, 68, 72, 76, 80, 84, 88, 92, 96, 100
Note : Maximum bandwidth for EUTRA bands is 10/15/20 Mhz.		

Table 7.1.7.1.1.3.2-2b: Ambiguous Sizes of Information Bits

{12, 14, 16, 20, 24, 26, 32, 40, 44, 56}
--

Table 7.1.7.1.1.3.2-3: Main behaviour

St	Procedure	Message Sequence		TP	Verdict
		U – S	Message		
-	EXCEPTION: Steps 1 to 4 are repeated for allowed values of N_{PRB} as per table 7.1.7.1.1.3.2-2a and I_{MCS} from 0 to 28.	-	-	-	-
1	SS looks up I_{TBS} in table 7.1.7.1-1 in TS 36.213 based on the value of I_{MCS} . SS looks up TB_{size} in table 7.1.7.2.1-1 in TS 36.213 based on values of N_{PRB} and I_{TBS} .	-	-	-	-
-	EXCEPTION: Steps 2 to 4 are performed if TB_{size} is less than or equal to UE capability “Maximum number of DL-SCH transport block bits received within a TTI” as specified in Table 7.1.7.1.1.3.2-1 and larger than or equal to 104 bits as specified in Table 7.1.7.1.1.3.2-2, and the effective channel code rate, as defined in TS 36.213 clause 7.1.7, is lower than or equal to 0.930.	-	-	-	-
2	SS creates one or more PDCP SDUs, depending on TB_{size} , in accordance with Table 7.1.7.1.1.3.2-2.	-	-	-	-
3	SS transmits the PDCP SDUs concatenated into a MAC PDU and indicates on PDCCH DCI Format 1 with RA type 0 and a resource block assignment (RBA) correspondent to N_{PRB} as specified in 7.1.6.1 in TS 36.213 and modulation and coding scheme I_{MCS} . If the number of information bits in format 1 is equal to that for format 0/1A, one bit of value zero shall	<--	MAC PDU (NxPDCP SDUs) DCI: (DCI Format 1, RA type 0, RBA(N_{PRB}), I_{MCS})	-	-

	be appended to format 1 by the SS. If the number of information bits in format 1 belongs to one of the sizes in Table 7.1.7.1.1.3.2-2b, one or more zero bit(s) shall be appended to format 1 by the SS until the payload size of format 1 does not belong to one of the sizes in Table 7.1.7.1.1.3.2-2b and not equal to that of format 0/1A.				
3A	At the reception of scheduling request the SS transmits UL Grant for transmitting loop back PDCP SDUs.	<--	(UL Grant)	-	-
4	CHECK: Does UE return the same number of PDCP SDUs with same content as transmitted by the SS in step 3?	-->	(NxPDCP SDUs)	1	P

7.1.7.1.1.3.3 Specific Message Contents

Table 7.1.7.1.1.3.3.1: MAC-MainConfig-RBC (preamble Table 4.5.3.3-1 [18]: Step 8)

Derivation Path: 36.508 Table 4.8.2.1.5-1			
Information Element	Value/remark	Comment	Condition
retxBSR-Timer	sf320		

Table 7.1.7.1.1.3.3-2: UECapabilityInformation (Preamble Table 4.5.2.3-1 [18]: Step 13)

Derivation Path: 36.508 table 4.6.1-23			
Information Element	Value/remark	Comment	Condition
UECapabilityInformation ::= SEQUENCE {			
criticalExtensions CHOICE {			
c1 CHOICE{			
ueCapabilityInformation-r8 SEQUENCE {			
ue-CapabilityRAT-ContainerList SEQUENCE (SIZE (1..maxRAT-Capabilities)) OF SEQUENCE {	1 entry		
ueCapabilityRAT-Container			
ue-EUTRA-Capability SEQUENCE {			
ue-Category	Checked against UE Category indications in the PICS		
}			
}			
}			
}			
}			
}			

7.1.7.1.2 DL-SCH transport block size selection / DCI format 1 / RA type 1

7.1.7.1.2.1 Test Purpose (TP)

(1)

```
with { UE in E-UTRA RRC_CONNECTED state }
ensure that {
  when { UE on PDCCH receives DCI format 1 indicating Resource Allocation Type 1, a resource block assignment correspondent to  $N_{PRB}$  physical resource blocks and a modulation and coding scheme  $I_{MCS}$ 
}
```

```

    then { UE decodes the received transport block of size correspondent to the read  $N_{\text{PRB}}$  and  $I_{\text{MCS}}$ 
and forwards it to higher layers }
}

```

7.1.7.1.2.2 Conformance requirements

References: The conformance requirements covered in the current TC are specified in: TS 36.212, clause 5.3.3.1.2; TS 36.213, clauses 7.1.6.2, 7.1.7, 7.1.7.1, 7.1.7.2 and 7.1.7.2.1; and TS 36.306 clause 4.1.

[TS 36.212 clause 5.3.3.1.2]

DCI format 1 is used for the scheduling of one PDSCH codeword.

The following information is transmitted by means of the DCI format 1:

- Resource allocation header (resource allocation type 0 / type 1) – 1 bit as defined in section 7.1.6 of [3]

If downlink bandwidth is less than or equal to 10 PRBs, there is no resource allocation header and resource allocation type 0 is assumed.

- Resource block assignment:

...

- For resource allocation type 1 as defined in section 7.1.6.2 of [3]:

- $\lceil \log_2(P) \rceil$ bits of this field are used as a header specific to this resource allocation type to indicate the selected resource blocks subset

- 1 bit indicates a shift of the resource allocation span

- $\left(\left\lceil N_{\text{RB}}^{\text{DL}} / P \right\rceil - \lceil \log_2(P) \rceil - 1 \right)$ bits provide the resource allocation

where the value of P depends on the number of DL resource blocks as indicated in section 7.1.6 of [3]

- Modulation and coding scheme – 5 bits as defined in section 7.1.7 of [3]

If the number of information bits in format 1 is equal to that for format 0/1A, one bit of value zero shall be appended to format 1.

If the number of information bits in format 1 belongs to one of the sizes in Table 5.3.3.1.2-1, one or more zero bit(s) shall be appended to format 1 until the payload size of format 1 does not belong to one of the sizes in Table 5.3.3.1.2-1 and not equal to that of format 0/1A.

Table 5.3.3.1.2-1: Ambiguous Sizes of Information Bits

{12, 14, 16, 20, 24, 26, 32, 40, 44, 56}
--

[TS 36.213 clause 7.1.6.2]

In resource allocations of type 1, a resource block assignment information of size N_{RBG} indicates to a scheduled UE the PRBs from the set of PRBs from one of P RBG subsets. Also P is the RBG size associated with the system bandwidth as shown in Table 7.1.6.1-1. A RBG subset p , where $0 \leq p < P$, consists of every P th RBG starting from RBG p . The resource block assignment information consists of three fields [4].

The first field with $\lceil \log_2(P) \rceil$ bits is used to indicate the selected RBG subset among P RBG subsets.

The second field with one bit is used to indicate a shift of the resource allocation span within a subset. A bit value of 1 indicates shift is triggered. Shift is not triggered otherwise.

The third field includes a bitmap, where each bit of the bitmap addresses a single PRB in the selected RBG subset in such a way that MSB to LSB of the bitmap are mapped to the PRBs in the increasing frequency order. The PRB is allocated to the UE if the corresponding bit value in the bit field is 1, the PRB is not allocated to the UE otherwise. The portion of the bitmap used to address PRBs in a selected RBG subset has size $N_{\text{RB}}^{\text{TYPE1}}$ and is defined as

$$N_{RB}^{TYPE1} = \left\lceil N_{RB}^{DL} / P \right\rceil - \lceil \log_2(P) \rceil - 1$$

The addressable PRB numbers of a selected RBG subset start from an offset, $\Delta_{\text{shift}}(p)$ to the smallest PRB number within the selected RBG subset, which is mapped to the MSB of the bitmap. The offset is in terms of the number of PRBs and is done within the selected RBG subset. If the value of the bit in the second field for shift of the resource allocation span is set to 0, the offset for RBG subset p is given by $\Delta_{\text{shift}}(p) = 0$. Otherwise, the offset for RBG subset p is given by $\Delta_{\text{shift}}(p) = N_{RB}^{RBG \text{ subset}}(p) - N_{RB}^{TYPE1}$, where the LSB of the bitmap is justified with the highest PRB number within the selected RBG subset. $N_{RB}^{RBG \text{ subset}}(p)$ is the number of PRBs in RBG subset p and can be calculated by the following equation,

$$N_{RB}^{RBG \text{ subset}}(p) = \begin{cases} \left\lfloor \frac{N_{RB}^{DL} - 1}{P^2} \right\rfloor \cdot P + P & , p < \left\lfloor \frac{N_{RB}^{DL} - 1}{P} \right\rfloor \bmod P \\ \left\lfloor \frac{N_{RB}^{DL} - 1}{P^2} \right\rfloor \cdot P + (N_{RB}^{DL} - 1) \bmod P + 1 & , p = \left\lfloor \frac{N_{RB}^{DL} - 1}{P} \right\rfloor \bmod P \\ \left\lfloor \frac{N_{RB}^{DL} - 1}{P^2} \right\rfloor \cdot P & , p > \left\lfloor \frac{N_{RB}^{DL} - 1}{P} \right\rfloor \bmod P \end{cases}$$

Consequently, when RBG subset p is indicated, bit i for $i = 0, 1, \dots, N_{RB}^{TYPE1} - 1$ in the bitmap field indicates PRB number,

$$n_{PRB}^{RBG \text{ subset}}(p) = \left\lfloor \frac{i + \Delta_{\text{shift}}(p)}{P} \right\rfloor P^2 + p \cdot P + (i + \Delta_{\text{shift}}(p)) \bmod P$$

[TS 36.213 clause 7.1.7]

To determine the modulation order and transport block size(s) in the physical downlink shared channel, the UE shall first

- read the 5-bit “modulation and coding scheme” field (I_{MCS}) in the DCI

and second if the DCI CRC is scrambled by P-RNTI, RA-RNTI, or SI-RNTI then

...

else

- set the Table 7.1.7.2.1-1 column indicator N'_{PRB} to the total number of allocated PRBs based on the procedure defined in Section 7.1.6.

if the transport block is transmitted in DwPTS of the special subframe in frame structure type 2, then

$$\text{set the Table 7.1.7.2.1-1 column indicator } N_{PRB} = \max \left\{ \left\lfloor N'_{PRB} \times 0.75 \right\rfloor, 1 \right\},$$

else, set the Table 7.1.7.2.1-1 column indicator $N_{PRB} = N'_{PRB}$.

The UE may skip decoding a transport block in an initial transmission if the effective channel code rate is higher than 0.930, where the effective channel code rate is defined as the number of downlink information bits (including CRC bits) divided by the number of physical channel bits on PDSCH. If the UE skips decoding, the physical layer indicates to higher layer that the transport block is not successfully decoded. For the special subframe configurations 0 and 5 with normal CP or configurations 0 and 4 with extended CP, shown in table 4.2-1 [3], there shall be no PDSCH transmission in DwPTS of the special subframe.

[TS 36.213 clause 7.1.7.1]

The UE shall use $Q_m = 2$ if the DCI CRC is scrambled by P-RNTI, RA-RNTI, or SI-RNTI, otherwise, the UE shall use I_{MCS} and Table 7.1.7.1-1 to determine the modulation order (Q_m) used in the physical downlink shared channel.

Table 7.1.7.1-1: Modulation and TBS index table for PDSCH

MCS Index I_{MCS}	Modulation Order Q_m	TBS Index I_{TBS}
0	2	0
1	2	1
2	2	2
3	2	3
4	2	4
5	2	5
6	2	6
7	2	7
8	2	8
9	2	9
10	4	9
11	4	10
12	4	11
13	4	12
14	4	13
15	4	14
16	4	15
17	6	15
18	6	16
19	6	17
20	6	18
21	6	19
22	6	20
23	6	21
24	6	22
25	6	23
26	6	24
27	6	25
28	6	26
29	2	reserved
30	4	
31	6	

[TS 36.213 clause 7.1.7.2]

If the DCI CRC is scrambled by P-RNTI, RA-RNTI, or SI-RNTI then

- for DCI format 1A:
 - the UE shall set the TBS index (I_{TBS}) equal to I_{MCS} and determine its TBS by the procedure in Section 7.1.7.2.1.

...

else

- for $0 \leq I_{MCS} \leq 28$, the UE shall first determine the TBS index (I_{TBS}) using I_{MCS} and Table 7.1.7.1-1 except if the transport block is disabled in DCI formats 2 and 2A as specified below. For a transport block that is not mapped to two-layer spatial multiplexing, the TBS is determined by the procedure in Section 7.1.7.2.1. For a transport block that is mapped to two-layer spatial multiplexing, the TBS is determined by the procedure in Section 7.1.7.2.2.
- for $29 \leq I_{MCS} \leq 31$, the TBS is assumed to be as determined from DCI transported in the latest PDCCH for the same transport block using $0 \leq I_{MCS} \leq 28$. If there is no latest PDCCH for the same transport block

using $0 \leq I_{MCS} \leq 28$, and if the initial PDSCH for the same transport block is semi-persistently scheduled, the TBS shall be determined from the most recent semi-persistent scheduling assignment PDCCH.

- In DCI formats 2 and 2A a transport block is disabled if $I_{MCS} = 0$ and if $rv_{idx} = 1$ otherwise the transport block is enabled.

The NDI and HARQ process ID, as signalled on PDCCH, and the TBS, as determined above, shall be delivered to higher layers.

[TS 36.213 clause 7.1.7.2.1]

For $1 \leq N_{PRB} \leq 110$, the TBS is given by the (I_{TBS}, N_{PRB}) entry of Table 7.1.7.2.1-1.

Table 7.1.7.2.1-1: Transport block size table (dimension 27x110)

I_{TBS}	N_{PRB}									
	1	2	3	4	5	6	7	8	9	10
0	16	32	56	88	120	152	176	208	224	256
1	24	56	88	144	176	208	224	256	328	344
2	32	72	144	176	208	256	296	328	376	424
3	40	104	176	208	256	328	392	440	504	568
4	56	120	208	256	328	408	488	552	632	696
5	72	144	224	328	424	504	600	680	776	872
6	328	176	256	392	504	600	712	808	936	1032
7	104	224	328	472	584	712	840	968	1096	1224
8	120	256	392	536	680	808	968	1096	1256	1384
9	136	296	456	616	776	936	1096	1256	1416	1544
10	144	328	504	680	872	1032	1224	1384	1544	1736
11	176	376	584	776	1000	1192	1384	1608	1800	2024
12	208	440	680	904	1128	1352	1608	1800	2024	2280
13	224	488	744	1000	1256	1544	1800	2024	2280	2536
14	256	552	840	1128	1416	1736	1992	2280	2600	2856
15	280	600	904	1224	1544	1800	2152	2472	2728	3112
16	328	632	968	1288	1608	1928	2280	2600	2984	3240
17	336	696	1064	1416	1800	2152	2536	2856	3240	3624
18	376	776	1160	1544	1992	2344	2792	3112	3624	4008
19	408	840	1288	1736	2152	2600	2984	3496	3880	4264
20	440	904	1384	1864	2344	2792	3240	3752	4136	4584
21	488	1000	1480	1992	2472	2984	3496	4008	4584	4968
22	520	1064	1608	2152	2664	3240	3752	4264	4776	5352
23	552	1128	1736	2280	2856	3496	4008	4584	5160	5736
24	584	1192	1800	2408	2984	3624	4264	4968	5544	5992
25	616	1256	1864	2536	3112	3752	4392	5160	5736	6200
26	712	1480	2216	2984	3752	4392	5160	5992	6712	7480

I_{TBS}	N_{PRB}									
	11	12	13	14	15	16	17	18	19	20
0	288	328	344	376	392	424	456	488	504	536
1	376	424	456	488	520	568	600	632	680	712
2	472	520	568	616	648	696	744	776	840	872
3	616	680	744	808	872	904	968	1032	1096	1160
4	776	840	904	1000	1064	1128	1192	1288	1352	1416
5	968	1032	1128	1224	1320	1384	1480	1544	1672	1736
6	1128	1224	1352	1480	1544	1672	1736	1864	1992	2088
7	1320	1480	1608	1672	1800	1928	2088	2216	2344	2472
8	1544	1672	1800	1928	2088	2216	2344	2536	2664	2792
9	1736	1864	2024	2216	2344	2536	2664	2856	2984	3112
10	1928	2088	2280	2472	2664	2792	2984	3112	3368	3496
11	2216	2408	2600	2792	2984	3240	3496	3624	3880	4008
12	2472	2728	2984	3240	3368	3624	3880	4136	4392	4584
13	2856	3112	3368	3624	3880	4136	4392	4584	4968	5160
14	3112	3496	3752	4008	4264	4584	4968	5160	5544	5736
15	3368	3624	4008	4264	4584	4968	5160	5544	5736	6200
16	3624	3880	4264	4584	4968	5160	5544	5992	6200	6456
17	4008	4392	4776	5160	5352	5736	6200	6456	6712	7224
18	4392	4776	5160	5544	5992	6200	6712	7224	7480	7992
19	4776	5160	5544	5992	6456	6968	7224	7736	8248	8504
20	5160	5544	5992	6456	6968	7480	7992	8248	8760	9144
21	5544	5992	6456	6968	7480	7992	8504	9144	9528	9912
22	5992	6456	6968	7480	7992	8504	9144	9528	10296	10680
23	6200	6968	7480	7992	8504	9144	9912	10296	11064	11448
24	6712	7224	7992	8504	9144	9912	10296	11064	11448	12216
25	6968	7480	8248	8760	9528	10296	10680	11448	12216	12576
26	8248	8760	9528	10296	11064	11832	12576	13536	14112	14688

I_{TBS}	N_{PRB}									
	21	22	23	24	25	26	27	28	29	30
0	288	328	344	376	392	424	456	488	504	536
1	376	424	456	488	520	568	600	632	680	712
2	472	520	568	616	648	696	744	776	840	872
3	616	680	744	808	872	904	968	1032	1096	1160
4	776	840	904	1000	1064	1128	1192	1288	1352	1416
5	968	1032	1128	1224	1320	1384	1480	1544	1672	1736
6	1128	1224	1352	1480	1544	1672	1736	1864	1992	2088
7	1320	1480	1608	1672	1800	1928	2088	2216	2344	2472
8	1544	1672	1800	1928	2088	2216	2344	2536	2664	2792
9	1736	1864	2024	2216	2344	2536	2664	2856	2984	3112
10	1928	2088	2280	2472	2664	2792	2984	3112	3368	3496
11	2216	2408	2600	2792	2984	3240	3496	3624	3880	4008
12	2472	2728	2984	3240	3368	3624	3880	4136	4392	4584
13	2856	3112	3368	3624	3880	4136	4392	4584	4968	5160
14	3112	3496	3752	4008	4264	4584	4968	5160	5544	5736
15	3368	3624	4008	4264	4584	4968	5160	5544	5736	6200
16	3624	3880	4264	4584	4968	5160	5544	5992	6200	6456
17	4008	4392	4776	5160	5352	5736	6200	6456	6712	7224
18	4392	4776	5160	5544	5992	6200	6712	7224	7480	7992
19	4776	5160	5544	5992	6456	6968	7224	7736	8248	8504
20	5160	5544	5992	6456	6968	7480	7992	8248	8760	9144
21	5544	5992	6456	6968	7480	7992	8504	9144	9528	9912
22	5992	6456	6968	7480	7992	8504	9144	9528	10296	10680
23	6200	6968	7480	7992	8504	9144	9912	10296	11064	11448
24	6712	7224	7992	8504	9144	9912	10296	11064	11448	12216
25	6968	7480	8248	8760	9528	10296	10680	11448	12216	12576
26	8248	8760	9528	10296	11064	11832	12576	13536	14112	14688

0	568	600	616	648	680	712	744	776	776	808
1	744	776	808	872	904	936	968	1000	1032	1064
2	936	968	1000	1064	1096	1160	1192	1256	1288	1320
3	1224	1256	1320	1384	1416	1480	1544	1608	1672	1736
4	1480	1544	1608	1736	1800	1864	1928	1992	2088	2152
5	1864	1928	2024	2088	2216	2280	2344	2472	2536	2664
6	2216	2280	2408	2472	2600	2728	2792	2984	2984	3112
7	2536	2664	2792	2984	3112	3240	3368	3368	3496	3624
8	2984	3112	3240	3368	3496	3624	3752	3880	4008	4264
9	3368	3496	3624	3752	4008	4136	4264	4392	4584	4776
10	3752	3880	4008	4264	4392	4584	4776	4968	5160	5352
11	4264	4392	4584	4776	4968	5352	5544	5736	5992	5992
12	4776	4968	5352	5544	5736	5992	6200	6456	6712	6712
13	5352	5736	5992	6200	6456	6712	6968	7224	7480	7736
14	5992	6200	6456	6968	7224	7480	7736	7992	8248	8504
15	6456	6712	6968	7224	7736	7992	8248	8504	8760	9144
16	6712	7224	7480	7736	7992	8504	8760	9144	9528	9912
17	7480	7992	8248	8760	9144	9528	9912	10296	10296	10680
18	8248	8760	9144	9528	9912	10296	10680	11064	11448	11832
19	9144	9528	9912	10296	10680	11064	11448	12216	12576	12960
20	9912	10296	10680	11064	11448	12216	12576	12960	13536	14112
21	10680	11064	11448	12216	12576	12960	13536	14112	14688	15264
22	11448	11832	12576	12960	13536	14112	14688	15264	15840	16416
23	12216	12576	12960	13536	14112	14688	15264	15840	16416	16992
24	12960	13536	14112	14688	15264	15840	16416	16992	17568	18336
25	13536	14112	14688	15264	15840	16416	16992	17568	18336	19080
26	15264	16416	16992	17568	18336	19080	19848	20616	21384	22152

I_{TBS}	N_{PRB}									
	31	32	33	34	35	36	37	38	39	40
0	840	872	904	936	968	1000	1032	1032	1064	1096
1	1128	1160	1192	1224	1256	1288	1352	1384	1416	1416
2	1384	1416	1480	1544	1544	1608	1672	1672	1736	1800
3	1800	1864	1928	1992	2024	2088	2152	2216	2280	2344
4	2216	2280	2344	2408	2472	2600	2664	2728	2792	2856
5	2728	2792	2856	2984	3112	3112	3240	3368	3496	3496
6	3240	3368	3496	3496	3624	3752	3880	4008	4136	4136
7	3752	3880	4008	4136	4264	4392	4584	4584	4776	4968
8	4392	4584	4584	4776	4968	4968	5160	5352	5544	5544
9	4968	5160	5160	5352	5544	5736	5736	5992	6200	6200
10	5544	5736	5736	5992	6200	6200	6456	6712	6712	6968
11	6200	6456	6712	6968	6968	7224	7480	7736	7736	7992
12	6968	7224	7480	7736	7992	8248	8504	8760	8760	9144
13	7992	8248	8504	8760	9144	9144	9528	9912	9912	10296
14	8760	9144	9528	9912	9912	10296	10680	11064	11064	11448
15	9528	9912	10296	10296	10680	11064	11448	11832	11832	12216
16	9912	10296	10680	11064	11448	11832	12216	12216	12576	12960
17	11064	11448	11832	12216	12576	12960	13536	13536	14112	14688
18	12216	12576	12960	13536	14112	14112	14688	15264	15264	15840
19	13536	13536	14112	14688	15264	15264	15840	16416	16992	16992
20	14688	14688	15264	15840	16416	16992	16992	17568	18336	18336
21	15840	15840	16416	16992	17568	18336	18336	19080	19848	19848
22	16992	16992	17568	18336	19080	19080	19848	20616	21384	21384
23	17568	18336	19080	19848	19848	20616	21384	22152	22152	22920
24	19080	19848	19848	20616	21384	22152	22920	22920	23688	24496
25	19848	20616	20616	21384	22152	22920	23688	24496	24496	25456
26	22920	23688	24496	25456	25456	26416	27376	28336	29296	29296

I_{TBS}	N_{PRB}									
	41	42	43	44	45	46	47	48	49	50
0	1128	1160	1192	1224	1256	1256	1288	1320	1352	1384
1	1480	1544	1544	1608	1608	1672	1736	1736	1800	1800
2	1800	1864	1928	1992	2024	2088	2088	2152	2216	2216
3	2408	2472	2536	2536	2600	2664	2728	2792	2856	2856
4	2984	2984	3112	3112	3240	3240	3368	3496	3496	3624

5	3624	3752	3752	3880	4008	4008	4136	4264	4392	4392
6	4264	4392	4584	4584	4776	4776	4968	4968	5160	5160
7	4968	5160	5352	5352	5544	5736	5736	5992	5992	6200
8	5736	5992	5992	6200	6200	6456	6456	6712	6968	6968
9	6456	6712	6712	6968	6968	7224	7480	7480	7736	7992
10	7224	7480	7480	7736	7992	7992	8248	8504	8504	8760
11	8248	8504	8760	8760	9144	9144	9528	9528	9912	9912
12	9528	9528	9912	9912	10296	10680	10680	11064	11064	11448
13	10680	10680	11064	11448	11448	11832	12216	12216	12576	12960
14	11832	12216	12216	12576	12960	12960	13536	13536	14112	14112
15	12576	12960	12960	13536	13536	14112	14688	14688	15264	15264
16	13536	13536	14112	14112	14688	14688	15264	15840	15840	16416
17	14688	15264	15264	15840	16416	16416	16992	17568	17568	18336
18	16416	16416	16992	17568	17568	18336	18336	19080	19080	19848
19	17568	18336	18336	19080	19080	19848	20616	20616	21384	21384
20	19080	19848	19848	20616	20616	21384	22152	22152	22920	22920
21	20616	21384	21384	22152	22920	22920	23688	24496	24496	25456
22	22152	22920	22920	23688	24496	24496	25456	25456	26416	27376
23	23688	24496	24496	25456	25456	26416	27376	27376	28336	28336
24	25456	25456	26416	26416	27376	28336	28336	29296	29296	30576
25	26416	26416	27376	28336	28336	29296	29296	30576	31704	31704
26	30576	30576	31704	32856	32856	34008	35160	35160	36696	36696

I_{TBS}	N_{PRB}									
	51	52	53	54	55	56	57	58	59	60
0	1416	1416	1480	1480	1544	1544	1608	1608	1608	1672
1	1864	1864	1928	1992	1992	2024	2088	2088	2152	2152
2	2280	2344	2344	2408	2472	2536	2536	2600	2664	2664
3	2984	2984	3112	3112	3240	3240	3368	3368	3496	3496
4	3624	3752	3752	3880	4008	4008	4136	4136	4264	4264
5	4584	4584	4776	4776	4776	4968	4968	5160	5160	5352
6	5352	5352	5544	5736	5736	5992	5992	5992	6200	6200
7	6200	6456	6456	6712	6712	6712	6968	6968	7224	7224
8	7224	7224	7480	7480	7736	7736	7992	7992	8248	8504
9	7992	8248	8248	8504	8760	8760	9144	9144	9144	9528
10	9144	9144	9144	9528	9528	9912	9912	10296	10296	10680
11	10296	10680	10680	11064	11064	11448	11448	11832	11832	12216
12	11832	11832	12216	12216	12576	12576	12960	12960	13536	13536
13	12960	13536	13536	14112	14112	14688	14688	14688	15264	15264
14	14688	14688	15264	15264	15840	15840	16416	16416	16992	16992
15	15840	15840	16416	16416	16992	16992	17568	17568	18336	18336
16	16416	16992	16992	17568	17568	18336	18336	19080	19080	19848
17	18336	19080	19080	19848	19848	20616	20616	20616	21384	21384
18	19848	20616	21384	21384	22152	22152	22920	22920	23688	23688
19	22152	22152	22920	22920	23688	24496	24496	25456	25456	25456
20	23688	24496	24496	25456	25456	26416	26416	27376	27376	28336
21	25456	26416	26416	27376	27376	28336	28336	29296	29296	30576
22	27376	28336	28336	29296	29296	30576	30576	31704	31704	32856
23	29296	29296	30576	30576	31704	31704	32856	32856	34008	34008
24	31704	31704	32856	32856	34008	34008	35160	35160	36696	36696
25	32856	32856	34008	34008	35160	35160	36696	36696	37888	37888
26	37888	37888	39232	40576	40576	40576	42368	42368	43816	43816

I_{TBS}	N_{PRB}									
	61	62	63	64	65	66	67	68	69	70
0	1672	1736	1736	1800	1800	1800	1864	1864	1928	1928
1	2216	2280	2280	2344	2344	2408	2472	2472	2536	2536
2	2728	2792	2856	2856	2856	2984	2984	3112	3112	3112
3	3624	3624	3624	3752	3752	3880	3880	4008	4008	4136
4	4392	4392	4584	4584	4584	4776	4776	4968	4968	4968
5	5352	5544	5544	5736	5736	5736	5992	5992	5992	6200
6	6456	6456	6456	6712	6712	6968	6968	6968	7224	7224
7	7480	7480	7736	7736	7992	7992	8248	8248	8504	8504
8	8504	8760	8760	9144	9144	9144	9528	9528	9528	9912
9	9528	9912	9912	10296	10296	10296	10680	10680	11064	11064

10	10680	11064	11064	11448	11448	11448	11832	11832	12216	12216
11	12216	12576	12576	12960	12960	13536	13536	13536	14112	14112
12	14112	14112	14112	14688	14688	15264	15264	15264	15840	15840
13	15840	15840	16416	16416	16992	16992	16992	17568	17568	18336
14	17568	17568	18336	18336	18336	19080	19080	19848	19848	19848
15	18336	19080	19080	19848	19848	20616	20616	20616	21384	21384
16	19848	19848	20616	20616	21384	21384	22152	22152	22152	22920
17	22152	22152	22920	22920	23688	23688	24496	24496	24496	25456
18	24496	24496	24496	25456	25456	26416	26416	27376	27376	27376
19	26416	26416	27376	27376	28336	28336	29296	29296	29296	30576
20	28336	29296	29296	29296	30576	30576	31704	31704	31704	32856
21	30576	31704	31704	31704	32856	32856	34008	34008	35160	35160
22	32856	34008	34008	34008	35160	35160	36696	36696	36696	37888
23	35160	35160	36696	36696	37888	37888	37888	39232	39232	40576
24	36696	37888	37888	39232	39232	40576	40576	42368	42368	42368
25	39232	39232	40576	40576	40576	42368	42368	43816	43816	43816
26	45352	45352	46888	46888	48936	48936	48936	51024	51024	52752

I_{TBS}	N_{PRB}									
	71	72	73	74	75	76	77	78	79	80
0	1992	1992	2024	2088	2088	2088	2152	2152	2216	2216
1	2600	2600	2664	2728	2728	2792	2792	2856	2856	2856
2	3240	3240	3240	3368	3368	3368	3496	3496	3496	3624
3	4136	4264	4264	4392	4392	4392	4584	4584	4584	4776
4	5160	5160	5160	5352	5352	5544	5544	5544	5736	5736
5	6200	6200	6456	6456	6712	6712	6712	6968	6968	6968
6	7480	7480	7736	7736	7736	7992	7992	8248	8248	8248
7	8760	8760	8760	9144	9144	9144	9528	9528	9528	9912
8	9912	9912	10296	10296	10680	10680	10680	11064	11064	11064
9	11064	11448	11448	11832	11832	11832	12216	12216	12576	12576
10	12576	12576	12960	12960	12960	13536	13536	13536	14112	14112
11	14112	14688	14688	14688	15264	15264	15840	15840	15840	16416
12	16416	16416	16416	16992	16992	17568	17568	17568	18336	18336
13	18336	18336	19080	19080	19080	19848	19848	19848	20616	20616
14	20616	20616	20616	21384	21384	22152	22152	22152	22920	22920
15	22152	22152	22152	22920	22920	23688	23688	23688	24496	24496
16	22920	23688	23688	24496	24496	24496	25456	25456	25456	26416
17	25456	26416	26416	26416	27376	27376	27376	28336	28336	29296
18	28336	28336	29296	29296	29296	30576	30576	30576	31704	31704
19	30576	30576	31704	31704	32856	32856	32856	34008	34008	34008
20	32856	34008	34008	34008	35160	35160	35160	36696	36696	36696
21	35160	36696	36696	36696	37888	37888	39232	39232	39232	40576
22	37888	39232	39232	40576	40576	40576	42368	42368	42368	43816
23	40576	40576	42368	42368	43816	43816	43816	45352	45352	45352
24	43816	43816	45352	45352	45352	46888	46888	46888	48936	48936
25	45352	45352	46888	46888	46888	48936	48936	48936	51024	51024
26	52752	52752	55056	55056	55056	55056	57336	57336	57336	59256

I_{TBS}	N_{PRB}									
	81	82	83	84	85	86	87	88	89	90
0	2280	2280	2280	2344	2344	2408	2408	2472	2472	2536
1	2984	2984	2984	3112	3112	3112	3240	3240	3240	3240
2	3624	3624	3752	3752	3880	3880	3880	4008	4008	4008
3	4776	4776	4776	4968	4968	4968	5160	5160	5160	5352
4	5736	5992	5992	5992	5992	6200	6200	6200	6456	6456
5	7224	7224	7224	7480	7480	7480	7736	7736	7736	7992
6	8504	8504	8760	8760	8760	9144	9144	9144	9144	9528
7	9912	9912	10296	10296	10296	10680	10680	10680	11064	11064
8	11448	11448	11448	11832	11832	12216	12216	12216	12576	12576
9	12960	12960	12960	13536	13536	13536	13536	14112	14112	14112
10	14112	14688	14688	14688	14688	15264	15264	15264	15840	15840
11	16416	16416	16992	16992	16992	17568	17568	17568	18336	18336
12	18336	19080	19080	19080	19080	19848	19848	19848	20616	20616
13	20616	21384	21384	21384	22152	22152	22152	22920	22920	22920
14	22920	23688	23688	24496	24496	24496	25456	25456	25456	25456

15	24496	25456	25456	25456	26416	26416	26416	27376	27376	27376
16	26416	26416	27376	27376	27376	28336	28336	28336	29296	29296
17	29296	29296	30576	30576	30576	30576	31704	31704	31704	32856
18	31704	32856	32856	32856	34008	34008	34008	35160	35160	35160
19	35160	35160	35160	36696	36696	36696	37888	37888	37888	39232
20	37888	37888	39232	39232	39232	40576	40576	40576	42368	42368
21	40576	40576	42368	42368	42368	43816	43816	43816	45352	45352
22	43816	43816	45352	45352	45352	46888	46888	46888	48936	48936
23	46888	46888	46888	48936	48936	48936	51024	51024	51024	51024
24	48936	51024	51024	51024	52752	52752	52752	52752	55056	55056
25	51024	52752	52752	52752	55056	55056	55056	55056	57336	57336
26	59256	59256	61664	61664	61664	63776	63776	63776	66592	66592

I_{TBS}	N_{PRB}									
	91	92	93	94	95	96	97	98	99	100
0	2536	2536	2600	2600	2664	2664	2728	2728	2728	2792
1	3368	3368	3368	3496	3496	3496	3496	3624	3624	3624
2	4136	4136	4136	4264	4264	4264	4392	4392	4392	4584
3	5352	5352	5352	5544	5544	5544	5736	5736	5736	5736
4	6456	6456	6712	6712	6712	6968	6968	6968	6968	7224
5	7992	7992	8248	8248	8248	8504	8504	8760	8760	8760
6	9528	9528	9528	9912	9912	9912	10296	10296	10296	10296
7	11064	11448	11448	11448	11448	11832	11832	11832	12216	12216
8	12576	12960	12960	12960	13536	13536	13536	13536	14112	14112
9	14112	14688	14688	14688	15264	15264	15264	15264	15840	15840
10	15840	16416	16416	16416	16992	16992	16992	16992	17568	17568
11	18336	18336	19080	19080	19080	19080	19848	19848	19848	19848
12	20616	21384	21384	21384	21384	22152	22152	22152	22920	22920
13	23688	23688	23688	24496	24496	24496	25456	25456	25456	25456
14	26416	26416	26416	27376	27376	27376	28336	28336	28336	28336
15	28336	28336	28336	29296	29296	29296	29296	30576	30576	30576
16	29296	30576	30576	30576	30576	31704	31704	31704	31704	32856
17	32856	32856	34008	34008	34008	35160	35160	35160	35160	36696
18	36696	36696	36696	37888	37888	37888	37888	39232	39232	39232
19	39232	39232	40576	40576	40576	40576	42368	42368	42368	43816
20	42368	42368	43816	43816	43816	45352	45352	45352	46888	46888
21	45352	46888	46888	46888	46888	48936	48936	48936	48936	51024
22	48936	48936	51024	51024	51024	51024	52752	52752	52752	55056
23	52752	52752	52752	55056	55056	55056	55056	57336	57336	57336
24	55056	57336	57336	57336	57336	59256	59256	59256	61664	61664
25	57336	59256	59256	59256	61664	61664	61664	61664	63776	63776
26	66592	68808	68808	68808	71112	71112	71112	73712	73712	75376

I_{TBS}	N_{PRB}									
	101	102	103	104	105	106	107	108	109	110
0	2792	2856	2856	2856	2984	2984	2984	2984	2984	3112
1	3752	3752	3752	3752	3880	3880	3880	4008	4008	4008
2	4584	4584	4584	4584	4776	4776	4776	4776	4968	4968
3	5992	5992	5992	5992	6200	6200	6200	6200	6456	6456
4	7224	7224	7480	7480	7480	7480	7736	7736	7736	7992
5	8760	9144	9144	9144	9144	9528	9528	9528	9528	9528
6	10680	10680	10680	10680	11064	11064	11064	11448	11448	11448
7	12216	12576	12576	12576	12960	12960	12960	12960	13536	13536
8	14112	14112	14688	14688	14688	14688	15264	15264	15264	15264
9	15840	16416	16416	16416	16416	16992	16992	16992	16992	17568
10	17568	18336	18336	18336	18336	18336	19080	19080	19080	19080
11	20616	20616	20616	21384	21384	21384	21384	22152	22152	22152
12	22920	23688	23688	23688	23688	24496	24496	24496	24496	25456
13	26416	26416	26416	26416	27376	27376	27376	27376	28336	28336
14	29296	29296	29296	29296	30576	30576	30576	30576	31704	31704
15	30576	31704	31704	31704	31704	32856	32856	32856	34008	34008
16	32856	32856	34008	34008	34008	34008	35160	35160	35160	35160
17	36696	36696	36696	37888	37888	37888	39232	39232	39232	39232
18	40576	40576	40576	40576	42368	42368	42368	42368	43816	43816
19	43816	43816	43816	45352	45352	45352	46888	46888	46888	46888

20	46888	46888	48936	48936	48936	48936	48936	51024	51024	51024
21	51024	51024	51024	52752	52752	52752	52752	55056	55056	55056
22	55056	55056	55056	57336	57336	57336	57336	59256	59256	59256
23	57336	59256	59256	59256	59256	61664	61664	61664	61664	63776
24	61664	61664	63776	63776	63776	63776	66592	66592	66592	66592
25	63776	63776	66592	66592	66592	66592	68808	68808	68808	71112
26	75376	75376	75376	75376	75376	75376	75376	75376	75376	75376

[TS 36.306 clause 4.1]

The field *ue-Category* parameter defines a combined uplink and downlink capability. The parameters set by the UE Category are defined in subclause 4.2. Tables 4.1-1 and 4.1-2 define the downlink and, respectively, uplink physical layer parameter values for each UE Category.

Table 4.1-1: Downlink physical layer parameter values set by the field *ue-Category*

UE Category	Maximum number of DL-SCH transport block bits received within a TTI	Maximum number of bits of a DL-SCH transport block received within a TTI	Total number of soft channel bits	Maximum number of supported layers for spatial multiplexing in DL
Category 1	10296	10296	250368	1
Category 2	51024	51024	1237248	2
Category 3	102048	75376	1237248	2
Category 4	150752	75376	1827072	2
Category 5	299552	149776	3667200	4

Table 4.1-2: Uplink physical layer parameter values set by the field *ue-Category*

UE Category	Maximum number of bits of an UL-SCH transport block transmitted within a TTI	Support for 64QAM in UL
Category 1	5160	No
Category 2	25456	No
Category 3	51024	No
Category 4	51024	No
Category 5	75376	Yes

7.1.7.1.2.3 Test description

7.1.7.1.2.3.1 Pre-test conditions

System Simulator:

- Cell 1.
- Uplink and downlink bandwidth set to the maximum bandwidth for the E-UTRA Band under test as specified in Table 5.6.1-1 in [31] (to enable testing of N_{PRB} up to maximum value). For Band 18, Band 19 and Band 25, based on industry requirement, uplink and downlink bandwidth set to 10MHz.

UE:

None.

Preamble:

- The UE is in state Loopback Activated (state 4) according to [18].

7.1.7.1.2.3.2 Test procedure sequence

Table 7.1.7.1.2.3.2-1: Maximum TB_{size} for different UE categories

UE Category	Maximum number of bits of a DL-SCH transport block received within a TTI
Category 1	10296
Category 2	51024
Category 3	75376
Category 4	75376
Category 5	149776

Table 7.1.7.1.2.3.2-2: Number of downlink PDCP SDUs and PDCP SDU size used as test data

TB_{size} [bits]	Number of PDCP SDUs	PDCP SDU size [bits] See note 1
$104 \leq TB_{size} \leq 12096$ note 2	1	$8 * \text{FLOOR}((TB_{size} - 96)/8)$
$12097 \leq TB_{size} \leq 24128$	2	$8 * \text{FLOOR}((TB_{size} - 128)/16)$
$24129 \leq TB_{size} \leq 36152$	3	$8 * \text{FLOOR}((TB_{size} - 152)/24)$
$36153 \leq TB_{size} \leq 48184$	4	$8 * \text{FLOOR}((TB_{size} - 184)/32)$
$48185 \leq TB_{size} \leq 60208$	5	$8 * \text{FLOOR}((TB_{size} - 208)/40)$
$60209 \leq TB_{size} \leq 72240$	6	$8 * \text{FLOOR}((TB_{size} - 240)/48)$
$TB_{size} > 72240$	7	$8 * \text{FLOOR}((TB_{size} - 264)/56)$

Note 1: Each PDCP SDU is limited to 1500 octets (to keep below maximum SDU size of ESM as specified in TS 24.301 clause 9.9.4.12).

The PDCP SDU size of each PDCP SDU is

PDCP SDU size = $(TB_{size} - N * \text{PDCP header size} - \text{AMD PDU header size} - \text{MAC header size} - \text{Size of Timing Advance} - \text{RLC Status PDU size}) / N$, where

PDCP header size is 16 bits for the RLC AM and 12-bit SN case;
AMD PDU header size is $\text{CIEL}[(16 + (N-1) * 12)/8]$ bytes which includes 16 standard AM header and (N-1) Length indicators; and

MAC header size = 40 bits as MAC header can be

R/R/E/LCID MAC subheader (8 bits for Timing Advance) + R/R/E/LCID MAC subheader (16 bits for MAC SDU for RLC Status PDU) + R/R/E/LCID MAC subheader (8 bits for MAC SDU for AMD PDU) = 8 + 16 + 8 bits = 32 bits
OR
R/R/E/LCID MAC subheader (8 bits for Timing Advance) + R/R/E/LCID MAC subheader (24 bits for MAC SDU for AMD PDU, Note: Length can be 2 bytes depending on the size of AMD PDU) + R/R/E/LCID MAC subheader (8 bits for MAC SDU for RLC Status PDU) = 8 + 24 + 8 bits = 40 bits

Therefore maximum MAC header size can be 40 bits

Size of Timing Advance MAC CE is 8 bits (if no Timing Advance and/or RLC status needs to be sent, padding will occur instead)
RLC Status PDU size = 16 bits

This gives:

PDCP SDU size = $8 * \text{FLOOR}((TB_{size} - N * 16 - 8 * \text{CIEL}[(16 + (N-1) * 12)/8] - 64)/(8 * N))$ bits

Note 2: According to TS 36.213 Table 7.1.7.2.1-1 and the final PDCP SDU size formula in Note 1, the smallest TB_{size} that can be tested is 104 bits.

Table 7.1.7.1.2.3.2-2a: Bandwidth Dependent Parameters

Max Bandwidth	Max N_{PRB}	N_{RB}^{TYPE1}
10 Mhz	50	14
15 Mhz	75	16
20 Mhz	100	22

Note : Maximum bandwidth for EUTRA bands is 10/15/20 Mhz.

Table 7.1.7.1.2.3.2-2b: Ambiguous Sizes of Information Bits

{12, 14, 16 ,20, 24, 26, 32, 40, 44, 56}

Table 7.1.7.1.2.3.2-3: Main behaviour

St	Procedure	Message Sequence		TP	Verdict
		U – S	Message		
-	EXCEPTION: Steps 1 to 4 are repeated for values of N_{PRB} from 1 to N_{RB}^{TYPE1} as per table 7.1.7.1.2.3.2-2a and I_{MCS} from 0 to 28.	-	-	-	-
1	SS looks up I_{TBS} in table 7.1.7.1-1 in TS 36.213 based on the value of I_{MCS} . SS looks up TB_{size} in table 7.1.7.2.1-1 in TS 36.213 based on values of N_{PRB} and I_{TBS} .	-	-	-	-
-	EXCEPTION: Steps 2 to 4 are performed if TB_{size} is less than or equal to UE capability “Maximum number of DL-SCH transport block bits received within a TTI” as specified in Table 7.1.7.1.2.3.2-1 and larger than or equal to 104 bits as specified in Table 7.1.7.1.2.3.2-2, and the effective channel code rate, as defined in TS 36.213 clause 7.1.7, is lower than or equal to 0.930.	-	-	-	-
2	SS creates one or more PDCP SDUs, depending on TB_{size} , in accordance with Table 7.1.7.1.2.3.2-2.	-	-	-	-
3	SS transmits the PDCP SDUs concatenated into a MAC PDU and indicates on PDCCH DCI Format 1 with RA type 1 and a resource block assignment (RBA) correspondent to N_{PRB} as specified in 7.1.6.2 in TS 36.213 and modulation and coding scheme I_{MCS} . If the number of information bits in format 1 is equal to that for format 0/1A, one bit of value zero shall be appended to format 1 by the SS.	<--	MAC PDU (NxPDCP SDUs) DCI: (DCI Format 1, RA type 1, RBA(N_{PRB}), I_{MCS})	-	-

	If the number of information bits in format 1 belongs to one of the sizes in Table 7.1.7.1.2.3.2-2b, one or more zero bit(s) shall be appended to format 1 by the SS until the payload size of format 1 does not belong to one of the sizes in Table 7.1.7.1.2.3.2-2b and not equal to that of format 0/1A.				
3A	At the reception of scheduling request the SS transmits UL Grant for transmitting loop back PDCP SDUs.	<--	(UL Grant)		
4	CHECK: Does UE return the same number of PDCP SDUs with same content as transmitted by the SS in step 3?	-->	(NxPDCP SDUs)	1	P

7.1.7.1.2.3.3 Specific Message Contents

Table 7.1.7.1.2.3.3.1: MAC-MainConfig-RBC (preamble Table 4.5.3.3-1 [18]: Step 8)

Derivation Path: 36.508 Table 4.8.2.1.5-1			
Information Element	Value/remark	Comment	Condition
retxBSR-Timer	sf320		

Table 7.1.7.1.2.3.3-2: UECapabilityInformation (Preamble Table 4.5.2.3-1 [18]: Step 13)

Derivation Path: 36.508 table 4.6.1-23			
Information Element	Value/remark	Comment	Condition
UECapabilityInformation ::= SEQUENCE {			
criticalExtensions CHOICE {			
c1 CHOICE{			
ueCapabilityInformation-r8 SEQUENCE {			
ue-CapabilityRAT-ContainerList SEQUENCE (SIZE (1..maxRAT-Capabilities)) OF SEQUENCE {	1 entry		
ueCapabilityRAT-Container			
ue-EUTRA-Capability SEQUENCE {			
ue-Category	Checked against UE Category indications in the PICS		
}			
}			
}			

7.1.7.1.3 DL-SCH transport block size selection / DCI format 1A / RA type 2 / Localised VRB

7.1.7.1.3.1 Test Purpose (TP)

(1)

with { UE in E-UTRA RRC_CONNECTED state }
 ensure that {
 when { UE on PDCCH receives DCI format 1A indicating Resource Allocation Type 2 with Localized VRB, a resource block assignment correspondent to N_{PRB} physical resource blocks and a modulation and coding scheme I_{MCS} }

then { UE decodes the received transport block of size correspondent to the read N_{PRB} and I_{MCS}
and forwards it to higher layers }
 }

7.1.7.1.3.2 Conformance requirements

References: The conformance requirements covered in the current TC are specified in: TS 36.212, clauses 5.3.3.1.2 and 5.3.3.1.3; TS 36.213, clauses 7.1.6.3, 7.1.7, 7.1.7.1, 7.1.7.2 and 7.1.7.2.1; and TS 36.306 clause 4.1.

[TS 36.212 clause 5.3.3.1.2]

...

Table 5.3.3.1.2-1: Ambiguous Sizes of Information Bits

{12, 14, 16, 20, 24, 26, 32, 40, 44, 56}
--

[TS 36.212 clause 5.3.3.1.3]

DCI format 1A is used for the compact scheduling of one PDSCH codeword and random access procedure initiated by a PDCCH order.

The following information is transmitted by means of the DCI format 1A:

- Flag for format0/format1A differentiation – 1 bit, where value 0 indicates format 0 and value 1 indicates format 1A

...

Otherwise,

- Localized/Distributed VRB assignment flag – 1 bit as defined in 7.1.6.3 of [3]

- Resource block assignment – $\lceil \log_2(N_{\text{RB}}^{\text{DL}}(N_{\text{RB}}^{\text{DL}} + 1)/2) \rceil$ bits as defined in section 7.1.6.3 of [3]:

- For localized VRB:

$\lceil \log_2(N_{\text{RB}}^{\text{DL}}(N_{\text{RB}}^{\text{DL}} + 1)/2) \rceil$ bits provide the resource allocation

- For distributed VRB:

- If $N_{\text{RB}}^{\text{DL}} < 50$ or if the format 1A CRC is scrambled by RA-RNTI, P-RNTI, or SI-RNTI

- $\lceil \log_2(N_{\text{RB}}^{\text{DL}}(N_{\text{RB}}^{\text{DL}} + 1)/2) \rceil$ bits provide the resource allocation

- Else

- 1 bit, the MSB indicates the gap value, where value 0 indicates $N_{\text{gap}} = N_{\text{gap},1}$ and value 1 indicates

$N_{\text{gap}} = N_{\text{gap},2}$

- $(\lceil \log_2(N_{\text{RB}}^{\text{DL}}(N_{\text{RB}}^{\text{DL}} + 1)/2) \rceil - 1)$ bits provide the resource allocation

- Modulation and coding scheme – 5bits as defined in section 7.1.7 of [3]

If the number of information bits in format 1A is less than that of format 0, zeros shall be appended to format 1A until the payload size equals that of format 0.

If the number of information bits in format 1A belongs to one of the sizes in Table 5.3.3.1.2-1, one zero bit shall be appended to format 1A.

...

[TS 36.213 clause 7.1.6.3]

In resource allocations of type 2, the resource block assignment information indicates to a scheduled UE a set of contiguously allocated localized virtual resource blocks or distributed virtual resource blocks. In case of resource allocation signalled with PDCCH DCI format 1A, 1B or 1D, one bit flag indicates whether localized virtual resource blocks or distributed virtual resource blocks are assigned (value 0 indicates Localized and value 1 indicates Distributed VRB assignment) while distributed virtual resource blocks are always assigned in case of resource allocation signalled with PDCCH DCI format 1C. Localized VRB allocations for a UE vary from a single VRB up to a maximum number of VRBs spanning the system bandwidth. For DCI format 1A the distributed VRB allocations for a UE vary from a single VRB up to N_{VRB}^{DL} VRBs, where N_{VRB}^{DL} is defined in [3], if the DCI CRC is scrambled by P-RNTI, RA-RNTI, or SI-RNTI. With PDCCH DCI format 1B, 1D, or 1A with a CRC scrambled with C-RNTI, distributed VRB allocations for a UE vary from a single VRB up to N_{VRB}^{DL} VRBs if N_{RB}^{DL} is 6-49 and vary from a single VRB up to 16 if N_{RB}^{DL} is 50-110. With PDCCH DCI format 1C, distributed VRB allocations for a UE vary from N_{RB}^{step} VRB(s) up to $\lfloor N_{VRB}^{DL} / N_{RB}^{step} \rfloor \cdot N_{RB}^{step}$ VRBs with an increment step of N_{RB}^{step} , where N_{RB}^{step} value is determined depending on the downlink system bandwidth as shown in Table 7.1.6.3-1.

Table 7.1.6.3-1: N_{RB}^{step} values vs. Downlink System Bandwidth

System BW (N_{RB}^{DL})	N_{RB}^{step}
	DCI format 1C
6-49	2
50-110	4

For PDCCH DCI format 1A, 1B or 1D, a type 2 resource allocation field consists of a resource indication value (RIV) corresponding to a starting resource block (RB_{start}) and a length in terms of virtually contiguously allocated resource blocks L_{CRBs} . The resource indication value is defined by

if $(L_{CRBs} - 1) \leq \lfloor N_{RB}^{DL} / 2 \rfloor$ then

$$RIV = N_{RB}^{DL} (L_{CRBs} - 1) + RB_{start}$$

else

$$RIV = N_{RB}^{DL} (N_{RB}^{DL} - L_{CRBs} + 1) + (N_{RB}^{DL} - 1 - RB_{start})$$

where $L_{CRBs} \geq 1$ and shall not exceed $N_{VRB}^{DL} - RB_{start}$.

For PDCCH DCI format 1C, a type 2 resource block assignment field consists of a resource indication value (RIV) corresponding to a starting resource block ($RB_{start} = 0, N_{RB}^{step}, 2N_{RB}^{step}, \dots, (\lfloor N_{VRB}^{DL} / N_{RB}^{step} \rfloor - 1)N_{RB}^{step}$) and a length in terms of virtually contiguously allocated resource blocks ($L_{CRBs} = N_{RB}^{step}, 2N_{RB}^{step}, \dots, \lfloor N_{VRB}^{DL} / N_{RB}^{step} \rfloor \cdot N_{RB}^{step}$). The resource indication value is defined by

if $(L'_{CRBs} - 1) \leq \lfloor N_{VRB}^{DL} / 2 \rfloor$ then

$$RIV = N_{VRB}^{DL} (L'_{CRBs} - 1) + RB'_{start}$$

else

$$RIV = N_{VRB}^{DL} (N_{VRB}^{DL} - L'_{CRBs} + 1) + (N_{VRB}^{DL} - 1 - RB'_{start})$$

where $L'_{CRBs} = L_{CRBs} / N_{RB}^{step}$, $RB'_{start} = RB_{start} / N_{RB}^{step}$ and $N_{VRB}^{DL} = \lfloor N_{VRB}^{DL} / N_{RB}^{step} \rfloor$. Here,

$L'_{CRBs} \geq 1$ and shall not exceed $N_{VRB}^{DL} - RB'_{start}$.

[TS 36.213 clause 7.1.7]

To determine the modulation order and transport block size(s) in the physical downlink shared channel, the UE shall first

- read the 5-bit “modulation and coding scheme” field (I_{MCS}) in the DCI

and second if the DCI CRC is scrambled by P-RNTI, RA-RNTI, or SI-RNTI then

...

else

- set the Table 7.1.7.2.1-1 column indicator N'_{PRB} to the total number of allocated PRBs based on the procedure defined in Section 7.1.6.

if the transport block is transmitted in DwPTS of the special subframe in frame structure type 2, then

$$\text{set the Table 7.1.7.2.1-1 column indicator } N_{PRB} = \max \left\{ \left\lfloor N'_{PRB} \times 0.75 \right\rfloor, 1 \right\},$$

else, set the Table 7.1.7.2.1-1 column indicator $N_{PRB} = N'_{PRB}$.

The UE may skip decoding a transport block in an initial transmission if the effective channel code rate is higher than 0.930, where the effective channel code rate is defined as the number of downlink information bits (including CRC bits) divided by the number of physical channel bits on PDSCH. If the UE skips decoding, the physical layer indicates to higher layer that the transport block is not successfully decoded. For the special subframe configurations 0 and 5 with normal CP or configurations 0 and 4 with extended CP, shown in table 4.2-1 [3], there shall be no PDSCH transmission in DwPTS of the special subframe.

[TS 36.213 clause 7.1.7.1]

The UE shall use $Q_m = 2$ if the DCI CRC is scrambled by P-RNTI, RA-RNTI, or SI-RNTI, otherwise, the UE shall use I_{MCS} and Table 7.1.7.1-1 to determine the modulation order (Q_m) used in the physical downlink shared channel.

Table 7.1.7.1-1: Modulation and TBS index table for PDSCH

MCS Index I_{MCS}	Modulation Order Q_m	TBS Index I_{TBS}
0	2	0
1	2	1
2	2	2
3	2	3
4	2	4
5	2	5
6	2	6
7	2	7
8	2	8
9	2	9
10	4	9
11	4	10
12	4	11
13	4	12
14	4	13
15	4	14
16	4	15
17	6	15
18	6	16
19	6	17
20	6	18
21	6	19
22	6	20
23	6	21
24	6	22
25	6	23
26	6	24
27	6	25
28	6	26
29	2	reserved
30	4	
31	6	

[TS 36.213 clause 7.1.7.2]

If the DCI CRC is scrambled by P-RNTI, RA-RNTI, or SI-RNTI then

- for DCI format 1A:
 - the UE shall set the TBS index (I_{TBS}) equal to I_{MCS} and determine its TBS by the procedure in Section 7.1.7.2.1.

...

else

- for $0 \leq I_{MCS} \leq 28$, the UE shall first determine the TBS index (I_{TBS}) using I_{MCS} and Table 7.1.7.1-1 except if the transport block is disabled in DCI formats 2 and 2A as specified below. For a transport block that is not mapped to two-layer spatial multiplexing, the TBS is determined by the procedure in Section 7.1.7.2.1. For a transport block that is mapped to two-layer spatial multiplexing, the TBS is determined by the procedure in Section 7.1.7.2.2.
- for $29 \leq I_{MCS} \leq 31$, the TBS is assumed to be as determined from DCI transported in the latest PDCCH for the same transport block using $0 \leq I_{MCS} \leq 28$. If there is no latest PDCCH for the same transport block using $0 \leq I_{MCS} \leq 28$, and if the initial PDSCH for the same transport block is semi-persistently scheduled, the TBS shall be determined from the most recent semi-persistent scheduling assignment PDCCH.

- In DCI formats 2 and 2A a transport block is disabled if $I_{MCS} = 0$ and if $rv_{idx} = 1$ otherwise the transport block is enabled.

The NDI and HARQ process ID, as signalled on PDCCH, and the TBS, as determined above, shall be delivered to higher layers.

[TS 36.213 clause 7.1.7.2.1]

For $1 \leq N_{PRB} \leq 110$, the TBS is given by the (I_{TBS}, N_{PRB}) entry of Table 7.1.7.2.1-1.

Table 7.1.7.2.1-1: Transport block size table (dimension 27x110)

I_{TBS}	N_{PRB}									
	1	2	3	4	5	6	7	8	9	10
0	16	32	56	88	120	152	176	208	224	256
1	24	56	88	144	176	208	224	256	328	344
2	32	72	144	176	208	256	296	328	376	424
3	40	104	176	208	256	328	392	440	504	568
4	56	120	208	256	328	408	488	552	632	696
5	72	144	224	328	424	504	600	680	776	872
6	328	176	256	392	504	600	712	808	936	1032
7	104	224	328	472	584	712	840	968	1096	1224
8	120	256	392	536	680	808	968	1096	1256	1384
9	136	296	456	616	776	936	1096	1256	1416	1544
10	144	328	504	680	872	1032	1224	1384	1544	1736
11	176	376	584	776	1000	1192	1384	1608	1800	2024
12	208	440	680	904	1128	1352	1608	1800	2024	2280
13	224	488	744	1000	1256	1544	1800	2024	2280	2536
14	256	552	840	1128	1416	1736	1992	2280	2600	2856
15	280	600	904	1224	1544	1800	2152	2472	2728	3112
16	328	632	968	1288	1608	1928	2280	2600	2984	3240
17	336	696	1064	1416	1800	2152	2536	2856	3240	3624
18	376	776	1160	1544	1992	2344	2792	3112	3624	4008
19	408	840	1288	1736	2152	2600	2984	3496	3880	4264
20	440	904	1384	1864	2344	2792	3240	3752	4136	4584
21	488	1000	1480	1992	2472	2984	3496	4008	4584	4968
22	520	1064	1608	2152	2664	3240	3752	4264	4776	5352
23	552	1128	1736	2280	2856	3496	4008	4584	5160	5736
24	584	1192	1800	2408	2984	3624	4264	4968	5544	5992
25	616	1256	1864	2536	3112	3752	4392	5160	5736	6200
26	712	1480	2216	2984	3752	4392	5160	5992	6712	7480

I_{TBS}	N_{PRB}									
	11	12	13	14	15	16	17	18	19	20
0	288	328	344	376	392	424	456	488	504	536
1	376	424	456	488	520	568	600	632	680	712
2	472	520	568	616	648	696	744	776	840	872
3	616	680	744	808	872	904	968	1032	1096	1160
4	776	840	904	1000	1064	1128	1192	1288	1352	1416
5	968	1032	1128	1224	1320	1384	1480	1544	1672	1736
6	1128	1224	1352	1480	1544	1672	1736	1864	1992	2088
7	1320	1480	1608	1672	1800	1928	2088	2216	2344	2472
8	1544	1672	1800	1928	2088	2216	2344	2536	2664	2792
9	1736	1864	2024	2216	2344	2536	2664	2856	2984	3112
10	1928	2088	2280	2472	2664	2792	2984	3112	3368	3496
11	2216	2408	2600	2792	2984	3240	3496	3624	3880	4008
12	2472	2728	2984	3240	3368	3624	3880	4136	4392	4584
13	2856	3112	3368	3624	3880	4136	4392	4584	4968	5160
14	3112	3496	3752	4008	4264	4584	4968	5160	5544	5736
15	3368	3624	4008	4264	4584	4968	5160	5544	5736	6200
16	3624	3880	4264	4584	4968	5160	5544	5992	6200	6456
17	4008	4392	4776	5160	5352	5736	6200	6456	6712	7224
18	4392	4776	5160	5544	5992	6200	6712	7224	7480	7992
19	4776	5160	5544	5992	6456	6968	7224	7736	8248	8504
20	5160	5544	5992	6456	6968	7480	7992	8248	8760	9144
21	5544	5992	6456	6968	7480	7992	8504	9144	9528	9912
22	5992	6456	6968	7480	7992	8504	9144	9528	10296	10680
23	6200	6968	7480	7992	8504	9144	9912	10296	11064	11448
24	6712	7224	7992	8504	9144	9912	10296	11064	11448	12216
25	6968	7480	8248	8760	9528	10296	10680	11448	12216	12576
26	8248	8760	9528	10296	11064	11832	12576	13536	14112	14688

I_{TBS}	N_{PRB}									
	21	22	23	24	25	26	27	28	29	30

0	568	600	616	648	680	712	744	776	776	808
1	744	776	808	872	904	936	968	1000	1032	1064
2	936	968	1000	1064	1096	1160	1192	1256	1288	1320
3	1224	1256	1320	1384	1416	1480	1544	1608	1672	1736
4	1480	1544	1608	1736	1800	1864	1928	1992	2088	2152
5	1864	1928	2024	2088	2216	2280	2344	2472	2536	2664
6	2216	2280	2408	2472	2600	2728	2792	2984	2984	3112
7	2536	2664	2792	2984	3112	3240	3368	3368	3496	3624
8	2984	3112	3240	3368	3496	3624	3752	3880	4008	4264
9	3368	3496	3624	3752	4008	4136	4264	4392	4584	4776
10	3752	3880	4008	4264	4392	4584	4776	4968	5160	5352
11	4264	4392	4584	4776	4968	5352	5544	5736	5992	5992
12	4776	4968	5352	5544	5736	5992	6200	6456	6712	6712
13	5352	5736	5992	6200	6456	6712	6968	7224	7480	7736
14	5992	6200	6456	6968	7224	7480	7736	7992	8248	8504
15	6456	6712	6968	7224	7736	7992	8248	8504	8760	9144
16	6712	7224	7480	7736	7992	8504	8760	9144	9528	9912
17	7480	7992	8248	8760	9144	9528	9912	10296	10296	10680
18	8248	8760	9144	9528	9912	10296	10680	11064	11448	11832
19	9144	9528	9912	10296	10680	11064	11448	12216	12576	12960
20	9912	10296	10680	11064	11448	12216	12576	12960	13536	14112
21	10680	11064	11448	12216	12576	12960	13536	14112	14688	15264
22	11448	11832	12576	12960	13536	14112	14688	15264	15840	16416
23	12216	12576	12960	13536	14112	14688	15264	15840	16416	16992
24	12960	13536	14112	14688	15264	15840	16416	16992	17568	18336
25	13536	14112	14688	15264	15840	16416	16992	17568	18336	19080
26	15264	16416	16992	17568	18336	19080	19848	20616	21384	22152

I_{TBS}	N_{PRB}									
	31	32	33	34	35	36	37	38	39	40
0	840	872	904	936	968	1000	1032	1032	1064	1096
1	1128	1160	1192	1224	1256	1288	1352	1384	1416	1416
2	1384	1416	1480	1544	1544	1608	1672	1672	1736	1800
3	1800	1864	1928	1992	2024	2088	2152	2216	2280	2344
4	2216	2280	2344	2408	2472	2600	2664	2728	2792	2856
5	2728	2792	2856	2984	3112	3112	3240	3368	3496	3496
6	3240	3368	3496	3496	3624	3752	3880	4008	4136	4136
7	3752	3880	4008	4136	4264	4392	4584	4584	4776	4968
8	4392	4584	4584	4776	4968	4968	5160	5352	5544	5544
9	4968	5160	5160	5352	5544	5736	5736	5992	6200	6200
10	5544	5736	5736	5992	6200	6200	6456	6712	6712	6968
11	6200	6456	6712	6968	6968	7224	7480	7736	7736	7992
12	6968	7224	7480	7736	7992	8248	8504	8760	8760	9144
13	7992	8248	8504	8760	9144	9144	9528	9912	9912	10296
14	8760	9144	9528	9912	9912	10296	10680	11064	11064	11448
15	9528	9912	10296	10296	10680	11064	11448	11832	11832	12216
16	9912	10296	10680	11064	11448	11832	12216	12216	12576	12960
17	11064	11448	11832	12216	12576	12960	13536	13536	14112	14688
18	12216	12576	12960	13536	14112	14112	14688	15264	15264	15840
19	13536	13536	14112	14688	15264	15264	15840	16416	16992	16992
20	14688	14688	15264	15840	16416	16992	16992	17568	18336	18336
21	15840	15840	16416	16992	17568	18336	18336	19080	19848	19848
22	16992	16992	17568	18336	19080	19080	19848	20616	21384	21384
23	17568	18336	19080	19848	19848	20616	21384	22152	22152	22920
24	19080	19848	19848	20616	21384	22152	22920	22920	23688	24496
25	19848	20616	20616	21384	22152	22920	23688	24496	24496	25456
26	22920	23688	24496	25456	25456	26416	27376	28336	29296	29296

I_{TBS}	N_{PRB}									
	41	42	43	44	45	46	47	48	49	50
0	1128	1160	1192	1224	1256	1256	1288	1320	1352	1384
1	1480	1544	1544	1608	1608	1672	1736	1736	1800	1800
2	1800	1864	1928	1992	2024	2088	2088	2152	2216	2216
3	2408	2472	2536	2536	2600	2664	2728	2792	2856	2856
4	2984	2984	3112	3112	3240	3240	3368	3496	3496	3624

5	3624	3752	3752	3880	4008	4008	4136	4264	4392	4392
6	4264	4392	4584	4584	4776	4776	4968	4968	5160	5160
7	4968	5160	5352	5352	5544	5736	5736	5992	5992	6200
8	5736	5992	5992	6200	6200	6456	6456	6712	6968	6968
9	6456	6712	6712	6968	6968	7224	7480	7480	7736	7992
10	7224	7480	7480	7736	7992	7992	8248	8504	8504	8760
11	8248	8504	8760	8760	9144	9144	9528	9528	9912	9912
12	9528	9528	9912	9912	10296	10680	10680	11064	11064	11448
13	10680	10680	11064	11448	11448	11832	12216	12216	12576	12960
14	11832	12216	12216	12576	12960	12960	13536	13536	14112	14112
15	12576	12960	12960	13536	13536	14112	14688	14688	15264	15264
16	13536	13536	14112	14112	14688	14688	15264	15840	15840	16416
17	14688	15264	15264	15840	16416	16416	16992	17568	17568	18336
18	16416	16416	16992	17568	17568	18336	18336	19080	19080	19848
19	17568	18336	18336	19080	19080	19848	20616	20616	21384	21384
20	19080	19848	19848	20616	20616	21384	22152	22152	22920	22920
21	20616	21384	21384	22152	22920	22920	23688	24496	24496	25456
22	22152	22920	22920	23688	24496	24496	25456	25456	26416	27376
23	23688	24496	24496	25456	25456	26416	27376	27376	28336	28336
24	25456	25456	26416	26416	27376	28336	28336	29296	29296	30576
25	26416	26416	27376	28336	28336	29296	29296	30576	31704	31704
26	30576	30576	31704	32856	32856	34008	35160	35160	36696	36696

I_{TBS}	N_{PRB}									
	51	52	53	54	55	56	57	58	59	60
0	1416	1416	1480	1480	1544	1544	1608	1608	1608	1672
1	1864	1864	1928	1992	1992	2024	2088	2088	2152	2152
2	2280	2344	2344	2408	2472	2536	2536	2600	2664	2664
3	2984	2984	3112	3112	3240	3240	3368	3368	3496	3496
4	3624	3752	3752	3880	4008	4008	4136	4136	4264	4264
5	4584	4584	4776	4776	4776	4968	4968	5160	5160	5352
6	5352	5352	5544	5736	5736	5992	5992	5992	6200	6200
7	6200	6456	6456	6712	6712	6712	6968	6968	7224	7224
8	7224	7224	7480	7480	7736	7736	7992	7992	8248	8504
9	7992	8248	8248	8504	8760	8760	9144	9144	9144	9528
10	9144	9144	9144	9528	9528	9912	9912	10296	10296	10680
11	10296	10680	10680	11064	11064	11448	11448	11832	11832	12216
12	11832	11832	12216	12216	12576	12576	12960	12960	13536	13536
13	12960	13536	13536	14112	14112	14688	14688	14688	15264	15264
14	14688	14688	15264	15264	15840	15840	16416	16416	16992	16992
15	15840	15840	16416	16416	16992	16992	17568	17568	18336	18336
16	16416	16992	16992	17568	17568	18336	18336	19080	19080	19848
17	18336	19080	19080	19848	19848	20616	20616	20616	21384	21384
18	19848	20616	21384	21384	22152	22152	22920	22920	23688	23688
19	22152	22152	22920	22920	23688	24496	24496	25456	25456	25456
20	23688	24496	24496	25456	25456	26416	26416	27376	27376	28336
21	25456	26416	26416	27376	27376	28336	28336	29296	29296	30576
22	27376	28336	28336	29296	29296	30576	30576	31704	31704	32856
23	29296	29296	30576	30576	31704	31704	32856	32856	34008	34008
24	31704	31704	32856	32856	34008	34008	35160	35160	36696	36696
25	32856	32856	34008	34008	35160	35160	36696	36696	37888	37888
26	37888	37888	39232	40576	40576	40576	42368	42368	43816	43816

I_{TBS}	N_{PRB}									
	61	62	63	64	65	66	67	68	69	70
0	1672	1736	1736	1800	1800	1800	1864	1864	1928	1928
1	2216	2280	2280	2344	2344	2408	2472	2472	2536	2536
2	2728	2792	2856	2856	2856	2984	2984	3112	3112	3112
3	3624	3624	3624	3752	3752	3880	3880	4008	4008	4136
4	4392	4392	4584	4584	4584	4776	4776	4968	4968	4968
5	5352	5544	5544	5736	5736	5736	5992	5992	5992	6200
6	6456	6456	6456	6712	6712	6968	6968	6968	7224	7224
7	7480	7480	7736	7736	7992	7992	8248	8248	8504	8504
8	8504	8760	8760	9144	9144	9144	9528	9528	9528	9912
9	9528	9912	9912	10296	10296	10296	10680	10680	11064	11064

10	10680	11064	11064	11448	11448	11448	11832	11832	12216	12216
11	12216	12576	12576	12960	12960	13536	13536	13536	14112	14112
12	14112	14112	14112	14688	14688	15264	15264	15264	15840	15840
13	15840	15840	16416	16416	16992	16992	16992	17568	17568	18336
14	17568	17568	18336	18336	18336	19080	19080	19848	19848	19848
15	18336	19080	19080	19848	19848	20616	20616	20616	21384	21384
16	19848	19848	20616	20616	21384	21384	22152	22152	22152	22920
17	22152	22152	22920	22920	23688	23688	24496	24496	24496	25456
18	24496	24496	24496	25456	25456	26416	26416	27376	27376	27376
19	26416	26416	27376	27376	28336	28336	29296	29296	29296	30576
20	28336	29296	29296	29296	30576	30576	31704	31704	31704	32856
21	30576	31704	31704	31704	32856	32856	34008	34008	35160	35160
22	32856	34008	34008	34008	35160	35160	36696	36696	36696	37888
23	35160	35160	36696	36696	37888	37888	37888	39232	39232	40576
24	36696	37888	37888	39232	39232	40576	40576	42368	42368	42368
25	39232	39232	40576	40576	40576	42368	42368	43816	43816	43816
26	45352	45352	46888	46888	48936	48936	48936	51024	51024	52752

I_{TBS}	N_{PRB}									
	71	72	73	74	75	76	77	78	79	80
0	1992	1992	2024	2088	2088	2088	2152	2152	2216	2216
1	2600	2600	2664	2728	2728	2792	2792	2856	2856	2856
2	3240	3240	3240	3368	3368	3368	3496	3496	3496	3624
3	4136	4264	4264	4392	4392	4392	4584	4584	4584	4776
4	5160	5160	5160	5352	5352	5544	5544	5544	5736	5736
5	6200	6200	6456	6456	6712	6712	6712	6968	6968	6968
6	7480	7480	7736	7736	7736	7992	7992	8248	8248	8248
7	8760	8760	8760	9144	9144	9144	9528	9528	9528	9912
8	9912	9912	10296	10296	10680	10680	10680	11064	11064	11064
9	11064	11448	11448	11832	11832	11832	12216	12216	12576	12576
10	12576	12576	12960	12960	12960	13536	13536	13536	14112	14112
11	14112	14688	14688	14688	15264	15264	15840	15840	15840	16416
12	16416	16416	16416	16992	16992	17568	17568	17568	18336	18336
13	18336	18336	19080	19080	19080	19848	19848	19848	20616	20616
14	20616	20616	20616	21384	21384	22152	22152	22152	22920	22920
15	22152	22152	22152	22920	22920	23688	23688	23688	24496	24496
16	22920	23688	23688	24496	24496	24496	25456	25456	25456	26416
17	25456	26416	26416	26416	27376	27376	27376	28336	28336	29296
18	28336	28336	29296	29296	29296	30576	30576	30576	31704	31704
19	30576	30576	31704	31704	32856	32856	32856	34008	34008	34008
20	32856	34008	34008	34008	35160	35160	35160	36696	36696	36696
21	35160	36696	36696	36696	37888	37888	39232	39232	39232	40576
22	37888	39232	39232	40576	40576	40576	42368	42368	42368	43816
23	40576	40576	42368	42368	43816	43816	43816	45352	45352	45352
24	43816	43816	45352	45352	45352	46888	46888	46888	48936	48936
25	45352	45352	46888	46888	46888	48936	48936	48936	51024	51024
26	52752	52752	55056	55056	55056	55056	57336	57336	57336	59256

I_{TBS}	N_{PRB}									
	81	82	83	84	85	86	87	88	89	90
0	2280	2280	2280	2344	2344	2408	2408	2472	2472	2536
1	2984	2984	2984	3112	3112	3112	3240	3240	3240	3240
2	3624	3624	3752	3752	3880	3880	3880	4008	4008	4008
3	4776	4776	4776	4968	4968	4968	5160	5160	5160	5352
4	5736	5992	5992	5992	5992	6200	6200	6200	6456	6456
5	7224	7224	7224	7480	7480	7480	7736	7736	7736	7992
6	8504	8504	8760	8760	8760	9144	9144	9144	9144	9528
7	9912	9912	10296	10296	10296	10680	10680	10680	11064	11064
8	11448	11448	11448	11832	11832	12216	12216	12216	12576	12576
9	12960	12960	12960	13536	13536	13536	13536	14112	14112	14112
10	14112	14688	14688	14688	14688	15264	15264	15264	15840	15840
11	16416	16416	16992	16992	16992	17568	17568	17568	18336	18336
12	18336	19080	19080	19080	19080	19848	19848	19848	20616	20616
13	20616	21384	21384	21384	22152	22152	22152	22920	22920	22920
14	22920	23688	23688	24496	24496	24496	25456	25456	25456	25456

15	24496	25456	25456	25456	26416	26416	26416	27376	27376	27376
16	26416	26416	27376	27376	27376	28336	28336	28336	29296	29296
17	29296	29296	30576	30576	30576	30576	31704	31704	31704	32856
18	31704	32856	32856	32856	34008	34008	34008	35160	35160	35160
19	35160	35160	35160	36696	36696	36696	37888	37888	37888	39232
20	37888	37888	39232	39232	39232	40576	40576	40576	42368	42368
21	40576	40576	42368	42368	42368	43816	43816	43816	45352	45352
22	43816	43816	45352	45352	45352	46888	46888	46888	48936	48936
23	46888	46888	46888	48936	48936	48936	51024	51024	51024	51024
24	48936	51024	51024	51024	52752	52752	52752	52752	55056	55056
25	51024	52752	52752	52752	55056	55056	55056	55056	57336	57336
26	59256	59256	61664	61664	61664	63776	63776	63776	66592	66592

I_{TBS}	N_{PRB}									
	91	92	93	94	95	96	97	98	99	100
0	2536	2536	2600	2600	2664	2664	2728	2728	2728	2792
1	3368	3368	3368	3496	3496	3496	3496	3624	3624	3624
2	4136	4136	4136	4264	4264	4264	4392	4392	4392	4584
3	5352	5352	5352	5544	5544	5544	5736	5736	5736	5736
4	6456	6456	6712	6712	6712	6968	6968	6968	6968	7224
5	7992	7992	8248	8248	8248	8504	8504	8760	8760	8760
6	9528	9528	9528	9912	9912	9912	10296	10296	10296	10296
7	11064	11448	11448	11448	11448	11832	11832	11832	12216	12216
8	12576	12960	12960	12960	13536	13536	13536	13536	14112	14112
9	14112	14688	14688	14688	15264	15264	15264	15264	15840	15840
10	15840	16416	16416	16416	16992	16992	16992	16992	17568	17568
11	18336	18336	19080	19080	19080	19080	19848	19848	19848	19848
12	20616	21384	21384	21384	21384	22152	22152	22152	22920	22920
13	23688	23688	23688	24496	24496	24496	25456	25456	25456	25456
14	26416	26416	26416	27376	27376	27376	28336	28336	28336	28336
15	28336	28336	28336	29296	29296	29296	29296	30576	30576	30576
16	29296	30576	30576	30576	30576	31704	31704	31704	31704	32856
17	32856	32856	34008	34008	34008	35160	35160	35160	35160	36696
18	36696	36696	36696	37888	37888	37888	37888	39232	39232	39232
19	39232	39232	40576	40576	40576	40576	42368	42368	42368	43816
20	42368	42368	43816	43816	43816	45352	45352	45352	46888	46888
21	45352	46888	46888	46888	46888	48936	48936	48936	48936	51024
22	48936	48936	51024	51024	51024	51024	52752	52752	52752	55056
23	52752	52752	52752	55056	55056	55056	55056	57336	57336	57336
24	55056	57336	57336	57336	57336	59256	59256	59256	61664	61664
25	57336	59256	59256	59256	61664	61664	61664	61664	63776	63776
26	66592	68808	68808	68808	71112	71112	71112	73712	73712	75376

I_{TBS}	N_{PRB}									
	101	102	103	104	105	106	107	108	109	110
0	2792	2856	2856	2856	2984	2984	2984	2984	2984	3112
1	3752	3752	3752	3752	3880	3880	3880	4008	4008	4008
2	4584	4584	4584	4584	4776	4776	4776	4776	4968	4968
3	5992	5992	5992	5992	6200	6200	6200	6200	6456	6456
4	7224	7224	7480	7480	7480	7480	7736	7736	7736	7992
5	8760	9144	9144	9144	9144	9528	9528	9528	9528	9528
6	10680	10680	10680	10680	11064	11064	11064	11448	11448	11448
7	12216	12576	12576	12576	12960	12960	12960	12960	13536	13536
8	14112	14112	14688	14688	14688	14688	15264	15264	15264	15264
9	15840	16416	16416	16416	16416	16992	16992	16992	16992	17568
10	17568	18336	18336	18336	18336	18336	19080	19080	19080	19080
11	20616	20616	20616	21384	21384	21384	21384	22152	22152	22152
12	22920	23688	23688	23688	23688	24496	24496	24496	24496	25456
13	26416	26416	26416	26416	27376	27376	27376	27376	28336	28336
14	29296	29296	29296	29296	30576	30576	30576	30576	31704	31704
15	30576	31704	31704	31704	31704	32856	32856	32856	34008	34008
16	32856	32856	34008	34008	34008	34008	35160	35160	35160	35160
17	36696	36696	36696	37888	37888	37888	39232	39232	39232	39232
18	40576	40576	40576	40576	42368	42368	42368	42368	43816	43816
19	43816	43816	43816	45352	45352	45352	46888	46888	46888	46888

20	46888	46888	48936	48936	48936	48936	48936	51024	51024	51024
21	51024	51024	51024	52752	52752	52752	52752	55056	55056	55056
22	55056	55056	55056	57336	57336	57336	57336	59256	59256	59256
23	57336	59256	59256	59256	59256	61664	61664	61664	61664	63776
24	61664	61664	63776	63776	63776	63776	63776	66592	66592	66592
25	63776	63776	66592	66592	66592	66592	68808	68808	68808	71112
26	75376	75376	75376	75376	75376	75376	75376	75376	75376	75376

[TS 36.306 clause 4.1]

The field *ue-Category* defines a combined uplink and downlink capability. The parameters set by the UE Category are defined in subclause 4.2. Tables 4.1-1 and 4.1-2 define the downlink and, respectively, uplink physical layer parameter values for each UE Category.

Table 4.1-1: Downlink physical layer parameter values set by the field *ue-Category*

UE Category	Maximum number of DL-SCH transport block bits received within a TTI	Maximum number of bits of a DL-SCH transport block received within a TTI	Total number of soft channel bits	Maximum number of supported layers for spatial multiplexing in DL
Category 1	10296	10296	250368	1
Category 2	51024	51024	1237248	2
Category 3	102048	75376	1237248	2
Category 4	150752	75376	1827072	2
Category 5	299552	149776	3667200	4

Table 4.1-2: Uplink physical layer parameter values set by the field *ue-Category*

UE Category	Maximum number of bits of an UL-SCH transport block transmitted within a TTI	Support for 64QAM in UL
Category 1	5160	No
Category 2	25456	No
Category 3	51024	No
Category 4	51024	No
Category 5	75376	Yes

7.1.7.1.3.3 Test description

7.1.7.1.3.3.1 Pre-test conditions

System Simulator:

- Cell 1.
- Uplink and downlink bandwidth set to the maximum bandwidth for the E-UTRA Band under test as specified in Table 5.6.1-1 in [31] (to enable testing of N_{PRB} up to maximum value). For Band 18, Band 19 and Band 25, based on industry requirement, uplink and downlink bandwidth set to 10MHz.

UE:

None.

Preamble:

- The UE is in state Loopback Activated (state 4) according to [18].

7.1.7.1.3.3.2 Test procedure sequence

Table 7.1.7.1.3.3.2-1: Maximum TB_{size} for different UE categories

UE Category	Maximum number of bits of a DL-SCH transport block received within a TTI
Category 1	10296
Category 2	51024
Category 3	75376
Category 4	75376
Category 5	149776

Table 7.1.7.1.3.3.2-2: Number of downlink PDCP SDUs and PDCP SDU size used as test data

TB_{size} [bits]	Number of PDCP SDUs	PDCP SDU size [bits] See note 1
$104 \leq TB_{size} \leq 12096$ note 2	1	$8 * \text{FLOOR}((TB_{size} - 96)/8)$
$12097 \leq TB_{size} \leq 24128$	2	$8 * \text{FLOOR}((TB_{size} - 128)/16)$
$24129 \leq TB_{size} \leq 36152$	3	$8 * \text{FLOOR}((TB_{size} - 152)/24)$
$36153 \leq TB_{size} \leq 48184$	4	$8 * \text{FLOOR}((TB_{size} - 184)/32)$
$48185 \leq TB_{size} \leq 60208$	5	$8 * \text{FLOOR}((TB_{size} - 208)/40)$
$60209 \leq TB_{size} \leq 72240$	6	$8 * \text{FLOOR}((TB_{size} - 240)/48)$
$TB_{size} > 72240$	7	$8 * \text{FLOOR}((TB_{size} - 264)/56)$

Note 1: Each PDCP SDU is limited to 1500 octets (to keep below maximum SDU size of ESM as specified in TS 24.301 clause 9.9.4.12).

The PDCP SDU size of each PDCP SDU is

PDCP SDU size = $(TB_{size} - N * \text{PDCP header size} - \text{AMD PDU header size} - \text{MAC header size} - \text{Size of Timing Advance} - \text{RLC Status PDU size}) / N$, where

PDCP header size is 16 bits for the RLC AM and 12-bit SN case;
AMD PDU header size is $\text{CIEL}[(16 + (N-1) * 12)/8]$ bytes which includes 16 standard AM header and (N-1) Length indicators; and

MAC header size = 40 bits as MAC header can be
R/R/E/LCID MAC subheader (8 bits for Timing Advance) + R/R/E/LCID MAC subheader (16 bits for MAC SDU for RLC Status PDU) + R/R/E/LCID MAC subheader (8 bits for MAC SDU for AMD PDU) = 8 + 16 + 8 bits = 32 bits
Or
R/R/E/LCID MAC subheader (8 bits for Timing Advance) + R/R/E/LCID MAC subheader (24 bits for MAC SDU for AMD PDU, Note: Length can be 2 bytes depending on the size of AMD PDU) + R/R/E/LCID MAC subheader (8 bits for MAC SDU for RLC Status PDU) = 8 + 24 + 8 bits = 40 bits

Therefore maximum MAC header size can be 40 bits

Size of Timing Advance MAC CE is 8 bits (if no Timing Advance and/or RLC status needs to be sent, padding will occur instead)
RLC Status PDU size = 16 bits

This gives:

PDCP SDU size = $8 * \text{FLOOR}((TB_{size} - N * 16 - 8 * \text{CIEL}[(16 + (N-1) * 12)/8] - 64) / (8 * N))$ bits.

Note 2: According to TS 36.213 Table 7.1.7.2.1-1 and the final PDCP SDU size formula in Note 1, the smallest TB_{size} that can be tested is 104 bits.

Table 7.1.7.1.3.3.2-2a: Bandwidth Dependent Parameters

Max Bandwidth	Max N_{PRB}
10 Mhz	50
15 Mhz	75
20 Mhz	100

Note : Maximum bandwidth for EUTRA bands is 10/15/20 Mhz.

Table 7.1.7.1.3.3.2-2b: Ambiguous Sizes of Information Bits

{12, 14, 16 ,20, 24, 26, 32, 40, 44, 56}
--

Table 7.1.7.1.3.3.2-3: Main behaviour

St	Procedure	Message Sequence		TP	Verdict
		U – S	Message		
-	EXCEPTION: Steps 1 to 4 are repeated for values of N_{PRB} from 1 to Max N_{PRB} as per table 7.1.7.1.3.3.2-2a and I_{MCS} from 0 to 28.	-	-	-	-
1	SS looks up I_{TBS} in table 7.1.7.1-1 in TS 36.213 based on the value of I_{MCS} . SS looks up TB_{size} in table 7.1.7.2.1-1 in TS 36.213 based on values of N_{PRB} and I_{TBS} .	-	-	-	-
-	EXCEPTION: Steps 2 to 4 are performed if TB_{size} is less than or equal to UE capability “Maximum number of DL-SCH transport block bits received within a TTI” as specified in Table 7.1.7.1.3.3.2-1 and larger than or equal to 104 bits as specified in Table 7.1.7.1.3.3.2-2, and the effective channel code rate, as defined in TS 36.213 clause 7.1.7, is lower than or equal to 0.930.	-	-	-	-
2	SS creates one or more PDCP SDUs, depending on TB_{size} , in accordance with Table 7.1.7.1.3.3.2-2.	-	-	-	-
3	SS transmits the PDCP SDUs concatenated into a MAC PDU and indicates on PDCCH DCI Format 1A with RA type 2 using Localized VRB and a resource block assignment (RBA) correspondent to N_{PRB} as specified in 7.1.6.3 in TS 36.213 and modulation and coding scheme I_{MCS} . If the number of information bits in format 1A is less than that of format 0, zeros shall be appended by the SS to format 1A until the payload size equals that of format	<--	MAC PDU (NxPDCP SDUs) DCI: (DCI Format 1A, RA type 2, Localized/Distributed VRB assignment flag =‘0’, RBA(N_{PRB}), I_{MCS})	-	-

	0. If the number of information bits in format 1A belongs to one of the sizes in Table 7.1.7.1.3.3.2-2b, one zero bit shall be appended by the SS to format 1A.				
3A	At the reception of scheduling request the SS transmits UL Grant for transmitting loop back PDCP SDUs.	<--	(UL Grant)	-	-
4	CHECK: Does UE return the same number of PDCP SDUs with same content as transmitted by the SS in step 3?	-->	(NxPDCP SDUs)	1	P

7.1.7.1.3.3.3 Specific Message Contents

Table 7.1.7.1.3.3.3.1: MAC-MainConfig-RBC (preamble Table 4.5.3.3-1 [18]: Step 8)

Derivation Path: 36.508 Table 4.8.2.1.5-1			
Information Element	Value/remark	Comment	Condition
retxBSR-Timer	sf320		

Table 7.1.7.1.3.3.3-2: UECapabilityInformation (Preamble Table 4.5.2.3-1 [18]: Step 13)

Derivation Path: 36.508 table 4.6.1-23			
Information Element	Value/remark	Comment	Condition
UECapabilityInformation ::= SEQUENCE {			
criticalExtensions CHOICE {			
c1 CHOICE{			
ueCapabilityInformation-r8 SEQUENCE {			
ue-CapabilityRAT-ContainerList SEQUENCE (SIZE (1..maxRAT-Capabilities)) OF SEQUENCE {	1 entry		
ueCapabilityRAT-Container			
ue-EUTRA-Capability SEQUENCE {			
accessStratumRelease	Any allowed value		
ue-Category	Checked against UE Category indications in the PICS		
pdcp-Parameters	Any allowed value		
phyLayerParameters	Any allowed value		
rf-Parameters	Any allowed value		
measParameters	Any allowed value		
featureGroupIndicators	Any allowed value		
interRAT-Parameters	Any allowed value		
nonCriticalExtension	Any allowed value		
}			
}			
}			
}			

7.1.7.1.4 DL-SCH transport block size selection / DCI format 1A / RA type 2 / Distributed VRB

7.1.7.1.4.1 Test Purpose (TP)

(1)

with { UE in E-UTRA RRC_CONNECTED state }
ensure that {

when { UE on PDCCH receives DCI format 1A indicating Resource Allocation Type 2 with Distributed VRB, a resource block assignment correspondent to N_{PRB} physical resource blocks and a modulation and coding scheme I_{MCS} }

then { UE decodes the received transport block of size correspondent to the read N_{PRB} and I_{MCS}
and forwards it to higher layers }
 }

7.1.7.1.4.2 Conformance requirements

References: The conformance requirements covered in the current TC are specified in: TS 36.212, clauses 5.3.3.1.2 and 5.3.3.1.3; TS 36.213, clauses 7.1.6.3, 7.1.7, 7.1.7.1, 7.1.7.2 and 7.1.7.2.1; and TS 36.306 clause 4.1.

[TS 36.212 clause 5.3.3.1.2]

...

Table 5.3.3.1.2-1: Ambiguous Sizes of Information Bits

{12, 14, 16, 20, 24, 26, 32, 40, 44, 56}
--

[TS 36.212 clause 5.3.3.1.3]

DCI format 1A is used for the compact scheduling of one PDSCH codeword and random access procedure initiated by a PDCCH order.

The following information is transmitted by means of the DCI format 1A:

- Flag for format0/format1A differentiation – 1 bit, where value 0 indicates format 0 and value 1 indicates format 1A

...

Otherwise,

- Localized/Distributed VRB assignment flag – 1 bit as defined in 7.1.6.3 of [3]

- Resource block assignment – $\lceil \log_2(N_{\text{RB}}^{\text{DL}}(N_{\text{RB}}^{\text{DL}} + 1)/2) \rceil$ bits as defined in section 7.1.6.3 of [3]:

- For localized VRB:

$\lceil \log_2(N_{\text{RB}}^{\text{DL}}(N_{\text{RB}}^{\text{DL}} + 1)/2) \rceil$ bits provide the resource allocation

- For distributed VRB:

- If $N_{\text{RB}}^{\text{DL}} < 50$ or if the format 1A CRC is scrambled by RA-RNTI, P-RNTI, or SI-RNTI

- $\lceil \log_2(N_{\text{RB}}^{\text{DL}}(N_{\text{RB}}^{\text{DL}} + 1)/2) \rceil$ bits provide the resource allocation

- Else

- 1 bit, the MSB indicates the gap value, where value 0 indicates $N_{\text{gap}} = N_{\text{gap},1}$ and value 1 indicates

$N_{\text{gap}} = N_{\text{gap},2}$

- $(\lceil \log_2(N_{\text{RB}}^{\text{DL}}(N_{\text{RB}}^{\text{DL}} + 1)/2) \rceil - 1)$ bits provide the resource allocation

- Modulation and coding scheme – 5bits as defined in section 7.1.7 of [3]

If the number of information bits in format 1A is less than that of format 0, zeros shall be appended to format 1A until the payload size equals that of format 0.

If the number of information bits in format 1A belongs to one of the sizes in Table 5.3.3.1.2-1, one zero bit shall be appended to format 1A.

...

[TS 36.213 clause 7.1.6.3]

In resource allocations of type 2, the resource block assignment information indicates to a scheduled UE a set of contiguously allocated localized virtual resource blocks or distributed virtual resource blocks. In case of resource allocation signalled with PDCCH DCI format 1A, 1B or 1D, one bit flag indicates whether localized virtual resource blocks or distributed virtual resource blocks are assigned (value 0 indicates Localized and value 1 indicates Distributed VRB assignment) while distributed virtual resource blocks are always assigned in case of resource allocation signalled with PDCCH DCI format 1C. Localized VRB allocations for a UE vary from a single VRB up to a maximum number of VRBs spanning the system bandwidth. For DCI format 1A the distributed VRB allocations for a UE vary from a single VRB up to N_{VRB}^{DL} VRBs, where N_{VRB}^{DL} is defined in [3], if the DCI CRC is scrambled by P-RNTI, RA-RNTI, or SI-RNTI. With PDCCH DCI format 1B, 1D, or 1A with a CRC scrambled with C-RNTI, distributed VRB allocations for a UE vary from a single VRB up to N_{VRB}^{DL} VRBs if N_{RB}^{DL} is 6-49 and vary from a single VRB up to 16 if N_{RB}^{DL} is 50-110. With PDCCH DCI format 1C, distributed VRB allocations for a UE vary from N_{RB}^{step} VRB(s) up to $\lfloor N_{VRB}^{DL} / N_{RB}^{step} \rfloor \cdot N_{RB}^{step}$ VRBs with an increment step of N_{RB}^{step} , where N_{RB}^{step} value is determined depending on the downlink system bandwidth as shown in Table 7.1.6.3-1.

Table 7.1.6.3-1: N_{RB}^{step} values vs. Downlink System Bandwidth

System BW (N_{RB}^{DL})	N_{RB}^{step}
	DCI format 1C
6-49	2
50-110	4

For PDCCH DCI format 1A, 1B or 1D, a type 2 resource allocation field consists of a resource indication value (RIV) corresponding to a starting resource block (RB_{start}) and a length in terms of virtually contiguously allocated resource blocks L_{CRBs} . The resource indication value is defined by

if $(L_{CRBs} - 1) \leq \lfloor N_{RB}^{DL} / 2 \rfloor$ then

$$RIV = N_{RB}^{DL} (L_{CRBs} - 1) + RB_{start}$$

else

$$RIV = N_{RB}^{DL} (N_{RB}^{DL} - L_{CRBs} + 1) + (N_{RB}^{DL} - 1 - RB_{start})$$

where $L_{CRBs} \geq 1$ and shall not exceed $N_{VRB}^{DL} - RB_{start}$.

For PDCCH DCI format 1C, a type 2 resource block assignment field consists of a resource indication value (RIV) corresponding to a starting resource block ($RB_{start} = 0, N_{RB}^{step}, 2N_{RB}^{step}, \dots, (\lfloor N_{VRB}^{DL} / N_{RB}^{step} \rfloor - 1)N_{RB}^{step}$) and a length in terms of virtually contiguously allocated resource blocks ($L_{CRBs} = N_{RB}^{step}, 2N_{RB}^{step}, \dots, \lfloor N_{VRB}^{DL} / N_{RB}^{step} \rfloor \cdot N_{RB}^{step}$). The resource indication value is defined by

if $(L'_{CRBs} - 1) \leq \lfloor N'_{VRB}^{DL} / 2 \rfloor$ then

$$RIV = N'_{VRB}^{DL} (L'_{CRBs} - 1) + RB'_{start}$$

else

$$RIV = N'_{VRB}^{DL} (N'_{VRB}^{DL} - L'_{CRBs} + 1) + (N'_{VRB}^{DL} - 1 - RB'_{start})$$

where $L'_{CRBs} = L_{CRBs} / N_{RB}^{step}$, $RB'_{start} = RB_{start} / N_{RB}^{step}$ and $N'_{VRB} = \lfloor N_{VRB}^{DL} / N_{RB}^{step} \rfloor$. Here,

$L'_{CRBs} \geq 1$ and shall not exceed $N'_{VRB} - RB'_{start}$.

[TS 36.213 clause 7.1.7]

To determine the modulation order and transport block size(s) in the physical downlink shared channel, the UE shall first

- read the 5-bit “modulation and coding scheme” field (I_{MCS}) in the DCI

and second if the DCI CRC is scrambled by P-RNTI, RA-RNTI, or SI-RNTI then

...

else

- set the Table 7.1.7.2.1-1 column indicator N'_{PRB} to the total number of allocated PRBs based on the procedure defined in Section 7.1.6.

if the transport block is transmitted in DwPTS of the special subframe in frame structure type 2, then

set the Table 7.1.7.2.1-1 column indicator $N_{PRB} = \max \left\{ \left\lfloor N'_{PRB} \times 0.75 \right\rfloor, 1 \right\}$,

else, set the Table 7.1.7.2.1-1 column indicator $N_{PRB} = N'_{PRB}$.

The UE may skip decoding a transport block in an initial transmission if the effective channel code rate is higher than 0.930, where the effective channel code rate is defined as the number of downlink information bits (including CRC bits) divided by the number of physical channel bits on PDSCH. If the UE skips decoding, the physical layer indicates to higher layer that the transport block is not successfully decoded. For the special subframe configurations 0 and 5 with normal CP or configurations 0 and 4 with extended CP, shown in table 4.2-1 [3], there shall be no PDSCH transmission in DwPTS of the special subframe.

[TS 36.213 clause 7.1.7.1]

The UE shall use $Q_m = 2$ if the DCI CRC is scrambled by P-RNTI, RA-RNTI, or SI-RNTI, otherwise, the UE shall use I_{MCS} and Table 7.1.7.1-1 to determine the modulation order (Q_m) used in the physical downlink shared channel.

Table 7.1.7.1-1: Modulation and TBS index table for PDSCH

MCS Index I_{MCS}	Modulation Order Q_m	TBS Index I_{TBS}
0	2	0
1	2	1
2	2	2
3	2	3
4	2	4
5	2	5
6	2	6
7	2	7
8	2	8
9	2	9
10	4	9
11	4	10
12	4	11
13	4	12
14	4	13
15	4	14
16	4	15
17	6	15
18	6	16
19	6	17
20	6	18
21	6	19
22	6	20
23	6	21
24	6	22
25	6	23
26	6	24
27	6	25
28	6	26
29	2	reserved
30	4	
31	6	

[TS 36.213 clause 7.1.7.2]

If the DCI CRC is scrambled by P-RNTI, RA-RNTI, or SI-RNTI then

- for DCI format 1A:
 - the UE shall set the TBS index (I_{TBS}) equal to I_{MCS} and determine its TBS by the procedure in Section 7.1.7.2.1.

...

else

- for $0 \leq I_{MCS} \leq 28$, the UE shall first determine the TBS index (I_{TBS}) using I_{MCS} and Table 7.1.7.1-1 except if the transport block is disabled in DCI formats 2 and 2A as specified below. For a transport block that is not mapped to two-layer spatial multiplexing, the TBS is determined by the procedure in Section 7.1.7.2.1. For a transport block that is mapped to two-layer spatial multiplexing, the TBS is determined by the procedure in Section 7.1.7.2.2.
- for $29 \leq I_{MCS} \leq 31$, the TBS is assumed to be as determined from DCI transported in the latest PDCCH for the same transport block using $0 \leq I_{MCS} \leq 28$. If there is no latest PDCCH for the same transport block using $0 \leq I_{MCS} \leq 28$, and if the initial PDSCH for the same transport block is semi-persistently scheduled, the TBS shall be determined from the most recent semi-persistent scheduling assignment PDCCH.

- In DCI formats 2 and 2A a transport block is disabled if $I_{\text{MCS}} = 0$ and if $rv_{idx} = 1$ otherwise the transport block is enabled.

The NDI and HARQ process ID, as signalled on PDCCH, and the TBS, as determined above, shall be delivered to higher layers.

[TS 36.213 clause 7.1.7.2.1]

For $1 \leq N_{\text{PRB}} \leq 110$, the TBS is given by the $(I_{\text{TBS}}, N_{\text{PRB}})$ entry of Table 7.1.7.2.1-1.

Table 7.1.7.2.1-1: Transport block size table (dimension 27x110)

I_{TBS}	N_{PRB}									
	1	2	3	4	5	6	7	8	9	10
0	16	32	56	88	120	152	176	208	224	256
1	24	56	88	144	176	208	224	256	328	344
2	32	72	144	176	208	256	296	328	376	424
3	40	104	176	208	256	328	392	440	504	568
4	56	120	208	256	328	408	488	552	632	696
5	72	144	224	328	424	504	600	680	776	872
6	328	176	256	392	504	600	712	808	936	1032
7	104	224	328	472	584	712	840	968	1096	1224
8	120	256	392	536	680	808	968	1096	1256	1384
9	136	296	456	616	776	936	1096	1256	1416	1544
10	144	328	504	680	872	1032	1224	1384	1544	1736
11	176	376	584	776	1000	1192	1384	1608	1800	2024
12	208	440	680	904	1128	1352	1608	1800	2024	2280
13	224	488	744	1000	1256	1544	1800	2024	2280	2536
14	256	552	840	1128	1416	1736	1992	2280	2600	2856
15	280	600	904	1224	1544	1800	2152	2472	2728	3112
16	328	632	968	1288	1608	1928	2280	2600	2984	3240
17	336	696	1064	1416	1800	2152	2536	2856	3240	3624
18	376	776	1160	1544	1992	2344	2792	3112	3624	4008
19	408	840	1288	1736	2152	2600	2984	3496	3880	4264
20	440	904	1384	1864	2344	2792	3240	3752	4136	4584
21	488	1000	1480	1992	2472	2984	3496	4008	4584	4968
22	520	1064	1608	2152	2664	3240	3752	4264	4776	5352
23	552	1128	1736	2280	2856	3496	4008	4584	5160	5736
24	584	1192	1800	2408	2984	3624	4264	4968	5544	5992
25	616	1256	1864	2536	3112	3752	4392	5160	5736	6200
26	712	1480	2216	2984	3752	4392	5160	5992	6712	7480

I_{TBS}	N_{PRB}									
	11	12	13	14	15	16	17	18	19	20
0	288	328	344	376	392	424	456	488	504	536
1	376	424	456	488	520	568	600	632	680	712
2	472	520	568	616	648	696	744	776	840	872
3	616	680	744	808	872	904	968	1032	1096	1160
4	776	840	904	1000	1064	1128	1192	1288	1352	1416
5	968	1032	1128	1224	1320	1384	1480	1544	1672	1736
6	1128	1224	1352	1480	1544	1672	1736	1864	1992	2088
7	1320	1480	1608	1672	1800	1928	2088	2216	2344	2472
8	1544	1672	1800	1928	2088	2216	2344	2536	2664	2792
9	1736	1864	2024	2216	2344	2536	2664	2856	2984	3112
10	1928	2088	2280	2472	2664	2792	2984	3112	3368	3496
11	2216	2408	2600	2792	2984	3240	3496	3624	3880	4008
12	2472	2728	2984	3240	3368	3624	3880	4136	4392	4584
13	2856	3112	3368	3624	3880	4136	4392	4584	4968	5160
14	3112	3496	3752	4008	4264	4584	4968	5160	5544	5736
15	3368	3624	4008	4264	4584	4968	5160	5544	5736	6200
16	3624	3880	4264	4584	4968	5160	5544	5992	6200	6456
17	4008	4392	4776	5160	5352	5736	6200	6456	6712	7224
18	4392	4776	5160	5544	5992	6200	6712	7224	7480	7992
19	4776	5160	5544	5992	6456	6968	7224	7736	8248	8504
20	5160	5544	5992	6456	6968	7480	7992	8248	8760	9144
21	5544	5992	6456	6968	7480	7992	8504	9144	9528	9912
22	5992	6456	6968	7480	7992	8504	9144	9528	10296	10680
23	6200	6968	7480	7992	8504	9144	9912	10296	11064	11448
24	6712	7224	7992	8504	9144	9912	10296	11064	11448	12216
25	6968	7480	8248	8760	9528	10296	10680	11448	12216	12576
26	8248	8760	9528	10296	11064	11832	12576	13536	14112	14688

I_{TBS}	N_{PRB}									
	21	22	23	24	25	26	27	28	29	30
0	1120	1280	1440	1600	1760	1920	2080	2240	2400	2560
1	1440	1600	1760	1920	2080	2240	2400	2560	2720	2880
2	1760	1920	2080	2240	2400	2560	2720	2880	3040	3200
3	2080	2240	2400	2560	2720	2880	3040	3200	3360	3520
4	2400	2560	2720	2880	3040	3200	3360	3520	3680	3840
5	2720	2880	3040	3200	3360	3520	3680	3840	4000	4160
6	3040	3200	3360	3520	3680	3840	4000	4160	4320	4480
7	3360	3520	3680	3840	4000	4160	4320	4480	4640	4800
8	3680	3840	4000	4160	4320	4480	4640	4800	4960	5120
9	4000	4160	4320	4480	4640	4800	4960	5120	5280	5440
10	4320	4480	4640	4800	4960	5120	5280	5440	5600	5760
11	4640	4800	4960	5120	5280	5440	5600	5760	5920	6080
12	4960	5120	5280	5440	5600	5760	5920	6080	6240	6400
13	5280	5440	5600	5760	5920	6080	6240	6400	6560	6720
14	5600	5760	5920	6080	6240	6400	6560	6720	6880	7040
15	5920	6080	6240	6400	6560	6720	6880	7040	7200	7360
16	6240	6400	6560	6720	6880	7040	7200	7360	7520	7680
17	6560	6720	6880	7040	7200	7360	7520	7680	7840	8000
18	6880	7040	7200	7360	7520	7680	7840	8000	8160	8320
19	7200	7360	7520	7680	7840	8000	8160	8320	8480	8640
20	7520	7680	7840	8000	8160	8320	8480	8640	8800	8960
21	7840	8000	8160	8320	8480	8640	8800	8960	9120	9280
22	8160	8320	8480	8640	8800	8960	9120	9280	9440	9600
23	8480	8640	8800	8960	9120	9280	9440	9600	9760	9920
24	8800	8960	9120	9280	9440	9600	9760	9920	10080	10240
25	9120	9280	9440	9600	9760	9920	10080	10240	10400	10560
26	9440	9600	9760	9920	10080	10240	10400	10560	10720	10880

0	568	600	616	648	680	712	744	776	776	808
1	744	776	808	872	904	936	968	1000	1032	1064
2	936	968	1000	1064	1096	1160	1192	1256	1288	1320
3	1224	1256	1320	1384	1416	1480	1544	1608	1672	1736
4	1480	1544	1608	1736	1800	1864	1928	1992	2088	2152
5	1864	1928	2024	2088	2216	2280	2344	2472	2536	2664
6	2216	2280	2408	2472	2600	2728	2792	2984	2984	3112
7	2536	2664	2792	2984	3112	3240	3368	3368	3496	3624
8	2984	3112	3240	3368	3496	3624	3752	3880	4008	4264
9	3368	3496	3624	3752	4008	4136	4264	4392	4584	4776
10	3752	3880	4008	4264	4392	4584	4776	4968	5160	5352
11	4264	4392	4584	4776	4968	5352	5544	5736	5992	5992
12	4776	4968	5352	5544	5736	5992	6200	6456	6712	6712
13	5352	5736	5992	6200	6456	6712	6968	7224	7480	7736
14	5992	6200	6456	6968	7224	7480	7736	7992	8248	8504
15	6456	6712	6968	7224	7736	7992	8248	8504	8760	9144
16	6712	7224	7480	7736	7992	8504	8760	9144	9528	9912
17	7480	7992	8248	8760	9144	9528	9912	10296	10296	10680
18	8248	8760	9144	9528	9912	10296	10680	11064	11448	11832
19	9144	9528	9912	10296	10680	11064	11448	12216	12576	12960
20	9912	10296	10680	11064	11448	12216	12576	12960	13536	14112
21	10680	11064	11448	12216	12576	12960	13536	14112	14688	15264
22	11448	11832	12576	12960	13536	14112	14688	15264	15840	16416
23	12216	12576	12960	13536	14112	14688	15264	15840	16416	16992
24	12960	13536	14112	14688	15264	15840	16416	16992	17568	18336
25	13536	14112	14688	15264	15840	16416	16992	17568	18336	19080
26	15264	16416	16992	17568	18336	19080	19848	20616	21384	22152

I_{TBS}	N_{PRB}									
	31	32	33	34	35	36	37	38	39	40
0	840	872	904	936	968	1000	1032	1032	1064	1096
1	1128	1160	1192	1224	1256	1288	1352	1384	1416	1416
2	1384	1416	1480	1544	1544	1608	1672	1672	1736	1800
3	1800	1864	1928	1992	2024	2088	2152	2216	2280	2344
4	2216	2280	2344	2408	2472	2600	2664	2728	2792	2856
5	2728	2792	2856	2984	3112	3112	3240	3368	3496	3496
6	3240	3368	3496	3496	3624	3752	3880	4008	4136	4136
7	3752	3880	4008	4136	4264	4392	4584	4584	4776	4968
8	4392	4584	4584	4776	4968	4968	5160	5352	5544	5544
9	4968	5160	5160	5352	5544	5736	5736	5992	6200	6200
10	5544	5736	5736	5992	6200	6200	6456	6712	6712	6968
11	6200	6456	6712	6968	6968	7224	7480	7736	7736	7992
12	6968	7224	7480	7736	7992	8248	8504	8760	8760	9144
13	7992	8248	8504	8760	9144	9144	9528	9912	9912	10296
14	8760	9144	9528	9912	9912	10296	10680	11064	11064	11448
15	9528	9912	10296	10296	10680	11064	11448	11832	11832	12216
16	9912	10296	10680	11064	11448	11832	12216	12216	12576	12960
17	11064	11448	11832	12216	12576	12960	13536	13536	14112	14688
18	12216	12576	12960	13536	14112	14112	14688	15264	15264	15840
19	13536	13536	14112	14688	15264	15264	15840	16416	16992	16992
20	14688	14688	15264	15840	16416	16992	16992	17568	18336	18336
21	15840	15840	16416	16992	17568	18336	18336	19080	19848	19848
22	16992	16992	17568	18336	19080	19080	19848	20616	21384	21384
23	17568	18336	19080	19848	19848	20616	21384	22152	22152	22920
24	19080	19848	19848	20616	21384	22152	22920	22920	23688	24496
25	19848	20616	20616	21384	22152	22920	23688	24496	24496	25456
26	22920	23688	24496	25456	25456	26416	27376	28336	29296	29296

I_{TBS}	N_{PRB}									
	41	42	43	44	45	46	47	48	49	50
0	1128	1160	1192	1224	1256	1256	1288	1320	1352	1384
1	1480	1544	1544	1608	1608	1672	1736	1736	1800	1800
2	1800	1864	1928	1992	2024	2088	2088	2152	2216	2216
3	2408	2472	2536	2536	2600	2664	2728	2792	2856	2856
4	2984	2984	3112	3112	3240	3240	3368	3496	3496	3624

5	3624	3752	3752	3880	4008	4008	4136	4264	4392	4392
6	4264	4392	4584	4584	4776	4776	4968	4968	5160	5160
7	4968	5160	5352	5352	5544	5736	5736	5992	5992	6200
8	5736	5992	5992	6200	6200	6456	6456	6712	6968	6968
9	6456	6712	6712	6968	6968	7224	7480	7480	7736	7992
10	7224	7480	7480	7736	7992	7992	8248	8504	8504	8760
11	8248	8504	8760	8760	9144	9144	9528	9528	9912	9912
12	9528	9528	9912	9912	10296	10680	10680	11064	11064	11448
13	10680	10680	11064	11448	11448	11832	12216	12216	12576	12960
14	11832	12216	12216	12576	12960	12960	13536	13536	14112	14112
15	12576	12960	12960	13536	13536	14112	14688	14688	15264	15264
16	13536	13536	14112	14112	14688	14688	15264	15840	15840	16416
17	14688	15264	15264	15840	16416	16416	16992	17568	17568	18336
18	16416	16416	16992	17568	17568	18336	18336	19080	19080	19848
19	17568	18336	18336	19080	19080	19848	20616	20616	21384	21384
20	19080	19848	19848	20616	20616	21384	22152	22152	22920	22920
21	20616	21384	21384	22152	22920	22920	23688	24496	24496	25456
22	22152	22920	22920	23688	24496	24496	25456	25456	26416	27376
23	23688	24496	24496	25456	25456	26416	27376	27376	28336	28336
24	25456	25456	26416	26416	27376	28336	28336	29296	29296	30576
25	26416	26416	27376	28336	28336	29296	29296	30576	31704	31704
26	30576	30576	31704	32856	32856	34008	35160	35160	36696	36696

I_{TBS}	N_{PRB}									
	51	52	53	54	55	56	57	58	59	60
0	1416	1416	1480	1480	1544	1544	1608	1608	1608	1672
1	1864	1864	1928	1992	1992	2024	2088	2088	2152	2152
2	2280	2344	2344	2408	2472	2536	2536	2600	2664	2664
3	2984	2984	3112	3112	3240	3240	3368	3368	3496	3496
4	3624	3752	3752	3880	4008	4008	4136	4136	4264	4264
5	4584	4584	4776	4776	4776	4968	4968	5160	5160	5352
6	5352	5352	5544	5736	5736	5992	5992	5992	6200	6200
7	6200	6456	6456	6712	6712	6712	6968	6968	7224	7224
8	7224	7224	7480	7480	7736	7736	7992	7992	8248	8504
9	7992	8248	8248	8504	8760	8760	9144	9144	9144	9528
10	9144	9144	9144	9528	9528	9912	9912	10296	10296	10680
11	10296	10680	10680	11064	11064	11448	11448	11832	11832	12216
12	11832	11832	12216	12216	12576	12576	12960	12960	13536	13536
13	12960	13536	13536	14112	14112	14688	14688	14688	15264	15264
14	14688	14688	15264	15264	15840	15840	16416	16416	16992	16992
15	15840	15840	16416	16416	16992	16992	17568	17568	18336	18336
16	16416	16992	16992	17568	17568	18336	18336	19080	19080	19848
17	18336	19080	19080	19848	19848	20616	20616	20616	21384	21384
18	19848	20616	21384	21384	22152	22152	22920	22920	23688	23688
19	22152	22152	22920	22920	23688	24496	24496	25456	25456	25456
20	23688	24496	24496	25456	25456	26416	26416	27376	27376	28336
21	25456	26416	26416	27376	27376	28336	28336	29296	29296	30576
22	27376	28336	28336	29296	29296	30576	30576	31704	31704	32856
23	29296	29296	30576	30576	31704	31704	32856	32856	34008	34008
24	31704	31704	32856	32856	34008	34008	35160	35160	36696	36696
25	32856	32856	34008	34008	35160	35160	36696	36696	37888	37888
26	37888	37888	39232	40576	40576	40576	42368	42368	43816	43816

I_{TBS}	N_{PRB}									
	61	62	63	64	65	66	67	68	69	70
0	1672	1736	1736	1800	1800	1800	1864	1864	1928	1928
1	2216	2280	2280	2344	2344	2408	2472	2472	2536	2536
2	2728	2792	2856	2856	2856	2984	2984	3112	3112	3112
3	3624	3624	3624	3752	3752	3880	3880	4008	4008	4136
4	4392	4392	4584	4584	4584	4776	4776	4968	4968	4968
5	5352	5544	5544	5736	5736	5736	5992	5992	5992	6200
6	6456	6456	6456	6712	6712	6968	6968	6968	7224	7224
7	7480	7480	7736	7736	7992	7992	8248	8248	8504	8504
8	8504	8760	8760	9144	9144	9144	9528	9528	9528	9912
9	9528	9912	9912	10296	10296	10296	10680	10680	11064	11064

10	10680	11064	11064	11448	11448	11448	11832	11832	12216	12216
11	12216	12576	12576	12960	12960	13536	13536	13536	14112	14112
12	14112	14112	14112	14688	14688	15264	15264	15264	15840	15840
13	15840	15840	16416	16416	16992	16992	16992	17568	17568	18336
14	17568	17568	18336	18336	18336	19080	19080	19848	19848	19848
15	18336	19080	19080	19848	19848	20616	20616	20616	21384	21384
16	19848	19848	20616	20616	21384	21384	22152	22152	22152	22920
17	22152	22152	22920	22920	23688	23688	24496	24496	24496	25456
18	24496	24496	24496	25456	25456	26416	26416	27376	27376	27376
19	26416	26416	27376	27376	28336	28336	29296	29296	29296	30576
20	28336	29296	29296	29296	30576	30576	31704	31704	31704	32856
21	30576	31704	31704	31704	32856	32856	34008	34008	35160	35160
22	32856	34008	34008	34008	35160	35160	36696	36696	36696	37888
23	35160	35160	36696	36696	37888	37888	37888	39232	39232	40576
24	36696	37888	37888	39232	39232	40576	40576	42368	42368	42368
25	39232	39232	40576	40576	40576	42368	42368	43816	43816	43816
26	45352	45352	46888	46888	48936	48936	48936	51024	51024	52752

I_{TBS}	N_{PRB}									
	71	72	73	74	75	76	77	78	79	80
0	1992	1992	2024	2088	2088	2088	2152	2152	2216	2216
1	2600	2600	2664	2728	2728	2792	2792	2856	2856	2856
2	3240	3240	3240	3368	3368	3368	3496	3496	3496	3624
3	4136	4264	4264	4392	4392	4392	4584	4584	4584	4776
4	5160	5160	5160	5352	5352	5544	5544	5544	5736	5736
5	6200	6200	6456	6456	6712	6712	6712	6968	6968	6968
6	7480	7480	7736	7736	7736	7992	7992	8248	8248	8248
7	8760	8760	8760	9144	9144	9144	9528	9528	9528	9912
8	9912	9912	10296	10296	10680	10680	10680	11064	11064	11064
9	11064	11448	11448	11832	11832	11832	12216	12216	12576	12576
10	12576	12576	12960	12960	12960	13536	13536	13536	14112	14112
11	14112	14688	14688	14688	15264	15264	15840	15840	15840	16416
12	16416	16416	16416	16992	16992	17568	17568	17568	18336	18336
13	18336	18336	19080	19080	19080	19848	19848	19848	20616	20616
14	20616	20616	20616	21384	21384	22152	22152	22152	22920	22920
15	22152	22152	22152	22920	22920	23688	23688	23688	24496	24496
16	22920	23688	23688	24496	24496	24496	25456	25456	25456	26416
17	25456	26416	26416	26416	27376	27376	27376	28336	28336	29296
18	28336	28336	29296	29296	29296	30576	30576	30576	31704	31704
19	30576	30576	31704	31704	32856	32856	32856	34008	34008	34008
20	32856	34008	34008	34008	35160	35160	35160	36696	36696	36696
21	35160	36696	36696	36696	37888	37888	39232	39232	39232	40576
22	37888	39232	39232	40576	40576	40576	42368	42368	42368	43816
23	40576	40576	42368	42368	43816	43816	43816	45352	45352	45352
24	43816	43816	45352	45352	45352	46888	46888	46888	48936	48936
25	45352	45352	46888	46888	46888	48936	48936	48936	51024	51024
26	52752	52752	55056	55056	55056	55056	57336	57336	57336	59256

I_{TBS}	N_{PRB}									
	81	82	83	84	85	86	87	88	89	90
0	2280	2280	2280	2344	2344	2408	2408	2472	2472	2536
1	2984	2984	2984	3112	3112	3112	3240	3240	3240	3240
2	3624	3624	3752	3752	3880	3880	3880	4008	4008	4008
3	4776	4776	4776	4968	4968	4968	5160	5160	5160	5352
4	5736	5992	5992	5992	5992	6200	6200	6200	6456	6456
5	7224	7224	7224	7480	7480	7480	7736	7736	7736	7992
6	8504	8504	8760	8760	8760	9144	9144	9144	9144	9528
7	9912	9912	10296	10296	10296	10680	10680	10680	11064	11064
8	11448	11448	11448	11832	11832	12216	12216	12216	12576	12576
9	12960	12960	12960	13536	13536	13536	13536	14112	14112	14112
10	14112	14688	14688	14688	14688	15264	15264	15264	15840	15840
11	16416	16416	16992	16992	16992	17568	17568	17568	18336	18336
12	18336	19080	19080	19080	19080	19848	19848	19848	20616	20616
13	20616	21384	21384	21384	22152	22152	22152	22920	22920	22920
14	22920	23688	23688	24496	24496	24496	25456	25456	25456	25456

15	24496	25456	25456	25456	26416	26416	26416	27376	27376	27376
16	26416	26416	27376	27376	27376	28336	28336	28336	29296	29296
17	29296	29296	30576	30576	30576	30576	31704	31704	31704	32856
18	31704	32856	32856	32856	34008	34008	34008	35160	35160	35160
19	35160	35160	35160	36696	36696	36696	37888	37888	37888	39232
20	37888	37888	39232	39232	39232	40576	40576	40576	42368	42368
21	40576	40576	42368	42368	42368	43816	43816	43816	45352	45352
22	43816	43816	45352	45352	45352	46888	46888	46888	48936	48936
23	46888	46888	46888	48936	48936	48936	51024	51024	51024	51024
24	48936	51024	51024	51024	52752	52752	52752	52752	55056	55056
25	51024	52752	52752	52752	55056	55056	55056	55056	57336	57336
26	59256	59256	61664	61664	61664	63776	63776	63776	66592	66592

I_{TBS}	N_{PRB}									
	91	92	93	94	95	96	97	98	99	100
0	2536	2536	2600	2600	2664	2664	2728	2728	2728	2792
1	3368	3368	3368	3496	3496	3496	3496	3624	3624	3624
2	4136	4136	4136	4264	4264	4264	4392	4392	4392	4584
3	5352	5352	5352	5544	5544	5544	5736	5736	5736	5736
4	6456	6456	6712	6712	6712	6968	6968	6968	6968	7224
5	7992	7992	8248	8248	8248	8504	8504	8760	8760	8760
6	9528	9528	9528	9912	9912	9912	10296	10296	10296	10296
7	11064	11448	11448	11448	11448	11832	11832	11832	12216	12216
8	12576	12960	12960	12960	13536	13536	13536	13536	14112	14112
9	14112	14688	14688	14688	15264	15264	15264	15264	15840	15840
10	15840	16416	16416	16416	16992	16992	16992	16992	17568	17568
11	18336	18336	19080	19080	19080	19080	19848	19848	19848	19848
12	20616	21384	21384	21384	21384	22152	22152	22152	22920	22920
13	23688	23688	23688	24496	24496	24496	25456	25456	25456	25456
14	26416	26416	26416	27376	27376	27376	28336	28336	28336	28336
15	28336	28336	28336	29296	29296	29296	29296	30576	30576	30576
16	29296	30576	30576	30576	30576	31704	31704	31704	31704	32856
17	32856	32856	34008	34008	34008	35160	35160	35160	35160	36696
18	36696	36696	36696	37888	37888	37888	37888	39232	39232	39232
19	39232	39232	40576	40576	40576	40576	42368	42368	42368	43816
20	42368	42368	43816	43816	43816	45352	45352	45352	46888	46888
21	45352	46888	46888	46888	46888	48936	48936	48936	48936	51024
22	48936	48936	51024	51024	51024	51024	52752	52752	52752	55056
23	52752	52752	52752	55056	55056	55056	55056	57336	57336	57336
24	55056	57336	57336	57336	57336	59256	59256	59256	61664	61664
25	57336	59256	59256	59256	61664	61664	61664	61664	63776	63776
26	66592	68808	68808	68808	71112	71112	71112	73712	73712	75376

I_{TBS}	N_{PRB}									
	101	102	103	104	105	106	107	108	109	110
0	2792	2856	2856	2856	2984	2984	2984	2984	2984	3112
1	3752	3752	3752	3752	3880	3880	3880	4008	4008	4008
2	4584	4584	4584	4584	4776	4776	4776	4776	4968	4968
3	5992	5992	5992	5992	6200	6200	6200	6200	6456	6456
4	7224	7224	7480	7480	7480	7480	7736	7736	7736	7992
5	8760	9144	9144	9144	9144	9528	9528	9528	9528	9528
6	10680	10680	10680	10680	11064	11064	11064	11448	11448	11448
7	12216	12576	12576	12576	12960	12960	12960	12960	13536	13536
8	14112	14112	14688	14688	14688	14688	15264	15264	15264	15264
9	15840	16416	16416	16416	16416	16992	16992	16992	16992	17568
10	17568	18336	18336	18336	18336	18336	19080	19080	19080	19080
11	20616	20616	20616	21384	21384	21384	21384	22152	22152	22152
12	22920	23688	23688	23688	23688	24496	24496	24496	24496	25456
13	26416	26416	26416	26416	27376	27376	27376	27376	28336	28336
14	29296	29296	29296	29296	30576	30576	30576	30576	31704	31704
15	30576	31704	31704	31704	31704	32856	32856	32856	34008	34008
16	32856	32856	34008	34008	34008	34008	35160	35160	35160	35160
17	36696	36696	36696	37888	37888	37888	39232	39232	39232	39232
18	40576	40576	40576	40576	42368	42368	42368	42368	43816	43816
19	43816	43816	43816	45352	45352	45352	46888	46888	46888	46888

20	46888	46888	48936	48936	48936	48936	48936	51024	51024	51024
21	51024	51024	51024	52752	52752	52752	52752	55056	55056	55056
22	55056	55056	55056	57336	57336	57336	57336	59256	59256	59256
23	57336	59256	59256	59256	59256	61664	61664	61664	61664	63776
24	61664	61664	63776	63776	63776	63776	66592	66592	66592	66592
25	63776	63776	66592	66592	66592	66592	68808	68808	68808	71112
26	75376	75376	75376	75376	75376	75376	75376	75376	75376	75376

[TS 36.306 clause 4.1]

The field *ue-Category* defines a combined uplink and downlink capability. The parameters set by the UE Category are defined in subclause 4.2. Tables 4.1-1 and 4.1-2 define the downlink and, respectively, uplink physical layer parameter values for each UE Category.

Table 4.1-1: Downlink physical layer parameter values set by the field *ue-Category*

UE Category	Maximum number of DL-SCH transport block bits received within a TTI	Maximum number of bits of a DL-SCH transport block received within a TTI	Total number of soft channel bits	Maximum number of supported layers for spatial multiplexing in DL
Category 1	10296	10296	250368	1
Category 2	51024	51024	1237248	2
Category 3	102048	75376	1237248	2
Category 4	150752	75376	1827072	2
Category 5	299552	149776	3667200	4

Table 4.1-2: Uplink physical layer parameter values set by the field *ue-Category*

UE Category	Maximum number of bits of an UL-SCH transport block transmitted within a TTI	Support for 64QAM in UL
Category 1	5160	No
Category 2	25456	No
Category 3	51024	No
Category 4	51024	No
Category 5	75376	Yes

7.1.7.1.4.3 Test description

7.1.7.1.4.3.1 Pre-test conditions

System Simulator:

- Cell 1.
- Uplink and downlink bandwidth set to the maximum bandwidth for the E-UTRA Band under test as specified in Table 5.6.1-1 in [31] (to enable testing of N_{PRB} up to maximum value). For Band 18, Band 19 and Band 25, based on industry requirement, uplink and downlink bandwidth set to 10MHz.
- DCI format 1C shall be used for BCCH, PCH and RAR (note).

UE:

None.

Preamble:

- The UE is in state Loopback Activated (state 4) according to [18].

NOTE: To maximize resources for DL-SCH TB size testing for DCI format 1A/RA type 2/Distributed VRB then the SS need to use DCI Format 1C for BCCH, PCH and RAR

7.1.7.1.4.3.2 Test procedure sequence

Table 7.1.7.1.4.3.2-1: Maximum TB_{size} for different UE categories

UE Category	Maximum number of bits of a DL-SCH transport block received within a TTI
Category 1	10296
Category 2	51024
Category 3	75376
Category 4	75376
Category 5	149776

Table 7.1.7.1.4.3.2-2: Number of downlink PDCP SDUs and PDCP SDU size used as test data

TB_{size} [bits]	Number of PDCP SDUs	PDCP SDU size [bits] See note 1
$104 \leq TB_{size} \leq 12096$ note 2	1	$8 * \text{FLOOR}((TB_{size} - 96)/8)$
$12097 \leq TB_{size} \leq 24128$	2	$8 * \text{FLOOR}((TB_{size} - 128)/16)$
$24129 \leq TB_{size} \leq 36152$	3	$8 * \text{FLOOR}((TB_{size} - 152)/24)$
$36153 \leq TB_{size} \leq 48184$	4	$8 * \text{FLOOR}((TB_{size} - 184)/32)$
$48185 \leq TB_{size} \leq 60208$	5	$8 * \text{FLOOR}((TB_{size} - 208)/40)$
$60209 \leq TB_{size} \leq 72240$	6	$8 * \text{FLOOR}((TB_{size} - 240)/48)$
$TB_{size} > 72240$	7	$8 * \text{FLOOR}((TB_{size} - 264)/56)$

Note 1: Each PDCP SDU is limited to 1500 octets (to keep below maximum SDU size of ESM as specified in TS 24.301 clause 9.9.4.12).

The PDCP SDU size of each PDCP SDU is

$$\text{PDCP SDU size} = (TB_{size} - N * \text{PDCP header size} - \text{AMD PDU header size} - \text{MAC header size} - \text{Size of Timing Advance} - \text{RLC Status PDU size}) / N, \text{ where}$$

PDCP header size is 16 bits for the RLC AM and 12-bit SN case;
AMD PDU header size is $\text{CIEL}[(16 + (N-1) * 12)/8]$ bytes which includes 16 standard AM header and (N-1) Length indicators; and

MAC header size = 40 bits as MAC header can be

R/R/E/LCID MAC subheader (8 bits for Timing Advance) + R/R/E/LCID MAC subheader (16 bits for MAC SDU for RLC Status PDU) + R/R/E/LCID MAC subheader (8 bits for MAC SDU for AMD PDU) = 8 + 16 + 8 bits = 32 bits
OR
R/R/E/LCID MAC subheader (8 bits for Timing Advance) + R/R/E/LCID MAC subheader (24 bits for MAC SDU for AMD PDU, Note: Length can be 2 bytes depending on the size of AMD PDU) + R/R/E/LCID MAC subheader (8 bits for MAC SDU for RLC Status PDU) = 8 + 24 + 8 bits = 40 bits

Therefore maximum MAC header size can be 40 bits
Size of Timing Advance MAC CE is 8 bits (if no Timing Advance and/or RLC status needs to be sent, padding will occur instead)
RLC Status PDU size = 16 bits

This gives:

$$\text{PDCP SDU size} = 8 * \text{FLOOR}((TB_{size} - N * 16 - 8 * \text{CIEL}[(16 + (N-1) * 12)/8] - 64) / (8 * N)) \text{ bits.}$$

Note 2: According to TS 36.213 Table 7.1.7.2.1-1 and the final PDCP SDU size formula in Note 1, the smallest TB_{size} that can be tested is 104 bits.

Table 7.1.7.1.4.3.2-2a: Bandwidth Dependent Parameters

Max Bandwidth	Max N_{PRB}	MAX VRB
10 Mhz	50	16
15 Mhz	75	16
20 Mhz	100	16

Note : Maximum bandwidth for EUTRA bands is 10/15/20 Mhz.

Table 7.1.7.1.4.3.2-2b: Ambiguous Sizes of Information Bits

{12, 14, 16 ,20, 24, 26, 32, 40, 44, 56}
--

Table 7.1.7.1.4.3.2-3: Main behaviour

St	Procedure	Message Sequence		TP	Verdict
		U – S	Message		
-	EXCEPTION: Steps 1 to 4 are repeated for values of N_{PRB} from 1 to 16[MAX VRB] and I_{MCS} from 0 to 28.	-	-	-	-
1	SS looks up I_{TBS} in table 7.1.7.1-1 in TS 36.213 based on the value of I_{MCS} . SS looks up TB_{size} in table 7.1.7.2.1-1 in TS 36.213 based on values of N_{PRB} and I_{TBS} .	-	-	-	-
-	EXCEPTION: Steps 2 to 4 are performed if TB_{size} is less than or equal to UE capability "Maximum number of DL-SCH transport block bits received within a TTI" as specified in Table 7.1.7.1.4.3.2-1 and larger than or equal to 104 bits as specified in Table 7.1.7.1.4.3.2-2, and the effective channel code rate, as defined in TS 36.213 clause 7.1.7 is lower than or equal to 0.930.	-	-	-	-
2	SS creates one or more PDCP SDUs, depending on TB_{size} , in accordance with Table 7.1.7.1.4.3.2-2.	-	-	-	-
3	SS transmits the PDCP SDUs concatenated into a MAC PDU and indicates on PDCCH DCI Format 1A with RA type 2 using Distributed VRB and a resource block assignment (RBA) correspondent to N_{PRB} as specified in 7.1.6.3 in TS 36.213 and modulation and coding scheme I_{MCS} . If the number of information bits in format 1A is less than that of format 0, zeros shall be appended by the SS to format 1A until the payload size equals that of format 0.	<--	MAC PDU (NxPDCP SDUs) DCI: (DCI Format 1A, RA type 2, Localized/Distributed VRB assignment flag = '1', RBA(N_{PRB}), I_{MCS})	-	-

	If the number of information bits in format 1A belongs to one of the sizes in Table 7.1.7.1.4.3.2-2b, one zero bit shall be appended by the SS to format 1A.				
3A	At the reception of scheduling request the SS transmits UL Grant for transmitting loop back PDCP SDUs.	<--	(UL Grant)	-	-
4	CHECK: Does UE return the same number of PDCP SDUs with same content as transmitted by the SS in step 3?	-->	(NxPDCP SDUs)	1	P

7.1.7.1.4.3.3 Specific Message Contents

Table 7.1.7.1.4.3.3.1: MAC-MainConfig-RBC (preamble Table 4.5.3.3-1 [18]: Step 8)

Derivation Path: 36.508 Table 4.8.2.1.5-1			
Information Element	Value/remark	Comment	Condition
retxBSR-Timer	sf320		

Table 7.1.7.1.4.3.3-2: UECapabilityInformation (Preamble Table 4.5.2.3-1 [18]: Step 13)

Derivation Path: 36.508 table 4.6.1-23			
Information Element	Value/remark	Comment	Condition
UECapabilityInformation ::= SEQUENCE {			
criticalExtensions CHOICE {			
c1 CHOICE{			
ueCapabilityInformation-r8 SEQUENCE {			
ue-CapabilityRAT-ContainerList SEQUENCE	1 entry		
(SIZE (1..maxRAT-Capabilities)) OF SEQUENCE {			
ueCapabilityRAT-Container			
ue-EUTRA-Capability SEQUENCE {			
ue-Category	Checked against UE Category indications in the PICS		
}			
}			
}			
}			
}			

7.1.7.1.5 DL-SCH transport block size selection / DCI format 2A / RA type 0 / Two transport blocks enabled / Transport block to codeword swap flag value set to '0'

7.1.7.1.5.1 Test Purpose (TP)

(1)

```

with { UE in E-UTRA RRC_CONNECTED state }
ensure that {
  when { UE has two transport blocks enabled and on PDCCH receives DCI format 2A indicating Resource Allocation Type 0, a resource block assignment correspondent to  $N_{PRB}$  physical resource blocks, the Transport block to codeword swap flag value set to '0' and a modulation and coding scheme  $I_{MCS}$  for two transport blocks }
  then { UE decodes the received transport blocks of sizes correspondent to the read  $N_{PRB}$  and  $I_{MCS}$  for transport block 1 and  $I_{MCS}$  for transport block 2 and forwards it to higher layers }
}

```

7.1.7.1.5.2 Conformance requirements

References: The conformance requirements covered in the current TC are specified in: TS 36.212, clauses 5.3.3.1.2, 5.3.3.1.5 and 5.3.3.1.5A; TS 36.213, clauses 7.1.6.1, 7.1.7, 7.1.7.1, 7.1.7.2 and 7.1.7.2.1; and TS 36.306 clause 4.1.

[TS 36.212 clause 5.3.3.1.2]

...

Table 5.3.3.1.2-1: Ambiguous Sizes of Information Bits

{12, 14, 16, 20, 24, 26, 32, 40, 44, 56}
--

[TS 36.212 clause 5.3.3.1.5]

Table 5.3.3.1.5-1: Transport block to codeword mapping (two transport blocks enabled)

transport block to codeword swap flag value	codeword 0 (enabled)	codeword 1 (enabled)
0	transport block 1	transport block 2
1	transport block 2	transport block 1

Table 5.3.3.1.5-2: Transport block to codeword mapping (one transport block enabled)

Transport block 1	transport block 2	codeword 0 (enabled)	codeword 1 (disabled)
enabled	disabled	transport block 1	-
disabled	enabled	transport block 2	-

[TS 36.212 clause 5.3.3.1.5A]

The following information is transmitted by means of the DCI format 2A:

- Resource allocation header (resource allocation type 0 / type 1) – 1 bit as defined in section 7.1.6 of [3]

If downlink bandwidth is less than or equal to 10 PRBs, there is no resource allocation header and resource allocation type 0 is assumed.

- Resource block assignment:

- For resource allocation type 0 as defined in section 7.1.6.1 of [3]

- $\lceil N_{RB}^{DL} / P \rceil$ bits provide the resource allocation

...

where the value of P depends on the number of DL resource blocks as indicated in subclause [7.1.6.1] of [3]

...

- Transport block to codeword swap flag – 1 bit

In addition, for transport block 1:

- Modulation and coding scheme – 5 bits as defined in section 7.1.7 of [3]
- New data indicator – 1 bit
- Redundancy version – 2 bits

In addition, for transport block 2:

- Modulation and coding scheme – 5 bits as defined in section 7.1.7 of [3]
- New data indicator – 1 bit
- Redundancy version – 2 bits

...

Precoding information – number of bits as specified in Table 5.3.3.1.5A-1

If both transport blocks are enabled, the transport block to codeword mapping is specified according to Table 5.3.3.1.5-1.

In case one of the transport blocks is disabled, the transport block to codeword swap flag is reserved and the transport block to codeword mapping is specified according to Table 5.3.3.1.5-2.

The precoding information field is defined according to Table 5.3.3.1.5A-2. For a single enabled codeword, index 1 in Table 5.3.3.1.5A-2 is only supported for retransmission of the corresponding transport block if that transport block has previously been transmitted using two layers with open-loop spatial multiplexing.

For transmission with 2 antenna ports, the precoding information field is not present. The number of transmission layers is equal to 2 if both codewords are enabled; transmit diversity is used if codeword 0 is enabled while codeword 1 is disabled.

If the number of information bits in format 2A belongs to one of the sizes in Table 5.3.3.1.2-1, one zero bit shall be appended to format 2A.

Table 5.3.3.1.5A-1: Number of bits for precoding information

Number of antenna ports at eNodeB	Number of bits for precoding information
2	0
4	2

Table 5.3.3.1.5A-2: Content of precoding information field for 4 antenna ports

One codeword: Codeword 0 enabled, Codeword 1 disabled		Two codewords: Codeword 0 enabled, Codeword 1 enabled	
Bit field mapped to index	Message	Bit field mapped to index	Message
0	4 layers: Transmit diversity	0	2 layers: precoder cycling with large delay CDD
1	2 layers: precoder cycling with large delay CDD	1	3 layers: precoder cycling with large delay CDD
2	reserved	2	4 layers: precoder cycling with large delay CDD
3	reserved	3	reserved

[TS 36.213 clause 7.1.6.1]

In resource allocations of type 0, resource block assignment information includes a bitmap indicating the resource block groups (RBGs) that are allocated to the scheduled UE where a RBG is a set of consecutive physical resource blocks (PRBs). Resource block group size (P) is a function of the system bandwidth as shown in Table 7.1.6.1-1. The total number of RBGs (N_{RBG}) for downlink system bandwidth of N_{RB}^{DL} PRBs is given by $N_{RBG} = \lceil N_{RB}^{DL} / P \rceil$ where

$\lfloor N_{RB}^{DL} / P \rfloor$ of the RBGs are of size P and if $N_{RB}^{DL} \bmod P > 0$ then one of the RBGs is of size $N_{RB}^{DL} - P \cdot \lfloor N_{RB}^{DL} / P \rfloor$. The bitmap is of size N_{RBG} bits with one bitmap bit per RBG such that each RBG is addressable. The RBGs shall be indexed in the order of increasing frequency and non-increasing RBG sizes starting at the lowest frequency. The order of RBG to bitmap bit mapping is in such way that RBG 0 to RBG $N_{RBG} - 1$ are mapped to MSB to LSB of the bitmap. The RBG is allocated to the UE if the corresponding bit value in the bitmap is 1, the RBG is not allocated to the UE otherwise.

Table 7.1.6.1-1: Type 0 Resource Allocation RBG Size vs. Downlink System Bandwidth

System Bandwidth N_{RB}^{DL}	RBG Size (P)
≤ 10	1
11 – 26	2
27 – 63	3
64 – 110	4

[TS 36.213 clause 7.1.7]

To determine the modulation order and transport block size(s) in the physical downlink shared channel, the UE shall first

- read the 5-bit “modulation and coding scheme” field (I_{MCS}) in the DCI

and second if the DCI CRC is scrambled by P-RNTI, RA-RNTI, or SI-RNTI then

...

else

- set the Table 7.1.7.2.1-1 column indicator N'_{PRB} to the total number of allocated PRBs based on the procedure defined in Section 7.1.6.

if the transport block is transmitted in DwPTS of the special subframe in frame structure type 2, then

$$\text{set the Table 7.1.7.2.1-1 column indicator } N_{PRB} = \max \left\{ \left\lfloor N'_{PRB} \times 0.75 \right\rfloor, 1 \right\},$$

else, set the Table 7.1.7.2.1-1 column indicator $N_{PRB} = N'_{PRB}$.

The UE may skip decoding a transport block in an initial transmission if the effective channel code rate is higher than 0.930, where the effective channel code rate is defined as the number of downlink information bits (including CRC bits) divided by the number of physical channel bits on PDSCH. If the UE skips decoding, the physical layer indicates to higher layer that the transport block is not successfully decoded. For the special subframe configurations 0 and 5 with normal CP or configurations 0 and 4 with extended CP, shown in table 4.2-1 [3], there shall be no PDSCH transmission in DwPTS of the special subframe.

[TS 36.213 clause 7.1.7.1]

The UE shall use $Q_m = 2$ if the DCI CRC is scrambled by P-RNTI, RA-RNTI, or SI-RNTI, otherwise, the UE shall use I_{MCS} and Table 7.1.7.1-1 to determine the modulation order (Q_m) used in the physical downlink shared channel.

Table 7.1.7.1-1: Modulation and TBS index table for PDSCH

MCS Index I_{MCS}	Modulation Order Q_m	TBS Index I_{TBS}
0	2	0
1	2	1
2	2	2
3	2	3
4	2	4
5	2	5
6	2	6
7	2	7
8	2	8
9	2	9
10	4	9
11	4	10
12	4	11
13	4	12
14	4	13
15	4	14
16	4	15
17	6	15
18	6	16
19	6	17
20	6	18
21	6	19
22	6	20
23	6	21
24	6	22
25	6	23
26	6	24
27	6	25
28	6	26
29	2	reserved
30	4	
31	6	

[TS 36.213 clause 7.1.7.2]

If the DCI CRC is scrambled by P-RNTI, RA-RNTI, or SI-RNTI then

- for DCI format 1A:
 - the UE shall set the TBS index (I_{TBS}) equal to I_{MCS} and determine its TBS by the procedure in Section 7.1.7.2.1.

...

else

- for $0 \leq I_{MCS} \leq 28$, the UE shall first determine the TBS index (I_{TBS}) using I_{MCS} and Table 7.1.7.1-1 except if the transport block is disabled in DCI formats 2 and 2A as specified below. For a transport block that is not mapped to two-layer spatial multiplexing, the TBS is determined by the procedure in Section 7.1.7.2.1. For a transport block that is mapped to two-layer spatial multiplexing, the TBS is determined by the procedure in Section 7.1.7.2.2.
- for $29 \leq I_{MCS} \leq 31$, the TBS is assumed to be as determined from DCI transported in the latest PDCCH for the same transport block using $0 \leq I_{MCS} \leq 28$. If there is no latest PDCCH for the same transport block using $0 \leq I_{MCS} \leq 28$, and if the initial PDSCH for the same transport block is semi-persistently scheduled, the TBS shall be determined from the most recent semi-persistent scheduling assignment PDCCH.

- In DCI formats 2 and 2A a transport block is disabled if $I_{\text{MCS}} = 0$ and if $rv_{idx} = 1$ otherwise the transport block is enabled.

The NDI and HARQ process ID, as signalled on PDCCH, and the TBS, as determined above, shall be delivered to higher layers.

[TS 36.213 clause 7.1.7.2.1]

For $1 \leq N_{\text{PRB}} \leq 110$, the TBS is given by the $(I_{\text{TBS}}, N_{\text{PRB}})$ entry of Table 7.1.7.2.1-1.

Table 7.1.7.2.1-1: Transport block size table (dimension 27x110)

I_{TBS}	N_{PRB}									
	1	2	3	4	5	6	7	8	9	10
0	16	32	56	88	120	152	176	208	224	256
1	24	56	88	144	176	208	224	256	328	344
2	32	72	144	176	208	256	296	328	376	424
3	40	104	176	208	256	328	392	440	504	568
4	56	120	208	256	328	408	488	552	632	696
5	72	144	224	328	424	504	600	680	776	872
6	328	176	256	392	504	600	712	808	936	1032
7	104	224	328	472	584	712	840	968	1096	1224
8	120	256	392	536	680	808	968	1096	1256	1384
9	136	296	456	616	776	936	1096	1256	1416	1544
10	144	328	504	680	872	1032	1224	1384	1544	1736
11	176	376	584	776	1000	1192	1384	1608	1800	2024
12	208	440	680	904	1128	1352	1608	1800	2024	2280
13	224	488	744	1000	1256	1544	1800	2024	2280	2536
14	256	552	840	1128	1416	1736	1992	2280	2600	2856
15	280	600	904	1224	1544	1800	2152	2472	2728	3112
16	328	632	968	1288	1608	1928	2280	2600	2984	3240
17	336	696	1064	1416	1800	2152	2536	2856	3240	3624
18	376	776	1160	1544	1992	2344	2792	3112	3624	4008
19	408	840	1288	1736	2152	2600	2984	3496	3880	4264
20	440	904	1384	1864	2344	2792	3240	3752	4136	4584
21	488	1000	1480	1992	2472	2984	3496	4008	4584	4968
22	520	1064	1608	2152	2664	3240	3752	4264	4776	5352
23	552	1128	1736	2280	2856	3496	4008	4584	5160	5736
24	584	1192	1800	2408	2984	3624	4264	4968	5544	5992
25	616	1256	1864	2536	3112	3752	4392	5160	5736	6200
26	712	1480	2216	2984	3752	4392	5160	5992	6712	7480
I_{TBS}	N_{PRB}									
	11	12	13	14	15	16	17	18	19	20
0	288	328	344	376	392	424	456	488	504	536
1	376	424	456	488	520	568	600	632	680	712
2	472	520	568	616	648	696	744	776	840	872
3	616	680	744	808	872	904	968	1032	1096	1160
4	776	840	904	1000	1064	1128	1192	1288	1352	1416
5	968	1032	1128	1224	1320	1384	1480	1544	1672	1736
6	1128	1224	1352	1480	1544	1672	1736	1864	1992	2088
7	1320	1480	1608	1672	1800	1928	2088	2216	2344	2472
8	1544	1672	1800	1928	2088	2216	2344	2536	2664	2792
9	1736	1864	2024	2216	2344	2536	2664	2856	2984	3112
10	1928	2088	2280	2472	2664	2792	2984	3112	3368	3496
11	2216	2408	2600	2792	2984	3240	3496	3624	3880	4008
12	2472	2728	2984	3240	3368	3624	3880	4136	4392	4584
13	2856	3112	3368	3624	3880	4136	4392	4584	4968	5160
14	3112	3496	3752	4008	4264	4584	4968	5160	5544	5736
15	3368	3624	4008	4264	4584	4968	5160	5544	5736	6200
16	3624	3880	4264	4584	4968	5160	5544	5992	6200	6456
17	4008	4392	4776	5160	5352	5736	6200	6456	6712	7224
18	4392	4776	5160	5544	5992	6200	6712	7224	7480	7992
19	4776	5160	5544	5992	6456	6968	7224	7736	8248	8504
20	5160	5544	5992	6456	6968	7480	7992	8248	8760	9144
21	5544	5992	6456	6968	7480	7992	8504	9144	9528	9912
22	5992	6456	6968	7480	7992	8504	9144	9528	10296	10680
23	6200	6968	7480	7992	8504	9144	9912	10296	11064	11448
24	6712	7224	7992	8504	9144	9912	10296	11064	11448	12216
25	6968	7480	8248	8760	9528	10296	10680	11448	12216	12576
26	8248	8760	9528	10296	11064	11832	12576	13536	14112	14688
I_{TBS}	N_{PRB}									
	21	22	23	24	25	26	27	28	29	30
0	568	600	616	648	680	712	744	776	776	808
1	744	776	808	872	904	936	968	1000	1032	1064

2	936	968	1000	1064	1096	1160	1192	1256	1288	1320
3	1224	1256	1320	1384	1416	1480	1544	1608	1672	1736
4	1480	1544	1608	1736	1800	1864	1928	1992	2088	2152
5	1864	1928	2024	2088	2216	2280	2344	2472	2536	2664
6	2216	2280	2408	2472	2600	2728	2792	2984	2984	3112
7	2536	2664	2792	2984	3112	3240	3368	3368	3496	3624
8	2984	3112	3240	3368	3496	3624	3752	3880	4008	4264
9	3368	3496	3624	3752	4008	4136	4264	4392	4584	4776
10	3752	3880	4008	4264	4392	4584	4776	4968	5160	5352
11	4264	4392	4584	4776	4968	5352	5544	5736	5992	5992
12	4776	4968	5352	5544	5736	5992	6200	6456	6712	6712
13	5352	5736	5992	6200	6456	6712	6968	7224	7480	7736
14	5992	6200	6456	6968	7224	7480	7736	7992	8248	8504
15	6456	6712	6968	7224	7736	7992	8248	8504	8760	9144
16	6712	7224	7480	7736	7992	8504	8760	9144	9528	9912
17	7480	7992	8248	8760	9144	9528	9912	10296	10296	10680
18	8248	8760	9144	9528	9912	10296	10680	11064	11448	11832
19	9144	9528	9912	10296	10680	11064	11448	12216	12576	12960
20	9912	10296	10680	11064	11448	12216	12576	12960	13536	14112
21	10680	11064	11448	12216	12576	12960	13536	14112	14688	15264
22	11448	11832	12576	12960	13536	14112	14688	15264	15840	16416
23	12216	12576	12960	13536	14112	14688	15264	15840	16416	16992
24	12960	13536	14112	14688	15264	15840	16416	16992	17568	18336
25	13536	14112	14688	15264	15840	16416	16992	17568	18336	19080
26	15264	16416	16992	17568	18336	19080	19848	20616	21384	22152
I_{TBS}	N_{PRB}									
	31	32	33	34	35	36	37	38	39	40
0	840	872	904	936	968	1000	1032	1032	1064	1096
1	1128	1160	1192	1224	1256	1288	1352	1384	1416	1416
2	1384	1416	1480	1544	1544	1608	1672	1672	1736	1800
3	1800	1864	1928	1992	2024	2088	2152	2216	2280	2344
4	2216	2280	2344	2408	2472	2600	2664	2728	2792	2856
5	2728	2792	2856	2984	3112	3112	3240	3368	3496	3496
6	3240	3368	3496	3496	3624	3752	3880	4008	4136	4136
7	3752	3880	4008	4136	4264	4392	4584	4584	4776	4968
8	4392	4584	4584	4776	4968	4968	5160	5352	5544	5544
9	4968	5160	5160	5352	5544	5736	5736	5992	6200	6200
10	5544	5736	5736	5992	6200	6200	6456	6712	6712	6968
11	6200	6456	6712	6968	6968	7224	7480	7736	7736	7992
12	6968	7224	7480	7736	7992	8248	8504	8760	8760	9144
13	7992	8248	8504	8760	9144	9144	9528	9912	9912	10296
14	8760	9144	9528	9912	9912	10296	10680	11064	11064	11448
15	9528	9912	10296	10296	10680	11064	11448	11832	11832	12216
16	9912	10296	10680	11064	11448	11832	12216	12216	12576	12960
17	11064	11448	11832	12216	12576	12960	13536	13536	14112	14688
18	12216	12576	12960	13536	14112	14112	14688	15264	15264	15840
19	13536	13536	14112	14688	15264	15264	15840	16416	16992	16992
20	14688	14688	15264	15840	16416	16992	16992	17568	18336	18336
21	15840	15840	16416	16992	17568	18336	18336	19080	19848	19848
22	16992	16992	17568	18336	19080	19080	19848	20616	21384	21384
23	17568	18336	19080	19848	19848	20616	21384	22152	22152	22920
24	19080	19848	19848	20616	21384	22152	22920	22920	23688	24496
25	19848	20616	20616	21384	22152	22920	23688	24496	24496	25456
26	22920	23688	24496	25456	25456	26416	27376	28336	29296	29296
I_{TBS}	N_{PRB}									
	41	42	43	44	45	46	47	48	49	50
0	1128	1160	1192	1224	1256	1256	1288	1320	1352	1384
1	1480	1544	1544	1608	1608	1672	1736	1736	1800	1800
2	1800	1864	1928	1992	2024	2088	2088	2152	2216	2216
3	2408	2472	2536	2536	2600	2664	2728	2792	2856	2856
4	2984	2984	3112	3112	3240	3240	3368	3496	3496	3624
5	3624	3752	3752	3880	4008	4008	4136	4264	4392	4392
6	4264	4392	4584	4584	4776	4776	4968	4968	5160	5160
7	4968	5160	5352	5352	5544	5736	5736	5992	5992	6200

8	5736	5992	5992	6200	6200	6456	6456	6712	6968	6968
9	6456	6712	6712	6968	6968	7224	7480	7480	7736	7992
10	7224	7480	7480	7736	7992	7992	8248	8504	8504	8760
11	8248	8504	8760	8760	9144	9144	9528	9528	9912	9912
12	9528	9528	9912	9912	10296	10680	10680	11064	11064	11448
13	10680	10680	11064	11448	11448	11832	12216	12216	12576	12960
14	11832	12216	12216	12576	12960	12960	13536	13536	14112	14112
15	12576	12960	12960	13536	13536	14112	14688	14688	15264	15264
16	13536	13536	14112	14112	14688	14688	15264	15840	15840	16416
17	14688	15264	15264	15840	16416	16416	16992	17568	17568	18336
18	16416	16416	16992	17568	17568	18336	18336	19080	19080	19848
19	17568	18336	18336	19080	19080	19848	20616	20616	21384	21384
20	19080	19848	19848	20616	20616	21384	22152	22152	22920	22920
21	20616	21384	21384	22152	22920	22920	23688	24496	24496	25456
22	22152	22920	22920	23688	24496	24496	25456	25456	26416	27376
23	23688	24496	24496	25456	25456	26416	27376	27376	28336	28336
24	25456	25456	26416	26416	27376	28336	28336	29296	29296	30576
25	26416	26416	27376	28336	28336	29296	29296	30576	31704	31704
26	30576	30576	31704	32856	32856	34008	35160	35160	36696	36696
I_{TBS}	N_{PRB}									
	51	52	53	54	55	56	57	58	59	60
0	1416	1416	1480	1480	1544	1544	1608	1608	1608	1672
1	1864	1864	1928	1992	1992	2024	2088	2088	2152	2152
2	2280	2344	2344	2408	2472	2536	2536	2600	2664	2664
3	2984	2984	3112	3112	3240	3240	3368	3368	3496	3496
4	3624	3752	3752	3880	4008	4008	4136	4136	4264	4264
5	4584	4584	4776	4776	4776	4968	4968	5160	5160	5352
6	5352	5352	5544	5736	5736	5992	5992	5992	6200	6200
7	6200	6456	6456	6712	6712	6712	6968	6968	7224	7224
8	7224	7224	7480	7480	7736	7736	7992	7992	8248	8504
9	7992	8248	8248	8504	8760	8760	9144	9144	9144	9528
10	9144	9144	9144	9528	9528	9912	9912	10296	10296	10680
11	10296	10680	10680	11064	11064	11448	11448	11832	11832	12216
12	11832	11832	12216	12216	12576	12576	12960	12960	13536	13536
13	12960	13536	13536	14112	14112	14688	14688	14688	15264	15264
14	14688	14688	15264	15264	15840	15840	16416	16416	16992	16992
15	15840	15840	16416	16416	16992	16992	17568	17568	18336	18336
16	16416	16992	16992	17568	17568	18336	18336	19080	19080	19848
17	18336	19080	19080	19848	19848	20616	20616	20616	21384	21384
18	19848	20616	21384	21384	22152	22152	22920	22920	23688	23688
19	22152	22152	22920	22920	23688	24496	24496	25456	25456	25456
20	23688	24496	24496	25456	25456	26416	26416	27376	27376	28336
21	25456	26416	26416	27376	27376	28336	28336	29296	29296	30576
22	27376	28336	28336	29296	29296	30576	30576	31704	31704	32856
23	29296	29296	30576	30576	31704	31704	32856	32856	34008	34008
24	31704	31704	32856	32856	34008	34008	35160	35160	36696	36696
25	32856	32856	34008	34008	35160	35160	36696	36696	37888	37888
26	37888	37888	39232	40576	40576	40576	42368	42368	43816	43816
I_{TBS}	N_{PRB}									
	61	62	63	64	65	66	67	68	69	70
0	1672	1736	1736	1800	1800	1800	1864	1864	1928	1928
1	2216	2280	2280	2344	2344	2408	2472	2472	2536	2536
2	2728	2792	2856	2856	2856	2984	2984	3112	3112	3112
3	3624	3624	3624	3752	3752	3880	3880	4008	4008	4136
4	4392	4392	4584	4584	4584	4776	4776	4968	4968	4968
5	5352	5544	5544	5736	5736	5736	5992	5992	5992	6200
6	6456	6456	6456	6712	6712	6968	6968	6968	7224	7224
7	7480	7480	7736	7736	7992	7992	8248	8248	8504	8504
8	8504	8760	8760	9144	9144	9144	9528	9528	9528	9912
9	9528	9912	9912	10296	10296	10296	10680	10680	11064	11064
10	10680	11064	11064	11448	11448	11448	11832	11832	12216	12216
11	12216	12576	12576	12960	12960	13536	13536	13536	14112	14112
12	14112	14112	14112	14688	14688	15264	15264	15264	15840	15840
13	15840	15840	16416	16416	16992	16992	16992	17568	17568	18336

14	17568	17568	18336	18336	18336	19080	19080	19848	19848	19848
15	18336	19080	19080	19848	19848	20616	20616	20616	21384	21384
16	19848	19848	20616	20616	21384	21384	22152	22152	22152	22920
17	22152	22152	22920	22920	23688	23688	24496	24496	24496	25456
18	24496	24496	24496	25456	25456	26416	26416	27376	27376	27376
19	26416	26416	27376	27376	28336	28336	29296	29296	29296	30576
20	28336	29296	29296	29296	30576	30576	31704	31704	31704	32856
21	30576	31704	31704	31704	32856	32856	34008	34008	35160	35160
22	32856	34008	34008	34008	35160	35160	36696	36696	36696	37888
23	35160	35160	36696	36696	37888	37888	37888	39232	39232	40576
24	36696	37888	37888	39232	39232	40576	40576	42368	42368	42368
25	39232	39232	40576	40576	40576	42368	42368	43816	43816	43816
26	45352	45352	46888	46888	48936	48936	48936	51024	51024	52752
I_{TBS}	N_{PRB}									
	71	72	73	74	75	76	77	78	79	80
0	1992	1992	2024	2088	2088	2088	2152	2152	2216	2216
1	2600	2600	2664	2728	2728	2792	2792	2856	2856	2856
2	3240	3240	3240	3368	3368	3368	3496	3496	3496	3624
3	4136	4264	4264	4392	4392	4392	4584	4584	4584	4776
4	5160	5160	5160	5352	5352	5544	5544	5544	5736	5736
5	6200	6200	6456	6456	6712	6712	6712	6968	6968	6968
6	7480	7480	7736	7736	7736	7992	7992	8248	8248	8248
7	8760	8760	8760	9144	9144	9144	9528	9528	9528	9912
8	9912	9912	10296	10296	10680	10680	10680	11064	11064	11064
9	11064	11448	11448	11832	11832	11832	12216	12216	12576	12576
10	12576	12576	12960	12960	12960	13536	13536	13536	14112	14112
11	14112	14688	14688	14688	15264	15264	15840	15840	15840	16416
12	16416	16416	16416	16992	16992	17568	17568	17568	18336	18336
13	18336	18336	19080	19080	19080	19848	19848	19848	20616	20616
14	20616	20616	20616	21384	21384	22152	22152	22152	22920	22920
15	22152	22152	22152	22920	22920	23688	23688	23688	24496	24496
16	22920	23688	23688	24496	24496	24496	25456	25456	25456	26416
17	25456	26416	26416	26416	27376	27376	27376	28336	28336	29296
18	28336	28336	29296	29296	29296	30576	30576	30576	31704	31704
19	30576	30576	31704	31704	32856	32856	32856	34008	34008	34008
20	32856	34008	34008	34008	35160	35160	35160	36696	36696	36696
21	35160	36696	36696	36696	37888	37888	39232	39232	39232	40576
22	37888	39232	39232	40576	40576	40576	42368	42368	42368	43816
23	40576	40576	42368	42368	43816	43816	43816	45352	45352	45352
24	43816	43816	45352	45352	45352	46888	46888	46888	48936	48936
25	45352	45352	46888	46888	46888	48936	48936	48936	51024	51024
26	52752	52752	55056	55056	55056	55056	57336	57336	57336	59256
I_{TBS}	N_{PRB}									
	81	82	83	84	85	86	87	88	89	90
0	2280	2280	2280	2344	2344	2408	2408	2472	2472	2536
1	2984	2984	2984	3112	3112	3112	3240	3240	3240	3240
2	3624	3624	3752	3752	3880	3880	3880	4008	4008	4008
3	4776	4776	4776	4968	4968	4968	5160	5160	5160	5352
4	5736	5992	5992	5992	5992	6200	6200	6200	6456	6456
5	7224	7224	7224	7480	7480	7480	7736	7736	7736	7992
6	8504	8504	8760	8760	8760	9144	9144	9144	9144	9528
7	9912	9912	10296	10296	10296	10680	10680	10680	11064	11064
8	11448	11448	11448	11832	11832	12216	12216	12216	12576	12576
9	12960	12960	12960	13536	13536	13536	13536	14112	14112	14112
10	14112	14688	14688	14688	14688	15264	15264	15264	15840	15840
11	16416	16416	16992	16992	16992	17568	17568	17568	18336	18336
12	18336	19080	19080	19080	19080	19848	19848	19848	20616	20616
13	20616	21384	21384	21384	21384	22152	22152	22152	22920	22920
14	22920	23688	23688	24496	24496	24496	25456	25456	25456	25456
15	24496	25456	25456	25456	26416	26416	26416	27376	27376	27376
16	26416	26416	27376	27376	27376	28336	28336	28336	29296	29296
17	29296	29296	30576	30576	30576	30576	31704	31704	31704	32856
18	31704	32856	32856	32856	34008	34008	34008	35160	35160	35160
19	35160	35160	35160	36696	36696	36696	37888	37888	37888	39232

20	37888	37888	39232	39232	39232	40576	40576	40576	42368	42368
21	40576	40576	42368	42368	42368	43816	43816	43816	45352	45352
22	43816	43816	45352	45352	45352	46888	46888	46888	48936	48936
23	46888	46888	46888	48936	48936	48936	51024	51024	51024	51024
24	48936	51024	51024	51024	52752	52752	52752	52752	55056	55056
25	51024	52752	52752	52752	55056	55056	55056	55056	57336	57336
26	59256	59256	61664	61664	61664	63776	63776	63776	66592	66592
I_{TBS}	N_{PRB}									
	91	92	93	94	95	96	97	98	99	100
0	2536	2536	2600	2600	2664	2664	2728	2728	2728	2792
1	3368	3368	3368	3496	3496	3496	3496	3624	3624	3624
2	4136	4136	4136	4264	4264	4264	4392	4392	4392	4584
3	5352	5352	5352	5544	5544	5544	5736	5736	5736	5736
4	6456	6456	6712	6712	6712	6968	6968	6968	6968	7224
5	7992	7992	8248	8248	8248	8504	8504	8760	8760	8760
6	9528	9528	9528	9912	9912	9912	10296	10296	10296	10296
7	11064	11448	11448	11448	11448	11832	11832	11832	12216	12216
8	12576	12960	12960	12960	13536	13536	13536	13536	14112	14112
9	14112	14688	14688	14688	15264	15264	15264	15264	15840	15840
10	15840	16416	16416	16416	16992	16992	16992	16992	17568	17568
11	18336	18336	19080	19080	19080	19080	19848	19848	19848	19848
12	20616	21384	21384	21384	21384	22152	22152	22152	22920	22920
13	23688	23688	23688	24496	24496	24496	25456	25456	25456	25456
14	26416	26416	26416	27376	27376	27376	28336	28336	28336	28336
15	28336	28336	28336	29296	29296	29296	29296	30576	30576	30576
16	29296	30576	30576	30576	30576	31704	31704	31704	31704	32856
17	32856	32856	34008	34008	34008	35160	35160	35160	35160	36696
18	36696	36696	36696	37888	37888	37888	37888	39232	39232	39232
19	39232	39232	40576	40576	40576	40576	42368	42368	42368	43816
20	42368	42368	43816	43816	43816	45352	45352	45352	46888	46888
21	45352	46888	46888	46888	46888	48936	48936	48936	48936	51024
22	48936	48936	51024	51024	51024	51024	51024	52752	52752	55056
23	52752	52752	52752	55056	55056	55056	55056	57336	57336	57336
24	55056	57336	57336	57336	57336	59256	59256	59256	61664	61664
25	57336	59256	59256	59256	61664	61664	61664	61664	63776	63776
26	66592	68808	68808	68808	71112	71112	71112	73712	73712	75376
I_{TBS}	N_{PRB}									
	101	102	103	104	105	106	107	108	109	110
0	2792	2856	2856	2856	2984	2984	2984	2984	2984	3112
1	3752	3752	3752	3752	3880	3880	3880	4008	4008	4008
2	4584	4584	4584	4584	4776	4776	4776	4776	4968	4968
3	5992	5992	5992	5992	6200	6200	6200	6200	6456	6456
4	7224	7224	7480	7480	7480	7480	7736	7736	7736	7992
5	8760	9144	9144	9144	9144	9528	9528	9528	9528	9528
6	10680	10680	10680	10680	11064	11064	11064	11448	11448	11448
7	12216	12576	12576	12576	12960	12960	12960	12960	13536	13536
8	14112	14112	14688	14688	14688	14688	15264	15264	15264	15264
9	15840	16416	16416	16416	16416	16992	16992	16992	17568	17568
10	17568	18336	18336	18336	18336	18336	19080	19080	19080	19080
11	20616	20616	20616	21384	21384	21384	21384	22152	22152	22152
12	22920	23688	23688	23688	23688	24496	24496	24496	24496	25456
13	26416	26416	26416	26416	27376	27376	27376	27376	28336	28336
14	29296	29296	29296	29296	30576	30576	30576	30576	31704	31704
15	30576	31704	31704	31704	31704	32856	32856	32856	34008	34008
16	32856	32856	34008	34008	34008	34008	35160	35160	35160	35160
17	36696	36696	36696	37888	37888	37888	39232	39232	39232	39232
18	40576	40576	40576	40576	42368	42368	42368	42368	43816	43816
19	43816	43816	43816	45352	45352	45352	46888	46888	46888	46888
20	46888	46888	48936	48936	48936	48936	48936	51024	51024	51024
21	51024	51024	51024	52752	52752	52752	52752	55056	55056	55056
22	55056	55056	55056	57336	57336	57336	57336	59256	59256	59256
23	57336	59256	59256	59256	59256	61664	61664	61664	61664	63776
24	61664	61664	63776	63776	63776	63776	66592	66592	66592	66592
25	63776	63776	66592	66592	66592	66592	68808	68808	68808	71112

26	75376	75376	75376	75376	75376	75376	75376	75376	75376	75376
----	-------	-------	-------	-------	-------	-------	-------	-------	-------	-------

[TS 36.306 clause 4.1]

The field *ue-Category* defines a combined uplink and downlink capability. The parameters set by the UE Category are defined in subclause 4.2. Tables 4.1-1 and 4.1-2 define the downlink and, respectively, uplink physical layer parameter values for each UE Category.

Table 4.1-1: Downlink physical layer parameter values set by the field *ue-Category*

UE Category	Maximum number of DL-SCH transport block bits received within a TTI	Maximum number of bits of a DL-SCH transport block received within a TTI	Total number of soft channel bits	Maximum number of supported layers for spatial multiplexing in DL
Category 1	10296	10296	250368	1
Category 2	51024	51024	1237248	2
Category 3	102048	75376	1237248	2
Category 4	150752	75376	1827072	2
Category 5	299552	149776	3667200	4

Table 4.1-2: Uplink physical layer parameter values set by the field *ue-Category*

UE Category	Maximum number of bits of an UL-SCH transport block transmitted within a TTI	Support for 64QAM in UL
Category 1	5160	No
Category 2	25456	No
Category 3	51024	No
Category 4	51024	No
Category 5	75376	Yes

...

7.1.7.1.5.3 Test description

7.1.7.1.5.3.1 Pre-test conditions

System Simulator

- Cell 1.
- Uplink and downlink bandwidth set to the maximum bandwidth for the E-UTRA Band under test as specified in Table 5.6.1-1 in [31] (to enable testing of N_{PRB} up to maximum value). For Band 18, Band 19 and Band 25, based on industry requirement, uplink and downlink bandwidth set to 10MHz.

UE:

None.

Preamble

- The UE is in state Loopback Activated (state 4) according to [18] condition 2TX to configure MIMO.

7.1.7.1.5.3.2 Test procedure sequence

Table 7.1.7.1.5.3.2-1: Maximum TB_{size} for different UE categories

UE Category	Maximum number of bits of a DL-SCH transport block received within a TTI
Category 1	10296
Category 2	51024
Category 3	75376
Category 4	75376
Category 5	149776

Table 7.1.7.1.5.3.2-2: Number of downlink PDCP SDUs and PDCP SDU size used as test data for transport block 1 and transport block 2

Total TB_{size} (sum of the sizes of $TB_{size\#1}$ and $TB_{size\#2}$) (bits)	Number of PDCP SDUs	PDCP SDU size (bits) See note 1
$136 \leq TB_{size} \leq 12120$ See note 2	1	$8 * \text{FLOOR}((TB_{size} - 120)/8)$
$12121 \leq TB_{size} \leq 24152$	2	$8 * \text{FLOOR}((TB_{size} - 152)/16)$
$24153 \leq TB_{size} \leq 36176$	3	$8 * \text{FLOOR}((TB_{size} - 176)/24)$
$36177 \leq TB_{size} \leq 48208$	4	$8 * \text{FLOOR}((TB_{size} - 208)/32)$
$48209 \leq TB_{size} \leq 60232$	5	$8 * \text{FLOOR}((TB_{size} - 232)/40)$
$60233 \leq TB_{size} \leq 72264$	6	$8 * \text{FLOOR}((TB_{size} - 264)/48)$
$72265 \leq TB_{size} \leq 84288$	7	$8 * \text{FLOOR}((TB_{size} - 288)/56)$
$84289 \leq TB_{size} \leq 96320$	8	$8 * \text{FLOOR}((TB_{size} - 320)/64)$
$96321 \leq TB_{size} \leq 108348$	9	$8 * \text{FLOOR}((TB_{size} - 348)/72)$
$108349 \leq TB_{size} \leq 120376$	10	$8 * \text{FLOOR}((TB_{size} - 376)/80)$
$120377 \leq TB_{size} \leq 132400$	11	$8 * \text{FLOOR}((TB_{size} - 400)/88)$
$132401 \leq TB_{size} \leq 144432$	12	$8 * \text{FLOOR}((TB_{size} - 432)/96)$
$TB_{size} \geq 144433$	13	$8 * \text{FLOOR}((TB_{size} - 456)/104)$
<p>Note 1. Each PDCP SDU is limited to 1500 octets (to keep below maximum SDU size of ESM as specified in TS 24.301 clause 9.9.4.12).</p> <p>The PDCP SDU size of each PDCP SDU is</p> <p>PDCP SDU size = (Total TB_{size} - $N * \text{PDCP header size}$ - AMD PDU header size - MAC header size - Size of Timing Advance - RLC Status PDU size) / N, where</p> <p>PDCP header size is 16 bits for the RLC AM and 12-bit SN case;</p> <p>AMD PDU header size is $\text{CEIL}[(\text{Number of TBs} * 16 + (N-1) * 12)/8]$ bytes which includes one 16 bit standard AM header per TB and $N-1$ Length indicators of 12 bits corresponding to the worst case when one of the PDCP SDU is split between the two transport blocks. If no PDCP SDU is split between the transport blocks then there will be only $N-2$ LIs and MAC padding will occur instead of one LI;</p> <p>MAC header size = R/R/E/LCID MAC subheader (8 bits for Timing Advance) + R/R/E/LCID MAC subheader (24 bits for MAC SDU for RLC data PDU) + Number of TBs R/R/E/LCID MAC subheaders (8 bits for MAC SDU for RLC status PDU) = $8 + 24 + \text{Number of TBs} * 8$ bits; If status PDU is not included or, MAC LI is included for MAC SDU for RLC status PDU instead of RLC data PDU, MAC padding will occur in place of unused bits</p> <p>Size of Timing Advance MAC CE is 8 bits (if no Timing Advance needs to be sent, padding will occur instead);</p> <p>RLC Status PDU size = 16 bits (including one ACK SQN triggered in execution $X+1$, due to loop back transmission in execution X and as all loop backed PDUs in execution X have been correctly received, the status PDU will carry an ACK SQN only.</p>		

This gives:

PDCP SDU size = $8 \cdot \text{FLOOR}((\text{Total TBSize} - N \cdot 16 - 8 \cdot \text{CEIL}((2 \cdot 16 + (N-1) \cdot 12) / 8) - 72) / (8 \cdot N))$ bits

Note 2: According to TS 36.213 Table 7.1.7.2.1-1 and the final PDCP SDU size formula in Note 1, the smallest total TBSize that can be tested (corresponding to $N=1$, and PDCP SDU size of 16) is 136 bits.

Table 7.1.7.1.5.3.2-2a: Bandwidth Dependent Parameters

Max Bandwidth	Max N_{PRB}	Allowed N_{PRB} Values
10 Mhz	50	2, 3, 5, 6, 8, 9, 11, 12, 14, 15, 17, 18, 20, 21, 23, 24, 26, 27, 29, 30, 32, 33, 35, 36, 38, 39, 41, 42, 44, 45, 47, 48, 50
15 Mhz	75	3, 4, 7, 8, 11, 12, 15, 16, 19, 20, 23, 24, 27, 28, 31, 32, 35, 36, 39, 40, 43, 44, 47, 48, 51, 52, 55, 56, 59, 60, 63, 64, 67, 68, 71, 72, 75
20 Mhz	100	4, 8, 12, 16, 20, 24, 28, 32, 36, 40, 44, 48, 52, 56, 60, 64, 68, 72, 76, 80, 84, 88, 92, 96, 100

Note : Maximum bandwidth for EUTRA bands is 10/15/20 Mhz.

Table 7.1.7.1.5.3.2-2b: Ambiguous Sizes of Information Bits

{12, 14, 16, 20, 24, 26, 32, 40, 44, 56}

Table 7.1.7.1.5.3.2-3: Main behaviour

St	Procedure	Message Sequence		TP	Verdict
		U – S	Message		
-	EXCEPTION: Steps 1 to 4 are repeated for allowed values of N_{PRB} as per table 7.1.7.1.5.3.2-2a and for each I_{MCS} from 0 to 28	-	-	-	-
1	SS looks up I_{TBS} in table 7.1.7.1-1 in TS 36.213 based on the value of I_{MCS} . SS looks up TB_{size} in table 7.1.7.2.1-1 in TS 36.213 based on values of N_{PRB} and I_{TBS} . The SS uses the same I_{MCS} and TB_{size} for both transport blocks: $I_{\text{MCS}\#1} = I_{\text{MCS}\#2} = I_{\text{MCS}}$ $\text{TB}_{\text{size}\#1} = \text{TB}_{\text{size}\#2} = \text{TB}_{\text{size}}$	-	-	-	-
-	EXCEPTION: Steps 2 to 4 are performed if the sum of the sizes of $\text{TB}_{\text{size}\#1}$ and $\text{TB}_{\text{size}\#2}$ is less than or equal to UE capability "Maximum number of DL-SCH transport block bits received within a TTI" as specified in Table 7.1.7.1.5.3.2-1 and larger than or equal to 136 bits as specified in Table 7.1.7.1.5.3.2-2, and the effective channel code rate, as defined in TS 36.213 clause 7.1.7,	-	-	-	-

	is lower than or equal to 0.930.				
2	SS creates one or more PDCP SDUs for transport block 1 and 2 depending on $TB_{size\#1}$, and $TB_{size\#2}$ in accordance with Table 7.1.7.1.5.3.2-2.	-	-	-	-
3	SS transmits the PDCP SDUs for transport block 1 and 2 concatenated into a MAC PDU per transport block and indicates on PDCCH DCI Format 2A with RA type 0 and a resource block assignment (RBA) correspondent to N_{PRB} as specified in 7.1.6.1 in TS 36.213 and modulation and coding scheme $I_{MCS\#1}$ for transport block 1 and $I_{MCS\#2}$ for transport block 2. The N PDCP SDUs are split between MAC PDU 1 and 2;	<--	Transport block 1: MAC PDU Transport block 2: MAC PDU DCI: (DCI Format 2A, RA type 0, $RBA(N_{PRB})$, $I_{MCS\#1}$, $I_{MCS\#2}$)	-	-
3a	SS transmits one or more UL Grants sufficient for transmitting loop back PDCP SDUs.	<--	(UL Grant)	-	-
4	CHECK: Does UE return the same number of PDCP SDUs with same content as transmitted by the SS in step 3?	-->	(N x PDCP SDUs)	1	P

7.1.7.1.5.3.3 Specific Message Contents

Table 7.1.7.1.5.3.3-1: UECapabilityInformation (Preamble Table 4.5.2.3-1 [18]: Step 13)

Derivation Path: 36.508 table 4.6.1-23			
Information Element	Value/remark	Comment	Condition
UECapabilityInformation ::= SEQUENCE {			
criticalExtensions CHOICE {			
c1 CHOICE{			
ueCapabilityInformation-r8 SEQUENCE {			
ue-CapabilityRAT-ContainerList SEQUENCE (SIZE (1..maxRAT-Capabilities)) OF SEQUENCE {	1 entry		
ueCapabilityRAT-Container			
ue-EUTRA-Capability SEQUENCE {			
ue-Category	Checked against UE Category indications in the PICS		
}			
}			
}			
}			
}			

7.1.7.1.6 DL-SCH Transport Block Size selection / DCI format 2A / RA type 1 / Two transport blocks enabled / Transport block to codeword swap flag value set to '1'

7.1.7.1.6.1 Test Purpose (TP)

(1)

with { UE in E-UTRA RRC_CONNECTED state }
ensure that {

when { UE has two transport blocks enabled and on PDCCH receives DCI format 2A indicating Resource Allocation Type 1, a resource block assignment correspondent to N_{PRB} physical resource blocks, the Transport block to codeword swap flag value set to '1' and a modulation and coding scheme I_{MCS} for two transport blocks }

then { UE decodes the two transport blocks of sizes correspondent to the read N_{PRB} and I_{MCS} for transport block 1 and I_{MCS} for transport block 2 **and** forwards it to higher layers }

7.1.7.1.6.2 Conformance requirements

References: The conformance requirements covered in the current TC are specified in: TS 36.212, clauses 5.3.3.1.2, 5.3.3.1.5 and 5.3.3.1.5A; TS 36.213, clauses 7.1.6.1, 7.1.7, 7.1.7.1, 7.1.7.2 and 7.1.7.2.1; and TS 36.306 clause 4.1.

[TS 36.212 clause 5.3.3.1.2]

...

Table 5.3.3.1.2-1: Ambiguous Sizes of Information Bits

{12, 14, 16, 20, 24, 26, 32, 40, 44, 56}
--

[TS 36.212 clause 5.3.3.1.5]

Table 5.3.3.1.5-1: Transport block to codeword mapping (two transport blocks enabled)

transport block to codeword swap flag value	codeword 0 (enabled)	codeword 1 (enabled)
0	transport block 1	transport block 2
1	transport block 2	transport block 1

[TS 36.212 clause 5.3.3.1.5A]

The following information is transmitted by means of the DCI format 2A:

- Resource allocation header (resource allocation type 0 / type 1) – 1 bit as defined in section 7.1.6 of [3]

If downlink bandwidth is less than or equal to 10 PRBs, there is no resource allocation header and resource allocation type 0 is assumed.

- Resource block assignment:

...

- For resource allocation type 1 as defined in section 7.1.6.2 of [3]

- $\lceil \log_2(P) \rceil$ bits of this field are used as a header specific to this resource allocation type to indicate the selected resource blocks subset

- 1 bit indicates a shift of the resource allocation span

- $\left(\left\lceil N_{RB}^{DL} / P \right\rceil - \lceil \log_2(P) \rceil - 1 \right)$ bits provide the resource allocation

where the value of P depends on the number of DL resource blocks as indicated in subclause [7.1.6.1] of [3]

...

- Transport block to codeword swap flag – 1 bit

In addition, for transport block 1:

- Modulation and coding scheme – 5 bits as defined in section 7.1.7 of [3]
- New data indicator – 1 bit
- Redundancy version – 2 bits

In addition, for transport block 2:

- Modulation and coding scheme – 5 bits as defined in section 7.1.7 of [3]
- New data indicator – 1 bit
- Redundancy version – 2 bits

...

If both transport blocks are enabled, the transport block to codeword mapping is specified according to Table 5.3.3.1.5-1.

...

If the number of information bits in format 2A belongs to one of the sizes in Table 5.3.3.1.2-1, one zero bit shall be appended to format 2A.

[TS 36.213 clause 7.1.6.1]

In resource allocations of type 0, resource block assignment information includes a bitmap indicating the resource block groups (RBGs) that are allocated to the scheduled UE where a RBG is a set of consecutive physical resource blocks (PRBs). Resource block group size (P) is a function of the system bandwidth as shown in Table 7.1.6.1-1. The total number of RBGs (N_{RBG}) for downlink system bandwidth of N_{RB}^{DL} PRBs is given by $N_{RBG} = \left\lceil N_{RB}^{DL} / P \right\rceil$ where $\left\lfloor N_{RB}^{DL} / P \right\rfloor$ of the RBGs are of size P and if $N_{RB}^{DL} \bmod P > 0$ then one of the RBGs is of size $N_{RB}^{DL} - P \cdot \left\lfloor N_{RB}^{DL} / P \right\rfloor$. The bitmap is of size N_{RBG} bits with one bitmap bit per RBG such that each RBG is addressable. The RBGs shall be indexed in the order of increasing frequency and non-increasing RBG sizes starting at the lowest frequency. The order of RBG to bitmap bit mapping is in such way that RBG 0 to RBG $N_{RBG} - 1$ are mapped to MSB to LSB of the bitmap. The RBG is allocated to the UE if the corresponding bit value in the bitmap is 1, the RBG is not allocated to the UE otherwise.

Table 7.1.6.1-1: Type 0 Resource Allocation RBG Size vs. Downlink System Bandwidth

System Bandwidth N_{RB}^{DL}	RBG Size (P)
≤ 10	1
11 – 26	2
27 – 63	3
64 – 110	4

[TS 36.213 clause 7.1.7]

To determine the modulation order and transport block size(s) in the physical downlink shared channel, the UE shall first

- read the 5-bit “modulation and coding scheme” field (I_{MCS}) in the DCI

and second if the DCI CRC is scrambled by P-RNTI, RA-RNTI, or SI-RNTI then

...

else

- set the Table 7.1.7.2.1-1 column indicator N'_{PRB} to the total number of allocated PRBs based on the procedure defined in Section 7.1.6.

if the transport block is transmitted in DwPTS of the special subframe in frame structure type 2, then

set the Table 7.1.7.2.1-1 column indicator $N_{PRB} = \max \left\{ \left\lfloor N'_{PRB} \times 0.75 \right\rfloor, 1 \right\}$,

else, set the Table 7.1.7.2.1-1 column indicator $N_{PRB} = N'_{PRB}$.

The UE may skip decoding a transport block in an initial transmission if the effective channel code rate is higher than 0.930, where the effective channel code rate is defined as the number of downlink information bits (including CRC bits) divided by the number of physical channel bits on PDSCH. If the UE skips decoding, the physical layer indicates to higher layer that the transport block is not successfully decoded. For the special subframe configurations 0 and 5 with normal CP or configurations 0 and 4 with extended CP, shown in table 4.2-1 [3], there shall be no PDSCH transmission in DwPTS of the special subframe.

[TS 36.213 clause 7.1.7.1]

The UE shall use $Q_m = 2$ if the DCI CRC is scrambled by P-RNTI, RA-RNTI, or SI-RNTI, otherwise, the UE shall use I_{MCS} and Table 7.1.7.1-1 to determine the modulation order (Q_m) used in the physical downlink shared channel.

Table 7.1.7.1-1: Modulation and TBS index table for PDSCH

MCS Index I_{MCS}	Modulation Order Q_m	TBS Index I_{TBS}
0	2	0
1	2	1
2	2	2
3	2	3
4	2	4
5	2	5
6	2	6
7	2	7
8	2	8
9	2	9
10	4	9
11	4	10
12	4	11
13	4	12
14	4	13
15	4	14
16	4	15
17	6	15
18	6	16
19	6	17
20	6	18
21	6	19
22	6	20
23	6	21
24	6	22
25	6	23
26	6	24
27	6	25
28	6	26
29	2	reserved
30	4	
31	6	

[TS 36.213 clause 7.1.7.2]

If the DCI CRC is scrambled by P-RNTI, RA-RNTI, or SI-RNTI then

- for DCI format 1A:

- the UE shall set the TBS index (I_{TBS}) equal to I_{MCS} and determine its TBS by the procedure in Section 7.1.7.2.1.

...

else

- for $0 \leq I_{\text{MCS}} \leq 28$, the UE shall first determine the TBS index (I_{TBS}) using I_{MCS} and Table 7.1.7.1-1 except if the transport block is disabled in DCI formats 2 and 2A as specified below. For a transport block that is not mapped to two-layer spatial multiplexing, the TBS is determined by the procedure in Section 7.1.7.2.1. For a transport block that is mapped to two-layer spatial multiplexing, the TBS is determined by the procedure in Section 7.1.7.2.2.
- for $29 \leq I_{\text{MCS}} \leq 31$, the TBS is assumed to be as determined from DCI transported in the latest PDCCH for the same transport block using $0 \leq I_{\text{MCS}} \leq 28$. If there is no latest PDCCH for the same transport block using $0 \leq I_{\text{MCS}} \leq 28$, and if the initial PDSCH for the same transport block is semi-persistently scheduled, the TBS shall be determined from the most recent semi-persistent scheduling assignment PDCCH.
- In DCI formats 2 and 2A a transport block is disabled if $I_{\text{MCS}} = 0$ and if $rv_{\text{idx}} = 1$ otherwise the transport block is enabled.

The NDI and HARQ process ID, as signalled on PDCCH, and the TBS, as determined above, shall be delivered to higher layers.

[TS 36.213 clause 7.1.7.2.1]

For $1 \leq N_{\text{PRB}} \leq 110$, the TBS is given by the ($I_{\text{TBS}}, N_{\text{PRB}}$) entry of Table 7.1.7.2.1-1.

Table 7.1.7.2.1-1: Transport block size table (dimension 27x110)

I_{TBS}	N_{PRB}									
	1	2	3	4	5	6	7	8	9	10
0	16	32	56	88	120	152	176	208	224	256
1	24	56	88	144	176	208	224	256	328	344
2	32	72	144	176	208	256	296	328	376	424
3	40	104	176	208	256	328	392	440	504	568
4	56	120	208	256	328	408	488	552	632	696
5	72	144	224	328	424	504	600	680	776	872
6	328	176	256	392	504	600	712	808	936	1032
7	104	224	328	472	584	712	840	968	1096	1224
8	120	256	392	536	680	808	968	1096	1256	1384
9	136	296	456	616	776	936	1096	1256	1416	1544
10	144	328	504	680	872	1032	1224	1384	1544	1736
11	176	376	584	776	1000	1192	1384	1608	1800	2024
12	208	440	680	904	1128	1352	1608	1800	2024	2280
13	224	488	744	1000	1256	1544	1800	2024	2280	2536
14	256	552	840	1128	1416	1736	1992	2280	2600	2856
15	280	600	904	1224	1544	1800	2152	2472	2728	3112
16	328	632	968	1288	1608	1928	2280	2600	2984	3240
17	336	696	1064	1416	1800	2152	2536	2856	3240	3624
18	376	776	1160	1544	1992	2344	2792	3112	3624	4008
19	408	840	1288	1736	2152	2600	2984	3496	3880	4264
20	440	904	1384	1864	2344	2792	3240	3752	4136	4584
21	488	1000	1480	1992	2472	2984	3496	4008	4584	4968
22	520	1064	1608	2152	2664	3240	3752	4264	4776	5352
23	552	1128	1736	2280	2856	3496	4008	4584	5160	5736
24	584	1192	1800	2408	2984	3624	4264	4968	5544	5992
25	616	1256	1864	2536	3112	3752	4392	5160	5736	6200
26	712	1480	2216	2984	3752	4392	5160	5992	6712	7480
I_{TBS}	N_{PRB}									
	11	12	13	14	15	16	17	18	19	20
0	288	328	344	376	392	424	456	488	504	536
1	376	424	456	488	520	568	600	632	680	712
2	472	520	568	616	648	696	744	776	840	872
3	616	680	744	808	872	904	968	1032	1096	1160
4	776	840	904	1000	1064	1128	1192	1288	1352	1416
5	968	1032	1128	1224	1320	1384	1480	1544	1672	1736
6	1128	1224	1352	1480	1544	1672	1736	1864	1992	2088
7	1320	1480	1608	1672	1800	1928	2088	2216	2344	2472
8	1544	1672	1800	1928	2088	2216	2344	2536	2664	2792
9	1736	1864	2024	2216	2344	2536	2664	2856	2984	3112
10	1928	2088	2280	2472	2664	2792	2984	3112	3368	3496
11	2216	2408	2600	2792	2984	3240	3496	3624	3880	4008
12	2472	2728	2984	3240	3368	3624	3880	4136	4392	4584
13	2856	3112	3368	3624	3880	4136	4392	4584	4968	5160
14	3112	3496	3752	4008	4264	4584	4968	5160	5544	5736
15	3368	3624	4008	4264	4584	4968	5160	5544	5736	6200
16	3624	3880	4264	4584	4968	5160	5544	5992	6200	6456
17	4008	4392	4776	5160	5352	5736	6200	6456	6712	7224
18	4392	4776	5160	5544	5992	6200	6712	7224	7480	7992
19	4776	5160	5544	5992	6456	6968	7224	7736	8248	8504
20	5160	5544	5992	6456	6968	7480	7992	8248	8760	9144
21	5544	5992	6456	6968	7480	7992	8504	9144	9528	9912
22	5992	6456	6968	7480	7992	8504	9144	9528	10296	10680
23	6200	6968	7480	7992	8504	9144	9912	10296	11064	11448
24	6712	7224	7992	8504	9144	9912	10296	11064	11448	12216
25	6968	7480	8248	8760	9528	10296	10680	11448	12216	12576
26	8248	8760	9528	10296	11064	11832	12576	13536	14112	14688
I_{TBS}	N_{PRB}									
	21	22	23	24	25	26	27	28	29	30
0	568	600	616	648	680	712	744	776	776	808
1	744	776	808	872	904	936	968	1000	1032	1064

2	936	968	1000	1064	1096	1160	1192	1256	1288	1320
3	1224	1256	1320	1384	1416	1480	1544	1608	1672	1736
4	1480	1544	1608	1736	1800	1864	1928	1992	2088	2152
5	1864	1928	2024	2088	2216	2280	2344	2472	2536	2664
6	2216	2280	2408	2472	2600	2728	2792	2984	2984	3112
7	2536	2664	2792	2984	3112	3240	3368	3368	3496	3624
8	2984	3112	3240	3368	3496	3624	3752	3880	4008	4264
9	3368	3496	3624	3752	4008	4136	4264	4392	4584	4776
10	3752	3880	4008	4264	4392	4584	4776	4968	5160	5352
11	4264	4392	4584	4776	4968	5352	5544	5736	5992	5992
12	4776	4968	5352	5544	5736	5992	6200	6456	6712	6712
13	5352	5736	5992	6200	6456	6712	6968	7224	7480	7736
14	5992	6200	6456	6968	7224	7480	7736	7992	8248	8504
15	6456	6712	6968	7224	7736	7992	8248	8504	8760	9144
16	6712	7224	7480	7736	7992	8504	8760	9144	9528	9912
17	7480	7992	8248	8760	9144	9528	9912	10296	10296	10680
18	8248	8760	9144	9528	9912	10296	10680	11064	11448	11832
19	9144	9528	9912	10296	10680	11064	11448	12216	12576	12960
20	9912	10296	10680	11064	11448	12216	12576	12960	13536	14112
21	10680	11064	11448	12216	12576	12960	13536	14112	14688	15264
22	11448	11832	12576	12960	13536	14112	14688	15264	15840	16416
23	12216	12576	12960	13536	14112	14688	15264	15840	16416	16992
24	12960	13536	14112	14688	15264	15840	16416	16992	17568	18336
25	13536	14112	14688	15264	15840	16416	16992	17568	18336	19080
26	15264	16416	16992	17568	18336	19080	19848	20616	21384	22152
I_{TBS}	N_{PRB}									
	31	32	33	34	35	36	37	38	39	40
0	840	872	904	936	968	1000	1032	1032	1064	1096
1	1128	1160	1192	1224	1256	1288	1352	1384	1416	1416
2	1384	1416	1480	1544	1544	1608	1672	1672	1736	1800
3	1800	1864	1928	1992	2024	2088	2152	2216	2280	2344
4	2216	2280	2344	2408	2472	2600	2664	2728	2792	2856
5	2728	2792	2856	2984	3112	3112	3240	3368	3496	3496
6	3240	3368	3496	3496	3624	3752	3880	4008	4136	4136
7	3752	3880	4008	4136	4264	4392	4584	4584	4776	4968
8	4392	4584	4584	4776	4968	4968	5160	5352	5544	5544
9	4968	5160	5160	5352	5544	5736	5736	5992	6200	6200
10	5544	5736	5736	5992	6200	6200	6456	6712	6712	6968
11	6200	6456	6712	6968	6968	7224	7480	7736	7736	7992
12	6968	7224	7480	7736	7992	8248	8504	8760	8760	9144
13	7992	8248	8504	8760	9144	9144	9528	9912	9912	10296
14	8760	9144	9528	9912	9912	10296	10680	11064	11064	11448
15	9528	9912	10296	10296	10680	11064	11448	11832	11832	12216
16	9912	10296	10680	11064	11448	11832	12216	12216	12576	12960
17	11064	11448	11832	12216	12576	12960	13536	13536	14112	14688
18	12216	12576	12960	13536	14112	14112	14688	15264	15264	15840
19	13536	13536	14112	14688	15264	15264	15840	16416	16992	16992
20	14688	14688	15264	15840	16416	16992	16992	17568	18336	18336
21	15840	15840	16416	16992	17568	18336	18336	19080	19848	19848
22	16992	16992	17568	18336	19080	19080	19848	20616	21384	21384
23	17568	18336	19080	19848	19848	20616	21384	22152	22152	22920
24	19080	19848	19848	20616	21384	22152	22920	22920	23688	24496
25	19848	20616	20616	21384	22152	22920	23688	24496	24496	25456
26	22920	23688	24496	25456	25456	26416	27376	28336	29296	29296
I_{TBS}	N_{PRB}									
	41	42	43	44	45	46	47	48	49	50
0	1128	1160	1192	1224	1256	1256	1288	1320	1352	1384
1	1480	1544	1544	1608	1608	1672	1736	1736	1800	1800
2	1800	1864	1928	1992	2024	2088	2088	2152	2216	2216
3	2408	2472	2536	2536	2600	2664	2728	2792	2856	2856
4	2984	2984	3112	3112	3240	3240	3368	3496	3496	3624
5	3624	3752	3752	3880	4008	4008	4136	4264	4392	4392
6	4264	4392	4584	4584	4776	4776	4968	4968	5160	5160
7	4968	5160	5352	5352	5544	5736	5736	5992	5992	6200

8	5736	5992	5992	6200	6200	6456	6456	6712	6968	6968
9	6456	6712	6712	6968	6968	7224	7480	7480	7736	7992
10	7224	7480	7480	7736	7992	7992	8248	8504	8504	8760
11	8248	8504	8760	8760	9144	9144	9528	9528	9912	9912
12	9528	9528	9912	9912	10296	10680	10680	11064	11064	11448
13	10680	10680	11064	11448	11448	11832	12216	12216	12576	12960
14	11832	12216	12216	12576	12960	12960	13536	13536	14112	14112
15	12576	12960	12960	13536	13536	14112	14688	14688	15264	15264
16	13536	13536	14112	14112	14688	14688	15264	15840	15840	16416
17	14688	15264	15264	15840	16416	16416	16992	17568	17568	18336
18	16416	16416	16992	17568	17568	18336	18336	19080	19080	19848
19	17568	18336	18336	19080	19080	19848	20616	20616	21384	21384
20	19080	19848	19848	20616	20616	21384	22152	22152	22920	22920
21	20616	21384	21384	22152	22920	22920	23688	24496	24496	25456
22	22152	22920	22920	23688	24496	24496	25456	25456	26416	27376
23	23688	24496	24496	25456	25456	26416	27376	27376	28336	28336
24	25456	25456	26416	26416	27376	28336	28336	29296	29296	30576
25	26416	26416	27376	28336	28336	29296	29296	30576	31704	31704
26	30576	30576	31704	32856	32856	34008	35160	35160	36696	36696
I_{TBS}	N_{PRB}									
	51	52	53	54	55	56	57	58	59	60
0	1416	1416	1480	1480	1544	1544	1608	1608	1608	1672
1	1864	1864	1928	1992	1992	2024	2088	2088	2152	2152
2	2280	2344	2344	2408	2472	2536	2536	2600	2664	2664
3	2984	2984	3112	3112	3240	3240	3368	3368	3496	3496
4	3624	3752	3752	3880	4008	4008	4136	4136	4264	4264
5	4584	4584	4776	4776	4776	4968	4968	5160	5160	5352
6	5352	5352	5544	5736	5736	5992	5992	5992	6200	6200
7	6200	6456	6456	6712	6712	6712	6968	6968	7224	7224
8	7224	7224	7480	7480	7736	7736	7992	7992	8248	8504
9	7992	8248	8248	8504	8760	8760	9144	9144	9144	9528
10	9144	9144	9144	9528	9528	9912	9912	10296	10296	10680
11	10296	10680	10680	11064	11064	11448	11448	11832	11832	12216
12	11832	11832	12216	12216	12576	12576	12960	12960	13536	13536
13	12960	13536	13536	14112	14112	14688	14688	14688	15264	15264
14	14688	14688	15264	15264	15840	15840	16416	16416	16992	16992
15	15840	15840	16416	16416	16992	16992	17568	17568	18336	18336
16	16416	16992	16992	17568	17568	18336	18336	19080	19080	19848
17	18336	19080	19080	19848	19848	20616	20616	20616	21384	21384
18	19848	20616	21384	21384	22152	22152	22920	22920	23688	23688
19	22152	22152	22920	22920	23688	24496	24496	25456	25456	25456
20	23688	24496	24496	25456	25456	26416	26416	27376	27376	28336
21	25456	26416	26416	27376	27376	28336	28336	29296	29296	30576
22	27376	28336	28336	29296	29296	30576	30576	31704	31704	32856
23	29296	29296	30576	30576	31704	31704	32856	32856	34008	34008
24	31704	31704	32856	32856	34008	34008	35160	35160	36696	36696
25	32856	32856	34008	34008	35160	35160	36696	36696	37888	37888
26	37888	37888	39232	40576	40576	40576	42368	42368	43816	43816
I_{TBS}	N_{PRB}									
	61	62	63	64	65	66	67	68	69	70
0	1672	1736	1736	1800	1800	1800	1864	1864	1928	1928
1	2216	2280	2280	2344	2344	2408	2472	2472	2536	2536
2	2728	2792	2856	2856	2856	2984	2984	3112	3112	3112
3	3624	3624	3624	3752	3752	3880	3880	4008	4008	4136
4	4392	4392	4584	4584	4584	4776	4776	4968	4968	4968
5	5352	5544	5544	5736	5736	5736	5992	5992	5992	6200
6	6456	6456	6456	6712	6712	6968	6968	6968	7224	7224
7	7480	7480	7736	7736	7992	7992	8248	8248	8504	8504
8	8504	8760	8760	9144	9144	9144	9528	9528	9528	9912
9	9528	9912	9912	10296	10296	10296	10680	10680	11064	11064
10	10680	11064	11064	11448	11448	11448	11832	11832	12216	12216
11	12216	12576	12576	12960	12960	13536	13536	13536	14112	14112
12	14112	14112	14112	14688	14688	15264	15264	15264	15840	15840
13	15840	15840	16416	16416	16992	16992	16992	17568	17568	18336

14	17568	17568	18336	18336	18336	19080	19080	19848	19848	19848
15	18336	19080	19080	19848	19848	20616	20616	20616	21384	21384
16	19848	19848	20616	20616	21384	21384	22152	22152	22152	22920
17	22152	22152	22920	22920	23688	23688	24496	24496	24496	25456
18	24496	24496	24496	25456	25456	26416	26416	27376	27376	27376
19	26416	26416	27376	27376	28336	28336	29296	29296	29296	30576
20	28336	29296	29296	29296	30576	30576	31704	31704	31704	32856
21	30576	31704	31704	31704	32856	32856	34008	34008	35160	35160
22	32856	34008	34008	34008	35160	35160	36696	36696	36696	37888
23	35160	35160	36696	36696	37888	37888	37888	39232	39232	40576
24	36696	37888	37888	39232	39232	40576	40576	42368	42368	42368
25	39232	39232	40576	40576	40576	42368	42368	43816	43816	43816
26	45352	45352	46888	46888	48936	48936	48936	51024	51024	52752
I_{TBS}	N_{PRB}									
	71	72	73	74	75	76	77	78	79	80
0	1992	1992	2024	2088	2088	2088	2152	2152	2216	2216
1	2600	2600	2664	2728	2728	2792	2792	2856	2856	2856
2	3240	3240	3240	3368	3368	3368	3496	3496	3496	3624
3	4136	4264	4264	4392	4392	4392	4584	4584	4584	4776
4	5160	5160	5160	5352	5352	5544	5544	5544	5736	5736
5	6200	6200	6456	6456	6712	6712	6712	6968	6968	6968
6	7480	7480	7736	7736	7736	7992	7992	8248	8248	8248
7	8760	8760	8760	9144	9144	9144	9528	9528	9528	9912
8	9912	9912	10296	10296	10680	10680	10680	11064	11064	11064
9	11064	11448	11448	11832	11832	11832	12216	12216	12576	12576
10	12576	12576	12960	12960	12960	13536	13536	13536	14112	14112
11	14112	14688	14688	14688	15264	15264	15840	15840	15840	16416
12	16416	16416	16416	16992	16992	17568	17568	17568	18336	18336
13	18336	18336	19080	19080	19080	19848	19848	19848	20616	20616
14	20616	20616	20616	21384	21384	22152	22152	22152	22920	22920
15	22152	22152	22152	22920	22920	23688	23688	23688	24496	24496
16	22920	23688	23688	24496	24496	24496	25456	25456	25456	26416
17	25456	26416	26416	26416	27376	27376	27376	28336	28336	29296
18	28336	28336	29296	29296	29296	30576	30576	30576	31704	31704
19	30576	30576	31704	31704	32856	32856	32856	34008	34008	34008
20	32856	34008	34008	34008	35160	35160	35160	36696	36696	36696
21	35160	36696	36696	36696	37888	37888	39232	39232	39232	40576
22	37888	39232	39232	40576	40576	40576	42368	42368	42368	43816
23	40576	40576	42368	42368	43816	43816	43816	45352	45352	45352
24	43816	43816	45352	45352	45352	46888	46888	46888	48936	48936
25	45352	45352	46888	46888	46888	48936	48936	48936	51024	51024
26	52752	52752	55056	55056	55056	55056	57336	57336	57336	59256
I_{TBS}	N_{PRB}									
	81	82	83	84	85	86	87	88	89	90
0	2280	2280	2280	2344	2344	2408	2408	2472	2472	2536
1	2984	2984	2984	3112	3112	3112	3240	3240	3240	3240
2	3624	3624	3752	3752	3880	3880	3880	4008	4008	4008
3	4776	4776	4776	4968	4968	4968	5160	5160	5160	5352
4	5736	5992	5992	5992	5992	6200	6200	6200	6456	6456
5	7224	7224	7224	7480	7480	7480	7736	7736	7736	7992
6	8504	8504	8760	8760	8760	9144	9144	9144	9144	9528
7	9912	9912	10296	10296	10296	10680	10680	10680	11064	11064
8	11448	11448	11448	11832	11832	12216	12216	12216	12576	12576
9	12960	12960	12960	13536	13536	13536	13536	14112	14112	14112
10	14112	14688	14688	14688	14688	15264	15264	15264	15840	15840
11	16416	16416	16992	16992	16992	17568	17568	17568	18336	18336
12	18336	19080	19080	19080	19080	19848	19848	19848	20616	20616
13	20616	21384	21384	21384	21384	22152	22152	22920	22920	22920
14	22920	23688	23688	24496	24496	24496	25456	25456	25456	25456
15	24496	25456	25456	25456	26416	26416	26416	27376	27376	27376
16	26416	26416	27376	27376	27376	28336	28336	28336	29296	29296
17	29296	29296	30576	30576	30576	30576	31704	31704	31704	32856
18	31704	32856	32856	32856	34008	34008	34008	35160	35160	35160
19	35160	35160	35160	36696	36696	36696	37888	37888	37888	39232

20	37888	37888	39232	39232	39232	40576	40576	40576	42368	42368
21	40576	40576	42368	42368	42368	43816	43816	43816	45352	45352
22	43816	43816	45352	45352	45352	46888	46888	46888	48936	48936
23	46888	46888	46888	48936	48936	48936	51024	51024	51024	51024
24	48936	51024	51024	51024	52752	52752	52752	52752	55056	55056
25	51024	52752	52752	52752	55056	55056	55056	55056	57336	57336
26	59256	59256	61664	61664	61664	63776	63776	63776	66592	66592
I_{TBS}	N_{PRB}									
	91	92	93	94	95	96	97	98	99	100
0	2536	2536	2600	2600	2664	2664	2728	2728	2728	2792
1	3368	3368	3368	3496	3496	3496	3496	3624	3624	3624
2	4136	4136	4136	4264	4264	4264	4392	4392	4392	4584
3	5352	5352	5352	5544	5544	5544	5736	5736	5736	5736
4	6456	6456	6712	6712	6712	6968	6968	6968	6968	7224
5	7992	7992	8248	8248	8248	8504	8504	8760	8760	8760
6	9528	9528	9528	9912	9912	9912	10296	10296	10296	10296
7	11064	11448	11448	11448	11448	11832	11832	11832	12216	12216
8	12576	12960	12960	12960	13536	13536	13536	13536	14112	14112
9	14112	14688	14688	14688	15264	15264	15264	15264	15840	15840
10	15840	16416	16416	16416	16992	16992	16992	16992	17568	17568
11	18336	18336	19080	19080	19080	19080	19848	19848	19848	19848
12	20616	21384	21384	21384	21384	22152	22152	22152	22920	22920
13	23688	23688	23688	24496	24496	24496	25456	25456	25456	25456
14	26416	26416	26416	27376	27376	27376	28336	28336	28336	28336
15	28336	28336	28336	29296	29296	29296	29296	30576	30576	30576
16	29296	30576	30576	30576	30576	31704	31704	31704	31704	32856
17	32856	32856	34008	34008	34008	35160	35160	35160	35160	36696
18	36696	36696	36696	37888	37888	37888	37888	39232	39232	39232
19	39232	39232	40576	40576	40576	40576	42368	42368	42368	43816
20	42368	42368	43816	43816	43816	45352	45352	45352	46888	46888
21	45352	46888	46888	46888	46888	48936	48936	48936	48936	51024
22	48936	48936	51024	51024	51024	51024	52752	52752	52752	55056
23	52752	52752	52752	55056	55056	55056	55056	57336	57336	57336
24	55056	57336	57336	57336	57336	59256	59256	59256	61664	61664
25	57336	59256	59256	59256	61664	61664	61664	61664	63776	63776
26	66592	68808	68808	68808	71112	71112	71112	73712	73712	75376
I_{TBS}	N_{PRB}									
	101	102	103	104	105	106	107	108	109	110
0	2792	2856	2856	2856	2984	2984	2984	2984	2984	3112
1	3752	3752	3752	3752	3880	3880	3880	4008	4008	4008
2	4584	4584	4584	4584	4776	4776	4776	4776	4968	4968
3	5992	5992	5992	5992	6200	6200	6200	6200	6456	6456
4	7224	7224	7480	7480	7480	7480	7736	7736	7736	7992
5	8760	9144	9144	9144	9144	9528	9528	9528	9528	9528
6	10680	10680	10680	10680	11064	11064	11064	11448	11448	11448
7	12216	12576	12576	12576	12960	12960	12960	12960	13536	13536
8	14112	14112	14688	14688	14688	14688	15264	15264	15264	15264
9	15840	16416	16416	16416	16416	16992	16992	16992	17568	17568
10	17568	18336	18336	18336	18336	18336	19080	19080	19080	19080
11	20616	20616	20616	21384	21384	21384	21384	22152	22152	22152
12	22920	23688	23688	23688	23688	24496	24496	24496	24496	25456
13	26416	26416	26416	26416	27376	27376	27376	27376	28336	28336
14	29296	29296	29296	29296	30576	30576	30576	30576	31704	31704
15	30576	31704	31704	31704	31704	32856	32856	32856	34008	34008
16	32856	32856	34008	34008	34008	34008	35160	35160	35160	35160
17	36696	36696	36696	37888	37888	37888	39232	39232	39232	39232
18	40576	40576	40576	40576	42368	42368	42368	42368	43816	43816
19	43816	43816	43816	45352	45352	45352	46888	46888	46888	46888
20	46888	46888	48936	48936	48936	48936	48936	51024	51024	51024
21	51024	51024	51024	52752	52752	52752	52752	55056	55056	55056
22	55056	55056	55056	57336	57336	57336	57336	59256	59256	59256
23	57336	59256	59256	59256	59256	61664	61664	61664	61664	63776
24	61664	61664	63776	63776	63776	63776	66592	66592	66592	66592
25	63776	63776	66592	66592	66592	66592	68808	68808	68808	71112

26	75376	75376	75376	75376	75376	75376	75376	75376	75376	75376
----	-------	-------	-------	-------	-------	-------	-------	-------	-------	-------

[TS 36.306 clause 4.1]

The field *ue-Category* defines a combined uplink and downlink capability. The parameters set by the UE Category are defined in subclause 4.2. Tables 4.1-1 and 4.1-2 define the downlink and, respectively, uplink physical layer parameter values for each UE Category.

Table 4.1-1: Downlink physical layer parameter values set by the field *ue-Category*

UE Category	Maximum number of DL-SCH transport block bits received within a TTI	Maximum number of bits of a DL-SCH transport block received within a TTI	Total number of soft channel bits	Maximum number of supported layers for spatial multiplexing in DL
Category 1	10296	10296	250368	1
Category 2	51024	51024	1237248	2
Category 3	102048	75376	1237248	2
Category 4	150752	75376	1827072	2
Category 5	299552	149776	3667200	4

Table 4.1-2: Uplink physical layer parameter values set by the field *ue-Category*

UE Category	Maximum number of bits of an UL-SCH transport block transmitted within a TTI	Support for 64QAM in UL
Category 1	5160	No
Category 2	25456	No
Category 3	51024	No
Category 4	51024	No
Category 5	75376	Yes

...

7.1.7.1.6.3 Test description

7.1.7.1.6.3.1 Pre-test conditions

System Simulator

- Cell 1.
- Uplink and downlink bandwidth set to the maximum bandwidth for the E-UTRA Band under test as specified in Table 5.6.1-1 in [31] (to enable testing of N_{PRB} up to maximum value). For Band 18, Band 19 and Band 25, based on industry requirement, uplink and downlink bandwidth set to 10MHz.

UE:

None.

Preamble

- The UE is in state Loopback Activated (state 4) according to [18] condition 2TX to configure MIMO.

7.1.7.1.6.3.2 Test procedure sequence

Table 7.1.7.1.6.3.2-1: Maximum TB_{size} for different UE categories

UE Category	Maximum number of bits of a DL-SCH transport block received within a TTI
Category 1	10296
Category 2	51024
Category 3	75376
Category 4	75376
Category 5	149776

Table 7.1.7.1.6.3.2-2: Number of downlink PDCP SDUs and PDCP SDU size used as test data for transport block 1 and transport block 2

Total TB _{size} (sum of the sizes of TB _{size#1} and TB _{size#2}) (bits)	Number of PDCP SDUs	PDCP SDU size (bits] See note 1
$136 \leq TB_{size} \leq 12120$ See note 2	1	$8 * \text{FLOOR}((TB_{size} - 120)/8)$
$12121 \leq TB_{size} \leq 24152$	2	$8 * \text{FLOOR}((TB_{size} - 152)/16)$
$24153 \leq TB_{size} \leq 36176$	3	$8 * \text{FLOOR}((TB_{size} - 176)/24)$
$36177 \leq TB_{size} \leq 48208$	4	$8 * \text{FLOOR}((TB_{size} - 208)/32)$
$48209 \leq TB_{size} \leq 60232$	5	$8 * \text{FLOOR}((TB_{size} - 232)/40)$
$60233 \leq TB_{size} \leq 72264$	6	$8 * \text{FLOOR}((TB_{size} - 264)/48)$
$72265 \leq TB_{size} \leq 84288$	7	$8 * \text{FLOOR}((TB_{size} - 288)/56)$
	8	$84289 \leq TB_{size} \leq 96320$ $8 * \text{FLOOR}((TB_{size} - 320)/64)$
$84321 \leq TB_{size} \leq 108348$	9	$8 * \text{FLOOR}((TB_{size} - 348)/72)$
	10	$8 * \text{FLOOR}((TB_{size} - 376)/80)$
$96321 \leq TB_{size} \leq 108348$		
	11	$8 * \text{FLOOR}((TB_{size} - 400)/88)$
$108349 \leq TB_{size} \leq 120376$		
	12	$8 * \text{FLOOR}((TB_{size} - 432)/96)$
$120377 \leq TB_{size} \leq 132400$		
	13	$8 * \text{FLOOR}((TB_{size} - 456)/104)$
$132401 \leq TB_{size} \leq 144432$		
<p>Note 1. Each PDCP SDU is limited to 1500 octets (to keep below maximum SDU size of ESM as specified in TS 24.301 clause 9.9.4.12).</p> <p>The PDCP SDU size of each PDCP SDU is</p> <p>PDCP SDU size = (Total TBsize – N*PDCP header size - AMD PDU header size - - MAC header size – Size of Timing Advance– RLC Status PDU size) / N, where</p> <p>PDCP header size is 16 bits for the RLC AM and 12-bit SN case;</p> <p>AMD PDU header size is $\text{CEIL}[(\text{Number of TBs} * 16 + (\text{N}-1) * 12) / 8]$ bytes which includes one 16 bit standard AM header per TB and N-1 Length indicators of 12 bits corresponding to the worst case when one of the PDCP SDU is split between the two transport blocks. If no PDCP SDU is split between the transport blocks then there will be only N-2 LIs and MAC padding will occur instead of one LI;</p> <p>MAC header size = R/R/E/LCID MAC subheader (8 bits for Timing Advance) + R/R/E/LCID MAC subheader (24 bits for MAC SDU for RLC data PDU)+ Number of TBs R/R/E/LCID MAC subheaders (8 bits for MAC SDU for RLC status PDU) = 8 +24 + Number of TBs * 8 bits; If status PDU is not included or, MAC LI is included for MAC SDU for RLC status PDU instead of RLC data PDU, MAC padding will occur in place of unused bits</p> <p>Size of Timing Advance MAC CE is 8 bits (if no Timing Advance needs to be sent, padding will occur instead);</p> <p>RLC Status PDU size = 16 bits (including one ACK SQN triggered in execution X+1, due to loop back transmission in execution X and as all loop backed PDUs in execution X have been correctly received, the status PDU will carry an ACK SQN only.</p>		

This gives:

PDCP SDU size = $8 \cdot \text{FLOOR}((\text{Total TBSize} - N \cdot 16 - 8 \cdot \text{CEIL}((2 \cdot 16 + (N-1) \cdot 12) / 8) - 72) / (8 \cdot N))$ bits

Note 2: According to TS 36.213 Table 7.1.7.2.1-1 and the final PDCP SDU size formula in Note 1, the smallest total TBSize that can be tested (corresponding to $N=1$, and PDCP SDU size of 16) is 136 bits.

Table 7.1.7.1.6.3.2-2a: Bandwidth Dependent Parameters

Max Bandwidth	Max N_{PRB}	Allowed N_{PRB} Values
10 Mhz	50	2, 3, 5, 6, 8, 9, 11, 12, 14, 15, 17, 18, 20, 21, 23, 24, 26, 27, 29, 30, 32, 33, 35, 36, 38, 39, 41, 42, 44, 45, 47, 48, 50
15 Mhz	75	3, 4, 7, 8, 11, 12, 15, 16, 19, 20, 23, 24, 27, 28, 31, 32, 35, 36, 39, 40, 43, 44, 47, 48, 51, 52, 55, 56, 59, 60, 63, 64, 67, 68, 71, 72, 75
20 Mhz	100	4, 8, 12, 16, 20, 24, 28, 32, 36, 40, 44, 48, 52, 56, 60, 64, 68, 72, 76, 80, 84, 88, 92, 96, 100

Note: Maximum bandwidth for EUTRA bands is 10/15/20 Mhz.

Table 7.1.7.1.6.3.2-2b: Ambiguous Sizes of Information Bits

{12, 14, 16, 20, 24, 26, 32, 40, 44, 56}

Table 7.1.7.1.6.3.2-3: Main behaviour

St	Procedure	Message Sequence		TP	Verdict
		U – S	Message		
-	EXCEPTION: Steps 1 to 4 are repeated for allowed values of N_{PRB} as per table 7.1.7.1.6.3.2-2a and for each I_{MCS} from 0 to 28	-	-	-	-
1	SS looks up I_{TBS} in table 7.1.7.1-1 in TS 36.213 based on the value of I_{MCS} . SS looks up TB_{size} in table 7.1.7.2.1-1 in TS 36.213 based on values of N_{PRB} and I_{TBS} . The SS uses the same I_{MCS} and TB_{size} for both transport blocks: $I_{MCS\#1} = I_{MCS\#2} = I_{MCS}$ $TB_{size\#1} = TB_{size\#2} = TB_{size}$	-	-	-	-
-	EXCEPTION: Steps 2 to 4 are performed if the sum of the sizes of $TB_{size\#1}$ and $TB_{size\#2}$ is less than or equal to UE capability "Maximum number of DL-SCH transport block bits received within a TTI" as specified in Table 7.1.7.1.6.3.2-1 and larger than or equal to 136 bits as specified in Table 7.1.7.1.6.3.2-2, and the effective channel code rate, as defined in TS 36.213 clause 7.1.7,	-	-	-	-

	is lower than or equal to 0.930.				
2	SS creates one or more PDCP SDUs for transport block 1 and 2 depending on $TB_{size\#1}$ and $TB_{size\#2}$, in accordance with Table 7.1.7.1.6.3.2-2.	-	-	-	-
3	SS transmits the PDCP SDUs for transport block 1 and 2 concatenated into a MAC PDU per transport block and indicates on PDCCH DCI Format 2A with RA type 1 and a resource block assignment (RBA) correspondent to N_{PRB} as specified in 7.1.6.1 in TS 36.213, transport block to codeword swap flag value set to '1' and modulation and coding scheme $I_{MCS\#1}$ for transport block 1 and $I_{MCS\#2}$ for transport block 2. . The N PDCP SDUs are split between MAC PDU 1 and 2;	<--	Transport block 1: MAC PDU Transport block 2: MAC PDU DCI: (DCI Format 2A, RA type 1, RBA(N_{PRB}), Transport block to codeword swap flag value set to='1', $I_{MCS\#1}$, $I_{MCS\#2}$)	-	-
3a	SS transmits one or more UL Grants sufficient for transmitting loop back PDCP SDUs.	<--	(UL Grant)	-	-
4	CHECK: Does UE return the same number of PDCP SDUs with same content as transmitted by the SS in step 3?	-->	(N_1 x PDCP SDUs, N_2 x PDCP SDUs)	1	P

7.1.7.1.6.3.3 Specific Message Contents

Table 7.1.7.1.6.3.3-1: UECapabilityInformation (Preamble Table 4.5.2.3-1 [18]: Step 13)

Derivation Path: 36.508 table 4.6.1-23			
Information Element	Value/remark	Comment	Condition
UECapabilityInformation ::= SEQUENCE {			
criticalExtensions CHOICE {			
c1 CHOICE{			
ueCapabilityInformation-r8 SEQUENCE {			
ue-CapabilityRAT-ContainerList SEQUENCE (SIZE (1..maxRAT-Capabilities)) OF SEQUENCE {	1 entry		
ueCapabilityRAT-Container			
ue-EUTRA-Capability SEQUENCE {			
ue-Category	Checked against UE Category indications in the PICS		
}			
}			
}			
}			
}			
}			

7.1.7.2 UL-SCH transport block size support

7.1.7.2.1 UL-SCH transport block size selection / DCI format 0

7.1.7.2.1.1 Test Purpose (TP)

(1)

```
with { UE in E-UTRA RRC_CONNECTED state }
ensure that {
  when { UE has pending data for transmission and receives a Resource Block Assignment correspondent
to  $N_{PRB}$  physical resource blocks and a modulation and coding scheme  $I_{MCS}$  for PUSCH scheduling }
  then { UE transmits MAC PDU on PUSCH on the granted resources using a transport block size
correspondent to the read  $N_{PRB}$  and  $I_{MCS}$  }
}
```

7.1.7.2.1.2 Conformance requirements

References: The conformance requirements covered in the current TC are specified in: TS 36.212, clause 5.3.3.1.1; TS 36.213, clauses 8.1, 8.6, 8.6.1, 8.6.2 and 7.1.7.2.1; TS 36.211, clause 5.3.3; and TS 36.306 clause 4.1.

[TS 36.212 clause 5.3.3.1.1]

DCI format 0 is used for the scheduling of PUSCH.

The following information is transmitted by means of the DCI format 0:

- Flag for format0/format1A differentiation – 1 bit, where value 0 indicates format 0 and value 1 indicates format 1A
- Hopping flag – 1 bit as defined in section 8.4 of [3]
- Resource block assignment and hopping resource allocation – $\left\lceil \log_2(N_{RB}^{UL}(N_{RB}^{UL} + 1)/2) \right\rceil$ bits
 - For PUSCH hopping:
 - N_{UL_hop} MSB bits are used to obtain the value of $\tilde{n}_{PRB}(i)$ as indicated in subclause [8.4] of [3]
 - $\left(\left\lceil \log_2(N_{RB}^{UL}(N_{RB}^{UL} + 1)/2) \right\rceil - N_{UL_hop} \right)$ bits provide the resource allocation of the first slot in the UL subframe
 - For non-hopping PUSCH:
 - $\left(\left\lceil \log_2(N_{RB}^{UL}(N_{RB}^{UL} + 1)/2) \right\rceil \right)$ bits provide the resource allocation in the UL subframe as defined in section 8.1 of [3]
- Modulation and coding scheme and redundancy version – 5 bits as defined in section 8.6 of [3]

[TS 36.213 clause 8.1]

The resource allocation information indicates to a scheduled UE a set of contiguously allocated virtual resource block indices denoted by n_{VRB} . A resource allocation field in the scheduling grant consists of a resource indication value (RIV) corresponding to a starting resource block (RB_{START}) and a length in terms of contiguously allocated resource blocks ($L_{CRBs} \geq 1$). The resource indication value is defined by

if $(L_{CRBs} - 1) \leq \left\lfloor N_{RB}^{UL} / 2 \right\rfloor$ then

$$RIV = N_{RB}^{UL} (L_{CRBs} - 1) + RB_{START}$$

else

$$RIV = N_{RB}^{UL} (N_{RB}^{UL} - L_{CRBs} + 1) + (N_{RB}^{UL} - 1 - RB_{START})$$

A UE shall discard PUSCH resource allocation in the corresponding PDCCH with DCI format 0 if consistent control information is not detected.

[TS 36.213 clause 8.6]

To determine the modulation order, redundancy version and transport block size for the physical uplink shared channel, the UE shall first

- read the 5-bit “modulation and coding scheme and redundancy version” field (I_{MCS}) in the DCI, and
- check the “CQI request” bit in DCI, and
- compute the total number of allocated PRBs (N_{PRB}) based on the procedure defined in Section 8.1, and
- compute the number of coded symbols for control information..

[TS 36.213 clause 8.6.1]

For $0 \leq I_{MCS} \leq 28$, the modulation order (Q_m) is determined as follows:

- If the UE is capable of supporting 64QAM in PUSCH and has not been configured by higher layers to transmit only QPSK and 16QAM, the modulation order is given by Q_m in Table 8.6.1-1.
- If the UE is not capable of supporting 64QAM in PUSCH or has been configured by higher layers to transmit only QPSK and 16QAM, Q_m is first read from Table 8.6.1-1. The modulation order is set to $Q_m = \min(4, Q_m)$.
- If the parameter *ttiBundling* provided by higher layers is set to *TRUE*, then the resource allocation size is restricted to $N_{PRB} \leq 3$ and the modulation order is set to $Q_m = 2$.

For $29 \leq I_{MCS} \leq 31$, If $I_{MCS} = 29$, the “CQI request” bit in DCI format 0 is set to 1 and $N_{PRB} \leq 4$, the modulation order is set to $Q_m = 2$. Otherwise, the modulation order shall be determined from the DCI transported in the latest PDCCH with DCI format 0 for the same transport block using $0 \leq I_{MCS} \leq 28$. If there is no PDCCH with DCI format 0 for the same transport block using $0 \leq I_{MCS} \leq 28$, the modulation order shall be determined from

- the most recent semi-persistent scheduling assignment PDCCH, when the initial PUSCH for the same transport block is semi-persistently scheduled, or,

the random access response grant for the same transport block, when the PUSCH is initiated by the random access response grant.

The UE shall use I_{MCS} and Table 8.6.1-1 to determine the redundancy version (rv_{idx}) to use in the physical uplink shared channel.

Table 8.6.1-1: Modulation, TBS index and redundancy version table for PUSCH

MCS Index I_{MCS}	Modulation Order Q_m	TBS Index I_{TBS}	Redundancy Version RV_{idx}
0	2	0	0
1	2	1	0
2	2	2	0
3	2	3	0
4	2	4	0
5	2	5	0
6	2	6	0
7	2	7	0
8	2	8	0
9	2	9	0
10	2	10	0
11	4	10	0
12	4	11	0
13	4	12	0
14	4	13	0
15	4	14	0
16	4	15	0
17	4	16	0
18	4	17	0
19	4	18	0
20	4	19	0
21	6	19	0
22	6	20	0
23	6	21	0
24	6	22	0
25	6	23	0
26	6	24	0
27	6	25	0
28	6	26	0
29	reserved		1
30			2
31			3

[TS 36.213 clause 8.6.2]

For $0 \leq I_{MCS} \leq 28$, the UE shall first determine the TBS index (I_{TBS}) using I_{MCS} and Table 8.6.1-1. The UE shall then follow the procedure in Section 7.1.7.2.1 to determine the transport block size.

For $29 \leq I_{MCS} \leq 31$, If $I_{MCS} = 29$, the “CQI request” bit in DCI format 0 is set to 1 and $N_{PRB} \leq 4$, then there is no transport block for the UL-SCH and only the control information feedback for the current PUSCH reporting mode is transmitted by the UE. Otherwise, the transport block size shall be determined from the initial PDCCH for the same transport block using $0 \leq I_{MCS} \leq 28$. If there is no initial PDCCH with DCI format 0 for the same transport block using $0 \leq I_{MCS} \leq 28$, the transport block size shall be determined from

- the most recent semi-persistent scheduling assignment PDCCH, when the initial PUSCH for the same transport block is semi-persistently scheduled, or,
- the random access response grant for the same transport block, when the PUSCH is initiated by the random access response grant.

[TS 36.213 clause 7.1.7.2.1]

For $1 \leq N_{PRB} \leq 110$, the TBS is given by the (I_{TBS}, N_{PRB}) entry of Table 7.1.7.2.1-1.

Table 7.1.7.2.1-1: Transport block size table (dimension 27x110)

I_{TBS}	N_{PRB}									
	1	2	3	4	5	6	7	8	9	10
0	16	32	56	88	120	152	176	208	224	256
1	24	56	88	144	176	208	224	256	328	344
2	32	72	144	176	208	256	296	328	376	424
3	40	104	176	208	256	328	392	440	504	568
4	56	120	208	256	328	408	488	552	632	696
5	72	144	224	328	424	504	600	680	776	872
6	328	176	256	392	504	600	712	808	936	1032
7	104	224	328	472	584	712	840	968	1096	1224
8	120	256	392	536	680	808	968	1096	1256	1384
9	136	296	456	616	776	936	1096	1256	1416	1544
10	144	328	504	680	872	1032	1224	1384	1544	1736
11	176	376	584	776	1000	1192	1384	1608	1800	2024
12	208	440	680	904	1128	1352	1608	1800	2024	2280
13	224	488	744	1000	1256	1544	1800	2024	2280	2536
14	256	552	840	1128	1416	1736	1992	2280	2600	2856
15	280	600	904	1224	1544	1800	2152	2472	2728	3112
16	328	632	968	1288	1608	1928	2280	2600	2984	3240
17	336	696	1064	1416	1800	2152	2536	2856	3240	3624
18	376	776	1160	1544	1992	2344	2792	3112	3624	4008
19	408	840	1288	1736	2152	2600	2984	3496	3880	4264
20	440	904	1384	1864	2344	2792	3240	3752	4136	4584
21	488	1000	1480	1992	2472	2984	3496	4008	4584	4968
22	520	1064	1608	2152	2664	3240	3752	4264	4776	5352
23	552	1128	1736	2280	2856	3496	4008	4584	5160	5736
24	584	1192	1800	2408	2984	3624	4264	4968	5544	5992
25	616	1256	1864	2536	3112	3752	4392	5160	5736	6200
26	712	1480	2216	2984	3752	4392	5160	5992	6712	7480

I_{TBS}	N_{PRB}									
	11	12	13	14	15	16	17	18	19	20
0	288	328	344	376	392	424	456	488	504	536
1	376	424	456	488	520	568	600	632	680	712
2	472	520	568	616	648	696	744	776	840	872
3	616	680	744	808	872	904	968	1032	1096	1160
4	776	840	904	1000	1064	1128	1192	1288	1352	1416
5	968	1032	1128	1224	1320	1384	1480	1544	1672	1736
6	1128	1224	1352	1480	1544	1672	1736	1864	1992	2088
7	1320	1480	1608	1672	1800	1928	2088	2216	2344	2472
8	1544	1672	1800	1928	2088	2216	2344	2536	2664	2792
9	1736	1864	2024	2216	2344	2536	2664	2856	2984	3112
10	1928	2088	2280	2472	2664	2792	2984	3112	3368	3496
11	2216	2408	2600	2792	2984	3240	3496	3624	3880	4008
12	2472	2728	2984	3240	3368	3624	3880	4136	4392	4584
13	2856	3112	3368	3624	3880	4136	4392	4584	4968	5160
14	3112	3496	3752	4008	4264	4584	4968	5160	5544	5736
15	3368	3624	4008	4264	4584	4968	5160	5544	5736	6200
16	3624	3880	4264	4584	4968	5160	5544	5992	6200	6456
17	4008	4392	4776	5160	5352	5736	6200	6456	6712	7224
18	4392	4776	5160	5544	5992	6200	6712	7224	7480	7992
19	4776	5160	5544	5992	6456	6968	7224	7736	8248	8504
20	5160	5544	5992	6456	6968	7480	7992	8248	8760	9144
21	5544	5992	6456	6968	7480	7992	8504	9144	9528	9912
22	5992	6456	6968	7480	7992	8504	9144	9528	10296	10680
23	6200	6968	7480	7992	8504	9144	9912	10296	11064	11448
24	6712	7224	7992	8504	9144	9912	10296	11064	11448	12216
25	6968	7480	8248	8760	9528	10296	10680	11448	12216	12576
26	8248	8760	9528	10296	11064	11832	12576	13536	14112	14688

I_{TBS}	N_{PRB}									
	21	22	23	24	25	26	27	28	29	30

0	568	600	616	648	680	712	744	776	776	808
1	744	776	808	872	904	936	968	1000	1032	1064
2	936	968	1000	1064	1096	1160	1192	1256	1288	1320
3	1224	1256	1320	1384	1416	1480	1544	1608	1672	1736
4	1480	1544	1608	1736	1800	1864	1928	1992	2088	2152
5	1864	1928	2024	2088	2216	2280	2344	2472	2536	2664
6	2216	2280	2408	2472	2600	2728	2792	2984	2984	3112
7	2536	2664	2792	2984	3112	3240	3368	3368	3496	3624
8	2984	3112	3240	3368	3496	3624	3752	3880	4008	4264
9	3368	3496	3624	3752	4008	4136	4264	4392	4584	4776
10	3752	3880	4008	4264	4392	4584	4776	4968	5160	5352
11	4264	4392	4584	4776	4968	5352	5544	5736	5992	5992
12	4776	4968	5352	5544	5736	5992	6200	6456	6712	6712
13	5352	5736	5992	6200	6456	6712	6968	7224	7480	7736
14	5992	6200	6456	6968	7224	7480	7736	7992	8248	8504
15	6456	6712	6968	7224	7736	7992	8248	8504	8760	9144
16	6712	7224	7480	7736	7992	8504	8760	9144	9528	9912
17	7480	7992	8248	8760	9144	9528	9912	10296	10296	10680
18	8248	8760	9144	9528	9912	10296	10680	11064	11448	11832
19	9144	9528	9912	10296	10680	11064	11448	12216	12576	12960
20	9912	10296	10680	11064	11448	12216	12576	12960	13536	14112
21	10680	11064	11448	12216	12576	12960	13536	14112	14688	15264
22	11448	11832	12576	12960	13536	14112	14688	15264	15840	16416
23	12216	12576	12960	13536	14112	14688	15264	15840	16416	16992
24	12960	13536	14112	14688	15264	15840	16416	16992	17568	18336
25	13536	14112	14688	15264	15840	16416	16992	17568	18336	19080
26	15264	16416	16992	17568	18336	19080	19848	20616	21384	22152

I_{TBS}	N_{PRB}									
	31	32	33	34	35	36	37	38	39	40
0	840	872	904	936	968	1000	1032	1032	1064	1096
1	1128	1160	1192	1224	1256	1288	1352	1384	1416	1416
2	1384	1416	1480	1544	1544	1608	1672	1672	1736	1800
3	1800	1864	1928	1992	2024	2088	2152	2216	2280	2344
4	2216	2280	2344	2408	2472	2600	2664	2728	2792	2856
5	2728	2792	2856	2984	3112	3112	3240	3368	3496	3496
6	3240	3368	3496	3496	3624	3752	3880	4008	4136	4136
7	3752	3880	4008	4136	4264	4392	4584	4584	4776	4968
8	4392	4584	4584	4776	4968	4968	5160	5352	5544	5544
9	4968	5160	5160	5352	5544	5736	5736	5992	6200	6200
10	5544	5736	5736	5992	6200	6200	6456	6712	6712	6968
11	6200	6456	6712	6968	6968	7224	7480	7736	7736	7992
12	6968	7224	7480	7736	7992	8248	8504	8760	8760	9144
13	7992	8248	8504	8760	9144	9144	9528	9912	9912	10296
14	8760	9144	9528	9912	9912	10296	10680	11064	11064	11448
15	9528	9912	10296	10296	10680	11064	11448	11832	11832	12216
16	9912	10296	10680	11064	11448	11832	12216	12216	12576	12960
17	11064	11448	11832	12216	12576	12960	13536	13536	14112	14688
18	12216	12576	12960	13536	14112	14112	14688	15264	15264	15840
19	13536	13536	14112	14688	15264	15264	15840	16416	16992	16992
20	14688	14688	15264	15840	16416	16992	16992	17568	18336	18336
21	15840	15840	16416	16992	17568	18336	18336	19080	19848	19848
22	16992	16992	17568	18336	19080	19080	19848	20616	21384	21384
23	17568	18336	19080	19848	19848	20616	21384	22152	22152	22920
24	19080	19848	19848	20616	21384	22152	22920	22920	23688	24496
25	19848	20616	20616	21384	22152	22920	23688	24496	24496	25456
26	22920	23688	24496	25456	25456	26416	27376	28336	29296	29296

I_{TBS}	N_{PRB}									
	41	42	43	44	45	46	47	48	49	50
0	1128	1160	1192	1224	1256	1256	1288	1320	1352	1384
1	1480	1544	1544	1608	1608	1672	1736	1736	1800	1800
2	1800	1864	1928	1992	2024	2088	2088	2152	2216	2216
3	2408	2472	2536	2536	2600	2664	2728	2792	2856	2856
4	2984	2984	3112	3112	3240	3240	3368	3496	3496	3624

5	3624	3752	3752	3880	4008	4008	4136	4264	4392	4392
6	4264	4392	4584	4584	4776	4776	4968	4968	5160	5160
7	4968	5160	5352	5352	5544	5736	5736	5992	5992	6200
8	5736	5992	5992	6200	6200	6456	6456	6712	6968	6968
9	6456	6712	6712	6968	6968	7224	7480	7480	7736	7992
10	7224	7480	7480	7736	7992	7992	8248	8504	8504	8760
11	8248	8504	8760	8760	9144	9144	9528	9528	9912	9912
12	9528	9528	9912	9912	10296	10680	10680	11064	11064	11448
13	10680	10680	11064	11448	11448	11832	12216	12216	12576	12960
14	11832	12216	12216	12576	12960	12960	13536	13536	14112	14112
15	12576	12960	12960	13536	13536	14112	14688	14688	15264	15264
16	13536	13536	14112	14112	14688	14688	15264	15840	15840	16416
17	14688	15264	15264	15840	16416	16416	16992	17568	17568	18336
18	16416	16416	16992	17568	17568	18336	18336	19080	19080	19848
19	17568	18336	18336	19080	19080	19848	20616	20616	21384	21384
20	19080	19848	19848	20616	20616	21384	22152	22152	22920	22920
21	20616	21384	21384	22152	22920	22920	23688	24496	24496	25456
22	22152	22920	22920	23688	24496	24496	25456	25456	26416	27376
23	23688	24496	24496	25456	25456	26416	27376	27376	28336	28336
24	25456	25456	26416	26416	27376	28336	28336	29296	29296	30576
25	26416	26416	27376	28336	28336	29296	29296	30576	31704	31704
26	30576	30576	31704	32856	32856	34008	35160	35160	36696	36696

I_{TBS}	N_{PRB}									
	51	52	53	54	55	56	57	58	59	60
0	1416	1416	1480	1480	1544	1544	1608	1608	1608	1672
1	1864	1864	1928	1992	1992	2024	2088	2088	2152	2152
2	2280	2344	2344	2408	2472	2536	2536	2600	2664	2664
3	2984	2984	3112	3112	3240	3240	3368	3368	3496	3496
4	3624	3752	3752	3880	4008	4008	4136	4136	4264	4264
5	4584	4584	4776	4776	4776	4968	4968	5160	5160	5352
6	5352	5352	5544	5736	5736	5992	5992	5992	6200	6200
7	6200	6456	6456	6712	6712	6712	6968	6968	7224	7224
8	7224	7224	7480	7480	7736	7736	7992	7992	8248	8504
9	7992	8248	8248	8504	8760	8760	9144	9144	9144	9528
10	9144	9144	9144	9528	9528	9912	9912	10296	10296	10680
11	10296	10680	10680	11064	11064	11448	11448	11832	11832	12216
12	11832	11832	12216	12216	12576	12576	12960	12960	13536	13536
13	12960	13536	13536	14112	14112	14688	14688	14688	15264	15264
14	14688	14688	15264	15264	15840	15840	16416	16416	16992	16992
15	15840	15840	16416	16416	16992	16992	17568	17568	18336	18336
16	16416	16992	16992	17568	17568	18336	18336	19080	19080	19848
17	18336	19080	19080	19848	19848	20616	20616	20616	21384	21384
18	19848	20616	21384	21384	22152	22152	22920	22920	23688	23688
19	22152	22152	22920	22920	23688	24496	24496	25456	25456	25456
20	23688	24496	24496	25456	25456	26416	26416	27376	27376	28336
21	25456	26416	26416	27376	27376	28336	28336	29296	29296	30576
22	27376	28336	28336	29296	29296	30576	30576	31704	31704	32856
23	29296	29296	30576	30576	31704	31704	32856	32856	34008	34008
24	31704	31704	32856	32856	34008	34008	35160	35160	36696	36696
25	32856	32856	34008	34008	35160	35160	36696	36696	37888	37888
26	37888	37888	39232	40576	40576	40576	42368	42368	43816	43816

I_{TBS}	N_{PRB}									
	61	62	63	64	65	66	67	68	69	70
0	1672	1736	1736	1800	1800	1800	1864	1864	1928	1928
1	2216	2280	2280	2344	2344	2408	2472	2472	2536	2536
2	2728	2792	2856	2856	2856	2984	2984	3112	3112	3112
3	3624	3624	3624	3752	3752	3880	3880	4008	4008	4136
4	4392	4392	4584	4584	4584	4776	4776	4968	4968	4968
5	5352	5544	5544	5736	5736	5736	5992	5992	5992	6200
6	6456	6456	6456	6712	6712	6968	6968	6968	7224	7224
7	7480	7480	7736	7736	7992	7992	8248	8248	8504	8504
8	8504	8760	8760	9144	9144	9144	9528	9528	9528	9912
9	9528	9912	9912	10296	10296	10296	10680	10680	11064	11064

10	10680	11064	11064	11448	11448	11448	11832	11832	12216	12216
11	12216	12576	12576	12960	12960	13536	13536	13536	14112	14112
12	14112	14112	14112	14688	14688	15264	15264	15264	15840	15840
13	15840	15840	16416	16416	16992	16992	16992	17568	17568	18336
14	17568	17568	18336	18336	18336	19080	19080	19848	19848	19848
15	18336	19080	19080	19848	19848	20616	20616	20616	21384	21384
16	19848	19848	20616	20616	21384	21384	22152	22152	22152	22920
17	22152	22152	22920	22920	23688	23688	24496	24496	24496	25456
18	24496	24496	24496	25456	25456	26416	26416	27376	27376	27376
19	26416	26416	27376	27376	28336	28336	29296	29296	29296	30576
20	28336	29296	29296	29296	30576	30576	31704	31704	31704	32856
21	30576	31704	31704	31704	32856	32856	34008	34008	35160	35160
22	32856	34008	34008	34008	35160	35160	36696	36696	36696	37888
23	35160	35160	36696	36696	37888	37888	37888	39232	39232	40576
24	36696	37888	37888	39232	39232	40576	40576	42368	42368	42368
25	39232	39232	40576	40576	40576	42368	42368	43816	43816	43816
26	45352	45352	46888	46888	48936	48936	48936	51024	51024	52752

I_{TBS}	N_{PRB}									
	71	72	73	74	75	76	77	78	79	80
0	1992	1992	2024	2088	2088	2088	2152	2152	2216	2216
1	2600	2600	2664	2728	2728	2792	2792	2856	2856	2856
2	3240	3240	3240	3368	3368	3368	3496	3496	3496	3624
3	4136	4264	4264	4392	4392	4392	4584	4584	4584	4776
4	5160	5160	5160	5352	5352	5544	5544	5544	5736	5736
5	6200	6200	6456	6456	6712	6712	6712	6968	6968	6968
6	7480	7480	7736	7736	7736	7992	7992	8248	8248	8248
7	8760	8760	8760	9144	9144	9144	9528	9528	9528	9912
8	9912	9912	10296	10296	10680	10680	10680	11064	11064	11064
9	11064	11448	11448	11832	11832	11832	12216	12216	12576	12576
10	12576	12576	12960	12960	12960	13536	13536	13536	14112	14112
11	14112	14688	14688	14688	15264	15264	15840	15840	15840	16416
12	16416	16416	16416	16992	16992	17568	17568	17568	18336	18336
13	18336	18336	19080	19080	19080	19848	19848	19848	20616	20616
14	20616	20616	20616	21384	21384	22152	22152	22152	22920	22920
15	22152	22152	22152	22920	22920	23688	23688	23688	24496	24496
16	22920	23688	23688	24496	24496	24496	25456	25456	25456	26416
17	25456	26416	26416	26416	27376	27376	27376	28336	28336	29296
18	28336	28336	29296	29296	29296	30576	30576	30576	31704	31704
19	30576	30576	31704	31704	32856	32856	32856	34008	34008	34008
20	32856	34008	34008	34008	35160	35160	35160	36696	36696	36696
21	35160	36696	36696	36696	37888	37888	39232	39232	39232	40576
22	37888	39232	39232	40576	40576	40576	42368	42368	42368	43816
23	40576	40576	42368	42368	43816	43816	43816	45352	45352	45352
24	43816	43816	45352	45352	45352	46888	46888	46888	48936	48936
25	45352	45352	46888	46888	46888	48936	48936	48936	51024	51024
26	52752	52752	55056	55056	55056	55056	57336	57336	57336	59256

I_{TBS}	N_{PRB}									
	81	82	83	84	85	86	87	88	89	90
0	2280	2280	2280	2344	2344	2408	2408	2472	2472	2536
1	2984	2984	2984	3112	3112	3112	3240	3240	3240	3240
2	3624	3624	3752	3752	3880	3880	3880	4008	4008	4008
3	4776	4776	4776	4968	4968	4968	5160	5160	5160	5352
4	5736	5992	5992	5992	5992	6200	6200	6200	6456	6456
5	7224	7224	7224	7480	7480	7480	7736	7736	7736	7992
6	8504	8504	8760	8760	8760	9144	9144	9144	9144	9528
7	9912	9912	10296	10296	10296	10680	10680	10680	11064	11064
8	11448	11448	11448	11832	11832	12216	12216	12216	12576	12576
9	12960	12960	12960	13536	13536	13536	13536	14112	14112	14112
10	14112	14688	14688	14688	14688	15264	15264	15264	15840	15840
11	16416	16416	16992	16992	16992	17568	17568	17568	18336	18336
12	18336	19080	19080	19080	19080	19848	19848	19848	20616	20616
13	20616	21384	21384	21384	22152	22152	22152	22920	22920	22920
14	22920	23688	23688	24496	24496	24496	25456	25456	25456	25456

15	24496	25456	25456	25456	26416	26416	26416	27376	27376	27376
16	26416	26416	27376	27376	27376	28336	28336	28336	29296	29296
17	29296	29296	30576	30576	30576	30576	31704	31704	31704	32856
18	31704	32856	32856	32856	34008	34008	34008	35160	35160	35160
19	35160	35160	35160	36696	36696	36696	37888	37888	37888	39232
20	37888	37888	39232	39232	39232	40576	40576	40576	42368	42368
21	40576	40576	42368	42368	42368	43816	43816	43816	45352	45352
22	43816	43816	45352	45352	45352	46888	46888	46888	48936	48936
23	46888	46888	46888	48936	48936	48936	51024	51024	51024	51024
24	48936	51024	51024	51024	52752	52752	52752	52752	55056	55056
25	51024	52752	52752	52752	55056	55056	55056	55056	57336	57336
26	59256	59256	61664	61664	61664	63776	63776	63776	66592	66592

I_{TBS}	N_{PRB}									
	91	92	93	94	95	96	97	98	99	100
0	2536	2536	2600	2600	2664	2664	2728	2728	2728	2792
1	3368	3368	3368	3496	3496	3496	3496	3624	3624	3624
2	4136	4136	4136	4264	4264	4264	4392	4392	4392	4584
3	5352	5352	5352	5544	5544	5544	5736	5736	5736	5736
4	6456	6456	6712	6712	6712	6968	6968	6968	6968	7224
5	7992	7992	8248	8248	8248	8504	8504	8760	8760	8760
6	9528	9528	9528	9912	9912	9912	10296	10296	10296	10296
7	11064	11448	11448	11448	11448	11832	11832	11832	12216	12216
8	12576	12960	12960	12960	13536	13536	13536	13536	14112	14112
9	14112	14688	14688	14688	15264	15264	15264	15264	15840	15840
10	15840	16416	16416	16416	16992	16992	16992	16992	17568	17568
11	18336	18336	19080	19080	19080	19080	19848	19848	19848	19848
12	20616	21384	21384	21384	21384	22152	22152	22152	22920	22920
13	23688	23688	23688	24496	24496	24496	25456	25456	25456	25456
14	26416	26416	26416	27376	27376	27376	28336	28336	28336	28336
15	28336	28336	28336	29296	29296	29296	29296	30576	30576	30576
16	29296	30576	30576	30576	30576	31704	31704	31704	31704	32856
17	32856	32856	34008	34008	34008	35160	35160	35160	35160	36696
18	36696	36696	36696	37888	37888	37888	37888	39232	39232	39232
19	39232	39232	40576	40576	40576	40576	42368	42368	42368	43816
20	42368	42368	43816	43816	43816	45352	45352	45352	46888	46888
21	45352	46888	46888	46888	46888	48936	48936	48936	48936	51024
22	48936	48936	51024	51024	51024	51024	52752	52752	52752	55056
23	52752	52752	52752	55056	55056	55056	55056	57336	57336	57336
24	55056	57336	57336	57336	57336	59256	59256	59256	61664	61664
25	57336	59256	59256	59256	61664	61664	61664	61664	63776	63776
26	66592	68808	68808	68808	71112	71112	71112	73712	73712	75376

I_{TBS}	N_{PRB}									
	101	102	103	104	105	106	107	108	109	110
0	2792	2856	2856	2856	2984	2984	2984	2984	2984	3112
1	3752	3752	3752	3752	3880	3880	3880	4008	4008	4008
2	4584	4584	4584	4584	4776	4776	4776	4776	4968	4968
3	5992	5992	5992	5992	6200	6200	6200	6200	6456	6456
4	7224	7224	7480	7480	7480	7480	7736	7736	7736	7992
5	8760	9144	9144	9144	9144	9528	9528	9528	9528	9528
6	10680	10680	10680	10680	11064	11064	11064	11448	11448	11448
7	12216	12576	12576	12576	12960	12960	12960	12960	13536	13536
8	14112	14112	14688	14688	14688	14688	15264	15264	15264	15264
9	15840	16416	16416	16416	16416	16992	16992	16992	16992	17568
10	17568	18336	18336	18336	18336	18336	19080	19080	19080	19080
11	20616	20616	20616	21384	21384	21384	21384	22152	22152	22152
12	22920	23688	23688	23688	23688	24496	24496	24496	24496	25456
13	26416	26416	26416	26416	27376	27376	27376	27376	28336	28336
14	29296	29296	29296	29296	30576	30576	30576	30576	31704	31704
15	30576	31704	31704	31704	31704	32856	32856	32856	34008	34008
16	32856	32856	34008	34008	34008	34008	35160	35160	35160	35160
17	36696	36696	36696	37888	37888	37888	39232	39232	39232	39232
18	40576	40576	40576	40576	42368	42368	42368	42368	43816	43816
19	43816	43816	43816	45352	45352	45352	46888	46888	46888	46888

20	46888	46888	48936	48936	48936	48936	48936	51024	51024	51024
21	51024	51024	51024	52752	52752	52752	52752	55056	55056	55056
22	55056	55056	55056	57336	57336	57336	57336	59256	59256	59256
23	57336	59256	59256	59256	59256	61664	61664	61664	61664	63776
24	61664	61664	63776	63776	63776	63776	66592	66592	66592	66592
25	63776	63776	66592	66592	66592	66592	68808	68808	68808	71112
26	75376	75376	75376	75376	75376	75376	75376	75376	75376	75376

[TS 36.211 clause 5.3.3]

The block of complex-valued symbols $d(0), \dots, d(M_{\text{symb}} - 1)$ is divided into $M_{\text{symb}}/M_{\text{sc}}^{\text{PUSCH}}$ sets, each corresponding to one SC-FDMA symbol. Transform precoding shall be applied according to

$$z(l \cdot M_{\text{sc}}^{\text{PUSCH}} + k) = \frac{1}{\sqrt{M_{\text{sc}}^{\text{PUSCH}}}} \sum_{i=0}^{M_{\text{sc}}^{\text{PUSCH}} - 1} d(l \cdot M_{\text{sc}}^{\text{PUSCH}} + i) e^{-j \frac{2\pi i k}{M_{\text{sc}}^{\text{PUSCH}}}}$$

$$k = 0, \dots, M_{\text{sc}}^{\text{PUSCH}} - 1$$

$$l = 0, \dots, M_{\text{symb}}/M_{\text{sc}}^{\text{PUSCH}} - 1$$

resulting in a block of complex-valued symbols $z(0), \dots, z(M_{\text{symb}} - 1)$. The variable $M_{\text{sc}}^{\text{PUSCH}} = M_{\text{RB}}^{\text{PUSCH}} \cdot N_{\text{sc}}^{\text{RB}}$, where $M_{\text{RB}}^{\text{PUSCH}}$ represents the bandwidth of the PUSCH in terms of resource blocks, and shall fulfil

$$M_{\text{RB}}^{\text{PUSCH}} = 2^{\alpha_2} \cdot 3^{\alpha_3} \cdot 5^{\alpha_5} \leq N_{\text{RB}}^{\text{UL}}$$

where $\alpha_2, \alpha_3, \alpha_5$ is a set of non-negative integers.

[TS 36.306 clause 4.1]

The field *ue-Category* defines a combined uplink and downlink capability. The parameters set by the UE Category are defined in subclause 4.2. Tables 4.1-1 and 4.1-2 define the downlink and, respectively, uplink physical layer parameter values for each UE Category.

Table 4.1-1: Downlink physical layer parameter values set by the field *ue-Category*

UE Category	Maximum number of DL-SCH transport block bits received within a TTI	Maximum number of bits of a DL-SCH transport block received within a TTI	Total number of soft channel bits	Maximum number of supported layers for spatial multiplexing in DL
Category 1	10296	10296	250368	1
Category 2	51024	51024	1237248	2
Category 3	102048	75376	1237248	2
Category 4	150752	75376	1827072	2
Category 5	299552	149776	3667200	4

Table 4.1-2: Uplink physical layer parameter values set by the field *ue-Category*

UE Category	Maximum number of bits of an UL-SCH transport block transmitted within a TTI	Support for 64QAM in UL
Category 1	5160	No
Category 2	25456	No
Category 3	51024	No
Category 4	51024	No
Category 5	75376	Yes

7.1.7.2.1.3 Test description

7.1.7.2.1.3.1 Pre-test conditions

System Simulator:

- Cell 1.
- Uplink and downlink bandwidth set to the maximum bandwidth for the E-UTRA Band under test as specified in Table 5.6.1-1 in [31](to enable testing of N_{PRB} up to maximum value). For Band 18, Band 19 and Band 25, based on industry requirement, uplink and downlink bandwidth set to 10MHz.

UE:

None.

Preamble:

- The UE is in state Loopback Activated (state 4) according to [18].

7.1.7.2.1.3.2 Test procedure sequence

Table 7.1.7.2.1.3.2-1: Maximum TB_{size} for different UE categories

UE Category	Maximum number of bits of an UL-SCH transport block transmitted within a TTI
Category 1	5160
Category 2	25456
Category 3	51024
Category 4	51024
Category 5	75376

Table 7.1.7.2.1.3.2-2: Number of downlink PDCP SDUs and PDCP SDU size used as test data

TB_{size} [bits]	Number of PDCP SDUs, N_{SDUs}	PDCP SDU size [bits] See note 1
104 ≤ TB _{size} ≤ 12096 note 2	1	8*FLOOR((TB _{size} - 96)/8)
12097 ≤ TB _{size} ≤ 24128	2	8*FLOOR((TB _{size} - 128)/16))
24129 ≤ TB _{size} ≤ 36152	3	8*FLOOR((TB _{size} - 152)/24))
36153 ≤ TB _{size} ≤ 48184	4	8*FLOOR((TB _{size} - 184)/32))
48185 ≤ TB _{size} ≤ 60208	5	8*FLOOR((TB _{size} - 208)/40))
60209 ≤ TB _{size} ≤ 72240	6	8*FLOOR((TB _{size} - 240)/48))
TB _{size} > 72240	7	8*FLOOR((TB _{size} - 264)/56))

Note 1: Each PDCP SDU is limited to 1500 octets (to keep below maximum SDU size of ESM as specified in TS 24.301 clause 9.9.4.12).

N PDCP SDUs are transmitted in N AMD PDUs concatenated into a MAC PDU. The PDCP SDU size of each PDCP SDU is

PDCP SDU size = (TB_{size} - N*PDCP header size - N*AMD PDU header size - MAC header - Size of Timing Advance - RLC Status PDU size) / N, where

PDCP header size is 16 bits for the RLC AM and 12-bit SN case;
 AMD PDU header size is 16 bits;
 MAC header size is 40 bits as MAC header size can be:

1) R/R/E/LCID MAC subheader (8 bits for Timing Advance) + R/R/E/LCID MAC subheader (16 bits for MAC SDU for RLC Status PDU) + R/R/E/LCID MAC subheader (8 bits for MAC SDU for AMD PDU) = 8 + 16 + 8 bits = 32 bits
 or

2) R/R/E/LCID MAC subheader (8 bits for Timing Advance) + R/R/E/LCID MAC subheader (24 bits for MAC SDU for AMD PDU, Note: Length can be of 2 bytes depending upon the size of AMD PDU) + R/R/E/LCID MAC subheader (8 bits for MAC SDU for RLC Status PDU) = 8 + 24 + 8 bits = 40 bits

Therefore Maximum MAC header size can be 40 bits

Size of Timing Advance MAC CE is 8 bits (if no Timing Advance and/or RLC status needs to be sent, padding will occur instead)

RLC Status PDU size = 16 bit size =

This gives:

PDCP SDU size = 8*FLOOR((TB_{size} - N*16 - 8*CEL((16+(N-1)*12)/8) - 64)/(8*N)) bits.

Note 2: According to TS 36.213 Table 7.1.7.2.1-1 and the final PDCP SDU size formula in Note 1, the smallest TB_{size} that can be tested is 104 bits.

Table 7.1.7.2.1.3.2-2a: Bandwidth Dependent Parameters

Max Bandwidth	Max N_{PRB}
10 Mhz	50
15 Mhz	75
20 Mhz	100

Note: Maximum bandwidth for EUTRA bands is 10/15/20 Mhz.

Table 7.1.7.2.1.3.2-3: Main behaviour

St	Procedure	Message Sequence		TP	Verdict
		U - S	Message		
1	The SS ignores scheduling requests and does not allocate any uplink grant.	-	-	-	-
-	EXCEPTION: Steps 2 to 7 are	-	-	-	-

	repeated for values of N_{PRB} from 1 to Max N_{PRB} and I_{MCS} from 0 to 28, where N_{PRB} satisfies values equal to $2^{\alpha_2} \cdot 3^{\alpha_3} \cdot 5^{\alpha_5} \leq N_{\text{RB}}^{\text{UL}}$ and where $\alpha_2, \alpha_3, \alpha_5$ is a set of non-negative integers.				
2	SS looks up I_{TBS} in table 8.6.1-1 in TS 36.213 based on the value of I_{MCS} . SS looks up TB_{size} in table 7.1.7.2.1-1 in TS 36.213 based on values of N_{PRB} and I_{TBS} .	-	-	-	-
-	EXCEPTION: Steps 3 to 7 are performed if TB_{size} is less than or equal to UE capability "Maximum number of UL-SCH transport block bits received within a TTI" as specified in Table 7.1.7.2.1.3.2-1 and larger than or equal to 104 bits as specified in Table 7.1.7.2.1.3.2-2.	-	-	-	-
3	SS creates one or more PDCP SDUs, depending on TB_{size} , in accordance with Table 7.1.7.2.1.3.2-2.	-	-	-	-
4	After 300ms, the SS transmits all PDCP SDUs (N_{SDUs}) as created in step 3 in a MAC PDU.	<--	MAC PDU ($N_{\text{SDUs}} \times \text{PDCP SDU}$)	-	-
5	After 60ms of step 4, the allocates an uplink grant SS indicating DCI Format 0 with a RVI correspondent to N_{PRB} as specified in 8.1 in TS 36.213 and modulation and coding scheme I_{MCS} as specified in Table 8.6.1-1 in TS 36.213.	<--	(UL Grant) DCI: (DCI Format 0, RVI (N_{PRB}), I_{MCS})	-	-
6	Void	-	-	-	-
7	CHECK: Does UE return the same number of PDCP SDUs with same content as transmitted by the SS in step 4 using the Resource Block Assignment and modulation and coding scheme as configured by the SS in step 5?	-->	MAC PDU ($N_{\text{SDUs}} \times \text{PDCP SDU}$)	1	P

7.1.7.2.1.3.3 Specific Message Contents

Table 7.1.7.2.1.3.3-1: UECapabilityInformation (Preamble Table 4.5.2.3-1 [18]: Step 13)

Derivation Path: 36.508 table 4.6.1-23			
Information Element	Value/remark	Comment	Condition
UECapabilityInformation ::= SEQUENCE {			
criticalExtensions CHOICE {			
c1 CHOICE{			
ueCapabilityInformation-r8 SEQUENCE {			
ue-CapabilityRAT-ContainerList SEQUENCE	1 entry		
(SIZE (1..maxRAT-Capabilities)) OF SEQUENCE {			
ueCapabilityRAT-Container			
ue-EUTRA-Capability SEQUENCE {			
ue-Category	Checked against UE Category indications in the PICS		
}			
}			
}			
}			
}			
}			

7.1.8 Reporting of Rank Indicator (RI)

7.1.8.1 Periodic RI reporting using PUCCH / Category 1 UE / Transmission mode 3/4

7.1.8.1.1 Test Purpose (TP)

(1)

```
with { UE in E-UTRA RRC_CONNECTED state }
ensure that {
  when { Category 1 UE is configured to transmission mode 3 }
  then { UE always reports RI equals to one }
}
```

(2)

```
with { UE in E-UTRA RRC_CONNECTED state }
ensure that {
  when { Category 1 UE is configured to transmission mode 4 }
  then { UE always reports RI equals to one }
}
```

7.1.8.1.2 Conformance requirements

References: The conformance requirements covered in the present TC are specified in: TS 36.306 clause 4 and clause 4.1, TS 36.213 clause 7.2.2.

[TS 36.306, clause 4]

The following subclauses define the UE radio access capability parameters. Only parameters for which there is the possibility for UEs to signal different values are considered as UE radio access capability parameters. Therefore, mandatory capabilities that are the same for all UEs are not listed here.

[TS 36.306, clause 4.1]

The field *ue-Category* defines a combined uplink and downlink capability. The parameters set by the UE Category are defined in subclause 4.2. Tables 4.1-1 and 4.1-2 define the downlink and, respectively, uplink physical layer parameter values for each UE Category.

Table 4.1-1: Downlink physical layer parameter values set by the field *ue-Category*

UE Category	Maximum number of DL-SCH transport block bits received within a TTI	Maximum number of bits of a DL-SCH transport block received within a TTI	Total number of soft channel bits	Maximum number of supported layers for spatial multiplexing in DL
Category 1	10296	10296	250368	1
Category 2	51024	51024	1237248	2
Category 3	102048	75376	1237248	2
Category 4	150752	75376	1827072	2
Category 5	299552	149776	3667200	4

[TS 36.213, clause 7.2.2]

A UE is semi-statically configured by higher layers to periodically feed back different CQI, PMI, and RI on the PUCCH using the reporting modes given in Table 7.2.2-1 and described below.

Table 7.2.2-1: CQI and PMI Feedback Types for PUCCH reporting Modes

		PMI Feedback Type	
		No PMI	Single PMI
PUCCH CQI Feedback Type	Wideband (wideband CQI)	Mode 1-0	Mode 1-1
	UE Selected (subband CQI)	Mode 2-0	Mode 2-1

For each of the transmission modes defined in Section 7.1, the following reporting modes are supported on PUCCH:

- Transmission mode 1 : Modes 1-0, 2-0
- Transmission mode 2 : Modes 1-0, 2-0
- Transmission mode 3 : Modes 1-0, 2-0
- Transmission mode 4 : Modes 1-1, 2-1
- Transmission mode 5 : Modes 1-1, 2-1
- Transmission mode 6 : Modes 1-1, 2-1
- Transmission mode 7 : Modes 1-0, 2-0
- Transmission mode 8 : Modes 1-1, 2-1 if the UE is configured with PMI/RI reporting; modes 1-0, 2-0 if the UE is configured without PMI/RI reporting

Four CQI/PMI and RI reporting types with distinct periods and offsets are supported for each PUCCH reporting mode as given in Table 7.2.2-3:

- Type 1 report supports CQI feedback for the UE selected sub-bands
- Type 2 report supports wideband CQI and PMI feedback.
- Type 3 report supports RI feedback
- Type 4 report supports wideband CQI

The periodicity N_p (in subframes) and offset $N_{OFFSET,CQI}$ (in subframes) for CQI/PMI reporting are determined based on the parameter *cqi-pmi-ConfigIndex* ($I_{CQI/PMI}$) given in Table 7.2.2-1A for FDD and table 7.2.2-1C for TDD. The periodicity M_{RI} and relative offset $N_{OFFSET,RI}$ for RI reporting are determined based on the parameter *ri-ConfigIndex* (I_{RI}) given in

Table 7.2.2-1B. Both *cqi-pmi-ConfigIndex* and *ri-ConfigIndex* are configured by higher layer signalling. The relative reporting offset for RI $N_{OFFSET,RI}$ takes values from the set $\{0, -1, \dots, -(N_p - 1)\}$

- Wideband feedback

- Mode 1-1 description:

- In the subframe where RI is reported (only for transmission mode 4 and transmission mode 8):

- A UE shall determine a RI assuming transmission on set S subbands.

- The UE shall report a type 3 report consisting of one RI

- In the subframe where CQI/PMI is reported:

- A single precoding matrix is selected from the codebook subset assuming transmission on set S subbands

- A UE shall report a type 2 report on each respective successive reporting opportunity consisting of

- A single wideband CQI value which is calculated assuming the use of a single precoding matrix in all subbands and transmission on set S subbands.

- The selected single precoding matrix indicator (wideband PMI)

- When $RI > 1$, a 3-bit wideband spatial differential CQI, which is shown in Table 7.2-2.

- For transmission mode 4 and transmission mode 8, the PMI and CQI are calculated conditioned on the last reported periodic RI. For other transmission modes they are calculated conditioned on transmission rank 1.

7.1.8.1.3 Test description

7.1.8.1.3.1 Pre-test conditions

System Simulator:

- Cell 1
- System Simulator transmits according to the rank reported by UE

UE:

None.

Preamble:

- The UE is in state Generic RB Established (state 3) according to [18]

7.1.8.1.3.2 Test procedure sequence

Table 7.1.8.1.3.2-1: Main behaviour

St	Procedure	Message Sequence		TP	Verdict
		U - S	Message		
-	EXCEPTION: Step 1 is repeated 5 times	-	-	-	-
1	CHECK: Does the UE transmit PUCCH type 3 report with RI set to 1? (NOTE)	-->	(RI)	1	P
2	The SS transmits a MAC PDU containing an <i>RRCCONNECTIONRECONFIGURATION</i> message to reconfigure the UE transmission mode to tm4	<--	MAC PDU (<i>RRCCONNECTIONRECONFIGURATION</i>)	-	-
3	The UE transmits a MAC PDU containing an <i>RRCCONNECTIONRECONFIGURATIONCOMPLETE</i> message	-->	MAC PDU (<i>RRCCONNECTIONRECONFIGURATIONCOMPLETE</i>)	-	-
-	EXCEPTION: Step 4 is repeated 5 times	-	-	-	-
4	CHECK: Does the UE transmit PUCCH type 3 report with RI set to 1? (NOTE)	-->	(RI)	2	P
5	Check: Does the test result of CALL generic procedure in TS 36.508 subclause 6.4.2.3 indicate that UE is in E-UTRA RRC_CONNECTED state?	-	-	2	-

Note: In this test case, it is configured for wideband CQI/PMI reporting for transmission mode tm3 and tm4, the reporting instances of RI reporting are subframes satisfying:
 $(10 \times n_f + \lfloor n_s / 2 \rfloor - N_{OFFSET,CQI} - N_{OFFSET,RI}) \bmod (N_p \cdot M_{RI}) = 0$ the default configuration in TS 36.508, the $cqi-pmi-ConfigIndex(I_{CQI/PMI}) = 25(\text{FDD})/24(\text{TDD})$, $ri-ConfigIndex(I_{RI}) = 483(\text{FDD}) / 484(\text{TDD})$, as per the Table 7.2.2-1A, 7.2.2-1B and 7.2.2-1C in TS 36.213, the periodicity N_p (in subframes) = 20ms(FDD) / 20ms(TDD), $N_{OFFSET,CQI}$ (in subframes) = 8ms(FDD) / 8ms(TDD), The periodicity $M_{RI} = 8(\text{FDD}) / 8(\text{TDD})$ and relative offset $N_{OFFSET,RI} = 0(\text{FDD}) / -1(\text{TDD})$

7.1.8.1.3.3 Specific message contents

Table 7.1.8.1.3.3-1: RRCCONNECTIONRECONFIGURATION (step 2, Table 7.1.8.1.3.2-1)

Derivation Path: 36.508 table 4.6.1-8, condition SRB2-DRB(1, 0)

Table 7.1.8.1.3.3-2: PhysicalConfigDedicated-DEFAULT (step 2, Table 7.1.8.1.3.2-1)

Derivation Path: 36.331 clause 6.3.2			
Information Element	Value/remark	Comment	Condition
PhysicalConfigDedicated-DEFAULT ::= SEQUENCE {			
antennaInfo CHOICE {			
defaultValue	NULL		
explicitValue SEQUENCE {			2TX
transmissionMode	tm4		
codebookSubsetRestriction CHOICE {			
n2TxAntenna-tm4	'111111'	BIT STRING (SIZE (6))	
}			
ue-TransmitAntennaSelection CHOICE {			
Release	NULL		
}			
}			

7.1.9 Activation/Deactivation of SCells

7.1.9.1 CA / Activation/Deactivation of SCells / Activation/Deactivation MAC control element reception / sCellDeactivationTimer

7.1.9.1.1 CA / Activation/Deactivation of SCells / Activation/Deactivation MAC control element reception / sCellDeactivationTimer / Intra-band Contiguous CA

7.1.9.1.1.1 Test Purpose (TP)

(1)

```
with { UE in E-UTRA RRC_CONNECTED state with SCell configure }
ensure that {
  when { the UE receives an Activation MAC Control Element activating the SCell }
  then { the UE starts monitoring PDCCH on activated SCell }
}
```

(2)

```
with { UE in E-UTRA RRC_CONNECTED state with SCell activated }
ensure that {
  when { the UE receives an UL grant on SCell PDCCH }
  then { the UE restarts the sCellDeactivationTimer }
}
```

(3)

```
with { UE in E-UTRA RRC_CONNECTED state with SCell activated }
ensure that {
  when { the UE sCellDeactivationTimer expires }
  then { the UE deactivates the SCell and stops monitoring PDCCH on SCell }
}
```

(4)

```
with { UE in E-UTRA RRC_CONNECTED state with SCell Activated }
ensure that {
  when { the UE receives a deactivation MAC Control Element deactivating the SCell }
  then { the UE deactivates the SCell and stops monitoring PDCCH on SCell }
}
```

(5)

```
with { UE in E-UTRA RRC_CONNECTED state with SCell activated }
ensure that {
  when { the UE receives a DL assignment on SCell PDCCH }
  then { the UE restarts the sCellDeactivationTimer }
}
```

7.1.9.1.1.2 Conformance requirements

References: The conformance requirements covered in the current TC are specified in: TS 36.321, clause 5.13 & 6.1.3.8.

[TS 36.321, clause 5.13]

If the UE is configured with one or more SCells, the network may activate and deactivate the configured SCells. The PCell is always activated. The network activates and deactivates the SCell(s) by sending the Activation/Deactivation MAC control element described in subclause 6.1.3.8. Furthermore, the UE maintains a *sCellDeactivationTimer* timer per configured SCell and deactivates the associated SCell upon its expiry. The same initial timer value applies to each instance of the *sCellDeactivationTimer* and it is configured by RRC. The configured SCells are initially deactivated upon addition and after a handover.

The UE shall for each TTI and for each configured SCell:

- if the UE receives an Activation/Deactivation MAC control element in this TTI activating the SCell, the UE shall in the TTI according to the timing defined in [2]:

- activate the SCell; i.e. apply normal SCell operation including:
 - SRS transmissions on the SCell;
 - CQI/PMI/RI/PTI reporting for the SCell;
 - PDCCH monitoring on the SCell;
 - PDCCH monitoring for the SCell
- start or restart the *sCellDeactivationTimer* associated with the SCell;
- else, if the UE receives an Activation/Deactivation MAC control element in this TTI deactivating the SCell; or
- if the *sCellDeactivationTimer* associated with the activated SCell expires in this TTI:
 - in the TTI according to the timing defined in [2]:
 - deactivate the SCell;
 - stop the *sCellDeactivationTimer* associated with the SCell;
 - flush all HARQ buffers associated with the SCell.
- if PDCCH on the activated SCell indicates an uplink grant or downlink assignment; or
- if PDCCH on the Serving Cell scheduling the activated SCell indicates an uplink grant or a downlink assignment for the activated SCell:
 - restart the *sCellDeactivationTimer* associated with the SCell;
- if the SCell is deactivated:
 - not transmit SRS on the SCell;
 - not report CQI/PMI/RI/PTI for the SCell;
 - not transmit on UL-SCH on the SCell;
 - not monitor the PDCCH on the SCell;
 - not monitor the PDCCH for the SCell.

[TS 36.321, clause 6.1.3.8]

The Activation/Deactivation MAC control element is identified by a MAC PDU subheader with LCID as specified in table 6.2.1-1. It has a fixed size and consists of a single octet containing seven C-fields and one R-field. The Activation/Deactivation MAC control element is defined as follows (figure 6.1.3.8-1).

- C_i : if there is an SCell configured with *SCellIndex* i as specified in [8], this field indicates the activation/deactivation status of the SCell with *SCellIndex* i , else the UE shall ignore the C_i field. The C_i field is set to "1" to indicate that the SCell with *SCellIndex* i shall be activated. The C_i field is set to "0" to indicate that the SCell with *SCellIndex* i shall be deactivated;
- R: Reserved bit, set to "0".

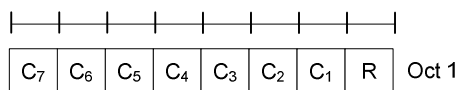

Figure 6.1.3.8-1: Activation/Deactivation MAC control element

7.1.9.1.1.3 Test description

7.1.9.1.1.3.1 Pre-test conditions

System Simulator:

- Cell 1 (PCell) and Cell 3(SCell)
- Cell 3 is an Active SCell according to [18] cl. 6.3.4.

UE:

None.

Preamble:

- The UE is in state Loopback Activated (state 4) on Cell 1 according to [18].

7.1.9.1.1.3.2 Test procedure sequence

Table 7.1.9.1.1.3.2-1: Time instances of cell power level and parameter changes

	Parameter	Unit	Cell 1	Cell 3
T0	Cell-specific RS EPRE	dBm/15k Hz	-85	-85

Table 7.1.9.1.1.3.2-2: Main behaviour

St	Procedure	Message Sequence		TP	Verdict
		U - S	Message		
1	The SS transmits an <i>RRConnectionReconfiguration</i> message containing a <i>sCellToAddModList</i> on Cell 1 with SCell (Cell 3) addition.	<--	<i>RRConnectionReconfiguration</i>	-	-
2	The UE transmit an <i>RRConnectionReconfigurationComplete</i> message.	-->	<i>RRConnectionReconfigurationComplete</i>	-	-
3	The SS transmits Activation MAC control element to activate Scell (Cell 3).	<--	MAC PDU (Activation (C ₁ =1))	-	-
4	200 ms after step 3, the SS indicates a new transmission on PDCCH of CC ₂ and transmits a MAC PDU (containing an RLC PDU)	<--	MAC PDU (CC ₂)	-	-
5	Check: Does the UE transmit a Scheduling Request on PUCCH?	-->	(SR)	1	P
6	The SS sends an UL grant suitable for transmitting loop back PDU on Cell 1.	<--	(UL Grant)	-	-
7	The UE transmit a MAC PDU containing the loop back PDU corresponding to step 4	-->	MAC PDU	-	-
7a	The SS transmits a MAC PDU containing RLC status PDU acknowledging reception of RLC PDU in step 7	<--	MAC PDU (CC ₁)	-	-
8	200 ms after step 6, the SS indicates a new transmission on PDCCH of CC ₂ and transmits a MAC PDU (containing an RLC PDU)	<--	MAC PDU (CC ₂)	-	-
9	Check: Does the UE transmit a Scheduling Request on PUCCH?	-->	(SR)	2	P
10	The SS sends an UL grant suitable for transmitting loop back PDU on Cell 1.	<--	(UL Grant)	-	-
11	The UE transmit a MAC PDU containing the loop back PDU corresponding to step 8	-->	MAC PDU	-	-
12	The SS transmits a MAC PDU containing RLC status PDU acknowledging reception of RLC PDU in step 11	<--	MAC PDU (CC ₁)	-	-
13	400 ms after step 10, the SS indicates a new transmission on PDCCH of CC ₂ and transmits a MAC PDU (containing an RLC PDU)	<--	MAC PDU (CC ₂)	-	-
14	Check: Does the UE transmit a Scheduling Request on PUCCH in next 1 second?	-->	(SR)	3	F
15	The SS transmits Activation MAC control element to activate Scell (Cell 3).	<--	MAC PDU (Activation (C ₁ =1))	-	-
16	200 ms after step 15 The SS indicates a new transmission on PDCCH of CC ₂ and transmits a MAC PDU (containing just padding or RLC status PDU, but no RLC data PDU)	<--	MAC PDU (CC ₂)	-	-
17	400 ms after step 15 the SS indicates a new transmission on PDCCH of CC ₂ and transmits a MAC PDU (containing an RLC PDU)	<--	MAC PDU (CC ₂)	-	-
18	Check: Does the UE transmit a Scheduling Request on PUCCH?	-->	(SR)	1,5	P
19	The SS sends an UL grant suitable for transmitting loop back PDU on Cell 1.	<--	(UL Grant)	-	-
19	The UE transmit a MAC PDU containing the loop back PDU corresponding to step 17	-->	MAC PDU	-	-
20	The SS transmits a MAC PDU containing RLC status PDU acknowledging reception of RLC PDU in step 19	<--	MAC PDU (CC ₁)	-	-
21	The SS transmits Deactivation MAC control element to de-activate Scell (Cell 3).	<--	MAC PDU (Deactivation (C ₁ =0))	-	-
22	The SS indicates a new transmission on PDCCH of CC ₂ and transmits a MAC PDU (containing an RLC PDU)	<--	MAC PDU (CC ₂)	-	-
23	Check: Does the UE transmit a Scheduling Request on PUCCH in next 1 second?	-->	(SR)	4	F

7.1.9.1.3.3 Specific message contents

Table 7.1.9.1.1.3.3-1: RRCConnectionReconfiguration (Table 7.1.9.1.1.3.2-1, step 1)

Derivation path: 36.508 table 4.6.1-8 condition SCell_AddMod			
Information Element	Value/Remark	Comment	Condition
RRCConnectionReconfiguration ::= SEQUENCE {			
criticalExtensions CHOICE {			
c1 CHOICE{			
rrcConnectionReconfiguration-r8 SEQUENCE {			
RadioResourceConfigDedicated SEQUENCE {			
mac-MainConfig CHOICE {			
explicit	MAC-MainConfig-RBC		
}			
}			
}			
}			
}			
}			

Table 7.1.9.1.1.3.3-2: MAC-MainConfig-RBC (Table 7.1.9.1.1.3.3-1)

Derivation path: 36.508 table 4.8.2.1.5-1 condition DRX_L			
Information Element	Value/Remark	Comment	Condition
MAC-MainConfig-RBC SEQUENCE {			
timeAlignmentTimerDedicated	Infinity		
mac-MainConfig-v1020 SEQUENCE {			
sCellDeactivationTimer-r10	rf32	320 milliseconds	
}			
}			

Table 7.1.9.1.1.3.3-3: SCellToAddMod-r10 (Table 7.1.9.1.1.3.3-1)

Derivation Path: 36.508, Table 4.6.3-19D			
Information Element	Value/remark	Comment	Condition
SCellToAddMod-r10 ::= SEQUENCE {			
sCellIndex-r10	1		
cellIdentification-r10 SEQUENCE {			
physCellId-r10	PhysicalCellIdentity of Cell 3		
dl-CarrierFreq-r10	Same downlink EARFCN as used for Cell 3		
}			
}			

7.1.9.1.2 CA / Activation/Deactivation of SCells / Activation/Deactivation MAC control element reception / sCellDeactivationTimer / Inter-band CA

The scope and description of the present TC is the same as test case 7.1.9.1.1 with the following differences:

- CA configuration: Inter-band CA replaces Intra-band Contiguous CA.
- Cells configuration: Cell 10 replaces Cell 3.
- Cell 10 is an Active SCell according to [18] cl. 6.3.4.

7.2 RLC

7.2.1 General

For UM tests, the UM test DRB is set up using the Generic Procedure described in clause 4.5 of [18], with the parameters described in clause 4.8.2.1.3.1 of [18], except for the tests that explicitly specify a different DRB configuration.

For AM tests, the AM test DRB is set up using the Generic Procedure described in clause 4.5 of [18], with the parameters described in clause 4.8.2.1.3.2 of [18], except for the tests that explicitly specify a different DRB configuration.

Unless specified otherwise in the test procedure sequence, the data field of each RLC PDU transmitted by the SS contains a complete RLC SDU.

7.2.2 Unacknowledged mode

7.2.2.1 UM RLC / Segmentation and reassembly / 5-bit SN / Framing info field

7.2.2.1.1 Test Purpose (TP)

(1)

```
with { UE in E-UTRA RRC_CONNECTED state }
ensure that {
  when { UE receives a 5 bit SN configured UMD PDU containing a FI field set to 00 }
  then { UE correctly decodes the received UMD PDU }
}
```

(2)

```
with { UE in E-UTRA RRC_CONNECTED state }
ensure that {
  when { UE receives a 5 bit SN configured UMD PDU containing a FI field set to 01 }
  then { UE correctly decodes the received UMD PDU }
}
```

(3)

```
with { UE in E-UTRA RRC_CONNECTED state }
ensure that {
  when { UE receives a 5 bit SN configured UMD PDU containing a FI field set to 11 }
  then { UE correctly decodes the received UMD PDU }
}
```

(4)

```
with { UE in E-UTRA RRC_CONNECTED state }
ensure that {
  when { UE receives a 5 bit SN configured UMD PDU containing a FI field set to 10 }
  then { UE correctly decodes the received UMD PDU }
}
```

7.2.2.1.2 Conformance requirements

References: The conformance requirements covered in the present TC are specified in: TS 36.322, clause 6.2.1.3 and 6.2.2.6.

[TS 36.322, clause 6.2.1.3]

...

An UM RLC entity is configured by RRC to use either a 5 bit SN or a 10 bit SN. When the 5 bit SN is configured, the length of the fixed part of the UMD PDU header is one byte. When the 10 bit SN is configured, the fixed part of the UMD PDU header is identical to the fixed part of the AMD PDU header, except for D/C, RF and P fields all being replaced with R1 fields. The extension part of the UMD PDU header is identical to the extension part of the AMD PDU header (regardless of the configured SN size).

...

[TS 36.322, clause 6.2.2.6]

Length: 2 bits.

The FI field indicates whether a RLC SDU is segmented at the beginning and/or at the end of the Data field. Specifically, the FI field indicates whether the first byte of the Data field corresponds to the first byte of a RLC SDU, and whether the last byte of the Data field corresponds to the last byte of a RLC SDU. The interpretation of the FI field is provided in Table 6.2.2.6-1.

Table 6.2.2.6-1: FI field interpretation

Value	Description
00	First byte of the Data field corresponds to the first byte of a RLC SDU. Last byte of the Data field corresponds to the last byte of a RLC SDU.
01	First byte of the Data field corresponds to the first byte of a RLC SDU. Last byte of the Data field does not correspond to the last byte of a RLC SDU.
10	First byte of the Data field does not correspond to the first byte of a RLC SDU. Last byte of the Data field corresponds to the last byte of a RLC SDU.
11	First byte of the Data field does not correspond to the first byte of a RLC SDU. Last byte of the Data field does not correspond to the last byte of a RLC SDU.

7.2.2.1.3 Test description

7.2.2.1.3.1 Pre-test conditions

System Simulator:

- Cell 1.

UE:

None.

Preamble:

- The UE is in state Loopback Activated (state 4) according to [18] with the exceptions listed in table 7.2.2.1.3.1-1 applicable for the configured UM DRB.
- The condition SRB2-DRB(1,1) is used for step 8 in 4.5.3A.3 according to [18].

Table 7.2.2.1.3.1-1: RLC parameters

Uplink RLC sn-FieldLength	size5
Downlink RLC sn-FieldLength	size5

7.2.2.1.3.2 Test procedure sequence

Table 7.2.2.1.3.2-1: Main behaviour

St	Procedure	Message Sequence		TP	Verdict
		U - S	Message		
1	The SS transmits UMD PDU#1 containing a complete RLC SDU#1 (FI field = 00).	<--	UMD PDU#1	-	-
2	Check: Does the UE transmit RLC SDU#1?	-->	(RLC SDU#1)	1	P
3	The SS transmits UMD PDU#2 containing the first segment of RLC SDU#2 (FI field = 01).	<--	UMD PDU#2	-	-
4	The SS transmits UMD PDU#3 containing the second segment of RLC SDU#2 (FI field = 11).	<--	UMD PDU#3	-	-
5	The SS transmits UMD PDU#4 containing the last segment of RLC SDU#2 (FI field = 10).	<--	UMD PDU#4	-	-
6	Check: Does the UE transmit RLC SDU#2?	-->	(RLC SDU#2)	2,3, 4	P

7.2.2.1.3.3 Specific message contents

None.

7.2.2.2 UM RLC / Segmentation and reassembly / 10-bit SN / Framing info field

7.2.2.2.1 Test Purpose (TP)

(1)

```
with { UE in E-UTRA RRC_CONNECTED state }
ensure that {
  when { UE receives a 10 bit SN configured UMD PDU containing a FI field set to 00 }
  then { UE correctly decodes the received UMD PDU }
}
```

(2)

```
with { UE in E-UTRA RRC_CONNECTED state }
ensure that {
  when { UE receives a 10 bit SN configured UMD PDU containing a FI field set to 01 }
  then { UE correctly decodes the received UMD PDU }
}
```

(3)

```
with { UE in E-UTRA RRC_CONNECTED state }
ensure that {
  when { UE receives a 10 bit SN configured UMD PDU containing a FI field set to 11 }
  then { UE correctly decodes the received UMD PDU }
}
```

(4)

```
with { UE in E-UTRA RRC_CONNECTED state }
ensure that {
  when { UE receives a 10 bit SN configured UMD PDU containing a FI field set to 10 }
  then { UE correctly decodes the received UMD PDU }
}
```

7.2.2.2.2 Conformance requirements

References: The conformance requirements covered in the present TC are specified in: TS 36.322, clause 6.2.1.3 and 6.2.2.6.

[TS 36.322, clause 6.2.1.3]

...

An UM RLC entity is configured by RRC to use either a 5 bit SN or a 10 bit SN. When the 5 bit SN is configured, the length of the fixed part of the UMD PDU header is one byte. When the 10 bit SN is configured, the fixed part of the UMD PDU header is identical to the fixed part of the AMD PDU header, except for D/C, RF and P fields all being

replaced with R1 fields. The extension part of the UMD PDU header is identical to the extension part of the AMD PDU header (regardless of the configured SN size).

...

[TS 36.322, clause 6.2.2.6]

Length: 2 bits.

The FI field indicates whether a RLC SDU is segmented at the beginning and/or at the end of the Data field. Specifically, the FI field indicates whether the first byte of the Data field corresponds to the first byte of a RLC SDU, and whether the last byte of the Data field corresponds to the last byte of a RLC SDU. The interpretation of the FI field is provided in Table 6.2.2.6-1.

Table 6.2.2.6-1: FI field interpretation

Value	Description
00	First byte of the Data field corresponds to the first byte of a RLC SDU. Last byte of the Data field corresponds to the last byte of a RLC SDU.
01	First byte of the Data field corresponds to the first byte of a RLC SDU. Last byte of the Data field does not correspond to the last byte of a RLC SDU.
10	First byte of the Data field does not correspond to the first byte of a RLC SDU. Last byte of the Data field corresponds to the last byte of a RLC SDU.
11	First byte of the Data field does not correspond to the first byte of a RLC SDU. Last byte of the Data field does not correspond to the last byte of a RLC SDU.

7.2.2.2.3 Test description

7.2.2.2.3.1 Pre-test conditions

System Simulator:

- Cell 1.

UE:

None.

Preamble:

- The UE is in state Loopback Activated (state 4) according to [18].
- The condition SRB2-DRB(1,1) is used for step 8 in 4.5.3A.3 according to [18].

7.2.2.2.3.2 Test procedure sequence

Table 7.2.2.2.3.2-1: Main behaviour

St	Procedure	Message Sequence		TP	Verdict
		U - S	Message		
1	The SS transmits UMD PDU#1 containing a complete RLC SDU#1 (FI field = 00).	<--	UMD PDU#1	-	-
2	Check: Does the UE transmit RLC SDU#1?	-->	(RLC SDU#1)	1	P
3	The SS transmits UMD PDU#2 containing the first segment of RLC SDU#2 (FI field = 01).	<--	UMD PDU#2	-	-
4	The SS transmits UMD PDU#3 containing the second segment of RLC SDU#2 (FI field = 11).	<--	UMD PDU#3	-	-
5	The SS transmits UMD PDU#4 containing the last segment of RLC SDU#2 (FI field = 10).	<--	UMD PDU#4	-	-
6	Check: Does the UE transmit RLC SDU#2?	-->	(RLC SDU#2)	2, 3, 4	P

7.2.2.2.3.3 Specific message contents

None.

7.2.2.3 UM RLC / Reassembly / 5-bit SN / LI value > PDU size

7.2.2.3.1 Test Purpose (TP)

(1)

```
with { UE in E-UTRA RRC_CONNECTED state }
ensure that {
  when { UE receives a 5 bit SN configured RLC PDU with Length Indicator value larger than RLC PDU
size }
  then { UE discards the RLC PDU }
}
```

7.2.2.3.2 Conformance requirements

See TS 36.322 clauses 6.2.2.5 and 5.5.1

References: The conformance requirements covered in the present TC are specified in: TS 36.322, clause 5.5.1 and 6.2.2.5.

[TS 36.322, clause 5.5.1]

When an RLC entity receives an RLC PDU that contains reserved or invalid values, the RLC entity shall:

- discard the received PDU.

[TS 36.322, clause 6.2.2.5]

Length: 11 bits.

The LI field indicates the length in bytes of the corresponding Data field element present in the RLC data PDU delivered/received by an UM or an AM RLC entity. The first LI present in the RLC data PDU header corresponds to the first Data field element present in the Data field of the RLC data PDU, the second LI present in the RLC data PDU header corresponds to the second Data field element present in the Data field of the RLC data PDU, and so on. The value 0 is reserved.

7.2.2.3.3 Test description

7.2.2.3.3.1 Pre-test conditions

System Simulator:

- Cell 1.

UE:

None.

Preamble:

- The UE is in state Loopback Activated (state 4) according to [18] with the exceptions listed in table 7.2.2.3.3.1-1 applicable for the configured UM DRB.
- The condition SRB2-DRB(1,1) is used for step 8 in 4.5.3A.3 according to [18].

Table 7.2.2.3.3.1-1: RLC parameters

Uplink RLC sn-FieldLength	size5
Downlink RLC sn-FieldLength	size5

7.2.2.3.3.2 Test procedure sequence

Table 7.2.2.3.3.2-1: Main behaviour

St	Procedure	Message Sequence		TP	Verdict
		U - S	Message		
-	EXCEPTION: the behaviour described in table 7.2.2.3.3.2-2 runs in parallel with steps 1 to 5 below.	-	-	-	-
1	The SS transmits UMD PDU#1 containing first segment of RLC SDU#1.	<--	UMD PDU#1 (SN=0)	-	-
2	The SS transmits UMD PDU#2 containing last segment of RLC SDU#1 and first segment of RLC SDU#2.	<--	UMD PDU#2 (SN=1)	-	-
3	The SS transmits UMD PDU#3 containing last segment of RLC SDU#2, first segment of RLC SDU#3 and with Length Indicator that points beyond the end of the UMD PDU#3.	<--	UMD PDU#3 (SN=2)	-	-
4	The SS transmits UMD PDU#4 containing last segment of RLC SDU#3.	<--	UMD PDU#4 (SN=3)	-	-
5	The SS transmits UMD PDU#5 containing RLC SDU#4.	<--	UMD PDU#5 (SN=4)	-	-

Table 7.2.2.3.3.2-2: Parallel behaviour

St	Procedure	Message Sequence		TP	Verdict
		U - S	Message		
1	The UE transmits RLC SDU#1.	-->	(RLC SDU#1)	-	-
2	Check: Does the UE transmit RLC SDU#2?	-->	(RLC SDU#2)	1	F
3	Check: Does the UE transmit RLC SDU#3?	-->	(RLC SDU#3)	1	F
4	The UE transmits RLC SDU#4.	-->	(RLC SDU#4)	-	-

7.2.2.3.3.3 Specific message contents

None.

7.2.2.4 UM RLC / Reassembly / 10-bit SN / LI value > PDU size

7.2.2.4.1 Test Purpose (TP)

(1)

```
with { UE in E-UTRA RRC_CONNECTED state }
ensure that {
  when { UE receives an RLC PDU with Length Indicator value larger than RLC PDU size }
  then { UE discards the RLC PDU }
}
```

7.2.2.4.2 Conformance requirements

References: The conformance requirements covered in the present TC are specified in: TS 36.322, clause 5.5.1.

[TS 36.322, clause 5.5.1]

When an RLC entity receives an RLC PDU that contains reserved or invalid values, the RLC entity shall:

- discard the received PDU.

7.2.2.4.3 Test description

7.2.2.4.3.1 Pre-test conditions

System Simulator:

- Cell 1.

UE:

None.

Preamble:

- The UE is in state Loopback Activated (state 4) according to [18].
- The condition SRB2-DRB(1,1) is used for step 8 in 4.5.3A.3 according to [18].

7.2.2.4.3.2 Test procedure sequence

Table 7.2.2.4.3.2-1: Main behaviour

St	Procedure	Message Sequence		TP	Verdict
		U - S	Message		
-	EXCEPTION: The behaviour described in table 7.2.2.4.3.2-2 runs in parallel with steps 1 to 5 below.	-	-	-	-
1	The SS transmits UMD PDU#1 containing first segment of RLC SDU#1.	<--	UMD PDU#1 (SN=0)	-	-
2	The SS transmits UMD PDU#2 containing last segment of RLC SDU#1 and first segment of RLC SDU#2.	<--	UMD PDU#2 (SN=1)	-	-
3	The SS transmits UMD PDU#3 containing last segment of RLC SDU#2, first segment of RLC SDU#3 and with Length Indicator that points beyond the end of the RLC PDU#3.	<--	UMD PDU#3 (SN=2)	-	-
4	The SS transmits UMD PDU#4 containing last segment of RLC SDU#3.	<--	UMD PDU#4 (SN=3)	-	-
5	The SS transmits UMD PDU#5 containing RLC SDU#4.	<--	UMD PDU#5 (SN=4)	-	-

Table 7.2.2.4.3.2-2: Parallel behaviour

St	Procedure	Message Sequence		TP	Verdict
		U - S	Message		
1	Check: Does the UE transmit RLC SDU#1?	-->	(RLC SDU#1)	1	P
2	Check: Does the UE transmit RLC SDU#2?	-->	(RLC SDU#2)	1	F
3	Check: Does the UE transmit RLC SDU#3?	-->	(RLC SDU#3)	1	F
4	Check: Does the UE transmit RLC SDU#4?	-->	(RLC SDU#4)	1	P

7.2.2.4.3.3 Specific message contents

None.

7.2.2.5 UM RLC / Correct use of sequence numbering

7.2.2.5.1 UM RLC / 5-bit SN / Correct use of sequence numbering

7.2.2.5.1.1 Test Purpose (TP)

(1)

```
with { UE in E-UTRA RRC_CONNECTED state }
ensure that {
  when { UE transmits the first PDU }
  then { UE sets the sequence Number field equal to 0 }
}
```

(2)

```
with { UE in E-UTRA RRC_CONNECTED state }
ensure that {
  when { UE transmits subsequent PDUs }
  then { SN incremented by 1 for each PDU transmitted }
}
```

(3)

```

with { UE in E-UTRA RRC_CONNECTED state and an UM RLC DRB is configured using 5 bit SN }
ensure that {
  when { UE transmits more than 32 PDUs }
  then { UE wraps the Sequence Number after transmitting the 32 PDU }
}

```

(4)

```

with { UE in E-UTRA RRC_CONNECTED state and an UM RLC DRB is configured using 5 bit SN }
ensure that {
  when { more than 32 PDUs are sent to UE }
  then { UE accepts PDUs with SNs that wrap around every 32 PDU }
}

```

7.2.2.5.1.2 Conformance requirements

References: The conformance requirements covered in the present TC are specified in: 3GPP TS 36.322, clause 5.1.2.1.1, 5.1.2.2, 6.2.1.3, 6.2.2.3 and 7.1.

[TS 36.322, clause 5.1.2.1.1]

When delivering a new UMD PDU to lower layer, the transmitting UM RLC entity shall:

- set the SN of the UMD PDU to VT(US), and then increment VT(US) by one.

[TS 36.322, clause 5.1.2.2]

The receiving UM RLC entity shall maintain a reordering window according to state variable VR(UH) as follows:

- a SN falls within the reordering window if $(VR(UH) - UM_Window_Size) \leq SN < VR(UH)$;
- a SN falls outside of the reordering window otherwise.

When receiving an UMD PDU from lower layer, the receiving UM RLC entity shall:

- either discard the received UMD PDU or place it in the reception buffer (see sub clause 5.1.2.2.2);
- if the received UMD PDU was placed in the reception buffer:
 - update state variables, reassemble and deliver RLC SDUs to upper layer and start/stop *t-Reordering* as needed (see sub clause 5.1.2.2.3);

...

When an UMD PDU with SN = x is received from lower layer, the receiving UM RLC entity shall:

- if $VR(UR) < x < VR(UH)$ and the UMD PDU with SN = x has been received before; or
- if $(VR(UH) - UM_Window_Size) \leq x < VR(UR)$:
 - discard the received UMD PDU;
- else:
 - place the received UMD PDU in the reception buffer.

...

When an UMD PDU with SN = x is placed in the reception buffer, the receiving UM RLC entity shall:

- if x falls outside of the reordering window:
 - update VR(UH) to x + 1;
 - reassemble RLC SDUs from any UMD PDUs with SN that falls outside of the reordering window, remove RLC headers when doing so and deliver the reassembled RLC SDUs to upper layer in ascending order of the RLC SN if not delivered before;
- if VR(UR) falls outside of the reordering window:

- set VR(UR) to (VR(UH) – UM_Window_Size);
- if the reception buffer contains an UMD PDU with SN = VR(UR):
 - update VR(UR) to the SN of the first UMD PDU with SN > current VR(UR) that has not been received;
 - reassemble RLC SDUs from any UMD PDUs with SN < updated VR(UR), remove RLC headers when doing so and deliver the reassembled RLC SDUs to upper layer in ascending order of the RLC SN if not delivered before;

...

[TS 36.322, clause 6.2.1.3]

...

An UM RLC entity is configured by RRC to use either a 5 bit SN or a 10 bit SN. When the 5 bit SN is configured, the length of the fixed part of the UMD PDU header is one byte. When the 10 bit SN is configured, the fixed part of the UMD PDU header is identical to the fixed part of the AMD PDU header, except for D/C, RF and P fields all being replaced with R1 fields. The extension part of the UMD PDU header is identical to the extension part of the AMD PDU header (regardless of the configured SN size).

...

[TS 36.322, clause 6.2.2.3]

...

The SN field indicates the sequence number of the corresponding UMD...The sequence number is incremented by one for every UMD...

[TS 36.322, clause 7.1]

...

All state variables and all counters are non-negative integers.

...

All state variables related to UM data transfer can take values from 0 to $2^{[sn-FieldLength]} - 1$. All arithmetic operations contained in the present document on state variables related to UM data transfer are affected by the UM modulus (i.e. final value = [value from arithmetic operation] modulo $2^{[sn-FieldLength]}$).

...

When performing arithmetic comparisons of state variables or SN values, a modulus base shall be used.

...

VR(UH) – UM_Window_Size shall be assumed as the modulus base at the receiving side of an UM RLC entity. This modulus base is subtracted from all the values involved, and then an absolute comparison is performed (e.g. (VR(UH) – UM_Window_Size) <= SN < VR(UH) is evaluated as [(VR(UH) – UM_Window_Size) – (VR(UH) – UM_Window_Size)] modulo $2^{[sn-FieldLength]}$ <= [SN – (VR(UH) – UM_Window_Size)] modulo $2^{[sn-FieldLength]}$ < [VR(UH) – (VR(UH) – UM_Window_Size)] modulo $2^{[sn-FieldLength]}$).

...

Each transmitting UM RLC entity shall maintain the following state variables:

a) VT(US)

This state variable holds the value of the SN to be assigned for the next newly generated UMD PDU. It is initially set to 0, and is updated whenever the UM RLC entity delivers an UMD PDU with SN = VT(US).

Each receiving UM RLC entity shall maintain the following state variables:

a) VR(UR) – UM receive state variable

This state variable holds the value of the SN of the earliest UMD PDU that is still considered for reordering. It is initially set to 0.

b) VR(UX) – UM t-Reordering state variable

This state variable holds the value of the SN following the SN of the UMD PDU which triggered t-Reordering.

c) VR(UH) – UM highest received state variable

This state variable holds the value of the SN following the SN of the UMD PDU with the highest SN among received UMD PDUs, and it serves as the higher edge of the reordering window. It is initially set to 0.

7.2.2.5.1.3 Test description

7.2.2.5.1.3.1 Pre-test conditions

System Simulator:

- Cell 1.

UE:

None.

Preamble:

- UE is in state Loopback Activated (state 4) according to [18] with the exceptions listed in table 7.2.2.5.1.3.1-1 applicable for the configured UM DRB.
- The condition SRB2-DRB(1,1) is used for step 8 in 4.5.3A.3 according to [18].

Table 7.2.2.5.1.3.1-1: RLC parameters

Uplink RLC sn-FieldLength	size5
Downlink RLC sn-FieldLength	size5

7.2.2.5.1.3.2 Test procedure sequence

Table 7.2.2.5.1.3.2-1: Main behaviour

St	Procedure	Message Sequence		TP	Verdict
		U - S	Message/PDU/SDU		
-	EXCEPTION: Step 3 to 4 is executed 31 times.	-	-	-	-
1	The SS transmits an UMD PDU. SN equals 0.	<--	UMD PDU	-	-
2	Check: Does the UE transmit an UMD PDU with SN = 0?	-->	UMD PDU	1	P
3	The SS transmits an UMD PDU. SN equals 1 and is incremented for each PDU transmitted.	<--	UMD PDU	-	-
4	Check: Does the UE transmit an UMD PDU with SN increased by 1 compared with the previous one?	-->	UMD PDU	2	P
5	The SS transmits an UMD PDU. SN equals 0.	<--	UMD PDU	-	-
6	Check: Does the UE transmit an UMD PDU with SN=0?	-->	UMD PDU	3, 4	P

7.2.2.5.1.3.3 Specific message contents

None.

7.2.2.5.2 UM RLC / 10-bit SN / Correct use of Sequence numbering

7.2.2.5.2.1 Test Purpose (TP)

(1)

```
with { UE in E-UTRA RRC_CONNECTED state }
ensure that {
  when { UE transmits the first PDU }
  then { UE sets the Sequence Number field equal to 0 }
}
```

(2)

```
with { UE in E-UTRA RRC_CONNECTED state }
ensure that {
  when { UE transmits subsequent PDUs }
  then { SN incremented by 1 for each PDU transmitted }
}
```

(3)

```
with { UE in E-UTRA RRC_CONNECTED state and an UM RLC DRB is configured using 10 bit SN }
ensure that {
  when { UE transmits more than 1024 PDUs }
  then { UE wraps the Sequence Number after transmitting the 1024 PDU }
}
```

(4)

```
with { UE in E-UTRA RRC_CONNECTED state and an UM RLC DRB is configured using 10 bit SN }
ensure that {
  when { more than 1024 PDUs are sent to UE }
  then { UE accepts PDUs with SNs that wrap around every 1024 PDU }
}
```

7.2.2.5.2.2 Conformance requirements

References: The conformance requirements covered in the present TC are specified in: 3GPP TS 36.322, clause 5.1.2.1.1, 5.1.2.2, 6.2.1.3, 6.2.2.3 and 7.1.

[TS 36.322, clause 5.1.2.1.1]

When delivering a new UMD PDU to lower layer, the transmitting UM RLC entity shall:

- set the SN of the UMD PDU to VT(US), and then increment VT(US) by one.

[TS 36.322, clause 5.1.2.2]

The receiving UM RLC entity shall maintain a reordering window according to state variable VR(UH) as follows:

- a SN falls within the reordering window if $(VR(UH) - UM_Window_Size) \leq SN < VR(UH)$;
- a SN falls outside of the reordering window otherwise.

When receiving an UMD PDU from lower layer, the receiving UM RLC entity shall:

- either discard the received UMD PDU or place it in the reception buffer (see sub clause 5.1.2.2.2);
- if the received UMD PDU was placed in the reception buffer:
 - update state variables, reassemble and deliver RLC SDUs to upper layer and start/stop *t-Reordering* as needed (see sub clause 5.1.2.2.3);

...

When an UMD PDU with SN = x is received from lower layer, the receiving UM RLC entity shall:

- if $VR(UR) < x < VR(UH)$ and the UMD PDU with SN = x has been received before; or
- if $(VR(UH) - UM_Window_Size) \leq x < VR(UR)$:
 - discard the received UMD PDU;

- else:
 - place the received UMD PDU in the reception buffer.

...

When an UMD PDU with SN = x is placed in the reception buffer, the receiving UM RLC entity shall:

- if x falls outside of the reordering window:
 - update VR(UH) to x + 1;
 - reassemble RLC SDUs from any UMD PDUs with SN that falls outside of the reordering window, remove RLC headers when doing so and deliver the reassembled RLC SDUs to upper layer in ascending order of the RLC SN if not delivered before;
- if VR(UR) falls outside of the reordering window:
 - set VR(UR) to (VR(UH) – UM_Window_Size);
- if the reception buffer contains an UMD PDU with SN = VR(UR):
 - update VR(UR) to the SN of the first UMD PDU with SN > current VR(UR) that has not been received;
 - reassemble RLC SDUs from any UMD PDUs with SN < updated VR(UR), remove RLC headers when doing so and deliver the reassembled RLC SDUs to upper layer in ascending order of the RLC SN if not delivered before;

...

[TS 36.322, clause 6.2.1.3]

...

An UM RLC entity is configured by RRC to use either a 5 bit SN or a 10 bit SN. When the 5 bit SN is configured, the length of the fixed part of the UMD PDU header is one byte. When the 10 bit SN is configured, the fixed part of the UMD PDU header is identical to the fixed part of the AMD PDU header, except for D/C, RF and P fields all being replaced with R1 fields. The extension part of the UMD PDU header is identical to the extension part of the AMD PDU header (regardless of the configured SN size).

...

[TS 36.322, clause 6.2.2.3]

...

The SN field indicates the sequence number of the corresponding UMD...The sequence number is incremented by one for every UMD...

[TS 36.322, clause 7.1]

...

All state variables and all counters are non-negative integers.

...

All state variables related to UM data transfer can take values from 0 to $2^{[sn-FieldLength]} - 1$. All arithmetic operations contained in the present document on state variables related to UM data transfer are affected by the UM modulus (i.e. final value = [value from arithmetic operation] modulo $2^{[sn-FieldLength]}$).

...

When performing arithmetic comparisons of state variables or SN values, a modulus base shall be used.

...

VR(UH) – UM_Window_Size shall be assumed as the modulus base at the receiving side of an UM RLC entity. This modulus base is subtracted from all the values involved, and then an absolute comparison is performed (e.g. $(VR(UH) - UM_Window_Size) \leq SN < VR(UH)$ is evaluated as $[(VR(UH) - UM_Window_Size) - (VR(UH) - UM_Window_Size)] \bmod 2^{[sn-FieldLength]} \leq [SN - (VR(UH) - UM_Window_Size)] \bmod 2^{[sn-FieldLength]} < [VR(UH) - (VR(UH) - UM_Window_Size)] \bmod 2^{[sn-FieldLength]}$).

...

Each transmitting UM RLC entity shall maintain the following state variables:

a) VT(US)

This state variable holds the value of the SN to be assigned for the next newly generated UMD PDU. It is initially set to 0, and is updated whenever the UM RLC entity delivers an UMD PDU with SN = VT(US).

Each receiving UM RLC entity shall maintain the following state variables:

a) VR(UR) – UM receive state variable

This state variable holds the value of the SN of the earliest UMD PDU that is still considered for reordering. It is initially set to 0.

b) VR(UX) – UM *t*-Reordering state variable

This state variable holds the value of the SN following the SN of the UMD PDU which triggered *t*-Reordering.

c) VR(UH) – UM highest received state variable

This state variable holds the value of the SN following the SN of the UMD PDU with the highest SN among received UMD PDUs, and it serves as the higher edge of the reordering window. It is initially set to 0.

7.2.2.5.2.3 Test description

7.2.2.5.2.3.1 Pre-test conditions

System Simulator:

- Cell 1.

UE:

None.

Preamble:

- UE is in state Loopback Activated (state 4) according to [18] with PDCP Data PDUs using 7 bit SN length.
- The condition SRB2-DRB(1,1) is used for step 8 in 4.5.3A.3 according to [18].

7.2.2.5.2.3.2 Test procedure sequence

Table 7.2.2.5.2.3.2-1: Main behaviour

St	Procedure	Message Sequence		TP	Verdict
		U - S	Message/PDU/SDU		
-	EXCEPTION: Steps 3 to 4 are executed 1023 times.	-	-	-	-
1	The SS transmits an UMD PDU. SN equals 0.	<--	UMD PDU	-	-
2	Check: Does the UE transmit an UMD PDU with SN = 0?	-->	UMD PDU	1	P
3	The SS transmits an UMD PDU. SN equals 1 and is incremented for each PDU transmitted.	<--	UMD PDU	-	-
4	Check: Does the UE transmit an UMD PDU with SN increased by 1 compared with the previous one?	-->	UMD PDU	2	P
5	The SS transmits an UMD PDU. SN equals 0.	<--	UMD PDU	-	-
6	Check: Does the UE transmit an UMD PDU with SN=0?	-->	UMD PDU	3, 4	P

7.2.2.5.2.3.3 Specific message contents

None.

7.2.2.6 UM RLC / Concatenation, segmentation and reassembly

7.2.2.6.1 Test Purpose (TP)

(1)

```
with { UE in E-UTRA RRC_CONNECTED state }
ensure that {
  when { The UE has multiple RLC SDUs in the transmission buffer that fits into the available UMD
PDU size }
  then { The UE concatenates the RLC SDUs in the transmission buffer into one UMD PDU and
transmits it}
}
```

(2)

```
with { UE in E-UTRA RRC_CONNECTED state }
ensure that {
  when { The UE receives UMD PDUs containing concatenated RLC SDUs}
  then { The UE reassembles the RLC SDUs in accordance with the Framing Info and Length Indicators
indicated in UMD PDUs }
}
```

(3)

```
with { UE in E-UTRA RRC_CONNECTED state }
ensure that {
  when { The UE has RLC SDU in the transmission buffer that does not fit into the available UMD PDU
size }
  then { The UE segments the RLC SDU in accordance with the Framing Info and Length Indicators
indicated in UMD PDUs }
}
```

7.2.2.6.2 Conformance requirements

References: The conformance requirements covered in the present TC are specified in: 3GPP TS 36.322, clause 4.2.1.2.2, 4.2.1.2.3, 4.4, 6.2.1.3 and 6.2.2.6.

[TS 36.322, clause 4.2.1.2.2]

When a transmitting UM RLC entity forms UMD PDUs from RLC SDUs, it shall:

- segment and/or concatenate the RLC SDUs so that the UMD PDUs fit within the total size of RLC PDU(s) indicated by lower layer at the particular transmission opportunity notified by lower layer;

- include relevant RLC headers in the UMD PDU.

[TS 36.322, clause 4.2.1.2.3]

When a receiving UM RLC entity receives UMD PDUs, it shall:

...

- reassemble RLC SDUs from the reordered UMD PDUs (not accounting for RLC PDUs for which losses have been detected) and deliver the RLC SDUs to upper layer in ascending order of the RLC SN;

...

[TS 36.322, clause 4.4]

The following functions are supported by the RLC sub layer:

...

- concatenation, segmentation and reassembly of RLC SDUs (only for UM and AM data transfer);

...

[TS 36.322, clause 6.2.1.3]

UMD PDU consists of a Data field and an UMD PDU header.

UMD PDU header consists of a fixed part (fields that are present for every UMD PDU) and an extension part (fields that are present for an UMD PDU when necessary). The fixed part of the UMD PDU header itself is byte aligned and consists of a FI, an E and a SN. The extension part of the UMD PDU header itself is byte aligned and consists of E(s) and LI(s).

An UM RLC entity is configured by RRC to use either a 5 bit SN or a 10 bit SN. When the 5 bit SN is configured, the length of the fixed part of the UMD PDU header is one byte. When the 10 bit SN is configured, the fixed part of the UMD PDU header is identical to the fixed part of the AMD PDU header, except for D/C, RF and P fields all being replaced with R1 fields. The extension part of the UMD PDU header is identical to the extension part of the AMD PDU header (regardless of the configured SN size).

An UMD PDU header consists of an extension part only when more than one Data field elements are present in the UMD PDU, in which case an E and a LI are present for every Data field element except the last. Furthermore, when an UMD PDU header consists of an odd number of LI(s), four padding bits follow after the last LI.

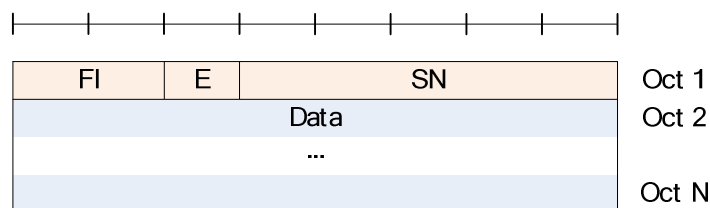

Figure 6.2.1.3-1: UMD PDU with 5 bit SN (No LI)

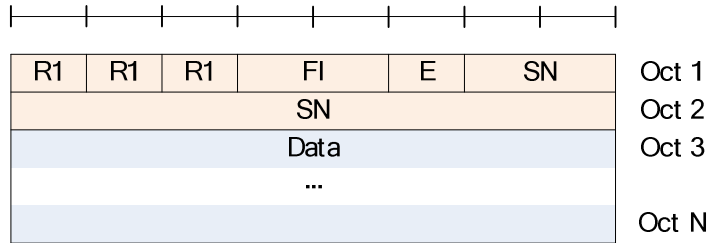

Figure 6.2.1.3-2: UMD PDU with 10 bit SN (No LI)

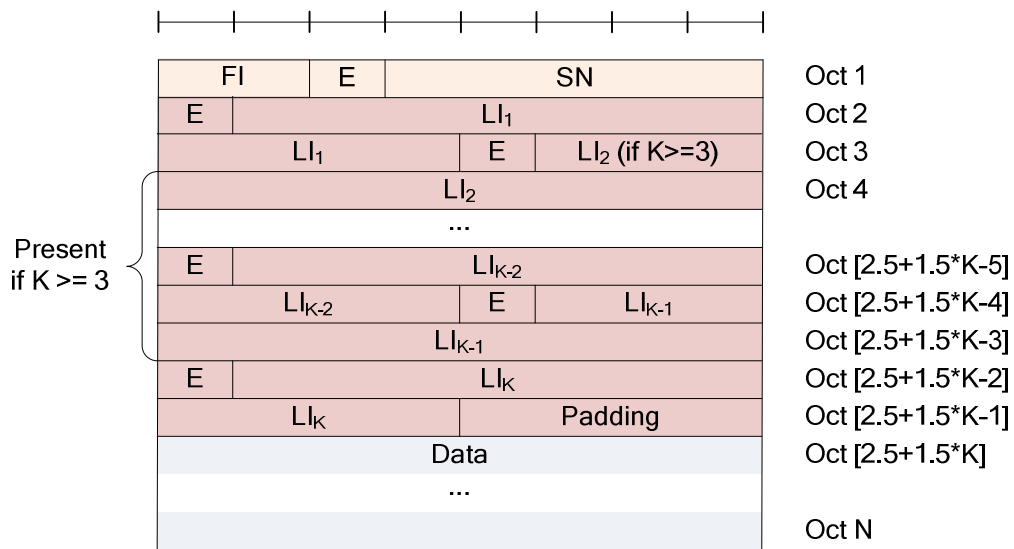

Figure 6.2.1.3-3: UMD PDU with 5 bit SN (Odd number of LIs, i.e. K = 1, 3, 5, ...)

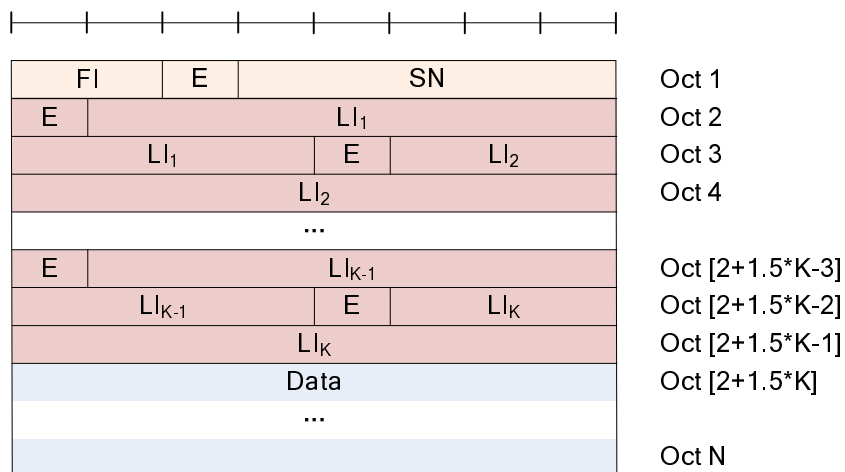

Figure 6.2.1.3-4: UMD PDU with 5 bit SN (Even number of LIs, i.e. K = 2, 4, 6, ...)

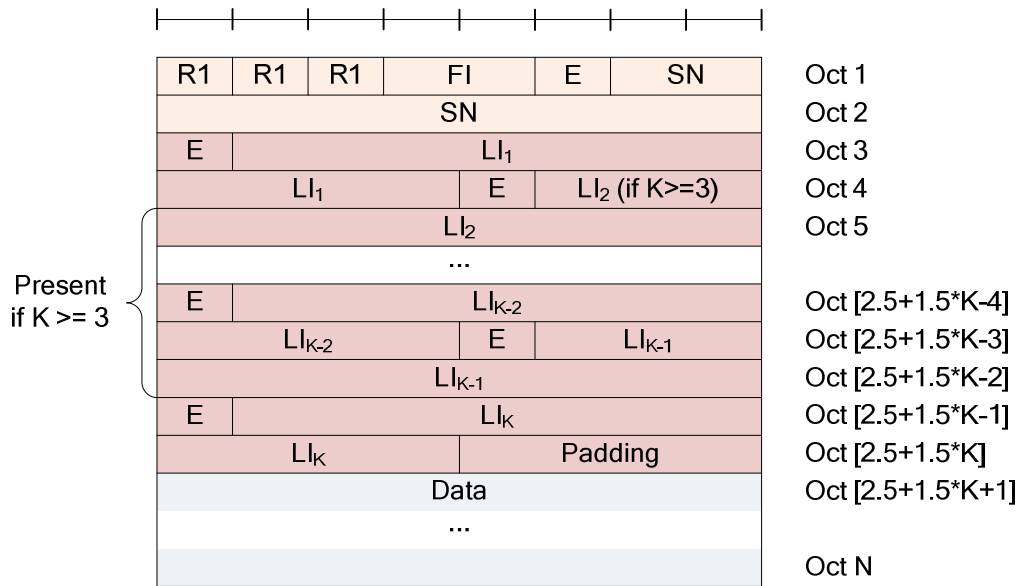

Figure 6.2.1.3-5: UMD PDU with 10 bit SN (Odd number of LIs, i.e. K = 1, 3, 5, ...)

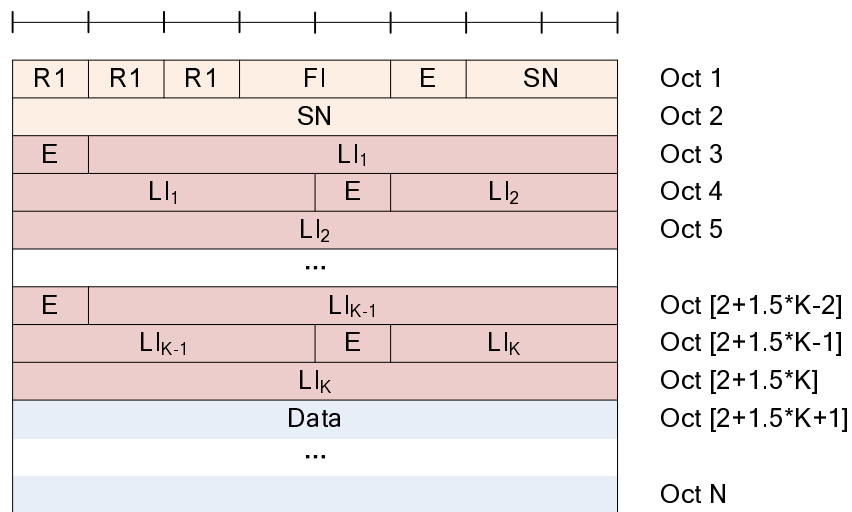

Figure 6.2.1.3-6: UMD PDU with 10 bit SN (Even number of LIs, i.e. K = 2, 4, 6, ...)

[TS 36.322, clause 6.2.2.6]

Length: 2 bits.

The FI field indicates whether a RLC SDU is segmented at the beginning and/or at the end of the Data field. Specifically, the FI field indicates whether the first byte of the Data field corresponds to the first byte of a RLC SDU, and whether the last byte of the Data field corresponds to the last byte of a RLC SDU. The interpretation of the FI field is provided in Table 6.2.2.6-1.

Table 6.2.2.6-1: FI field interpretation

Value	Description
00	First byte of the Data field corresponds to the first byte of a RLC SDU. Last byte of the Data field corresponds to the last byte of a RLC SDU.
01	First byte of the Data field corresponds to the first byte of a RLC SDU. Last byte of the Data field does not correspond to the last byte of a RLC SDU.
10	First byte of the Data field does not correspond to the first byte of a RLC SDU. Last byte of the Data field corresponds to the last byte of a RLC SDU.
11	First byte of the Data field does not correspond to the first byte of a RLC SDU. Last byte of the Data field does not correspond to the last byte of a RLC SDU.

7.2.2.6.3 Test description

7.2.2.6.3.1 Pre-test conditions

System Simulator:

- Cell 1.

UE:

None.

Preamble:

- The UE is in state Loopback Activated (state 4) according to [18].
- The condition SRB2-DRB(1,1) is used for step 8 in 4.5.3A.3 according to [18].

7.2.2.6.3.2 Test procedure sequence

Table 7.2.2.6.3.2-1: Main behaviour

St	Procedure	Message Sequence		TP	Verdict
		U - S	Message		
1	The SS does not allocate any uplink grant.	-	-	-	-
2	The SS transmits UMD PDU#1. This PDU carries SDU#1 with size of 50 bytes.	<--	UMD PDU#1 (RLC SDU#1)	-	-
3	The SS transmits UMD PDU#2. This PDU carries SDU#2 with size of 50 bytes.	<--	UMD PDU#2 (RLC SDU#2)	-	-
4	SS transmits UL grants to enable UE to return RLC SDU#1 and RLC SDU#2 both in one UMD PDU.	<--	(UL grants)	-	-
5	Check: Does UE transmit RLC SDU#1 and RLC SDU#2 within UMD PDU with FI field set to '00', E field in the fixed part set to '1', first E field in the extension part set to '0' and first LI field set to 50 bytes?	-->	UMD PDU#1 (RLC SDU#1 and RLC SDU#2)	1	P
5A	The SS does not allocate any uplink grant.	-	-	-	-
6	SS transmits an UMD PDU#3 including RLC SDU#3 and RLC SDU#4 each with size of 50 bytes. Header of UMD PDU#3 contains FI='00', E='1', SN=2, E ₁ '='0', LI ₁ '='50'.	<--	UMD PDU#3 (RLC SDU#3 and RLC SDU#4)	-	-
7	The SS waits for 60 ms and then allocates 2 UL grants (UL grant allocation type 2) with a time spacing of 5 ms to enable UE to return each RLC SDU in one UMD PDU.	<--	(UL grants)	-	-
8	Check: Does UE transmit RLC SDU#3 within an UMD PDU with FI field set to '00' and E field in the fixed part set to '0'?	-->	UMD PDU#3 (RLC SDU#3)	2	P
9	Check: Does UE transmit RLC SDU#4 within an UMD PDU with FI field set to '00' and E field in the fixed part set to '0'?	-->	UMD PDU#4 (RLC SDU#4)	2	P
10	The SS transmits UMD PDU#4. This PDU carries SDU#5 with size of 50 bytes.	<--	UMD PDU#4 (RLC SDU#5)	-	-
11	The SS waits for 60 ms and then allocates 2 UL grants (UL grant allocation type 2) with a time spacing of 5 ms to enable UE to return RLC SDU#5 in two UMD PDUs.	<--	(UL grants)	-	-
12	Check: Does UE transmit 1 st part of RLC SDU#5 within UMD PDU#5 with FI field set to '01' and E field in the fixed part set to '0'?	-->	UMD PDU#5	3	P
13	Check: Does UE transmit last part of RLC SDU#5 within an UMD PDU#6 with FI field set to '10' and E field in the fixed part set to '0'?	-->	UMD PDU#6	3	P

7.2.2.6.3.3 Specific message contents

None.

7.2.2.7 UM RLC / In sequence delivery of upper layer PDUs without residual loss of RLC PDUs / Maximum re-ordering delay below *t-Reordering*

7.2.2.7.1 Test Purpose (TP)

(1)

```

with { UE in E-UTRAN RRC_CONNECTED state }
ensure that {
  when { UE receives missing PDUs whose SN is within the reordering window before t-Reordering has expired }
  then { RLC reassembles and reorders the UMD PDUs and delivers them to the upper layer in sequence }
}

```

7.2.2.7.2 Conformance requirements

References: The conformance requirements covered in the present TC are specified in: 3GPP TS 36.322, clause 5.1.2.2. [TS 36.322, clause 5.1.2.2]

The receiving UM RLC entity shall maintain a reordering window according to state variable VR(UH) as follows:

- a SN falls within the reordering window if $(VR(UH) - UM_Window_Size) \leq SN < VR(UH)$;
- a SN falls outside of the reordering window otherwise.

When receiving an UMD PDU from lower layer, the receiving UM RLC entity shall:

- either discard the received UMD PDU or place it in the reception buffer (see sub clause 5.1.2.2.2);
- if the received UMD PDU was placed in the reception buffer:
 - update state variables, reassemble and deliver RLC SDUs to upper layer and start/stop *t-Reordering* as needed (see sub clause 5.1.2.2.3);

...

When an UMD PDU with SN = x is received from lower layer, the receiving UM RLC entity shall:

- if $VR(UR) < x < VR(UH)$ and the UMD PDU with SN = x has been received before; or
- if $(VR(UH) - UM_Window_Size) \leq x < VR(UR)$:
 - discard the received UMD PDU;
- else:
 - place the received UMD PDU in the reception buffer.

...

When an UMD PDU with SN = x is placed in the reception buffer, the receiving UM RLC entity shall:

- if x falls outside of the reordering window:
 - update VR(UH) to x + 1;
 - reassemble RLC SDUs from any UMD PDUs with SN that falls outside of the reordering window, remove RLC headers when doing so and deliver the reassembled RLC SDUs to upper layer in ascending order of the RLC SN if not delivered before;
 - if VR(UR) falls outside of the reordering window:
 - set VR(UR) to $(VR(UH) - UM_Window_Size)$;
- if the reception buffer contains an UMD PDU with SN = VR(UR):
 - update VR(UR) to the SN of the first UMD PDU with SN > current VR(UR) that has not been received;
 - reassemble RLC SDUs from any UMD PDUs with SN < updated VR(UR), remove RLC headers when doing so and deliver the reassembled RLC SDUs to upper layer in ascending order of the RLC SN if not delivered before;
- if *t-Reordering* is running:
 - if $VR(UX) \leq VR(UR)$; or
 - if VR(UX) falls outside of the reordering window and VR(UX) is not equal to VR(UH)::
 - stop and reset *t-Reordering*;
- if *t-Reordering* is not running (includes the case when *t-Reordering* is stopped due to actions above):

- if $VR(UH) > VR(UR)$:
- start *t-Reordering*;
- set $VR(UX)$ to $VR(UH)$.

7.2.2.7.3 Test description

7.2.2.7.3.1 Pre-test conditions

System Simulator:

- Cell 1.

UE:

None.

Preamble

- UE is in state Loopback Activated (state 4) according to [18] with the exceptions listed in table 7.2.2.7.3.1-1 applicable for the configured UM DRB.
- The condition SRB2-DRB(1,1) is used for step 8 in 4.5.3A.3 according to [18].

Table 7.2.2.7.3.1-1: RLC parameters

Downlink RLC <i>t-Reordering</i>	ms200
-------------------------------------	-------

7.2.2.7.3.2 Test procedure sequence

Table 7.2.2.7.3.2-1: Main behaviour

St	Procedure	Message Sequence		TP	Verdict
		U - S	Message		
1	The SS transmits an UMD PDU. This PDU carries SDU#1. SN equals 0.	<--	UMD PDU#1	-	-
2	The UE transmits RLC SDU#1.	-->	(RLC SDU#1)	-	-
2A	The SS does not allocate any uplink grant.	-	-	-	-
3	The SS transmits an UMD PDU. This PDU contains the last part of SDU#4. SN equals 3. The UE starts <i>t-Reordering</i> .	<--	UMD PDU#4	-	-
4	The SS transmits an UMD PDU. This PDU contains the last part of SDU#3, and the 1 st part of SDU#4. SN equals 2.	<--	UMD PDU#3	-	-
5	The SS transmits an UMD PDU. This PDU carries SDU#2 and the 1 st part of SDU#3. SN equals 1. (Note)	<--	UMD PDU#2	-	-
5A	The SS waits for 60 ms and then allocates 3 UL grants (UL grant allocation type 2) with a time spacing of 5 ms of size enough for the UE to loop back one SDU in one UMD PDU	-	-	-	-
6	Check: Does the UE transmit RLC SDU#2?	-->	(RLC SDU#2)	1	P
7	Check: Does the UE transmit RLC SDU#3?	-->	(RLC SDU#3)	1	P
8	Check: Does the UE transmit RLC SDU#4?	-->	(RLC SDU#4)	1	P
Note:	The UE stops <i>t-Reordering</i> , reassembles UMD PDUs and delivers RLC SDU#2, RLC SDU#3 and RLC SDU#4 to the upper layer in sequence.				

7.2.2.7.3.3 Specific message contents

None.

7.2.2.8 UM RLC / In sequence delivery of upper layer PDUs without residual loss of RLC PDUs / Maximum re-ordering delay exceeds *t-Reordering*

7.2.2.8.1 Test Purpose (TP)

(1)

```
with { UE in E-UTRA RRC_CONNECTED state }
ensure that {
  when { a PDU is received out of order after t-Reordering has expired }
  then { UE discards the corresponding PDU and delivers all correctly received RLC SDUs to upper
layer in the correct order }
}
```

7.2.2.8.2 Conformance requirements

References: The conformance requirements covered in the present TC are specified in: TS 36.322, clause 5.1.2.2.2, 5.1.2.2.3 and 5.1.2.2.4.

[TS 36.322, clause 5.1.2.2.2]

When an UMD PDU with SN = x is received from lower layer, the receiving UM RLC entity shall:

- if $VR(UR) < x < VR(UH)$ and the UMD PDU with SN = x has been received before; or
- if $(VR(UH) - UM_Window_Size) \leq x < VR(UR)$:
 - discard the received UMD PDU;
- else:
 - place the received UMD PDU in the reception buffer.

[TS 36.322, clause 5.1.2.2.3]

When an UMD PDU with SN = x is placed in the reception buffer, the receiving UM RLC entity shall:

- if x falls outside of the reordering window:
 - update $VR(UH)$ to $x + 1$;
 - reassemble RLC SDUs from any UMD PDUs with SN that falls outside of the reordering window, remove RLC headers when doing so and deliver the reassembled RLC SDUs to upper layer in ascending order of the RLC SN if not delivered before;
- if $VR(UR)$ falls outside of the reordering window:
 - set $VR(UR)$ to $(VR(UH) - UM_Window_Size)$;
- if the reception buffer contains an UMD PDU with SN = $VR(UR)$:
 - update $VR(UR)$ to the SN of the first UMD PDU with SN > current $VR(UR)$ that has not been received;
 - reassemble RLC SDUs from any UMD PDUs with SN < updated $VR(UR)$, remove RLC headers when doing so and deliver the reassembled RLC SDUs to upper layer in ascending order of the RLC SN if not delivered before;
- if *t-Reordering* is running:
 - if $VR(UX) \leq VR(UR)$; or
 - if $VR(UX)$ falls outside of the reordering window and $VR(UX)$ is not equal to $VR(UH)$:
 - stop and reset *t-Reordering*;
- if *t-Reordering* is not running (includes the case when *t-Reordering* is stopped due to actions above):
 - if $VR(UH) > VR(UR)$:

- start *t-Reordering*;
- set VR(UX) to VR(UH).

[TS 36.322, clause 5.1.2.2.4]

When *t-Reordering* expires, the receiving UM RLC entity shall:

- update VR(UR) to the SN of the first UMD PDU with SN >= VR(UX) that has not been received;
- reassemble RLC SDUs from any UMD PDUs with SN < updated VR(UR), remove RLC headers when doing so and deliver the reassembled RLC SDUs to upper layer in ascending order of the RLC SN if not delivered before;
- if VR(UH) > VR(UR):
 - start *t-Reordering*;
 - set VR(UX) to VR(UH).

7.2.2.8.3 Test description

7.2.2.8.3.1 Pre-test conditions

System Simulator:

- Cell 1.

UE:

None.

Preamble:

- The UE is in state Loopback Activated (state 4) according to [18] with the exceptions listed in table 7.2.2.8.3.1-1 applicable for the configured UM DRB.
- The condition SRB2-DRB(1,1) is used for step 8 in 4.5.3A.3 according to [18].

Table 7.2.2.8.3.1-1: RLC parameters

Downlink RLC <i>t-Reordering</i>	ms200
-------------------------------------	-------

7.2.2.8.3.2 Test procedure sequence

Table 7.2.2.8.3.2-1: Main behaviour

St	Procedure	Message Sequence		TP	Verdict
		U - S	Message		
1	The SS transmits RLC PDU#1 containing first segment of RLC SDU#1. Note T ₁	<--	UMD PDU#1	-	-
2	The SS does not transmit RLC PDU#2 containing last segment of RLC SDU#1.	-	-	-	-
3	The SS transmits RLC PDU#3 containing RLC SDU#2.	<--	UMD PDU#3	-	-
3A	Check 1: Does the UE transmit RLC SDU#2 after <i>t-Reordering</i> (200 ms) expiry? Note T ₂ Check 2: Is (T ₂ - T ₁) > <i>t-reordering</i> ?	-->	(RLC SDU#2)	1	P
3B	The SS transmits RLC PDU#2 containing last segment of RLC SDU#1.	<--	UMD PDU#2	-	-
4	Check: Does the UE transmit RLC SDU#1 within 100 ms?	-->	(RLC SDU#1)	1	F

7.2.2.8.3.3 Specific message contents

None.

7.2.2.9 UM RLC / In sequence delivery of upper layer PDUs with residual loss of RLC PDUs / Maximum re-ordering delay exceeds *t-Reordering*

7.2.2.9.1 Test Purpose (TP)

(1)

```
with { UE in E-UTRA RRC_CONNECTED state }
ensure that {
  when { UE detects that RLC PDUs constructing different RLC SDUs are lost }
  then { UE delivers all received RLC SDUs to upper layer in the correct order }
}
```

7.2.2.9.2 Conformance requirements

References: The conformance requirements covered in the present TC are specified in: TS 36.322, clause 5.1.2.2.2, 5.1.2.2.3 and 5.1.2.2.4.

[TS 36.322, clause 5.1.2.2.2]

When an UMD PDU with SN = x is received from lower layer, the receiving UM RLC entity shall:

- if $VR(UR) < x < VR(UH)$ and the UMD PDU with SN = x has been received before; or
- if $(VR(UH) - UM_Window_Size) \leq x < VR(UR)$:
 - discard the received UMD PDU;
- else:
 - place the received UMD PDU in the reception buffer.

[TS 36.322, clause 5.1.2.2.3]

When an UMD PDU with SN = x is placed in the reception buffer, the receiving UM RLC entity shall:

- if x falls outside of the reordering window:
 - update $VR(UH)$ to $x + 1$;
 - reassemble RLC SDUs from any UMD PDUs with SN that falls outside of the reordering window, remove RLC headers when doing so and deliver the reassembled RLC SDUs to upper layer in ascending order of the RLC SN if not delivered before;
- if $VR(UR)$ falls outside of the reordering window:
 - set $VR(UR)$ to $(VR(UH) - UM_Window_Size)$;
- if the reception buffer contains an UMD PDU with SN = $VR(UR)$:
 - update $VR(UR)$ to the SN of the first UMD PDU with SN > current $VR(UR)$ that has not been received;
 - reassemble RLC SDUs from any UMD PDUs with SN < updated $VR(UR)$, remove RLC headers when doing so and deliver the reassembled RLC SDUs to upper layer in ascending order of the RLC SN if not delivered before;
- if *t-Reordering* is running:
 - if $VR(UX) \leq VR(UR)$; or
 - if $VR(UX)$ falls outside of the reordering window and $VR(UX)$ is not equal to $VR(UH)$:
 - stop and reset *t-Reordering*;

- if *t-Reordering* is not running (includes the case when *t-Reordering* is stopped due to actions above):
 - if $VR(UH) > VR(UR)$:
 - start *t-Reordering*;
 - set $VR(UX)$ to $VR(UH)$.

[TS 36.322, clause 5.1.2.2.4]

When *t-Reordering* expires, the receiving UM RLC entity shall:

- update $VR(UR)$ to the SN of the first UMD PDU with $SN \geq VR(UX)$ that has not been received;
- reassemble RLC SDUs from any UMD PDUs with $SN < \text{updated } VR(UR)$, remove RLC headers when doing so and deliver the reassembled RLC SDUs to upper layer in ascending order of the RLC SN if not delivered before;
- if $VR(UH) > VR(UR)$:
 - start *t-Reordering*;
 - set $VR(UX)$ to $VR(UH)$.

7.2.2.9.3 Test description

7.2.2.9.3.1 Pre-test conditions

System Simulator:

- Cell 1.

UE:

None.

Preamble:

- UE is in state Loopback Activated (state 4) according to [18] with the exceptions listed in table 7.2.2.9.3.1-1 applicable for the configured UM DRB.
- The condition SRB2-DRB(1,1) is used for step 8 in 4.5.3A.3 according to [18].

Table 7.2.2.9.3.1-1: RLC parameters

Downlink RLC <i>t-Reordering</i>	ms200
-------------------------------------	-------

7.2.2.9.3.2 Test procedure sequence

Table 7.2.2.9.3.2-1: Main behaviour

St	Procedure	Message Sequence		TP	Verdict
		U - S	Message		
1	The SS transmits UMD PDU#1 containing first segment of RLC SDU#1.	<--	UMD PDU#1	-	-
2	The SS does not transmit UMD PDU#2 containing last segment of RLC SDU#1.	-	-	-	-
3	The SS transmits UMD PDU#3 containing first segment of RLC SDU#2.	<--	UMD PDU#3	-	-
4	The SS transmits UMD PDU#4 containing last segment of RLC SDU#2.	<--	UMD PDU#4	-	-
5	The SS transmits UMD PDU#5 containing first segment of RLC SDU#3.	<--	UMD PDU#5	-	-
6	The SS does not transmit UMD PDU#6 containing last segment of RLC SDU#3.	-	-	-	-
7	The SS transmits UMD PDU#7 containing first segment of RLC SDU#4.	<--	UMD PDU#7	-	-
8	The SS transmits UMD PDU#8 containing last segment of RLC SDU#4.	<--	UMD PDU#8	-	-
9	Wait for 200 ms to ensure that <i>t-Reordering</i> for the UMD PDU#2 expires.	-	-	-	-
10	Check: Does the UE transmit RLC SDU#2?	-->	(RLC SDU#2)	1	P
11	Wait for 200 ms to ensure that <i>t-Reordering</i> for the UMD PDU#6 expires.	-	-	-	-
12	Check: Does the UE transmit RLC SDU#4?	-->	(RLC SDU#4)	1	P

7.2.2.9.3.3 Specific message contents

None.

7.2.2.10 UM RLC / Duplicate detection of RLC PDUs

7.2.2.10.1 Test Purpose (TP)

(1)

```
with { UE in E-UTRAN RRC_CONNECTED state }
ensure that {
  when { UE receives duplicate UMD PDUs }
  then { UE discards the duplicate UMD PDUs }
}
```

(2)

```
with { UE in E-UTRAN RRC_CONNECTED state }
ensure that {
  when { UE receives UMD PDUs whose SN is within the reordering window and duplicate UMD PDUs }
  then { UE discards the duplicate UMD PDUs }
}
```

7.2.2.10.2 Conformance requirements

References: The conformance requirements covered in the present TC are specified in: 3GPP TS 36.322, clause 4.2.1.2.3 and 5.1.2.2.2.

[TS 36.322, clause 4.2.1.2.3]

When a receiving UM RLC entity receives UMD PDUs, it shall:

- detect whether or not the UMD PDUs have been received in duplication, and discard duplicated UMD PDUs;
- reorder the UMD PDUs if they are received out of sequence;
- detect the loss of UMD PDUs at lower layers and avoid excessive reordering delays;

- reassemble RLC SDUs from the reordered UMD PDUs (not accounting for RLC PDUs for which losses have been detected) and deliver the RLC SDUs to upper layer in ascending order of the RLC SN;

...

[TS 36.322, clause 5.1.2.2.2]

When an UMD PDU with SN = x is received from lower layer, the receiving UM RLC entity shall:

- if $VR(UR) < x < VR(UH)$ and the UMD PDU with SN = x has been received before; or
- if $(VR(UH) - UM_Window_Size) \leq x < VR(UR)$:
 - discard the received UMD PDU;

...

7.2.2.10.3 Test description

7.2.2.10.3.1 Pre-test conditions

System Simulator:

- Cell 1.

UE:

None.

Preamble:

- UE is in state Loopback Activated (state 4) according to [18] with the exceptions listed in table 7.2.2.10.3.1-1.

Table 7.2.2.10.3.1-1: RLC settings

Parameter	Value
<i>t-Reordering</i>	ms100

- The condition SRB2-DRB(1,1) is used for step 8 in 4.5.3A.3 according to [18].

7.2.2.10.3.2 Test procedure sequence

Table 7.2.2.10.3.2-1: Main behaviour

St	Procedure	Message Sequence		TP	Verdict
		U - S	Message		
1	The SS transmits an UMD PDU. This PDU carries SDU#1. SN equals 0.	<--	UMD PDU#1	-	-
2	The UE transmits RLC SDU#1.	-->	(RLC SDU#1)	-	-
3	The SS transmits an UMD PDU. This PDU carries SDU#1. SN equals 0.	<--	UMD PDU#1	-	-
4	Check: Does the UE transmit RLC SDU#1?	-->	(RLC SDU#1)	1	F
5	The SS transmits an UMD PDU. This PDU contains SDU#2 and the 1 st part of SDU#3. SN equals 1.	<--	UMD PDU#2	-	-
6	The UE transmit RLC SDU#2.	-->	(RLC SDU#2)	-	-
7	The SS transmits an UMD PDU. This PDU contains SDU#2 and the 1 st part of SDU#3. SN equals 1.	<--	UMD PDU#2	-	-
8	Check: Does the UE transmit RLC SDU#2?	-->	(RLC SDU#2)	1	F
9	The SS transmits an UMD PDU. This PDU contains the last part of SDU#3. SN equals 2.	<--	UMD PDU#3	-	-
10	The UE transmits RLC SDU#3.	-->	(RLC SDU#3)	-	-
10 A	The SS ignores scheduling requests and does not allocate any uplink grant.	-	-	-	-
10 B	The SS enables the indication of scheduling requests till step 15.	-	-	-	-
11	After 100 ms the SS transmits an UMD PDU. This PDU carries SDU#5. SN equals 4.	<--	UMD PDU#5	-	-
12	The SS transmits an UMD PDU. This PDU carries SDU#6. SN equals 5.	<--	UMD PDU#6	-	-
13	The SS transmits an UMD PDU. This PDU contains the last part of SDU#3. SN equals 2.	<--	UMD PDU#3	-	-
14	Check: Does the UE transmit scheduling request before transmission of UMD PDU at step 15?	-->	(SR)	2	F
15	After 75 ms from step 11 the SS transmits an UMD PDU. This PDU carries SDU#4. SN equals 3.	<--	UMD PDU#4	-	-
15 A	The SS waits for 60 ms and then allocates 1 UL grant of size enough for the UE to loop back 3 RLC SDU in one UMD PDU	<--	(UL Grant)	-	-
16	SS receives SDU#4, SDU#5 and SDU#6 in a single PDU	-->	(RLC SDU#4, RLC SDU#5 and RLC SDU#6)	1,2	P
17	Void				
18	Void				

7.2.2.10.3.3 Specific message contents

None.

7.2.2.11 UM RLC / RLC re-establishment procedure

7.2.2.11.1 Test Purpose (TP)

(1)

```
with { UE in E-UTRA RRC_CONNECTED state }
ensure that {
  when { RLC re-establishment is performed upon request by RRC }
  then { The UE discards all UMD PDUs where no RLC SDUs can be reassembled }
}
```

(2)

```
with { UE in E-UTRA RRC_CONNECTED state }
ensure that {
  when { RLC re-establishment is performed upon request by RRC }
```

```

    then { The UE resets variable VT(US), VR(UH) and VR(UR) to its initial value }
  }

```

7.2.2.11.2 Conformance requirements

References: The conformance requirements covered in the present TC are specified in: 3GPP TS 36.322, clause 4.2.1.2.3 and 5.4.

[TS 36.322, clause 4.2.1.2.3]

At the time of RLC re-establishment, the receiving UM RLC entity shall:

- if possible, reassemble RLC SDUs from the UMD PDUs that are received out of sequence and deliver them to upper layer;
- discard any remaining UMD PDUs that could not be reassembled into RLC SDUs;
- initialize relevant state variables and stop relevant timers.

[TS 36.322, clause 5.4]

RLC re-establishment is performed upon request by RRC, and the function is applicable for AM, UM and TM RLC entities.

When RRC indicates that an RLC entity should be re-established, the RLC entity shall:

...

- if it is a receiving UM RLC entity:
 - when possible, reassemble RLC SDUs from UMD PDUs with SN < VR(UH), remove RLC headers when doing so and deliver all reassembled RLC SDUs to upper layer in ascending order of the RLC SN, if not delivered before;
 - discard all remaining UMD PDUs;

...

- reset all state variables to their initial values.

7.2.2.11.3 Test description

7.2.2.11.3.1 Pre-test conditions

System Simulator:

- Cell 1

UE:

None.

Preamble:

- UE is in Loopback Activated state (state 4) according to TS 36.508 clause 4.5 [18] with the exceptions listed in table 7.2.2.11.3.1-1 applicable for the configured UM DRB.
- The condition SRB2-DRB(1,1) is used for step 8 in 4.5.3A.3 according to [18].

Table 7.2.2.11.3.1-1: RLC parameters

Downlink RLC <i>t-Reordering</i>	ms200
-------------------------------------	-------

7.2.2.11.3.2 Test procedure sequence

Table 7.2.2.11.3.2-1: Main behaviour

St	Procedure	Message Sequence		TP	Verdict
		U - S	Message		
1	The SS transmits UMD PDU#1. Header of UMD PDU#1 contains SN=0. This PDU carries RLC SDU#1.	<--	UMD PDU#1	-	-
2	The UE transmits RLC SDU#1.	-->	(RLC SDU#1)	-	-
3	The SS transmits UMD PDU#2. Header of UMD PDU#2 contains SN=1. This PDU carries the 1 st segment of SDU#2.	<--	UMD PDU#2	-	-
4	SS performs a RRC Connection Reconfiguration procedure including the <i>mobilityControlInfo</i> IE in <i>RRCConnectionReconfiguration</i> triggering RLC re-establishment.	-	-	-	-
5	The SS transmits UMD PDU#3. Header of UMD PDU#3 contains SN=2. This PDU carries the last segment of RLC SDU#2. The UE starts <i>t-Reordering</i> .	<--	UMD PDU#3	-	-
6	Check: Does the UE transmit RLC SDU#2?	-->	(RLC SDU#2)	1	F
7	300 ms ($1.5 * t-Reordering$) after step 5 the SS transmits UMD PDU#4. Header of UMD PDU#4 contains SN=3. This PDU carries RLC SDU#3.	<--	UMD PDU#4	-	-
8	The UE transmit RLC SDU#3. Header of UMD PDU carrying RLC SDU#3 contains SN=0.	-->	(RLC SDU#3)	-	-
9	The SS transmits UMD PDU#5. Header of UMD PDU#5 contains SN=4. This PDU carries RLC SDU#4.	<--	UMD PDU#5	-	-
10	The UE transmits RLC SDU#4. Header of UMD PDU carrying RLC SDU#4 contains SN=1.	-->	(RLC SDU#4)	-	-
11	SS performs a RRC Connection Reconfiguration procedure including the <i>MobilityControlInfo</i> IE in <i>RRCConnectionReconfiguration</i> triggering RLC re-establishment.	-	-	-	-
12	The SS transmits UMD PDU#6. Header of UMD PDU#6 contains SN=0. This PDU carries RLC SDU#5.	<--	UMD PDU#6	-	-
13	Check 1: Does the UE transmit RLC SDU#5? Check 2: Does header of UMD PDU carrying RLC SDU#5 contain SN=0?	-->	(RLC SDU#5)	2	P

7.2.2.11.3.3 Specific message contents

Table 7.2.2.11.3.3-1: *RRCConnectionReconfiguration* (step 4 and step 11, Table 7.2.2.11.3.2-1)

Derivation Path: 36.508, Table 4.6.1-8, condition HO
--

Table 7.2.2.11.3.3-2: *MobilityControlInfo* (step 4 and step 11, Table 7.2.2.11.3.2-1)

Derivation Path: 36.508, Table 4.6.5-1			
Information Element	Value/remark	Comment	Condition
<i>MobilityControlInfo</i> ::= SEQUENCE {			
targetPhysCellId	PhysicalCellId of Cell 1		
carrierFreq	Not present		
}			

7.2.3 Acknowledged mode

7.2.3.1 AM RLC / Concatenation and reassembly

7.2.3.1.1 Test Purpose (TP)

(1)

```
with { UE in E-UTRA RRC_CONNECTED state }
ensure that {
  when { The UE has multiple RLC SDUs in the transmission buffer that fits into the available AMD
PDU size }
  then { The UE concatenates the RLC SDUs in the transmission buffer into an AMD PDU and transmits
it}
}
```

(2)

```
with { UE in E-UTRA RRC_CONNECTED state }
ensure that {
  when { The UE receives an AMD PDUs containing concatenated RLC }
  then { The UE reassembles the RLC SDUs in accordance with the Framing Info and Length Indicators
indicated in AMD PDUs }
}
```

7.2.3.1.2 Conformance requirements

References: The conformance requirements covered in the current TC are specified in: TS 36.322, clauses 4.2.1.3.2 , 4.2.1.3.3, 6.2.1.4 and 6.2.2.6.

[TS 36.322, clause 4.2.1.3.2]

When the transmitting side of an AM RLC entity forms AMD PDUs from RLC SDUs, it shall:

- segment and/or concatenate the RLC SDUs so that the AMD PDUs fit within the total size of RLC PDU(s) indicated by lower layer at the particular transmission opportunity notified by lower layer.

...

[TS 36.322, clause 4.2.1.3.3]

When the receiving side of an AM RLC entity receives RLC data PDUs, it shall:

....

- reassemble RLC SDUs from the reordered RLC data PDUs and deliver the RLC SDUs to upper layer in sequence.

...

[TS 36.322, clause 6.2.1.4]

AMD PDU consists of a Data field and an AMD PDU header.

AMD PDU header consists of a fixed part (fields that are present for every AMD PDU) and an extension part (fields that are present for an AMD PDU when necessary). The fixed part of the AMD PDU header itself is byte aligned and consists of a D/C, a RF, a P, a FI, an E and a SN. The extension part of the AMD PDU header itself is byte aligned and consists of E(s) and LI(s).

An AMD PDU header consists of an extension part only when more than one Data field elements are present in the AMD PDU, in which case an E and a LI are present for every Data field element except the last. Furthermore, when an AMD PDU header consists of an odd number of LI(s), four padding bits follow after the last LI.

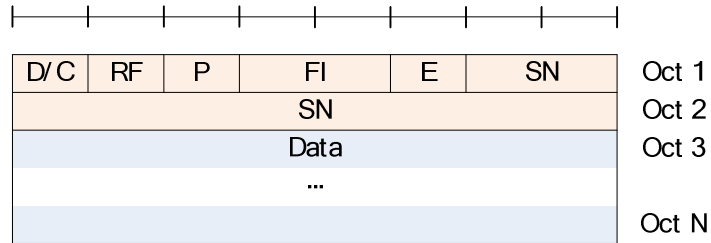

Figure 6.2.1.4-1: AMD PDU (No LI)

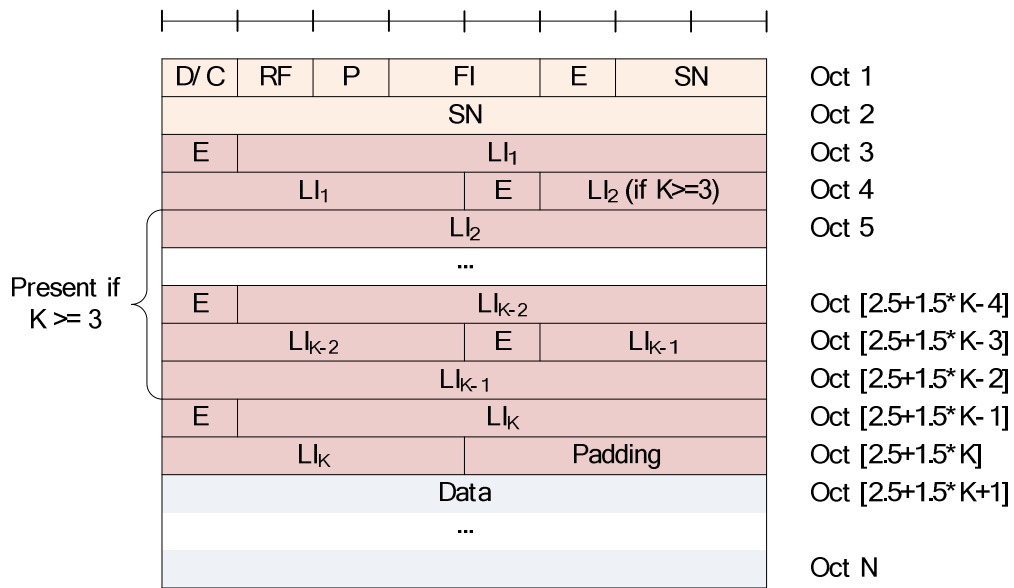

Figure 6.2.1.4-2: AMD PDU (Odd number of LIs, i.e. K = 1, 3, 5, ...)

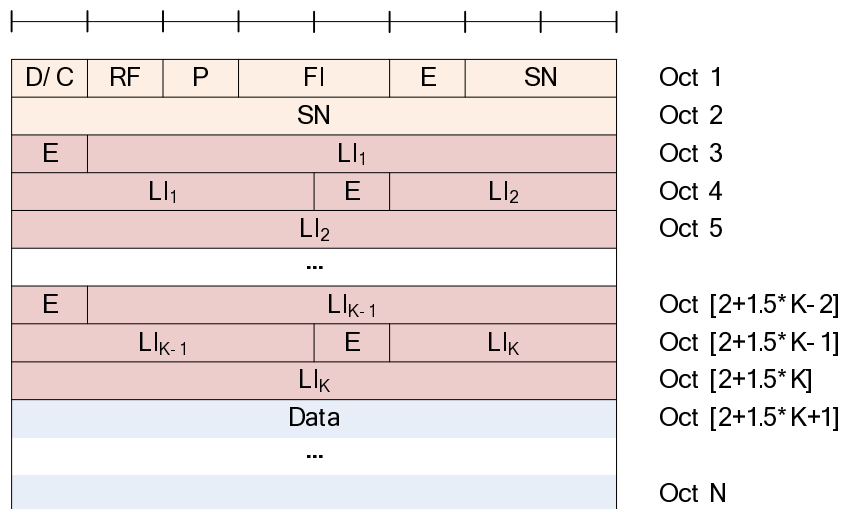

Figure 6.2.1.4-3: AMD PDU (Even number of LIs, i.e. K = 2, 4, 6, ...)

[TS 36.322, clause 6.2.2.6]

The FI field indicates whether a RLC SDU is segmented at the beginning and/or at the end of the Data field. Specifically, the FI field indicates whether the first byte of the Data field corresponds to the first byte of a RLC SDU, and whether the last byte of the Data field corresponds to the last byte of a RLC SDU. The interpretation of the FI field is provided in Table 6.2.2.6-1.

Table 6.2.2.6-1: FI field interpretation

Value	Description
00	First byte of the Data field corresponds to the first byte of a RLC SDU. Last byte of the Data field corresponds to the last byte of a RLC SDU.
01	First byte of the Data field corresponds to the first byte of a RLC SDU. Last byte of the Data field does not correspond to the last byte of a RLC SDU.
10	First byte of the Data field does not correspond to the first byte of a RLC SDU. Last byte of the Data field corresponds to the last byte of a RLC SDU.
11	First byte of the Data field does not correspond to the first byte of a RLC SDU. Last byte of the Data field does not correspond to the last byte of a RLC SDU.

7.2.3.1.3 Test description

7.2.3.1.3.1 Pre-test conditions

System Simulator:

- Cell 1.

UE:

None.

Preamble:

- The UE is in state Loopback Activated (state 4) according to [18] with the exceptions listed in table 7.2.3.1.3.1-1.

Table 7.2.3.1.3.1-1: RLC settings

Parameter	Value
t-StatusProhibit	500 ms

7.2.3.1.3.2 Test procedure sequence

Table 7.2.3.1.3.2-1: Main behaviour

St	Procedure	Message Sequence		TP	Verdict
		U - S	Message		
1	During the whole test sequence, the SS should not allocate UL grants unless when explicitly stated so in the procedure.	-	-	-	-
2	The SS transmits an AMD PDU including two RLC SDUs of size 40 bytes each with poll bit set to '1'.	<--	AMD PDU(AMD PDU header(D/C='1', RF='0', P='1', FI='00', E='1', SN='0', E ₁ '='0', LI ₁ '='40' bytes), 2 RLC SDUs of 40 bytes)	-	-
3	The SS waits for 60 ms and the allocates an UL grant (UL grant allocation type 3) of size 776 bits (Note 1).	<--	(UL grant, 776 bits)	-	-
4	Check: Does the UE transmit a STATUS PDU with positive acknowledgement?	-->	STATUS PDU (ACK SN=1)	2	P
5	Check: Does the UE transmit two RLC SDUs within an AMD PDU with FI field set to '00', first E field in the fixed part set to '1', first E field in the extension part set to '0', first LI field set to 40 bytes?	-->	AMD PDU(AMD PDU header(P='1', FI='00', E='1', SN=0, E ₁ '='0', LI ₁ '='40') , two RLC SDUs of size 40 bytes)	1, 2	P
6	The SS transmits a STATUS PDU.	<--	STATUS PDU (ACK SN=1)	-	-
7	After 500 ms the SS transmits an AMD PDU including three RLC SDU of size 40 bytes with P field set to "1".	<--	AMD PDU(AMD PDU header(D/C='1', RF='0', P='1', FI='00', E='1', SN='1', E ₁ '='1', LI ₁ '='40' bytes, E ₂ '='0', LI ₂ '='40' bytes), three RLC SDUs of size 40 bytes)	-	-
8	The SS waits for 60 ms and then allocates an UL grant (UL grant allocation type 3) of size 1096 bits. (Note 2).	<--	(UL grant, 1096 bits)	-	-
9	Check: Does the UE transmit a STATUS PDU with positive acknowledgement?	-->	STATUS PDU (ACK SN=2)	2	P
10	Check: Does the UE transmit three RLC SDUs within an AMD PDU with FI field set to "00", first E field in the fixed part set to '1', first E field in the extension part set to '1', first LI field set to 40 bytes, second E field in the extension part set to '0', second LI field set to 40 bytes and P field set to "1"?	-->	AMD PDU(AMD PDU header(P='1', FI='00', SN=1, E ₁ '='1', LI ₁ '='40', E ₂ '='0', LI ₂ '='40'), three RLC SDUs of size 40 bytes)	1, 2	P
11	The SS transmits a STATUS PDU.	<--	STATUS PDU (ACK SN=2)	-	-
Note 1	UL grant of 776 bits ($I_{TBS}=11$, $N_{PRB}=4$, see TS 36.213 Table 7.1.7.2.1-1) is chosen such that UE will fit two RLC SDUs of 40 bytes within one AMD PDU. MAC PDU of 776 bits=97 bytes fits an AMD PDU payload of 80 bytes (two 40 byte RLC SDUs) + 4 bytes AMD PDU header + 13 bytes spare for MAC header and possible RLC STATUS PDU and BSR report.				
Note 2	UL grant of 1096 bits ($I_{TBS}=8$, $N_{PRB}=8$, see TS 36.213 Table 7.1.7.2.1-1) is chosen such that UE will fit three RLC SDUs of 40 bytes within one AMD PDU. MAC PDU of 1096 bits=137 bytes fits an AMD PDU payload of 120 bytes (three 40 byte RLC SDUs) + 5 bytes AMD PDU header + 12 bytes spare for MAC header and possible RLC STATUS PDU and BSR report.				

7.2.3.1.3.3 Specific message contents

None.

7.2.3.2 AM RLC / Segmentation and reassembly / No PDU segmentation

7.2.3.2.1 Test Purpose (TP)

(1)

```

with { UE in E-UTRA RRC_CONNECTED state }
  ensure that {
    when { the UE has a RLC SDU with larger size than available AMD PDU size in the transmission
buffer }

```



```

    then { the UE segments the RLC SDU in accordance with the available AMD PDU size }
  }

```

(2)

```

with { UE in E-UTRA RRC_CONNECTED state }
ensure that {
  when { the UE receives AMD PDUs containing a segmented RLC SDU }
  then { the UE reassembles the RLC SDUs in accordance with the Framing Info and Length Indicators
indicated in the AMD PDUs }
}

```

7.2.3.2.2 Conformance requirements

References: The conformance requirements covered in the current TC are specified in: TS 36.322, clauses 4.2.1.3.2, 4.2.1.3.3 and 6.2.2.6.

[TS 36.322, clause 4.2.1.3.2]

When the transmitting side of an AM RLC entity forms AMD PDUs from RLC SDUs, it shall:

- segment and/or concatenate the RLC SDUs so that the AMD PDUs fit within the total size of RLC PDU(s) indicated by lower layer at the particular transmission opportunity notified by lower layer.

...

[TS 36.322, clause 4.2.1.3.3]

When the receiving side of an AM RLC entity receives RLC data PDUs, it shall:

....

- reassemble RLC SDUs from the reordered RLC data PDUs and deliver the RLC SDUs to upper layer in sequence.

...

[TS 36.322, clause 6.2.2.6]

...

The FI field indicates whether a RLC SDU is segmented at the beginning and/or at the end of the Data field. Specifically, the FI field indicates whether the first byte of the Data field corresponds to the first byte of a RLC SDU, and whether the last byte of the Data field corresponds to the last byte of a RLC SDU. The interpretation of the FI field is provided in Table 6.2.2.6-1.

Table 6.2.2.6-1: FI field interpretation

Value	Description
00	First byte of the Data field corresponds to the first byte of a RLC SDU. Last byte of the Data field corresponds to the last byte of a RLC SDU.
01	First byte of the Data field corresponds to the first byte of a RLC SDU. Last byte of the Data field does not correspond to the last byte of a RLC SDU.
10	First byte of the Data field does not correspond to the first byte of a RLC SDU. Last byte of the Data field corresponds to the last byte of a RLC SDU.
11	First byte of the Data field does not correspond to the first byte of a RLC SDU. Last byte of the Data field does not correspond to the last byte of a RLC SDU.

7.2.3.2.3 Test description

7.2.3.2.3.1 Pre-test conditions

System Simulator:

- Cell 1.

UE:

None.

Preamble:

- The UE is in state Loopback Activated (state 4) according to [18].

7.2.3.2.3.2 Test procedure sequence

Table 7.2.3.2.3.2-1: Main behaviour

St	Procedure	Message Sequence		TP	Verdict
		U - S	Message/PDU/SDU		
1	During the whole test sequence, the SS should not allocate UL grants unless when explicitly stated so in the procedure.	-	-	-	-
2	The SS transmits a RLC SDU of size 80 bytes segmented into two AMD PDUs. The two AMD PDUs are transmitted in separate TTIs.	<--	(RLC SDU#1) AMD PDU#1(FI='01',SN=0) AMD PDU#2(FI='10',SN=1)	-	-
3	60 ms after step 2 the SS allocates 2 UL grants (UL grant allocation type 2) with a time spacing of 5 ms of size 392 bits. (Note 1).	<--	(UL grants)	-	-
4	Check: Does the UE return a RLC SDU with equal content as sent in downlink in step 2 segmented into two AMD PDUs and received in different TTIs? (Note2: Details for AMD PDU#2)	-->	(RLC SDU#1) AMD PDU#1 AMD PDU#2	1,2	P
5	The SS transmits a STATUS PDU.	<--	STATUS PDU (ACK SN=2)	-	-
6	The SS sends a RLC SDU of size 120 bytes octets segmented into three AMD PDUs.	<--	(RLC SDU#2) AMD PDU#1(FI='01',SN=2) AMD PDU#2(FI='11',SN=3) AMD PDU#3(FI='10',SN=4)	-	-
7	60 ms after step 6 the SS allocates 3 UL grants (UL grant allocation type 2) with a time spacing of 5 ms of size 392 bits. (Note 1).	<--	(UL grants)	-	-
8	Check: Does the UE return a RLC SDU with equal content as sent in downlink in step 6 segmented into three AMD PDUs where each AMD PDU is received in different TTI? (Note2: Details for AMD PDU#3)	-->	(RLC SDU#2) AMD PDU#1 AMD PDU#2 AMD PDU#3	1,2	P
9	The SS transmits a STATUS PDU.	<--	STATUS PDU (ACK SN=5)	-	-
<p>Note 1: UL grant of 392 bits ($I_{TBS}=8$, $N_{PRB}=3$, see TS 36.213 Table 7.1.7.2.1-1) is chosen to force the UE to segment the returned UL RLC SDU into multiple AMD PDUs. An UL grant of 392 bits=49 bytes allows the UE to transmit one AMD PDU of maximum 46 bytes (49 bytes – 2 byte AMD PDU header - minimum 1 byte MAC header). UE at step 4 and step 8 during transmission of AMD PDU#1 will transmit BSR MCE which will take 2 bytes and hence AMD PDU size will be 44 bytes.</p> <p>Note2: Polling bit will be set for this PDU by the UE and SS transmits a STATUS PDU.</p>					

7.2.3.2.3.3 Specific message contents

None.

7.2.3.3 AM RLC / Segmentation and reassembly / Framing info field

7.2.3.3.1 Test Purpose (TP)

(1)

```
with { UE in E-UTRA RRC_CONNECTED state }
ensure that {
  when { UE receives an AMD PDU or an AMD PDU segment containing a FI field set to 00 }
  then { UE correctly decodes the received AMD PDU or AMD PDU segment }
}
```

(2)

```
with { UE in E-UTRA RRC_CONNECTED state }
ensure that {
  when { UE receives an AMD PDU or an AMD PDU segment containing a FI field set to 01 }
  then { UE correctly decodes the received AMD PDU or AMD PDU segment }
}
```

(3)

```

with { UE in E-UTRA RRC_CONNECTED state }
ensure that {
  when { UE receives an AMD PDU or an AMD PDU segment containing a FI field set to 11 }
  then { UE correctly decodes the received AMD PDU or AMD PDU segment }
}

```

(4)

```

with { UE in E-UTRA RRC_CONNECTED state }
ensure that {
  when { UE receives an AMD PDU or an AMD PDU segment containing a FI field set to 10 }
  then { UE correctly decodes the received AMD PDU or AMD PDU segment }
}

```

7.2.3.3.2 Conformance requirements

References: The conformance requirements covered in the present TC are specified in: TS 36.322, clause 6.2.2.6.

[TS 36.322, clause 6.2.2.6]

Length: 2 bits.

The FI field indicates whether a RLC SDU is segmented at the beginning and/or at the end of the Data field. Specifically, the FI field indicates whether the first byte of the Data field corresponds to the first byte of a RLC SDU, and whether the last byte of the Data field corresponds to the last byte of a RLC SDU. The interpretation of the FI field is provided in Table 6.2.2.6-1.

Table 6.2.2.6-1: FI field interpretation

Value	Description
00	First byte of the Data field corresponds to the first byte of a RLC SDU. Last byte of the Data field corresponds to the last byte of a RLC SDU.
01	First byte of the Data field corresponds to the first byte of a RLC SDU. Last byte of the Data field does not correspond to the last byte of a RLC SDU.
10	First byte of the Data field does not correspond to the first byte of a RLC SDU. Last byte of the Data field corresponds to the last byte of a RLC SDU.
11	First byte of the Data field does not correspond to the first byte of a RLC SDU. Last byte of the Data field does not correspond to the last byte of a RLC SDU.

7.2.3.3.3 Test description

7.2.3.3.3.1 Pre-test conditions

System Simulator:

- Cell 1.

UE:

None.

Preamble:

- The UE is in state Loopback Activated (state 4) according to [18].

7.2.3.3.3.2 Test procedure sequence

Table 7.2.3.3.3.2-1: Main behaviour

St	Procedure	Message Sequence		TP	Verdict
		U - S	Message		
1	The SS transmits AMD PDU#1 containing a complete RLC SDU#1 (FI field = 00).	<--	AMD PDU#1	-	-
2	Check: Does the UE transmit RLC SDU#1?	-->	(RLC SDU#1)	1	P
2A	The SS transmits a STATUS PDU.	<--	STATUS PDU (ACK SN=1)	-	-
3	The SS transmits AMD PDU#2 containing the first segment of RLC SDU#2 (FI field = 01).	<--	AMD PDU#2	-	-
4	The SS transmits AMD PDU#3 containing the second segment of RLC SDU#2 (FI field = 11).	<--	AMD PDU#3	-	-
5	The SS transmits AMD PDU#4 containing the last segment of RLC SDU#2 (FI field = 10).	<--	AMD PDU#4	-	-
6	Check: Does the UE transmit RLC SDU#2?	-->	(RLC SDU#2)	2,3, 4	P
6A	The SS transmits a STATUS PDU.	<--	STATUS PDU (ACK SN=2)	-	-
7	The <i>t-PollRetransmit</i> timer for RLC PDU#5 expires and SS assumes that the transmission of AMD PDU#5 containing a complete RLC SDU#3 and a complete RLC SDU#4 is failed and consider RLC PDU#5 for re-transmission	-	-	-	-
8	The SS transmits AMD PDU segment containing a complete RLC SDU#3 (FI field = 00).	<--	AMD PDU segment	-	-
9	Check: Does the UE transmit RLC SDU#3?	-->	(RLC SDU#3)	1	P
9A	The SS transmits a STATUS PDU.	<--	STATUS PDU (ACK SN=3)	-	-
10	The SS transmits AMD PDU segment containing the first segment of RLC SDU#4 (FI field = 01).	<--	AMD PDU segment	-	-
11	The SS transmits AMD PDU segment containing the second segment of RLC SDU#4 (FI field = 11).	<--	AMD PDU segment	-	-
12	The SS transmits AMD PDU segment containing the last segment of RLC SDU#4 (FI field = 10).	<--	AMD PDU segment	-	-
13	Check: Does the UE transmit RLC SDU#4?	-->	(RLC SDU#4)	2,3, 4	P
14	The SS transmits a STATUS PDU.	<--	STATUS PDU (ACK SN=4)	-	-

7.2.3.3.3.3 Specific message contents

None.

7.2.3.4 AM RLC / Segmentation and reassembly / Different numbers of length indicators

7.2.3.4.1 Test Purpose (TP)

(1)

```
with { UE in E-UTRA RRC_CONNECTED state }
ensure that {
  when { UE receives an AMD PDU or an AMD PDU segment with no LI field }
  then { UE correctly decodes the received AMD PDU or AMD PDU segment }
}
```

(2)

```
with { UE in E-UTRA RRC_CONNECTED state }
ensure that {
  when { UE receives an AMD PDU or an AMD PDU segment with one LI field }
  then { UE correctly decodes the received AMD PDU or AMD PDU segment }
}
```

(3)

```

with { UE in E-UTRA RRC_CONNECTED state }
ensure that {
  when { UE receives an AMD PDU or an AMD PDU segment with two LI fields }
  then { UE correctly decodes the received AMD PDU or AMD PDU segment }
}

```

7.2.3.4.2 Conformance requirements

References: The conformance requirements covered in the present TC are specified in: TS 36.322, clause 6.2.2.5.

[TS 36.322, clause 6.2.2.5]

Length: 11 bits.

The LI field indicates the length in bytes of the corresponding Data field element present in the RLC data PDU delivered/received by an UM or an AM RLC entity. The first LI present in the RLC DATA PDU header corresponds to the first Data field element present in the Data field of the RLC DATA PDU, the second LI present in the RLC DATA PDU header corresponds to the second Data field element present in the Data field of the RLC DATA PDU, and so on. The value 0 is reserved.

7.2.3.4.3 Test description

7.2.3.4.3.1 Pre-test conditions

System Simulator:

- Cell 1.

UE:

None.

Preamble:

- The UE is in state Loopback Activated (state 4) according to [18] with the exceptions listed in table 7.2.3.4.3.1-1.

Table 7.2.3.4.3.1-1: RLC settings

Parameter	Value
t-Reordering	150 ms

7.2.3.4.3.2 Test procedure sequence

Table 7.2.3.4.3.2-1: Main behaviour

St	Procedure	Message Sequence		TP	Verdict
		U - S	Message		
-	During the whole test sequence, the SS should not allocate UL grants unless when explicitly stated so in the procedure.	-	-	-	-
1	The SS transmits AMD PDU#1 containing a complete RLC SDU#1 without LI field.	<--	AMD PDU#1	-	-
2	The SS transmits an uplink grant allowing the UE to transmit 1 RLC SDU.	<--	(UL grant)	-	-
3	Check: Does the UE transmit an AMD PDU containing RLC SDU#1?	-->	AMD PDU (RLC SDU#1)	1	P
3A	The SS transmits a STATUS PDU.	<--	STATUS PDU (ACK SN=1)	-	-
4	The SS transmits AMD PDU#2 containing a complete RLC SDU#2 and a complete RLC SDU#3 with one LI field.	<--	AMD PDU#2	-	-
5	The SS waits for 60 ms then assigns an UL grant sufficient for the UE to loopback RLC SDU#2 and RLC SDU#3.	<--	(UL grant)	-	-
6	Check: Does the UE transmit an AMD PDU containing RLC SDU#2 and RLC SDU#3 in its data field?	-->	AMD PDU (RLC SDU#2, RLC SDU#3)	2	P
7	The SS transmits a STATUS PDU.	<--	STATUS PDU (ACK SN=2)	-	-
8	The SS transmits AMD PDU#3 containing a complete RLC SDU#4, a complete RLC SDU#5 and a complete RLC SDU#6 with two LI fields.	<--	AMD PDU#3	-	-
9	The SS waits for 60 ms then assigns an UL grant sufficient for the UE to loopback RLC SDU#4, RLC SDU#5 and RLC SDU#6.	<--	(UL grant)	-	-
10	Check: Does the UE transmit an AMD PDU containing RLC SDU#4, RLC SDU#5 and RLC SDU#6 in its data field?	-->	AMD PDU (RLC SDU#4, RLC SDU#5, RLC SDU#6)	3	P
11	The SS transmits a STATUS PDU.	<--	STATUS PDU (ACK SN=3)	-	-
12	Void	-	-	-	-
13	The <i>t-PollRetransmit</i> timer for AMD PDU#4 expires and SS assumes that the transmission of AMD PDU#4 containing a complete RLC SDU#7, a complete RLC SDU#8, a complete RLC SDU#9, a complete RLC SDU#10, a complete RLC SDU#11 and a complete RLC SDU#12 is failed and consider AMD PDU#4 for re-transmission.	-	-	-	-
14	The SS transmits AMD PDU segment containing a complete RLC SDU#7 without LI field.	<--	AMD PDU segment	-	-
15	The SS waits for 60 ms and then assigns an uplink grant (UL grant allocation type 3) allowing the UE to transmit 1 RLC SDU.	<--	(UL grant)	-	-
16	Check: Does the UE transmit an AMD PDU containing RLC SDU#7?	-->	AMD PDU (RLC SDU#7)	1	P
16 A	The SS transmits a STATUS PDU.	<--	STATUS PDU (ACK SN=4)	-	-
17	The SS transmits AMD PDU segment containing a complete RLC SDU#8 and a complete RLC SDU#9 with one LI field.	<--	AMD PDU segment	-	-
18	The SS waits for 60 ms and then assigns an UL grant (UL grant allocation type 3) sufficient for the UE to loopback RLC SDU#8 and RLC SDU#9.	<--	(UL grant)	-	-
19	Check: Does the UE transmit an AMD PDU containing RLC SDU#8 and RLC SDU#9 in its data field?	-->	AMD PDU (RLC SDU#8, RLC SDU#9)	2	P
20	The SS transmits a STATUS PDU.	<--	STATUS PDU (ACK SN=5)	-	-

21	The SS transmits AMD PDU segment containing a complete RLC SDU#10, a complete RLC SDU#11 and a complete RLC SDU#12 with two LI fields.	<--	AMD PDU segment	-	-
22	The SS waits for 60 ms and then assigns an UL grant (UL grant allocation type 3) sufficient for the UE to loopback RLC SDU#10, RLC SDU#11 and RLC SDU#12.	<--	(UL grant)	-	-
23	Check: Does the UE transmit an AMD PDU containing RLC SDU#10, RLC SDU#11 and RLC SDU#12 in its data field?	-->	AMD PDU (RLC SDU#10, RLC SDU#11, RLC SDU#12)	3	P
24	The SS transmits a STATUS PDU.	<--	STATUS PDU (ACK SN=6)	-	-
25	Void	-	-	-	-

7.2.3.4.3.3 Specific message contents

None.

7.2.3.5 AM RLC / Reassembly / LI value > PDU size

7.2.3.5.1 Test Purpose (TP)

(1)

```
with { UE in E-UTRA RRC_CONNECTED state }
ensure that {
  when { UE receives PDU with "Length Indicators" that point beyond the end of the PDU }
  then { UE discards PDU }
}
```

7.2.3.5.2 Conformance requirements

References: The conformance requirements covered in the present TC are specified in: 3GPP TS 36.322 clauses 5.5.1 and 6.2.2.5.

[TS 36.322, clause 5.5.1]

When an RLC entity receives an RLC PDU that contains reserved or invalid values, the RLC entity shall:

- discard the received PDU.

[TS 36.322, clause 6.2.2.5]

Length: 11 bits.

The LI field indicates the length in bytes of the corresponding Data field element present in the RLC data PDU. The first LI present in the RLC data PDU header corresponds to the first Data field element present in the Data field of the RLC data PDU, the second LI present in the RLC data PDU header corresponds to the second Data field element present in the Data of the RLC data PDU, and so on. The value 0 is reserved.

7.2.3.5.3 Test description

7.2.3.5.3.1 Pre-test conditions

System Simulator:

- Cell 1.

UE:

None.

Preamble:

- The UE is in state Loopback Activated (state 4) according to [18] with the loopback size set to 98 bytes.

7.2.3.5.3.2 Test procedure sequence

Table 7.2.3.5.3.2-1: Main behaviour

St	Procedure	Message Sequence		TP	Verdict
		U - S	Message/PDU/SDU		
0	During the whole test sequence, the SS should not allocate UL grants unless when explicitly stated so in the procedure.	-	-	-	-
1	The SS transmits an AMD PDU containing the first half (50 bytes) of SDU#1 in its data field to the UE.	<--	AMD PDU#1 (SN = 0)	-	-
2	The SS transmits an AMD PDU containing the second half (50 bytes) of SDU#1 and the first half (50 bytes) of SDU#2 in its data field to the UE. LI associated with PDU#2 has a value > PDU size, i.e. > 100.	<--	AMD PDU#2 (SN=1)	-	-
3	The SS transmits an AMD PDU containing the second half (50 bytes) of SDU#2 and the first half (50 bytes) of SDU#3 in its data field to the UE.	<--	AMD PDU#3 (SN=2)	-	-
4	The SS transmits an AMD PDU containing the second half (50 bytes) of SDU#3 in its data field to the UE.	<--	AMD PDU#4 (SN=3)	-	-
4A	100 ms after step 4 the SS assigns an UL grant (UL grant allocation type 3) of size 56 bits (Note 1).	<--	(UL grant, 56 bits)	-	-
5	Check: Does the UE transmit a STATUS PDU with NACK_SN field set to 1?	-->	STATUS PDU	1	P
6	The SS transmits an AMD PDU containing the second half (50 bytes) of SDU#1 and the first half (50 bytes) of SDU#2 in its data field to the UE. The LI is correct.	<--	AMD PDU#2 (SN=1)	-	-
6A	The SS waits for 60 ms to ensure UE RLC has all the required SDU available in UL for loopback.				
6B	The SS transmits an UL grant (UL grant allocation type 3) of size 2536 bits (Note 2).	<--	(UL grant, 2536 bits)	-	-
7	Check: Does the UE transmit RLC SDU#1, SDU#2, and SDU#3? (Note 3: Details for RLC PDU carrying RLC SDU#3)	-->	AMD PDU(RLC SDU#1, RLC SDU#2, RLC SDU#3)	1	P
8	The SS transmits a STATUS PDU.	<--	STATUS PDU (ACK SN=1)	-	-
Note 1: UL grant of 56 bits ($I_{TBS}=1$, $N_{PRB}=2$, see TS 36.213 Table 7.1.7.2.1-1) is chosen such that UE will be enabled to send the status PDU. Note 2: UL grant of 2536 bits ($I_{TBS}=13$, $N_{PRB}=10$, see TS 36.213 Table 7.1.7.2.1-1) is chosen such that UE will fit all 3 SDU in one AMD PDU. Note 3: In step 7, poll is set so SS will send STATUS PDU to UE in step 8.					

7.2.3.5.3.3 Specific message contents

None.

7.2.3.6 AM RLC / Correct use of sequence numbering

7.2.3.6.1 Test Purpose (TP)

(1)

```

with { UE in E-UTRA RRC_CONNECTED state }
ensure that {
  when { UE transmits the first PDU }
  then { UE sets the Sequence Number field equal to 0 }
}

```

(2)

```

with { UE in E-UTRA RRC_CONNECTED state }

```



```

ensure that {
  when { UE transmits subsequent PDUs }
  then { SN incremented by 1 for each PDU transmitted }
}

```

(3)

```

with { UE in E-UTRA RRC_CONNECTED state }
ensure that {
  when { UE transmits more than 1024 PDUs }
  then { UE wraps the Sequence Number after transmitting the 1024 PDU }
}

```

(4)

```

with { UE in E-UTRA RRC_CONNECTED state }
ensure that {
  when { more than 1024 PDUs are sent to UE }
  then { UE accepts PDUs with SNs that wrap around every 1024 PDU }
}

```

7.2.3.6.2 Conformance requirements

References: The conformance requirements covered in the present TC are specified in: 3GPP TS 36.322 clauses 5.1.3.1.1, 6.2.2.3 and 7.1.

[TS 36.322, clause 5.1.3.1.1]

The transmitting side of an AM RLC entity shall prioritize transmission of RLC control PDUs over RLC data PDUs. The transmitting side of an AM RLC entity shall prioritize retransmission of RLC data PDUs over transmission of new AMD PDUs.

The transmitting side of an AM RLC entity shall maintain a transmitting window according to state variables VT(A) and VT(MS) as follows:

- a SN falls within the transmitting window if $VT(A) \leq SN < VT(MS)$;
- a SN falls outside of the transmitting window otherwise.

The transmitting side of an AM RLC entity shall not deliver to lower layer any RLC data PDU whose SN falls outside of the transmitting window.

When delivering a new AMD PDU to lower layer, the transmitting side of an AM RLC entity shall:

- set the SN of the AMD PDU to VT(S), and then increment VT(S) by one.

The transmitting side of an AM RLC entity can receive a positive acknowledgement (confirmation of successful reception by its peer AM RLC entity) for a RLC data PDU by the following:

- STATUS PDU from its peer AM RLC entity.

When receiving a positive acknowledgement for an AMD PDU with $SN = VT(A)$, the transmitting side of an AM RLC entity shall:

- set VT(A) equal to the SN of the AMD PDU with the smallest SN, whose SN falls within the range $VT(A) \leq SN \leq VT(S)$ and for which a positive acknowledgment has not been received yet.
- if positive acknowledgements have been received for all AMD PDUs associated with a transmitted RLC SDU :- send an indication to the upper layers of successful delivery of the RLC SDU.

[TS 36.322, clause 6.2.2.3]

Length: 10bits for AMD PDU, AMD PDU segments and STATUS PDUs. ...

The SN field indicates the sequence number of the corresponding ... AMD PDU. For an AMD PDU segment, the SN field indicates the sequence number of the original AMD PDU from which the AMD PDU segment was constructed from. The sequence number is incremented by one for every ... AMD PDU.

[TS 36.322, clause 7.1]

...

All state variables and all counters are non-negative integers.

All state variables related to AM data transfer can take values from 0 to 1023. All arithmetic operations contained in the present document on state variables related to AM data transfer are affected by the AM modulus (i.e. final value = [value from arithmetic operation] modulo 1024).

AMD PDUs ... are numbered integer sequence numbers (SN) cycling through the field: 0 to 1023 for AMD PDU ...

...

c) VT(S) – Send state variable

This state variable holds the value of the SN to be assigned for the next newly generated AMD PDU. It is initially set to 0, and is updated whenever the AM RLC entity delivers an AMD PDU with SN = VT(S).

...

7.2.3.6.3 Test description

7.2.3.6.3.1 Pre-test conditions

System Simulator:

- Cell 1.

UE:

None.

Preamble:

- UE is in state Loopback Activated (state 4) according to [18].

7.2.3.6.3.2 Test procedure sequence

Table 7.2.3.6.3.2-1: Main behaviour

St	Procedure	Message Sequence		TP	Verdict
		U - S	Message/PDU/SDU		
-	During the whole test sequence, the SS should not allocate UL grants unless when explicitly stated so in the procedure.	-	-	-	-
-	EXCEPTION: SS is configured 500ms in advance for step 1 and 2. Step 1 is executed 512 times such that 1 AMD PDU is transmitted every second radio frame. (Note 1) . Step 2 is started 60 ms after the first DL AMD PDU has been transmitted in step 1 (Note 1).	-	-	-	-
-	EXCEPTION: In parallel to steps 1 and 2, the behaviour described in table 7.2.3.6.3.2-2 is running.	-	-	-	-
1	The SS transmits an AMD PDU to the UE. SN equals 0 and is incremented for each PDU transmitted (Note 1).	<--	AMD PDU	-	-
2	The SS transmits 1 UL grant (UL grant allocation type 2) in every second radio frame to enable the UE to return each received AMD PDU in one looped back AMD PDU (Note 1).	<--	(UL grants)	-	-
2A	The SS does not allocate any uplink grant.	-	-	-	-
-	EXCEPTION: SS is configured 500ms in advance for step 2B and 2C. Step 2B is executed 512 times such that 1 AMD PDU is transmitted every second radio frame. (Note 1) . Step 2C is started 60 ms after the first DL AMD PDU has been transmitted in step 2B (Note 1).	-	-	-	-
-	EXCEPTION: In parallel to steps 2B and 2C, the behaviour described in table 7.2.3.6.3.2-3 is running.	-	-	-	-
2B	The SS transmits an AMD PDU to the UE. SN equals 512 and is incremented for each PDU transmitted.	<--	AMD PDU	-	-
2C	The SS transmits 1 UL grant (UL grant allocation type 2) in every second radio frame to enable the UE to return each received AMD PDU in one looped back AMD PDU (Note 1) .	<--	(UL grants)	-	-
3	The SS transmits an AMD PDU to the UE. SN equals 0.	<--	AMD PDU	-	-
4	Void	-	-	-	-
4A	The SS starts the UL default grant transmission	-	-	-	-
5	Check: Does the UE transmit an AMD PDU with SN=0?	-->	AMD PDU	3,4	P
6	The SS transmits a STATUS PDU with ACK_SN = 1.	<--	STATUS PDU	-	-
<p>Note 1: 20 ms gap between transmissions both in DL and UL respectively allows TTCN to tolerate one HARQ retransmission (FDD/TDD) per transport block, if such happen (TS 36.523-3).</p> <p>Note 2: Delaying first UL grant for 60 ms, ensures that UE UL buffer does not become empty every time one UL AMD PDU is sent i.e. UE does not enable polling for every UL AMD PDU. SS continuously transmits the grants until it has received all PDUs in UL.</p>					

Table 7.2.3.6.3.2-2: Parallel behaviour

St	Procedure	Message Sequence		TP	Verdict
		U - S	Message		
1	Check: Does the UE transmit an AMD PDU with SN = 0?	-->	AMD PDU	1	P
-	EXCEPTION: Steps 2 and 3a1 are executed 511 times.	-	-	-	-
2	Check: Does the UE transmit an AMD PDU with SN increased by 1 compared with the previous one?	-->	AMD PDU	2	P
	EXCEPTION: Step 3a1 describes behaviour that depends on the contents of the AMD PDU transmitted at Step 2.	-	-	-	-
3a1	IF the UE has set the poll bit in the AMD PDU transmitted at Step 2 THEN the SS transmits a Status Report.	<--	STATUS PDU	-	-

Table 7.2.3.6.3.2-3: Parallel behaviour

St	Procedure	Message Sequence		TP	Verdict
		U - S	Message		
-	EXCEPTION: Steps 1 and 2a1 are executed 512 times.	-	-	-	-
1	Check: Does the UE transmit an AMD PDU with SN increased by 1 compared with the previous one?	-->	AMD PDU	2	P
	EXCEPTION: Step 2a1 describes behaviour that depends on the contents of the AMD PDU transmitted at Step 1.	-	-	-	-
2a1	IF the UE has set the poll bit in the AMD PDU transmitted at Step 1 THEN the SS transmits a Status Report.	<--	STATUS PDU	-	-

7.2.3.6.3.3 Specific message contents

None.

7.2.3.7 AM RLC / Control of transmit window

7.2.3.7.1 Test Purpose (TP)

(1)

```
with { UE in E-UTRA RRC_CONNECTED state with DRB established and pending uplink data for
transmission }
ensure that {
  when { AMD PDUs in transmission buffer fall outside VT(A) <= SN < VT(MS) }
  then { UE does not transmit these AMD PDUs }
}
```

(2)

```
with { UE in E-UTRA RRC_CONNECTED state with DRB established and pending uplink data for
transmission }
ensure that {
  when { receiving a STATUS PDU where ACK_SN acknowledges at least one AMD PDU not yet acknowledged }
  then { UE transmits AMD PDUs within updated window range }
}
```

7.2.3.7.2 Conformance requirements

References: The conformance requirements covered in the present TC are specified in: 3GPP TS 36.322 clauses 5.1.3.1.1, 7.1 and 7.2.

[TS 36.322, clause 5.1.3.1.1]

...

The transmitting side of an AM RLC entity shall maintain a transmitting window according to state variables VT(A) and VT(MS) as follows:

- a SN falls within the transmitting window if $VT(A) \leq SN < VT(MS)$;
- a SN falls outside of the transmitting window otherwise.

The transmitting side of an AM RLC entity shall not deliver to lower layer any RLC data PDU whose SN falls outside of the transmitting window.

When delivering a new AMD PDU to lower layer, the transmitting side of an AM RLC entity shall:

- set the SN of the AMD PDU to VT(S), and then increment VT(S) by one.

The transmitting side of an AM RLC entity can receive a positive acknowledgement (confirmation of successful reception by its peer AM RLC entity) for a RLC data PDU by the following:

- STATUS PDU from its peer AM RLC entity.

When receiving a positive acknowledgement for an AMD PDU with $SN = VT(A)$, the transmitting side of an AM RLC entity shall:

- set VT(A) equal to the SN of the AMD PDU with the smallest SN, whose SN falls within the range $VT(A) \leq SN \leq VT(S)$ and for which a positive acknowledgment has not been received yet.
- if positive acknowledgements have been received for all AMD PDUs associated with a transmitted RLC SDU :
 - send an indication to the upper layers of successful delivery of the RLC SDU.

[TS 36.322, clause 7.2]

a) AM_Window_Size

This constant is used by both the transmitting side and the receiving side of each AM RLC entity to calculate VT(MS) from VT(A), and VR(MR) from VR(R). AM_Window_Size = 512.

...

[TS 36.322, clause 7.1]

...

a) VT(A) – Acknowledgement state variable

This state variable holds the value of the SN of the next AMD PDU for which a positive acknowledgment is to be received in-sequence, and it serves as the lower edge of the transmitting window). It is initially set to 0, and is updated whenever the AM RLC entity receives a positive acknowledgment for an AMD PDU with $SN = VT(A)$.

b) VT(MS) – Maximum send state variable

This state variable equals $VT(A) + AM_Window_Size$, and it serves as the higher edge of the transmitting window.

...

7.2.3.7.3 Test description

7.2.3.7.3.1 Pre-test conditions

System Simulator:

- Cell 1.

UE:

None.

Preamble:

- UE is in state Loopback Activated (state 4) according to [18] with the loopback size set to 100 bytes, and with the expectations listed in table 7.2.3.7.3.1-1.

Table 7.2.3.7.3.1-1: RLC Settings

Parameter	Value
PollPDU	plInfinity
PollByte	kBinfinity
t-PollRetransmit	ms300

Table 7.2.3.7.3.1-2: SchedulingRequest-Config

Derivation Path: 36.508 Table 4.6.3-20			
Information Element	Value/remark	Comment	Condition
dscr-TransMax	n8		

7.2.3.7.3.2 Test procedure sequence

Table 7.2.3.7.3.2-1: Main behaviour

St	Procedure	Message Sequence		TP	Verdict
		U - S	Message		
-	The SS does not allocate any uplink grant.	-	-	-	-
-	EXCEPTION: The SS is configured for step 1 and 1A 500ms in advance. Step 1 is repeated W+1 times, where W = AM_Window_Size. The transmission is performed every second radio frame. (Note 2). Step 1A is started 100 ms after the first DL AMD PDU has been transmitted in step 1.	-	-	-	-
-	EXCEPTION: In parallel to steps 1 and 1A, the behaviour described in table 7.2.3.7.3.2-2 is running.	-	-	-	-
1	The SS transmits an AMD PDU containing a SDU to the UE.	<--	AMD PDU	-	-
1A	In the following steps the SS transmits 1 UL grant (UL grant allocation type 2) in every second radio frame to enable the UE to return each received AMD PDU in one looped back AMD PDU. (Note 2)	<--	(UL grants)	-	-
1B	Void	-	-	-	-
1C	Check: Does the UE transmit an AMD PDU with the Poll bit set and with the contents of the SDU?	-->	AMD PDU(SN=W-1), Poll	1	P
1D	The SS starts the UL default grant transmission	-	-	-	-
2	Check: Does the UE transmit an AMD PDU within <i>t-PollRetransmit</i> ?	-->	AMD PDU	1	F
3	The SS transmits a STATUS PDU to acknowledge the W uplink AMD PDUs with SN=0 to SN=W-1. ACK_SN = W.	<--	STATUS PDU	-	-
3A	Check: Does the UE transmit an AMD PDU with the Poll bit set and with the contents of the SDU?	-->	AMD PDU(SN=W), Poll	2	P
3B	The SS transmits a STATUS PDU with ACK_SN = W+1.	<--	STATUS PDU	-	-

Note 1: SDUs are numbered 1,2, ..., W+1
 Note 2: 20 ms gap between transmissions both in DL and UL respectively allows TTCN to tolerate one HARQ retransmission (FDD/TDD) per transport block, if such happen (TS 36.523-3).

Table 7.2.3.7.3.2-2: Parallel behaviour

St	Procedure	Message Sequence		TP	Verdict
		U - S	Message		
-	EXCEPTION: Step 1 is executed W-1 times.	-	-	-	-
1	The UE transmits an AMD PDU with the same data as received in the corresponding DL AMD PDU.	-->	AMD PDU	-	-

7.2.3.7.3.3 Specific message contents

None.

7.2.3.8 AM RLC / Control of receive window

7.2.3.8.1 Test Purpose (TP)

(1)

```
with { UE in E-UTRA RRC_CONNECTED state }
ensure that {
  when { the UE receives AMD PDUs with SN outside the upper boundary of the receive window }
  then { the UE discards these AMD PDUs }
}
```

(2)

```
with { UE in E-UTRA RRC_CONNECTED state }
ensure that {
  when { the receive window has been moved }
  then { UE continues accepting AMD PDUs within updated window range }
}
```

7.2.3.8.2 Conformance requirements

References: The conformance requirements covered in the present TC are specified in: 3GPP TS 36.322 clauses 5.1.3.2.1 and 7.2.

[TS 36.322, clause 5.1.3.2.1]

The receiving side of an AM RLC entity shall maintain a receiving window according to state variables VR(R) and VR(MR) as follows:

- a SN falls within the receiving window if $VR(R) \leq SN < VR(MR)$;
- a SN falls outside of the receiving window otherwise.

When receiving a RLC data PDU from lower layer, the receiving side of an AM RLC entity shall:

- either discard the received RLC data PDU or place it in the reception buffer (see sub clause 5.1.3.2.2);
- if the received RLC data PDU was placed in the reception buffer:
 - update state variables, reassemble and deliver RLC SDUs to upper layer and start/stop *t-Reordering* as needed (see sub clause 5.1.3.2.3).

When *t-Reordering* expires, the receiving side of an AM RLC entity shall:

- update state variables and start *t-Reordering* as needed (see sub clause 5.1.3.2.4).

[TS 36.322, clause 7.2]

a) AM_Window_Size

This constant is used by both the transmitting side and the receiving side of each AM RLC entity to calculate VT(MS) from VT(A), and VR(MR) from VR(R). AM_Window_Size = 512.

...

7.2.3.8.3 Test description

7.2.3.8.3.1 Pre-test conditions

System Simulator:

- Cell 1.

UE:

None.

Preamble:

- The UE is in state Loopback Activated (state 4) according to [18] with a loopback size of 0 byte.

7.2.3.8.3.2 Test procedure sequence

Table 7.2.3.8.3.2-1: Main behaviour

St	Procedure	Message Sequence		TP	Verdict
		U - S	Message/PDU/SDU		
-	EXCEPTION: SS is configured 500ms in advance for step 1. Step 1 shall be repeated W times, where W is AM_Window_Size. Polling bit enabled for the Wth RLC PDU transmitted. The SS shall set the Sequence Number field for the first AMD PDU to 0 and increment it by 1 for every execution of Step 1. The transmission is performed in every second radio frame.(Note 3)	-	-	-	-
1	The SS transmits an AMD PDU to the UE	<--	AMD PDU		
2	Check: Does the UE transmit a STATUS PDU acknowledging W PDUs? (ACK_SN = W)	-->	STATUS PDU	1	P
3	The SS transmits the (W+1)th AMD PDU to the UE with the Sequence Number field set to $((2W \bmod 1024) = 0)$ and the Polling bit set.	<--	AMD PDU	-	-
4	Check: does the UE transmit a STATUS PDU acknowledging W PDUs? (ACK_SN = W) (Note 1)	-->	STATUS PDU	1	P
5	The SS transmits the (W+2)th AMD PDU to the UE with the Sequence Number field set to W and the Polling bit set.	<--	AMD PDU	-	-
6	Check: Does the UE transmit a STATUS PDU acknowledging W +1 PDUs? (ACK_SN field = W+1) (Note 2)	-->	STATUS PDU	2	P
Note 1: This shows that the UE has discarded the (W+1)th PDU. Note 2: This shows that the UE did not discard the (W+2)th PDU and has updated the Receive Window correctly. Note 3: 20 ms gap between transmissions both in DL and UL respectively allows TTCN to tolerate one HARQ retransmission (FDD/TDD) per transport block, if such happen (TS 36.523-3).					

7.2.3.8.3.3 Specific message contents

None.

7.2.3.9 AM RLC / Polling for status

7.2.3.9.1 Test Purpose (TP)

(1)

```
with { UE in E-UTRA RRC_CONNECTED state and using AM RLC }
ensure that {
  when { last data in the buffer was transmitted }
  then { UE transmits a Poll }
}
```

(2)

```
with { UE in E-UTRA RRC_CONNECTED state and using AM RLC }
ensure that {
  when { the t-PollRetransmit timer expires }
  then { UE transmits a Poll }
}
```

(3)

```
with { UE in E-UTRA RRC_CONNECTED state and using AM RLC }
ensure that {
  when { PDU_WITHOUT_POLL=pollPDU }
  then { UE transmits a Poll }
}
```

(4)

```
with { UE in E-UTRA RRC_CONNECTED state and using AM RLC }
ensure that {
  when { BYTE_WITHOUT_POLL=pollByte }
  then { UE transmits a Poll }
}
```

7.2.3.9.2 Conformance requirements

References: The conformance requirements covered in the present TC are specified in: 3GPP TS 36.322 clauses 5.2.2.

[TS 36.322, clause 5.2.2]

...

Upon assembly of a new AMD PDU, the transmitting side of an AM RLC entity shall:

- increment PDU_WITHOUT_POLL by one;
- increment BYTE_WITHOUT_POLL by every new byte of Data field element that it maps to the Data field of the RLC data PDU;
- if PDU_WITHOUT_POLL \geq *pollPDU*; or
- if BYTE_WITHOUT_POLL \geq *pollByte*;
 - include a poll in the RLC data PDU as described below.

Upon assembly of an AMD PDU or AMD PDU segment, the transmitting side of an AM RLC entity shall:

- if both the transmission buffer and the retransmission buffer becomes empty (excluding transmitted RLC data PDU awaiting for acknowledgements) after the transmission of the RLC data PDU; or
- if no further RLC data PDU can be transmitted after the transmission of the RLC data PDU (e.g. due to window stalling);
 - include a poll in the RLC data PDU as described below.

To include a poll in a RLC data PDU, the transmitting side of an AM RLC entity shall:

- set the P field of the RLC data PDU to "1";
- set PDU_WITHOUT_POLL to 0;
- set BYTE_WITHOUT_POLL to 0;

After delivering a RLC data PDU including a poll to lower layer and after incrementing of VT(S) if necessary, the transmitting side of an AM RLC entity shall:

- set POLL_SN to VT(S) – 1;
- if *t-PollRetransmit* is not running:

- start *t-PollRetransmit*;
- else:
 - restart *t-PollRetransmit*;

[TS 36.322, clause 5.2.2.3]

Upon expiry of *t-PollRetransmit*, the transmitting side of an AM RLC entity shall:

- if both the transmission buffer and the retransmission buffer are empty (excluding transmitted RLC data PDU awaiting for acknowledgements); or
- if no new RLC data PDU can be transmitted (e.g. due to window stalling):
 - consider the AMD PDU with $SN = VT(S) - 1$ for retransmission;
 - consider any AMD PDU which has not been positively acknowledged for retransmission;
- include a poll in a RLC data PDU as described in section 5.2.2.1.

7.2.3.9.3 Test description

7.2.3.9.3.1 Pre-test conditions

System Simulator:

- Cell 1.

UE:

None.

Preamble:

- UE is in state Loopback Activated (state 4) according to [18] with the exceptions listed in table 7.2.3.9.3.1-1 and 7.2.3.9.3.1-2.

Table 7.2.3.9.3.1-1: RLC Settings

Parameter	Value
<i>pollPDU</i>	p256
<i>pollByte</i>	kB25
<i>t-PollRetransmit</i>	ms400

Table 7.2.3.9.3.1-2: SchedulingRequest-Config

Derivation Path: 36.508 Table 4.6.3-20			
Information Element	Value/remark	Comment	Condition
dsr-TransMax	n8		

7.2.3.9.3.2 Test procedure sequence

Table 7.2.3.9.3.2-1: Main behaviour

St	Procedure	Message Sequence		TP	Verdict
		U - S	Message		
0	During the whole test sequence, the SS should not allocate UL grants unless when explicitly stated so in the procedure.	-	-	-	-
1	The SS transmits 4 AMD PDUs such that 1 AMD PDU is sent every second radio frame, each containing an RLC SDU of 2 560 bits. (Note 2)	<--	AMD PDU (SN=0) AMD PDU (SN=1) AMD PDU (SN=2) AMD PDU (SN=3)	-	-
-	EXCEPTION: In parallel to the events described in step 1A, the step specified in Table 7.2.3.9.3.2-2 should take place.	-	-	-	-
1A	The SS waits for 100 ms after the first DL AMD PDU has been transmitted in step 1, then starts assigning UL grants (UL grant allocation type 2) in every second radio frame of size 2 600 bits. (Note 1) (Note 2)	-	-	-	-
2	Check 1: Does the UE transmit an AMD PDU with a SN in range 0 to 3 and P=1? Record time T_B . Check 2: Is $(T_B - T_A) = t\text{-PollRetransmit}$?	-->	AMD PDU	2	P
2A	The SS starts the UL default grant transmission	-	-	-	-
3	Upon receiving the Poll, the SS transmits an RLC Status Report.	<--	STATUS PDU	-	-
4	Check: Does the UE retransmit an AMD PDU within 1 sec?	-->	AMD PDU	2	F
5	SS performs an RRC Connection Reconfiguration procedure changing <i>pollPDU</i> to p4.	-	-	-	-
5A	The SS does not allocate any UL grant.	-	-	-	-
6	The SS transmits 8 AMD PDUs such that 1 AMD PDU is sent every second radio frame, each containing an RLC SDU of 2 560 bits. (Note 2)	<--	AMD PDU (SN=4) AMD PDU (SN=5) ... AMD PDU (SN=11)	-	-
-	EXCEPTION: In parallel to the events described in step 6A, the step specified in Table 7.2.3.9.3.2-3 should take place.	-	-	-	-
6A	The SS waits for 100 ms after the first DL AMD PDU has been transmitted in step 6, then starts assigning UL grants (UL grant allocation type 2) in every second radio frame of size 2 600 bits. (Note 1) (Note 2)	-	-	-	-
7	The SS transmits a Status Report with ACK_SN=12, NACK_SN=4, NACK_SN=5, NACK_SN=6, NACK_SN=8 and NACK_SN=9.	<--	STATUS PDU	-	-
8	Check: Does the UE transmit AMD PDUs with the following SN and P values? AMD PDU, SN=4, P=0 AMD PDU, SN=5, P=0 AMD PDU, SN=6, P=0 AMD PDU, SN=8, P=0 AMD PDU, SN=9, P=1	-->	AMD PDU (SN=4, P=0) AMD PDU (SN=5, P=0) AMD PDU (SN=6, P=0) AMD PDU (SN=8, P=0) AMD PDU (SN=9, P=1)	3	P
8A	The SS starts the UL default grant transmission	-	-	-	-
8A	The SS transmits a Status Report with ACK_SN=12 and no NACK_SN.	<--	STATUS PDU	-	-
9	SS performs an RRC Connection Reconfiguration procedure changing <i>pollPDU</i> to p256.	-	-	-	-
9A	The SS does not allocate any UL grant.	-	-	-	-
10	After 500 ms the SS transmits 160 AMD PDUs such that 1 AMD PDU is sent every second	<--	AMD PDU (SN=12) AMD PDU (SN=13)	-	-

	radio frame, each containing an RLC SDU of size 2 560 bits. (Note 2)		... AMD PDU (SN=171)		
-	EXCEPTION: In parallel to the events described in step 10A, the steps specified in Table 7.2.3.9.3.2-4 should take place.	-	-	-	-
10 A	The SS waits for 100 ms after the first DL AMD PDU has been transmitted in step 10, then starts assigning UL grants (UL grant allocation type 2) in every second radio frame of size 2600 bits. (Note 1) (Note 2)	-	-	-	-
10 B	The SS starts the UL default grant transmission	-	-	-	-
<p>Note 1: UL grant of 2600 bits ($I_{TBS}=14$, $N_{PRB}=9$, see TS 36.213 Table 7.1.7.2.1-1) is chosen to allow the UE to loop back one SDU of size 2560 bits and one short BSR (8 bits) into each MAC PDU sent in the uplink (2600 bits - 16 bit AMD PDU header - 8 bit MAC BSR subheader - 8 bit MAC PDU subheader). The UE will include an SDU of size 2560 bits and one short BSR in the looped back MAC PDU.</p> <p>Note 2: 20ms gap between transmissions both in DL and UL respectively allows TTCN to tolerate one HARQ retransmission (FDD/TDD) per transport block, if such happen (TS 36.523-3).</p>					

Table 7.2.3.9.3.2-2: Parallel behaviour

St	Procedure	Message Sequence		TP	Verdict
		U - S	Message		
1	Check: Does the UE transmit 4 AMD PDUs, with only the last one having the poll bit set? Record time T_A when the PDU with the poll bit set is received at the SS.	-->	AMD PDUs	1	P

Table 7.2.3.9.3.2-3: Parallel behaviour

St	Procedure	Message Sequence		TP	Verdict
		U - S	Message		
1	Check: Does the UE transmit 8 AMD PDUs, with the poll bit set only in the 4 th and the 8 th PDUs?	-->	AMD PDUs	3	P

Table 7.2.3.9.3.2-4: Parallel behaviour

St	Procedure	Message Sequence		TP	Verdict
		U - S	Message		
1	Check: Does the UE transmit 79 AMD PDUs, with the poll bit set only in the last (79 th) one? (Note 1)	-->	AMD PDUs	1,4	P
2	The SS transmits an RLC Status Report.	<--	STATUS PDU	-	-
3	Check: Does the UE transmit 79 AMD PDUs, with the poll bit set only in the last (158 th) one? (Note 1)	-->	AMD PDUs	1,4	P
4	The SS transmits an RLC Status Report.	<--	STATUS PDU	-	-
5	Check: Does the UE transmit 2 AMD PDUs, with the poll bit set only in the last (160 th) one?	-->	AMD PDUs	1,4	P
6	The SS transmits an RLC Status Report.	<--	STATUS PDU	-	-
Note 1: (2560 bits x 79 PDUs) / 8 = 25 280 > 25 KB, with 1 kB = 1000 bytes (TS 36.331, cl. 3.2)					

7.2.3.9.3.3 Specific message contents

None.

7.2.3.10 AM RLC / Receiver status triggers

7.2.3.10.1 Test Purpose (TP)

(1)

```
with { UE in E-UTRA RRC_CONNECTED state and using AM RLC }
ensure that {
  when { Reception failure of an RLC data PDU is detected }
  then { UE initiates Status Reporting when t-Reordering expires }
}
```

(2)

```
with { UE in E-UTRA RRC_CONNECTED state and using AM RLC }
ensure that {
  when { Status Reporting is triggered and t-StatusProhibit is running }
  then { UE wait until t-StatusProhibit has expired to send Status Report }
}
```

(3)

```
with { UE in E-UTRA RRC_CONNECTED state and using AM RLC }
ensure that {
  when { Polling from peer AM RLC entity is detected and the sequence number of the PDU that carries
  the Poll is less than VR(MS) }
  then { UE initiates Status Reporting }
}
```

(4)

```
with { UE in E-UTRA RRC_CONNECTED state and using AM RLC }
ensure that {
  when { Polling from peer AM RLC entity is detected and the sequence number of the PDU that carries
  the Poll is greater than or equal to VR(MS) }
  then { UE waits until VR(MS) becomes greater than the sequence number of the PDU with the Poll
  before initiating Status Reporting }
}
```

(5)

```
with { UE in E-UTRA RRC_CONNECTED state and using AM RLC }
ensure that {
  when { the UE needs to send a Status Report and the UL grant is not large enough to accommodate
  the whole report }
  then { UE includes as many NACK SNs in the Status Report as allowed by the UL grant }
}
```

7.2.3.10.2 Conformance requirements

References: The conformance requirements covered in the present TC are specified in: 3GPP TS 36.322 clause 5.2.3.

[TS 36.322, clause 5.2.3]

An AM RLC entity sends STATUS PDUs to its peer AM RLC entity in order to provide positive and/or negative acknowledgements of RLC PDUs (or portions of them).

RRC configures whether or not the status prohibit function is to be used an AM RLC entity.

Triggers to initiate STATUS reporting include:

- Polling from its peer AM RLC entity:
 - When a RLC data PDU with SN = x and the P field set to "1" is received from lower layer, the receiving side of an AM RLC entity shall:
 - if the PDU is to be discarded as specified in subclause 5.1.3.2.2; or
 - if $x < VR(MS)$ or $x \geq VR(MR)$:
 - trigger a STATUS report;

- else:
 - delay triggering the STATUS report until $x < VR(MS)$ or $x \geq VR(MR)$.

NOTE: This ensures that the RLC Status report is transmitted after HARQ reordering.

- Detection of reception failure of an RLC data PDU:
 - The receiving side of an AM RLC entity shall trigger a STATUS report when *t-Reordering* expires.

NOTE: The expiry of *T_reordering* triggers both *VR(MS)* to be updated and a STATUS report to be triggered, but the STATUS report shall be triggered after *VR(MS)* is updated.

When STATUS reporting has been triggered, the receiving side of an AM RLC entity shall:

- if *t-StatusProhibit* is not running:
 - at the first transmission opportunity indicated by lower layer, construct a STATUS PDU and deliver it to lower layer;
- else:
 - at the first transmission opportunity indicated by lower layer after *t-StatusProhibit* expires, construct a single STATUS PDU even if status reporting was triggered several times while *t-StatusProhibit* was running and deliver it to lower layer;

When a STATUS PDU has been delivered to lower layer, the receiving side of an AM RLC entity shall:

- start *t-StatusProhibit*.

When constructing a STATUS PDU, the AM RLC entity shall:

- for the AMD PDUs with SN such that $VR(R) \leq SN < VR(MS)$ that has not been completely received yet, in increasing SN order of PDUs and increasing byte segment order within PDUs, starting with $SN = VR(R)$ up to the point where the resulting STATUS PDU still fits to the total size of RLC PDU(s) indicated by lower layer:
 - for an AMD PDU for which no byte segments have been received yet for an AMD PDU:
 - include in the STATUS PDU a *NACK_SN* which is set to the SN of the AMD PDU;
 - for a continuous sequence of byte segments of a partly received AMD PDU that have not been received yet :
 - include in the STATUS PDU a set of *NACK_SN*, *SOstart* and *SOend*
- set the *ACK_SN* to the SN of the next not received RLC Data PDU which is not indicated as missing in the resulting STATUS PDU.

7.2.3.10.3 Test description

7.2.3.10.3.1 Pre-test conditions

System Simulator:

- Cell 1.

UE:

None.

Preamble

- The UE is in state Loopback Activated (state 4) according to [18] with the exceptions listed in table 7.2.3.10.3.1-1.

Table 7.2.3.10.3.1-1: RLC settings

Parameter	Value
<i>t-Reordering</i>	ms150
<i>t-StatusProhibit</i>	ms300
<i>t-PollRetransmit</i>	ms500

7.2.3.10.3.2 Test procedure sequence

Table 7.2.3.10.3.2-1: Main behaviour

St	Procedure	Message Sequence		TP	Verdict
		U - S	Message		
-	The SS ignores scheduling requests and does not allocate any uplink grant.	-	-	-	-
1	The SS transmits 4 AMD PDUs with SN=0, 1, 2, and 4. The SS sets the P field of all the AMD PDUs to 0. Record time T_A when the AMD PDU with SN=4 is sent.	<--	AMD PDU (SN=0, P=0) AMD PDU (SN=1, P=0) AMD PDU (SN=2, P=0) AMD PDU (SN=4, P=0)	-	-
1A	The SS waits for 60 ms after the transmission of the first AMD PDU to ensure UE RLC has all the required SDUs available and then assigns 3 UL grants (UL grant allocation type 2) with a time spacing of 5 ms of size 840 bits (UL Grant Allocation type 2). (Note 1, Note 5)	<--	(UL grants, 840 bits)	-	-
1B	The UE transmits RLC SDU#1.	-->	(RLC SDU#1)	-	-
1C	The UE transmits RLC SDU#2.	-->	(RLC SDU#2)	-	-
1D	The UE transmits RLC SDU#3.	-->	(RLC SDU#3)	-	-
1E	The SS transmits a STATUS PDU	<--	STATUS PDU	-	-
1F	The SS starts the UL default grant transmission	-	-	-	-
2	Check 1: Does the UE transmit a Status Report with NACK_SN=3 and ACK_SN=5? Record time T_B Check 2: $(T_B - T_A) = t\text{-Reordering}$	-->	STATUS PDU	1	P
3	100 ms after the Status Report is received at Step 2, the SS transmits 4 AMD PDUs with SN=5, 6, 8 and 9. The SS sets the P field of all the AMD PDUs to 0.	<--	AMD PDU (SN=5, P=0) AMD PDU (SN=6, P=0) AMD PDU (SN=8, P=0) AMD PDU (SN=9, P=0)	-	-
3A	Void	-	-	-	-
3B	Check 1: Does the UE transmit a Status Report with NACK_SN=3, ACK_SN=7? Record time T_C Check 2: $(T_C - T_B) = t\text{-StatusProhibit}$	-->	STATUS PDU	2	P
3C	Void	-	-	-	-
4	The UE transmit a Status Report with NACK_SN=3, NACK_SN=7 and ACK_SN=10	-->	STATUS PDU		
4A	The SS ignores scheduling requests unless otherwise specified and does not allocate any uplink grant and is configured for Uplink Grant Allocation Type 3.	-	-	-	-
5	Void	-	-	-	-
6	After 300 ms the SS transmits 2 AMD PDUs with SN=3, SN=7. The SS sets the P field of all the AMD PDUs to 0 except for that of the AMD PDU with SN=7.	<--	AMD PDU (SN=3, P=0) AMD PDU (SN=7, P=1)	-	-
6A	The SS waits for 60 ms to ensure UE RLC has all the required SDUs available and then assigns 1 UL grant (UL grant allocation type 3) of size 40 bits. (Note 2)	<--	(UL grant, 40 bits)	-	-
7	Check: Does the UE transmit a Status Report with no NACK_SN and ACK_SN = 10?	-->	STATUS PDU	3	P
7A	In the subframe following the one scheduled in step 6A the SS assigns 7 UL grants (UL grant allocation type 2) with a time spacing of 5 ms of size 840 bits. (Note 1)	<--	(UL grant, 840 bits)	-	-
7B	The UE transmits RLC SDU#4.	-->	(RLC SDU#4)	-	-
7C	The UE transmits RLC SDU#5.	-->	(RLC SDU#5)	-	-
7D	The UE transmits RLC SDU#6.	-->	(RLC SDU#6)	-	-
7E	The UE transmits RLC SDU#7.	-->	(RLC SDU#7)	-	-
7F	The UE transmits RLC SDU#8.	-->	(RLC SDU#8)	-	-
7G	The UE transmits RLC SDU#9.	-->	(RLC SDU#9)	-	-
7H	The UE transmits RLC SDU#10.	-->	(RLC SDU#10)	-	-

7I	The SS transmits a STATUS PDU	<--	STATUS PDU	-	-
8	Void	-	-	-	-
9	After 300 ms the SS transmits an AMD PDU with SN=10 and P=0, and an AMD PDU with SN=12 and P=1.	<--	AMD PDU (SN=10, P=0) AMD PDU (SN=12, P=1)	-	-
9A	Check: Does the UE transmits a scheduling request within <i>t-Reordering</i> / 2 ms?	-->	(SR)	4	F
10	Within <i>t-Reordering</i> / 2 ms after Step 9, the SS transmits an AMD PDU with SN=11 and P=0. Note: AMD PDUs with SN 10,11 and 12 carry RLC SDU #11.	<--	AMD PDU (SN=11, P=0)	-	-
10 A	The SS waits for 60 ms to ensure UE RLC has all the required SDUs available and then assigns 1 UL grant (UL grant allocation type 3) of size 40 bits. (Note 2)	<--	(UL grants, 40 bits)	-	-
11	Check: Does the UE transmit a Status Report with no NACK_SN and ACK_SN=13?	-->	STATUS PDU	4	P
11 A	The SS assigns 1 UL grant (UL grant allocation type 3) of size 840 bits. (Note 1)	<--	(UL grant, 840 bits)	-	-
11 B	The UE transmit RLC SDU#11.	-->	(RLC SDU#11)	-	-
11 C	The SS transmits a STATUS PDU	<--	STATUS PDU	-	-
12	Void	-	-	-	-
13	Void	-	-	-	-
14	After 300 ms the SS transmits an AMD PDU with SN=13 and P=0, and an AMD PDU with SN=19 and P=1.	<--	AMD PDU (SN=13, P=0) AMD PDU (SN=19, P=1)	-	-
15	The SS waits for <i>t-Reordering</i> ms to ensure expiry.	-	-	-	-
16	Void	-	-	-	-
17	60 ms after step 15 the SS assigns an UL grant (UL grant allocation type 3) of size 72 bits. (Note 3)	<--	(UL Grant)	-	-
18	Void	-	-	-	-
-	Steps 18a1 and 18b1 depends on the UE behaviour; the "lower case letter" identifies a step sequence that takes place if a specific behaviour happens	-	-	-	-
18a 1	Check: Does the UE transmit a Status Report with ACK_SN=16 and 2 NACK_SNs: 14 and 15?	-->	STATUS PDU	5	P
18b 1	Check: Does the UE transmit a Status Report with ACK_SN=18 and 4 NACK_SNs: 14,15, 16 and 17?	-->	STATUS PDU	5	P
19	Void	-	-	-	-
20	Void	-	-	-	-
21	After 300 ms The SS transmits an AMD PDU with SN=14 and P=1.	<--	AMD PDU (SN=14, P=1)	-	-
22	60 ms after step 21 the SS assigns an UL grant (UL grant allocation type 3) of size 72 bits. (Note 4)	<--	(UL Grant)	-	-
23	Check: Does the UE transmit a Status Report with ACK_SN=20 and 4 NACK_SNs: 15, 16, 17 and 18?	-->	STATUS PDU	5	P
24	60 ms after step 22 the SS transmits 4 AMD PDU with SN=15, 16, 17, 18. Note: AMD PDUs with SN 13 to 19 carry RLC SDU #12.	<--	AMD PDU (SN=15, P=0) AMD PDU (SN=16, P=0) AMD PDU (SN=17, P=0) AMD PDU (SN=18, P=0)	-	-
24 A	60 ms after step 24 the SS assigns 1 UL grant (UL grant allocation type 3) of size 840 bits. (Note 1)	<--	(UL grant, 840 bits)	-	-
25	The UE loopbacks the complete RLC SDU.	-->	(RLC SDU#12)	-	-
26	The SS transmits a STATUS PDU	<--	STATUS PDU	-	-
Note 1: UL grant of 840 bits ($I_{TBS}=14$, $N_{PRB}=3$, see TS 36.213 Table 7.1.7.2.1-1) is chosen to allow the UE to transmit one PDU at a time.					
Note 2: UL grant of 40 bits ($I_{TBS}=3$, $N_{PRB}=1$, see TS 36.213 Table 7.1.7.2.1-1) is chosen to allow the UE to transmit a					

Status Report with ACK_SN and (8-bit short BSR + 2x 8-bit MAC PDU subheader + 4-bit D/C/CPT + 10-bit ACK_SN + 1-bit E1 + 1bit padding).

Note 3: UL grant of 72 bits ($I_{TBS}=2$, $N_{PRB}=2$, see TS 36.213 Table 7.1.7.2.1-1) is chosen to allow the UE to transmit (a Status Report with ACK_SN and 2 NACK_SNs (3x 8-bit MAC PDU subheader +8-bit Short BSR + 4-bit D/C/CPT + 10-bit ACK_SN + 1-bit E1 + 2 x (12-bit NACK_SN/E1/E2) + 1-bit Padding)) or (a Status Report with ACK_SN and 4 NACK_SNs (8-bit MAC PDU subheader +4-bit D/C/CPT + 10-bit ACK_SN + 1-bit E1 + 4 x (12-bit NACK_SN/E1/E2) +1-bit padding)).

Note 4: UL grant of 72 bits ($I_{TBS}=2$, $N_{PRB}=2$, see TS 36.213 Table 7.1.7.2.1-1) is chosen to allow the UE to transmit a Status Report with ACK_SN and 4 NACK_SNs (8-bit MAC PDU subheader + 4-bit D/C/CPT + 10-bit ACK_SN + 1-bit E1 + 4 x (12-bit NACK_SN/E1/E2) +1-bit padding).

Note 5: The first AMD PDU is transmitted in subframe #4. This subframe is as well suitable for the transmission of UL grants in TDD.

7.2.3.10.3.3 Specific message contents

None.

7.2.3.11 Void

7.2.3.12 Void

7.2.3.13 AM RLC / Reconfiguration of RLC parameters by upper layers

7.2.3.13.1 Test Purpose (TP)

(1)

```
with { UE in E-UTRA RRC_CONNECTED state and using AM RLC }
ensure that {
  when { t-PollRetransmit value is changed during reconfiguration of RLC parameters by upper layers }
  then { UE starts using new t-PollRetransmit value }
}
```

(2)

```
with { UE in E-UTRA RRC_CONNECTED state and using AM RLC }
ensure that {
  when { t-Reordering value is changed during reconfiguration of RLC parameters by upper layers }
  then { UE starts using new t-Reordering value }
}
```

(3)

```
with { UE in E-UTRA RRC_CONNECTED state and using AM RLC }
ensure that {
  when { t-StatusProhibit value is changed during reconfiguration of RLC parameters by upper layers }
  then { UE starts using new t-StatusProhibit value }
}
```

7.2.3.13.2 Conformance requirements

References: The conformance requirements covered in the present TC are specified in: 3GPP TS 36.322 clause 5.2.2, 5.2.2.1, 5.2.2.2, 5.2.2.3 and 5.2.3.

[TS 36.322, clause 5.2.2]

An AM RLC entity can poll its peer AM RLC entity in order to trigger STATUS reporting at the peer AM RLC entity.

[TS 36.322, clause 5.2.2.1]

Upon assembly of a new AMD PDU, the transmitting side of an AM RLC entity shall:

- increment PDU_WITHOUT_POLL by one;
- increment BYTE_WITHOUT_POLL by every new byte of Data field element that it maps to the Data field of the RLC data PDU;
- if PDU_WITHOUT_POLL \geq *pollPDU*; or

- if `BYTE_WITHOUT_POLL >= pollByte`;
- include a poll in the RLC data PDU as described below.

Upon assembly of a AMD PDU or AMD PDU segment, the transmitting side of an AM RLC entity shall:

- if both the transmission buffer and the retransmission buffer becomes empty (excluding transmitted RLC data PDU awaiting for acknowledgements) after the transmission of the RLC data PDU; or
- if no new RLC data PDU can be transmitted after the transmission of the RLC data PDU (e.g. due to window stalling);
- include a poll in the RLC data PDU as described below.

To include a poll in a RLC data PDU, the transmitting side of an AM RLC entity shall:

- set the P field of the RLC data PDU to "1";
- set `PDU_WITHOUT_POLL` to 0;
- set `BYTE_WITHOUT_POLL` to 0;

After delivering a RLC data PDU including a poll to lower layer and after incrementing of `VT(S)` if necessary, the transmitting side of an AM RLC entity shall:

- set `POLL_SN` to `VT(S) - 1`;
- if *t-PollRetransmit* is not running:
 - start *t-PollRetransmit*;
- else:
 - restart *t-PollRetransmit*;

[TS 36.322, clause 5.2.2.2]

Upon reception of a STATUS report from the receiving RLC AM entity the transmitting side of an AM RLC entity shall:

- if the STATUS report comprises a positive or negative acknowledgement for the RLC data PDU with sequence number equal to `POLL_SN`:
- if the *t-PollRetransmit* is running:
 - stop and reset *t-PollRetransmit*.

[TS 36.322, clause 5.2.2.3]

Upon expiry of *t-PollRetransmit*, the transmitting side of an AM RLC entity shall:

- if both the transmission buffer and the retransmission buffer are empty (excluding transmitted RLC data PDU awaiting for acknowledgements); or
- if no new RLC data PDU can be transmitted (e.g. due to window stalling):
 - consider the AMD PDU with `SN = VT(S) - 1` for retransmission; or
 - consider any AMD PDU which has not been positively acknowledged for retransmission;
- include a poll in a RLC data PDU as described in section 5.2.2.1.

[TS 36.322, clause 5.2.3]

An AM RLC entity sends STATUS PDUs to its peer AM RLC entity in order to provide positive and/or negative acknowledgements of RLC PDUs (or portions of them).

RRC configures whether or not the status prohibit function is to be used for an AM RLC entity.

Triggers to initiate STATUS reporting include:

- Polling from its peer AM RLC entity:
 - When a RLC data PDU with SN = x and the P field set to "1" is received from lower layer, the receiving side of an AM RLC entity shall:
 - if the PDU is to be discarded as specified in subclause 5.1.3.2.2; or
 - if $x < VR(MS)$ or $x \geq VR(MR)$:
 - trigger a STATUS report;
 - else:
 - delay triggering the STATUS report until $x < VR(MS)$ or $x \geq VR(MR)$.

NOTE: This ensures that the RLC Status report is transmitted after HARQ reordering.

- Detection of reception failure of an RLC data PDU:
 - The receiving side of an AM RLC entity shall trigger a STATUS report when *t-Reordering* expires.

NOTE: The expiry of *T_reordering* triggers both *VR(MS)* to be updated and a STATUS report to be triggered, but the STATUS report shall be triggered after *VR(MS)* is updated.

When STATUS reporting has been triggered, the receiving side of an AM RLC entity shall:

- if *t-StatusProhibit* is not running:
 - at the first transmission opportunity indicated by lower layer, construct a STATUS PDU and deliver it to lower layer;
- else:
 - at the first transmission opportunity indicated by lower layer after *t-StatusProhibit* expires, construct a single STATUS PDU even if status reporting was triggered several times while *T_status_prohibit* was running and deliver it to lower layer;

When a STATUS PDU has been delivered to lower layer, the receiving side of an AM RLC entity shall:

- start *t-StatusProhibit*.

When constructing a STATUS PDU, the AM RLC entity shall:

- for the AMD PDUs with SN such that $VR(R) \leq SN < VR(MS)$ that has not been completely received yet, in increasing SN order of PDUs and increasing byte segment order within PDUs, starting with SN = *VR(R)* up to the point where the resulting STATUS PDU still fits to the total size of RLC PDU(s) indicated by lower layer:
 - for an AMD PDU for which no byte segments have been received yet :
 - include in the STATUS PDU a *NACK_SN* which is set to the SN of the AMD PDU;
 - for a continuous sequence of byte segments of a partly received AMD PDU that have not been received yet
 - include in the STATUS PDU a set of *NACK_SN*, *SOstart* and *SOend*
- set the *ACK_SN* to the SN of the next not received RLC Data PDU which is not indicated as missing in the resulting STATUS PDU.

7.2.3.13.3 Test description

7.2.3.13.3.1 Pre-test conditions

System Simulator:

- Cell 1.

UE:

None.

Preamble:

- The UE is in state Loopback Activated (state 4) according to [18] with the exceptions listed in table 7.2.3.13.3.1-1.

Table 7.2.3.13.3.1-1: RLC settings

Parameter	Value
<i>t-Reordering</i>	ms150
<i>t-StatusProhibit</i>	ms300
<i>t-PollRetransmit</i>	ms400
<i>pollPDU</i>	pInfinity
<i>pollByte</i>	kBinfinity

7.2.3.13.3.2 Test procedure sequence

Table 7.2.3.13.3.2-1: Main behaviour

St	Procedure	Message Sequence		TP	Verdict
		U - S	Message/PDU/SDU		
1	Void	-	-	-	-
	The SS ignores scheduling requests and does not allocate any uplink grant.	-	-	-	-
2	The SS transmits 4 AMD PDUs with P=0 and SN=0, 1, 2 and 4. The SS record time T_A when AMD PDU#5 (with SN=4) is sent.	<--	AMD PDU#1 (SN=0, P=0) AMD PDU#2 (SN=1, P=0) AMD PDU#3 (SN=2, P=0) AMD PDU#5 (SN=4, P=0)	-	-
2A	The SS waits for 60 ms after the transmission of the first AMD PDU to ensure UE RLC has all the required SDUs available and then assigns 3 UL grants of size 840 bits (UL Grant Allocation type 2) with a time spacing of 5 ms. (Note 2, Note 5)	<--	(UL grants, 840 bits)	-	-
2B	The UE transmits RLC SDU#1.	-->	(RLC SDU#1)	-	-
2C	The UE transmits RLC SDU#2.	-->	(RLC SDU#2)	-	-
2D	The UE transmits RLC SDU#3.	-->	(RLC SDU#3)	-	-
2E	The SS transmits a STATUS PDU	<--	STATUS PDU	-	-
2F	The SS starts the UL default grant transmission	-	-	-	-
3	Check 1: Does the UE transmit a STATUS PDU with NACK_SN=3 and ACK_SN=5? Record time T_B . Check 2: Is $(T_B - T_A) = t\text{-Reordering?}$	-->	STATUS PDU	-	-
4	100 ms after the Status Report received at Step 3, the SS sends 4 AMD PDUs with P=0 and SN=5, 6, 8 and 9.	<--	AMD PDU#6 (SN=5, P=0) AMD PDU#7 (SN=6, P=0) AMD PDU#9 (SN=8, P=0) AMD PDU#10 (SN=9, P=0)	-	-
4A	Check 1: Does the UE transmit a Status Report with NACK_SN=3, ACK_SN=7? Record time T_C Check 2: $(T_C - T_B) = t\text{-StatusProhibit?}$	-->	STATUS PDU	-	-
5	The UE transmits a STATUS PDU with NACK_SN=3, NACK_SN=7 and ACK_SN=10.	-->	STATUS PDU	-	-
6	The SS ignores scheduling requests and does not allocate any uplink grant.	-	-	-	-
7	After 300 ms the SS transmits 3 AMD PDUs with SN=3, 7 and 9. The SS sets the P field of all the AMD PDUs to 0 except for that of the AMD PDU with SN=9.	<--	AMD PDU#4 (SN=3, P=0) AMD PDU#8 (SN=7, P=0) AMD PDU#10 (SN=9, P=1)	-	-
7A	The SS waits for 60 ms to ensure UE RLC has all the required SDUs available and then assigns 1 UL grant of size 40 bits (UL Grant Allocation type 3). (Note 3)	<--	(UL grant, 40 bits)	-	-
8	The UE transmits a Status Report with no NACK_SN and ACK_SN = 10.	-->	STATUS PDU	-	-
8A	In the subframe following the one scheduled in step 7A the SS assigns 7 UL grants of size 840 bits (UL Grant Allocation type 2) with a time spacing of 5 ms. (Note 2)	<--	(UL grants, 840 bits)	-	-

8B	The UE transmits RLC SDU#4.	-->	(RLC SDU#4)	-	-
8C	The UE transmits RLC SDU#5.	-->	(RLC SDU#5)	-	-
8D	The UE transmits RLC SDU#6.	-->	(RLC SDU#6)	-	-
8E	The UE transmits RLC SDU#7.	-->	(RLC SDU#7)	-	-
8F	The UE transmits RLC SDU#8.	-->	(RLC SDU#8)	-	-
8G	The UE transmits RLC SDU#9.	-->	(RLC SDU#9)	-	-
8H	The UE transmits RLC SDU#10.	-->	(RLC SDU#10)	-	-
8I	The SS transmits a STATUS PDU	<--	STATUS PDU	-	-
9	The SS transmits an AMD PDU to the UE.	<--	AMD PDU#11 (SN=10, P=0)	-	-
9A	The SS starts the UL default grant transmission	-	-	-	-
10	The UE transmits an AMD PDU with the same data as received in the corresponding DL AMD PDU. Record time T_D .	-->	AMD PDU#11 (SN=10, P=1)	-	-
11	Check 1: Does the UE set the poll bit as both the transmission and retransmission buffers become empty? Record time T_E . Check 2: Is $(T_E - T_D) = t\text{-PollRetransmit}$?	-->	AMD PDU#11 (SN=10, P=1)	1	P
11 A	The SS transmits a STATUS PDU	<--	STATUS PDU	-	-
12	The SS reconfigures RLC in the UE and sets: - $t\text{-Reordering}$ to ms200, - $t\text{-StatusProhibit}$ to ms400, - $t\text{-PollRetransmit}$ to ms500. (Note 1)	-	-	-	-
-	The SS ignores scheduling requests and does not allocate any uplink grant.	-	-	-	-
13	The SS transmits 4 AMD PDUs with P=0 and SN=11, 12, 13 and 15. The SS record time T_F when AMD PDU#16 (with SN=15) is sent.	<--	AMD PDU#12 (SN=11, P=0) AMD PDU#13 (SN=12, P=0) AMD PDU#14 (SN=13, P=0) AMD PDU#16 (SN=15, P=0)	-	-
13 A	The SS waits for 60 ms after the transmission of the first AMD PDU to ensure UE RLC has all the required SDUs available and then assigns 3 UL grants of size 840 bits (UL Grant Allocation type 2) with a time spacing of 5 ms. (Note 2, Note 5)	<--	(UL grants, 840 bits)	-	-
13 B	The UE transmits RLC SDU#12.	-->	(RLC SDU#12)	-	-
13 C	The UE transmits RLC SDU#13.	-->	(RLC SDU#13)	-	-
13 D	The UE transmits RLC SDU#14.	-->	(RLC SDU#14)	-	-
13 E	The SS transmits a STATUS PDU	<--	STATUS PDU	-	-
13F	The SS starts the UL default grant transmission	-	-	-	-
14	Check 1: Does the UE transmit a STATUS PDU with NACK_SN=14 and ACK_SN=16? Record time T_G . Check 2: Is $(T_G - T_F) = \text{updated value of } t\text{-Reordering}$?	-->	STATUS PDU	2	P
15	100 ms after the Status Report received at Step 14, the SS sends 4 AMD PDUs with P=0 and SN=16, 17, 19 and 20.	<--	AMD PDU#17 (SN=16, P=0) AMD PDU#18 (SN=17, P=0) AMD PDU#20 (SN=19, P=0) AMD PDU#21 (SN=20, P=0)	-	-
15 A	Check 1: Does the UE transmit a STATUS PDU with NACK_SN=14 and ACK_SN=18? Record time T_H . Check 2: Is $(T_H - T_G) = \text{updated value of } t\text{-StatusProhibit}$?	-->	STATUS PDU	3	P
16	The UE transmits a STATUS PDU with NACK_SN=14, NACK_SN=18 and ACK_SN=21.	-->	STATUS PDU	-	-
17	The SS ignores scheduling requests and does not allocate any uplink grant.	-	-	-	-
18	After 450 ms the SS transmits 3 AMD PDUs	<--	AMD PDU#15 (SN=14, P=0)	-	-

	with SN=14, 18 and 20. The SS sets the P field of all the AMD PDUs to 0 except for that of the AMD PDU with SN=20.		AMD PDU#19 (SN=18, P=0) AMD PDU#21 (SN=20, P=1)		
18 A	The SS waits for 60 ms to ensure UE RLC has all the required SDUs available and then assigns 1 UL grant of size 40 bits (UL Grant Allocation type 3). (Note 3)	<--	(UL grant, 40 bits)	-	-
19	The UE transmits a Status Report with no NACK_SN and ACK_SN = 21.	-->	STATUS PDU	-	-
19 A	In the subframe following the one scheduled in step 18A the SS assigns 7 UL grants of size 840 bits (UL Grant Allocation type 2) with a time spacing of 5 ms. (Note 2)	<--	(UL grants, 840 bits)	-	-
19 B	The UE transmits RLC SDU#15.	-->	(RLC SDU#15)	-	-
19 C	The UE transmits RLC SDU#16.	-->	(RLC SDU#16)	-	-
19 D	The UE transmits RLC SDU#17.	-->	(RLC SDU#17)	-	-
19 E	The UE transmits RLC SDU#18.	-->	(RLC SDU#18)	-	-
19F	The UE transmits RLC SDU#19.	-->	(RLC SDU#19)	-	-
19 G	The UE transmits RLC SDU#20.	-->	(RLC SDU#20)	-	-
19 H	The UE transmits RLC SDU#21.	-->	(RLC SDU#21)	-	-
19I	The SS transmits a STATUS PDU	<--	STATUS PDU	-	-
20	The SS transmits an AMD PDU to the UE.	<--	AMD PDU#22 (SN=21, P=0)	-	-
20 A	The SS starts the UL default grant transmission	-	-	-	-
21	The UE transmits an AMD PDU with the same data as received in the corresponding DL AMD PDU. Record time T_i .	-->	AMD PDU#22 (SN=21, P=1)	-	-
22	Check 1: Does the UE set the poll bit as both the transmission and retransmission buffers become empty? Record time T_j . Check 2: Is $(T_j - T_i) =$ updated value of t - <i>PollRetransmit</i> ?	-->	AMD PDU#22 (SN=21, P=1)	1	P
23	The SS transmits a STATUS PDU	<--	STATUS PDU	-	-
<p>Note 1: The RRC Connection Reconfiguration procedure is performed.</p> <p>Note 2: UL grant of 840 bits (ITBS=14, NPRB=3, see TS 36.213 Table 7.1.7.2.1-1) is chosen to allow the UE to transmit one PDU at a time.</p> <p>Note 3: UL grant of 40 bits (ITBS=3, NPRB=1, see TS 36.213 Table 7.1.7.2.1-1) is chosen to allow the UE to transmit a Status Report with ACK_SN and (16-bit short BSR + 8-bit MAC PDU subheader + 4-bit D/C/CPT + 10-bit ACK_SN + 1-bit E1 + 1bit padding).</p> <p>Note 4: Every DL AMD PDU contains 1 RLC SDU size of 100 bytes.</p> <p>Note 5: The first AMD PDU is transmitted in subframe #4. This subframe is as well suitable for the transmission of UL grants in TDD.</p>					

7.2.3.13.3.3 Specific message contents

None.

7.2.3.14 AM RLC / In sequence delivery of upper layers PDUs

7.2.3.14.1 Test Purpose (TP)

(1)

```
with { UE in E-UTRAN RRC_CONNECTED state }
ensure that {
  when { UE receives duplicate AMD PDUs }
  then { UE discards the duplicate AMD PDUs }
}
```

(2)

```
with { UE in E-UTRAN RRC_CONNECTED state }
```



```
ensure that {  
  when { UE receives an AMD PDU with a SN gap }  
  then { UE sends STATUS PDU to request retransmissions of PDUs in the SN gap }  
}
```

(3)

```
with { UE in E-UTRAN RRC_CONNECTED state }  
ensure that {  
  when { UE receives PDUs within a SN gap }  
  then { RLC reassembles and reorders the AMD PDUs and deliver them to the upper layer in sequence }  
}
```

7.2.3.14.2 Conformance requirements

References: The conformance requirements covered in the present TC are specified in: 3GPP TS 36.322 clause 4.2.1.3.3.

[TS 36.322, clause 4.2.1.3.3]

When the receiving side of an AM RLC entity receives RLC data PDUs, it shall:

- detect whether or not the RLC data PDUs have been received in duplication, and discard duplicated RLC data PDUs;
- reorder the RLC data PDUs if they are received out of sequence;
- detect the loss of RLC data PDUs at lower layers and request retransmissions to its peer AM RLC entity;
- reassemble RLC SDUs from the reordered RLC data PDUs and deliver the RLC SDUs to upper layer in sequence.

...

7.2.3.14.3 Test description

7.2.3.14.3.1 Pre-test conditions

System Simulator:

- Cell 1.

UE:

None.

Preamble:

- The UE is in state Loopback Activated (state 4) according to [18].

7.2.3.14.3.2 Test procedure sequence

Table 7.2.3.14.3.2-1: Main behaviour

St	Procedure	Message Sequence		TP	Verdict
		U - S	Message		
1	The SS transmits an AMD PDU to the UE. This PDU carries SDU#1.	<--	AMD PDU#1 (SN=0)		
2	The SS transmits an AMD PDU to the UE. This PDU carries SDU#1.	<--	AMD PDU#1 (SN=0)	-	-
3	Check: Does the UE transmit RLC SDU#1? (Note)	-->	(RLC SDU#1)	1	P
3A	The SS transmits a STATUS PDU.	<--	STATUS PDU (ACK SN=1)	-	-
4	The SS transmits an AMD PDU to the UE. This PDU contains SDU#2, and the 1 st part of SDU#3.	<--	AMD PDU#2 (SN=1)	-	-
5	Check: Does the UE transmit RLC SDU#2?	-->	(RLC SDU#2)	1	P
5A	The SS transmits a STATUS PDU.	<--	STATUS PDU (ACK SN=2)	-	-
6	The SS transmits an AMD PDU to the UE. This PDU contains SDU#2, and the 1 st part of SDU#3.	<--	AMD PDU#2 (SN=1)	-	-
7	Check: Does the UE transmit RLC SDU#2?	-->	(RLC SDU#2)	1	F
8	The SS transmits an AMD PDU to the UE. This PDU contains the 2 nd part of SDU#3.	<--	AMD PDU#3 (SN=2)	-	-
9	Check: Does the UE transmit RLC SDU#3?	-->	(RLC SDU#3)	1	P
9A	The SS transmits a STATUS PDU.	<--	STATUS PDU (ACK SN=3)	-	-
10	The SS transmits an AMD PDU to the UE. This PDU contains the last part of SDU#6.	<--	AMD PDU#6 (SN=5)	-	-
11	The SS transmits an AMD PDU to the UE. This PDU contains the 2 nd part of SDU#5, and the 1 st part of SDU#6.	<--	AMD PDU#5 (SN=4)	-	-
11 A	The SS does not allocate any uplink grant.	-	-	-	-
12	The SS transmits an AMD PDU to the UE. This PDU carries SDU#4 and the 1 st part of SDU#5.	<--	AMD PDU#4 (SN=3)	-	-
12 A	The SS waits for 60 ms then assigns an UL grant sufficient for the UE to loopback SDU#4, SDU#5 and SDU#6.	<--	(UL grant)	-	-
13	Check: Does the UE transmit an AMD PDU containing RLC SDU#4, RLC SDU#5 and RLC SDU#6 in its data field?	-->	AMD PDU (RLC SDU#4, RLC SDU#5, RLC SDU#6)	3	P
14	The SS transmits a STATUS PDU.	<--	STATUS PDU (ACK SN=4)	-	-
15	Void	-	-	-	-
16	The SS transmits an AMD RLC PDU to the UE. This PDU contains the last part of SDU#9.	<--	AMD PDU#9 (SN=8, P=1)	-	-
17	Check: Does the UE transmit a STATUS PDU NACK_SN/E1/E2 fields set correctly to inform SS of missing PDUs #7, #8, (ACK_SN =9, NACK_SN = 6, NACK_SN = 7)?	-->	STATUS PDU	2	P
18	The SS transmits an AMD PDU to the UE. This PDU contains SDU#8, and the 1 st part of SDU#9.	<--	AMD PDU#8 (SN=7)	-	-
18 A	The SS does not allocate any uplink grant.	-	-	-	-
19	The SS transmits an AMD PDU to the UE. This PDU carries SDU#7.	<--	AMD PDU#7 (SN=6)	-	-
19 A	The SS waits for 60 ms then assigns an UL grant sufficient for the UE to loopback SDU#7, SDU#8 and SDU#9.	<--	(UL grants)	-	-
20	Check: Does the UE transmit an AMD PDU containing RLC SDU#7, RLC SDU#8 and RLC SDU#9 in its data field?	-->	AMD PDU (RLC SDU#7, RLC SDU#8, RLC SDU#9)	3	P
21	The SS transmits a STATUS PDU.	<--	STATUS PDU (ACK SN=5)	-	-
22	Void	-	-	-	-

Note: UE may transmit RLC SDU #1 between Step 1 and Step 2.

7.2.3.14.3.3 Specific message contents

None.

7.2.3.15 AM RLC / Re-ordering of RLC PDU segments

7.2.3.15.1 Test Purpose (TP)

(1)

```
with { UE in E-UTRAN RRC_CONNECTED state }
ensure that {
  when { UE receives RLC AM PDU segments }
  then { UE reorders RLC AMD PDU segments received out of sequence }
}
```

(2)

```
with { UE in E-UTRA RRC_CONNECTED state }
ensure that {
  when { t-Reordering expires }
  then { Set VR(MS) to SN of the first AMD PDU with SN >= VR(X) for which not all byte segments
have been received }
}
```

7.2.3.15.2 Conformance requirements

References: The conformance requirements covered in the present TC are specified in: 3GPP TS 36.322 clauses 4.2.1.3.3, 5.1.3.2.1, 5.1.3.2.2, 5.1.2.3.3 and 5.1.2.3.4.

[TS 36.322, clause 4.2.1.3.3]

When the receiving side of an AM RLC entity receives RLC data PDUs, it shall:

...

- detect the loss of RLC data PDUs at lower layers and request retransmissions to its peer AM RLC entity;
- reassemble RLC SDUs from the reordered RLC data PDUs and deliver the RLC SDUs to upper layer in sequence.

...

[TS 36.322, clause 5.1.3.2.1]

The receiving side of an AM RLC entity shall maintain a receiving window according to state variables VR(R) and VR(MR) as follows:

- a SN falls within the receiving window if $VR(R) \leq SN < VR(MR)$;
- a SN falls outside of the receiving window otherwise.

When receiving a RLC data PDU from lower layer, the receiving side of an AM RLC entity shall:

- either discard the received RLC data PDU or place it in the reception buffer (see sub clause 5.1.3.2.2);
- if the received RLC data PDU was placed in the reception buffer:
 - update state variables, reassemble and deliver RLC SDUs to upper layer and start/stop *t-Reordering* as needed (see sub clause 5.1.3.2.3).

When *t-Reordering* expires, the receiving side of an AM RLC entity shall:

- update state variables and start *t-Reordering* as needed (see sub clause 5.1.3.2.4).

[TS 36.322, clause 5.1.3.2.2]

When a RLC data PDU is received from lower layer, where the RLC data PDU contains byte segment numbers y to z of an AMD PDU with SN = x, the receiving side of an AM RLC entity shall:

- if x falls outside of the receiving window; or
- if byte segment numbers y to z of the AMD PDU with $SN = x$ have been received before:
 - discard the received RLC data PDU;
- else:
 - place the received RLC data PDU in the reception buffer;
 - if some byte segments of the AMD PDU contained in the RLC data PDU have been received before:
 - discard the duplicate byte segments.

[TS 36.322, clause 5.1.3.2.3]

When a RLC data PDU with $SN = x$ is placed in the reception buffer, the receiving side of an AM RLC entity shall:

- if all byte segments of the AMD PDU with $SN = VR(MS)$ are received:
 - update $VR(MS)$ to the SN of the first AMD PDU with $SN > \text{current } VR(MS)$ for which not all byte segments have been received;
- if $x = VR(R)$:
 - if all byte segments of the AMD PDU with $SN = VR(R)$ are received:
 - update $VR(R)$ to the SN of the first AMD PDU with $SN > \text{current } VR(R)$ for which not all byte segments have been received;
 - update $VR(MR)$ to the updated $VR(R) + AM_Window_Size$;
 - reassemble RLC SDUs from any byte segments of AMD PDUs with SN that falls outside of the receiving window and in-sequence byte segments of the AMD PDU with $SN = VR(R)$, remove RLC headers when doing so and deliver the reassembled RLC SDUs to upper layer in sequence if not delivered before;
- if $x \geq VR(H)$
 - update $VR(H)$ to $x + 1$;
- if *t-Reordering* is running:
 - if $VR(X) = VR(R)$; or
 - if $VR(X)$ falls outside of the receiving window and $VR(X)$ is not equal to $VR(MR)$:
 - stop and reset *t-Reordering*;
- if *t-Reordering* is not running (includes the case *t-Reordering* is stopped due to actions above):
 - if $VR(H) > VR(R)$:
 - start *t-Reordering*;
 - set $VR(X)$ to $VR(H)$.

[TS 36.322, clause 5.1.3.2.4]

When *t-Reordering* expires, the receiving side of an AM RLC entity shall:

- update $VR(MS)$ to the SN of the first AMD PDU with $SN \geq VR(X)$ for which not all byte segments have been received;
- if $VR(H) > VR(MS)$:
 - start *t-Reordering*;
 - set $VR(X)$ to $VR(H)$.

7.2.3.15.3 Test description

7.2.3.15.3.1 Pre-test conditions

System Simulator:

- Cell 1.

UE:

None.

Preamble:

- The UE is in state Loopback Activated (state 4) according to [18] with a loop back size of 98 bytes.

7.2.3.15.3.2 Test procedure sequence

Table 7.2.3.15.3.2-1: Main behaviour

St	Procedure	Message Sequence		TP	Verdict
		U - S	Message/PDU/SDU		
1	The SS transmits one AMD PDU containing SDU#8 (100 bytes) in its data field to the UE. SN=7 indicates the loss of 7 PDUs.	<--	AMD PDU#8 (SN=7)	-	-
2	The SS transmits one AMD PDU segment containing 50 bytes of SDU#1 in its data field to the UE. This AMD PDU segment carries part 1 of AMD PDU#1, which contained SDU#1 (100 bytes) in its data field. SO=0 and LSF=0.	<--	AMD PDU#1 (SN=0) segment 1	-	-
3	The SS transmits one AMD PDU segment containing 50 bytes of SDU#2 in its data field to the UE. This AMD PDU segment carries part 2 of AMD PDU#2, which contained SDU#2 (100 bytes) in its data field. SO=50 and LSF=1.	<--	AMD PDU#2 (SN=1) segment 2	-	-
4	The SS transmits one AMD PDU segment containing 50 bytes of SDU#3 in its data field to the UE. This AMD PDU segment carries part 1 of AMD PDU#3, which contained SDU#3 (100 bytes) in its data field. SO=0 and LSF=0.	<--	AMD PDU#3 (SN=2) segment 1	-	-
5	The SS transmits one AMD PDU segment containing 50 bytes of SDU#4 in its data field to the UE. This AMD PDU segment carries part 2 of AMD PDU#4, which contained SDU#4 (100 bytes) in its data field. SO=50 and LSF=1.	<--	AMD PDU#4 (SN=3) segment 2	-	-
6	The SS transmits one AMD PDU segment containing 50 bytes of SDU#4 in its data field to the UE. This AMD PDU segment carries part 1 of AMD PDU#4, which contained SDU#4 (100 bytes) in its data field. SO=0 and LSF=0.	<--	AMD PDU#4 (SN=3) segment 1	-	-
7	The SS transmits one AMD PDU segment containing 50 bytes of SDU#1 in its data field to the UE. This AMD PDU segment carries part 2 of AMD PDU#1, which contained SDU#1 (100 bytes) in its data field. SO=50 and LSF=1.	<--	AMD PDU#1 (SN=0) segment 2	-	-
8	Void				
9	The SS transmits one AMD PDU segment containing 50 bytes of SDU#2 in its data field to the UE. This AMD PDU segment carries part 1 of AMD PDU#2, which contained SDU#2 (100 bytes) in its data field. SO=0 and LSF=0.	<--	AMD PDU#2 (SN=1) segment 1	-	-
10	Void				
11	The SS transmits one AMD PDU segment containing 50 bytes of SDU#3 in its data field to the UE. This AMD PDU segment carries part 2 of PDU#3, which contained SDU#3 (100 bytes) in its data field. SO=50 and LSF=1.	<--	AMD PDU#3 (SN=2) segment 2	-	-
11 A	The SS transmits one AMD PDU segment containing 50 bytes of SDU#7 in its data field to the UE. This AMD PDU segment carries part 1 of PDU #7, which contained SDU#7 (100 bytes) in its data field. SO=0 and LSF=0.	<--	AMD PDU#7 (SN=6) segment 1	-	-
11 B	The SS transmits one AMD PDU segment containing 50 bytes of SDU#6 in its data field to the UE. This AMD PDU segment carries segment 2 of AMD PDU#6, which contained SDU#6 (100 bytes) in its data field. SO=50 and LSF=1.	<--	AMD PDU#6 (SN=5) segment 2	-	-

11 C	The SS waits for 60 ms then SS transmits 4 uplink grants (UL grant allocation type 2) with a time spacing of 5 ms, each allowing the UE to transmit 1 RLC SDU.	<--	(UL grants)	-	-
11 D	Check: Does the UE transmit an RLC SDU containing SDU#1 in its data field?	-->	(RLC SDU#1)	1	P
11 E	Check: Does the UE transmit an RLC SDU containing SDU#2 in its data field?	-->	(RLC SDU#2)	1	P
12	Check: Does the UE transmit an RLC SDU containing SDU#3 in its data field?	-->	(RLC SDU#3)	1	P
13	Check: Does the UE transmit an RLC SDU containing SDU#4 in its data field?	-->	(RLC SDU#4)	1	P
14	The SS transmits an RLC STATUS PDU to the UE. This PDU acks PDUs up to those including SDU#4. ACK_SN=4.	<--	STATUS PDU	-	-
15	Void				
16	Void				
17	Wait for <i>t-Reordering</i> to run out at the UE side.	-	-	-	-
18	Check: Does the UE transmit a Status Report with NACK_SN=4, NACK_SN=5 with SOStart=0 and SOEnd=49, and NACK_SN=6 with SOStart=50 and SOEnd=32767 (special SOEnd value), and ACK_SN=8?	-->	STATUS PDU	2	P
19	The SS transmits one AMD PDU segment containing 50 bytes of SDU#7 in its data field to the UE. This AMD PDU segment carries part 2 of AMD PDU#7, which contained SDU#7 (100 bytes) in its data field. SO=50 and LSF=1.	<--	AMD PDU#7 (SN=6) segment 2	-	-
20	The SS transmits one AMD PDU segment containing 50 bytes of SDU#6 in its data field to the UE. This AMD PDU segment carries part 1 of AMD PDU#6, which contained SDU#6 (100 bytes) in its data field. SO=0 and LSF=0.	<--	AMD PDU#6 (SN=5) segment 1	-	-
21	The SS transmits one AMD PDU segment containing 50 bytes of SDU#5 in its data field to the UE. This AMD PDU segment carries part 1 of AMD PDU#5, which contained SDU#5 (100 bytes) in its data field. SO=0 and LSF=0.	<--	AMD PDU#5 (SN=4) segment 1	-	-
22	Wait for <i>t-Reordering</i> to run out at the UE side.	-	-	-	-
23	Check: Does the UE transmit a Status Report with NACK_SN=4 with SOStart=50 and SOEnd=32767 (special SOEnd value), and ACK_SN=8?	-->	STATUS PDU	2	P
24	The SS transmits one AMD PDU segment containing 50 bytes of SDU#5 in its data field to the UE. This AMD PDU segment carries part 2 of AMD PDU#5, which contained SDU#5 (100 bytes) in its data field. SO=50 and LSF=1.	<--	AMD PDU#5 (SN=4) segment 2	-	-
24 A	The SS waits for 60 ms then SS transmits 4 uplink grants (UL grant allocation type 2) with a time spacing of 5 ms, each allowing the UE to transmit 1 RLC SDU.	<--	(UL grants)	-	-
25	Check: Does the UE transmit an RLC SDU containing SDU#5 in its data field?	-->	(RLC SDU#5)	1	P
26	Check: Does the UE transmit an RLC SDU containing SDU#6 in its data field?	-->	(RLC SDU#6)	1	P
27	Check: Does the UE transmit an RLC SDU containing SDU#7 in its data field?	-->	(RLC SDU#7)	1	P
28	Check: Does the UE transmit an RLC SDU containing SDU#8 in its data field?	-->	(RLC SDU#8)	1	P
29	The SS transmits an RLC STATUS PDU to the UE. This PDU acks PDUs up to those including SDU#7. ACK_SN=8.	<--	STATUS PDU	-	-

7.2.3.15.3.3 Specific message contents

None.

7.2.3.16 AM RLC / Re-transmission of RLC PDU without re-segmentation

7.2.3.16.1 Test Purpose (TP)

(1)

```
with { UE in E-UTRA RRC_CONNECTED state }
ensure that {
  when { UE receives a STATUS PDU including a NACK_SN for missing AMD PDUs and missing AMD PDUs can
fit into within the total size of RLC PDU(s) indicated by lower layer at the particular transmission
opportunity}
then { UE successfully retransmits missing AMD PDUs without re-segmentation}
}
```

(2)

```
with { UE in E-UTRA RRC_CONNECTED state }
ensure that {
  when { NACK received for missing AMD PDUs and RETX_COUNT < maxRetxThreshold }
then { UE retransmits AMD PDUs }
}
```

(3)

```
with { UE in E-UTRA RRC_CONNECTED state }
ensure that {
  when { an AMD PDU or a portion of an AMD PDU is considered for retransmission and if RETX_COUNT =
maxRetxThreshold }
then { UE indicates to upper layers that max retransmission has been reached }
}
```

7.2.3.16.2 Conformance requirements

References: The conformance requirements covered in the present TC are specified in: 3GPP TS 36.322 clause 5.2.1.

[TS 36.322 clause 5.2.1]

The transmitting side of an AM RLC entity can receive a negative acknowledgement (notification of reception failure by its peer AM RLC entity) for an AMD PDU or a portion of an AMD PDU by the following:

- STATUS PDU from its peer AM RLC entity.

When receiving a negative acknowledgement for an AMD PDU or a portion of an AMD PDU by a STATUS PDU from its peer AM RLC entity, the transmitting side of the AM RLC entity shall:

- if the SN of the corresponding AMD PDU falls within the range $VT(A) \leq SN < VT(S)$:
 - consider the AMD PDU or the portion of the AMD PDU for which a negative acknowledgement was received for retransmission.

When an AMD PDU or a portion of an AMD PDU is considered for retransmission, the transmitting side of the AM RLC entity shall:

- if the AMD PDU is considered for retransmission for the first time:
 - set the RETX_COUNT associated with the AMD PDU to zero;
- else, if it (the AMD PDU or the portion of the AMD PDU that is considered for retransmission) or a portion of it is not pending for retransmission already:
 - increment the RETX_COUNT;
- if RETX_COUNT = *maxRetxThreshold*:
 - indicate to upper layers that max retransmission has been reached.

When retransmitting an AMD PDU, the transmitting side of an AM RLC entity shall:

- if the AMD PDU can entirely fit within the total size of RLC PDU(s) indicated by lower layer at the particular transmission opportunity:
 - deliver the AMD PDU as it is except for the P field (the P field should be set according to sub clause 5.2.2) to lower layer;
- otherwise:
 - segment the AMD PDU form a new AMD PDU segment which will fit within the total size of RLC PDU(s) indicated by lower layer at the particular transmission opportunity and deliver the new AMD PDU segment to lower layer.

When retransmitting a portion of an AMD PDU, the transmitting side of an AM RLC entity shall:

- segment the portion of the AMD PDU as necessary, form a new AMD PDU segment which will fit within the total size of RLC PDU(s) indicated by lower layer at the particular transmission opportunity and deliver the new AMD PDU segment to lower layer.

When forming a new AMD PDU segment, the transmitting side of an AM RLC entity shall:

- only map the Data field of the original AMD PDU to the Data field of the new AMD PDU segment;
- set the header of the new AMD PDU segment in accordance with the description in sub clause 6.;
- set the P field according to sub clause 5.2.2.

7.2.3.16.3 Test description

7.2.3.16.3.1 Pre-test conditions

System Simulator:

- Cell 1.

UE:

None.

Preamble:

- The UE is in state Loopback Activated (state 4) according to [18] with a loopback size of 98 bytes with the exceptions listed in table 7.2.3.16.3.1-1.

Table 7.2.3.16.3.1-1: PDCP-Config-DRB-AM

Information Element	Value/remark	Comment	Condition
PDCP-Config-DRB-AM ::= SEQUENCE {			
rlc-AM SEQUENCE {			
statusReportRequired	FALSE		
}			
}			

7.2.3.16.3.2 Test procedure sequence

Table 7.2.3.16.3.2-1: Main behaviour

St	Procedure	Message Sequence		TP	Verdict
		U - S	Message		
1	The SS transmits one AMD PDU containing SDU#1 (100 bytes) in its data field.	<--	AMD PDU#1	-	-
2	The UE transmits one AMD PDU containing SDU#1 in its data field.	-->	AMD PDU#1 (SN=0)	-	-
3	The SS transmits one AMD PDU containing SDU#2 (100 bytes) in its data field.	<--	AMD PDU#2	-	-
4	The UE transmits one AMD PDU containing SDU#2 in its data field.	-->	AMD PDU#2 (SN=1)	-	-
5	The SS transmits an RLC STATUS PDU. ACK_SN=2, NACK_SN=0.	<--	STATUS PDU	-	-
6	Check: Does the UE transmit the AMD PDU not yet acknowledged?	-->	AMD PDU#1 (SN=0)	1	P
7	The SS transmits an RLC STATUS PDU. ACK_SN=2.	<--	STATUS PDU	-	-
8	The SS transmits one AMD PDU containing SDU#3 (100 bytes) in its data field.	<--	AMD PDU#3	-	-
9	The UE transmits an AMD PDU containing SDU#3 in its data field.	-->	AMD PDU#3 (SN=2)	-	-
-	EXCEPTION: Step 10 to 11 shall be repeated <i>maxRetxThreshold</i> times	-	-	-	-
10	The SS transmits an RLC STATUS PDU. ACK_SN =3 and NACK_SN =2.	<--	STATUS PDU	-	-
11	Check: Does the UE retransmit the AMD PDU not yet acknowledged?	-->	AMD PDU#3 (SN=2)	2	P
12	The SS transmits an RLC STATUS PDU. ACK_SN =3 and NACK_SN =2.	<--	STATUS PDU	-	-
13	Check: Does the UE transmit an RRC Connection Re-establishment Request message? Note 1	-	-	3	P
14	The SS transmits <i>RRCCConnectionReestablishment</i> message.	-	-	-	-
15	The UE transmits <i>RRCCConnectionReestablishmentComplete</i> message.	-	-	-	-
16	The SS transmits an <i>RRCCConnectionReconfiguration</i> message to resume SRB2 and DRB1.	-	-	-	-
-	EXCEPTION: Step 17 and Step 18 can happen in any order.	-	-	-	-
17	The UE transmits an <i>RRCCConnectionReconfigurationComplete</i> message.	-	-	-	-
18	The UE retransmits the AMD PDU not yet acknowledged. Note 2.	-->	AMD PDU#3 (SN=0)	-	-

Note 1: The RRC Connection Re-establishment procedure is initiated. See 36.331 cl. 5.3.7.2 and 5.3.11.3.
Note 2: The PDCP PDU contained in this AMD PDU carries PDCP SN=2.

7.2.3.16.3.3 Specific message contents

Table 7.2.3.16.3.3-1: RRCConnectionReconfiguration (step 16, Table 7.2.3.16.3.2-1)

Derivation Path: 36.508, Table 4.6.1-8			
Information Element	Value/remark	Comment	Condition
RRCConnectionReconfiguration ::= SEQUENCE {			
criticalExtensions CHOICE {			
c1 CHOICE{			
rrcConnectionReconfiguration-r8 SEQUENCE {			
radioResourceConfigDedicated	RadioResourceConfigDe dicated-HO		
}			
}			
}			
}			

7.2.3.17 AM RLC / Re-segmentation RLC PDU / SO, FI, LSF

7.2.3.17.1 Test Purpose (TP)

(1)

```
with { UE in E-UTRA RRC_CONNECTED state }
ensure that {
  when { AMD PDU to be retransmitted does not fit in new allocated TBS }
then { UE segments AMD PDU into AMD PDU segments }
}
```

(2)

```
with { UE in E-UTRA RRC_CONNECTED state }
ensure that {
  when { AMD PDU segment to be retransmitted does not fit in new allocated TBS }
then { UE resegments AMD PDU segment to fit TBS }
}
```

7.2.3.17.2 Conformance requirements

References: The conformance requirements covered in the present TC are specified in: 3GPP TS 36.322 clauses 4.2.1.3.2, 5.2.1, 6.2.1.4 and 6.2.1.5.

[TS 36.322, clause 4.2.1.3.2]

When the transmitting side of an AM RLC entity forms AMD PDUs from RLC SDUs, it shall:

- segment and/or concatenate the RLC SDUs so that the AMD PDUs fit within the total size of RLC PDU(s) indicated by lower layer at the particular transmission opportunity notified by lower layer.

The transmitting side of an AM RLC entity supports retransmission of RLC data PDUs (ARQ):

- if the RLC data PDU to be retransmitted does not fit within the total size of RLC PDU(s) indicated by lower layer at the particular transmission opportunity notified by lower layer, the AM RLC entity can re-segment the RLC data PDU into AMD PDU segments;
- the number of re-segmentation is not limited.

When the transmitting side of an AM RLC entity forms AMD PDUs from RLC SDUs received from upper layer or AMD PDU segments from RLC data PDUs to be retransmitted, it shall:

- include relevant RLC headers in the RLC data PDU.

[TS 36.322 clause 5.2.1]

...

When retransmitting an AMD PDU, the transmitting side of an AM RLC entity shall:

- if the AMD PDU can entirely fit within the total size of RLC PDU(s) indicated by lower layer at the particular transmission opportunity:
 - deliver the AMD PDU as it is except for the P field (the P field should be set according to sub clause 5.2.2) to lower layer;
- otherwise:
 - segment the AMD PDU form a new AMD PDU segment which will fit within the total size of RLC PDU(s) indicated by lower layer at the particular transmission opportunity and deliver the new AMD PDU segment to lower layer.

When retransmitting a portion of an AMD PDU, the transmitting side of an AM RLC entity shall:

- segment the portion of the AMD PDU as necessary form a new AMD PDU segment which will fit within the total size of RLC PDU(s) indicated by lower layer at the particular transmission opportunity and deliver the new AMD PDU segment to lower layer.

When forming a new AMD PDU segment, the transmitting side of an AM RLC entity shall:

- only map the Data field of the original AMD PDU to the Data field of the new AMD PDU segment;
- set the header of the new AMD PDU segment in accordance with the description in sub clause 6.;
- set the P field according to sub clause 5.2.2.

[TS 36.322, clause 6.2.1.4]

AMD PDU consists of a Data field and an AMD PDU header.

AMD PDU header consists of a fixed part (fields that are present for every AMD PDU) and an extension part (fields that are present for an AMD PDU when necessary). The fixed part of the AMD PDU header itself is byte aligned and consists of a D/C, a RF, a P, a FI, an E and a SN. The extension part of the AMD PDU header itself is byte aligned and consists of E(s) and LI(s).

An AMD PDU header consists of an extension part only when more than one Data field elements are present in the AMD PDU, in which case an E and a LI are present for every Data field element except the last. Furthermore, when an AMD PDU header consists of an odd number of LI(s), four padding bits follow after the last LI

....

[TS 36.322, clause 6.2.1.5]

AMD PDU segment consists of a Data field and an AMD PDU segment header.

AMD PDU segment header consists of a fixed part (fields that are present for every AMD PDU segment) and an extension part (fields that are present for an AMD PDU segment when necessary). The fixed part of the AMD PDU segment header itself is byte aligned and consists of a D/C, a RF, a P, a FI, an E, a SN, a LSF and a SO. The extension part of the AMD PDU segment header itself is byte aligned and consists of E(s) and LI(s).

An AMD PDU segment header consists of an extension part only when more than one Data field elements are present in the AMD PDU segment, in which case an E and a LI are present for every Data field element except the last. Furthermore, when an AMD PDU segment header consists of an odd number of LI(s), four padding bits follow after the last LI.

...

7.2.3.17.3 Test description

7.2.3.17.3.1 Pre-test conditions

System Simulator:

- Cell 1.

UE:

None.

Preamble:

- The UE is in state Loopback Activated (state 4) according to [18] with a loop back size of 98 bytes and the exceptions listed in table 7.2.3.17.3.1-1 applicable for the configured AM DRB.

Table 7.2.3.17.3.1-1: RLC settings

Parameter	Value
<i>t-PollRetransmit</i>	ms150

7.2.3.17.3.2 Test procedure sequence

Table 7.2.3.17.3.2-1: Main behaviour

St	Procedure	Message Sequence		TP	Verdict
		U - S	Message/PDU/SDU		
0	The SS stops the UL grant transmission.	-	-	-	-
1	The SS transmits one AMD PDU containing SDU#1 (100 bytes) in its data field.	<--	AMD PDU#1	-	-
1A	60 ms after step 1 the SS assigns one default grant (UL grant allocation type 2). (Note 6)	<--	(UL grant, 840 bits)	-	-
2	The UE transmits an AMD PDU with the same data contents as received in the corresponding part of DL PDU#1?	-->	AMD PDU#1 (SN=0)	-	-
3	20 ms after step 1 The SS transmits one AMD PDU containing SDU#2 (100 bytes) in its data field.	<--	AMD PDU#2	-	-
3A	60 ms after step 3 the SS assigns one default grant (UL grant allocation type 2). (Note 6)	<--	(UL grant, 840 bits)	-	-
4	The UE transmits an AMD PDU with the same data contents as received in the corresponding part of DL PDU#2?	-->	AMD PDU#2 (SN=1)	-	-
5	Void	-	-	-	-
6	The SS transmits a STATUS PDU. This PDU nacks the AMD PDU with SN=0. NACK_SN=0 and ACK_SN=2.	<--	STATUS PDU	-	-
6A	The SS waits for 20 ms and then allocates 2 UL grants (UL grant allocation type 2) of size 472 bits such that there is 20 ms gap between UL grants (Note 1, Note 4)	<--	(UL grants, 472 bits)	-	-
7	Check: Does the UE transmit an AMD PDU segment with SO=0, LSF=0 and the same data contents at the received positions as in the original AMD PDU?	-->	AMD PDU#1 segment 1 (SN=0)	1	P
8	Check: Does the UE transmit an AMD PDU segment with SO=<x>, LSF=1 and the same data contents at the received positions as in the original AMD PDU? (Note 3)	-->	AMD PDU#1 segment 2 (SN=0)	1	P
9	Void	-	-	-	-
10	After 100 ms the SS transmits a STATUS PDU. This PDU nacks the AMD PDU with SN=0. NACK_SN=0, SOStart=0, SOEnd=<x-1> and ACK_SN=2. (Note 3, Note 5)	<--	STATUS PDU	-	-
10A	The SS waits for 20 ms and then allocates 2 UL grants (UL grant allocation type 2) of size 328 bits such that there is 20 ms gap between UL grants (Note 2) (Note 4)	<--	(UL grants, 472 bits)	-	-
11	Check: Does the UE transmit an AMD PDU segment with SO=0, LSF=0 and the same data contents at the received positions as in the original AMD PDU?	-->	AMD PDU#1 segment 1, 1 st part (SN=0)	2	P
12	Check: Does the UE transmit an AMD PDU segment with SO=<y>, LSF=0 and the same data contents at the received positions as in the original AMD PDU? (Note 3)	-->	AMD PDU#1 segment 1, 2 nd part (SN=0)	2	P
13	The SS transmits a STATUS PDU. This PDU acks the AMD PDUs with SN=0 and SN=1. ACK_SN=2.	<--	STATUS PDU	-	-
<p>Note 1: UL grant of 472 bits ($I_{TBS}=7$, $N_{PRB}=4$, see TS 36.213 Table 7.1.7.2.1-1) is chosen such that UE will segment into 2 AMD PDUs. MAC PDU of 472 bits=59 bytes fits an AMD PDU payload of ≥ 50 bytes + 2 bytes AMD PDU header + 2 bytes of segment header + ? bytes spare for MAC header and possible RLC STATUS PDU and BSR report.</p> <p>Note 2: UL grant of 328 bits ($I_{TBS}=5$, $N_{PRB}=4$, see TS 36.213 Table 7.1.7.2.1-1) is chosen such that UE will segment into 2 AMD PDUs. MAC PDU of 328 bits=41 bytes fits an AMD PDU payload of ≥ 25 bytes + 2 bytes AMD PDU header + 2 bytes of segment header + ? bytes spare for MAC header and possible RLC STATUS PDU and BSR report.</p> <p>Note 3: The values x and y depend upon the need of the UE to add RLC STATUS PDU and BSR report. The TBS has been chosen to ensure that the PDUs to be resegmented can be carried in 2 segments.</p>					

Note 4: 20 ms gap between transmissions both in DL and UL respectively allows TTCN to tolerate one HARQ retransmission (FDD/TDD) per transport block, if such happen (TS 36.523-3).

Note 5: As <x> becomes available in step 8 only the transmission in step 10 can only be scheduled afterwards. This requires a 100 ms activation time.

Note 6: UL grant of 840 bits ($I_{TBS}=14$, $N_{PRB}=3$, see TS 36.213 Table 7.1.7.2.1-1) is chosen to allow the UE to transmit one PDU at a time.

7.2.3.17.3.3 Specific message contents

None.

7.2.3.18 AM RLC / Reassembly / AMD PDU reassembly from AMD PDU segments, Segmentation Offset and Last Segment Flag fields

7.2.3.18.1 Test Purpose (TP)

(1)

```
with { UE in E-UTRAN RRC_CONNECTED state }
ensure that {
  when { UE receives AM PDU segments }
  then { UE delivers reassembled RLC SDU to upper layer }
}
```

(2)

```
with { UE in E-UTRAN RRC_CONNECTED state }
ensure that {
  when { UE receives RLC AM PDU segments without segment header extension part }
  then { UE correctly reassembles RLC AMD PDU segments into RLC AMD PDUs }
}
```

(3)

```
with { UE in E-UTRAN RRC_CONNECTED state }
ensure that {
  when { UE receives RLC AM PDU segments with segment header extension part }
  then { UE correctly reassembles RLC AMD PDU segments into RLC AMD PDUs }
}
```

(4)

```
with { UE in E-UTRAN RRC_CONNECTED state }
ensure that {
  when { UE receives duplicate RLC AM PDU segments }
  then { UE discards duplicate RLC AMD PDU segments }
}
```

(5)

```
with { UE in E-UTRAN RRC_CONNECTED state }
ensure that {
  when { UE receives RLC AM PDU segments out of sequence }
  then { UE delivers reassembled RLC SDU to upper layer }
}
```

(6)

```
with { UE in E-UTRAN RRC_CONNECTED state }
ensure that {
  when { UE receives RLC AMD PDU segments with segments lost }
  then { UE transmits STATUS PDU to request retransmission of missing segments }
}
```

(7)

```
with { UE in E-UTRAN RRC_CONNECTED state }
ensure that {
  when { UE receives overlapping RLC AMD PDU segments }
  then { UE discards duplicate RLC AMD PDU byte segments }
}
```

7.2.3.18.2 Conformance requirements

References: The conformance requirements covered in the present TC are specified in: 3GPP TS 36.322 clauses 4.2.1.3.3, 5.1.3.2.2, 6.2.1.4 and 6.2.1.5.

[TS 36.322, clause 4.2.1.3.3]

When the receiving side of an AM RLC entity receives RLC data PDUs, it shall:

- detect whether or not the RLC data PDUs have been received in duplication, and discard duplicated RLC data PDUs;
- reorder the RLC data PDUs if they are received out of sequence;
- detect the loss of RLC data PDUs at lower layers and request retransmissions to its peer AM RLC entity;
- reassemble RLC SDUs from the reordered RLC data PDUs and deliver the RLC SDUs to upper layer in sequence.

...

[TS 36.322, clause 5.1.3.2.2]

When a RLC data PDU is received from lower layer, where the RLC data PDU contains byte segment numbers y to z of an AMD PDU with $SN = x$, the receiving side of an AM RLC entity shall:

- if x falls outside of the receiving window; or
- if byte segment numbers y to z of the AMD PDU with $SN = x$ have been received before:
 - discard the received RLC data PDU;
- else:
 - place the received RLC data PDU in the reception buffer;
 - if some byte segments of the AMD PDU contained in the RLC data PDU have been received before:
 - discard the duplicate byte segments.

[TS 36.322, clause 6.2.1.4]

AMD PDU consists of a Data field and an AMD PDU header.

AMD PDU header consists of a fixed part (fields that are present for every AMD PDU) and an extension part (fields that are present for an AMD PDU when necessary). The fixed part of the AMD PDU header itself is byte aligned and consists of a D/C, a RF, a P, a FI, an E and a SN. The extension part of the AMD PDU header itself is byte aligned and consists of E(s) and LI(s).

An AMD PDU header consists of an extension part only when more than one Data field elements are present in the AMD PDU, in which case an E and a LI are present for every Data field element except the last. Furthermore, when an AMD PDU header consists of an odd number of LI(s), four padding bits follow after the last LI.

...

[TS 36.322, clause 6.2.1.5]

AMD PDU segment consists of a Data field and an AMD PDU segment header.

AMD PDU segment header consists of a fixed part (fields that are present for every AMD PDU segment) and an extension part (fields that are present for an AMD PDU segment when necessary). The fixed part of the AMD PDU segment header itself is byte aligned and consists of a D/C, a RF, a P, a FI, an E, a SN, a LSF and a SO. The extension part of the AMD PDU segment header itself is byte aligned and consists of E(s) and LI(s).

An AMD PDU segment header consists of an extension part only when more than one Data field elements are present in the AMD PDU segment, in which case an E and a LI are present for every Data field element except the last.

Furthermore, when an AMD PDU segment header consists of an odd number of LI(s), four padding bits follow after the last LI.

...

7.2.3.18.3 Test description

7.2.3.18.3.1 Pre-test conditions

System Simulator:

- Cell 1.

UE:

None.

Preamble:

- The UE is in state Loopback Activated (state 4) according to [18] with a loop back size of 98 bytes.

7.2.3.18.3.2 Test procedure sequence

Table 7.2.3.18.3.2-1: Main behaviour

St	Procedure	Message Sequence		TP	Verdict
		U - S	Message/PDU/SDU		
1	The SS transmits an AMD PDU containing the first half (50 bytes) of SDU#1 in its data field. This PDU is in error (SN falls outside of the receiving window) and is to be discarded by the UE.	<--	AMD PDU#1 (SN=WindowSize+3)	-	-
2	The SS transmits an AMD PDU containing SDU#2 (100 bytes) in its data field with the P-bit set.	<--	AMD PDU#2 (SN=1, P=1)	-	-
3	The UE transmits a STATUS PDU with NACK_SN field indicating missing PDU#1. ACK_SN=2, NACK_SN=0.	-->	STATUS PDU	-	-
3A	The SS stops the UL grant transmission.	-	-	-	-
4	After 100 ms the SS transmits an AMD PDU segment of AMD PDU#1 (AMD PDU#1 carries SDU#1) containing the first 50 bytes of SDU#1 in its data field. SO=0 and LSF=0. No header extension part is provided.	<--	AMD PDU#1 (SN=0) segment 1	-	-
5	The SS transmits an AMD PDU segment of AMD PDU#1 (AMD PDU#1 carries SDU#1) containing the last 50 bytes of SDU#1 in its data field with the P-bit set. SO=50 and LSF=1. No header extension part is provided.	<--	AMD PDU #1 (SN=0, P=1) segment 2	-	-
5A	The SS waits for 60 ms to ensure UE RLC has all the required SDUs available and then assigns one default UL grant (UL grant allocation type 3).	<--	(UL grant)	-	-
6	Check: Does the UE transmit a STATUS PDU with ACK_SN=2, thus acknowledging the reception of PDUs with SN=0 and SN=1, and no NACK_SN provided?	-->	STATUS PDU	2	P
7	Check: Does the UE transmit RLC SDU#1 and RLC SDU#2?	-->	AMD PDU (RLC SDU#1, RLC SDU#2)	1	P
8	Void	-	-	-	-
8A	The SS transmits a STATUS PDU.	<--	STATUS PDU (ACK SN=1)	-	-
9	After 100 ms the SS transmits an AMD PDU segment of AMD PDU#3 (AMD PDU#3 carries SDU#3 and SDU#4) containing the last 50 bytes of SDU#4 in its data field, with the P-bit set. FI=10, SO=150 and LSF=1. No header extension part is provided.	<--	AMD PDU#3 (SN=2, P=1) segment 2	-	-
9A	100 ms after step 9 the SS assigns one default grant (UL grant allocation type 3).	<--	(UL grant)	-	-
10	The UE transmits a STATUS PDU NACK_SN field for receipt of PDU#3. ACK_SN=3, NACK_SN=2, SOStart=0/SOEnd=149.	-->	STATUS PDU	-	-
11	After 100 ms the SS transmits an AMD PDU segment of AMD PDU#3 (AMD PDU#3 carries SDU#3 and SDU#4) containing SDU#3 (100 bytes) and the first 50 bytes of SDU#4 in its data field, with the P-bit set. FI=01, SO=0 and LSF=0. Header extension part present: E in fixed part header=1, E in extension part header=0, LI=100.	<--	AMD PDU#3 (SN=2, P=1) segment 1	-	-
11 A	The SS waits for 60 ms to ensure UE RLC has all the required SDUs available and then assigns one default UL grant (UL grant allocation type 3).	<--	(UL grant)	-	-
12	Check: Does the UE transmit a STATUS PDU with ACK_SN=3?	-->	STATUS PDU	3	P
13	Void	-	-	-	-
14	Check: Does the UE transmit RLC SDU#3 and RLC SDU#4?	-->	AMD PDU (RLC SDU#3, RLC SDU#4)	1,5	P

14 A	The SS transmits a STATUS PDU.	<--	STATUS PDU (ACK SN=2)	-	-
15	After 100 ms the SS transmits an AMD PDU segment of AMD PDU#4 (AMD PDU#4 carries SDU#5) containing the first 50 bytes of SDU#5 in its data field. SO=0 and LSF=0. No header extension part is provided.	<--	AMD PDU#4 (SN=3) segment 1	-	-
16	The SS transmits an AMD PDU segment of AMD PDU#4 (AMD PDU#4 carries SDU#5) containing the first 50 bytes of SDU#5 in its data field. SO=0 and LSF=0. No header extension part is provided.	<--	AMD PDU#4 (SN=3) segment 1	-	-
17	The SS transmits an AMD PDU segment of AMD PDU#4 (AMD PDU#4 carries SDU#5) containing the last 50 bytes of SDU#5 in its data field, with the P-bit set. SO=50 and LSF=1. No header extension part is provided.	<--	AMD PDU#4 (SN=3, P=1) segment 2	-	-
17 A	The SS waits for 60 ms to ensure UE RLC has all the required SDUs available and then assigns one default UL grant (UL grant allocation type 3).	<--	(UL grant)	-	-
18	Check: Does the UE transmit a STATUS PDU with ACK_SN=4, thus acknowledging the reception of PDUs with SN=0 to SN=3, and no NACK_SN provided?	-->	STATUS PDU	4	P
19	Check: Does the UE transmit RLC SDU#5?	-->	(RLC SDU#5)	1	P
19 A	The SS transmits a STATUS PDU.	<--	STATUS PDU (ACK SN=3)	-	-
20	After 100 ms the SS transmits an AMD PDU segment of AMD PDU#6 (AMD PDU#6 carries SDU#7) containing the last 50 bytes of SDU#7 in its data field, with the P-bit set. This AMD PDU segment is sent with SN=5. SO=50 and LSF=1. No header extension part is provided.	<--	AMD PDU#6 (SN=5, P=1) segment 2	-	-
20 A	100 ms after step 20 the SS assigns one default grant (UL grant allocation type 3).	<--	(UL grant)	-	-
21	Check: Does the UE transmit a STATUS PDU with ACK_SN=6, thus acknowledging the reception of PDUs with SN=0 to SN=5, and NACK_SN=4, E1/E2 field for receipt of PDU#5 and NACK_SN=5, SOStart=0/SOEnd=49 for segment 1 of PDU#6?	-->	STATUS PDU	6	P
22	After 100 ms the SS transmits an AMD PDU segment of AMD PDU#6 (AMD PDU#6 carries SDU#7) containing the first 50 bytes of SDU#7 in its data field. SO=0 and LSF=0. No header extension part is provided.	<--	AMD PDU#6 (SN=5) segment 1	-	-
23	The SS transmits one AMD PDU containing SDU#6 (100 bytes) in its data field, with the P-bit set.	<--	AMD PDU#5 (SN=4, P=1)	-	-
23 A	The SS waits for 60 ms to ensure UE RLC has all the required SDUs available and then assigns one default UL grant (UL grant allocation type 3).	<--	(UL grant)	-	-
24	The UE transmits a STATUS PDU with ACK_SN=6, thus acknowledging the reception of PDUs with SN=0 to SN=5, and no NACK_SN provided.	-->	STATUS PDU	-	-
25	Void	-	-	-	-
26	Check: Does the UE transmit RLC SDU#6 and RLC SDU#7?	-->	AMD PDU (RLC SDU#6, RLC SDU#7)	2,5	P
26 A	The SS transmits a STATUS PDU.	<--	STATUS PDU (ACK SN=4)	-	-
27	After 100 ms the SS transmits an AMD PDU segment of AMD PDU#7 (AMD PDU#7 carries SDU#8, SDU#9 and SDU#10) containing the last 20 bytes of SDU#9 and the complete SDU#10 (100 bytes) in its data field, with the	<--	AMD PDU#7 (SN=6, P=1) segment 3	-	-

	P-bit set. FI=10, SO=180 and LSF=1. Header extension part present: E in fixed part header=1, E in extension part header=0, LI=20.				
27 A	100 ms after step 27 the SS assigns one default grant (UL grant allocation type 3).	<--	(UL grant)	-	-
28	The UE transmits a STATUS PDU NACK_SN field for receipt of PDU#7. ACK_SN=7, NACK_SN=6, SOStart=0/SOEnd=179.	-->	STATUS PDU	-	-
29	After 100 ms the SS transmits an AMD PDU segment of AMD PDU#7 (AMD PDU#7 carries SDU#8, SDU#9 and SDU#10) containing the last 20 bytes of SDU#8 and the complete SDU#9 in its data field, with the P-bit set. FI=10, SO=80 and LSF=0. Header extension part present: E in fixed part header=1, E in extension part header=0, LI=20.	<--	AMD PDU#7 (SN=6, P=1) segment 2	-	-
29 A	30 ms after step 29 the SS assigns one default grant (UL grant allocation type 3).	<--	(UL grant)	-	-
30	The UE transmits a STATUS PDU NACK_SN field for receipt of PDU#7. ACK_SN=7, NACK_SN=6, SOStart=0/SOEnd=79.	-->	STATUS PDU	7	P
31	60 ms after step 29 the SS transmits an AMD PDU segment of AMD PDU#7 (AMD PDU#7 carries SDU#8, SDU#9 and SDU#10) containing the first 80 bytes of SDU#8 in its data field, with the P-bit set. SO=0 and LSF=0. No header extension part is provided. Note 4	<--	AMD PDU#7 (SN=6, P=1) segment 1	-	-
31 A	The SS waits for 60 ms to ensure UE RLC has all the required SDUs available and then assigns one default UL grant (UL grant allocation type 3).	<--	(UL grant)	-	-
32	Check: Does the UE transmit a STATUS PDU with ACK_SN=7, thus acknowledging the reception of PDUs with SN=0 to SN=6, and no NACK_SN provided?	-->	STATUS PDU	7	P
33	Void	-	-	-	-
34	Void	-	-	-	-
35	Check: Does the UE transmit RLC SDU#8, RLC SDU#9 and RLC SDU#10?	-->	AMD PDU (RLC SDU#8, RLC SDU#9, RLC SDU#10)	7	P
36	The SS transmits a STATUS PDU.	<--	STATUS PDU (ACK SN=5)	-	-
<p>Note 1: From steps 4 onwards, the transmission of AMD PDUs is scheduled. The activation time of 100 ms for the first of possibly several AMD PDUs is greater than <i>t-StatusProhibit</i>, and therefore there is no need to wait for the expiry of this timer. Subsequent AMD PDU transmissions are using subsequent TTIs.</p> <p>Note 2: In steps 6-8, 12-14, 18-19, 24-26, 32-35 the STATUS PDU and the AMD PDU consisting of one or more RLC SDUs are received as a PDU list in one TTI.</p> <p>Note 3: In step 29A it is assumed that the UE will react upon the AMD PDU within 30 ms.</p> <p>Note 4: Step 31 shall be executed within 60 ms after step 29 to ensure that the UE receives the AMD PDU before the expiry of <i>t-Reordering</i> at the UE.</p>					

7.2.3.18.3.3 Specific message contents

None.

7.2.3.19 Void

7.2.3.20 AM RLC / Duplicate detection of RLC PDUs

7.2.3.20.1 Test Purpose (TP)

(1)

```
with { UE in E-UTRA RRC_CONNECTED state }
ensure that {
  when { UE is in AM mode and receives duplicated RLC data PDUs having the same sequence number }
  then { UE discards the duplicated RLC data PDUs }
```

}

7.2.3.20.2 Conformance requirements

References: The conformance requirements covered in the current TC are specified in: TS 36.322, clause 4.2.1.3.3.

[TS 36.322, clause 4.2.1.3.3]

When the receiving side of an AM RLC entity receives RLC data PDUs, it shall:

- detect whether or not the RLC data PDUs have been received in duplication, and discard duplicated RLC data PDUs;

...

7.2.3.20.3 Test description

7.2.3.20.3.1 Pre-test conditions

System Simulator:

- Cell 1.

UE:

None.

Preamble:

- The UE is in state Loopback Activated (state 4) according to [18].

7.2.3.20.3.2 Test procedure sequence

Table 7.2.3.20.3.2-1: Main behaviour

St	Procedure	Message Sequence		TP	Verdict
		U - S	Message		
1	SS creates 3 RLC SDUs of size 40 bytes segmented into two AMD PDUs each. AMD PDU#1 and AMD PDU#2 belong to RLC SDU#1, AMD PDU#3 and #4 belong to RLC SDU#2 and AMD PDU#5 and #6 belong to RLC SDU#3. SS transmits AMD PDU#1 with SN=0, AMD PDU#2 with SN=1 and AMD PDU#3 twice with SN=2.	<--	RLC AMD PDU#1 (SN=0) RLC AMD PDU#2 (SN=1) RLC AMD PDU#3 (SN=2) RLC AMD PDU#3 (SN=2)	-	-
2	Check: Does the UE transmit RLC SDU#1? (Note 1)	-->	(RLC SDU#1)	1	P
3	SS transmits AMD PDU#4 with SN=3.	<--	RLC AMD PDU#4 (SN=3)	-	-
4	Check: Does the UE transmit RLC SDU#2?	-->	(RLC SDU#2)	1	P
5	SS transmits AMD PDU#6 twice with SN=5.	<--	RLC AMD PDU#6 (SN=5) RLC AMD PDU#6 (SN=5)	-	-
6	SS transmits AMD PDU#5 twice with SN=4.	<--	RLC AMD PDU#5 (SN=4) RLC AMD PDU#5 (SN=4)	-	-
7	Check: Does the UE transmit RLC SDU#3 once? (Note 2)	-->	(RLC SDU#3)	1	P
Note 1: The duplicated AMD PDU#3 have been discarded by the conformant UE in step 1.					
Note 2: The duplicated AMD PDU#5 and AMD PDU#6 have been discarded by the conformant UE in steps 5 and 6.					

7.2.3.20.3.3 Specific message content

None.

7.2.3.21 AM RLC / RLC re-establishment at RRC connection reconfiguration including *mobilityControlInfo* IE

7.2.3.21.1 Test Purpose (TP)

(1)

```
with { UE in E-UTRA RRC_CONNECTED state }
ensure that {
  when { UE is requested to perform a RRC Connection reconfiguration including mobilityControlInfo
  IE }
  then { UE discards the remaining AMD PDUs; and discards all RLC SDUs in the transmitting side;
and reset all state variables to their initial values. }
}
```

7.2.3.21.2 Conformance requirements

References: The conformance requirements covered in the current TC are specified in: TS 36.322, clause 5.4 and TS 36.331 clause 5.3.5.4.

[TS 36.322, clause 5.4]

RLC re-establishment is performed upon request by RRC, and the function is applicable for AM, UM and TM RLC entities.

When RRC indicates that an RLC entity should be re-established, the RLC entity shall:

...

- if it is an AM RLC entity:
 - when possible, reassemble RLC SDUs from any byte segments of AMD PDUs with SN < VR(MR) in the receiving side, remove RLC headers when doing so and deliver all reassembled RLC SDUs to upper layer in ascending order of the RLC SN, if not delivered before;
 - discard the remaining AMD PDUs and byte segments of AMD PDUs in the receiving side;
 - discard all RLC SDUs and AMD PDUs in the transmitting side;
 - discard all RLC control PDUs.
- stop and reset all timers;
- reset all state variables to their initial values.

[TS 36.331, clause 5.3.5.4]

If the *RRCCongestionReconfiguration* message includes the *mobilityControlInfo* and the UE is able to comply with the configuration included in this message, the UE shall:

....

- 1> re-establish RLC for all RBs that are established;

...

7.2.3.21.3 Test description

7.2.3.21.3.1 Pre-test conditions

System Simulator:

- Cell 1.

UE:

None.

Preamble:

- The UE is in state Loopback Activated (state 4) according to [18] with the exceptions listed in table 7.2.3.21.3.1-1.

Table 7.2.3.21.3.1-1: RLC settings

Parameter	Value
<i>t-Reordering</i>	ms150
<i>t-PollRetransmit</i>	ms150

7.2.3.21.3.2 Test procedure sequence

Table 7.2.3.21.3.2-1: Main behaviour

St	Procedure	Message Sequence		TP	Verdict
		U - S	Message		
-	The SS ignores scheduling requests and does not allocate any uplink grant.	-	-	-	-
1	SS creates 3 RLC SDUs of size 40 bytes segmented into two AMD PDUs each. AMD PDU#1 and AMD PDU#2 belong to RLC SDU#1, AMD PDU#3 and #4 belong to RLC SDU#2 and AMD PDU#5 and #6 belong to RLC SDU#3. SS transmits AMD PDU#1 (SN=0), AMD PDU#2 (SN=1) and AMD PDU#4 (SN=3).	<--	AMD PDU#1 AMD PDU#2 AMD PDU#4	-	-
1A	60 ms after step 1 the SS allocates 1 UL grant of default size (UL grant allocation type 3).	<--	(UL grant)		
2	The UE returns RLC SDU#1.	-->	(RLC SDU#1)	-	-
3	SS does not acknowledge the reception of RLC SDU#1.	-	-	-	-
4	90 ms after step 1 SS performs a RRC Connection Reconfiguration procedure including the <i>mobilityControlInfo</i> IE triggering RLC-reestablishment. (Note 1)	-	-	-	-
4A A	The SS starts the UL default grant transmissions	-	-	-	-
4A	The UE retransmits RLC SDU #1. (Note 1A)	-->	(RLC SDU#1)	-	-
4B	SS transmits a STATUS PDU (ACK_SN = 1).	<--	STATUS PDU	-	-
5	SS transmits AMD PDU#5 with SN=0 and the P field set to "1"	<--	AMD PDU#5	-	-
6	Check: Does the UE transmit a STATUS PDU? (Note 2)	-->	STATUS PDU (ACK_SN = 1)	1	P
7	SS transmits AMD PDU#6 with SN=Receiving_AM_Window_Size+2	<--	AMD PDU#6	-	-
8	Check: Does the UE return RLC SDU#3 within 1s? (Note 3)	-->	(RLC SDU#3)	1	F
9	SS transmits AMD PDU#6 with SN=1	<--	AMD PDU#6	-	-
10	Check: Does the UE return RLC SDU#3 with its first AMD PDU set to SN=1?	-->	(RLC SDU#3)	1	P
<p>Note 1: Upon a RLC re-establishment a conformant UE discards any remaining AMD PDUs in the receiver and transmitter side, stops and resets all timers and resets all state variables to their initial values.</p> <p>Note 1A: The UE will retransmit the PDCP SDU associated with RLC SDU#1 in accordance to TS 36.323 clause 5.2.1.1.</p> <p>Note 2: AMD PDU#4 is discarded by a conformant UE in step 4.</p> <p>Note 3: AMD PDU#6 is discarded by a conformant UE due to being outside the receiving window size.</p>					

7.2.3.21.3.3 Specific message contents

Table 7.2.3.21.3.3-1: RRCConnectionReconfiguration (step 4, table 7.2.3.21.3.2-1)

Derivation Path: 36.508 table 4.6.1-8: RRCConnectionReconfiguration, condition HO			
Information Element	Value/remark	Comment	Condition
RRCConnectionReconfiguration ::= SEQUENCE {			
criticalExtensions CHOICE {			
c1 CHOICE{			
rrcConnectionReconfiguration-r8 SEQUENCE {			
mobilityControlInfo SEQUENCE {			
targetPhysCellId	Set to the physical cell identity of cell 1		
carrierFreq	Not present		
}			
radioResourceConfigCommon	Not present		
}			
}			
}			
}			

7.3 PDCP

7.3.1 Maintenance of PDCP sequence numbers for radio bearers

7.3.1.1 Maintenance of PDCP sequence numbers / User plane / RLC AM

7.3.1.1.1 Test Purpose (TP)

(1)

```
with { UE in E-UTRA RRC_CONNECTED state }
ensure that {
  when { UE transmits a PDCP Data SDU on a DRB mapped on AM RLC }
  then { UE increments SN with 1 for each transmitted PDU for SN=0 to Maximum_PDCP_SN }
}
```

(2)

```
with { UE in E-UTRA RRC_CONNECTED state }
ensure that {
  when { UE transmits a PDCP Data SDU on a DRB mapped on AM RLC and, after incrementation,
Next_PDCP_TX_SN is larger than the Maximum_PDCP_SN }
  then { UE sets SN to 0 in the next transmitted PDCP SDU}
}
```

7.3.1.1.2 Conformance requirements

References: The conformance requirements covered in the present TC are specified in: 3GPP TS 36.323 clause 5.1.1, 5.1.2.2 and 6.2.3.

[TS 36.323, clause 5.1.1]

At reception of a PDCP SDU from upper layers, the UE shall:

- *discardTimer* start the associated with this PDCP SDU (if configured);

For a PDCP SDU received from upper layers, the UE shall:

- associate the PDCP SN corresponding to *Next_PDCP_TX_SN* to this PDCP SDU;
- perform header compression of the PDCP SDU (if configured) as specified in the subclause 5.5.4;
- perform integrity protection (if applicable), and ciphering (if applicable) using COUNT based on *TX_HFN* and the PDCP SN associated with this PDCP SDU as specified in the subclause 5.7 and 5.6, respectively;
- increment *Next_PDCP_TX_SN* by one;

- if $\text{Next_PDCP_TX_SN} > \text{Maximum_PDCP_SN}$:
 - set Next_PDCP_TX_SN to 0;
 - increment TX_HFN by one;
- submit the resulting PDCP Data PDU to lower layer.

[TS 36.323, clause 5.1.2.1.2]

For DRBs mapped on RLC AM, at reception of a PDCP Data PDU from lower layers, the UE shall:

- if received $\text{PDCP SN} - \text{Last_Submitted_PDCP_RX_SN} > \text{Reordering_Window}$ or $0 \leq \text{Last_Submitted_PDCP_RX_SN} - \text{received PDCP SN} < \text{Reordering_Window}$:
 - if received $\text{PDCP SN} > \text{Next_PDCP_RX_SN}$:
 - decipher the PDCP PDU as specified in the subclause 5.6, using COUNT based on $\text{RX_HFN} - 1$ and the received PDCP SN;
 - else:
 - decipher the PDCP PDU as specified in the subclause 5.6, using COUNT based on RX_HFN and the received PDCP SN;
 - perform header decompression (if configured) as specified in the subclause 5.5.5;
 - discard this PDCP SDU;
- else if $\text{Next_PDCP_RX_SN} - \text{received PDCP SN} > \text{Reordering_Window}$:
 - increment RX_HFN by one;
 - use COUNT based on RX_HFN and the received PDCP SN for deciphering the PDCP PDU;
 - set Next_PDCP_RX_SN to the received PDCP SN + 1;
- else if received $\text{PDCP SN} - \text{Next_PDCP_RX_SN} \geq \text{Reordering_Window}$:
 - use COUNT based on $\text{RX_HFN} - 1$ and the received PDCP SN for deciphering the PDCP PDU;
- else if received $\text{PDCP SN} \geq \text{Next_PDCP_RX_SN}$:
 - use COUNT based on RX_HFN and the received PDCP SN for deciphering the PDCP PDU;
 - set Next_PDCP_RX_SN to the received PDCP SN + 1;
- if Next_PDCP_RX_SN is larger than Maximum_PDCP_SN :
 - set Next_PDCP_RX_SN to 0;
 - increment RX_HFN by one;
- else if received $\text{PDCP SN} < \text{Next_PDCP_RX_SN}$:
 - use COUNT based on RX_HFN and the received PDCP SN for deciphering the PDCP PDU;
- if the PDCP PDU has not been discarded in the above:
 - perform deciphering and header decompression (if configured) for the PDCP PDU as specified in the subclauses 5.6 and 5.5.5, respectively;
- if a PDCP SDU with the same PDCP SN is stored:
 - discard this PDCP SDU;
- else:
 - store the PDCP SDU;

- if the PDCP PDU received by PDCP is not due to the re-establishment of lower layers:
 - deliver to upper layers in ascending order of the associated COUNT value:
 - all stored PDCP SDU(s) with an associated COUNT value less than the COUNT value associated with the received PDCP SDU;
 - all stored PDCP SDU(s) with consecutively associated COUNT value(s) starting from the COUNT value associated with the received PDCP SDU;
 - set Last_Submitted_PDCP_RX_SN to the PDCP SN of the last PDCP SDU delivered to upper layers;
- else if received PDCP SN = Last_Submitted_PDCP_RX_SN + 1 or received PDCP SN = Last_Submitted_PDCP_RX_SN – Maximum_PDCP_SN:
 - deliver to upper layers in ascending order of the associated COUNT value:
 - all stored PDCP SDU(s) with consecutively associated COUNT value(s) starting from the COUNT value associated with the received PDCP SDU;
 - set Last_Submitted_PDCP_RX_SN to the PDCP SN of the last PDCP SDU delivered to upper layers.

[TS 36.323, clause 6.2.3]

Figure 6.2.3.1 shows the format of the PDCP Data PDU when a 12 bit SN length is used. This format is applicable for PDCP Data PDUs carrying data from DRBs mapped on RLC AM or RLC UM.

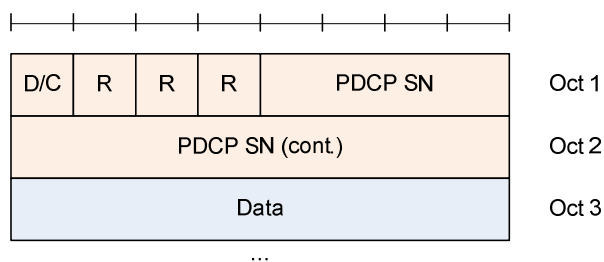

		U - S	Message		
-	EXCEPTION: Steps 1 and 2 shall be repeated for k=0 to Maximum_PDCP_SN (increment=1).				
1	SS transmits a PDCP Data PDU on DRB1 containing one IP packet without header compression.	<--	PDCP Data PDU (SN = k)		
2	CHECK: Does UE transmit a PDCP Data PDU with SN=0 for the first iteration and then incremented by 1 at each iteration?	-->	PDCP Data PDU (SN = k)	1	P
3	SS transmits a PDCP Data PDU on DRB1 containing one IP packet without header compression.	<--	PDCP Data PDU (SN = 0)		
4	CHECK: Does UE transmit a PDCP Data PDU with SN=0?	-->	PDCP Data PDU (SN = 0)	2	P
5	SS sends a PDCP Data PDU on DRB1 containing one IP packet without header compression.	<--	PDCP Data PDU (SN = 1)		
6	CHECK: Does UE transmit a PDCP Data PDU with SN=1?	-->	PDCP Data PDU (SN = 1)	1	P

7.3.1.1.3.3 Specific message contents

None

7.3.1.2 Maintenance of PDCP sequence numbers / User plane / RLC UM / Short PDCP SN (7 bits)

7.3.1.2.1 Test Purpose (TP)

(1)

```
with { UE in E-UTRA RRC_CONNECTED state }
ensure that {
  when { UE transmits a PDCP Data SDU on a DRB mapped on UM RLC and configured for short PDCP SN
size (7 bits) }
  then { UE increments SN with 1 for each transmitted PDU for SN=0 to Maximum_PDCP_SN }
}
```

(2)

```
with { UE in E-UTRA RRC_CONNECTED state }
ensure that {
  when { UE transmits a PDCP Data SDU on a DRB mapped on UM RLC and configured for short PDCP SN
size (7 bits); and, after incrementation, Next_PDCP_TX_SN is larger than the Maximum_PDCP_SN }
  then { UE sets SN to 0 in the next transmitted PDCP SDU }
}
```

7.3.1.2.2 Conformance requirements

References: The conformance requirements covered in the present TC are specified in: 3GPP TS 36.323 clause 5.1.1 , 5.1.2.1.3 and 6.2.4.

[TS 36.323, clause 5.1.1]

At reception of a PDCP SDU from upper layers, the UE shall:

- start the *discardTimer* associated with this PDCP SDU (if configured);

For a PDCP SDU received from upper layers, the UE shall:

- associate the PDCP SN corresponding to Next_PDCP_TX_SN to this PDCP SDU;
- perform header compression of the PDCP SDU (if configured) as specified in the subclause 5.5.4;
- perform integrity protection (if applicable), and ciphering (if applicable) using COUNT based on TX_HFN and the PDCP SN associated with this PDCP SDU as specified in the subclause 5.7 and 5.6, respectively;
- increment Next_PDCP_TX_SN by one;

- if Next_PDCP_TX_SN > Maximum_PDCP_SN:
 - set Next_PDCP_TX_SN to 0;
 - increment TX_HFN by one;
- submit the resulting PDCP Data PDU to lower layer.

[TS 36.323, clause 5.1.2.1.3]

For DRBs mapped on RLC UM, at reception of a PDCP Data PDU from lower layers, the UE shall:

- if received PDCP SN < Next_PDCP_RX_SN:
 - increment RX_HFN by one;
- decipher the PDCP Data PDU using COUNT based on RX_HFN and the received PDCP SN as specified in the subclause 5.6;
- set Next_PDCP_RX_SN to the received PDCP SN + 1;
- if Next_PDCP_RX_SN > Maximum_PDCP_SN:
 - set Next_PDCP_RX_SN to 0;
 - increment RX_HFN by one;
- perform header decompression (if configured) of the deciphered PDCP Data PDU as specified in the subclause 5.5.5;
- deliver the resulting PDCP SDU to upper layer.

[TS 36.323, clause 6.2.4]

Figure 6.2.4.1 shows the format of the PDCP Data PDU when a 7 bit SN length is used. This format is applicable for PDCP Data PDUs carrying data from DRBs mapped on RLC UM.

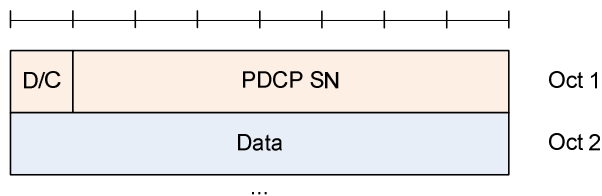

Figure 6.2.4.1: PDCP Data PDU format for DRBs using 7 bit SN

7.3.1.2.3 Test description

7.3.1.2.3.1 Pre-test conditions

System Simulator

- Cell 1
- SS PDCP set to Transparent Mode

UE:

None.

Preamble

- The UE is in state Loopback Activated (state 4) according to [18].

- The condition SRB2-DRB(1,1) is used for step 8 in 4.5.3A.3 according to [18].

7.3.1.2.3.2 Test procedure sequence

Table 7.3.1.2.3.2-1: Main behaviour

St	Procedure	Message Sequence		TP	Verdict
		U - S	Message		
-	EXCEPTION: Steps 1 and 2 shall be repeated for k=0 to Maximum_PDCP_SN (increment=1).				
1	SS transmits a PDCP Data PDU on UM DRB containing one IP packet without header compression.	<--	PDCP Data PDU (SN = k)		
2	CHECK: Does UE transmit a PDCP Data PDU with SN=0 for the first iteration and then incremented by 1 at each iteration?	-->	PDCP Data PDU (SN = k)	1	P
3	SS transmits a PDCP Data PDU on UM DRB containing one IP packet without header compression.	<--	PDCP Data PDU (SN = 0)		
4	CHECK: Does UE transmit a PDCP Data PDU with SN=0?	-->	PDCP Data PDU (SN = 0)	2	P
5	SS sends a PDCP Data PDU on UM DRB containing one IP packet without header compression.	<--	PDCP Data PDU (SN = 1)		
6	CHECK: Does UE transmit a PDCP Data PDU with SN=1?	-->	PDCP Data PDU (SN = 1)	1	P

7.3.1.2.3.3 Specific message contents

None

7.3.1.3 Maintenance of PDCP sequence numbers / User plane / RLC UM / Long PDCP SN (12 bits)

7.3.1.3.1 Test Purpose (TP)

(1)

```
with { UE in E-UTRA RRC_CONNECTED state }
ensure that {
  when { UE transmits a PDCP Data SDU on a DRB mapped on UM RLC and configured for long PDCP SN size (12 bits) }
  then { UE increments SN with 1 for each transmitted PDU for SN=0 to Maximum_PDCP_SN }
}
```

(2)

```
with { UE in E-UTRA RRC_CONNECTED state }
ensure that {
  when { UE transmits a PDCP Data SDU on a DRB mapped on UM RLC and configured for long PDCP SN size (12 bits); and, after incrementation, Next_PDCP_TX_SN is larger than the Maximum_PDCP_SN limit }
  then { UE sets SN to 0 in the next transmitted PDCP SDU }
}
```

7.3.1.3.2 Conformance requirements

References: The conformance requirements covered in the present TC are specified in: 3GPP TS 36.323 clause 5.1.1, 5.1.2.1.3 and 6.2.3.

[TS 36.323, clause 5.1.1]

At reception of a PDCP SDU from upper layers, the UE shall:

- start the *discardTimer* associated with this PDCP SDU (if configured);

For a PDCP SDU received from upper layers, the UE shall:

- associate the PDCP SN corresponding to Next_PDCP_TX_SN to this PDCP SDU;

- perform header compression of the PDCP SDU (if configured) as specified in the subclause 5.5.4;
- perform integrity protection (if applicable), and ciphering (if applicable) using COUNT based on TX_HFN and the PDCP SN associated with this PDCP SDU as specified in the subclause 5.7 and 5.6, respectively;
- increment Next_PDCP_TX_SN by one;
- if Next_PDCP_TX_SN > Maximum_PDCP_SN:
 - set Next_PDCP_TX_SN to 0;
 - increment TX_HFN by one;
- submit the resulting PDCP Data PDU to lower layer.

[TS 36.323, clause 5.1.2.1.3]

For DRBs mapped on RLC UM, at reception of a PDCP Data PDU from lower layers, the UE shall:

- if received PDCP SN < Next_PDCP_RX_SN:
 - increment RX_HFN by one;
- decipher the PDCP Data PDU using COUNT based on RX_HFN and the received PDCP SN as specified in the subclause 5.6;
- set Next_PDCP_RX_SN to the received PDCP SN + 1;
- if Next_PDCP_RX_SN > Maximum_PDCP_SN:
 - set Next_PDCP_RX_SN to 0;
 - increment RX_HFN by one;
- perform header decompression (if configured) of the deciphered PDCP Data PDU as specified in the subclause 5.5.5;
- deliver the resulting PDCP SDU to upper layer.

[TS 36.323, clause 6.2.3]

Figure 6.2.3.1 shows the format of the PDCP Data PDU when a 12 bit SN length is used. This format is applicable for PDCP Data PDUs carrying data from DRBs mapped on RLC AM or RLC UM.

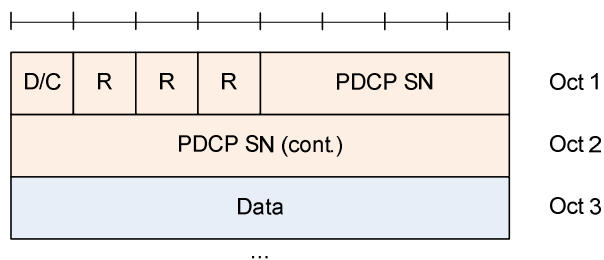

Figure 6.2.3.1: PDCP Data PDU format for DRBs using a 12 bit SN

7.3.1.3.3 Test description

7.3.1.3.3.1 Pre-test conditions

System Simulator

- Cell 1
- SS PDCP set to Transparent Mode

UE:

None.

Preamble

- The UE is in state Loopback Activated (state 4) according to [18] with the RLC UM bearer configured for long PDCP SN size (12 bits).
- The condition SRB2-DRB(1,1) is used for step 8 in 4.5.3A.3 according to [18].

7.3.1.3.3.2 Test procedure sequence

Table 7.3.1.3.3.2-1: Main behaviour

St	Procedure	Message Sequence		TP	Verdict
		U - S	Message		
-	EXCEPTION: Steps 1 and 2 shall be repeated for k=0 to Maximum_PDCP_SN (increment=1).				
1	SS transmits a PDCP Data PDU on UM DRB containing one IP packet without header compression.	<--	PDCP Data PDU (SN = k)		
2	CHECK: Does UE transmit a PDCP Data PDU with SN=0 for the first iteration and then incremented by 1 at each iteration?	-->	PDCP Data PDU (SN = k)	1	P
3	SS transmits a PDCP Data PDU on UM DRB containing one IP packet without header compression.	<--	PDCP Data PDU (SN = 0)		
4	CHECK: Does UE transmit a PDCP Data PDU with SN=0?	-->	PDCP Data PDU (SN = 0)	2	P
5	SS sends a PDCP Data PDU on UM DRB containing one IP packet without header compression.	<--	PDCP Data PDU (SN = 1)		
6	CHECK: Does UE transmit a PDCP Data PDU with SN=1?	-->	PDCP Data PDU (SN = 1)	1	P

7.3.1.3.3.3 Specific message contents

None

7.3.2 Void

7.3.3 PDCP ciphering and deciphering

7.3.3.1 Ciphering and deciphering / Correct functionality of EPS AS encryption algorithms / SNOW 3G

7.3.3.1.1 Test Purpose (TP)

(1)

```
with { UE in RRC_IDLE/E-UTRA RRC_CONNECTED state }
ensure that {
  when { Functionality of EPS AS encryption algorithms with SNOW 3G is taken into use }
  then { UE performs correct AS ciphering function in PDCP entities associated with SRBs. }
}
```

7.3.3.1.2 Conformance requirements

References: The conformance requirements covered in the present TC are specified in: TS 36.323, clause 5.6, TS 33.401, clause 5.1.3.2 and TS 36.331, clause 6.3.3.

[TS 36.323, clause 5.6]

The ciphering function includes both ciphering and deciphering and is performed in PDCP. For the control plane, the data unit that is ciphered is the data part of the PDCP PDU (see subclause 6.3.3) and the MAC-I (see subclause 6.3.4). For the user plane, the data unit that is ciphered is the data part of the PDCP PDU (see subclause 6.3.3); ciphering is not applicable to PDCP Control PDUs.

The ciphering algorithm and key to be used by the PDCP entity are configured by upper layers [3] and the ciphering method shall be applied as specified in [6].

The ciphering function is activated by upper layers [3]. After security activation, the ciphering function shall be applied to all PDCP PDUs indicated by upper layers [3] for the downlink and the uplink, respectively.

The parameters that are required by PDCP for ciphering are defined in [6] and are input to the ciphering algorithm. The required inputs to the ciphering function include the COUNT value, and DIRECTION (direction of the transmission: set as specified in [6]). The parameters required by PDCP which are provided by upper layers [3] are listed below:

- BEARER (defined as the radio bearer identifier in [6]. It will use the value RB identity –1 as in [3]);
- KEY (the ciphering keys for the control plane and for the user plane are K_{RRCenc} and K_{UPenc} , respectively).

[TS 33.401, clause 5.1.3.2]

All algorithms specified in this subclause are algorithms with a 128-bit input key except Null ciphering algorithm.

NOTE: Deviations from the above requirement have to be indicated explicitly in the algorithm identifier list below.

Each EPS Encryption Algorithm (EEA) will be assigned a 4-bit identifier. Currently, the following values have been defined for NAS, RRC and UP ciphering:

...

"0001₂" 128-EEA1 SNOW 3G based algorithm

...

The remaining values have been reserved for future use.

UEs and eNBs shall implement EEA0, 128-EEA1 and 128-EEA2 for both RRC signalling ciphering and UP ciphering. UEs and eNBs may implement 128-EEA3 for both RRC signalling ciphering and UP ciphering.

[TS 36.331, clause 6.3.3]

The IE *SecurityAlgorithmConfig* is used to configure AS integrity protection algorithm (SRBs) and AS ciphering algorithm (SRBs and DRBs). For RNs, the IE *SecurityAlgorithmConfig* is also used to configure AS integrity protection algorithm for DRBs between the RN and the E-UTRAN.

...

SecurityAlgorithmConfig field descriptions
<i>cipheringAlgorithm</i> Indicates the ciphering algorithm to be used for SRBs and DRBs, as specified in TS 33.401 [32, 5.1.3.2].
<i>integrityProtAlgorithm</i> Indicates the integrity protection algorithm to be used for SRBs, as specified in TS 33.401 [32, 5.1.4.2]. For RNs, also indicates the integrity protection algorithm to be used for integrity protection-enabled DRB(s).

7.3.3.1.3 Test description

7.3.3.1.3.1 Pre-test conditions

System Simulator:

- Cell 1.

UE:

- None.

Preamble:

- The UE shall be in Registered Idle Mode (State 2) according to [18].

7.3.3.1.3.2 Test procedure sequence

Table 7.3.3.1.3.2-1: Main Behaviour

St	Procedure	Message Sequence		TP	Verdict
		U - S	Message		
1	The SS sends a <i>Paging</i> message to the UE on the appropriate paging block, and including the UE identity in one entry of the IE <i>pagingRecordLists</i> .	<--	<i>Paging (PCCH)</i>	-	-
2	Check: Does The UE transmit a <i>RRCCConnectionRequest</i> message without related PDCP Data PDU being ciphered?	-->	<i>RRCCConnectionRequest</i>	1	P
3	The SS transmits an <i>RRCCConnectionSetup</i> message. This message related PDCP Data PDU should not be integrity protected and ciphered.	<--	<i>RRCCConnectionSetup</i>	-	-
4	Check: Does the UE transmit a <i>RRCCConnectionSetupComplete</i> message to confirm the successful completion of the connection establishment and to initiate the session management procedure by including the SERVICE REQUEST message (State3), and without related PDCP Data PDU being ciphered?	-->	<i>RRCCConnectionSetupComplete</i>	1	P
5	The SS transmits a <i>SecurityModeCommand</i> message to activate EPS AS encryption algorithm security. The message related PDCP Data PDU should be integrity protected but not ciphered.	<--	<i>SecurityModeCommand</i>	-	-
6	Check: Does the UE transmit a <i>SecurityModeComplete</i> message and establishes the initial security configuration without the message related PDCP Data PDU being ciphered?	-->	<i>SecurityModeComplete</i>	1	P
7	The SS configures a new data radio bearer, associated with the default EPS bearer context. This message related PDCP Data PDU should be integrity protected and ciphered. The COUNT of this message related PDCP Data PDU can be used for deciphering.	<--	<i>RRCCConnectionReconfiguration</i>	-	-
8	The UE transmits a <i>RRCCConnectionReconfigurationComplete</i> message to confirm the establishment of the new data radio bearer, associated with the default EPS bearer context. This message related PDCP Data PDU should be integrity protected and ciphered. The COUNT of this message related PDCP Data PDU can be used for deciphering.	-->	<i>RRCCConnectionReconfigurationComplete</i>	1	P

7.3.3.1.3.3 Specific message contents

Table 7.3.3.1.3.3-1 SecurityModeCommand (step 6, Table 7.3.3.1.3.2-1)

Derivation Path: TS36.508 clause 4.6.1 table 4.6.1-19			
Information Element	Value/remark	Comment	Condition
SecurityModeCommand ::= SEQUENCE {			
rrc-TransactionIdentifier	RRC-TransactionIdentifier-DL		
criticalExtensions CHOICE {			
c1 CHOICE {			
securityModeCommand-r8 SEQUENCE {			
securityConfigSMC SEQUENCE {			
securityAlgorithmConfig SEQUENCE {			
cipheringAlgorithm	eea1		
integrityProtAlgorithm	Default value specified in TS 36.508		
}			
nonCriticalExtension SEQUENCE {}	Not present		
}			
}			
}			
}			

7.3.3.2 Ciphering and deciphering / Correct functionality of EPS UP encryption algorithms / SNOW 3G

7.3.3.2.1 Test Purpose (TP)

(1)

```

with { UE in E-UTRA RRC_CONNECTED state }
ensure that {
  when { UE is requested to achieve functionality of EPS UP encryption algorithms with SNOW 3G }
  then { UE performs correct UP ciphering function in PDCP entities associated with DRBs. }
}

```

7.3.3.2.2 Conformance requirements

References: The conformance requirements covered in the present TC are specified in: TS 36.323, clause 5.6, TS 33.401, clause 5.1.3.2 and TS 36.331, clause 6.3.3.

[TS 36.323, clause 5.6]

The ciphering function includes both ciphering and deciphering and is performed in PDCP. For the control plane, the data unit that is ciphered is the data part of the PDCP PDU (see subclause 6.3.3) and the MAC-I (see subclause 6.3.4). For the user plane, the data unit that is ciphered is the data part of the PDCP PDU (see subclause 6.3.3); ciphering is not applicable to PDCP Control PDUs.

The ciphering algorithm and key to be used by the PDCP entity are configured by upper layers [3] and the ciphering method shall be applied as specified in [6].

The ciphering function is activated by upper layers [3]. After security activation, the ciphering function shall be applied to all PDCP PDUs indicated by upper layers [3] for the downlink and the uplink, respectively.

The parameters that are required by PDCP for ciphering are defined in [6] and are input to the ciphering algorithm. The required inputs to the ciphering function include the COUNT value, and DIRECTION (direction of the transmission: 0 for uplink, 1 for downlink). The parameters required by PDCP which are provided by upper layers [3] are listed below:

- BEARER (defined as the radio bearer identifier in [6]. It will use the value RB identity –1 as in [3]);
- KEY (the ciphering keys for the control plane and for the user plane are K_{RRCenc} and K_{UPenc} , respectively).

[TS 33.401, clause 5.1.3.2]

All algorithms specified in this subclause are algorithms with a 128-bit input key except Null ciphering algorithm.

NOTE: Deviations from the above requirement have to be indicated explicitly in the algorithm identifier list below.

Each EPS Encryption Algorithm (EEA) will be assigned a 4-bit identifier. Currently, the following values have been defined for NAS, RRC and UP ciphering:

...
 "0001₂" 128-EEA1 SNOW 3G based algorithm
 ...

The remaining values have been reserved for future use.

UEs and eNBs shall implement EEA0, 128-EEA1 and 128-EEA2 for both RRC signalling ciphering and UP ciphering. UEs and eNBs may implement 128-EEA3 for both RRC signalling ciphering and UP ciphering.

[TS 36.331, clause 6.3.3]

The IE *SecurityAlgorithmConfig* is used to configure AS integrity protection algorithm (SRBs) and AS ciphering algorithm (SRBs and DRBs). For RNs, the IE *SecurityAlgorithmConfig* is also used to configure AS integrity protection algorithm for DRBs between the RN and the E-UTRAN.

...

SecurityAlgorithmConfig field descriptions	
<i>cipheringAlgorithm</i>	Indicates the ciphering algorithm to be used for SRBs and DRBs, as specified in TS 33.401 [32, 5.1.3.2].
<i>integrityProtAlgorithm</i>	Indicates the integrity protection algorithm to be used for SRBs, as specified in TS 33.401 [32, 5.1.4.2]. For RNs, also indicates the integrity protection algorithm to be used for integrity protection-enabled DRB(s).

7.3.3.2.3 Test description

7.3.3.2.3.1 Pre-test conditions

System Simulator:

- Cell 1.

UE:

- None.

Preamble

- The UE shall be in Loopback Activation state (State 4) according to TS36.508.

7.3.3.2.3.2 Test procedure sequence

Table 7.3.3.2.3-1: Main Behaviour

St	Procedure	Message Sequence		TP	Verdict
		U - S	Message		
1	SS Transmits PDCP PDU on DRB ciphered.	<--	PDCP PDU	-	-
2	Check: Does the UE transmit loop backed PDCP PDU ciphered.	-->	PDCP PDU	1	P

7.3.3.2.3.3 Specific message contents

Table 7.3.3.2.3.3-1 SecurityModeCommand (in the preamble)

Derivation Path: TS36.508 clause 4.6.1 table 4.6.1-19			
Information Element	Value/remark	Comment	Condition
SecurityModeCommand ::= SEQUENCE {			
criticalExtensions CHOICE {			
c1 CHOICE{			
rrc-TransactionIdentifier	RRC-TransactionIdentifier-DL		
securityModeCommand-r8 SEQUENCE {			
securityConfigSMC SEQUENCE {			
cipheringAlgorithm	eea1		
}			
nonCriticalExtension SEQUENCE {}	Not present		
}			
}			
}			
}			

7.3.3.3 Ciphering and deciphering / Correct functionality of EPS AS encryption algorithms / AES

7.3.3.3.1 Test Purpose (TP)

(1)

```
with { UE in E-UTRA RRC_CONNECTED state }
ensure that {
  when { UE is requested to achieve functionality of EPS AS encryption algorithms with AES }
  then { UE performs correct AS ciphering function in PDCP entities associated with SRBs. }
}
```

7.3.3.3.2 Conformance requirements

References: The conformance requirements covered in the present TC are specified in: TS 36.323, clause 5.6, TS 33.401, clause 5.1.3.2 and TS 36.331, clause 6.3.3.

[TS 36.323, clause 5.6]

The ciphering function includes both ciphering and deciphering and is performed in PDCP. For the control plane, the data unit that is ciphered is the data part of the PDCP PDU (see subclause 6.3.3) and the MAC-I (see subclause 6.3.4). For the user plane, the data unit that is ciphered is the data part of the PDCP PDU (see subclause 6.3.3); ciphering is not applicable to PDCP Control PDUs.

The ciphering algorithm and key to be used by the PDCP entity are configured by upper layers [3] and the ciphering method shall be applied as specified in [6].

The ciphering function is activated by upper layers [3]. After security activation, the ciphering function shall be applied to all PDCP PDUs indicated by upper layers [3] for the downlink and the uplink, respectively.

The parameters that are required by PDCP for ciphering are defined in [6] and are input to the ciphering algorithm. The required inputs to the ciphering function include the COUNT value, and DIRECTION (direction of the transmission: set as specified in [6]). The parameters required by PDCP which are provided by upper layers [3] are listed below:

- BEARER (defined as the radio bearer identifier in [6]. It will use the value RB identity –1 as in [3]);
- KEY (the ciphering keys for the control plane and for the user plane are K_{RRCEnc} and K_{UPenc} , respectively).

[TS 33.401, clause 5.1.3.2]

All algorithms specified in this subclause are algorithms with a 128-bit input key except Null ciphering algorithm.

NOTE: Deviations from the above requirement have to be indicated explicitly in the algorithm identifier list below.

Each EPS Encryption Algorithm (EEA) will be assigned a 4-bit identifier. Currently, the following values have been defined for NAS, RRC and UP ciphering:

...
 "0010₂" 128-EEA2 AES based algorithm
 ...

The remaining values have been reserved for future use.

UEs and eNBs shall implement EEA0, 128-EEA1 and 128-EEA2 for both RRC signalling ciphering and UP ciphering. UEs and eNBs may implement 128-EEA3 for both RRC signalling ciphering and UP ciphering.

[TS 36.331, clause 6.3.3]

The IE *SecurityAlgorithmConfig* is used to configure AS integrity protection algorithm (SRBs) and AS ciphering algorithm (SRBs and DRBs). For RNs, the IE *SecurityAlgorithmConfig* is also used to configure AS integrity protection algorithm for DRBs between the RN and the E-UTRAN.

...

SecurityAlgorithmConfig field descriptions	
<i>cipheringAlgorithm</i>	Indicates the ciphering algorithm to be used for SRBs and DRBs, as specified in TS 33.401 [32, 5.1.3.2].
<i>integrityProtAlgorithm</i>	Indicates the integrity protection algorithm to be used for SRBs, as specified in TS 33.401 [32, 5.1.4.2]. For RNs, also indicates the integrity protection algorithm to be used for integrity protection-enabled DRB(s).

7.3.3.3.3 Test description

7.3.3.3.3.1 Pre-test conditions

Same Pre-test conditions as in clause 7.3.3.1.3.1.

7.3.3.3.3.2 Test procedure sequence

Same Test procedure sequence as in Table 7.3.3.1.3.2.

7.3.3.3.3.3 Specific message contents

Table 7.3.3.3.3-1 SecurityModeCommand (step 6)

Derivation Path: TS36.508 clause 4.6.1 table 4.6.1-19			
Information Element	Value/remark	Comment	Condition
SecurityModeCommand ::= SEQUENCE {			
rrc-TransactionIdentifier	RRC-TransactionIdentifier-DL		
criticalExtensions CHOICE {			
c1 CHOICE{			
securityModeCommand-r8 SEQUENCE {			
securityConfigSMC SEQUENCE {			
securityAlgorithmConfig SEQUENCE {			
cipheringAlgorithm	eea2		
}			
nonCriticalExtension SEQUENCE {}	Not present		
}			
}			
}			

7.3.3.4 Ciphering and deciphering / Correct functionality of EPS UP encryption algorithms / AES

7.3.3.4.1 Test Purpose (TP)

(1)

```
with { UE in E-UTRA RRC_CONNECTED state }
ensure that {
  when { UE is requested to achieve functionality of EPS UP encryption algorithms with AES }
  then { UE performs correct UP ciphering function in PDCP entities associated with DRBs. }
}
```

7.3.3.4.2 Conformance requirements

References: The conformance requirements covered in the present TC are specified in: TS 36.323, clause 5.6, TS 33.401, clause 5.1.3.2 and TS 36.331, clause 6.3.3.

[TS 36.323, clause 5.6]

The ciphering function includes both ciphering and deciphering and is performed in PDCP. For the control plane, the data unit that is ciphered is the data part of the PDCP PDU (see subclause 6.3.3) and the MAC-I (see subclause 6.3.4). For the user plane, the data unit that is ciphered is the data part of the PDCP PDU (see subclause 6.3.3); ciphering is not applicable to PDCP Control PDUs.

The ciphering algorithm and key to be used by the PDCP entity are configured by upper layers [3] and the ciphering method shall be applied as specified in [6].

The ciphering function is activated by upper layers [3]. After security activation, the ciphering function shall be applied to all PDCP PDUs indicated by upper layers [3] for the downlink and the uplink, respectively.

The parameters that are required by PDCP for ciphering are defined in [6] and are input to the ciphering algorithm. The required inputs to the ciphering function include the COUNT value, and DIRECTION (direction of the transmission: set as specified in [6]). The parameters required by PDCP which are provided by upper layers [3] are listed below:

- BEARER (defined as the radio bearer identifier in [6]. It will use the value RB identity -1 as in [3]);
- KEY (the ciphering keys for the control plane and for the user plane are K_{RRCenc} and K_{UPenc} , respectively).

[TS 33.401, clause 5.1.3.2]

All algorithms specified in this subclause are algorithms with a 128-bit input key except Null ciphering algorithm.

NOTE: Deviations from the above requirement have to be indicated explicitly in the algorithm identifier list below.

Each EPS Encryption Algorithm (EEA) will be assigned a 4-bit identifier. Currently, the following values have been defined for NAS, RRC and UP ciphering:

...

"0010₂" 128-EEA2 AES based algorithm

...

The remaining values have been reserved for future use.

UEs and eNBs shall implement EEA0, 128-EEA1 and 128-EEA2 for both RRC signalling ciphering and UP ciphering. UEs and eNBs may implement 128-EEA3 for both RRC signalling ciphering and UP ciphering.

[TS 36.331, clause 6.3.3]

The IE *SecurityAlgorithmConfig* is used to configure AS integrity protection algorithm (SRBs) and AS ciphering algorithm (SRBs and DRBs). For RNs, the IE *SecurityAlgorithmConfig* is also used to configure AS integrity protection algorithm for DRBs between the RN and the E-UTRAN.

...

SecurityAlgorithmConfig field descriptions
<p><i>cipheringAlgorithm</i> Indicates the ciphering algorithm to be used for SRBs and DRBs, as specified in TS 33.401 [32, 5.1.3.2].</p>
<p><i>integrityProtAlgorithm</i> Indicates the integrity protection algorithm to be used for SRBs, as specified in TS 33.401 [32, 5.1.4.2]. For RNs, also indicates the integrity protection algorithm to be used for integrity protection-enabled DRB(s).</p>

7.3.3.4.3 Test description

7.3.3.4.3.1 Pre-test conditions

Same Pre-test conditions as in clause 7.3.3.2.3.1.

7.3.3.4.3.2 Test procedure sequence

Same Test procedure sequence as in Table 7.3.3.2.3.2.

7.3.3.4.3.3 Specific message contents

Table 7.3.3.4.3.3-1 SecurityModeCommand (in the preamble)

Derivation Path: TS36.508 clause 4.6.1 table 4.6.1-19			
Information Element	Value/remark	Comment	Condition
rrc-TransactionIdentifier	RRC-TransactionIdentifier-DL		
SecurityModeCommand ::= SEQUENCE {			
criticalExtensions CHOICE {			
c1 CHOICE{			
securityConfigSMC SEQUENCE {			
securityModeCommand-r8 SEQUENCE {			
securityAlgorithmConfig SEQUENCE {			
cipheringAlgorithm	eea2		
	Not present		
}			
nonCriticalExtension SEQUENCE {}	Not present		
}			
}			

7.3.3.5 Ciphering and deciphering / Correct functionality of EPS AS encryption algorithms / ZUC

7.3.3.5.1 Test Purpose (TP)

(1)

```
with { UE in E-UTRA RRC_CONNECTED state }
ensure that {
  when { UE is requested to achieve functionality of EPS AS encryption algorithms with ZUC }
  then { UE performs correct AS ciphering function in PDCP entities associated with SRBs. }
}
```

7.3.3.5.2 Conformance requirements

References: The conformance requirements covered in the present TC are specified in: TS 36.323, clause 5.6, TS 33.401, clause 5.1.3.2 and TS 36.331, clause 6.3.3.

[TS 36.323, clause 5.6]

The ciphering function includes both ciphering and deciphering and is performed in PDCP. For the control plane, the data unit that is ciphered is the data part of the PDCP PDU (see subclause 6.3.3) and the MAC-I (see subclause 6.3.4). For the user plane, the data unit that is ciphered is the data part of the PDCP PDU (see subclause 6.3.3); ciphering is not applicable to PDCP Control PDUs.

The ciphering algorithm and key to be used by the PDCP entity are configured by upper layers [3] and the ciphering method shall be applied as specified in [6].

The ciphering function is activated by upper layers [3]. After security activation, the ciphering function shall be applied to all PDCP PDUs indicated by upper layers [3] for the downlink and the uplink, respectively.

The parameters that are required by PDCP for ciphering are defined in [6] and are input to the ciphering algorithm. The required inputs to the ciphering function include the COUNT value, and DIRECTION (direction of the transmission: set as specified in [6]). The parameters required by PDCP which are provided by upper layers [3] are listed below:

- BEARER (defined as the radio bearer identifier in [6]. It will use the value RB identity –1 as in [3]);
- KEY (the ciphering keys for the control plane and for the user plane are $K_{RRCCenc}$ and K_{UPenc} , respectively).

[TS 33.401, clause 5.1.3.2]

All algorithms specified in this subclause are algorithms with a 128-bit input key except Null ciphering algorithm.

NOTE: Deviations from the above requirement have to be indicated explicitly in the algorithm identifier list below.

Each EPS Encryption Algorithm (EEA) will be assigned a 4-bit identifier. Currently, the following values have been defined for NAS, RRC and UP ciphering:

...

"0011₂" 128-EEA3 ZUC based algorithm

The remaining values have been reserved for future use.

UEs and eNBs shall implement EEA0, 128-EEA1 and 128-EEA2 for both RRC signalling ciphering and UP ciphering. UEs and eNBs may implement 128-EEA3 for both RRC signalling ciphering and UP ciphering.

[TS 36.331, clause 6.3.3]

The IE *SecurityAlgorithmConfig* is used to configure AS integrity protection algorithm (SRBs) and AS ciphering algorithm (SRBs and DRBs). For RNs, the IE *SecurityAlgorithmConfig* is also used to configure AS integrity protection algorithm for DRBs between the RN and the E-UTRAN.

...

SecurityAlgorithmConfig field descriptions	
<i>cipheringAlgorithm</i>	Indicates the ciphering algorithm to be used for SRBs and DRBs, as specified in TS 33.401 [32, 5.1.3.2].
<i>integrityProtAlgorithm</i>	Indicates the integrity protection algorithm to be used for SRBs, as specified in TS 33.401 [32, 5.1.4.2]. For RNs, also indicates the integrity protection algorithm to be used for integrity protection-enabled DRB(s).

7.3.3.5.3 Test description

7.3.3.5.3.1 Pre-test conditions

Same Pre-test conditions as in clause 7.3.3.1.3.1.

7.3.3.5.3.2 Test procedure sequence

Same Test procedure sequence as in Table 7.3.3.1.3.2.

7.3.3.5.3.3 Specific message contents

Table 7.3.3.5.3.3-1: SecurityModeCommand (step 6)

Derivation Path: TS36.508 clause 4.6.1 table 4.6.1-19			
Information Element	Value/remark	Comment	Condition
SecurityModeCommand ::= SEQUENCE {			
rrc-TransactionIdentifier	RRC-TransactionIdentifier-DL		
criticalExtensions CHOICE {			
c1 CHOICE {			
securityModeCommand-r8 SEQUENCE {			
securityConfigSMC SEQUENCE {			
securityAlgorithmConfig SEQUENCE {			
cipheringAlgorithm	eea3-v11xy		
}			
nonCriticalExtension SEQUENCE {}	Not present		
}			
}			
}			
}			

7.3.3.6 Ciphering and deciphering / Correct functionality of EPS UP encryption algorithms / ZUC

7.3.3.6.1 Test Purpose (TP)

(1)

```

with { UE in E-UTRA RRC_CONNECTED state }
ensure that {
  when { UE is requested to achieve functionality of EPS UP encryption algorithms with ZUC }
  then { UE performs correct UP ciphering function in PDCP entities associated with DRBs. }
}

```

7.3.3.6.2 Conformance requirements

References: The conformance requirements covered in the present TC are specified in: TS 36.323, clause 5.6, TS 33.401, clause 5.1.3.2 and TS 36.331, clause 6.3.3.

[TS 36.323, clause 5.6]

The ciphering function includes both ciphering and deciphering and is performed in PDCP. For the control plane, the data unit that is ciphered is the data part of the PDCP PDU (see subclause 6.3.3) and the MAC-I (see subclause 6.3.4). For the user plane, the data unit that is ciphered is the data part of the PDCP PDU (see subclause 6.3.3); ciphering is not applicable to PDCP Control PDUs.

The ciphering algorithm and key to be used by the PDCP entity are configured by upper layers [3] and the ciphering method shall be applied as specified in [6].

The ciphering function is activated by upper layers [3]. After security activation, the ciphering function shall be applied to all PDCP PDUs indicated by upper layers [3] for the downlink and the uplink, respectively.

The parameters that are required by PDCP for ciphering are defined in [6] and are input to the ciphering algorithm. The required inputs to the ciphering function include the COUNT value, and DIRECTION (direction of the transmission: 0 for uplink, 1 for downlink). The parameters required by PDCP which are provided by upper layers [3] are listed below:

- BEARER (defined as the radio bearer identifier in [6]. It will use the value RB identity –1 as in [3]);
- KEY (the ciphering keys for the control plane and for the user plane are K_{RRCenc} and K_{UPenc} , respectively)

[TS 33.401, clause 5.1.3.2]

All algorithms specified in this subclause are algorithms with a 128-bit input key except Null ciphering algorithm.

NOTE: Deviations from the above requirement have to be indicated explicitly in the algorithm identifier list below.

Each EPS Encryption Algorithm (EEA) will be assigned a 4-bit identifier. Currently, the following values have been defined for NAS, RRC and UP ciphering:

...

"0011₂" 128-EEA3 ZUC based algorithm

The remaining values have been reserved for future use.

UEs and eNBs shall implement EEA0, 128-EEA1 and 128-EEA2 for both RRC signalling ciphering and UP ciphering. UEs and eNBs may implement 128-EEA3 for both RRC signalling ciphering and UP ciphering.

UEs and MMEs shall implement EEA0, 128-EEA1 and 128-EEA2 for NAS signalling ciphering. UEs and MMEs may implement 128-EEA3 for NAS signalling ciphering.

[TS 36.331, clause 6.3.3]

The IE *SecurityAlgorithmConfig* is used to configure AS integrity protection algorithm (SRBs) and AS ciphering algorithm (SRBs and DRBs). For RNs, the IE *SecurityAlgorithmConfig* is also used to configure AS integrity protection algorithm for DRBs between the RN and the E-UTRAN.

...

SecurityAlgorithmConfig field descriptions
<i>cipheringAlgorithm</i> Indicates the ciphering algorithm to be used for SRBs and DRBs, as specified in TS 33.401 [32, 5.1.3.2].
<i>integrityProtAlgorithm</i> Indicates the integrity protection algorithm to be used for SRBs, as specified in TS 33.401 [32, 5.1.4.2]. For RNs, also indicates the integrity protection algorithm to be used for integrity protection-enabled DRB(s).

7.3.3.6.3 Test description

7.3.3.6.3.1 Pre-test conditions

Same Pre-test conditions as in clause 7.3.3.2.3.1.

7.3.3.6.3.2 Test procedure sequences

Same Test procedure sequence as in Table 7.3.3.2.3.2.

7.3.3.6.3.3 Specific message contents

Table 7.3.3.6.3.3-1: SecurityModeCommand (in the preamble)

Derivation Path: TS36.508 clause 4.6.1 table 4.6.1-19			
Information Element	Value/remark	Comment	Condition
SecurityModeCommand ::= SEQUENCE {			
criticalExtensions CHOICE {			
c1 CHOICE{			
rrc-TransactionIdentifier	RRC-TransactionIdentifier-DL		
securityModeCommand-r8 SEQUENCE {			
securityConfigSMC SEQUENCE {			
CipheringAlgorithm	eea3-v11xy		
}			
nonCriticalExtension SEQUENCE {}	Not present		
}			
}			
}			

7.3.4 PDCP integrity protection

7.3.4.1 Integrity protection / Correct functionality of EPS AS integrity algorithms / SNOW3G

7.3.4.1.1 Test Purpose (TP)

(1)

```
with { UE in RRC_IDLE/E-UTRA RRC_CONNECTED state }
ensure that {
  when { Functionality of EPS AS integrity algorithms with SNOW3G is taken into use }
  then { UE performs the integrity protection function in PDCP entities associated with SRBs. }
}
```

(2)

```
with { UE in E-UTRA RRC_CONNECTED state }
ensure that {
  when { SecurityModeCommand fails the integrity protection check }
  then { UE transmits SecurityModeFailure message and continues using the configuration used
prior to the reception of the SecurityModeCommand message }
}
```

(3)

```
with { UE in E-UTRA RRC_CONNECTED state }
ensure that {
  when { UE has AS security activated and integrity check fails }
  then { UE initiates RRC connection re-establishment procedure }
}
```

7.3.4.1.2 Conformance requirements

References: The conformance requirements covered in the present TC are specified in: 3GPP TS 36.323 clauses 5.7, clause 5.1.2.2, TS 33.401 clause 5.1.4.2 and TS 36.331 clause 6.3.3.

[TS 36.323, clause 5.7]

The integrity protection function includes both integrity protection and integrity verification and is performed in PDCP for PDCP entities associated with SRBs. The data unit that is integrity protected is the PDU header and the data part of the PDU before ciphering.

The integrity protection algorithm and key to be used by the PDCP entities are configured by upper layers [3] and the integrity protection method shall be applied as specified in [6].

The integrity protection function is activated by upper layers [3]. After security activation, the integrity protection function shall be applied to all PDUs including and subsequent to the PDU indicated by upper layers [3] for the downlink and the uplink, respectively.

NOTE: As the RRC message which activates the integrity protection function is itself integrity protected with the configuration included in this RRC message, this message needs first be decoded by RRC before the integrity protection verification could be performed for the PDU in which the message was received.

The parameters that are required by PDCP for integrity protection are defined in [6] and are input to the integrity protection algorithm. The required inputs to the integrity protection function include the COUNT value, and DIRECTION (direction of the transmission: set as specification in [6]). The parameters required by PDCP which are provided by upper layers [3] are listed below:

- BEARER (defined as the radio bearer identifier in [6]. It will use the value RB identity –1 as in [3]);
- KEY (K_{RRCint}).

At transmission, the UE computes the value of the MAC-I field and at reception it verifies the integrity of the PDCP PDU by calculating the X-MAC based on the input parameters as specified above. If the calculated X-MAC corresponds to the received MAC-I, integrity protection is verified successfully.

[TS 36.323, clause 5.1.2.2]

- if integrity verification is not applicable:
 - if received PDCP SN < Next_PDCP_RX_SN:
 - increment RX_HFN by one;
 - set Next_PDCP_RX_SN to the received PDCP SN + 1;
 - if Next_PDCP_RX_SN > Maximum_PDCP_SN:
 - set Next_PDCP_RX_SN to 0;
 - increment RX_HFN by one;
 - deliver the resulting PDCP SDU to upper layer;
- else, if integrity verification is applicable and the integrity verification fails:
 - discard the received PDCP Data PDU;
- indicate the integrity verification failure to upper layer.

[TS 33.401, clause 5.1.4.2]

All algorithms specified in this subclause are algorithms with a 128-bit input key.

NOTE: Deviations from the above requirement have to be indicated explicitly in the algorithm identifier list below.

Each EPS Integrity Algorithm (EIA) will be assigned a 4-bit identifier. Currently, the following values have been defined:

...

"0001₂" 128-EIA1 SNOW 3G

...

The remaining values have been reserved for future use.

UEs and eNBs shall implement 128-EIA1 and 128-EIA2 for RRC signalling integrity protection. UEs and eNBs may implement 128-EIA3 for RRC signalling integrity protection.

...

UEs shall implement EIA0 for integrity protection of NAS and RRC signalling. As specified in clause 5.1.4.1 of this specification, EIA0 is only allowed for unauthenticated emergency calls. EIA0 shall not be used for integrity protection between RN and DeNB.

Implementation of EIA0 in MMEs and eNBs is optional, EIA0, if implemented, shall be disabled in MMEs and eNBs in the deployments where support of unauthenticated emergency calling is not a regulatory requirement.

[TS 36.331, clause 6.3.3]

The IE *SecurityAlgorithmConfig* is used to configure AS integrity protection algorithm (SRBs) and AS ciphering algorithm (SRBs and DRBs). For RNs, the IE *SecurityAlgorithmConfig* is also used to configure AS integrity protection algorithm for DRBs between the RN and the E-UTRAN.

...

SecurityAlgorithmConfig field descriptions
<i>cipheringAlgorithm</i> Indicates the ciphering algorithm to be used for SRBs and DRBs, as specified in TS 33.401 [32, 5.1.3.2].
<i>integrityProtAlgorithm</i> Indicates the integrity protection algorithm to be used for SRBs, as specified in TS 33.401 [32, 5.1.4.2]. For RNs, also indicates the integrity protection algorithm to be used for integrity protection-enabled DRB(s).

7.3.4.1.3 Test description

7.3.4.1.3.1 Pre-test conditions

System Simulator:

- Cell 1

UE:

None.

Preamble:

- The UE is in state Registered, Idle Mode (State 2) according to [18].

7.3.4.1.3.2 Test procedure sequence

Table 7.3.4.1.3.2-1: Main behaviour

St	Procedure	Message Sequence		TP	Verdict
		U - S	Message		
1	The SS sends a Paging message to the UE on the appropriate paging block, and including the UE identity in one entry of the IE <i>pagingRecordLists</i> .	-	<i>Paging (PCCH)</i>	-	-
2	The UE transmit a <i>RRCCONNECTIONREQUEST</i> message .	-->	<i>RRCCONNECTIONREQUEST</i>	-	-
3	The SS transmits an <i>RRCCONNECTIONSETUP</i> message.	<--	<i>RRCCONNECTIONSETUP</i>	-	-
4	Does: The UE transmit a <i>RRCCONNECTIONSETUPCOMPLETE</i> message to confirm the successful completion of the connection establishment and to initiate the session management procedure by including the SERVICE REQUEST message without related PDCP Data PDU being integrity protected?	-->	<i>RRCCONNECTIONSETUPCOMPLETE</i>	1	P
5	The SS transmits a <i>SECURITYMODECOMMAND</i> message to activate AS security with SNOW3G integrity algorithms protected.	<--	<i>SECURITYMODECOMMAND</i>	-	-
6	Check: Does the UE transmit a <i>SECURITYMODECOMPLETE</i> message with SNOW3G integrity algorithms and RRC integrity key protected and establish the initial security configuration.	-->	<i>SECURITYMODECOMPLETE</i>	1	P
7	Check: Does the <i>SECURITYMODECOMPLETE</i> message from the UE pass the SS' integrity protection check.	-	-	1	P
8	The SS transmits an <i>RRCCONNECTIONRELEASE</i> message.	<--	<i>RRCCONNECTIONRELEASE</i>	-	-
9	Wait for 5 s for the UE to enter E-UTRA RRC_IDLE state.			-	-
10	The SS transmits a <i>Paging</i> message including a matched identity.	<--	<i>Paging</i>	-	-
11	The UE transmit an <i>RRCCONNECTIONREQUEST</i> message.	-->	<i>RRCCONNECTIONREQUEST</i>	-	-
12	The SS transmits an <i>RRCCONNECTIONSETUP</i> message.	<--	<i>RRCCONNECTIONSETUP</i>	-	-
13	The UE transmits an <i>RRCCONNECTIONSETUPCOMPLETE</i> message. This message includes a SERVICE REQUEST message.	-->	<i>RRCCONNECTIONSETUPCOMPLETE</i>	-	-
14	The SS transmits a <i>SECURITYMODECOMMAND</i> message. MAC-I is calculated in such way, it will result in integrity check failure on UE side.	<--	<i>SECURITYMODECOMMAND</i>	-	-
15	Check: Does the UE transmit a <i>SECURITYMODEFAILURE</i> message without integrity protection nor ciphering?	-->	<i>SECURITYMODEFAILURE</i>	2	P
16	The SS transmits a <i>SECURITYMODECOMMAND</i> message to activate AS security with SNOW3G integrity algorithms protected.	<--	<i>SECURITYMODECOMMAND</i>	-	-
17	The UE transmits a <i>SECURITYMODECOMPLETE</i> message. The message related PDCP Data PDU should be integrity protected but not ciphered.	-->	<i>SECURITYMODECOMPLETE</i>	-	-
18	The SS transmits an <i>UECAPABILITYENQUIRY</i> message to initiate the UE radio access capability transfer procedure. MAC-I is calculated in such way, it will result in integrity check failure on UE side.	<--	<i>UECAPABILITYENQUIRY</i>	-	-
19	Check: Does the UE retransmit a <i>RRCCONNECTIONREESTABLISHMENTREQUEST</i> message on Cell 1?	-->	<i>RRCCONNECTIONREESTABLISHMENTREQUEST</i>	3	P

20	The SS transmits a <i>RRCCoNNECTIONReestablishment</i> message	<--	<i>RRCCoNNECTIONReestablishment</i>	-	-
21	The UE transmits <i>RRCCoNNECTIONReestablishmentComplete</i> message.	-->	<i>RRCCoNNECTIONReestablishmentComplete</i>	-	-
21 A	The SS transmits an <i>RRCCoNNECTIONReconfiguration</i> message.	<--	<i>RRCCoNNECTIONReconfiguration</i>	-	-
21 B	The UE transmits an <i>RRCCoNNECTIONReconfigurationComplete</i> message.	-->	<i>RRCCoNNECTIONReconfigurationComplete</i>	-	-
22	Check: Does the test result of generic test procedure in TS 36.508 subclause 6.4.2.3 indicate that the UE is in E-UTRA RRC_CONNECTED state on Cell 1?	-	-	-	-

7.3.4.1.3.3 Specific message contents

Table 7.3.4.1.3.3-1: *SecurityModeCommand* message (steps 5, 14 and 16, Table 7.3.4.1.3.2-1)

Derivation Path: 36.508 Table 4.6.1-19			
Information Element	Value/remark	Comment	Condition
<i>SecurityModeCommand</i> ::= SEQUENCE {			
<i>rrc-TransactionIdentifier</i>	RRC-TransactionIdentifier-DL		
criticalExtensions CHOICE {			
c1 CHOICE {			
<i>securityModeCommand-r8</i> SEQUENCE {			
<i>securityConfigSMC</i> SEQUENCE {			
<i>securityAlgorithmConfig</i> SEQUENCE {			
<i>integrityProtAlgorithm</i>	eia1	128-EIA1 SNOW 3G	
}			
}			
}			
}			
}			
}			

Table 7.3.4.1.3.3-2: *RRCCoNNECTIONReestablishmentRequest* (step 19, Table 7.3.4.1.3.2-1)

Derivation Path: 36.508, Table 4.6.1-13			
Information Element	Value/remark	Comment	Condition
<i>RRCCoNNECTIONReestablishmentRequest</i> ::= SEQUENCE {			
criticalExtensions CHOICE {			
<i>rrcCoNNECTIONReestablishmentRequest-r8</i> SEQUENCE {			
<i>ue-Identity</i> SEQUENCE {			
c-RNTI	the value of the C-RNTI of the UE		
physCellId	PhysicalCellIdentity of Cell 1		
shortMAC-I	The same value as the 16 least significant bits of the XMAC-I value calculated by SS		
}			
<i>reestablishmentCause</i>	otherFailure		
}			
}			

Table 7.3.4.1.3.3-3: RRCConnectionReconfiguration (step 21A, Table 7.3.4.1.3.2-1)

Derivation Path: 36.508 table 4.6.1-8, condition SRB2-DRB(1, 0)

7.3.4.2 Integrity protection / Correct functionality of EPS AS integrity algorithms / AES

7.3.4.2.1 Test Purpose (TP)

(1)

```
with { UE in RRC_IDLE/E-UTRA RRC_CONNECTED state }
ensure that {
  when { Functionality of EPS AS integrity algorithms with AES is taken into use }
  then { UE performs the integrity protection function in PDCP entities associated with SRBs. }
}
```

(2)

```
with { UE in E-UTRA RRC_CONNECTED state }
ensure that {
  when { SecurityModeCommand fails the integrity protection check }
  then { UE transmits SecurityModeFailure message and continues using the configuration used
prior to the reception of the SecurityModeCommand message }
}
```

(3)

```
with { UE in E-UTRA RRC_CONNECTED state }
ensure that {
  when { UE has AS security activated and integrity check fails }
  then { UE initiates RRC connection re-establishment procedure }
}
```

7.3.4.2.2 Conformance requirements

References: The conformance requirements covered in the present TC are specified in: 3GPP TS 36.323 clauses 5.7, clause 5.1.2.2, TS 33.401 clause 5.1.4.2 and TS 36.331 clause 6.3.3.

[TS 36.323, clause 5.7]

The integrity protection function includes both integrity protection and integrity verification and is performed in PDCP for PDCP entities associated with SRBs. The data unit that is integrity protected is the PDU header and the data part of the PDU before ciphering.

The integrity protection algorithm and key to be used by the PDCP entities are configured by upper layers [3] and the integrity protection method shall be applied as specified in [6].

The integrity protection function is activated by upper layers [3]. After security activation, the integrity protection function shall be applied to all PDUs including and subsequent to the PDU indicated by upper layers [3] for the downlink and the uplink, respectively.

NOTE: As the RRC message which activates the integrity protection function is itself integrity protected with the configuration included in this RRC message, this message needs first be decoded by RRC before the integrity protection verification could be performed for the PDU in which the message was received.

The parameters that are required by PDCP for integrity protection are defined in [6] and are input to the integrity protection algorithm. The required inputs to the integrity protection function include the COUNT value, and DIRECTION (direction of the transmission: set as specification in [6]). The parameters required by PDCP which are provided by upper layers [3] are listed below:

- BEARER (defined as the radio bearer identifier in [6]. It will use the value RB identity –1 as in [3]);
- KEY (K_{RRCint}).

At transmission, the UE computes the value of the MAC-I field and at reception it verifies the integrity of the PDCP PDU by calculating the X-MAC based on the input parameters as specified above. If the calculated X-MAC corresponds to the received MAC-I, integrity protection is verified successfully.

[TS 36.323, clause 5.1.2.2]

- if integrity verification is not applicable:
 - if received PDCP SN < Next_PDCP_RX_SN:
 - increment RX_HFN by one;
 - set Next_PDCP_RX_SN to the received PDCP SN + 1;
 - if Next_PDCP_RX_SN > Maximum_PDCP_SN:
 - set Next_PDCP_RX_SN to 0;
 - increment RX_HFN by one;
 - deliver the resulting PDCP SDU to upper layer;
- else, if integrity verification is applicable and the integrity verification fails:
 - discard the received PDCP Data PDU;
- indicate the integrity verification failure to upper layer.

[TS 33.401, clause 5.1.4.2]

All algorithms specified in this subclause are algorithms with a 128-bit input key.

NOTE: Deviations from the above requirement have to be indicated explicitly in the algorithm identifier list below.

Each EPS Integrity Algorithm (EIA) will be assigned a 4-bit identifier. Currently, the following values have been defined:

...

"0010₂" 128-EIA2 AES

...

The remaining values have been reserved for future use.

UEs and eNBs shall implement 128-EIA1 and 128-EIA2 for RRC signalling integrity protection. UEs and eNBs may implement 128-EIA3 for RRC signalling integrity protection.

...

UEs shall implement EIA0 for integrity protection of NAS and RRC signalling. As specified in clause 5.1.4.1 of this specification, EIA0 is only allowed for unauthenticated emergency calls. EIA0 shall not be used for integrity protection between RN and DeNB.

Implementation of EIA0 in MMEs and eNBs is optional, EIA0, if implemented, shall be disabled in MMEs and eNBs in the deployments where support of unauthenticated emergency calling is not a regulatory requirement.

[TS 36.331, clause 6.3.3]

The IE *SecurityAlgorithmConfig* is used to configure AS integrity protection algorithm (SRBs) and AS ciphering algorithm (SRBs and DRBs). For RNs, the IE *SecurityAlgorithmConfig* is also used to configure AS integrity protection algorithm for DRBs between the RN and the E-UTRAN.

...

SecurityAlgorithmConfig field descriptions
<p>cipheringAlgorithm Indicates the ciphering algorithm to be used for SRBs and DRBs, as specified in TS 33.401 [32, 5.1.3.2].</p>
<p>integrityProtAlgorithm Indicates the integrity protection algorithm to be used for SRBs, as specified in TS 33.401 [32, 5.1.4.2]. For RNs, also indicates the integrity protection algorithm to be used for integrity protection-enabled DRB(s).</p>

7.3.4.2.3 Test description

7.3.4.2.3.1 Pre-test conditions

Same Pre-test conditions as in clause 7.3.4.1.3.1.

7.3.4.2.3.2 Test procedure sequence

Same Test procedure sequence as in table 7.3.4.1.3.2-1, except the integrity protection algorithm is AES.

7.3.4.2.3.3 Specific message contents

Table 7.3.4.2.3.3-1: SecurityModeCommand message (step 5, 14 and 16, Table 7.3.4.1.3.2-1)

Derivation Path: 36.508 Table 4.6.1-19			
Information Element	Value/remark	Comment	Condition
SecurityModeCommand ::= SEQUENCE {			
rrc-TransactionIdentifier	RRC-TransactionIdentifier-DL		
criticalExtensions CHOICE {			
c1 CHOICE{			
securityModeCommand-r8 SEQUENCE {			
securityConfigSMC SEQUENCE {			
securityAlgorithmConfig SEQUENCE {			
integrityProtAlgorithm	eia2	128-EIA2 AES	
}			
}			
}			
}			
}			
}			

Table 7.3.4.2.3.3-2: RRCConnectionReestablishmentRequest (step 19, Table 7.3.4.2.3.2-1)

Derivation Path: 36.508, Table 4.6.1-13			
Information Element	Value/remark	Comment	Condition
RRCConnectionReestablishmentRequest ::= SEQUENCE {			
criticalExtensions CHOICE {			
rrcConnectionReestablishmentRequest-r8 SEQUENCE {			
ue-Identity SEQUENCE {			
c-RNTI	the value of the C-RNTI of the UE		
physCellId	PhysicalCellIdentity of Cell 1		
shortMAC-I	The same value as the 16 least significant bits of the XMAC-I value calculated by SS		
}			
reestablishmentCause	otherFailure		
}			
}			

7.3.4.3 Integrity protection / Correct functionality of EPS AS integrity algorithms / ZUC

7.3.4.3.1 Test Purpose (TP)

(1)

```
with { UE in RRC_IDLE/E-UTRA RRC_CONNECTED state }
ensure that {
  when { Functionality of EPS AS integrity algorithms with ZUC is taken into use }
  then { UE performs the integrity protection function in PDCP entities associated with SRBs. }
}
```

(2)

```
with { UE in E-UTRA RRC_CONNECTED state }
ensure that {
  when { SecurityModeCommand fails the integrity protection check }
  then { UE transmits SecurityModeFailure message and continues using the configuration used
prior to the reception of the SecurityModeCommand message }
}
```

(3)

```
with { UE in E-UTRA RRC_CONNECTED state }
ensure that {
  when { UE has AS security activated and integrity check fails }
  then { UE initiates RRC connection re-establishment procedure }
}
```

7.3.4.3.2 Conformance requirements

References: The conformance requirements covered in the present TC are specified in: 3GPP TS 36.323 clause 5.7, clause 5.1.2.2, TS 33.401 clause 5.1.4.2 and TS 36.331 clause 6.3.3

[TS 36.323, clause 5.7]

The integrity protection function includes both integrity protection and integrity verification and is performed in PDCP for PDCP entities associated with SRBs. The data unit that is integrity protected is the PDU header and the data part of the PDU before ciphering.

For RNs, the integrity protection function is performed also for PDCP entities associated with DRBs if integrity protection is configured.

The integrity protection algorithm and key to be used by the PDCP entity are configured by upper layers [3] and the integrity protection method shall be applied as specified in [6].

The integrity protection function is activated by upper layers [3]. After security activation, the integrity protection function shall be applied to all PDUs including and subsequent to the PDU indicated by upper layers [3] for the downlink and the uplink, respectively.

NOTE: As the RRC message which activates the integrity protection function is itself integrity protected with the configuration included in this RRC message, this message needs first be decoded by RRC before the integrity protection verification could be performed for the PDU in which the message was received.

The parameters that are required by PDCP for integrity protection are defined in [6] and are input to the integrity protection algorithm. The required inputs to the integrity protection function include the COUNT value, and DIRECTION (direction of the transmission: set as specified in [6]). The parameters required by PDCP which are provided by upper layers [3] are listed below:

- BEARER (defined as the radio bearer identifier in [6]. It will use the value RB identity –1 as in [3]);
- KEY (K_{RRCint}).
- for RNs, KEY (K_{UPint})

At transmission, the UE computes the value of the MAC-I field and at reception it verifies the integrity of the PDCP PDU by calculating the X-MAC based on the input parameters as specified above. If the calculated X-MAC corresponds to the received MAC-I, integrity protection is verified successfully.

[TS 36.323, clause 5.1.2.2]

if integrity verification is not applicable:

- if received PDCP SN < Next_PDCP_RX_SN:
 - increment RX_HFN by one;
- set Next_PDCP_RX_SN to the received PDCP SN + 1;
- if Next_PDCP_RX_SN > Maximum_PDCP_SN:
 - set Next_PDCP_RX_SN to 0;
 - increment RX_HFN by one;
- deliver the resulting PDCP SDU to upper layer;
- else, if integrity verification is applicable and the integrity verification fails:
 - discard the received PDCP Data PDU;
- indicate the integrity verification failure to upper layer

[TS 33.401, clause 5.1.4.2]

All algorithms specified in this subclause are algorithms with a 128-bit input key.

NOTE: Deviations from the above requirement have to be indicated explicitly in the algorithm identifier list below.

Each EPS Integrity Algorithm (EIA) will be assigned a 4-bit identifier. Currently, the following values have been defined:

...

"0011₂" 128-EIA3 ZUC

The remaining values have been reserved for future use.

UEs and eNBs shall implement 128-EIA1 and 128-EIA2 for RRC signalling integrity protection. UEs and eNBs may implement 128-EIA3 for RRC signalling integrity protection.

...

UEs shall implement EIA0 for integrity protection of NAS and RRC signalling. As specified in clause 5.1.4.1 of this specification, EIA0 is only allowed for unauthenticated emergency calls. EIA0 shall not be used for integrity protection between RN and DeNB.

Implementation of EIA0 in MMEs and eNBs is optional, EIA0, if implemented, shall be disabled in MMEs and eNBs in the deployments where support of unauthenticated emergency calling is not a regulatory requirement.

[TS 36.331, clause 6.3.3]

The IE *SecurityAlgorithmConfig* is used to configure AS integrity protection algorithm (SRBs) and AS ciphering algorithm (SRBs and DRBs). For RNs, the IE *SecurityAlgorithmConfig* is also used to configure AS integrity protection algorithm for DRBs between the RN and the E-UTRAN.

...

<i>SecurityAlgorithmConfig</i> field descriptions
<i>cipheringAlgorithm</i> Indicates the ciphering algorithm to be used for SRBs and DRBs, as specified in TS 33.401 [32, 5.1.3.2].
<i>integrityProtAlgorithm</i> Indicates the integrity protection algorithm to be used for SRBs, as specified in TS 33.401 [32, 5.1.4.2]. For RNs, also indicates the integrity protection algorithm to be used for integrity protection-enabled DRB(s).

7.3.4.3.3 Test description

7.3.4.3.3.1 Pre-test conditions

Same Pre-test conditions as in clause 7.3.4.1.3.1.

7.3.4.3.3.2 Test procedure sequence

Same Test procedure sequence as in table 7.3.4.1.3.2-1, except the integrity protection algorithm is ZUC.

7.3.4.3.3.3 Specific message contents

Table 7.3.4.3.3-1: SecurityModeCommand message (step 5, 14 and 16, Table 7.3.4.1.3.2-1)

Derivation Path: 36.508 Table 4.6.1-19			
Information Element	Value/remark	Comment	Condition
SecurityModeCommand ::= SEQUENCE {			
rrc-TransactionIdentifier	RRC-TransactionIdentifier-DL		
criticalExtensions CHOICE {			
c1 CHOICE{			
securityModeCommand-r8 SEQUENCE {			
securityConfigSMC SEQUENCE {			
securityAlgorithmConfig SEQUENCE {			
integrityProtAlgorithm	eia3-v11xy	128-EIA3 ZUC	
}			
}			
}			
}			
}			
}			

Table 7.3.4.3.3-2: RRCConnectionReestablishmentRequest (step 19, Table 7.3.4.1.3.2-1)

Derivation Path: 36.508, Table 4.6.1-13			
Information Element	Value/remark	Comment	Condition
RRCConnectionReestablishmentRequest ::= SEQUENCE {			
criticalExtensions CHOICE {			
rrcConnectionReestablishmentRequest-r8 SEQUENCE {			
ue-Identity SEQUENCE {			
c-RNTI	the value of the C-RNTI of the UE		
physCellId	PhysicalCellIdentity of Cell 1		
shortMAC-I	The same value as the 16 least significant bits of the XMAC-I value calculated by SS		
}			
reestablishmentCause	otherFailure		
}			
}			

Table 7.3.4.3.3-3: RRCConnectionReconfiguration (step 21A, Table 7.3.4.1.3.2-1)

Derivation Path: 36.508 table 4.6.1-8, condition SRB2-DRB(1, 0)

7.3.5 PDCP handover

7.3.5.1 Void

7.3.5.2 PDCP handover / Lossless handover / PDCP sequence number maintenance

7.3.5.2.1 Test Purpose (TP)

(1)

```
with {UE in E-UTRA RRC_CONNECTED state with default RB using RLC-AM}
ensure that {
  when { UE is requested to make a lossless handover by SS }
  then { UE retransmits the unacknowledged data }
}
```

7.3.5.2.2 Conformance requirements

References: The conformance requirements covered in the present TC are specified in: 3GPP TS 36.323 clause 5.2.1.1.

[TS 36.323, clause 5.2.1.1]

When upper layers request a PDCP re-establishment, the UE shall:

- reset the header compression protocol for uplink (if configured);
- apply the ciphering algorithm and key provided by upper layers during the re-establishment procedure;
- from the first PDCP SDU for which the successful delivery of the corresponding PDCP PDU has not been confirmed by lower layers, perform retransmission or transmission of all the PDCP SDUs already associated with PDCP SNs in ascending order of the COUNT values associated to the PDCP SDU prior to the PDCP re-establishment as specified below:
 - perform header compression of the PDCP SDU (if configured) as specified in the subclause 5.5.4;
 - perform ciphering of the PDCP SDU using the COUNT value associated with this PDCP SDU as specified in the subclause 5.6;
- submit the resulting PDCP Data PDU to lower layer

7.3.5.2.3 Test description

7.3.5.2.3.1 Pre-test conditions

System Simulator:

- Cell 1 and Cell 2

UE:

None.

Preamble:

- The UE is in state Loopback Activated (state 4) according to [18] and table 7.3.5.2.3. 3-2 for SR configuration.

7.3.5.2.3.2 Test procedure sequence

Table 7.3.5.2.3.2.0-1: Time instances of cell power level

	Parameter	Unit	Cell 1	Cell 2	Remark
T1	Cell-specific RS EPRE	dBm/15k Hz	-85	-79	

Table 7.3.5.2.3.2-1: Main behaviour

St	Procedure	Message Sequence		TP	Verdict
		U - S	Message		
1	The SS creates 5 PDCP Data PDUs and the Next_PDCP_TX_SN is set to "0".	-	-	-	-
-	EXCEPTION: Step 2 and 3 A shall be repeated for k=0 to 1(increment=1).	-	-	-	-
2	The SS sends the PDCP Data PDU#k via RLC-AM RB with the following content to the UE: D/C field = 1 (PDCP Data PDU) and PDCP SN = k. After having sent a PDU, the SS set Next_PDCP_TX_SN= k+1.	<--	PDCP PDU DATA #k	-	-
3	The UE sends the PDCP Data PDU#k via RLC-AM RB with the following content to the UE: D/C field = 1 (PDCP Data PDU) and PDCP SN = k. Data is previously received data from PDU #k. (Note 1)	-->	PDCP PDU DATA #k	-	-
3A	Wait for the expiry of t-PollRetransmit	-	-	-	-
4	Configure SS not to allocate UL grant to the UE in Cell 1.	-	-	-	-
-	EXCEPTION: Step 5 shall be repeated for m=2 to 4 (increment=1).	-	-	-	-
5	The SS sends the PDCP Data PDU #m via RLC-AM RB with the following content to the UE: D/C field = 1 (PDCP Data PDU) and PDCP SN =m. After having sent a PDU, the SS set Next_PDCP_TX_SN = m+1.	<--	PDCP PDU DATA #m	-	-
5A	The SS changes Cell 2 parameters according to the row "T1" in table 7.3.5.2.3.2.0-1.	-	-	-	-
5B	Configure SS to allocate Default UL grant to the UE in Cell 2 (Note 2). Note: These grants will be requested by the UE to send data after the handover	-	-	-	-
6	The SS requests UE to make a handover to Cell2 with the RRCConnectionReconfiguration message sent on Cell 1.	<--	<i>RRCConnectionReconfiguration</i>	-	-
7	SS assigns UL grant during the Random Access procedure to allow the UE to send only <i>RRCConnectionReconfigurationComplete</i> message.	-	-	-	-
8	The UE on Cell 2 transmits a <i>RRCConnectionReconfigurationComplete</i> message.	-->	<i>RRCConnectionReconfigurationComplete</i>	-	-
8A	The UE send PDCP Control PDUs via RLC-AM RB with the following content to the SS: D/C field = 0 (PDCP control PDU) and PDU Type =000, FMS field = 5.	-->	PDCP STATUS REPORT	-	-
8B	The SS generates a PDCP status report message and sends it to UE: D/C field = 0 (PDCP control PDU) and PDU Type =000, FMS field = 2.	<--	PDCP STATUS REPORT	-	-
8C	Configure SS to allocate Default UL grant to the UE in Cell 2	-	-	-	-
-	EXCEPTION: Step 9 shall be repeated for m=2 to 4 (increment=1).	-	-	-	-
9	Check: Does the UE send the PDCP Data PDU #m via RLC-AM RB with the following content to the SS: D/C field = 1 (PDCP Data PDU) and PDCP SN = m?	-->	PDCP PDU DATA #m	1	P

Data is previously received data from PDU #m.			
Note 1: The SS acknowledges the received data. Note 2: SS transmit an UL grant of 72 bits (ITBS=2, NPRB=2, TS 36.213 Table 7.1.7.2.1-1) to allow UE to transmit only PDCP Status report.			

7.3.5.2.3.3 Specific message contents

Table 7.3.5.2.3.3-1: RRCConnectionReconfiguration (step 6, Table 7.3.5.2.3.2-1)

Derivation Path: 36.508, Table 4.6.1-8, condition HO			
Information Element	Value/remark	Comment	Condition
RRCConnectionReconfiguration ::= SEQUENCE {			
criticalExtensions CHOICE {			
c1 CHOICE{			
rrcConnectionReconfiguration-r8 SEQUENCE {			
mobilityControllInfo SEQUENCE {		MobilityControllInfo -HO	
targetPhysCellId	PhysicalCellIdentity of Cell 2		
carrierFreq	Not present		
}			
}			
}			
}			
}			

Table 7.3.5.2.3. 3-2: SchedulingRequest-Config (RRC Connection Reconfiguration, preamble Table 4.5.3.3-1: Step8)

Derivation Path: 36.508 Table 4.6.3-20			
Information Element	Value/remark	Comment	Condition
dssr-TransMax	n64		

7.3.5.3 PDCP handover / Non-lossless handover PDCP sequence number maintenance

7.3.5.3.1 Test Purpose (TP)

(1)

```
with {UE in E-UTRA RRC_CONNECTED state with bearer using RLC-UM}
ensure that {
  when {UE is requested to make a non-lossless handover by SS}
  then {UE transmits next PDCP Data PDU with SN value 0 }
}
```

7.3.5.3.2 Conformance requirements

References: The conformance requirements covered in the present TC are specified in: 3GPP TS 36.323 clauses 5.2.1.2.

[TS 36.323, clause 5.2.1.2]

When upper layers request a PDCP re-establishment, the UE shall:

- reset the header compression protocol for uplink (if configured);
- set Next_PDCP_TX_SN, and TX_HFN to 0;
- apply the ciphering algorithm and key provided by upper layers during the re-establishment procedure;
- for each PDCP SDU already associated with a PDCP SN but for which a corresponding PDU has not previously been submitted to lower layers:
- consider the PDCP SDUs as received from upper layer;

- perform transmission of the PDCP SDUs in ascending order of the COUNT value associated to the PDCP SDU prior to the PDCP re-establishment, as specified in the subclause 5.1.1 without restarting the *discard-Timer*.

7.3.5.3.3 Test description

7.3.5.3.3.1 Pre-test conditions

System Simulator:

- Cell 1 and Cell 2

UE:

None.

Preamble:

- The UE is in state Loopback Activated (state 4) according to [18].
- The condition SRB2-DRB(1,1) is used for step 8 in 4.5.3A.3 according to [18].

7.3.5.3.3.2 Test procedure sequence

Table 7.3.5.3.3.2.0-1: Time instances of cell power level

	Parameter	Unit	Cell 1	Cell 2	Remark
T1	Cell-specific RS EPRE	dBm/15k Hz	-85	-79	

Table 7.3.5.3.3.2-1: Main behaviour

St	Procedure	Message Sequence		TP	Verdict
		U - S	Message		
1	The SS creates 3 PDCP Data PDUs and the Next_PDCP_TX_SN is set to "0".	-	-	-	-
	EXCEPTION: Step 2 and 3 shall be repeated for k=0 to 1 (increment=1).				
2	The SS sends the PDCP Data PDU #k via RLC-UM RB with the following content to the UE: D/C field = 1 (PDCP Data PDU) and PDCP SN = k. After having sent a PDU, the SS set Next_PDCP_TX_SN= k+1.	<--	PDCP PDU DATA #k	-	-
3	The UE sends the PDCP Data PDU #k via RLC-UM RB with the following content to the SS: D/C field = 1 (PDCP Data PDU) and PDCP SN = k. Data is previously received data PDU #k.	-->	PDCP PDU DATA #k		
3A	The SS changes Cell 2 parameters according to the row "T1" in table 7.3.5.3.3.2.0-1.	-	-	-	-
3B	Configure SS to allocate Default UL grant to the UE in Cell 2 Note: These grants will be requested by the UE to send data after the handover	-	-	-	-
4	The SS requests UE to make a handover to Cell 2 with the <i>RRCCConnectionReconfiguration</i> message.	<--	<i>RRCCConnectionReconfiguration</i>		
4A	SS assigns UL grant during the Random Access procedure to allow the UE to send only <i>RRCCConnectionReconfigurationComplete</i> message.	-	-	-	-
5	The UE transmits a <i>RRCCConnectionReconfigurationComplete</i> message.	-->	<i>RRCCConnectionReconfigurationComplete</i>	-	
6	The SS sends the PDCP Data PDU #2 via RLC-UM RB with the following content to the UE: D/C field = 1 (PDCP Data PDU) and PDCP SN = 2. After having sent a PDU, the SS set Next_PDCP_TX_SN= k+1.	<--	PDCP PDU DATA #2		
7	Check: Does the UE send the PDCP Data PDU #2 via RLC-UM RB with the following content back to the SS: D/C field = 1 (PDCP Data PDU) and PDCP SN = 0. Data is previously received data PDU #2.	-->	PDCP PDU DATA #2	1	P

7.3.5.3.3 Specific message contents

Table 7.3.5.3.3-1: RRCConnectionReconfiguration (step 4, 7.3.5.3.3.2-1)

Derivation Path: 36.508, Table 4.6.1-8, condition HO			
Information Element	Value/remark	Comment	Condition
RRCConnectionReconfiguration ::= SEQUENCE {			
criticalExtensions CHOICE {			
c1 CHOICE{			
rrcConnectionReconfiguration-r8 SEQUENCE {			
mobilityControlInfo SEQUENCE {		MobilityControlInfo -HO	
targetPhysCellId	PhysicalCellIdentity of Cell 2		
carrierFreq	Not present		
}			
}			
}			
}			
}			

7.3.5.4 PDCP handover / Lossless handover / PDCP status report to convey the information on missing or acknowledged PDCP SDUs at handover

7.3.5.4.1 Test Purpose (TP)

(1)

```
with { UE in E-UTRA RRC_CONNECTED state with default RB used RLC-AM mode }
ensure that {
  when { UE is requested to make a handover by SS }
  then { UE creates a PDCP status report to SS}}
```

(2)

```
with { UE in E-UTRA RRC_CONNECTED state with default RB used RLC-AM mode }
ensure that {
  when { UE is requested to make a handover by SS }
  then { UE discards the corresponding PDCP PDU and PDCP SDU according to the PDCP status report
from SS }}
```

7.3.5.4.2 Conformance requirements

References: The conformance requirements covered in the present TC are specified in: 3GPP TS 36.323 clauses 5.3 and 5.4

[TS 36.323, clause 5.3.1]

When upper layers request a PDCP re-establishment, for radio bearers that are mapped on RLC AM, the UE shall:

- if the radio bearer is configured by upper layers to send a PDCP status report in the uplink, compile a status report as indicated below after processing the PDCP Data PDUs that are received from lower layers due to the re-establishment of the lower layers as specified in the subclause 5.2.2.1, and submit it to lower layers as the first PDCP PDU for the transmission, by:
 - setting the FMS field to the PDCP SN of the first missing PDCP SDU;
 - if there is at least one out-of-sequence PDCP SDU stored, allocating a Bitmap field of length in bits equal to the number of PDCP SNs from and not including the first missing PDCP SDU up to and including the last out-of-sequence PDCP SDUs, rounded up to the next multiple of 8;
 - setting as '0' in the corresponding position in the bitmap field for all PDCP SDUs that have not been received as indicated by lower layers, and optionally PDCP SDUs for which decompression have failed;
 - indicating in the bitmap field as '1' for all other PDCP SDUs.

[TS 36.323, clause 5.3.2]

When a PDCP status report is received in the downlink, for radio bearers that are mapped on RLC AM:

- for each PDCP SDU, if any, with the bit in the bitmap set to '1', or with the associated COUNT value less than the COUNT value of the PDCP SDU identified by the FMS field, the successful delivery of the corresponding PDCP SDU is confirmed, and the UE shall process the PDCP SDU as specified in the subclause 5.4.

[TS 36.323, clause 5.4]

When the Discard_Timer expires for a PDCP SDU, or the successful delivery of a PDCP SDU is confirmed by PDCP status report, the UE shall discard the PDCP SDU along with the corresponding PDCP PDU. If the corresponding PDCP PDU has already been submitted to lower layers the discard is indicated to lower layers.

7.3.5.4.3 Test description

TC is applicable to:

- All UEs supporting E-UTRA.

7.3.5.4.3.1 Pre-test conditions

System Simulator:

- Cell 1 and Cell 2
- ROHC is not used for headerCompression settings.

UE:

- UE in UE Loopback Activated test state (state 4) with default RB using RLC-AM in Cell 1 and table 7.3.5.4.3.2 for SR configuration.

7.3.5.4.3.2 Test procedure sequence

Table 7.3.5.4.3.2-1: Time instances of cell power level

	Parameter	Unit	Cell 1	Cell 2	Remark
T1	Cell-specific RS EPRE	dBm/15k Hz	-85	-79	

Table 7.3.5.4.3.2-2: Main Behaviour

St	Procedure	Message Sequence		TP	Verdict
		U - S	Message		
1	Next_PDCP_TX_SN is set to "0". The SS creates 4 PDCP Data PDUs.		-	-	-
2	The SS sends the PDCP Data PDU #0 via RLC-AM RB with the following content to the UE: D/C field = 1 (PDCP Data PDU) and PDCP SN =0. The SS sets Next_PDCP_TX_SN = 1.	<--	PDCP DATA PDU #0	-	-
3	The UE sends a PDCP Data PDU #0 via RLC-AM RB with the following content back to the SS: D/C field = 1 (PDCP Data PDU) and PDCP SN = 0 data: previously received packet. (Note 1)	-->	PDCP DATA PDU #0	-	-
4	The SS is configured on Cell 1 not to send RLC acknowledgements (RLC ACK s) to the UE.				
4A	Configure SS not to allocate UL grant to the UE in Cell 1.	-	-	-	-
5	After 100 ms the SS sends the PDCP Data PDU #1 via RLC-AM RB with the following content to the UE: D/C field = 1 (PDCP Data PDU) and PDCP SN =1. The SS set Next_PDCP_TX_SN = 2.	<--	PDCP DATA PDU#1		
5A	The SS waits for 60 ms and then allocates 1 UL grants (UL grant allocation type 2, Default UL Grant size) to enable UE to return PDCP Data PDU	<--	(UL grants)	-	-
6	The UE sends a PDCP Data PDU #1 via RLC-AM RB with the following content back to the SS: D/C field = 1 (PDCP Data PDU) and PDCP SN = 1 data: previously received packet.	-->	PDCP DATA PDU#1		
6A	The SS changes Cell 2 parameters according to the row "T1" in table 7.3.5.4.3.2-1.	-	-	-	-
6B	The SS ignores scheduling requests and does not allocate any uplink grant in cell 2.	-	-	-	-
7	The SS requests UE to make a handover to Cell2 with the <i>RRConnectionReconfiguration</i> message sent on Cell1.	<--	<i>RRConnectionReconfiguration</i> message.	-	-
7A	SS assigns UL grant during the Random Access procedure to allow the UE to send only <i>RRConnectionReconfigurationComplete</i> message.	-	-	-	-
8	The UE transmits a <i>RRConnectionReconfigurationComplete</i> message on Cell2.	-->	<i>RRConnectionReconfigurationC</i> omplete message.	-	-
8A	The SS generates a PDCP status report message and sends it to UE: D/C field = 0 (PDCP control PDU) and PDU Type =000, FMS field = 2.	<--	PDCP status report	-	-
8B	SS waits for 500 ms of ensure UE PDCP has discarded PDCP PDU and is ready to transmit PDCP status report and then assigns 1 UL grant (UL grant allocation type 3) of size 72 bits. (Note 2)				
9	Check: Does the UE send PDCP Control PDUs via RLC-AM RB with the following content to the SS: D/C field = 0 (PDCP control	-->	PDCP status report	1	P

	PDU) and PDU Type =000, FMS field = 2.				
10	Void	-	-	-	-
10 A	Configure SS to allocate Default UL grant to the UE in Cell 2	-	-	-	-
	EXCEPTION: Step 11 shall be repeated for k=2 to 3 (increment=1).				
11	The SS sends the PDCP Data PDU #k via RLC-AM RB with the following content to the UE: D/C field = 1 (PDCP Data PDU) and PDCP SN = k. After having sent a PDU, the SS set Next_PDCP_TX_SN = k + 1.	<--	PDCP DATA PDU #k	-	-
12	Check: Does the UE send a PDCP Data PDU#2 via RLC-AM RB with the following content back to the SS: D/C field = 1 (PDCP Data PDU) and PDCP SN = 2 data: previously received packet.	-->	PDCP DATA PDU #2	2	P
13	Check: Does the UE send a PDCP Data PDU#3 via RLC-AM RB with the following content back to the SS: D/C field = 1 (PDCP Data PDU) and PDCP SN = 3 data: previously received packet.	-->	PDCP DATA PDU #3	2	P
<p>Note 1: The SS sends RLC ACK to the UE Note 2: SS transmit an UL grant of 72 bits (ITBS=2, NPRB=2, TS 36.213 Table 7.1.7.2.1-1) to allow UE to transmit only PDCP Status report.</p>					

7.3.5.4.3.3 Specific message contents

Table 7.3.5.4.3.3-1: RRCConnectionReconfiguration (Step 7, table 7.3.5.4.3.2-2)

Derivation Path: 36.508 Table 4.6.1-8			
Information Element	Value/remark	Comment	Condition
RRCConnectionReconfiguration ::= SEQUENCE {			
criticalExtensions CHOICE {			
c1 CHOICE{			
rrcConnectionReconfiguration-r8 SEQUENCE {			
mobilityControllInfo SEQUENCE {		MobilityControllInfo-HO	
targetPhysCellId	PhysicalCellIdentity of Cell 2		
carrierFreq	Not present		
}			
RadioResourceConfigDedicated-HO {			
drb-ToAddModifyList {			
PDCP-Configuration-DRB-AM {			
discardTimer	infinity		
rlc-AM SEQUENCE {			
statusReportRequired	TRUE		
}			
}			
}			
}			
}			
}			
}			
}			

Table 7.3.5.4.3.3-2: SchedulingRequest-Config (RRC Connection Reconfiguration, preamble Table 4.5.3.3-1: Step8 and table 7.3.5.4.3.2-2, step 7)

Derivation Path: 36.508 Table 4.6.3-20			
Information Element	Value/remark	Comment	Condition
dsr-TransMax	n64		

7.3.5.5 PDCP handover / In-order delivery and duplicate elimination in the downlink

7.3.5.5.1 Test Purpose (TP)

(1)

```
with { UE in E-UTRA RRC_CONNECTED state with default RB using RLC-AM }
ensure that {
  when { UE is requested to make a handover by SS }
  then { UE achieves in-order delivery and duplicate elimination in the downlink }
}
```

7.3.5.5.2 Conformance requirements

References: The conformance requirements covered in the present TC are specified in: 3GPP TS 36.323 clauses 5.1.2.1.2.

[TS 36.323, clause 5.1.2.1.2]

For DRBs mapped on RLC AM, at reception of a PDCP Data PDU from lower layers, the UE shall:

- if received PDCP SN – Last_Submitted_PDCP_RX_SN > Reordering_Window or 0 <= Last_Submitted_PDCP_RX_SN – received PDCP SN < Reordering_Window:
 - if received PDCP SN > Next_PDCP_RX_SN:
 - decipher the PDCP PDU as specified in the subclause 5.6, using COUNT based on RX_HFN - 1 and the received PDCP SN;
 - else:
 - decipher the PDCP PDU as specified in the subclause 5.6, using COUNT based on RX_HFN and the received PDCP SN;
 - perform header decompression (if configured) as specified in the subclause 5.5.5;
 - discard this PDCP SDU;
- else if Next_PDCP_RX_SN – received PDCP SN > Reordering_Window:
 - increment RX_HFN by one;
 - use COUNT based on RX_HFN and the received PDCP SN for deciphering the PDCP PDU;
 - set Next_PDCP_RX_SN to the received PDCP SN + 1;
- else if received PDCP SN – Next_PDCP_RX_SN >= Reordering_Window:
 - use COUNT based on RX_HFN – 1 and the received PDCP SN for deciphering the PDCP PDU;
- else if received PDCP SN >= Next_PDCP_RX_SN:
 - use COUNT based on RX_HFN and the received PDCP SN for deciphering the PDCP PDU;
 - set Next_PDCP_RX_SN to the received PDCP SN + 1;
 - if Next_PDCP_RX_SN is larger than Maximum_PDCP_SN:
 - set Next_PDCP_RX_SN to 0;

- increment RX_HFN by one;
- else if received PDCP SN < Next_PDCP_RX_SN:
 - use COUNT based on RX_HFN and the received PDCP SN for deciphering the PDCP PDU;
- if the PDCP PDU has not been discarded in the above:
 - perform deciphering and header decompression (if configured) for the PDCP PDU as specified in the subclauses 5.6 and 5.5.5, respectively;
 - if a PDCP SDU with the same PDCP SN is stored:
 - discard this PDCP SDU;
 - else:
 - store the PDCP SDU;
- if the PDCP PDU received by PDCP is not due to the re-establishment of lower layers:
 - deliver to upper layers in ascending order of the associated COUNT value:
 - all stored PDCP SDU(s) with an associated COUNT value less than the COUNT value associated with the received PDCP SDU;
 - all stored PDCP SDU(s) with consecutively associated COUNT value(s) starting from the COUNT value associated with the received PDCP SDU;
 - set Last_Submitted_PDCP_RX_SN to the PDCP SN of the last PDCP SDU delivered to upper layers;
- else if received PDCP SN = Last_Submitted_PDCP_RX_SN + 1 or received PDCP SN = Last_Submitted_PDCP_RX_SN – Maximum_PDCP_SN:
 - deliver to upper layers in ascending order of the associated COUNT value:
 - all stored PDCP SDU(s) with consecutively associated COUNT value(s) starting from the COUNT value associated with the received PDCP SDU;
 - set Last_Submitted_PDCP_RX_SN to the PDCP SN of the last PDCP SDU delivered to upper layers.

7.3.5.5.3 Test description

7.3.5.5.3.1 Pre-test conditions

System Simulator:

- Cell 1 and Cell 2

UE:

None.

Preamble:

- The UE is in state Loopback Activated (state 4) according to [18].

7.3.5.5.3.2 Test procedure sequence

Table 7.3.5.5.3.2.0-1: Time instances of cell power level

	Parameter	Unit	Cell 1	Cell 2	Remark
T1	Cell-specific RS EPRE	dBm/15k Hz	-85	-79	

Table 7.3.5.5.3.2-1: Main behaviour

St	Procedure	Message Sequence		TP	Verdict
		U - S	Message		
1	The Next PDCP_TX_SN is set to "0". The SS creates a PDCP Data PDU#0.	-	-	-	-
2	The SS sends the PDCP Data PDU#0 via RLC-AM RB with the following content to the UE: PDCP Data PDU #0 (D/C field = 1 (PDCP Data PDU) and PDCP SN=0) (Note 1)	<--	PDCP DATA PDU#0	-	-
3	The UE transmits a PDCP Data PDU via RLC-AM RB with the following content back to the SS D/C field = 1 (PDCP Data PDU) and PDCP SN=0 data: previously received packet in PDCP Data PDU#0 (Note 2)	-->	PDCP DATA PDU #0	-	-
4	Next_PDCP_TX_SN is set to 1. The SS creates a PDCP Data PDU#1 (not transmitted).	-	-	-	-
5	The Next_PDCP_TX_SN is set to "2". The SS creates a PDCP Data PDU #2.	-	-	-	-
6	The SS sends the PDCP Data PDU#2 via RLC-AM RB with the following content to the UE: PDCP Data PDU#1; D/C field = 1 (PDCP Data PDU) and PDCP SN=2 (Note 3)	<--	PDCP DATA PDU #2	-	-
7	Check: Does the UE transmit a PDCP DATA PDU#2?	-->	PDCP DATA PDU#2	1	F
7A	The SS changes Cell 2 parameters according to the row "T1" in table 7.3.5.5.3.2.0-1.	-	-	-	-
7B	Configure SS to allocate Default UL grant to the UE in Cell 2 (Note 6). Note: These grants will be requested by the UE to send data after the handover	-	-	-	-
8	The SS requests UE to make a handover to Cell 2 with the <i>RRConnectionReconfiguration</i> message.	<---	<i>RRConnectionReconfiguration</i>	-	-
8A	SS assigns UL grant during the Random Access procedure to allow the UE to send only <i>RRConnectionReconfigurationComplete</i> message.	-	-	-	-
9	The UE transmits a <i>RRConnectionReconfigurationComplete</i> message in the new cell.	-->	<i>RRConnectionReconfigurationC</i> omplete	-	-
9A	The UE send PDCP Control PDUs via RLC-AM RB with the following content to the SS: D/C field = 0 (PDCP control PDU) and PDU Type =000, FMS field = 1, Bitmap = 0x80.	-->	PDCP STATUS REPORT	-	-
9B	The SS generates a PDCP status report message and sends it to UE: D/C field = 0 (PDCP control PDU) and PDU Type =000, FMS field = 1.	<--	PDCP STATUS REPORT	-	-
9C	Configure SS to allocate Default UL grant to the UE in Cell 2	-	-	-	-
10	The SS sends the PDCP Data PDU#0 via	<--	PDCP DATA PDU #0	-	-

	RLC-AM RB with the following content to the UE: PDCP Data PDU #0(D/C field = 1 (PDCP Data PDU) and PDCP SN=0) (Note 4)				
11	Check: Does the UE transmit PDCP Data PDU via RLC-AM RB with the following content back to the SS? D/C field = 1 (PDCP Data PDU) and PDCP SN=0 data: previously received packet in PDCP Data PDU #0	-->	PDCP DATA PDU #0	1	F
12	The SS sends the PDCP Data PDU#1 via RLC-AM RB with the following content to the UE: PDCP Data PDU#1 (D/C field = 1 (PDCP Data PDU) and PDCP SN=1) (Note 5)	<--	PDCP DATA PDU #1	-	-
13	Check: Does the UE transmit a PDCP Data PDU via RLC-AM RB with the following content back to the SS? D/C field = 1 (PDCP Data PDU) and PDCP SN=1 data: previously received packet in PDCP Data PDU#1	-->	PDCP DATA PDU #1	1	P
14	Check: Does the UE transmit PDCP Data PDU via RLC-AM RB with the following content back to the SS? D/C field = 1 (PDCP Data PDU) and PDCP SN=2 data: previously received packet in PDCP Data PDU#2	-->	PDCP DATA PDU #2	1	P
<p>Note 1: PDCP Data PDU#0 is sent in RLC PDU#0: SN=0. Note 2: The SS sends RLC ACK to the UE Note 3: PDCP Data PDU #2 is sent in RLC PDU#2: SN=2 Note 4: PDCP Data PDU #0 is sent in RLC PDU#1: SN=1 Note 5: PDCP Data PDU #1 is sent in RLC PDU #2:SN = 2 Note 6: SS transmit an UL grant of 72 bits (ITBS=2, NPRB=2, TS 36.213 Table 7.1.7.2.1-1) to allow UE to transmit only PDCP Status report.</p>					

7.3.5.5.3.3 Specific message contents

Table 7.3.5.5.3.3-1: RRCConnectionReconfiguration (Step 4, Table 7.3.5.5.3.2-1)

Derivation Path: 36.508, Table 4.6.1-8, condition HO			
Information Element	Value/remark	Comment	Condition
RRCConnectionReconfiguration ::= SEQUENCE {			
criticalExtensions CHOICE {			
c1 CHOICE{			
rrcConnectionReconfiguration-r8 SEQUENCE {			
mobilityControllInfo SEQUENCE {		MobilityControllInfo -HO	
targetPhysCellId	PhysicalCellIdentity of Cell 2		
carrierFreq	Not present		
}			
}			
}			
}			
}			

7.3.6 PDCP Others

7.3.6.1 PDCP Discard

7.3.6.1.1 Test Purpose (TP)

(1)

```
with { UE in E-UTRA RRC_CONNECTED state }
ensure that {
  when { the Discard Timer for a PDCP SDU expires }
  then { UE discards the corresponding PDCP SDU }
}
```

7.3.6.1.2 Conformance requirements

References: The conformance requirements covered in the present TC are specified in: 3GPP TS 36.323 clause 5.9.

[TS 36.323, clause 5.4]

When the Discard_Timer expires for a PDCP SDU, or the successful delivery of a PDCP SDU is confirmed by PDCP status report, the UE shall discard the PDCP SDU along with the corresponding PDCP PDU. If the corresponding PDCP PDU has already been submitted to lower layers the discard is indicated to lower layers.

7.3.6.1.3 Test description

7.3.6.1.3.1 Pre-test conditions

System Simulator:

- Cell 1

UE:

None.

Preamble

- The UE is in state Loopback Activated (state 4) according to [18 with the exceptions listed in table 7.3.6.1.3.1-1 applicable for the configured UM DRB and table 7.3.6.1.3.1-2 for SR configuration.
- The condition SRB2-DRB(1,1) is used for step 8 in 4.5.3A.3 according to [18].

Table 7.3.6.1.3.1-1: PDCP Settings

Parameter	Value
Discard_Timer	500 ms

Table 7.3.6.1.3.1-2: SchedulingRequest-Config (preamble Table 4.5.3.3-1: Step8)

Derivation Path: 36.508 Table 4.6.3-20			
Information Element	Value/remark	Comment	Condition
dssr-TransMax	n64		

7.3.6.1.3.2 Test procedure sequence

Table 7.3.6.1.3.2-1: Main behaviour

St	Procedure	Message Sequence		TP	Verdict
		U - S	Message		
1	The SS creates 5 PDCP Data PDUs and the Next_PDCP_TX_SN is set to "0".	-		-	-
2	The SS ignores scheduling requests and does not allocate any uplink grant.	-	-	-	-
	EXCEPTION: Step 3 shall be repeated for k=0 to 2 (increment=1).				
3	The SS sends a PDCP Data PDU via RLC-UM RB with the following content to the UE: D/C field = 1 (PDCP Data PDU) and PDCP SN = k After having sent a PDU, the SS sets Next_PDCP_TX_SN = k+1.	<--	PDCP DATA PDU (SN=k)	-	-
4	Wait for Discard_Timer Note: According to TS36.508, timer tolerance should be 10% of Discard_Timer or 5 x RTT, whichever is greater. RTT = 8 TTIs for FDD and RTT = 16 TTIs for TDD	-	-	-	-
	EXCEPTION: Step 5 shall be repeated for k=3 to 4 (increment=1).				
5	The SS sends a PDCP Data PDU via RLC-UM RB with the following content to the UE: D/C field = 1 (PDCP Data PDU) and PDCP SN = k After having sent a PDU, the SS set Next_PDCP_TX_SN = k+1.	<--	PDCP DATA PDU (SN=k)	-	-
6	The SS resumes normal UL grant allocation.	-		-	-
7	Check: Does UE transmit a PDCP Data PDU with PDCP SN = 3?	-->	PDCP Data PDU (SN = 3)	1	P
8	Check: Does UE transmit a PDCP Data PDU with PDCP SN = 4?	-->	PDCP Data PDU (SN = 4)	1	P

7.3.6.1.3.3 Specific message contents

None.

8 RRC

8.1 RRC connection management procedures

8.1.1 Paging

8.1.1.1 RRC / Paging for connection in idle mode

8.1.1.1.1 Test Purpose (TP)

(1)

```
with { UE in E-UTRA RRC_IDLE state }
ensure that {
  when { UE receives a Paging message including an ue-Identity set an unmatched S-TMSI i.e. other
than the one allocated to the UE at the UE registration procedure }
  then { UE does not establish an RRC connection }
}
```

(2)

```
with { UE in E-UTRA RRC_IDLE state }
ensure that {
  when { UE receives a Paging message including an ue-Identity set to the S-TMSI which was allocated
to the UE at the UE registration procedure }
  then { UE establishes an RRC connection }
}
```

8.1.1.1.2 Conformance requirements

References: The conformance requirements covered in the present TC are specified in: TS 36.331, clause 5.3.2.3, 5.3.3.2, 5.3.3.3 and 5.3.3.4.

[TS 36.331, clause 5.3.2.3]

Upon receiving the *Paging* message, the UE shall:

- 1> if in RRC_IDLE, for each of the *PagingRecord*, if any, included in the *Paging* message:
 - 2> if the *ue-Identity* included in the *PagingRecord* matches one of the UE identities allocated by upper layers:
 - 3> forward the *ue-Identity*, and the *cn-Domain* to the upper layers.

...

[TS 36.331, clause 5.3.3.2]

The UE initiates the procedure when upper layers request establishment of an RRC connection while the UE is in RRC_IDLE.

Upon initiation of the procedure, the UE shall:

...

- 1> if access to the cell, as specified above, is not barred:
 - 2> apply the default physical channel configuration as specified in 9.2.4;
 - 2> apply the default semi-persistent scheduling configuration as specified in 9.2.3;
 - 2> apply the default MAC main configuration as specified in 9.2.2;
 - 2> apply the CCCH configuration as specified in 9.1.1.2;
 - 2> apply the *timeAlignmentTimerCommon* included in *SystemInfoBlockType2*;

2> start timer T300;

2> initiate transmission of the *RRCConnectionRequest* message in accordance with 5.3.3.3;

NOTE 2: Upon initiating the connection establishment procedure, the UE is not required to ensure it maintains up to date system information applicable only for UEs in RRC_IDLE state. However, the UE needs to perform system information acquisition upon cell re-selection.

...

[TS 36.331, clause 5.3.3.3]

The UE shall set the contents of *RRCConnectionRequest* message as follows:

1> set the *ue-Identity* as follows:

2> if upper layers provide an S-TMSI:

3> set the *ue-Identity* to the value received from upper layers;

2> else:

3> draw a random value in the range $0 \dots 2^{40}-1$ and set the *ue-Identity* to this value;

NOTE 1: Upper layers provide the S-TMSI if the UE is registered in the TA of the current cell.

1> set the *establishmentCause* in accordance with the information received from upper layers;

The UE shall submit the *RRCConnectionRequest* message to lower layers for transmission.

The UE shall continue cell re-selection related measurements as well as cell re-selection evaluation. If the conditions for cell re-selection are fulfilled, the UE shall perform cell re-selection as specified in 5.3.3.5.

[TS 36.331, clause 5.3.3.4]

NOTE: Prior to this, lower layer signalling is used to allocate a C-RNTI. For further details see TS 36.321 [6];

The UE shall:

1> perform the radio resource configuration procedure in accordance with the received *radioResourceConfigDedicated* and as specified in 5.3.10;

1> if stored, discard the cell reselection priority information provided by the *idleModeMobilityControlInfo* or inherited from another RAT;

1> stop timer T300;

1> stop timer T302, if running;

1> stop timer T303, if running;

1> stop timer T305, if running;

1> perform the actions as specified in 5.3.3.7;

1> stop timer T320, if running;

1> enter RRC_CONNECTED;

1> stop the cell re-selection procedure;

1> set the content of *RRCConnectionSetupComplete* message as follows:

2> set the *selectedPLMN-Identity* to the PLMN selected by upper layers (see TS 23.122 [11], TS 24.301 [35]) from the PLMN(s) included in the *plmn-IdentityList* in *SystemInformationBlockType1*;

2> if upper layers provide the 'Registered MME', include and set the *registeredMME* as follows:

3> if the PLMN identity of the 'Registered MME' is different from the PLMN selected by the upper layers:

4> include the *plmnIdentity* in the *registeredMME* and set it to the value of the PLMN identity in the 'Registered MME' received from upper layers;

3> set the *mmegi* and the *mmec* to the value received from upper layers;

2> set the *dedicatedInfoNAS* to include the information received from upper layers;

2> submit the *RRCConnectionSetupComplete* message to lower layers for transmission, upon which the procedure ends.

8.1.1.1.3 Test description

8.1.1.1.3.1 Pre-test conditions

System Simulator:

- Cell 1.

UE:

None.

Preamble:

- The UE is in state Registered, Idle mode (state 2) according to [18].

8.1.1.1.3.2 Test procedure sequence

Table 8.1.1.1.3.2-1: Main behaviour

St	Procedure	Message Sequence		TP	Verdict
		U - S	Message		
1	The SS transmits a <i>Paging</i> message including an unmatched identity (incorrect S-TMSI).	<--	<i>Paging</i>	-	-
2	Check: Does the UE transmit an <i>RRCConnectionRequest</i> message within 5 s?	-->	<i>RRCConnectionRequest</i>	1	F
3	The SS transmits a <i>Paging</i> message including a matched identity.	<--	<i>Paging</i>	-	-
4	Check: Does the UE transmit an <i>RRCConnectionRequest</i> message?	-->	<i>RRCConnectionRequest</i>	2	P
5	The SS transmits an <i>RRCConnectionSetup</i> message.	<--	<i>RRCConnectionSetup</i>	-	-
6	Check: Does the UE transmit an <i>RRCConnectionSetupComplete</i> message including SERVICE REQUEST to confirm the successful completion of the connection establishment?	-->	<i>RRCConnectionSetupComplete</i>	2	P
6A-6D	Steps 6 to 9 of the generic radio bearer establishment procedure (TS 36.508 4.5.3.3-1) are executed to successfully complete the service request procedure.	-	-	-	-
7	Check: Does the test result of generic test procedure in TS 36.508 subclause 6.4.2.3 indicate that the UE is in E-UTRA RRC_CONNECTED state on Cell 1?	-	-	1, 2	-

8.1.1.1.3.3 Specific message contents

Table 8.1.1.1.3.3-1: Paging (step 1, Table 8.1.1.1.3.2-1)

Derivation Path: 36.508 Table 4.6.1-7			
Information Element	Value/remark	Comment	Condition
Paging ::= SEQUENCE {			
pagingRecordList SEQUENCE (SIZE (1..maxPageRec)) OF SEQUENCE {	1 entry		
ue-Identity[1] CHOICE {			
s-TMSI SEQUENCE {			
mmec	Set to the different value from the S-TMSI of the UE		
m-TMSI	Set to the different value from the S-TMSI of the UE		
}			
}			
}			
}			

Table 8.1.1.1.3.3-2: RRCConnectionRequest (step 4, Table 8.1.1.1.3.2-1)

Derivation Path: 36.508 Table 4.6.1-16			
Information Element	Value/remark	Comment	Condition
RRCConnectionRequest ::= SEQUENCE {			
criticalExtensions CHOICE {			
rrcConnectionRequest-r8 SEQUENCE {			
establishmentCause	mt-Access		
}			
}			
}			

8.1.1.2 RRC / Paging for notification of BCCH modification in idle mode

8.1.1.2.1 Test Purpose (TP)

(1)

```

with { UE in E-UTRA RRC_IDLE state }
ensure that {
  when { UE receives a Paging message including a systemInfoModification }
    then { UE re-acquires and applies the new system information about the correct prach-ConfigIndex
in random access }
}

```

8.1.1.2.2 Conformance requirements

References: The conformance requirements covered in the present TC are specified in: TS 36.331, clause 5.3.2.3, 5.2.2.3, and 5.2.2.4.

[TS 36.331, clause 5.3.2.3]

Upon receiving the *Paging* message, the UE shall:

- 1> if in RRC_IDLE, for each of the *PagingRecord*, if any included in the *Paging* message:
 - 2> if the *ue-Identity* included in the *PagingRecord* matches one of the UE identities allocated by upper layers:
 - 3> forward the *ue-Identity* and the *cn-Domain* to the upper layers;
- 1> if the *systemInfoModification* is included:

- 2> re-acquire the required system information using the system information acquisition procedure as specified in 5.2.2.

...

[TS 36.331, clause 5.2.2.3]

The UE shall:

- 1> ensure having a valid version, as defined below, of (at least) the following system information, also referred to as the 'required' system information:
 - 2> if in RRC_IDLE:
 - 3> the *MasterInformationBlock* and *SystemInformationBlockType1* as well as *SystemInformationBlockType2* through *SystemInformationBlockType8*, depending on support of the concerned RATs;

...

[TS 36.331, clause 5.2.2.4]

The UE shall:

- 1> apply the specified BCCH configuration defined in 9.1.1.1;
- 1> if the procedure is triggered by a system information change notification:
 - 2> start acquiring the required system information, as defined in 5.2.2.3, from the beginning of the modification period following the one in which the change notification was received;

...

The UE may apply the received SIBs immediately, i.e. the UE does not need to delay using a SIB until all SI messages have been received. The UE may delay applying the received SIBs until completing lower layer procedures associated with a received or a UE originated RRC message, e.g. an ongoing random access procedure.

NOTE 3: While attempting to acquire a particular SIB, if the UE detects from *schedulingInfoList* that it is no longer present, the UE should stop trying to acquire the particular SIB.

8.1.1.2.3 Test description

8.1.1.2.3.1 Pre-test conditions

System Simulator:

- Cell 1.

UE:

None.

Preamble:

- The UE is in state Registered, Idle mode (state 2) according to [18].

8.1.1.2.3.2 Test procedure sequence

Table 8.1.1.2.3.2-1: Main behaviour

St	Procedure	Message Sequence		TP	Verdict
		U - S	Message		
1	The SS transmits a <i>Paging</i> message including a matched identity.	<--	<i>Paging</i>	-	-
2	Check: Does the UE transmit an <i>RRCCONNECTIONREQUEST</i> message?	-->	<i>RRCCONNECTIONREQUEST</i>	1	P
3	The SS transmits an <i>RRCCONNECTIONSETUP</i> message.	<--	<i>RRCCONNECTIONSETUP</i>	-	-
3A	The UE transmits an <i>RRCCONNECTIONSETUPCOMPLETE</i> message. This message includes a SERVICE REQUEST message.	-->	<i>RRCCONNECTIONSETUPCOMPLETE</i>	-	-
3B	The SS transmits a <i>SecurityModeCommand</i> message.	<--	<i>SecurityModeCommand</i>	-	-
3C	The UE transmits a <i>SecurityModeComplete</i> message.	-->	<i>SecurityModeComplete</i>	-	-
3D	The SS transmits an <i>RRCCONNECTIONRECONFIGURATION</i> message.	<--	<i>RRCCONNECTIONRECONFIGURATION</i>	-	-
3E	The UE transmits an <i>RRCCONNECTIONRECONFIGURATIONCOMPLETE</i> message.	-->	<i>RRCCONNECTIONRECONFIGURATIONCOMPLETE</i>	-	-
3F	The SS transmits an <i>RRCCONNECTIONRELEASE</i> message.	<--	<i>RRCCONNECTIONRELEASE</i>	-	-
3G	Wait for 5 s for the UE to enter E-UTRA RRC_IDLE state.	-	-	-	-
4	The SS changes the <i>prach-ConfigIndex</i> in the system information	-	-	-	-
5	The SS transmits a <i>Paging</i> message including a <i>systemInfoModification</i> .	<--	<i>Paging</i>	-	-
6	Wait for 15s for the UE to receive system information.	-	-	-	-
7	The SS transmits a <i>Paging</i> message including a matched identity.	<--	<i>Paging</i>	-	-
7A	Check: Does the UE re-transmit a random access using <i>prach-ConfigIndex</i> given in step 4?	-	-	1	P
8	The UE transmit an <i>RRCCONNECTIONREQUEST</i> message.	-->	<i>RRCCONNECTIONREQUEST</i>	-	-
9	The SS transmits an <i>RRCCONNECTIONSETUP</i> message.	<--	<i>RRCCONNECTIONSETUP</i>	-	-
9A	The UE transmits an <i>RRCCONNECTIONSETUPCOMPLETE</i> message. This message includes a SERVICE REQUEST message.	-->	<i>RRCCONNECTIONSETUPCOMPLETE</i>	-	-
9B	The SS transmits a <i>SecurityModeCommand</i> message.	<--	<i>SecurityModeCommand</i>	-	-
9C	The UE transmits a <i>SecurityModeComplete</i> message.	-->	<i>SecurityModeComplete</i>	-	-
9D	The SS transmits an <i>RRCCONNECTIONRECONFIGURATION</i> message.	<--	<i>RRCCONNECTIONRECONFIGURATION</i>	-	-
9E	The UE transmits an <i>RRCCONNECTIONRECONFIGURATIONCOMPLETE</i> message.	-->	<i>RRCCONNECTIONRECONFIGURATIONCOMPLETE</i>	-	-
9F	The SS transmits an <i>RRCCONNECTIONRELEASE</i> message.	<--	<i>RRCCONNECTIONRELEASE</i>	-	-
9G	Wait for 5 s for the UE to enter E-UTRA RRC_IDLE state.	-	-	-	-
10	Check: Does the test result of generic test procedure in TS 36.508 subclause 6.4.2.2 indicate that the UE is in E-UTRA RRC_IDLE state on Cell 1?	-	-	1	-

8.1.1.2.3.3 Specific message contents

Table 8.1.1.2.3.3-1: RRCConnectionRequest (step 2 and step 8, Table 8.1.1.2.3.2-1)

Derivation Path: 36.508 Table 4.6.1-16			
Information Element	Value/remark	Comment	Condition
RRCConnectionRequest ::= SEQUENCE {			
criticalExtensions CHOICE {			
rrcConnectionRequest-r8 SEQUENCE {			
establishmentCause	mt-Access		
}			
}			
}			

Table 8.1.1.2.3.3-2A: RRCConnectionReconfiguration (step 3D and step 9D, Table 8.1.1.2.3.2-1)

Derivation Path: 36.508 Table 4.6.1-8, condition SRB2-DRB(1, 0)

Table 8.1.1.2.3.3-2: Paging (step 5, Table 8.1.1.2.3.2-1)

Derivation Path: 36.508 Table 4.6.1-7			
Information Element	Value/remark	Comment	Condition
Paging ::= SEQUENCE {			
pagingRecordList	Not present		
systemInfoModification	true		
}			

Table 8.1.1.2.3.3-2A: SystemInformationBlockType1 (step 6, table 8.1.1.2.3.2-1)

Derivation path: 36.508 Table 4.4.3.2-3			
Information Element	Value/Remark	Comment	Condition
SystemInformationBlockType1 ::= SEQUENCE {			
systemInfoValueTag	1	Default value is 0	
}			

Table 8.1.1.2.3.3-3: SystemInformationBlockType2 (step 6, Table 8.1.1.2.3.2-1)

Derivation Path: 36.508 Table 4.4.3.3-1			
Information Element	Value/remark	Comment	Condition
SystemInformationBlockType2 ::= SEQUENCE {			
radioResourceConfigCommon SEQUENCE {			
prach-Config SEQUENCE {			
prach-ConfigInfo SEQUENCE {			
prach-ConfigIndex	5		FDD
prach-ConfigIndex	52	Set to index which denote subframe numbers different from the default one.	TDD
}			
}			
}			
}			

Condition	Explanation
FDD	FDD cell environment
TDD	TDD cell environment

8.1.1.3 RRC / Paging for connection in idle mode / Multiple paging records

8.1.1.3.1 Test Purpose (TP)

(1)

```
with { UE in E-UTRA RRC_IDLE state }
ensure that {
  when { UE receives a Paging message including only unmatched identities }
  then { UE does not establish any RRC connection }
}
```

(2)

```
with { UE in E-UTRA RRC_IDLE state }
ensure that {
  when { UE receives a Paging message including any matched identity }
  then { UE establishes an RRC connection }
}
```

8.1.1.3.2 Conformance requirements

References: The conformance requirements covered in the present TC are specified in: TS 36.331, clause 5.3.2.3, 5.3.3.2, 5.3.3.3 and 5.3.3.4.

[TS 36.331, clause 5.3.2.3]

Upon receiving the *Paging* message, the UE shall

- 1> If in RRC_IDLE, for each of the *Paging* records included in the *Paging* message:
 - 2> If the *ue-identity* included in the *pagingRecordList* matches one of the UE identities allocated by upper layers:
 - 3> forward the *ue-Identity*, the *cn-Domain* and the *pagingCause* to the upper layers.

...

[TS 36.331, clause 5.3.3.2]

The UE initiates the procedure when upper layers request establishment of an RRC connection while the UE is in RRC_IDLE state.

Upon initiation of the procedure, the UE shall:

...

- 1> If access to the cell, as specified above, is not barred:
 - 2> apply the default configuration applicable for the *antennaInformation* as specified in 9.2.3, until explicitly receiving a configuration;
 - 2> start timer T300;
 - 2> initiate transmission of the *RRCConnectionRequest* message in accordance with 5.3.3.3;

NOTE 2: Upon initiating the connection establishment procedure, the UE is not required to ensure it maintains up to date system information applicable only for UEs in RRC_IDLE state. However, the UE needs to perform system information acquisition upon re-selection.

...

[TS 36.331, clause 5.3.3.3]

The UE shall set the contents of *RRCConnectionRequest* message as follows:

- 1> set the IE *ue-Identity* as follows:
 - 2> if upper layers provide an S-TMSI:

3> set the *ue-Identity* to the value received from upper layers;

2> else

3> draw a random value and set the *ue-Identity* to this value;

NOTE 1 Upper layers provide the S-TMSI if the UE is registered in the TA of the current cell.

1> Set the *establishmentCause* in accordance with the information received from upper layers;

The UE shall submit the *RRCConnectionRequest* message to lower layers for transmission.

The UE shall continue cell re-selection related measurements as well as cell re-selection evaluation. If the conditions for cell re-selection are fulfilled, the UE shall perform cell re-selection as specified in 5.3.3.5.

[TS 36.331, clause 5.3.3.4]

NOTE: Prior to this, lower layers allocate a C-RNTI. For further details see TS 36.321 [6];

The UE shall:

1> establish SRB1 in accordance with the received *radioResourceConfiguration* and as specified in 5.3.10;

1> if stored, discard the Inter-frequency priority information and the Inter-RAT priority information provided via dedicated signalling using the IE *idleModeMobilityControlInfo*;

1> stop timer T300;

1> stop timer T302, if running;

1> stop timer T303, if running;

1> stop timer T305, if running;

1> stop timer T320, if running;

1> enter RRC_CONNECTED state;

1> stop the cell re-selection procedure;

1> set the content of *RRCConnectionSetupComplete* message as follows:

2> set the *selectedPLMN-Identity* to the PLMN selected by upper layers [TS 23.122, TS 24.008] from the PLMN(s) included in the *plmn-IdentityList* broadcast, within *SystemInformationBlockType1*, in the cell where the RRC connection was established;

2> if upper layers provide the 'Registered MME', set the *registeredMME* as follows:

3> if the PLMN identity of the 'Registered MME' is different from the PLMN selected by the upper layers, set the IE *plmnIdentity* to the value received from upper layers;

3> set the IEs *mmegi* and *mmec* to the value received from upper layers;

2> set the *nas-DedicatedInformation* to include the information received from upper layers;

2> submit the *RRCConnectionSetupComplete* message to lower layers for transmission, upon which the procedure ends.

8.1.1.3.3 Test description

8.1.1.3.3.1 Pre-test conditions

System Simulator:

- Cell 1

UE:

None.

Preamble:

- The UE is in state Registered, Idle mode (state 2) according to [18].

8.1.1.3.3.2 Test procedure sequence

Table 8.1.1.3.3.2-1: Main behaviour

St	Procedure	Message Sequence		TP	Verdict
		U - S	Message		
1	The SS transmits a <i>Paging</i> message including only unmatched identities (incorrect S-TMSI).	<--	<i>Paging</i>	1	-
2	Check: Does the UE transmit an <i>RRCCONNECTIONREQUEST</i> message within 10s?	-->	<i>RRCCONNECTIONREQUEST</i>	1	F
3	The SS transmits a <i>Paging</i> message including two unmatched identities and a matched identity.	<--	<i>Paging</i>	2	-
4	Check: Does the UE transmit an <i>RRCCONNECTIONREQUEST</i> message?	-->	<i>RRCCONNECTIONREQUEST</i>	2	P
5	The SS transmits an <i>RRCCONNECTIONSETUP</i> message.	<--	<i>RRCCONNECTIONSETUP</i>	-	-
6	The UE transmits an <i>RRCCONNECTIONSETUPCOMPLETE</i> message including SERVICE REQUEST to confirm the successful completion of the connection establishment.	-->	<i>RRCCONNECTIONSETUPCOMPLETE</i>	-	-
6A-6D	Steps 6 to 9 of the generic radio bearer establishment procedure in TS 36.508 subclause 4.5.3.3 are executed to successfully complete the service request procedure.	-	-	-	-
7	Check: Does the test result of generic test procedure in TS 36.508 subclause 6.4.2.3 indicate that the UE is in E-UTRA RRC_CONNECTED state on Cell 1?	-	-	1,2	-

8.1.1.3.3.3 Specific message contents

Table 8.1.1.3.3.3-1: Paging (step 1, Table 8.1.1.3.3.2-1)

Derivation Path: 36.508 Table 4.6.1-7			
Information Element	Value/remark	Comment	Condition
Paging ::= SEQUENCE {			
pagingRecordList SEQUENCE (SIZE (1..maxPageRec)) OF SEQUENCE {	3 entries		
ue-Identity[1] CHOICE {			
s-TMSI	Set to the different value from the S-TMSI of the UE		
}			
cn-Domain [1]	ps		
ue-Identity[2] CHOICE {			
s-TMSI	Set to the different value from the S-TMSI of the UE		
}			
cn-Domain [2]	ps		
ue-Identity[3] CHOICE {			
s-TMSI	Set to the different value from the S-TMSI of the UE		
}			
cn-Domain [3]	ps		
}			
}			

Table 8.1.1.3.3.3-2: Paging (step 3, Table 8.1.1.3.3.2-1)

Derivation Path: 36.508 Table 4.6.1-7			
Information Element	Value/remark	Comment	Condition
Paging ::= SEQUENCE {			
pagingRecordList SEQUENCE (SIZE (1..maxPageRec)) OF SEQUENCE {	3 entries		
ue-Identity[1] CHOICE {			
s-TMSI	Set to the different value from the S-TMSI of the UE		
}			
cn-Domain [1]	ps		
ue-Identity[2] CHOICE {			
s-TMSI	Set to the different value from the S-TMSI of the UE		
}			
cn-Domain [2]	ps		
ue-Identity[3] CHOICE {			
s-TMSI	Set to the value of the S-TMSI of the UE		
}			
cn-Domain [3]	ps		
}			
}			

Table 8.1.1.3.3.3-3: *RRCCONNECTIONREQUEST* (step 4, Table 8.1.1.3.3.2-1)

Derivation Path: 36.508 Table 4.6.1-16			
Information Element	Value/remark	Comment	Condition
RRCCONNECTIONREQUEST ::= SEQUENCE {			
criticalExtensions CHOICE {			
rrcConnectionRequest-r8 SEQUENCE {			
establishmentCause	mt-Access		
}			
}			
}			

8.1.1.4 RRC / Paging for connection in idle mode / Shared network environment

8.1.1.4.1 Test Purpose (TP)

(1)

```

with { UE in E-UTRA RRC_IDLE state having been registered in the TA of the current cell which has
broadcasted a SystemInformationBlockType1 message including multiple PLMN identities }
ensure that {
  when { UE receives a Paging message including an IE ue-Identity set to the S-TMSI which was
allocated to the UE at the UE registration procedure }
    then { UE establishes an RRC connection }
}

```

8.1.1.4.2 Conformance requirements

References: The conformance requirements covered in the present TC are specified in: TS 36.331, clause 5.3.2.3, 5.3.3.2, 5.3.3.3 and 5.3.3.4.

[TS 36.331, clause 5.3.2.3]

Upon receiving the *Paging* message, the UE shall:

- 1> if in RRC_IDLE, for each of the *PagingRecord*, if any, included in the *Paging* message:
 - 2> if the *ue-Identity* included in the *PagingRecord* matches one of the UE identities allocated by upper layers:
 - 3> forward the *ue-Identity* and the *cn-Domain* to the upper layers.

...

[TS 36.331, clause 5.3.3.2]

The UE initiates the procedure when upper layers request establishment of an RRC connection while the UE is in RRC_IDLE.

Upon initiation of the procedure, the UE shall:

...

- 1> if access to the cell, as specified above, is not barred:
 - 2> apply the default physical channel configuration as specified in 9.2.4;
 - 2> apply the default semi-persistent scheduling configuration as specified in 9.2.3;
 - 2> apply the default MAC main configuration as specified in 9.2.2;
 - 2> apply the CCCH configuration as specified in 9.1.1.2;
 - 2> apply the timeAlignmentTimerCommon included in SystemInformationBlockType2;
 - 2> start timer T300
 - 2> initiate transmission of the *RRCCONNECTIONREQUEST* message in accordance with 5.3.3.3;

NOTE 2: Upon initiating the connection establishment procedure, the UE is not required to ensure it maintains up to date system information applicable only for UEs in RRC_IDLE state. However, the UE needs to perform system information acquisition upon cell re-selection.

...

[TS 36.331, clause 5.3.3.3]

The UE shall set the contents of *RRCCConnectionRequest* message as follows:

- 1> set the *ue-Identity* as follows:
 - 2> if upper layers provide an S-TMSI:
 - 3> set the *ue-Identity* to the value received from upper layers;
 - 2> else
 - 3> draw a random value in the range $0 \dots 2^{40}-1$ and set the *ue-Identity* to this value;

NOTE 1 Upper layers provide the S-TMSI if the UE is registered in the TA of the current cell.

- 1> set the *establishmentCause* in accordance with the information received from upper layers;

The UE shall submit the *RRCCConnectionRequest* message to lower layers for transmission.

The UE shall continue cell re-selection related measurements as well as cell re-selection evaluation. If the conditions for cell re-selection are fulfilled, the UE shall perform cell re-selection as specified in 5.3.3.5.

[TS 36.331, clause 5.3.3.4]

NOTE: Prior to this, lower layer signalling is used to allocate a C-RNTI. For further details see TS 36.321 [6];

The UE shall:

- 1> perform the radio resource configuration procedure in accordance with the received *radioResourceConfigDedicated* and as specified in 5.3.10;
- 1> if stored, discard the cell reselection priority information provided by the *idleModeMobilityControlInfo* or inherited from another RAT;
- 1> stop timer T300;
- 1> stop timer T302, if running;
- 1> stop timer T303, if running;
- 1> stop timer T305, if running;
- 1> perform the actions as specified in 5.3.3.7;
- 1> stop timer T320, if running;
- 1> enter RRC_CONNECTED;
- 1> stop the cell re-selection procedure;
- 1> set the content of *RRCCConnectionSetupComplete* message as follows:
 - 2> set the *selectedPLMN-Identity* to the PLMN selected by upper layers (see TS 23.122 [11], TS 24.301 [35]) from the PLMN(s) included in the *plmn-IdentityList* in *SystemInformationBlockType1*;
 - 2> if upper layers provide the 'Registered MME', include and set the *registeredMME* as follows:
 - 3> if the PLMN identity of the 'Registered MME' is different from the PLMN selected by the upper layers;
 - 4> include the *plmnIdentity* in the *registeredMME* and set it to the value of the PLMN identity in the 'Registered MME' received from upper layers;

- 3> set the *mmegi* and the *mmec* to the value received from upper layers;
- 2> set the *dedicatedInfoNAS* to include the information received from upper layers;
- 2> submit the *RRCConnectionSetupComplete* message to lower layers for transmission, upon which the procedure ends.

8.1.1.4.3 Test description

8.1.1.4.3.1 Pre-test conditions

System Simulator:

- Cell 1

UE:

None.

Preamble:

- The UE is in state Registered, Idle mode (state 2) according to [18].

8.1.1.4.3.2 Test procedure sequence

Table 8.1.1.4.3.2-1: Main behaviour

St	Procedure	Message Sequence		TP	Verdict
		U - S	Message		
1	The SS transmits a <i>Paging</i> message including a matched identity.	<--	<i>Paging</i>	-	-
2	Check: Does the UE transmit an <i>RRCConnectionRequest</i> message?	-->	<i>RRCConnectionRequest</i>	1	P
3	The SS transmit an <i>RRCConnectionSetup</i> message.	<--	<i>RRCConnectionSetup</i>	-	-
4	Check: Does the UE transmit an <i>RRCConnectionSetupComplete</i> message including SERVICE REQUEST and an IE <i>selectedPLMN-Identity</i> corresponding to the PLMN on which the UE has been registered to confirm the successful completion of the connection establishment?	-->	<i>RRCConnectionSetupComplete</i>	1	P
4A-4D	Steps 6 to 9 of the generic radio bearer establishment procedure (TS 36.508 4.5.3.3-1) are executed to successfully complete the service request procedure.	-	-	-	-
5	Check: Does the test result of generic test procedure in TS 36.508 subclause 6.4.2.3 indicate that the UE is in E-UTRA RRC_CONNECTED state on Cell 1?	-	-	1	-

8.1.1.4.3.3 Specific message contents

Table 8.1.1.4.3.3-1: SystemInformationBlockType1 (all steps, Table 8.1.1.4.3.2-1)

Derivation Path: 36.508 Table 4.4.3.2-3			
Information Element	Value/remark	Comment	Condition
SystemInformationBlockType1 ::= SEQUENCE {			
cellAccessRelatedInformation SEQUENCE {			
plmn-IdentityList SEQUENCE (SIZE (1..6)) OF SEQUENCE {	2 entries		
plmn-Identity[1] SEQUENCE {			
mcc	See Table 8.1.1.4.3.3-1A		
mnc	See Table 8.1.1.4.3.3-1A		
}			
cellReservedForOperatorUse[1]	notReserved		
plmn-Identity[2] SEQUENCE {			
mcc	See Table 8.1.1.4.3.3-1A		
mnc	See Table 8.1.1.4.3.3-1A		
}			
cellReservedForOperatorUse[2]	notReserved		
}			
}			

The PLMN Identity list broadcasted on the BCCH in Cell 1 shall be configured as defined in the table below.

Table 8.1.1.4.3.3-1A: PLMN Identity List broadcasted for Cell 1

Cell	PLMN Identity (1)		PLMN Identity (2)	
	MCC digits	MNC digits	MCC digits	MNC digits
1	PLMN 1	PLMN 1	PLMN 2	PLMN 2

The definition of each PLMN code is found in table below.

PLMN	MCC digit			MNC digit		
	1	2	3	1	2	3
1	(NOTE 2)			(NOTE 2)		
2	(NOTE 3)			0	2	-

NOTE 1: “-” (dash) denotes “not present”

NOTE 2: Set to the same Mobile Country Code and Mobile Network Code stored in EF_{IMSI} on the test USIM card for PLMN 1.

NOTE 3: Set to the same Mobile Country Code stored in EF_{IMSI} on the test USIM card for PLMN 2.

Table 8.1.1.4.3.3-2: RRCConnectionRequest (step 2, Table 8.1.1.4.3.2-1)

Derivation Path: 36.508 Table 4.6.1-15			
Information Element	Value/remark	Comment	Condition
RRCConnectionRequest ::= SEQUENCE {			
criticalExtensions CHOICE {			
rrcConnectionRequest-r8 SEQUENCE {			
establishmentCause	mt-Access		
}			
}			
}			

Table 8.1.1.4.3.3-3: *RRCConnectionSetupComplete* (step 4, Table 8.1.1.4.3.2-1)

Derivation Path: 36.508, Table 4.6.1-17			
Information Element	Value/remark	Comment	Condition
RRCConnectionSetupComplete ::= SEQUENCE {			
criticalExtensions CHOICE {			
c1 CHOICE{			
rrcConnectionSetupComplete-r8 SEQUENCE {			
selectedPLMN-Identity	Set to the PLMN selected by upper layers		
}			
}			
}			
}			

8.1.1.5 Void

8.1.1.6 RRC / BCCH modification in connected mode

8.1.1.6.1 Test Purpose (TP)

```
with { the UE is in E-UTRA RRC_CONNECTED }
ensure that {
  when { the UE receives a Paging message including the systemInfoModification }
  then { the UE re-acquires the MasterInformationBlock, SystemInformationBlockType1 and
SystemInformationBlockType2 }
```

8.1.1.6.2 Conformance requirements

References: The conformance requirements covered in the present test case are specified in: TS 36.331 clauses 5.3.2.3, 5.2.2.3 and 5.2.2.4.

[TS 36.331, clause 5.3.2.3]

Upon receiving the *Paging* message, the UE shall:

...

1> if the *systemInfoModification* is included:

2> re-acquire the required system information using the system information acquisition procedure as specified in 5.2.2.

...

[TS 36.331, clause 5.2.2.3]

The UE shall:

1> ensure having a valid version, as defined below, of (at least) the following system information, also referred to as the 'required' system information:

...

2> if in RRC_CONNECTED:

3> the *MasterInformationBlock*, *SystemInformationBlockType1* and *SystemInformationBlockType2* as well as *SystemInformationBlockType8*, depending on support of CDMA2000;

...

[TS 36.331, clause 5.2.2.4]

The UE shall:

1> apply the specified BCCH configuration defined in 9.1.1.1;

1> if the procedure is triggered by a system information change notification:

2> start acquiring the required system information, as defined in 5.2.2.3, from the beginning of the modification period following the one in which the change notification was received;

NOTE 1: The UE continues using the previously received system information until the new system information has been acquired.

...

The UE may apply the received SIBs immediately, i.e. the UE does not need to delay using a SIB until all SI messages have been received. The UE may delay applying the received SIBs until completing lower layer procedures associated with a received or a UE originated RRC message, e.g. an ongoing random access procedure.

NOTE 2: While attempting to acquire a particular SIB, if the UE detects from *schedulingInfoList* that it is no longer present, the UE should stop trying to acquire the particular SIB.

8.1.1.6.3 Test description

8.1.1.6.3.1 Pre-test conditions

System Simulator:

- Cell 1.

UE:

None.

Preamble:

- The UE is in state Generic RB Established (state 3) according to [18], and using the condition *no_periodic_BSR_or_PHR*.

8.1.1.6.3.2 Test procedure sequence

Table 8.1.1.6.3.2-1: Main behaviour

St	Procedure	Message Sequence		TP	Verdict
		U - S	Message		
1	The SS transmits a <i>Paging</i> message paging occasion including a <i>systemInfoModification</i> .	<--	<i>Paging</i>	-	-
2	From the beginning of the next modification period the SS transmits a modified <i>SystemInformationBlockType1</i> and <i>SystemInformationBlockType2</i> as specified.	-	-	-	-
3	During the first on duration period after the end of the modification period where <i>SystemInformationBlockType2</i> was modified (see step 2), the SS transmits a PDCCH order including a dedicated preamble.	-	-	-	-
4	Check: Does the UE initiate a random access procedure using <i>prach-ConfigIndex</i> given in step 2 (i.e. for FDD in subframe number 7 and for TDD in subframe number 6)?	-	-	1	P
5	The SS transmits Random Access Response with RAPID corresponding to preamble in steps 3 and 4.	-	-	-	-

8.1.1.6.3.3 Specific message contents

Table 8.1.1.6.3.3-1: RRCConnectionReconfiguration (preamble, step 8, TS 36.508 table 4.5.3.3-1)

Derivation path: 36.508 table 4.6.1-8			
Information Element	Value/Remark	Comment	Condition
RRCConnectionReconfiguration ::= SEQUENCE {			
criticalExtensions CHOICE {			
c1 CHOICE {			
rrcConnectionReconfiguration-r8 {			
radioResourceConfigDedicated {			
mac-MainConfig {			
explicitValue {			
drx-Config	Not present		
}			
}			
}			
}			
}			
}			
}			

Table 8.1.1.6.3.3-2: SystemInformationBlockType1 (step 2, table 8.1.1.6.3.2-1)

Derivation path: 36.508 Table 4.4.3.2-3			
Information Element	Value/Remark	Comment	Condition
SystemInformationBlockType1 ::= SEQUENCE {			
systemInfoValueTag	1	Default value is 0	
}			

Table 8.1.1.6.3.3-3: SystemInformationBlockType2 (step 2, table 8.1.1.6.3.2-1)

Derivation path: 36.508 Table 4.4.3.3-1			
Information Element	Value/Remark	Comment	Condition
SystemInformationBlockType2 ::= SEQUENCE {			
radioResourceConfigCommon SEQUENCE {			
prach-Config SEQUENCE {			
prach-ConfigInfo SEQUENCE {			
prach-ConfigIndex	5	The default is 3	FDD
prach-ConfigIndex	52	The default is 51	TDD
}			
}			
}			
}			

8.1.2 RRC connection establishment

8.1.2.1 RRC connection establishment / Ks=1.25/ Success

8.1.2.1.1 Test Purpose (TP)

(1)

```

with {UE in E-UTRA RRC_IDLE state}
ensure that {
  when { UE is requested to make an outgoing call }
  then { UE establishes an RRC Connection }
}

```

8.1.2.1.2 Conformance requirements

References: The conformance requirements covered in the present TC are specified in: 3GPP TS 36.331 clauses 5.3.3.2, 5.3.3.3 and 5.3.3.4.

[TS 36.331, clause 5.3.3.2]

The UE initiates the procedure when upper layers request establishment of a signalling connection while the UE is in RRC_IDLE state.

Upon initiation of the procedure, the UE shall:

...

- 1> If access to the cell, as specified above, is not barred:
 - 2> apply the default physical channel configuration as specified in 9.2.4;
 - 2> apply the default semi-persistent scheduling configuration as specified in 9.2.3;
 - 2> apply the default MAC main configuration as specified in 9.2.2;
 - 2> apply the CCCH configuration as specified in 9.1.1.2;
 - 2> apply the *timeAlignmentTimerCommon* included in *SystemInformationBlockType2*;
 - 2> start timer T300;
 - 2> initiate transmission of the *RRCConnectionRequest* message in accordance with 5.3.3.3;

NOTE 2 Upon initiating the connection establishment procedure, the UE is not required to ensure it maintains up to date system information applicable only for UEs in RRC_IDLE state. However, the UE needs to perform system information acquisition upon re-selection.

...

[TS 36.331, clause 5.3.3.3]

The UE shall set the contents of *RRCConnectionRequest* message as follows:

- 1> set the IE *ue-Identity* as follows:
 - 2> if upper layers provide an S-TMSI:
 - 3> set the *ue-Identity* to the value received from upper layers;
 - 2> else
 - 3> draw a random value in the range $0 \dots 2^{40}-1$ and set the *ue-Identity* to this value;

NOTE 1 Upper layers provide the S-TMSI if the UE is registered in the TA of the current cell.

- 1> Set the *establishmentCause* in accordance with the information received from upper layers;

The UE shall submit the *RRCConnectionRequest* message to lower layers for transmission.

...

[TS 36.331, clause 5.3.3.4]

...

The UE shall:

- 1> perform the radio resource configuration procedure in accordance with the received *radioResourceConfiguration* and as specified in 5.3.10;
- 1> if stored, discard the cell reselection priority information provided by the *idleModeMobilityControlInfo* or inherited from another RAT;
- 1> stop timer T300;
- 1> stop timer T302, if running;

- 1> stop timer T303, if running;
- 1> stop timer T305, if running;
- 1> perform the actions as specified in 5.3.3.7;
- 1> stop timer T320, if running;
- 1> enter RRC_CONNECTED;
- 1> stop the cell re-selection procedure;
- 1> set the contents of *RRConnectionSetupComplete* message as follows:
 - 2> set the *selectedPLMN-Identity* to the PLMN selected by upper layers (see TS 23.122 [11], TS 24.301 [35]) from the PLMNs included in the *plmn-IdentityList* in *SystemInformationBlockType1*;
 - 2> if upper layers provide the 'Registered MME', include and set the *registeredMME* as follows:
 - 3> if the PLMN identity of the 'Registered MME' is different from the PLMN selected by the upper layers:
 - 4> include the *plmnIdentity* in the *registeredMME* and set it to the value of the PLMN identity in the 'Registered MME' received from upper layers;
 - 3> set the *mmegi* and *mmec* to the value received from upper layers;
 - 2> set the *nas-DedicatedInformation* to include the information received from upper layers;
 - 2> submit the *RRConnectionSetupComplete* message to lower layers for transmission, upon which the procedure ends.

8.1.2.1.3 Test description

8.1.2.1.3.1 Pre-test conditions

System Simulator:

- Cell 1

UE:

None.

Preamble:

- The UE is in state Registered, Idle mode (state 2) according to [18].

8.1.2.1.3 Test procedure sequence

Table 8.1.2.1.3-1: Main behaviour

St	Procedure	Message Sequence		TP	Verdict
		U - S	Message		
1	SS sends a <i>Paging</i> message to the UE on the appropriate paging block, and including the UE identity in one entry of the IE <i>pagingRecordLists</i> .	<--	<i>Paging</i>	-	-
2	Check: does the UE transmit an <i>RRCCONNECTIONREQUEST</i> message?	-->	<i>RRCCONNECTIONREQUEST</i>	1	P
3	The SS transmit an <i>RRCCONNECTIONSETUP</i> message with SRB1 configuration (Note 1).	<--	<i>RRCCONNECTIONSETUP</i>	-	-
4	Check: Does the UE transmit an <i>RRCCONNECTIONSETUPCOMPLETE</i> including SERVICE REQUEST message to confirm the successful completion of the connection establishment?	-->	<i>RRCCONNECTIONSETUPCOMPLETE</i>	1	P
4A-4D	Steps 6 to 9 of the generic radio bearer establishment procedure (TS 36.508 4.5.3.3-1) are executed to successfully complete the service request procedure.	-	-	-	-
5	Check: Does the test result of generic test procedure in TS 36.508 subclause 6.4.2.3 indicate that the UE is in E-UTRA RRC_CONNECTED state on Cell 1?	-	-	1	-

Note 1: Contains a SERVICE REQUEST NAS message.

8.1.2.1.3.3 Specific message contents

Table 8.1.2.1.3.3-1: RRCCONNECTIONSETUP-DeltaMCS (step 3, Table 8.1.2.1.3-1)

Derivation Path: 36.508, Table 4.6.1-17			
Information Element	Value/remark	Comment	Condition
RRCCONNECTIONSETUP-DeltaMCS ::= SEQUENCE {			
criticalExtensions CHOICE {			
c1 CHOICE {			
rrcConnectionSetup-r8 SEQUENCE {			
radioResourceConfigDedicated	RadioResourceConfigDedicated-SRB1-DeltaMCS		
}			
}			
}			
}			

Table 8.1.2.1.3.3-2: RadioResourceConfigDedicated-SRB1-DeltaMCS (Table 8.1.2.1.3.3-1)

Derivation Path: 36.508, Table 4.6.3-15,			
Information Element	Value/remark	Comment	Condition
RadioResourceConfigDedicated-SRB1-DeltaMCS ::= SEQUENCE {			
physicalConfigDedicated	PhysicalConfigDedicated--DeltaMCS using condition SRB1		
}			

Table 8.1.2.1.3.3-3: PhysicalConfigDedicated—DeltaMCS (Table 8.1.2.1.3.3-2)

Derivation Path: 36.508, Table 4.8.2.1.6-1			
Information Element	Value/remark	Comment	Condition
PhysicalConfigDedicated--DeltaMCS ::= SEQUENCE {			
uplinkPowerControlDedicated	UplinkPowerControlDedicated--DeltaMCS		SRB1
}			

Table 8.1.2.1.3.3-4: UplinkPowerControlDedicated--DeltaMCS (Table 8.1.2.1.3.3-3)

Derivation Path: 36.508, Table 4.6.3-26			
Information Element	Value/remark	Comment	Condition
UplinkPowerControlDedicated--DeltaMCS ::= SEQUENCE {			
deltaMCS-Enabled	en1	Corresponds to Ks value 1.25 corresponding to "enabled".	
}			

8.1.2.2 RRC connection establishment / Reject with wait time

8.1.2.2.1 Test Purpose (TP)

(1)

```
with { UE in E-UTRA RRC_IDLE state and has sent an RRCConnectionRequest message }
ensure that {
  when { UE receives an RRCConnectionReject message including an IE waitTime set to non-zero value }
  then { UE doesn't re-send RRCConnectionRequest before the waitTime is expired }
}
```

8.1.2.2.2 Conformance requirements

References: The conformance requirements covered in the current TC are specified in: TS 36.331, clauses 5.3.3.2, 5.3.3.3 and 5.3.3.8.

[TS 36.331, clause 5.3.3.2]

...

Upon initiation of the procedure, the UE shall:

1> if the UE is establishing the RRC connection for mobile terminating calls:

2> if timer T302 is running:

3> consider access to the cell as barred;

2> else:

3> consider access to the cell as not barred;

1> else if the UE is establishing the RRC connection for emergency calls:

...

1> else if the UE is establishing the RRC connection for mobile originating calls:

2> if timer T302 or T303 is running:

3> consider access to the cell as barred;

...

- 1> If access to the cell, as specified above, is not barred:
 - 2> apply the default physical channel configuration as specified in 9.2.4;
 - 2> apply the default semi-persistent scheduling configuration as specified in 9.2.3;
 - 2> apply the default MAC main configuration as specified in 9.2.2;
 - 2> apply the CCCH configuration as specified in 9.1.1.2;
 - 2> apply the *timeAlignmentTimerCommon* included in *SystemInformationBlockType2*;
 - 2> start timer T300;
 - 2> initiate transmission of the *RRCConnectionRequest* message in accordance with 5.3.3.3;

NOTE 2: Upon initiating the connection establishment procedure, the UE is not required to ensure it maintains up to date system information applicable only for UEs in RRC_IDLE state. However, the UE needs to perform system information acquisition upon re-selection.

...

[TS 36.331, clause 5.3.3.3]

The UE shall set the contents of *RRCConnectionRequest* message as follows:

- 1> set the IE *ue-Identity* as follows:
 - 2> if upper layers provide an S-TMSI:
 - 3> set the *ue-Identity* to the value received from upper layers;
 - 2> else
 - 3> draw a random value in the range $0 \dots 2^{40}-1$ and set the *ue-Identity* to this value;

NOTE 1 Upper layers provide the S-TMSI if the UE is registered in the TA of the current cell.

- 1> Set the *establishmentCause* in accordance with the information received from upper layers;

The UE shall submit the *RRCConnectionRequest* message to lower layers for transmission.

...

[TS 36.331, clause 5.3.3.8]

The UE shall:

- 1> stop timer T300;
- 1> reset MAC and release the MAC configuration;
- 1> start timer T302, with the timer value set to the *waitTime*;
- 1> inform upper layers about the failure to establish the RRC connection and that access barring for mobile originating calls, mobile originating signalling and mobile terminating access is applicable, upon which the procedure ends.

8.1.2.2.3 Test description

8.1.2.2.3.1 Pre-test conditions

System Simulator:

- Cell 1

UE:

None.

Preamble:

- The UE is in state Loopback Activated (state 4) with condition UE TEST LOOP MODE B on Cell 1 (serving cell) according to [18].

8.1.2.2.3.2 Test procedure sequence

Table 8.1.2.2.3.2-1: Main behaviour

St	Procedure	Message Sequence		TP	Verdict
		U - S	Message		
1	The SS transmits one IP packet to the UE on the DRB associated with the default EPS bearer context on Cell 1.	-	-	-	-
1A	Wait for 1 s after the IP packet has been transmitted in step 1. (Note 3)				
1B	The SS transmits an <i>RRCCoNNECTIONRelease</i> message on Cell 1.	<--	<i>RRCCoNNECTIONRelease</i>		
1C	The SS transmits a <i>Paging</i> message with a matching UE identity.	<--	<i>Paging</i>		
2	The UE transmits an <i>RRCCoNNECTIONRequest</i> message.	-->	<i>RRCCoNNECTIONRequest</i>	-	-
3	The SS responds with <i>RRCCoNNECTIONReject</i> message with IE <i>waitTime</i> set to 10s.	<--	<i>RRCCoNNECTIONReject</i>	-	-
-	EXCEPTION: the behaviour in table 8.1.2.2.3.2-2 runs in parallel with steps 4 and 5 below.	-	-	-	-
4	Void	-	-	-	-
5	The SS transmits a <i>Paging</i> message with a matching UE identity.	<--	<i>Paging</i>	-	-
6	The SS starts timer <i>Timer_1</i> = 5 s (Note 1)	-	-	-	-
-	EXCEPTION: Steps 7a1 to 7 b2 describe a transaction that depends on the UE behaviour; the "lower case letter" identifies a step sequence that takes place if a specific behaviour happens.(Note 2)	-	-	-	-
7a1	Check: Does UE transmit <i>RRCCoNNECTIONRequest</i> message when Cell 1 is treated as normal cell and access is granted for originating call?	-	<i>RRCCoNNECTIONRequest</i>	1	P
7a2 - 7a6	Steps 4 to 8 of the generic radio bearer establishment procedure (TS 36.508 4.5.3.3-1) are executed.	-	-	-	-
	EXCEPTION: Step 7a7 and 7a8 can occur in any order				
7a7	The UE transmits an <i>RRCCoNNECTIONReconfigurationComplete</i> message on Cell 1.	-->	<i>RRCCoNNECTIONReconfigurationComplete</i>		
7a8	The UE loop backs the IP packet received in step 1 on the DRB associated with the default EPS bearer context on Cell 1.				
7a9	Check: Does the test result of generic test procedure in TS 36.508 subclause 6.4.2.3 indicate that the UE is in E-UTRA RRC_CONNECTED state on Cell 1?			1	
7b1	The SS waits for <i>Timer_1</i> expiry	-	-	-	-
7b2	Check: Does the test result of generic test procedure in TS 36.508 subclause 6.4.2.2 indicate that the UE is in E-UTRA RRC_IDLE state on Cell 1?	-	-	1	-
Note 1:	Test step 6 is always executed 10s after step 3, i.e. when the reject timer is expired in the UE and the UE is allowed to answer paging and initiate calls again. This is because test steps 4 and 5 of the main behaviour run in parallel with test step 1 of the parallel behaviour, which lasts 10s unless the verdict is "Failed".				
Note 2:	A UE may send <i>RRCCoNNECTIONRequest</i> for the pending data sent at step 1.				
Note 3:	The 1 second delay is used to secure that the UE have received and forwarded the IP Packet transmitted by the SS in step 1 to the UE test loop function before the <i>RRCCoNNECTIONRelease</i> message is sent by the SS in step 1B.				

Table 8.1.2.2.3.2-2: Parallel behaviour

St	Procedure	Message Sequence		TP	Verdict
		U - S	Message		
1	Check: Does the UE transmit an <i>RRCCONNECTIONREQUEST</i> message within 10s.	-->	<i>RRCCONNECTIONREQUEST</i>	1	F

8.1.2.2.3.3 Specific message contents

Table 8.1.2.2.3.3-1: *RRCCONNECTIONREJECT* (step 3, table 8.1.2.2.3.2-1)

Derivation path: 36.508 table 4.6.1-14			
Information Element	Value/Remark	Comment	Condition
<i>RRCCONNECTIONREJECT</i> ::= SEQUENCE {			
criticalExtensions CHOICE {			
c1 CHOICE {			
rrcConnectionReject-r8 SEQUENCE {			
waitTime	10	10 seconds	
}			
}			
}			
}			

Table 8.1.2.2.3.3-2: CLOSE UE TEST LOOP (preamble, Table 8.1.2.2.3.2-1)

Derivation Path: 36.508, Table 4.7A-3, condition UE TEST LOOP MODE B			
Information Element	Value/remark	Comment	Condition
UE test loop mode B LB setup			
IP PDU delay	'0000 0101'B	5 seconds	

8.1.2.3 RRC connection establishment / Return to idle state after T300 timeout

8.1.2.3.1 Test Purpose (TP)

(1)

```
with {UE in E-UTRA RRC_IDLE state having sent an RRCCONNECTIONREQUEST message}
ensure that {
  when { the SS does not answer to the UE during T300}
  then {UE goes to RRC_IDLE}
}
```

8.1.2.3.2 Conformance requirements

References: The conformance requirements covered in the present TC are specified in: 3GPP TS 36.331 clause 5.3.3.6.

[TS 36.331, clause 5.3.3.6]

The UE shall:

- 1> if timer T300 expires
 - 2> reset MAC, release the MAC configuration and re-establish RLC for all RBs that are established;
 - 2> inform upper layers about the failure to establish the RRC connection, upon which the procedure ends.

8.1.2.3.3 Test description

8.1.2.3.3.1 Pre-test conditions

System Simulator:

- Cell 1

UE:

None.

Preamble:

- The UE is in state Registered, Idle mode (state 2) according to [18].

8.1.2.3.3.2 Test procedure sequence

Table 8.1.2.3.3.2-1: Main behaviour

St	Procedure	Message Sequence		TP	Verdict
		U - S	Message		
0A	SS is configured not to transmit MAC control element with matched UE Contention Resolution Identity	-	-	-	-
1	SS sends a Paging message to the UE on the appropriate paging block, and including the UE identity in one entry of the IE pagingRecordLists.	<--	Paging	-	-
2	The UE transmits an RRCConnectionRequest message.	-->	RRCConnectionRequest	-	-
3	The SS waits for 2s. Note: the UE may transmit one or more RRCConnectionRequest messages but the SS does not answer to these messages.	-->	RRCConnectionRequest	-	-
3A	SS is configured to transmit MAC control element with matched UE Contention Resolution Identity	-	-	-	-
4	Check: Does the test result of generic test procedure in TS 36.508 subclause 6.4.2.2 indicate that the UE is in E-UTRA RRC_IDLE state on Cell 1?	-	-	1	-

8.1.2.3.3.3 Specific message contents

Table 8.1.2.3.3.3-1: RRCConnectionRequest (step 2 and step 3, Table 8.1.2.3.3.2-1)

Derivation Path: 36.508, Table 4.6.1-16			
Information Element	Value/remark	Comment	Condition
RRCConnectionRequest ::= SEQUENCE {			
criticalExtensions CHOICE {			
rrcConnectionRequest-r8 SEQUENCE {			
establishmentCause	mt-Access		
}			
}			
}			

8.1.2.4 Void

8.1.2.5 RRC connection establishment / 0% access probability for MO calls, no restriction for MO signalling

8.1.2.5.1 Test Purpose (TP)

(1)

```
with { UE in E-UTRA RRC_IDLE state having received a SystemInformationBlockType2 indicating 0%
access probability for MO calls }
ensure that {
  when { UE has user data pending }
  then { UE does not transmit any RRCConnectionRequest message }
}
```

(2)

```

with { UE in E-UTRA RRC_IDLE state }
ensure that {
  when { UE reselects a new cell which belongs to different TA and broadcasts a
SystemInformationBlockType2 indicating no restriction for MO signalling }
  then { UE transmits an RRCConnectionRequest message }
}

```

8.1.2.5.2 Conformance requirements

References: The conformance requirements covered in the present TC are specified in: TS 36.331, clause 5.3.3.2.

[TS 36.331, clause 5.3.3.2]

The UE initiates the procedure when upper layers request establishment of an RRC connection while the UE is in RRC_IDLE.

Upon initiation of the procedure, the UE shall:

1> if the UE is establishing the RRC connection for mobile terminating calls:

...

1> else if the UE is establishing the RRC connection for emergency calls:

...

1> else if the UE is establishing the RRC connection for mobile originating calls:

2> if timer T302 or T303 is running:

3> consider access to the cell as barred;

2> else if *SystemInformationBlockType2* includes the *ac-BarringInfo* and the *ac-BarringForMO-Data* is present:

3> if the UE has one or more Access Classes, as stored on the USIM, with a value in the range 11..15, which is valid for the UE to use according to TS 22.011 [10] and TS 23.122 [11], and

3> for at least one of these Access Classes the corresponding bit in the *ac-BarringForSpecialAC* contained in *ac-BarringForMO-Data* is set to zero:

4> consider access to the cell as not barred;

3> else:

4> draw a random number '*rand*' uniformly distributed in the range: $0 \leq rand < 1$;

4> if '*rand*' is lower than the value indicated by *ac-BarringFactor* included in *ac-BarringForMO-Data*:

5> consider access to the cell as not barred;

4> else:

5> consider access to the cell as barred;

2> else:

3> consider access to the cell as not barred;

1> else (the UE is establishing the RRC connection for mobile originating signalling):

2> if timer T302 or T305 is running:

3> consider access to the cell as barred;

2> else if *SystemInformationBlockType2* includes the *ac-BarringInfo* and the *ac-BarringForMO-Signalling* is present:

- 3> if the UE has one or more Access Classes, as stored on the USIM, with a value in the range 11..15, which is valid for the UE to use according to TS 22.011 [10] and TS 23.122 [11], and
- 3> for at least one of these Access Classes the corresponding bit in the *ac-BarringForSpecialAC* contained in *ac-BarringForMO-Signalling* is set to zero:
 - 4> consider access to the cell as not barred;
- 3> else:
 - 4> draw a random number 'rand' uniformly distributed in the range: $0 \leq \text{rand} < 1$;
 - 4> if 'rand' is lower than the value indicated by *ac-BarringFactor* included in *ac-BarringForMO-Signalling*:
 - 5> consider access to the cell as not barred;
 - 4> else:
 - 5> consider access to the cell as barred;
- 2> else:
 - 3> consider access to the cell as not barred;
- 1> if access to the cell, as specified above, is not barred:
 - 2> apply the default physical channel configuration as specified in 9.2.4;
 - 2> apply the default semi-persistent scheduling configuration as specified in 9.2.3;
 - 2> apply the default MAC main configuration as specified in 9.2.2;
 - 2> apply the CCCH configuration as specified in 9.1.1.2;
 - 2> apply the *timeAlignmentTimerCommon* included in *SystemInformationBlockType2*;
 - 2> start timer T300;
 - 2> initiate transmission of the *RRCConnectionRequest* message in accordance with 5.3.3.3;

NOTE 2: Upon initiating the connection establishment procedure, the UE is not required to ensure it maintains up to date system information applicable only for UEs in RRC_IDLE state. However, the UE needs to perform system information acquisition upon cell re-selection.

- 1> else:
 - 2> if the UE is establishing the RRC connection for mobile originating calls and if both timers T302 and T303 are not running:
 - 3> draw a random number 'rand' that is uniformly distributed in the range $0 \leq \text{rand} < 1$;
 - 3> start timer T303 with the timer value calculated as follows, using the *ac-BarringTime* included in *ac-BarringForMO-Data*:
$$T303 = (0.7 + 0.6 * \text{rand}) * \text{ac-BarringTime}$$
 - 3> inform upper layers about the failure to establish the RRC connection and that access barring for mobile originating calls is applicable, upon which the procedure ends;

...

8.1.2.5.3 Test description

8.1.2.5.3.1 Pre-test conditions

System Simulator:

- Cell 1 and Cell 11 (HPLMN in different TA).

UE:

None.

Preamble:

- The UE is in state Loopback Activated (state 4) with condition UE TEST LOOP MODE B on Cell 1 (serving cell) according to [18].

8.1.2.5.3.2 Test procedure sequence

Table 8.1.2.5.3.2-1 illustrates the downlink power levels and other changing parameters to be applied for the cells at various time instants of the test execution. The configuration marked "T1" is applied at the point indicated in the Main behaviour description in Table 8.1.2.5.3.2-2.

Table 8.1.2.5.3.2-1: Time instances of cell power level and parameter changes

	Parameter	Unit	Cell 1	Cell 11	Remark
T1	Cell-specific RS EPRE	dBm/15 kHz	-85	-79	The power level values are assigned to satisfy RCell 1 < RCell 11.

Table 8.1.2.5.3.2-2: Main behaviour

St	Procedure	Message Sequence		TP	Verdict
		U - S	Message		
1	Void	-	-	-	-
2	Void	-	-	-	-
2A	The SS transmits an <i>RRCCONNECTIONRELEASE</i> message on Cell 1.	<--	<i>RRCCONNECTIONRELEASE</i>	-	-
2B	Wait for 5 s for the UE to enter E-UTRA RRC_IDLE state.	-	-	-	-
3	The SS changes Cell 1 and Cell 11 level according to the row "T1" in table 8.1.2.5.3.2-1.	-	-	-	-
3A	Check: Does the UE transmit an <i>RRCCONNECTIONREQUEST</i> on Cell 11?	-->	<i>RRCCONNECTIONREQUEST</i>	2	P
3B-3F	Steps 2 to 6 of the generic test procedure in TS 36.508 [18] subclause 6.4.2.7 are performed on Cell 11. Note: The UE performs a TAU procedure and the RRC connection is released.	-	-	-	-
4-9	Void	-	-	-	-
10	Wait for 5 s for the UE to enter E-UTRA RRC_IDLE state.	-	-	-	-
10 A	Generic test procedure in TS 36.508 subclause 4.5.3.3 is performed on Cell 11. NOTE: The UE performs the establishment of the new data radio bearer associated with the default EPS bearer context.	-	-	-	-
10 B	The SS transmits one IP packet to the UE on the DRB associated with the default EPS bearer context on Cell 11.	-	-	-	-
10 C	Wait for 1 s after the IP packet has been transmitted in step 10B. (Note 1)	-	-	-	-
11-13	Void	-	-	-	-
14	The SS transmits an <i>RRCCONNECTIONRELEASE</i> message on Cell 11.	<--	<i>RRCCONNECTIONRELEASE</i>	-	-
15	Check: Does the UE transmit an <i>RRCCONNECTIONREQUEST</i> message on Cell 11 within 30s?	-->	<i>RRCCONNECTIONREQUEST</i>	1	F
16	Void	-	-	-	-
-	EXCEPTION: Step 26 and Step 27a1 can happen in any order	-	-	-	-
17 - 26	Check: Does the test result of steps 1 to 10 generic test procedure in TS 36.508 subclause 6.4.2.2 indicate that the UE is in E-UTRA RRC_IDLE state on Cell 11?	-	-	1,2	-
-	EXCEPTION: Step 27a1 describes behaviour that depends on UE implementation; the "lower case letter" identifies a step sequence that takes place if the UE has user data pending.	-	-	-	-
27a 1	IF the UE has user data pending THEN the UE loops back the IP packet received in step 10C on the DRB associated with the default EPS bearer context on Cell 11 within 10s.	-	-	-	-
Note 1: The 1 second delay is used to secure that the UE have received and forwarded the IP Packet transmitted by the SS in step 10B to the UE test loop function before the <i>RRCCONNECTIONRELEASE</i> message is sent by the SS in step 14.					

8.1.2.5.3.3 Specific message contents

Table 8.1.2.5.3.3-1: SystemInformationBlockType2 for Cell 11 (preamble and all steps, Table 8.1.2.5.3.2-2)

Derivation Path: 36.508, Table 4.4.3.3-1			
Information Element	Value/remark	Comment	Condition
SystemInformationBlockType2 ::= SEQUENCE {			
ac-BarringInfo SEQUENCE {			
ac-BarringForEmergency	FALSE		
ac-BarringForMO-Signalling	Not present		
ac-BarringForMO-Data SEQUENCE {			
ac-BarringFactor	p00		
ac-BarringTime	s512		
ac-BarringForSpecialAC	'11111'B		
}			
}			
}			

Table 8.1.2.5.3.3-1A: CLOSE UE TEST LOOP (preamble, Table 8.1.2.5.3.2-2)

Derivation Path: 36.508, Table 4.7A-3, condition UE TEST LOOP MODE B			
Information Element	Value/remark	Comment	Condition
UE test loop mode B LB setup			
IP PDU delay	'0000 0101'B	5 seconds	

Table 8.1.2.5.3.3-2: RRCConnectionRequest (step 3A, Table 8.1.2.5.3.2-2)

Derivation Path: 36.508, Table 4.6.1-16			
Information Element	Value/remark	Comment	Condition
RRCConnectionRequest ::= SEQUENCE {			
criticalExtensions CHOICE {			
rrcConnectionRequest-r8 SEQUENCE {			
establishmentCause	mo-Signalling		
}			
}			
}			

8.1.2.6 RRC connection establishment / Non-zero percent access probability for MO calls, no restriction for MO signalling

8.1.2.6.1 Test Purpose (TP)

(1)

```
with { UE in E-UTRA RRC_IDLE state having received a SystemInformationBlockType2 indicating non zero
percent access probability for MO calls }
ensure that {
  when { UE has user data pending }
  then { UE does not transmit any RRCConnectionRequest message or UE transmits an
RRCConnectionRequest message }
}
```

(2)

```
with { UE in E-UTRA RRC_IDLE state }
ensure that {
  when { UE reselects a new cell which belongs to different TA and broadcasts a
SystemInformationBlockType2 indicating no restriction for MO signalling }
  then { UE transmits an RRCConnectionRequest message }
}
```

8.1.2.6.2 Conformance requirements

References: The conformance requirements covered in the present TC are specified in: TS 36.331, clause 5.3.3.2.

[TS 36.331, clause 5.3.3.2]

The UE initiates the procedure when upper layers request establishment of an RRC connection while the UE is in RRC_IDLE.

Upon initiation of the procedure, the UE shall:

1> if the UE is establishing the RRC connection for mobile terminating calls:

...

1> else if the UE is establishing the RRC connection for emergency calls:

...

1> else if the UE is establishing the RRC connection for mobile originating calls:

2> if timer T302 or T303 is running:

3> consider access to the cell as barred;

2> else if *SystemInformationBlockType2* includes the *ac-BarringInfo* and the *ac-BarringForMO-Data* is present:

3> if the UE has one or more Access Classes, as stored on the USIM, with a value in the range 11..15, which is valid for the UE to use according to TS 22.011 [10] and TS 23.122 [11], and

3> for at least one of these Access Classes the corresponding bit in the *ac-BarringForSpecialAC* contained in *ac-BarringForMO-Data* is set to zero:

4> consider access to the cell as not barred;

3> else:

4> draw a random number '*rand*' uniformly distributed in the range: $0 \leq rand < 1$;

4> if '*rand*' is lower than the value indicated by *ac-BarringFactor* included in *ac-BarringForMO-Data*:

5> consider access to the cell as not barred;

4> else:

5> consider access to the cell as barred;

2> else:

3> consider access to the cell as not barred;

1> else (the UE is establishing the RRC connection for mobile originating signalling):

2> if timer T302 or T305 is running:

3> consider access to the cell as barred;

2> else if *SystemInformationBlockType2* includes the *ac-BarringInfo* and the *ac-BarringForMO-Signalling* is present:

...

2> else:

3> consider access to the cell as not barred;

1> if access to the cell, as specified above, is not barred:

2> apply the default physical channel configuration as specified in 9.2.4;

- 2> apply the default semi-persistent scheduling configuration as specified in 9.2.3;
- 2> apply the default MAC main configuration as specified in 9.2.2;
- 2> apply the CCCH configuration as specified in 9.1.1.2;
- 2> apply the *timeAlignmentTimerCommon* included in *SystemInformationBlockType2*;
- 2> start timer T300;
- 2> initiate transmission of the *RRCConnectionRequest* message in accordance with 5.3.3.3;

NOTE 2: Upon initiating the connection establishment procedure, the UE is not required to ensure it maintains up to date system information applicable only for UEs in RRC_IDLE state. However, the UE needs to perform system information acquisition upon cell re-selection.

1> else:

- 2> if the UE is establishing the RRC connection for mobile originating calls and if both timers T302 and T303 are not running:
 - 3> draw a random number '*rand*' that is uniformly distributed in the range $0 \leq rand < 1$;
 - 3> start timer T303 with the timer value calculated as follows, using the *ac-BarringTime* included in *ac-BarringForMO-Data*:

$$T303 = (0.7 + 0.6 * rand) * ac-BarringTime$$
 - 3> inform upper layers about the failure to establish the RRC connection and that access barring for mobile originating calls is applicable, upon which the procedure ends;
- 2> else if the UE is establishing the RRC connection for mobile originating signalling and if both timers T302 and T305 are not running:
 - 3> draw a random number '*rand*' that is uniformly distributed in the range $0 \leq rand < 1$;
 - 3> start timer T305 with the timer value calculated as follows, using the *ac-BarringTime* included in *ac-BarringForMO-Signalling*:

$$T305 = (0.7 + 0.6 * rand) * ac-BarringTime$$
 - 3> inform upper layers about the failure to establish the RRC connection and that access barring for mobile originating signalling is applicable, upon which the procedure ends;

8.1.2.6.3 Test description

8.1.2.6.3.1 Pre-test conditions

System Simulator:

- Cell 1 and Cell 11.

UE:

None.

Preamble:

- UE is in state Generic RB Established, UE Test Mode Activated (state 3A) on Cell 1 according to [18].

8.1.2.6.3.2 Test procedure sequence

Table 8.1.2.6.3.2-1: Time instances of cell power level and parameter changes

	Parameter	Unit	Cell 1	Cell 11	Remark
T1	Cell-specific RS EPRE	dBm/15 kHz	-85	-79	The power level values are assigned to satisfy $R_{Cell\ 1} < R_{Cell\ 11}$.

Table 8.1.2.6.3.2-2: Main behaviour

St	Procedure	Message Sequence		TP	Verdict
		U - S	Message		
1	The SS initializes an internal counter K to 0 and L to 0.	-	-	-	-
2	Void	-	-	-	-
-	EXCEPTION: Step 2Aa1 to 3b9 shall be repeated maximum 50 times unless K > 0 and L > 0. (Note 1)	-	-	-	-
-	EXCEPTION: Step 2Aa1 describes behaviour that depends on the internal counters.	-	-	-	-
2Aa1	IF K>0 or L>0 THEN The SS opens the UE test loop mode.	-	-	-	-
2B	The SS closes the UE test loop mode.	-	-	-	-
2C	The SS transmits one IP packet to the UE on the DRB associated with the default EPS bearer context on Cell 1.	-	-	-	-
2D	Wait for 1 s after the IP packet has been transmitted in step 2C.	-	-	-	-
2E	SS transmits an <i>RRCCConnectionRelease</i> message to release the RRC connection.	<--	<i>RRCCConnectionRelease</i>	-	-
2F	Wait for 5 s for the UE to enter E-UTRA RRC_IDLE state.	-	-	-	-
-	EXCEPTION: Steps 3a1 to 3b9 describe behaviours which vary depending on whether the UE transmits an <i>RRCCConnectionRequest</i> message or not.	-	-	-	-
3a1	IF the UE does not transmit any <i>RRCCConnectionRequest</i> message within 5s (Note 3) THEN the SS increments the counter K by 1.	-	-	-	-
-	EXCEPTION: Steps 3a9 to 3a10 can occur in any order	-	-	-	-
3a2-3a9	Steps 2 to 9 of the generic radio bearer establishment procedure (TS 36.508 4.5.3.3-1) are executed (Note 2).	-	-	-	-
-	EXCEPTION: Step 3a10 describes behaviour that depends on UE implementation; step 3a10 takes place if the UE has user data pending.	-	-	-	-
3a10	IF the UE has user data pending THEN the UE loop backs the IP packet received in step 2D on the DRB associated with the default EPS bearer context on Cell 1 within 10 s.	-	-	-	-
3b1	ELSE IF the UE transmits an <i>RRCCConnectionRequest</i> message on Cell 1 THEN the SS increments the counter L by 1.	-->	<i>RRCCConnectionRequest</i>	-	-
3b2	Void	-	-	-	-
-	EXCEPTION: Steps 3b8 to 3b9 can occur in any order	-	-	-	-
3b3-3b8	Steps 4 to 9 of the generic radio bearer establishment procedure (TS 36.508 4.5.3.3-1) are executed.	-	-	-	-
3b9	The UE loop backs the IP packet received in step 4 on the DRB associated with the default EPS bearer context on Cell 1.	-	-	-	-
3b10-3b14	Void	-	-	-	-
4	Check: Is the counter K > 0 and L > 0?	-	-	1	P
4A	The SS transmits an <i>RRCCConnectionRelease</i> message on Cell 1.	<--	<i>RRCCConnectionRelease</i>	-	-
4B	Wait for 5 s for the UE to enter E-UTRA RRC_IDLE state.	-	-	-	-
5	The SS changes the power level setting according to the row "T1" in table 8.1.2.6.3.2-1.	-	-	-	-
6	Check: Does the UE transmit an	-->	<i>RRCCConnectionRequest</i>	2	P

	<i>RRCConnectionRequest</i> message on Cell 11?				
7-11	Steps 2 to 6 of the generic test procedure in TS 36.508 subclause 6.4.2.7 are performed on Cell 11. NOTE: The UE performs a TAU procedure and the RRC connection is released.	-	-	-	-
12	Check: Does the test result of generic test procedure in TS 36.508 subclause 6.4.2.2 indicate that the UE is in E-UTRA RRC_IDLE state on Cell 11?	-	-	1,2	-
<p>Note 1: There is an extremely low probability that the UE originating calls are barred, or not barred, 50 times consecutively. (The probability is 1.78×10^{-15}). Therefore, 50 times is enough number of trials for this test case.</p> <p>Note 2: After UE enters RRC_CONNECTED T303 is stopped.</p> <p>Note 3: The UE starts T303.</p>					

8.1.2.6.3.3 Specific message contents

Table 8.1.2.6.3.3-1: SystemInformationBlockType2 for Cell 1 and Cell 11 (preamble and all steps, Table 8.1.2.6.3.2-2)

Derivation Path: 36.508, Table 4.4.3.3-1			
Information Element	Value/remark	Comment	Condition
SystemInformationBlockType2 ::= SEQUENCE {			
ac-BarringInfo SEQUENCE {			
ac-BarringForEmergency	FALSE		
ac-BarringForMO-Signalling	Not present		
ac-BarringForMO-Data SEQUENCE {			
ac-BarringFactor	p50		
ac-BarringTime	s64		
ac-BarringForSpecialAC	'00000'B		
}			
}			
}			

Table 8.1.2.6.3.3-2: RRCConnectionRequest (step 3b1, Table 8.1.2.6.3.2-2)

Derivation Path: 36.508, Table 4.6.1-16			
Information Element	Value/remark	Comment	Condition
RRCConnectionRequest ::= SEQUENCE {			
criticalExtensions CHOICE {			
rrcConnectionRequest-r8 SEQUENCE {			
establishmentCause	mo-Data		
}			
}			
}			

Table 8.1.2.6.3.3-3: Void

Table 8.1.2.6.3.3-4: RRCConnectionRequest (step 6, Table 8.1.2.6.3.2-2)

Derivation Path: 36.508, Table 4.6.1-16			
Information Element	Value/remark	Comment	Condition
RRCConnectionRequest ::= SEQUENCE {			
criticalExtensions CHOICE {			
rrcConnectionRequest-r8 SEQUENCE {			
establishmentCause	mo-Signalling		
}			
}			
}			

Table 8.1.2.6.3.3-5: CLOSE UE TEST LOOP (step 2B, Table 8.1.2.6.3.2-2)

Derivation Path: 36.508, Table 4.7A-3, condition UE TEST LOOP MODE B			
Information Element	Value/remark	Comment	Condition
UE test loop mode B LB setup			
IP PDU delay	'0000 1000'B	8 seconds	

8.1.2.7 RRC connection establishment / 0% access probability for AC 0 to 9, AC 10 is barred, AC 11 to 15 are not barred, access for UE with access class in the range 11 to 15 is allowed

8.1.2.7.1 Test Purpose (TP)

(1)

```
with { UE in E-UTRA RRC_IDLE state having an Access Class with a value in the range 11..15 and
having received a SystemInformationBlockType2 indicating 0% access probability for AC 0..9 for both
MO call and MO signalling, access restriction for AC 10 and no restriction for AC 11..15 for both MO
call and MO signalling }
ensure that {
  when { UE has user data pending }
  then { UE transmits an RRCConnectionRequest message }
}
```

(2)

```
with { UE in E-UTRA RRC_IDLE state having an Access Class with a value in the range 11..15 }
ensure that {
  when { UE reselects a new cell which belongs to different TA and broadcasts a
SystemInformationBlockType2 indicating 0% access probability for AC 0..9 for both MO call and MO
signalling, access restriction for AC 10 and no restriction for AC 11..15 for both MO call and MO
signalling }
  then { UE transmits an RRCConnectionRequest message }
}
```

8.1.2.7.2 Conformance requirements

References: The conformance requirements covered in the present TC are specified in: TS 36.331, clause 5.3.3.2.

[TS 36.331, clause 5.3.3.2]

The UE initiates the procedure when upper layers request establishment of an RRC connection while the UE is in RRC_IDLE.

Upon initiation of the procedure, the UE shall:

1> if the UE is establishing the RRC connection for mobile terminating calls:

2> if timer T302 is running:

...

2> else:

3> consider access to the cell as not barred;

1> else if the UE is establishing the RRC connection for emergency calls:

...

1> else if the UE is establishing the RRC connection for mobile originating calls:

2> if timer T302 or T303 is running:

...

2> else if SystemInformationBlockType2 includes the ac-BarringInfo and the ac-BarringForMO-Data is present:

- 3> if the UE has one or more Access Classes, as stored on the USIM, with a value in the range 11..15, which is valid for the UE to use according to TS 22.011 [10] and TS 23.122 [11], and
- 3> for at least one of these Access Classes the corresponding bit in the *ac-BarringForSpecialAC* contained in *ac-BarringForMO-Data* is set to zero:
 - 4> consider access to the cell as not barred;
- 3> else:

...

1> else (the UE is establishing the RRC connection for mobile originating signalling):

- 2> if timer T302 or T305 is running:

...

2> else if *SystemInformationBlockType2* includes the *ac-BarringInfo* and the *ac-BarringForMO-Signalling* is present:

- 3> if the UE has one or more Access Classes, as stored on the USIM, with a value in the range 11..15, which is valid for the UE to use according to TS 22.011 [10] and TS 23.122 [11], and
- 3> for at least one of these Access Classes the corresponding bit in the *ac-BarringForSpecialAC* contained in *ac-BarringForMO-Signalling* is set to zero:
 - 4> consider access to the cell as not barred;
- 3> else:

...

1> if access to the cell, as specified above, is not barred:

- 2> apply the default physical channel configuration as specified in 9.2.4;
- 2> apply the default semi-persistent scheduling configuration as specified in 9.2.3;
- 2> apply the default MAC main configuration as specified in 9.2.2;
- 2> apply the CCCH configuration as specified in 9.1.1.2;
- 2> apply the *timeAlignmentTimerCommon* included in *SystemInformationBlockType2*;
- 2> start timer T300;
- 2> initiate transmission of the *RRCConnectionRequest* message in accordance with 5.3.3.3;

NOTE 2: Upon initiating the connection establishment procedure, the UE is not required to ensure it maintains up to date system information applicable only for UEs in RRC_IDLE state. However, the UE needs to perform system information acquisition upon cell re-selection.

...

8.1.2.7.3 Test description

8.1.2.7.3.1 Pre-test conditions

System Simulator:

- Cell 1 and Cell 11 (HPLMN in different TA).

UE:

- USIM set to Type C in 34.108[5] subclause 8.3.2.15 is inserted.

Preamble:

- The UE is in state Loopback Activated (state 4) with condition UE TEST LOOP MODE B on Cell 1 according to [18].

8.1.2.7.3.2 Test procedure sequence

Table 8.1.2.7.3.2-1 illustrates the downlink power levels and other changing parameters to be applied for the cells at various time instants of the test execution. Row marked "T0" denotes the initial conditions after preamble, while columns marked "T1" is to be applied subsequently. The exact instants on which these values shall be applied are described in the texts in this clause.

Table 8.1.2.7.3.2-1: Time instances of cell power level and parameter changes

	Parameter	Unit	Cell 1	Cell 11	Remark
T0	Cell-specific RS EPRE	dBm/15 kHz	-85	-91	The power level values are assigned to satisfy $S_{rxlev}Cell\ 1 > S_{rxlev}Cell\ 11$.
T1	Cell-specific RS EPRE	dBm/15 kHz	-85	-79	The power level values are assigned to satisfy $R_{Cell\ 1} < R_{Cell\ 11}$.

Table 8.1.2.7.3.2-2: Main behaviour

St	Procedure	Message Sequence		TP	Verdict
		U - S	Message		
0	The SS transmits one IP packet to the UE on the DRB associated with the default EPS bearer context on Cell 1.	-	-	-	-
0A	Wait for 1 s after the IP packet has been transmitted in step 0. (Note 1)	-	-	-	-
1	The SS transmits an <i>RRCConnectionRelease</i> message on Cell 1.	<--	<i>RRCConnectionRelease</i>	-	-
2	Check: Does the UE transmit an <i>RRCConnectionRequest</i> message on Cell 1?	-->	<i>RRCConnectionRequest</i>	1	P
3	The SS transmits an <i>RRCConnectionSetup</i> message on Cell 1.	<--	<i>RRCConnectionSetup</i>	-	-
3A	The UE transmits an <i>RRCConnectionSetupComplete</i> message on Cell 1. This message includes a SERVICE REQUEST message.	-->	<i>RRCConnectionSetupComplete</i>	-	-
3B	The SS transmits a <i>SecurityModeCommand</i> message on Cell 1.	<--	<i>SecurityModeCommand</i>	-	-
3C	The UE transmits a <i>SecurityModeComplete</i> message on Cell 1.	-->	<i>SecurityModeComplete</i>	-	-
3D	The SS transmits an <i>RRCConnectionReconfiguration</i> message on Cell 1.	<--	<i>RRCConnectionReconfiguration</i>	-	-
-	EXCEPTION: Step 3E and 3EA can occur in any order	-	-	-	-
3E	The UE transmits an <i>RRCConnectionReconfigurationComplete</i> message on Cell 1.	-->	<i>RRCConnectionReconfigurationComplete</i>	-	-
3E A	The UE loops back the IP packet received in step 0 on the DRB associated with the default EPS bearer context on Cell 1.	-	-	-	-
3F	The SS transmits an <i>RRCConnectionRelease</i> message on Cell 1.	<--	<i>RRCConnectionRelease</i>	-	-
3G	Wait for 5 s for the UE to enter E-UTRA RRC_IDLE state.	-	-	-	-
4	The SS changes Cell 1 and Cell 11 level according to the row "T1" in table 8.1.2.7.3.2-1.	-	-	-	-
4A	Check: Does the test result of generic test procedure in TS 36.508 subclause 6.4.2.7 indicate that the UE is camped on E-UTRAN Cell 11 and that the UE has performed TAU procedure with establishment cause 'high priority access'? NOTE: The UE performs a TAU procedure and the RRC connection is released.	-	-	2	-
5-10	Void	-	-	-	-
11	Wait for 5 s for the UE to enter E-UTRA RRC_IDLE state.	-	-	-	-
12-20	Void	-	-	-	-
21	Check: Does the test result of generic test procedure in TS 36.508 subclause 6.4.2.2 indicate that the UE is in E-UTRA RRC_IDLE state on Cell 11 and that the UE responds to paging with establishment cause 'high priority access'?	-	-	1,2	-
Note 1: The 1 second delay is used to secure that the UE have received and forwarded the IP Packet transmitted by the SS in step 0 to the UE test loop function before the <i>RRCConnectionRelease</i> message is sent by the SS in step 1.					

8.1.2.7.3.3 Specific message contents

Table 8.1.2.7.3.3-1: SystemInformationBlockType2 for Cell 1 and Cell 11 (preamble, Table 8.1.2.7.3.2-2)

Derivation Path: 36.508, Table 4.4.3.3-1			
Information Element	Value/remark	Comment	Condition
SystemInformationBlockType2 ::= SEQUENCE {			
ac-BarringInfo SEQUENCE {			
ac-BarringForEmergency	TRUE		
ac-BarringForMO-Signalling SEQUENCE {			
ac-BarringFactor	p00		
ac-BarringTime	s4		
ac-BarringForSpecialAC	'00000'B		
}			
ac-BarringForMO-Data SEQUENCE {			
ac-BarringFactor	p00		
ac-BarringTime	s4		
ac-BarringForSpecialAC	'00000'B		
}			
}			
}			

Table 8.1.2.7.3.3-1A: CLOSE UE TEST LOOP (preamble, Table 8.1.2.7.3.2-2)

Derivation Path: 36.508, Table 4.7A-3, condition UE TEST LOOP MODE B			
Information Element	Value/remark	Comment	Condition
UE test loop mode B LB setup			
IP PDU delay	'0000 1010'B	10 seconds	

Table 8.1.2.7.3.3-2: RRCConnectionRequest (step 2, step 4A and step 21, Table 8.1.2.7.3.2-2)

Derivation Path: 36.508, Table 4.6.1-16			
Information Element	Value/remark	Comment	Condition
RRCConnectionRequest ::= SEQUENCE {			
criticalExtensions CHOICE {			
rrcConnectionRequest-r8 SEQUENCE {			
establishmentCause	highPriorityAccess		
}			
}			
}			

Table 8.1.2.7.3.3-3: Void

Table 8.1.2.7.3.3-4: Void

Table 8.1.2.7.3.3-5: Void

Table 8.1.2.7.3.3-6: Void

Table 8.1.2.7.3.3-7: Void

Table 8.1.2.7.3.3-8: RRCConnectionReconfiguration (step 3D, Table 8.1.2.7.3.2-2)

Derivation Path: 36.508 Table 4.6.1-8, condition SRB2-DRB(1, 0)			
---	--	--	--

8.1.2.8 RRC connection establishment / Range of access barring time

8.1.2.8.1 Test Purpose (TP)

(1)

with { UE in E-UTRA RRC_IDLE state with T303 running }

```

ensure that {
  when { UE is requested to make an outgoing call }
  then { UE does not transmit any RRCConnectionRequest message }
}

```

(2)

```

with { UE in E-UTRA RRC_IDLE state having received SystemInformationBlockType2 with no restriction }
ensure that {
  when { UE is requested to make an outgoing call }
  then { UE transmits an RRCConnectionRequest message }
}

```

8.1.2.8.2 Conformance requirements

References: The conformance requirements covered in the present TC are specified in: TS 36.331, clause 5.3.3.2.

[TS 36.331, clause 5.3.3.2]

The UE initiates the procedure when upper layers request establishment of an RRC connection while the UE is in RRC_IDLE.

Upon initiation of the procedure, the UE shall:

- 1> if the UE is establishing the RRC connection for mobile terminating calls:
 - 2> if timer T302 is running:
 - 3> consider access to the cell as barred;
 - 2> else:
 - 3> consider access to the cell as not barred;
- 1> else if the UE is establishing the RRC connection for emergency calls:
 - 2> if *SystemInformationBlockType2* includes the *ac-BarringInfo*:
 - 3> if the *ac-BarringForEmergency* is set to *FALSE*:
 - 4> consider access to the cell as not barred;
 - 3> else if the UE has one or more Access Classes, as stored on the USIM, with a value in the range 11..15, which is valid for the UE to use according to TS 22.011 [10] and TS 23.122 [11]:
 - 4> if the *ac-BarringInfo* includes *ac-BarringForMO-Data*, and for all of the valid Access Classes for the UE, the corresponding bit in the *ac-BarringForSpecialAC* contained in *ac-BarringForMO-Data* is set to *one*:
 - 5> consider access to the cell as barred;
 - 4> else:
 - 5> consider access to the cell as not barred;
 - 3> else:
 - 4> consider access to the cell as barred;
 - 2> else:
 - 3> consider access to the cell as not barred;

NOTE 1: ACs 12, 13, 14 are only valid for use in the home country and ACs 11, 15 are only valid for use in the HPLMN/ EHPLMN.

- 1> else if the UE is establishing the RRC connection for mobile originating calls:
 - 2> if timer T302 or T303 is running:
 - 3> consider access to the cell as barred;

- 2> else if *SystemInformationBlockType2* includes the *ac-BarringInfo* and the *ac-BarringForMO-Data* is present:
 - 3> if the UE has one or more Access Classes, as stored on the USIM, with a value in the range 11..15, which is valid for the UE to use according to TS 22.011 [10] and TS 23.122 [11], and
 - 3> for at least one of these Access Classes the corresponding bit in the *ac-BarringForSpecialAC* contained in *ac-BarringForMO-Data* is set to *zero*:
 - 4> consider access to the cell as not barred;
 - 3> else:
 - 4> draw a random number '*rand*' uniformly distributed in the range: $0 \leq rand < 1$;
 - 4> if '*rand*' is lower than the value indicated by *ac-BarringFactor* included in *ac-BarringForMO-Data*:
 - 5> consider access to the cell as not barred;
 - 4> else:
 - 5> consider access to the cell as barred;
- 2> else:
 - 3> consider access to the cell as not barred;
- 1> else (the UE is establishing the RRC connection for mobile originating signalling):
 - 2> if timer T302 or T305 is running:
 - 3> consider access to the cell as barred;
 - 2> else if *SystemInformationBlockType2* includes the *ac-BarringInfo* and the *ac-BarringForMO-Signalling* is present:
 - 3> if the UE has one or more Access Classes, as stored on the USIM, with a value in the range 11..15, which is valid for the UE to use according to TS 22.011 [10] and TS 23.122 [11], and
 - 3> for at least one of these Access Classes the corresponding bit in the *ac-BarringForSpecialAC* contained in *ac-BarringForMO-Signalling* is set to *zero*:
 - 4> consider access to the cell as not barred;
 - 3> else:
 - 4> draw a random number '*rand*' uniformly distributed in the range: $0 \leq rand < 1$;
 - 4> if '*rand*' is lower than the value indicated by *ac-BarringFactor* included in *ac-BarringForMO-Signalling*:
 - 5> consider access to the cell as not barred;
 - 4> else:
 - 5> consider access to the cell as barred;
 - 2> else:
 - 3> consider access to the cell as not barred;
- 1> if access to the cell, as specified above, is not barred:
 - 2> apply the default physical channel configuration as specified in 9.2.4;
 - 2> apply the default semi-persistent scheduling configuration as specified in 9.2.3;
 - 2> apply the default MAC main configuration as specified in 9.2.2;

- 2> apply the CCCH configuration as specified in 9.1.1.2;
- 2> apply the *timeAlignmentTimerCommon* included in *SystemInformationBlockType2*;
- 2> start timer T300;
- 2> initiate transmission of the *RRCConnectionRequest* message in accordance with 5.3.3.3;

NOTE 2: Upon initiating the connection establishment procedure, the UE is not required to ensure it maintains up to date system information applicable only for UEs in RRC_IDLE state. However, the UE needs to perform system information acquisition upon cell re-selection.

1> else:

- 2> if the UE is establishing the RRC connection for mobile originating calls and if both timers T302 and T303 are not running:
 - 3> draw a random number '*rand*' that is uniformly distributed in the range $0 \leq rand < 1$;
 - 3> start timer T303 with the timer value calculated as follows, using the *ac-BarringTime* included in *ac-BarringForMO-Data*:

$$T303 = (0.7 + 0.6 * rand) * ac-BarringTime$$
 - 3> inform upper layers about the failure to establish the RRC connection and that access barring for mobile originating calls is applicable, upon which the procedure ends;
- 2> else if the UE is establishing the RRC connection for mobile originating signalling and if both timers T302 and T305 are not running:
 - 3> draw a random number '*rand*' that is uniformly distributed in the range $0 \leq rand < 1$;
 - 3> start timer T305 with the timer value calculated as follows, using the *ac-BarringTime* included in *ac-BarringForMO-Signalling*:

$$T305 = (0.7 + 0.6 * rand) * ac-BarringTime$$
 - 3> inform upper layers about the failure to establish the RRC connection and that access barring for mobile originating signalling is applicable, upon which the procedure ends;
- 2> else if the UE is establishing the RRC connection for emergency calls:
 - 3> inform upper layers about the failure to establish the RRC connection and that access barring for emergency calls is applicable, upon which the procedure ends;
- 2> else:
 - 3> inform upper layers about the failure to establish the RRC connection, upon which the procedure ends;

8.1.2.8.3 Test description

8.1.2.8.3.1 Pre-test conditions

System Simulator:

- Cell 1

UE:

None.

Preamble:

- The UE is in Registered, Idle mode state (state 2) according to [18].

8.1.2.8.3.2 Test procedure sequence

Table 8.1.2.8.3.2-1: Main behaviour

St	Procedure	Message Sequence		TP	Verdict
		U - S	Message		
1	The SS transmits a <i>Paging</i> message including <i>systemInfoModification</i> . (Note 3)	<--	<i>Paging</i>	-	-
2	The SS changes <i>SystemInformationBlockType2</i> parameters to 0% access probability for MO calls.	-	-	-	-
3	Wait for 15 s for the UE to receive system information.	-	-	-	-
4	Void	-	-	-	-
5	Cause the UE to request connectivity to an additional PDN. (Note 5)	-	-	-	-
5A	The UE does not transmit any <i>RRCConnectionRequest</i> message (The UE starts T303) (Note 2)	-	-	-	-
5B	Void	-	-	-	-
6	Cause the UE to request connectivity to an additional PDN. (Note 5)	-	-	-	-
7	Check: Does the UE transmit an <i>RRCConnectionRequest</i> message within 5s?	-->	<i>RRCConnectionRequest</i>	1	F
8	Wait for 20 s to ensure that T303 expires.	-	-	-	-
9	The SS transmits a <i>Paging</i> message including <i>systemInfoModification</i> (Note 3).	<--	<i>Paging</i>	-	-
10	The SS changes <i>SystemInformationBlockType2</i> parameters to default values (Note 4).	-	-	-	-
11	The SS starts timer <i>Timer_1</i> = 20 s.	-	-	-	-
-	EXCEPTION: Steps 12a1 to 12 b3 describe a transaction that depends on the UE behaviour; the "lower case letter" identifies a step sequence that takes place if a specific behaviour happens.(Note 6)	-	-	-	-
12a 1	Check: Does the UE transmit an <i>RRCConnectionRequest</i> message? SS stops timer <i>Timer_1</i>	-->	<i>RRCConnectionRequest</i>	2	P
12b 1	The SS waits for <i>Timer_1</i> expiry	-	-	-	-
12 b2	Cause the UE to request connectivity to an additional PDN. (Note 5)	-	-	-	-
12b 3	Check: Does the UE transmit an <i>RRCConnectionRequest</i> message?	-->	<i>RRCConnectionRequest</i>	2	P
13	Void	-	-	-	-
14- 23	Steps 2a2 to 6 of the generic test procedure in TS 36.508 [18] subclause 6.4.3.2 are performed on Cell 1	-	-	-	-
<p>Note 1: Void.</p> <p>Note 2: The UE is establishing the RRC connection for mobile originating calls, and consider access to the cell as barred, the UE should draw a rand number "rand" in the range $0 \leq rand < 1$, and start T303 with value set to the maximum value: $T303 = (0.7 + 0.6 \cdot rand) \cdot ac\text{-}BarringTime$.</p> <p>Note 3: To guarantee that the UE will receive at least one Paging in the Modification Period preceding the SysInfo change, SS should send the Paging message in every eligible PO in this Modification Period.</p> <p>Note 4: The default values refer to TS36.508 table 4.4.3.3-1.</p> <p>Note 5: The triggers in step 5, step 6 and step 12 b2 are the same as in the generic procedure in 36.508 clause 6.4.3.2.</p> <p>Note 6: A UE may send <i>RRCConnectionRequest</i> for the pending procedure triggered at step 6.</p>					

8.1.2.8.3.3 Specific message contents

Table 8.1.2.8.3.3-1: Paging (step 1 and step 9, Table 8.1.2.8.3.2-1)

Derivation path: 36.508 table 4.6.1-7			
Information Element	Value/Remark	Comment	Condition
Paging ::= SEQUENCE {			
pagingRecordList	Not present		
systemInfoModification	True		
}			

Table 8.1.2.8.3.3-2: SystemInformationBlockType2 (step 2, Table 8.1.2.8.3.2-1)

Derivation Path: 36.508, Table 4.4.3.3-1			
Information Element	Value/remark	Comment	Condition
SystemInformationBlockType2 ::= SEQUENCE {			
ac-BarringInfo SEQUENCE {			
ac-BarringForEmergency	FALSE	For AC 10	
ac-BarringForMO-Signalling SEQUENCE {			
ac-BarringFactor	p00		
ac-BarringTime	s16		
ac-BarringForSpecialAC	'11111'B		
}			
ac-BarringForMO-Data SEQUENCE {			
ac-BarringFactor	p00		
ac-BarringTime	s16		
ac-BarringForSpecialAC	'11111'B	For AC 11..15	
}			
}			
}			

8.1.2.9 RRC Connection Establishment / 0% access probability for MO calls, non-zero percent access probability for MO signalling

8.1.2.9.1 Test Purpose (TP)

(1)

```

with { UE in E-UTRA RRC_IDLE state }
ensure that {
  when { UE reselects a new cell which belongs to different TA and broadcasts
SystemInformationBlockType2 indicating non zero percent access probability for MO signalling }
  then { UE does not transmit any RRCConnectionRequest message when access to the cell is
considered as barred and UE transmits an RRCConnectionRequest message when access to the cell is
considered as not barred }
}

```

(2)

```

with { UE in E-UTRA RRC_IDLE state having received SystemInformationBlockType2 indicating 0% access
probability for MO call }
ensure that {
  when { UE has user data pending }
  then { UE does not transmit any RRCConnectionRequest message }
}

```

8.1.2.9.2 Conformance requirements

References: The conformance requirements covered in the present TC are specified in: TS 36.331, clause 5.3.3.2.

[TS 36.331, clause 5.3.3.2]

The UE initiates the procedure when upper layers request establishment of an RRC connection while the UE is in RRC_IDLE.

Upon initiation of the procedure, the UE shall:

1> if the UE is establishing the RRC connection for mobile terminating calls:

...

1> else if the UE is establishing the RRC connection for emergency calls:

...

1> else if the UE is establishing the RRC connection for mobile originating calls:

2> if timer T302 or T303 is running:

3> consider access to the cell as barred;

2> else if *SystemInformationBlockType2* includes the *ac-BarringInfo* and the *ac-BarringForMO-Data* is present:

3> if the UE has one or more Access Classes, as stored on the USIM, with a value in the range 11..15, which is valid for the UE to use according to TS 22.011 [10] and TS 23.122 [11], and

3> for at least one of these Access Classes the corresponding bit in the *ac-BarringForSpecialAC* contained in *ac-BarringForMO-Data* is set to *zero*:

4> consider access to the cell as not barred;

3> else:

4> draw a random number '*rand*' uniformly distributed in the range: $0 \leq rand < 1$;

4> if '*rand*' is lower than the value indicated by *ac-BarringFactor* included in *ac-BarringForMO-Data*:

5> consider access to the cell as not barred;

4> else:

5> consider access to the cell as barred;

2> else:

3> consider access to the cell as not barred;

1> else (the UE is establishing the RRC connection for mobile originating signalling):

2> if timer T302 or T305 is running:

3> consider access to the cell as barred;

2> else if *SystemInformationBlockType2* includes the *ac-BarringInfo* and the *ac-BarringForMO-Signalling* is present:

3> if the UE has one or more Access Classes, as stored on the USIM, with a value in the range 11..15, which is valid for the UE to use according to TS 22.011 [10] and TS 23.122 [11], and

3> for at least one of these Access Classes the corresponding bit in the *ac-BarringForSpecialAC* contained in *ac-BarringForMO-Signalling* is set to *zero*:

4> consider access to the cell as not barred;

3> else:

4> draw a random number '*rand*' uniformly distributed in the range: $0 \leq rand < 1$;

4> if '*rand*' is lower than the value indicated by *ac-BarringFactor* included in *ac-BarringForMO-Signalling*:

5> consider access to the cell as not barred;

4> else:

- 5> consider access to the cell as barred;
- 2> else:
 - 3> consider access to the cell as not barred;
- 1> if access to the cell, as specified above, is not barred:
 - 2> apply the default physical channel configuration as specified in 9.2.4;
 - 2> apply the default semi-persistent scheduling configuration as specified in 9.2.3;
 - 2> apply the default MAC main configuration as specified in 9.2.2;
 - 2> apply the CCCH configuration as specified in 9.1.1.2;
 - 2> apply the *timeAlignmentTimerCommon* included in *SystemInformationBlockType2*;
 - 2> start timer T300;
 - 2> initiate transmission of the *RRCConnectionRequest* message in accordance with 5.3.3.3;

NOTE 2: Upon initiating the connection establishment procedure, the UE is not required to ensure it maintains up to date system information applicable only for UEs in RRC_IDLE state. However, the UE needs to perform system information acquisition upon cell re-selection.

- 1> else:
 - 2> if the UE is establishing the RRC connection for mobile originating calls and if both timers T302 and T303 are not running:

...

- 2> else if the UE is establishing the RRC connection for mobile originating signalling and if both timers T302 and T305 are not running:
 - 3> draw a random number '*rand*' that is uniformly distributed in the range $0 \leq rand < 1$;
 - 3> start timer T305 with the timer value calculated as follows, using the *ac-BarringTime* included in *ac-BarringForMO-Signalling*:

$$T305 = (0.7 + 0.6 * rand) * ac-BarringTime$$
 - 3> inform upper layers about the failure to establish the RRC connection and that access barring for mobile originating signalling is applicable, upon which the procedure ends;

8.1.2.9.3 Test description

8.1.2.9.3.1 Pre-test conditions

System Simulator:

- Cell 1 and Cell 11.

UE:

None.

Preamble:

- The UE is in state Loopback Activated (state 4) with condition UE TEST LOOP MODE B on Cell 1 according to [18].

8.1.2.9.3.2 Test procedure sequence

Table 8.1.2.9.3.2-1: Time instances of cell power level and parameter changes

	Parameter	Unit	Cell 1	Cell 11	Remark
T1	Cell-specific RS EPRE	dBm/15 kHz	-85	-79	The power level values are assigned to satisfy $R_{\text{Cell } 1} < R_{\text{Cell } 11}$.
T2	Cell-specific RS EPRE	dBm/15 kHz	-85	-91	The power level values are assigned to satisfy $R_{\text{Cell } 1} > R_{\text{Cell } 11}$.

Table 8.1.2.9.3.2-2: Main behaviour

St	Procedure	Message Sequence		TP	Verdict
		U - S	Message		
1	The SS transmits an <i>RRConnectionRelease</i> message on Cell 1.	<--	<i>RRConnectionRelease</i>	-	-
2	Wait for 5 s for the UE to enter E-UTRA RRC_IDLE state.	-	-	-	-
3	The SS initializes internal counters: K to 0 and L to 0.	-	-	-	-
-	EXCEPTION: Steps 4 to 5b15 shall be repeated maximum 50 times unless K > 0 and L > 0. (Note 1)	-	-	-	-
4	The SS changes the power level setting according to the row "T1" in table 8.1.2.9.3.2-1.	-	-	-	-
-	EXCEPTION: Steps 5a1 to 5b15 describe behaviours which vary depending on whether the UE transmits an <i>RRConnectionRequest</i> message or not.	-	-	-	-
5a1	IF the UE does not transmit any <i>RRConnectionRequest</i> message within 34 s when K=0 and L=0 and within 8 s for other repeat times, i.e. K ≠ 0 or L ≠ 0 (Note 2) THEN the SS increments the counter K by 1.	-	-	-	-
5a2	The SS changes the power level setting according to the row "T2" in table 8.1.2.9.3.2-1.	-	-	-	-
5a3	The SS waits for 20s for the UE to perform cell reselection procedure. (Note 3)	-	-	-	-
5b1	ELSE IF the UE transmits an <i>RRConnectionRequest</i> message on Cell 1 THEN the SS increments the counter L by 1.	-->	<i>RRConnectionRequest</i>	-	-
5b2-5b6	Steps 2 to 6 of the generic test procedure in TS 36.508 [18] subclause 6.4.2.7 are performed on Cell 1. Note: The UE performs a TAU procedure and the RRC connection is released.	-	-	-	-
5b7	Wait for 5 s for the UE to enter E-UTRA RRC_IDLE state.	-	-	-	-
5b8	The SS changes the power level setting according to the row "T2" in table 8.1.2.9.3.2-1.	-	-	-	-
5b9	The UE transmits an <i>RRConnectionRequest</i> message on Cell 1.	-->	<i>RRConnectionRequest</i>	-	-
5b10-5b14	Steps 2 to 6 of the generic test procedure in TS 36.508 [18] subclause 6.4.2.7 are performed on Cell 1. Note: The UE performs a TAU procedure and the RRC connection is released.	-	-	-	-
5b15	Wait for 5 s for the UE to enter E-UTRA RRC_IDLE state.	-	-	-	-
6	Check: Is the counter K > 0 and L > 0?	-	-	1	P
7	Generic test procedure in TS 36.508 subclause 4.5.3.3 is performed on Cell 1. NOTE: The UE performs the establishment of the new data radio bearer associated with the default EPS bearer context.	-	-	-	-
8	The SS transmits one IP packet to the UE on the DRB associated with the default EPS bearer context on Cell 1.	-	-	-	-
9	Wait for 1 s after the IP packet has been transmitted in step 8. (Note 4)	-	-	-	-
10	The SS transmits an <i>RRConnectionRelease</i> message on Cell 1.	<--	<i>RRConnectionRelease</i>	-	-
11	Check: Does the UE transmit an <i>RRConnectionRequest</i> message on Cell 1 within 30s?	-->	<i>RRConnectionRequest</i>	2	F
-	EXCEPTION: Step 21 and Step 22a1 can happen in any order.	-	-	-	-

12-21	Check: Does the test result of steps 1 to 10 generic test procedure in TS 36.508 subclause 6.4.2.2 indicate that the UE is in E-UTRA RRC_IDLE state on Cell 1?	-	-	1,2	-
-	EXCEPTION: Step 22a1 describes behaviour that depends on UE implementation; the "lower case letter" identifies a step sequence that takes place if the UE has user data pending.	-	-	-	-
22a1	IF the UE has user data pending THEN the UE loop backs the IP packet received in step 8 on the DRB associated with the default EPS bearer context on Cell 1 within 10 s.	-	-	-	-
<p>Note 1: There is an extremely low probability that the UE originating calls are barred, or not barred, 50 times consecutively. (The probability is 1.78×10^{-15}). Therefore, 50 times is enough number of trials for this test case.</p> <p>Note 2: The UE starts T305.</p> <p>Note 3: The UE stops T305 upon cell reselection.</p> <p>Note 4: The 1 second delay is used to secure that the UE have received and forwarded the IP Packet transmitted by the SS in step 8 to the UE test loop function before the <i>RRConnectionRelease</i> message is sent by the SS in step 10.</p>					

8.1.2.9.3.3 Specific message contents

Table 8.1.2.9.3.3-1: SystemInformationBlockType2 for Cell 1 (preamble and all steps, Table 8.1.2.9.3.2-2)

Derivation Path: 36.508, Table 4.4.3.3-1			
Information Element	Value/remark	Comment	Condition
SystemInformationBlockType2 ::= SEQUENCE {			
ac-BarringInfo SEQUENCE {			
ac-BarringForEmergency	FALSE		
ac-BarringForMO-Signalling SEQUENCE {}	Not present		
ac-BarringForMO-Data SEQUENCE {			
ac-BarringFactor	p00		
ac-BarringTime	s512		
ac-BarringForSpecialAC	'11111'B		
}			
}			
}			

Table 8.1.2.9.3.3-2: SystemInformationBlockType2 for Cell 11 (preamble and all steps, Table 8.1.2.9.3.2-2)

Derivation Path: 36.508, Table 4.4.3.3-1			
Information Element	Value/remark	Comment	Condition
SystemInformationBlockType2 ::= SEQUENCE {			
ac-BarringInfo SEQUENCE {			
ac-BarringForEmergency	FALSE		
ac-BarringForMO-Signalling SEQUENCE {			
ac-BarringFactor	p50		
ac-BarringTime	s64		
ac-BarringForSpecialAC	'00000'B		
}			
ac-BarringForMO-Data SEQUENCE {}	Not present		
}			
}			

Table 8.1.2.9.3.3-3: CLOSE UE TEST LOOP (preamble, Table 8.1.2.9.3.2-2)

Derivation Path: 36.508, Table 4.7A-3, condition UE TEST LOOP MODE B			
Information Element	Value/remark	Comment	Condition
UE test loop mode B LB setup			
IP PDU delay	'0000 0101'B	5 seconds	

Table 8.1.2.9.3.3-4: RRCConnectionRequest (step 5b1 and step 5b9, Table 8.1.2.9.3.2-2)

Derivation Path: 36.508, Table 4.6.1-16			
Information Element	Value/remark	Comment	Condition
RRCConnectionRequest ::= SEQUENCE {			
criticalExtensions CHOICE {			
rrcConnectionRequest-r8 SEQUENCE {			
establishmentCause	mo-Signalling		
}			
}			
}			

8.1.2.10 Void

8.1.2.11 RRC connection establishment of emergency call

8.1.2.11.1 Test Purpose (TP)

(1)

```

with { UE in E-UTRA RRC_IDLE state }
ensure that {
  when { UE is requested to make an outgoing emergency call }
  then { UE transmits an RRCConnectionRequest message }
}

```

8.1.2.11.2 Conformance requirements

References: The conformance requirements covered in the current TC are specified in: TS 36.331 clause 5.3.3.2.

[TS 36.331, clause 5.3.3.2]

The UE initiates the procedure when upper layers request establishment of an RRC connection while the UE is in RRC_IDLE.

Upon initiation of the procedure, the UE shall:

...

1> else if the UE is establishing the RRC connection for emergency calls:

 2> if *SystemInformationBlockType2* includes the *ac-BarringInfo*:

...

 2> else:

 3> consider access to the cell as not barred;

...

1> if access to the cell, as specified above, is not barred:

 2> apply the default physical channel configuration as specified in 9.2.4;

 2> apply the default semi-persistent scheduling configuration as specified in 9.2.3;

 2> apply the default MAC main configuration as specified in 9.2.2;

 2> apply the CCCH configuration as specified in 9.1.1.2;

- 2> apply the *timeAlignmentTimerCommon* included in *SystemInformationBlockType2*;
- 2> start timer T300;
- 2> initiate transmission of the *RRCCoalitionRequest* message in accordance with 5.3.3.3;

[TS 36.331, clause 5.3.3.3]

The UE shall set the contents of *RRCCoalitionRequest* message as follows:

...

- 1> set the *establishmentCause* in accordance with the information received from upper layers;

The UE shall submit the *RRCCoalitionRequest* message to lower layers for transmission.

8.1.2.11.3 Test description

8.1.2.11.3.1 Pre-test conditions

System Simulator:

- Cell 1

UE:

None.

Preamble:

- The UE is in state Registered, Idle mode (state 2) according to [18].

8.1.2.11.3.2 Test procedure sequence

Table 8.1.2.11.3.2-1: Main behaviour

St	Procedure	Message Sequence		TP	Verdict
		U - S	Message		
1	Make the UE attempt an IMS emergency call	-	-	-	-
2	Check: Does the UE transmit an <i>RRCCoalitionRequest</i> message?	-->	<i>RRCCoalitionRequest</i>	1	P
3-15	Steps 3 to 15 of the generic test procedure for IMS Emergency call establishment in EUTRA: Normal Service (TS 36.508 4.5A.4.4-1).	-	-	-	-
16	Check: Does the test result of generic test procedure in TS 36.508 subclause 6.4.2.3 indicate that the UE is in E-UTRA RRC_CONNECTED state on Cell 1?	-	-	1	-

Table 8.1.2.11.3.2-2: Void

8.1.2.11.3.3 Specific message contents

Table 8.1.2.11.3.3-1: *RRCCoalitionRequest* (step 2, Table 8.1.2.11.3.2-1)

Derivation Path: 36.508, Table 4.6.1-16			
Information Element	Value/remark	Comment	Condition
<i>RRCCoalitionRequest</i> ::= SEQUENCE {			
<i>criticalExtensions</i> CHOICE {			
<i>rrcCoalitionRequest-r8</i> SEQUENCE {			
<i>establishmentCause</i>	emergency		
}			
}			
}			

8.1.2.12 RRC connection establishment of emergency call / Limited Service

8.1.2.12.1 Test Purpose (TP)

(1)

```
with { UE in E-UTRA RRC_IDLE state }
ensure that {
  when { UE camp on an acceptable cell and is requested to make an outgoing emergency call }
  then { UE transmits an RRCConnectionRequest message }
}
```

8.1.2.12.2 Conformance requirements

References: The conformance requirements covered in the current TC are specified in: TS 36.304 clause 4.3, 5.2.3.1 and TS 36.331 clause 5.3.3.2.

[TS 36.304, clause 4.3]

This clause defines the level of service that may be provided by the network to a UE in Idle mode.

The action of camping on a cell is necessary to get access to some services. Three levels of services are defined for UE:

- Limited service (emergency calls, ETWS and CMAS on an acceptable cell)
- Normal service (for public use on a suitable cell)
- Operator service (for operators only on a reserved cell)

Furthermore, the cells are categorised according to which services they offer:

acceptable cell:

An "acceptable cell" is a cell on which the UE may camp to obtain limited service (originate emergency calls and receive ETWS and CMAS notifications). Such a cell shall fulfil the following requirements, which is the minimum set of requirements to initiate an emergency call and to receive ETWS and CMAS notification in a E-UTRAN network:

- The cell is not barred, see subclause 5.3.1;
- The cell selection criteria are fulfilled, see subclause 5.2.3.2;

suitable cell:

A "suitable cell" is a cell on which the UE may camp on to obtain normal service. The UE shall have a valid USIM and such a cell shall fulfil all the following requirements.

- The cell is part of either:
 - the selected PLMN, or:
 - the registered PLMN, or:
 - a PLMN of the Equivalent PLMN list
 according to the latest information provided by NAS:
- The cell is not barred, see subclause 5.3.1;
- The cell is part of at least one TA that is not part of the list of "forbidden tracking areas for roaming", which belongs to a PLMN that fulfils the first bullet above;
- The cell selection criteria are fulfilled, see subclause 5.2.3.2;
- For a CSG cell, the CSG ID is part of the CSG whitelist of the UE.

If more than one PLMN identity is broadcast in the cell, the cell is considered to be part of all TAs with TAIs constructed from the PLMN identities and the TAC broadcast in the cell.

[TS 36.304, clause 5.2.3.1]

The UE shall use one of the following two cell selection procedures:

a) Initial Cell Selection

This procedure requires no prior knowledge of which RF channels are E-UTRA carriers. The UE shall scan all RF channels in the E-UTRA bands according to its capabilities to find a suitable cell. On each carrier frequency, the UE need only search for the strongest cell. Once a suitable cell is found this cell shall be selected.

b) Stored Information Cell Selection

This procedure requires stored information of carrier frequencies and optionally also information on cell parameters, from previously received measurement control information elements or from previously detected cells. Once the UE has found a suitable cell the UE shall select it. If no suitable cell is found the Initial Cell Selection procedure shall be started.

NOTE: Priorities between different frequencies or RATs provided to the UE by system information or dedicated signalling are not used in the cell selection process.

[TS 36.331, clause 5.3.3.2]

The UE initiates the procedure when upper layers request establishment of an RRC connection while the UE is in RRC_IDLE.

Upon initiation of the procedure, the UE shall:

...

1> else if the UE is establishing the RRC connection for emergency calls:

2> if *SystemInformationBlockType2* includes the *ac-BarringInfo*:

...

2> else:

3> consider access to the cell as not barred;

...

1> if access to the cell, as specified above, is not barred:

2> apply the default physical channel configuration as specified in 9.2.4;

2> apply the default semi-persistent scheduling configuration as specified in 9.2.3;

2> apply the default MAC main configuration as specified in 9.2.2;

2> apply the CCCH configuration as specified in 9.1.1.2;

2> apply the *timeAlignmentTimerCommon* included in *SystemInformationBlockType2*;

2> start timer T300;

2> initiate transmission of the *RRCConnectionRequest* message in accordance with 5.3.3.3;

[TS 36.331, clause 5.3.3.3]

The UE shall set the contents of *RRCConnectionRequest* message as follows:

...

1> set the *establishmentCause* in accordance with the information received from upper layers;

The UE shall submit the *RRCConnectionRequest* message to lower layers for transmission.

[TS 36.331, clause 6.2.2]

<i>SystemInformationBlockType1</i> field descriptions
...
ims-EmergencySupport Indicates whether the cell supports IMS emergency bearer services for UEs in limited service mode. If absent, IMS emergency call is not supported by the network in the cell for UEs in limited service mode.

8.1.2.12.3 Test description

8.1.2.12.3.1 Pre-test conditions

System Simulator:

- Cell 1
- The PLMN is defined in Table 8.1.2.12.3.1-1.

Table 8.1.2.12.3.1-1: PLMN identifier

Cell	PLMN name
1	PLMN4

UE:

- The UE is equipped with a USIM containing default values except for those listed in Table 8.1.2.12.3.1-2.

Table 8.1.2.12.3.1-2: USIM configuration

USIM field	Priority	Value	Access Technology Identifier
EF _{IMSI}		The HPLMN (MCC+MNC) of the IMSI is set to PLMN1.	
EF _{FPLMN}		PLMN4	
EF _{PLMNwACT}	1	Default	E-UTRAN
EF _{OPLMNwACT}	1	PLMN1	E-UTRAN
EF _{HPLMNwACT}	1	PLMN1	E-UTRAN

Preamble:

- The UE is Switched OFF (State 1) according to [18].

8.1.2.12.3.2 Test procedure sequence

Table 8.1.2.12.3.2-1: Main behaviour

St	Procedure	Message Sequence		TP	Verdict
		U - S	Message		
1	Power on the UE.	-	-	-	-
2	Wait 60s for the UE to camp on Cell 1 as an acceptable cell.	-	-	-	-
3	Make the UE attempt an IMS emergency call	-	-	-	-
4	Check: Does the UE transmit an <i>RRCConectionRequest</i> message?	-->	<i>RRCConectionRequest</i>	1	P
5-21	Steps 3 to 19 of the generic test procedure for IMS Emergency call establishment in EUTRA: Limited Service (TS 36.508 4.5A.5.3-1).	-	-	-	-

Table 8.1.2.12.3.2-2: Void

8.1.2.12.3.3 Specific message contents

Table 8.1.2.12.3.3-1: *RRCCConnectionRequest* (step 3, Table 8.1.2.12.3.2-1)

Derivation Path: 36.508, Table 4.6.1-16			
Information Element	Value/remark	Comment	Condition
RRCCConnectionRequest ::= SEQUENCE {			
criticalExtensions CHOICE {			
rrcConnectionRequest-r8 SEQUENCE {			
establishmentCause	emergency		
}			
}			
}			
}			

Table 8.1.2.12.3.3-2: Void

8.1.2.13 RRC connection establishment / 0% access probability for MO calls, 0% access probability for MO signalling

8.1.2.13.1 Test Purpose (TP)

(1)

```

with { UE in E-UTRA RRC_IDLE state }
ensure that {
  when { UE reselects a new cell which belongs to different TA and broadcasts
SystemInformationBlockType2 indicating 0% access probability for MO signalling }
  then { UE does not transmit any RRCCConnectionRequest message }
}

```

(2)

```

with { UE in E-UTRA RRC_IDLE state having received SystemInformationBlockType2 indicating 0% access
probability for MO call and for MO signalling }
ensure that {
  when { UE receives a Paging message }
  then { UE transmits an RRCCConnectionRequest message }
}

```

(3)

```

with { UE in E-UTRA RRC_IDLE state having received SystemInformationBlockType2 indicating 0% access
probability for MO call }
ensure that {
  when { UE has user data pending }
  then { UE does not transmit any RRCCConnectionRequest message }
}

```

8.1.2.13.2 Conformance requirements

References: The conformance requirements covered in the present TC are specified in: TS 36.331, clause 5.3.3.2.

[TS 36.331, clause 5.3.3.2]

The UE initiates the procedure when upper layers request establishment of an RRC connection while the UE is in RRC_IDLE.

Upon initiation of the procedure, the UE shall:

1> if the UE is establishing the RRC connection for mobile terminating calls:

...

1> else if the UE is establishing the RRC connection for emergency calls:

...

- 1> else if the UE is establishing the RRC connection for mobile originating calls:
 - 2> if timer T302 or T303 is running:
 - 3> consider access to the cell as barred;
 - 2> else if *SystemInformationBlockType2* includes the *ac-BarringInfo* and the *ac-BarringForMO-Data* is present:
 - 3> if the UE has one or more Access Classes, as stored on the USIM, with a value in the range 11..15, which is valid for the UE to use according to TS 22.011 [10] and TS 23.122 [11], and
 - 3> for at least one of these Access Classes the corresponding bit in the *ac-BarringForSpecialAC* contained in *ac-BarringForMO-Data* is set to *zero*:
 - 4> consider access to the cell as not barred;
 - 3> else:
 - 4> draw a random number '*rand*' uniformly distributed in the range: $0 \leq rand < 1$;
 - 4> if '*rand*' is lower than the value indicated by *ac-BarringFactor* included in *ac-BarringForMO-Data*:
 - 5> consider access to the cell as not barred;
 - 4> else:
 - 5> consider access to the cell as barred;
 - 2> else:
 - 3> consider access to the cell as not barred;
- 1> else (the UE is establishing the RRC connection for mobile originating signalling):
 - 2> if timer T302 or T305 is running:
 - 3> consider access to the cell as barred;
 - 2> else if *SystemInformationBlockType2* includes the *ac-BarringInfo* and the *ac-BarringForMO-Signalling* is present:
 - 3> if the UE has one or more Access Classes, as stored on the USIM, with a value in the range 11..15, which is valid for the UE to use according to TS 22.011 [10] and TS 23.122 [11], and
 - 3> for at least one of these Access Classes the corresponding bit in the *ac-BarringForSpecialAC* contained in *ac-BarringForMO-Signalling* is set to *zero*:
 - 4> consider access to the cell as not barred;
 - 3> else:
 - 4> draw a random number '*rand*' uniformly distributed in the range: $0 \leq rand < 1$;
 - 4> if '*rand*' is lower than the value indicated by *ac-BarringFactor* included in *ac-BarringForMO-Signalling*:
 - 5> consider access to the cell as not barred;
 - 4> else:
 - 5> consider access to the cell as barred;
 - 2> else:
 - 3> consider access to the cell as not barred;
- 1> if access to the cell, as specified above, is not barred:

- 2> apply the default physical channel configuration as specified in 9.2.4;
- 2> apply the default semi-persistent scheduling configuration as specified in 9.2.3;
- 2> apply the default MAC main configuration as specified in 9.2.2;
- 2> apply the CCCH configuration as specified in 9.1.1.2;
- 2> apply the *timeAlignmentTimerCommon* included in *SystemInformationBlockType2*;
- 2> start timer T300;
- 2> initiate transmission of the *RRCConnectionRequest* message in accordance with 5.3.3.3;

NOTE 2: Upon initiating the connection establishment procedure, the UE is not required to ensure it maintains up to date system information applicable only for UEs in RRC_IDLE state. However, the UE needs to perform system information acquisition upon cell re-selection.

1> else:

- 2> if the UE is establishing the RRC connection for mobile originating calls and if both timers T302 and T303 are not running:

...

- 2> else if the UE is establishing the RRC connection for mobile originating signalling and if both timers T302 and T305 are not running:

- 3> draw a random number '*rand*' that is uniformly distributed in the range $0 \leq rand < 1$;

- 3> start timer T305 with the timer value calculated as follows, using the *ac-BarringTime* included in *ac-BarringForMO-Signalling*:

$$T305 = (0.7 + 0.6 * rand) * ac-BarringTime$$

- 3> inform upper layers about the failure to establish the RRC connection and that access barring for mobile originating signalling is applicable, upon which the procedure ends;

8.1.2.13.3 Test description

8.1.2.13.3.1 Pre-test conditions

System Simulator:

- Cell 1 and Cell 11.

UE:

None.

Preamble:

- The UE is in state Loopback Activated (state 4) with condition UE TEST LOOP MODE B on Cell 1 according to [18].

8.1.2.13.3.2 Test procedure sequence

Table 8.1.2.13.3.2-1: Time instances of cell power level and parameter changes

	Parameter	Unit	Cell 1	Cell 11	Remark
T1	Cell-specific RS EPRE	dBm/15 kHz	-85	-79	The power level values are assigned to satisfy $R_{Cell\ 1} < R_{Cell\ 11}$.
T2	Cell-specific RS EPRE	dBm/15 kHz	-85	-91	The power level values are assigned to satisfy $R_{Cell\ 1} > R_{Cell\ 11}$.

Table 8.1.2.13.3.2-2: Main behaviour

St	Procedure	Message Sequence		TP	Verdict
		U - S	Message		
1	The SS transmits an <i>RRConnectionRelease</i> message on Cell 1.	<--	<i>RRConnectionRelease</i>	-	-
2	Wait for 5 s for the UE to enter E-UTRA RRC_IDLE state.	-	-	-	-
3	The SS changes the power level setting according to the row "T1" in table 8.1.2.13.3.2-1.	-	-	-	-
4	Check: Does the UE transmit an <i>RRConnectionRequest</i> message on Cell 1 within 40s? (Note 1)	-->	<i>RRConnectionRequest</i>	1	F
5	The SS transmits a <i>Paging</i> message including a matched identity allocated in Cell 1.	<--	<i>Paging</i>	-	-
6	Check: Does the UE transmit an <i>RRConnectionRequest</i> message on Cell 1 within 30s? (Note 2)	-->	<i>RRConnectionRequest</i>	1	F
7	The SS changes the <i>SystemInformationBlockType1</i> and <i>SystemInformationBlockType2</i> on Cell 1 according to Table 8.1.2.13.3.3-1.	-	-	-	-
7A	Wait for 2.1* modification period (Note 5) to allow the new system information to take effect.	-	-	-	-
7B	The SS changes the power level setting according to the row "T2" in table 8.1.2.13.3.2-1.	-	-	-	-
8	The SS waits for 40s the UE to perform cell reselection procedure (Note 3).	-	-	-	-
9	The SS sends a <i>Paging</i> message to the UE on the appropriate paging block, and including the UE identity in one entry of the IE <i>pagingRecordLists</i> on Cell 1.	<--	<i>Paging</i>	-	-
10	Check: Does the UE transmit an <i>RRConnectionRequest</i> message on Cell 1?	-->	<i>RRConnectionRequest</i>	2	P
11-16	Steps 4 to 9 of the generic test procedure in TS 36.508 subclause 4.5.3.3 are performed on Cell 1. NOTE: The UE performs the establishment of the new data radio bearer associated with the default EPS bearer context.	-	-	-	-
17	The SS transmits one IP packet to the UE on the DRB associated with the default EPS bearer context on Cell 1.	-	-	-	-
18	Wait for 1 s after the IP packet has been transmitted in step 17. (Note 4)	-	-	-	-
19	The SS transmits an <i>RRConnectionRelease</i> message on Cell 1.	<--	<i>RRConnectionRelease</i>	-	-
20	Check: Does the UE transmit an <i>RRConnectionRequest</i> message on Cell 1 within 10s?	-->	<i>RRConnectionRequest</i>	3	F
-	EXCEPTION: Step 30 and Step 31a1 can happen in any order.	-	-	-	-
21-30	Check: Does the test result of steps 1 to 10 generic test procedure in TS 36.508 subclause 6.4.2.2 indicate that the UE is in E-UTRA RRC_IDLE state on Cell 1?	-	-	1,2,3	-
-	EXCEPTION: Step 31a1 describes behaviour that depends on UE implementation; the "lower case letter" identifies a step sequence that takes place if the UE has user data pending.	-	-	-	-
31a1	IF the UE has user data pending THEN the UE loops back the IP packet received in step 17 on the DRB associated with the default EPS	-	-	-	-

	bearer context on Cell 1 within 10 s.			
Note 1:	The UE starts T305.			
Note 2:	In case that the UE did not response to paging on Cell 1, it is considered that the UE is camped on Cell 11.			
Note 3:	The UE stops T305 upon cell reselection.			
Note 4:	The 1 second delay is used to secure that the UE have received and forwarded the IP Packet transmitted by the SS in step 17 to the UE test loop function before the <i>RRCCConnectionRelease</i> message is sent by the SS in step 19.			
Note 5:	The wait time of 2.1* modification period in step 7A is to allow for the network to paging the system information change during the next modification period, and update the system information at the subsequent modification period. UE should acquire the updated system information within 100ms of the start of modification period.			

8.1.2.13.3.3 Specific message contents

Table 8.1.2.13.3.3-1: SystemInformationBlockType2 for Cell 1 (step 7, Table 8.1.2.13.3.2-2)

Derivation Path: 36.508, Table 4.4.3.3-1			
Information Element	Value/remark	Comment	Condition
SystemInformationBlockType2 ::= SEQUENCE {			
ac-BarringInfo SEQUENCE {			
ac-BarringForEmergency	FALSE		
ac-BarringForMO-Signalling SEQUENCE {			
ac-BarringFactor	p0		
ac-BarringTime	s8		
ac-BarringForSpecialAC	'11111'B		
}			
ac-BarringForMO-Data SEQUENCE {			
ac-BarringFactor	p0		
ac-BarringTime	s512		
ac-BarringForSpecialAC	'11111'B		
}			
}			
}			

Table 8.1.2.13.3.3-2: SystemInformationBlockType1 for Cell 1 (step 7, Table 8.1.2.13.3.2-2)

Derivation Path: 36.508, Table 4.4.3.2-3			
Information Element	Value/remark	Comment	Condition
SystemInformationBlockType1 ::= SEQUENCE {			
systemInfoValueTag	1		
}			

Table 8.1.2.13.3.3-3: SystemInformationBlockType2 for Cell 11 (preamble and all steps, Table 8.1.2.13.3.2-2)

Derivation Path: 36.508, Table 4.4.3.3-1			
Information Element	Value/remark	Comment	Condition
SystemInformationBlockType2 ::= SEQUENCE {			
ac-BarringInfo SEQUENCE {			
ac-BarringForEmergency	FALSE		
ac-BarringForMO-Signalling SEQUENCE {			
ac-BarringFactor	p0		
ac-BarringTime	s512		
ac-BarringForSpecialAC	'11111'B		
}			
ac-BarringForMO-Data SEQUENCE {}	Not present		
}			
}			

Table 8.1.2.13.3.3-4: CLOSE UE TEST LOOP (preamble, Table 8.1.2.13.3.2-2)

Derivation Path: 36.508, Table 4.7A-3, condition UE TEST LOOP MODE B			
Information Element	Value/remark	Comment	Condition
UE test loop mode B LB setup			
IP PDU delay	'0000 0101'B	5 seconds	

8.1.2.14 RRC connection establishment / High speed flag

8.1.2.14.1 Test Purpose (TP)

(1)

```
with { UE in E-UTRA RRC_IDLE state having received a SystemInformationBlockType2 indicating an IE highSpeedFlag set to true }
ensure that {
  when { UE receives a Paging message }
  then { UE establishes an RRC connection }
}
```

8.1.2.14.2 Conformance requirements

References: The conformance requirements covered in the present TC are specified in: TS 36.331, clauses 5.2.2.9 and 6.3.2.

[TS 36.331, clause 5.2.2.9]

Upon receiving *SystemInformationBlockType2*, the UE shall:

...

1> apply the configuration included in the *radioResourceConfigCommon*;

[TS 36.331, clause 6.3.2]

PRACH-Config field descriptions
...
highSpeedFlag Parameter: High-speed-flag, see TS 36.211, [21, 5.7.2]. TRUE corresponds to Restricted set and FALSE to Unrestricted set.

8.1.2.14.3 Test description

8.1.2.14.3.1 Pre-test conditions

System Simulator:

- Cell 1 and Cell 2.

UE:

None.

Preamble:

- The UE is in state Registered, Idle mode (state 2) on Cell 1 according to [18].

8.1.2.14.3.2 Test procedure sequence

Table 8.1.2.14.3.2-1 illustrates the downlink power levels to be applied for the cells at various time instants of the test execution. The configuration marked "T1" is applied at the point indicated in the Main behaviour description in Table 8.1.2.14.3.2-2.

Table 8.1.2.14.3.2-1: Time instances of cell power level and parameter changes

	Parameter	Unit	Cell 1	Cell 2	Remark
T1	Cell-specific RS EPRE	dBm/15 kHz	-85	-79	The power level values are assigned to satisfy $R_{Cell\ 1} < R_{Cell\ 2}$.

Table 8.1.2.14.3.2-2: Main behaviour

St	Procedure	Message Sequence		TP	Verdict
		U - S	Message		
1	The SS changes Cell 2 level according to the row "T1" in table 8.1.2.14.3.2-1.	-	-	-	-
2	The SS waits for 40s for the UE to perform cell reselection procedure.	-	-	-	-
3	The SS transmits a <i>Paging</i> message on Cell 2.	<--	<i>Paging</i>	-	-
4	Check: Does the UE transmit an <i>RRCConnectionRequest</i> message on Cell 2?	-->	<i>RRCConnectionRequest</i>	1	P
5-10	Steps 4 to 9 of the generic radio bearer establishment procedure (TS 36.508 4.5.3.3-1) are executed to successfully complete the service request procedure on Cell 2.	-	-	-	-
11	Check: Does the test result of generic test procedure in TS 36.508 subclause 6.4.2.3 indicate that the UE is in E-UTRA RRC_CONNECTED state on Cell 2?	-	-	1	-

8.1.2.14.3.3 Specific message contents

Table 8.1.2.14.3.3-1: SystemInformationBlockType2 for Cell 2 (preamble and all steps, Table 8.1.2.14.3.2-2)

Derivation Path: 36.508 Table 4.4.3.3-1			
Information Element	Value/remark	Comment	Condition
SystemInformationBlockType2 ::= SEQUENCE {			
radioResourceConfigCommon SEQUENCE {			
prach-Config SEQUENCE {			
rootSequenceIndex	86		
prach-ConfigInfo SEQUENCE {			
highSpeedFlag	true		
}			
}			
}			

8.1.3 RRC connection release

8.1.3.1 RRC connection release / Success

8.1.3.1.1 Test Purpose (TP)

(1)

```

with { UE in RRC_CONNECTED state }
ensure that {
  when { UE receives an RRCConnectionRelease message }
  then { UE releases the signalling connection, the established EPS bearer and all radio resources
and enters in RRC_IDLE state }
}

```

8.1.3.1.2 Conformance requirements

References: The conformance requirements covered in the present TC are specified in: 3GPP TS 36.331 clause 5.3.8.3 and 5.3.12.

[TS 36.331, clause 5.3.8.3]

The UE shall:

- 1> delay the following actions defined in this sub-clause 60ms from the moment the *RRConnectionRelease* message was received or optionally when lower layers indicate that the receipt of the *RRConnectionRelease* message has been successfully acknowledged, whichever is earlier;
- ...
- 1> if the *releaseCause* received in the *RRConnectionRelease* message indicates '*loadBalancingTAURequired*':
 - 2> perform the actions upon leaving RRC_CONNECTED as specified in 5.3.12, with release cause 'load balancing TAU required';
- 1> else:
 - 2> perform the actions upon leaving RRC_CONNECTED as specified in 5.3.12, with release cause 'other'.

[TS 36.331, clause 5.3.12]

Upon leaving RRC_CONNECTED, the UE shall:

- 1> reset MAC;
- 1> stop all timers that are running except T320;
- 1> release all radio resources, including release of the RLC entity, the MAC configuration and the associated PDCP entity for all established RBs;
- 1> indicate the release of the RRC connection to upper layers together with the release cause;
- 1> if leaving RRC_CONNECTED was not triggered by reception of the *MobilityFromEUTRACommand* message:
 - 2> enter RRC_IDLE by performing cell selection in accordance with the cell selection process, defined for the case of leaving RRC_CONNECTED, as specified in TS 36.304 [4].

8.1.3.1.3 Test description

8.1.3.1.3.1 Pre-test conditions

System Simulator:

- Cell 1

UE:

None.

Preamble:

- The UE is in state Generic RB Established (state 3) according to [18].

8.1.3.1.3.2 Test procedure sequence

Table 8.1.3.1.3.2-1: Main behaviour

St	Procedure	Message Sequence		TP	Verdict
		U - S	Message		
1	SS transmits an <i>RRConnectionRelease</i> message to release the RRC connection.	<--	<i>RRConnectionRelease</i>	-	-
2	SS waits for 5s.	-	-	-	-
3	Check: Does the test result of generic test procedure in TS 36.508 subclause 6.4.2.2 indicate that the UE is in E-UTRA RRC_IDLE state on Cell 1?	-	-	1	-

8.1.3.1.3.3 Specific message content

None.

8.1.3.2 Void

8.1.3.3 Void

8.1.3.4 RRC connection release / Redirection to another E-UTRAN frequency

8.1.3.4.1 Test Purpose (TP)

(1)

```
with { UE in E-UTRA RRC_CONNECTED state }
ensure that {
  when { UE receives an RRCConnectionRelease message including an IE redirectedCarrierInfo with
  extra different from the frequency UE was on in RRC_CONNECTED state}
  then { UE enters RRC_IDLE state on new frequency included in IE redirectedCarrierInfo }
}
```

8.1.3.4.2 Conformance requirements

References: The conformance requirements covered in the current TC are specified in: TS 36.331, clauses 5.3.8.3, 5.3.12 and TS 36.304, clauses 5.2.4.1, 5.2.7.

[TS 36.331, clause 5.3.8.3]

The UE shall:

- 1> delay the following actions defined in this sub-clause 60ms from the moment the *RRCConnectionRelease* message was received or optionally when lower layers indicate that the receipt of the *RRCConnectionRelease* message has been successfully acknowledged, whichever is earlier;
- 1> if the *RRCConnectionRelease* message includes the *idleModeMobilityControlInfo*:
 - ...
- 1> else:
 - 2> apply the cell reselection priority information broadcast in the system information;
- 1> if the *releaseCause* received in the *RRCConnectionRelease* message indicates '*loadBalancingTAURequired*':
 - ...
- 1> else:
 - 2> perform the actions upon leaving RRC_CONNECTED as specified in 5.3.12, with release cause 'other'.

[TS 36.331, clause 5.3.12]

Upon leaving RRC_CONNECTED, the UE shall:

- ...
- 1> indicate the release of the RRC connection to upper layers together with the release cause;
- 1> if leaving RRC_CONNECTED was not triggered by reception of the *MobilityFromEUTRACommand* message:
 - 2> enter RRC_IDLE by performing cell selection in accordance with the cell selection process, defined for the case of leaving RRC_CONNECTED, as specified in TS 36.304 [4].

[TS 36.304, clause 5.2.4.1]

...

UE shall only perform cell reselection evaluation for E-UTRAN frequencies and inter-RAT frequencies that are given in system information and for which the UE has a priority provided.

...

[TS 36.304, clause 5.2.7]

On transition from RRC_CONNECTED to RRC_IDLE, UE shall select a suitable cell to camp on according to *redirectedCarrierInfo*, if included in the *RRCConnectionRelease* message. Otherwise UE shall select a suitable cell on an EUTRA carrier. If no suitable cell is found, the UE shall perform a cell selection starting with Stored Information Cell Selection procedure in order to find a suitable cell to camp on.

...

8.1.3.4.3 Test description

8.1.3.4.3.1 Pre-test conditions

System Simulator:

- 2 cells on different E-UTRA frequencies and different tracking areas:
 - Cell 1 serving cell
 - Cell 23 suitable neighbour inter-frequency cell
 - Cell power levels are selected according to [18] so that camping on Cell 1 is guaranteed
 - System information combination 3 as defined in TS 36.508 [18] clause 4.4.3.1 is used in E-UTRA cells.

UE:

None.

Preamble:

- The UE is in state Generic RB Established (state 3) according to [18] on cell 1.

8.1.3.4.3.2 Test procedure sequence

Table 8.1.3.4.3.2-1: Main behaviour

St	Procedure	Message Sequence		TP	Verdict
		U - S	Message		
1	SS transmits an <i>RRCConnectionRelease</i> message (IE <i>redirectedCarrierInfo</i> including <i>eutra</i> of Cell 23).	<--	<i>RRCConnectionRelease</i>	-	-
2	Check: does the test result of generic test procedure in TS 36.508 subclause 6.4.2.7 indicate that the UE is camped on E-UTRAN Cell 23?	-	-	1	-

8.1.3.4.3.3 Specific message contents

Table 8.1.3.4.3.3-1: Conditions for table 8.1.3.4.3.3-3

Condition descriptions
Cell 1 This condition applies to system information transmitted on Cell 1.
Cell 23 This condition applies to system information transmitted on Cell 23.

Table 8.1.3.4.3.3-2: *Void*Table 8.1.3.4.3.3-3: *SystemInformationBlockType5* for cells 1 and 23 (preamble and all steps, Table 8.1.3.4.3.2-1)

Derivation Path: 36.508 table 4.4.3.3-4			
Information Element	Value/remark	Comment	Condition
SystemInformationBlockType5 ::= SEQUENCE {			
interFreqCarrierFreqList SEQUENCE (SIZE (1..maxFreq)) OF SEQUENCE {			
dl-CarrierFreq[n]	Same downlink EARFCN as used for Cell 23		Cell 1
	Same downlink EARFCN as used for Cell 1		Cell 23
cellReselectionPriority[n]	Not present		
}			
}			

Table 8.1.3.4.3.3-4: *RRCConnectionRelease* message (step 1, Table 8.1.3.4.3.2-1)

Derivation Path: 36.508 table 4.6.1-15			
Information Element	Value/remark	Comment	Condition
RRCConnectionRelease ::= SEQUENCE {			
criticalExtensions CHOICE {			
c1 CHOICE {			
rrcConnectionRelease-r8 SEQUENCE {			
redirectedCarrierInfo ::= CHOICE {			
eutra	Downlink EARFCN of cell 23		
}			
}			
}			
}			
}			

8.1.3.5 RRC connection release / Success / With priority information

8.1.3.5.1 Test Purpose (TP)

(1)

```
with { UE in E-UTRA RRC_IDLE state having received an RRCConnectionRelease message with the
freqPriorityListEUTRA with higher priority frequency}
ensure that {
  when { UE detects the cell re-selection criteria are met for the cell which belongs to the higher
priority frequency }
  then { UE reselects the cell which belongs to the higher priority frequency }
}
```

8.1.3.5.2 Conformance requirements

References: The conformance requirements covered in the present TC are specified in: TS 36.331, clause 5.3.8.3 and TS 36.304, clause 5.2.4.1, 5.2.4.2 and 5.2.4.5.

[TS 36.331, clause 5.3.8.3]

The UE shall:

- 1> delay the following actions defined in this sub-clause 60 ms from the moment the *RRCConnectionRelease* message was received or optionally when lower layers indicate that the receipt of the *RRCConnectionRelease* message has been successfully acknowledged, whichever is earlier;
- 1> if the *RRCConnectionRelease* message includes the *idleModeMobilityControlInfo*:
 - 2> store the cell reselection priority information provided by the *idleModeMobilityControlInfo*;

2> if the $t320$ is included:

3> start timer T320, with the timer value set according to the value of $t320$;

1> else:

...

1> if the *releaseCause* received in the *RRCConnectionRelease* message indicates '*loadBalancingTAURequired*':

2> perform the actions upon leaving RRC_CONNECTED as specified in 5.3.12, with release cause 'load balancing TAU required';

1> else:

2> perform the actions upon leaving RRC_CONNECTED as specified in 5.3.12, with release cause 'other';

[TS 36.304, clause 5.2.4.1]

Absolute priorities of different E-UTRAN frequencies or inter-RAT frequencies may be provided to the UE in the system information, in the *RRCConnectionRelease* message, or by inheriting from another RAT at inter-RAT cell (re)selection. In the case of system information, an E-UTRAN frequency or inter-RAT frequency may be listed without providing a priority (i.e. the field *cellReselectionPriority* is absent for that frequency). If priorities are provided in dedicated signalling, the UE shall ignore all the priorities provided in system information. If UE is in *camped on any cell* state, UE shall only apply the priorities provided by system information from current cell, and the UE preserves priorities provided by dedicated signalling unless specified otherwise. When the UE in *camped normally* state, has only dedicated priorities other than for the current frequency, the UE shall consider the current frequency to be the lowest priority frequency (i.e. lower than the eight network configured values). While the UE is camped on a suitable CSG cell, the UE shall always consider the current frequency to be the highest priority frequency (i.e. higher than the eight network configured values), irrespective of any other priority value allocated to this frequency. The UE shall delete priorities provided by dedicated signalling when:

- the UE enters RRC_CONNECTED state; or
- the optional validity time of dedicated priorities (T320) expires; or
- a PLMN selection is performed on request by NAS [5].

NOTE: Equal priorities between RATs are not supported.

The UE shall only perform cell reselection evaluation for E-UTRAN frequencies and inter-RAT frequencies that are given in system information and for which the UE has a priority provided.

The UE shall not consider any black listed cells as candidate for cell reselection.

The UE shall inherit the priorities provided by dedicated signalling and the remaining validity time (i.e., T320 in E-UTRA, T322 in UTRA and T3230 in GERAN), if configured, at inter-RAT cell (re)selection.

NOTE: The network may assign dedicated cell reselection priorities for frequencies not configured by system information.

[TS 36.304, clause 5.2.4.2]

When evaluating S_{rxlev} and S_{qual} of non-serving cells for reselection purposes, the UE shall use parameters provided by the serving cell.

Following rules are used by the UE to limit needed measurements:

- If the serving cell fulfils $S_{rxlev} > S_{IntraSearchP}$ and $S_{qual} > S_{IntraSearchQ}$, the UE may choose not to perform intra-frequency measurements.
- Otherwise, the UE shall perform intra-frequency measurements.
- The UE shall apply the following rules for E-UTRAN inter-frequencies and inter-RAT frequencies which are indicated in system information and for which the UE has priority provided as defined in 5.2.4.1:

- For an E-UTRAN inter-frequency or inter-RAT frequency with a reselection priority higher than the reselection priority of the current E-UTRA frequency the UE shall perform measurements of higher priority E-UTRAN inter-frequency or inter-RAT frequencies according to [10].
- For an E-UTRAN inter-frequency with an equal or lower reselection priority than the reselection priority of the current E-UTRA frequency and for inter-RAT frequency with lower reselection priority than the reselection priority of the current E-UTRAN frequency:
 - If the serving cell fulfils $S_{rxlev} > S_{nonIntraSearchP}$ and $S_{qual} > S_{nonIntraSearchQ}$, the UE may choose not to perform measurements of E-UTRAN inter-frequencies or inter-RAT frequency cells of equal or lower priority.
 - Otherwise, the UE shall perform measurements of E-UTRAN inter-frequencies or inter-RAT frequency cells of equal or lower priority according to [10].

[TS 36.304, clause 5.2.4.5]

If *threshServingLowQ* is provided in *SystemInformationBlockType3*, cell reselection to a cell on a higher priority E-UTRAN frequency or inter-RAT frequency than the serving frequency shall be performed if:

- A cell of a higher priority EUTRAN or UTRAN RAT/ frequency fulfils $S_{qual} > Thresh_{X, HighQ}$ during a time interval $T_{reselection_{RAT}}$; or
- A cell of a higher priority GERAN or CDMA2000 RAT/ frequency fulfils $S_{rxlev} > Thresh_{X, HighP}$ during a time interval $T_{reselection_{RAT}}$; and
- More than 1 second has elapsed since the UE camped on the current serving cell.

Otherwise, cell reselection to a cell on a higher priority E-UTRAN frequency or inter-RAT frequency than the serving frequency shall be performed if:

- A cell of a higher priority RAT/ frequency fulfils $S_{rxlev} > Thresh_{X, HighP}$ during a time interval $T_{reselection_{RAT}}$; and

More than 1 second has elapsed since the UE camped on the current serving cell.

Cell reselection to a cell on an equal priority E-UTRAN frequency shall be based on ranking for Intra-frequency cell reselection as defined in sub-clause 5.2.4.6.

If *threshServingLowQ* is provided in *SystemInformationBlockType3*, cell reselection to a cell on a lower priority E-UTRAN frequency or inter-RAT frequency than the serving frequency shall be performed if:

- The serving cell fulfils $S_{qual} < Thresh_{Serving, LowQ}$ and a cell of a lower priority EUTRAN or UTRAN RAT/ frequency fulfils $S_{qual} > Thresh_{X, LowQ}$ during a time interval $T_{reselection_{RAT}}$; or
- The serving cell fulfils $S_{qual} < Thresh_{Serving, LowQ}$ and a cell of a lower priority GERAN or CDMA2000 RAT/ frequency fulfils $S_{rxlev} > Thresh_{X, LowP}$ during a time interval $T_{reselection_{RAT}}$; and
- More than 1 second has elapsed since the UE camped on the current serving cell.

Otherwise, cell reselection to a cell on a lower priority E-UTRAN frequency or inter-RAT frequency than the serving frequency shall be performed if:

- The serving cell fulfils $S_{rxlev} < Thresh_{Serving, LowP}$ and a cell of a lower priority RAT/ frequency fulfils $S_{rxlev} > Thresh_{X, LowP}$ during a time interval $T_{reselection_{RAT}}$; and
- More than 1 second has elapsed since the UE camped on the current serving cell.

Cell reselection to a higher priority RAT/ frequency shall take precedence over a lower priority RAT/ frequency, if multiple cells of different priorities fulfil the cell reselection criteria.

For cdma2000 RATs, S_{rxlev} is equal to $-FLOOR(-2 \times 10 \times \log_{10} E_c/I_o)$ in units of 0.5 dB, as defined in [18], with E_c/I_o referring to the value measured from the evaluated cell.

For cdma2000 RATs, $Thresh_{X, HighP}$ and $Thresh_{X, LowP}$ are equal to -1 times the values signalled for the corresponding parameters in the system information.

In all the above criteria the value of $T_{reselection_{RAT}}$ is scaled when the UE is in the medium or high mobility state as defined in subclause 5.2.4.3.1. If more than one cell meets the above criteria, the UE shall reselect a cell as follows:

- If the highest-priority frequency is an E-UTRAN frequency, a cell ranked as the best cell among the cells on the highest priority frequency(ies) meeting the criteria according to section 5.2.4.6;
- If the highest-priority frequency is from another RAT, a cell ranked as the best cell among the cells on the highest priority frequency(ies) meeting the criteria of that RAT.

8.1.3.5.3 Test description

8.1.3.5.3.1 Pre-test conditions

System Simulator:

- Cell 1, Cell 3 and Cell6.
- System information combination 3 as defined in TS 36.508 [18] clause 4.4.3.1 is used in E-UTRA cells.

NOTE: For Cell 3 and 6 TAI is set to TAI-2

UE:

None.

Preamble:

- The UE is in state Generic RB Established (state 3) on Cell 1 according to [18].

8.1.3.5.3.2 Test procedure sequence

Table 8.1.3.5.3.2-1 illustrates the downlink power levels and other changing parameters to be applied for the cells at various time instants of the test execution. Row marked "T0" denotes the initial conditions after preamble, while columns marked "T1" is to be applied subsequently. The exact instants on which these values shall be applied are described in the texts in this clause.

Table 8.1.3.5.3.2-1: Time instances of cell power level and parameter changes

	Parameter	Unit	Cell 1	Cell 3	Cell 6	Remark
T0	Cell-specific RS EPRE	dBm/ 15kHz z	-85	"off"	"off"	The power level values are assigned to satisfy $S_{rxlev_{Cell\ 1}} > S_{intrasearch}$. (NOTE 1)
T1	Cell-specific RS EPRE	dBm/ 15kHz z	-85	-73	-73	The power level values are assigned to satisfy both $Thresh_{x, low} < S_{rxlev_{Cell\ 3}}$ and $Thresh_{x, high} < S_{rxlev_{Cell\ 6}}$.

NOTE 1: Power level "Off" is defined in TS36.508 Table 6.2.2.1-1.

Table 8.1.3.5.3.2-2: Main behaviour

St	Procedure	Message Sequence		TP	Verdict
		U - S	Message		
1	The SS transmits an <i>RRCCONNECTIONRELEASE</i> message including the <i>freqPriorityListEUTRA</i> on Cell 1.	<--	<i>RRCCONNECTIONRELEASE</i>	-	-
2	Wait for 5 s for the UE to enter E-UTRA RRC_IDLE state on Cell 1.	-	-	-	-
3	The SS changes Cell 1, Cell 3 and Cell 6 level according to the row "T1" in table 8.1.3.5.3.2-1.	-	-	-	-
4	Void	-	-	-	-
5	Check: Does the test result of generic test procedure in TS 36.508 subclause 6.4.2.7 indicate that the UE is camped on E-UTRAN Cell 6?	-	-	1	-

8.1.3.5.3.3 Specific message contents

Table 8.1.3.5.3.3-1: RRCConnectionRelease (step 1, Table 8.1.3.5.3.2-2)

Derivation Path: 36.508 Table 4.6.1-15			
Information Element	Value/remark	Comment	Condition
RRCConnectionRelease ::= SEQUENCE {			
criticalExtensions CHOICE {			
c1 CHOICE {			
rrcConnectionRelease-r8 SEQUENCE {			
idleModeMobilityControlInfo SEQUENCE {			
freqPriorityListEUTRA SEQUENCE (SIZE (1..maxFreq)) OF SEQUENCE {	3 entries		
carrierFreq[1]	Same downlink EARFCN as used for Cell 1		
cellReselectionPriority[1]	4		
carrierFreq[2]	Same downlink EARFCN as used for Cell 3		
cellReselectionPriority[2]	1		
carrierFreq[3]	Same downlink EARFCN as used for Cell 6		
cellReselectionPriority[3]	5		
}			
freqPriorityListGERAN	Not present		
freqPriorityListUTRA-FDD	Not present		
freqPriorityListUTRA-TDD	Not present		
bandClassPriorityListHRPD	Not present		
bandClassPriorityList1XRTT	Not present		
t320	Not present		
}			
}			
}			
}			
}			

Table 8.1.3.5.3.3-2: SystemInformationBlockType5 for Cell 1 (preamble and all steps, Table 8.1.3.5.3.2-2)

Derivation path: 36.508 table 4.4.3.3-4			
Information Element	Value/Remark	Comment	Condition
SystemInformationBlockType5 ::= SEQUENCE {			
interFreqCarrierFreqList SEQUENCE (SIZE (1..maxFreq)) OF SEQUENCE {			
dl-CarrierFreq[n]	Same downlink EARFCN as used for Cell 3		
dl-CarrierFreq[m]	Same downlink EARFCN as used for Cell 6		
threshX-Low[n]	11		
threshX-High[m]	11		
}			
}			

Table 8.1.3.5.3.3-3: *SystemInformationBlockType5* for Cell 6 (all steps, Table 8.1.3.5.3.2-2)

Derivation path: 36.508 table 4.4.3.3-4			
Information Element	Value/Remark	Comment	Condition
<pre> SystemInformationBlockType5 ::= SEQUENCE { interFreqCarrierFreqList SEQUENCE (SIZE (1..maxFreq)) OF SEQUENCE { dl-CarrierFreq[1] dl-CarrierFreq[2] cellReselectionPriority [2] } } </pre>	<p>2 entries</p> <p>Same downlink EARFCN as used for Cell 1</p> <p>Same downlink EARFCN as used for Cell 3</p> <p>1</p>		

8.1.3.6 RRC connection release / Redirection from E-UTRAN to UTRAN

8.1.3.6.1 Test Purpose (TP)

(1)

```

with { UE in E-UTRA RRC_CONNECTED state }
ensure that {
  when { UE receives an RRCConnectionRelease message including an IE redirectionInformation with
  ultra-CarrierFreq UTRA frequency }
  then { UE enters RRC_IDLE state on UTRA frequency included in IE redirectionInformation }
}

```

8.1.3.6.2 Conformance requirements

References: The conformance requirements covered in the current TC are specified in: TS 36.331, clause 5.3.8.3, 5.3.12 and TS 36.304, clause 5.2.7.

[TS 36.331, clause 5.3.8.3]

The UE shall:

- 1> delay the following actions defined in this sub-clause 60ms from the moment the *RRCCConnectionRelease* message was received or optionally when lower layers indicate that the receipt of the *RRCCConnectionRelease* message has been successfully acknowledged, whichever is earlier;
- 1> if the *RRCCConnectionRelease* message includes the *idleModeMobilityControlInfo*:
 - ...
- 1> else:
 - 2> apply the cell reselection priority information broadcast in the system information;
- 1> if the *releaseCause* received in the *RRCCConnectionRelease* message indicates '*loadBalancingTAURequired*':
 - ...
- 1> else:
 - 2> perform the actions upon leaving RRC_CONNECTED as specified in 5.3.12, with release cause 'other'.

[TS 36.331, clause 5.3.12]

Upon leaving RRC_CONNECTED, the UE shall:

- ...
- 1> indicate the release of the RRC connection to upper layers together with the release cause;
- 1> if leaving RRC_CONNECTED was not triggered by reception of the *MobilityFromEUTRACCommand* message:

- 2> enter RRC_IDLE by performing cell selection in accordance with the cell selection process, defined for the case of leaving RRC_CONNECTED, as specified in TS 36.304 [4].

[TS 36.304, clause 5.2.7]

On transition from RRC_CONNECTED to RRC_IDLE, UE shall select a suitable cell to camp on according to *redirectedCarrierInfo*, if included in the *RRCConnectionRelease* message. Otherwise UE shall select a suitable cell on an EUTRA carrier.

...

8.1.3.6.3 Test description

8.1.3.6.3.1 Pre-test conditions

System Simulator:

- 2 cells, one E-UTRA and one UTRA cell and different location areas:
 - Cell 1 E-UTRA serving cell
 - Cell 5 suitable neighbour UTRA cell
- The parameters settings and power levels for Cell 1 and Cell 5 are selected according to [18], [5] and Table 8.1.3.6.3.2-0 so that camping on Cell 1 is guaranteed and no cell re-selection to Cell 5 can take place (utra priority is lower than serving and $S_{Cell 1} > Thresh_{Cell 1,low}$).
- System information combination 4 as defined in TS 36.508 [18] clause 4.4.3.1 is used in E-UTRA cells.

UE:

None.

Preamble:

- The UE is in state Generic RB Established (state 3) on cell 1 according to [18].

8.1.3.6.3.2 Test procedure sequence

Table 8.1.3.6.3.2-0 shows the cell power levels after the preamble.

Table 8.1.3.6.3.2-0: Time instances of cell power level and parameter changes

	Parameter	Unit	Cell 1	Cell 5	Remark
T0	Cell-specific RS EPRE	dBm/15kHz	-75	-	The power levels are such that camping on Cell 1 is guaranteed.
	CPICH_Ec	dBm/3.84 MHz	-	-70	
	P-CCPCH	dBm/1.28 MHz	-	-72	

Table 8.1.3.6.3.2-1: Main behaviour

St	Procedure	Message Sequence		TP	Verdict
		U - S	Message		
1	SS transmits an <i>RRCConnectionRelease</i> message (IE <i>redirectionInformation</i> including <i>UTRA-CarrierFreq</i> of Cell 5).	<--	<i>RRCConnectionRelease</i>	-	-
2	Check: Does the test result of generic test procedure in TS 36.508 subclause 6.4.2.8 indicate that the UE is camped on UTRAN Cell 5?	-	-	1	-

8.1.3.6.3.3 Specific message or IE contents

Table 8.1.3.6.3.3-1: Void

Table 8.1.3.6.3.3-2: Void

Table 8.1.3.6.3.3-3: SystemInformationBlockType6 for cell 1 (preamble and all steps, Table 8.1.3.6.3.2-1)

Derivation Path: 36.508 table 4.4.3.3-5			
Information Element	Value/remark	Comment	Condition
SystemInformationBlockType6 ::= SEQUENCE {			
carrierFreqListUTRA-FDD SEQUENCE (SIZE (1..maxUTRA-FDD-Carrier)) OF SEQUENCE {			UTRA-FDD
carrierFreq[n]	Same downlink UARFCN as used for cell 5		
cellReselectionPriority[n]	3	Lower priority than E-UTRA	
}			
carrierFreqListUTRA-TDD SEQUENCE (SIZE (1..maxUTRA-TDD-Carrier)) OF SEQUENCE {			UTRA-TDD
carrierFreq[n]	Same downlink UARFCN as used for cell 5		
cellReselectionPriority[n]	3	Lower priority than E-UTRA	
}			
}			

Condition	Explanation
UTRA-FDD	UTRA FDD cell environment
UTRA-TDD	UTRA TDD cell environment

Table 8.1.3.6.3.3-4 RRCConnectionRelease message (step 1, Table 8.1.3.6.3.2-1)

Derivation Path: 36.508 table 4.6.1.1-15			
Information Element	Value/remark	Comment	Condition
RRCConnectionRelease ::= SEQUENCE {			
criticalExtensions CHOICE {			
c1 CHOICE {			
rrcConnectionRelease-r8 SEQUENCE {			
redirectedCarrierInfo ::= CHOICE {			
utra-FDD	Downlink UARFCN of cell 5		UTRA-FDD
utra-TDD	Downlink UARFCN of cell 5		UTRA-TDD
}			
}			
}			
}			
}			

Condition	Explanation
UTRA-FDD	UTRA FDD cell environment
UTRA-TDD	UTRA TDD cell environment

Table 8.1.3.6.3.3-5: System Information Block type 19 for Cell 5 (preamble and all steps, Table 8.1.3.6.3.2-1)

Derivation Path: 36.508 table 4.4.4.1-1			
Information Element	Value/remark	Comment	Condition
SysInfoType19 ::= SEQUENCE {			
Ultra-PriorityInfoList ::= SEQUENCE {			
utra-ServingCell ::= SEQUENCE {			
priority	5		
}			
}			
}			

8.1.3.6a RRC connection release / Redirection from E-UTRAN to UTRAN / Pre-redirection info

8.1.3.6a.1 Test Purpose (TP)

(1)

```
with { UE in E-UTRA RRC_CONNECTED state }
ensure that {
  when { UE receives an RRCConnectionRelease message including an IE redirectedCarrierInfo with
    ultra-CarrierFreq UTRA frequency }
  then { UE sends an RRC CONNECTION REQUEST message including IE Pre-redirection info set to FALSE
    on UTRA frequency included in IE redirectionInformation and enters RRC_IDLE state on that UTRA
    frequency }
}
```

8.1.3.6a.2 Conformance requirements

References: The conformance requirements covered in the current TC are specified in: TS 36.331, clause 5.3.8.3, 5.3.12 and TS 36.304, clause 5.2.7 and TS 25.331, clause 8.1.3.3, 10.2.39 with additional clarification in R2-105061.

[TS 36.331, clause 5.3.8.3]

The UE shall:

- 1> delay the following actions defined in this sub-clause 60ms from the moment the *RRCConnectionRelease* message was received or optionally when lower layers indicate that the receipt of the *RRCConnectionRelease* message has been successfully acknowledged, whichever is earlier;
- 1> if the *RRCConnectionRelease* message includes the *idleModeMobilityControlInfo*:
 - ...
- 1> else:
 - 2> apply the cell reselection priority information broadcast in the system information;
- 1> if the *releaseCause* received in the *RRCConnectionRelease* message indicates '*loadBalancingTAURequired*':
 - ...
- 1> else:
 - 2> perform the actions upon leaving RRC_CONNECTED as specified in 5.3.12, with release cause 'other'.

[TS 36.331, clause 5.3.12]

Upon leaving RRC_CONNECTED, the UE shall:

- ...
- 1> indicate the release of the RRC connection to upper layers together with the release cause;
- 1> if leaving RRC_CONNECTED was not triggered by reception of the *MobilityFromEUTRACommand* message:

2> enter RRC_IDLE by performing cell selection in accordance with the cell selection process, defined for the case of leaving RRC_CONNECTED, as specified in TS 36.304 [4].

[TS 36.304, clause 5.2.7]

On transition from RRC_CONNECTED to RRC_IDLE, UE shall select a suitable cell to camp on according to *redirectedCarrierInfo*, if included in the *RRCCConnectionRelease* message. Otherwise UE shall select a suitable cell on an EUTRA carrier.

[TS 25.331, clause 8.1.3.3]

...

1> if the UE supports E-UTRA:

2> if the UE is attempting to establish the signalling connection as a result of being redirected by E-UTRA; and

2> if this is the first attempt to establish the signalling connection;

3> do not include the IE "Pre-Redirection info";

[TS 25.331, clause 10.2.39]

Pre-redirection info	OP		Pre-redirection info 10.3.3.25a	The presence of this IE indicates the UE support of radio access technologies that the UE could be directed to, and that the UE was not redirected from EUTRA.	REL-8
----------------------	----	--	------------------------------------	--	-------

8.1.3.6a.3 Test description

8.1.3.6a.3.1 Pre-test conditions

System Simulator:

- 2 cells, one E-UTRA and one UTRA cell and different location areas:
 - Cell 1 E-UTRA serving cell
 - Cell 5 suitable neighbour UTRA cell
- The parameters settings and power levels for Cell 1 and Cell 5 are selected according to [18], [5] and Table 8.1.3.6a.3.2-0 so that camping on Cell 1 is guaranteed and no cell re-selection to Cell 5 can take place (utra priority is lower than serving and $S_{Cell 1} > Thresh_{Cell 1,low}$).
- System information combination 4 as defined in TS 36.508 [18] clause 4.4.3.1 is used in E-UTRA cells.

UE:

None.

Preamble:

- The UE is in state Generic RB Established (state 3) on cell 1 according to [18].

8.1.3.6a.3.2 Test procedure sequence

Table 8.1.3.6a.3.2-0 shows the cell power levels after the preamble.

Table 8.1.3.6a.3.2-0: Time instances of cell power level and parameter changes

	Parameter	Unit	Cell 1	Cell 5	Remark
T0	Cell-specific RS EPRE	dBm/15kHz	-75	-	The power levels are such that camping on Cell 1 is guaranteed.
	CPICH_Ec	dBm/3.84 MHz	-	-70	
	P-CCPCH	dBm/1.28 MHz	-	-72	

Table 8.1.3.6a.3.2-1: Main behaviour

St	Procedure	Message Sequence		TP	Verdict
		U - S	Message		
1	SS transmits an <i>RRConnectionRelease</i> message (IE <i>redirectedCarrierInfo</i> including <i>UTRA-CarrierFreq</i> of Cell 5).	<--	<i>RRConnectionRelease</i>	-	-
2	Check: Does the test result of generic test procedure in TS 36.508 subclause 6.4.2.8 indicate that the UE is camped on UTRAN Cell 5?	-	-	1	-

8.1.3.6a.3.3 Specific message or IE contents

Table 8.1.3.6a.3.3-1: *SystemInformationBlockType6* for cell 1 (preamble and all steps, Table 8.1.3.6a.3.2-1)

Derivation Path: 36.508 table 4.4.3.3-5			
Information Element	Value/remark	Comment	Condition
<i>SystemInformationBlockType6</i> ::= SEQUENCE { <i>carrierFreqListUTRA-FDD</i> SEQUENCE (SIZE (1..maxUTRA-FDD-Carrier)) OF SEQUENCE { <i>carrierFreq</i> [n]	Same downlink UARFCN as used for cell 5		UTRA-FDD
<i>cellReselectionPriority</i> [n]	3	Lower priority than E-UTRA	
}			
<i>carrierFreqListUTRA-TDD</i> SEQUENCE (SIZE (1..maxUTRA-TDD-Carrier)) OF SEQUENCE { <i>carrierFreq</i> [n]	Same downlink UARFCN as used for cell 5		UTRA-TDD
<i>cellReselectionPriority</i> [n]	3	Lower priority than E-UTRA	
}			
}			

Condition	Explanation
UTRA-FDD	UTRA FDD cell environment
UTRA-TDD	UTRA TDD cell environment

Table 8.1.3.6a.3.3-2 RRCConnectionRelease message (step 1, Table 8.1.3.6a.3.2-1)

Derivation Path: 36.508 table 4.6.1-15			
Information Element	Value/remark	Comment	Condition
RRCConnectionRelease ::= SEQUENCE {			
criticalExtensions CHOICE {			
c1 CHOICE {			
rrcConnectionRelease-r8 SEQUENCE {			
redirectedCarrierInfo ::= CHOICE {			
utra-FDD	Downlink UARFCN of cell 5		UTRA-FDD
utra-TDD	Downlink UARFCN of cell 5		UTRA-TDD
}			
nonCriticalExtension SEQUENCE {			
nonCriticalExtension SEQUENCE {			
cellInfoList-r9 ::= CHOICE { }	Not present	redirection with SIB is optional	
}			
}			
}			
}			
}			

Condition	Explanation
UTRA-FDD	UTRA FDD cell environment
UTRA-TDD	UTRA TDD cell environment

Table 8.1.3.6a.3.3-3: System Information Block type 19 for Cell 5 (preamble and all steps, Table 8.1.3.6a.3.2-1)

Derivation Path: 36.508 table 4.4.4.1-1			
Information Element	Value/remark	Comment	Condition
SysInfoType19 ::= SEQUENCE {			
Ultra-PriorityInfoList ::= SEQUENCE {			
utra-ServingCell ::= SEQUENCE {			
priority	5		
}			
}			
}			

Table 8.1.3.6a.3.3-4 RRC CONNECTION REQUEST (step 2, Table 8.1.3.6a.3.2-1)

Derivation Path: 36.508 table 4.7B.1-7			
Information Element	Value/remark	Comment	Condition
Pre-redirection info	Not present	The presence of this IE indicates the UE support of radio access technologies that the UE could be directed to, and that the UE was not redirected from EUTRA	

8.1.3.7 RRC connection release / Redirection from UTRAN to E-UTRAN

8.1.3.7.1 Test Purpose (TP)

(1)

with { UE in UTRA Idle state }

```

ensure that {
  when { UE is requested to make an outgoing PS call }
  then { UE includes in the RRC CONNECTION REQUEST the IE Pre-Redirection info }
}

```

(2)

```

with { UE in UTRA CELL_DCH state }
ensure that {
  when { UE receives an RRC CONNECTION RELEASE message including an IE Redirection info with E-UTRA target info E-UTRA frequency }
  then { UE enters RRC_IDLE state on E-UTRAN Carrier included in IE Redirection info }
}

```

8.1.3.7.2 Conformance requirements

References: The conformance requirements covered in the current TC are specified in: TS 25.331, clause 8.1.3.3, 8.1.4.3 and clause 8.5.2.

[TS 25.331, clause 8.1.3.3]

The UE shall, in the transmitted RRC CONNECTION REQUEST message:

...

- 1> if the UE supports E-UTRA:
 - 2> if the variable EUTRA_FREQUENCY_INFO_LIST contains no E-UTRA frequencies;
 - 3> include the IE "Pre-Redirection info";
 - 3> if the UE supports E-UTRA FDD:
 - 4> set the IE "Support of E-UTRA FDD" to TRUE.
 - 3> if the UE supports E-UTRA TDD:
 - 4> set the IE "Support of E-UTRA TDD" to TRUE.
 - 2> if the UE supports any of the bands that the E-UTRA frequencies included in the variable EUTRA_FREQUENCY_INFO_LIST belong to;
 - 3> include the IE "Pre-Redirection info";
 - 3> if the UE supports any of the bands that the E-UTRA FDD frequencies included in the variable EUTRA_FREQUENCY_INFO_LIST belong to:
 - 4> set the IE "Support of E-UTRA FDD" to TRUE.
 - 3> if the UE supports any of the bands that the E-UTRA TDD frequencies included in the variable EUTRA_FREQUENCY_INFO_LIST belong to:
 - 4> set the IE "Support of E-UTRA TDD" to TRUE.

[TS 25.331, clause 8.1.4.3]

The UE shall receive and act on an RRC CONNECTION RELEASE message in states CELL_DCH and CELL_FACH and CELL_PCH (FDD only). Furthermore this procedure can interrupt any ongoing procedures with the UE in the above listed states.

When the UE receives the first RRC CONNECTION RELEASE message; and

- 1> if the message is received on the CCCH, and IE "U-RNTI" is present and has the same value as the variable U_RNTI; or
- 1> if the message is received on DCCH:

the UE shall perform the RRC connection release procedure as specified below.

When the UE receives the first RRC CONNECTION RELEASE message; and

- 1> if the message is received on the CCCH, the IE "UTRAN group identity" is present and there is a group identity match according to subclause 8.6.3.13:

the UE shall perform the RRC connection release procedure as specified below.

The UE shall:

- 1> in state CELL_DCH:
 - 2> initialise the counter V308 to zero;
 - 2> set the IE "RRC transaction identifier" in the RRC CONNECTION RELEASE COMPLETE message to the value of "RRC transaction identifier" in the entry for the RRC CONNECTION RELEASE message in the table "Accepted transactions" in the variable TRANSACTIONS;
 - 2> submit an RRC CONNECTION RELEASE COMPLETE message to the lower layers for transmission using UM RLC on the DCCH to the UTRAN;
 - 2> if the IE "Rplmn information" is present:
 - 3> the UE may:
 - 4> store the IE on the ME together with the PLMN id for which it applies;
 - 3> the UE may then:
 - 4> utilise this information, typically indicating where a number of BCCH frequency ranges of a RAT may be expected to be found, during subsequent Rplmn selections of the indicated PLMN.
 - 2> if the IE "UE Mobility State Indicator" is present:
 - 3> consider the High-mobility state to have being detected when entering idle mode.
 - 2> start timer T308 when the RRC CONNECTION RELEASE COMPLETE message is sent on the radio interface.
- 1> in state CELL_FACH:
 - 2> if the RRC CONNECTION RELEASE message was received on the DCCH:
 - 3> set the IE "RRC transaction identifier" in the RRC CONNECTION RELEASE COMPLETE message to the value of "RRC transaction identifier" in the entry for the RRC CONNECTION RELEASE message in the table "Accepted transactions" in the variable TRANSACTIONS;
 - 3> submit an RRC CONNECTION RELEASE COMPLETE message to the lower layers for transmission using AM RLC on the DCCH to the UTRAN.
 - 3> when the successful transmission of the RRC CONNECTION RELEASE COMPLETE message has been confirmed by the lower layers:
 - 4> release all its radio resources; and
 - 4> indicate the release of the established signalling connections (as stored in the variable ESTABLISHED_SIGNALLING_CONNECTIONS) and established radio access bearers (as stored in the variable ESTABLISHED_RABS) to upper layers; and
 - 4> clear any entry for the RRC CONNECTION RELEASE message in the tables "Accepted transactions" and "Rejected transactions" in the variable TRANSACTIONS;
 - 4> clear the variable ESTABLISHED_SIGNALLING_CONNECTIONS;
 - 4> clear the variable ESTABLISHED_RABS;
 - 4> pass the value of the IE "Release cause" received in the RRC CONNECTION RELEASE message to upper layers;

- 4> enter idle mode;
- 4> perform the actions specified in subclause 8.5.2 when entering idle mode.
- 3> and the procedure ends.
- 2> if the RRC CONNECTION RELEASE message was received on the CCCH:
 - 3> release all its radio resources;
 - 3> indicate the release of the established signalling connections (as stored in the variable ESTABLISHED_SIGNALLING_CONNECTIONS) and established radio access bearers (as stored in the variable ESTABLISHED_RABS) to the upper layers;
 - 3> clear any entry for the RRC CONNECTION RELEASE message in the tables "Accepted transactions" and "Rejected transactions" in the variable TRANSACTIONS;
 - 3> clear the variable ESTABLISHED_SIGNALLING_CONNECTIONS;
 - 3> clear the variable ESTABLISHED_RABS;
 - 3> pass the value of the IE "Release cause" received in the RRC CONNECTION RELEASE message to upper layers;
 - 3> enter idle mode;
 - 3> perform the actions specified in subclause 8.5.2 when entering idle mode;
 - 3> and the procedure ends.

[TS 25.331, clause 8.5.2]

When entering idle mode from connected mode, the UE shall:

- 1> clear or set variables upon leaving UTRA RRC connected mode as specified in subclause 13.4;
- 1> if the RRC CONNECTION RELEASE message was received and the IE "Redirection info" was present therein:
 - 2> if the IE "Frequency info" is present, attempt to camp on a suitable cell on the indicated UTRA carrier included in the RRC CONNECTION RELEASE message;
 - 2> if the IE "GSM target cell info" is present, attempt to camp on a suitable cell of the list of cells for the indicated RAT included in the RRC CONNECTION RELEASE message. If no cells were indicated for that RAT or no suitable cell of the indicated cells for that RAT is found within 10s, attempt to camp on any suitable cell of that RAT; or
 - 2> if the IE "E-UTRA target info" is present, attempt to camp on any of the frequencies for the indicated RAT included in the RRC CONNECTION RELEASE message, excluding any cell indicated in the list of not allowed cells for that RAT, if present. If no suitable cell on the indicated frequencies for that RAT is found within 10s, attempt to camp on any suitable cell of that RAT, excluding any cell indicated in the list of not allowed cells for that RAT; or
- 2> if no suitable cell is found on the indicated UTRA carrier or RAT camp on any suitable cell.

8.1.3.7.3 Test description

8.1.3.7.3.1 Pre-test conditions

System Simulator:

- 2 cells, one UTRA and one E-UTRA cell:
 - Cell 5 UTRA serving cell (priority 4 default)
 - Cell 1 suitable neighbour E-UTRA cell (priority 3)
- System information combination 4 as defined in TS 36.508 [18] clause 4.4.3.1 is used in E-UTRA cells.

UE:

UTRAN Idle state

Preamble:

State 3 or state 7 as specified in clause 7.4 of TS 34.108, depending on the CN domain(s) supported by the UE.

8.1.3.7.3.2 Test procedure sequence

Table 8.1.3.7.3.2-0 illustrates the downlink power levels and other changing parameters to be applied for the cells at various time instants of the test execution. Subsequent configurations marked "T1" is applied at the point indicated in the Main behaviour description in Table 8.1.3.7.3.2-1.

Table 8.1.3.7.3.2-0: Time instances of cell power level and parameter changes

	Parameter	Unit	Cell 1	Cell 5	Remark
T1	Cell-specific RS EPRE	dBm/15k Hz	-70	-	The power level values are such that entering condition for event 3c is satisfied.
	CPICH Ec (UTRA FDD)	dBm/3.8 4 MHz	-	-85	
	PCCPCH Ec (UTRA LCR TDD)	dBm/1.2 8 MHz	-	-85	

Table 8.1.3.7.3.2-1: Main behaviour

St	Procedure	Message Sequence		TP	Verdict
		U - S	Message		
1	Make the UE initiate an outgoing PS call.	-	-	-	-
2	Check: Does the UE include the IE Pre-redirection info with Support of E-UTRA set to TRUE?	-->	RRC CONNECTION REQUEST	1	P
3	The SS transmits a RRC CONNECTION SETUP on SRB1 on Cell 5.	<--	RRC CONNECTION SETUP	-	-
4	The UE transmits an RRC CONNECTION SETUP COMPLETE message	-->	RRC CONNECTION SETUP COMPLETE	-	-
5	The UE transmits the SERVICE REQUEST message for PS data call	-->	INITIAL DIRECT TRANSFER	-	-
-	EXCEPTION: Steps 6a1 and 6a2 describe behaviour that depends on the UE capability; the "lower case letter" identifies a step sequence that takes place if a capability is supported. UTRAN FDD: IF pc_UTRA_CompressedModeRequired and pc_UTRA_FeatrGrp_2 THEN Steps 6a1, 6a2 UTRAN TDD: go to step 6Aa1				
6a1	The SS transmits a PHYSICAL CHANNEL RECONFIGURATION message on Cell 5 including the DPCH compressed mode info.	<--	PHYSICAL CHANNEL RECONFIGURATION	-	-
6a2	The UE transmits a PHYSICAL CHANNEL RECONFIGURATION COMPLETE message on Cell 5.	-->	PHYSICAL CHANNEL RECONFIGURATION COMPLETE	-	-
-	EXCEPTION: Steps 6Aa1 and 6Aa2 describe behaviour that depends on the UE capability; the "lower case letter" identifies a step sequence that takes place if a capability is supported. IF pc_UTRA_FeatrGrp_2 THEN 6Aa1 to 6Aa2.				
6Aa1	The SS configures the Inter-RAT measurement with E-UTRA frequency list including the DL Carrier frequency of Cell 1	<--	MEASUREMENT CONTROL	-	-
6Aa2	The SS changes Cell 1 and Cell 5 power level according to the row "T1" in table 8.1.3.7.3.2-0. Note: The UE starts sending MEASUREMENT REPORT messages during the Authentication Phase	-	-	-	-
7-9	Void				
10	The SS starts the Authentication and Ciphering Request procedure	<--	DOWNLINK DIRECT TRANSFER	-	-
11	The UE transmits the Authentication and Ciphering Response	-->	UPLINK DIRECT TRANSFER	-	-
12	The SS transmits a EXCEPTION: Step 13A and Step 14a can occur in any order. SECURITY MODE COMMAND message	<--	SECURITY MODE COMMAND	-	-
13	The UE transmits a SECURITY MODE COMPLETE message	-->	SECURITY MODE COMPLETE	-	-
13A	The UE transmits an ACTIVATE PDP CONTEXT REQUEST message NOTE: Retransmission of this message is ignored	-->	UPLINK DIRECT TRANSFER		
-	EXCEPTION: Step 14a describes behaviour that depends on the UE capability; the "lower case letter" identifies a step sequence that takes place if a capability is supported.				
14 a	IF pc_UTRA_FeatrGrp_2 THEN if MEASUREMENT REPORT is received during the authentication and security phase (from	-->	MEASUREMENT REPORT	-	-

	step 7 to 13) goto next step otherwise the SS waits for MEASUREMENT REPORT message.				
15	The SS transmits an RRC CONNECTION RELEASE message (IE E-UTRA target info including DL Carrier frequency of Cell 1).	<--	RRC CONNECTION RELEASE	-	-
16	The UE transmits a RRC CONNECTION RELEASE COMPLETE message	-->	RRC CONNECTION RELEASE COMPLETE	-	-
17	The UE transmits a RRC CONNECTION RELEASE COMPLETE message	-->	RRC CONNECTION RELEASE COMPLETE	-	-
18	Check: Does the test result of generic test procedure in TS 36.508 Table 6.4.2.7A-2 indicate that the UE is camped on E-UTRAN Cell 1?	-	-	2	-
NOTE: pc_FeatrGrp_2 is always set to TRUE when pc_UTRA_CompressedModeRequired is TRUE					

8.1.3.7.3.3 Specific message or IE contents

Table 8.1.3.7.3.3-1 System Information Block type 19 for Cell 5 (preamble and all steps, Table 8.1.3.7.3.2-1)

Derivation Path: 36.508 table Table 4.4.4.1-1			
Information Element	Value/remark	Comment	Condition
SysInfoType19 ::= SEQUENCE {			
utra-PriorityInfoList SEQUENCE {			
utra-ServingCell SEQUENCE {			
priority	4		
}			
utra-FrequencyAndPriorityInfoList SEQUENCE (SIZE (1..maxNumEUTRAFreqs)) OF SEQUENCE	1 entry		
earfcn[1]	Downlink EARFCN of Cell 1		
priority[1]	3		
}			
}			

Table 8.1.3.7.3.3-2: RRC CONNECTION REQUEST (step 2, Table 8.1.3.7.3.2-1)

Derivation path: 34.108 default RRC CONNECTION REQUEST in section 9.1.1 for UTRA FDD or 9.1.2 for UTRA TDD			
Information Element	Value/Remark	Comment	Condition
Pre-redirectio info		The presence of this IE indicates the UE support of radio access technologies that the UE could be directed to	
Support of E-UTRA FDD	TRUE		E-UTRA-FDD
Support of E-UTRA TDD	TRUE		E-UTRA-TDD

Table 8.1.3.7.3.3-3: MEASUREMENT CONTROL (step 6Aa1, Table 8.1.3.7.3.2-1)

Derivation Path: 36.508, clause 4.7B.1 Table 4.7B.1-3			
Information Element	Value/remark	Comment	Condition
CHOICE Measurement type	Inter-RAT measurement		
CHOICE report criteria	Inter-RAT measurement reporting criteria		
Parameters required for each event	1 entry		
Inter-RAT event identity	3c		
Threshold own system	Not present		
W	Not present		
DPCH Compressed mode status info			UTRA CM-

			Support
TGPS reconfiguration CFN	(Current CFN + (256 – TTI/10msec))mod 256		
Transmission gap pattern sequence	1 entry		
TGSPI	1		
TGPS Status Flag	activate		
TGCFN	(Current CFN + (256 – TTI/10msec))mod 256		
DPCH Compressed mode status info	Not Present		UTRA CM-Not Supported

Condition	Explanation
UTRA CM-Supported	UTRAN Compressed Mode configuration supported
UTRA CM-Not Supported	UTRAN Compressed Mode configuration not supported

Table 8.1.3.7.3.3-4: RRC CONNECTION RELEASE (step 15, Table 8.1.3.7.3.2-1)

Derivation path: 34.108 default RRC CONNECTION RELEASE in section 9.1.1 for UTRA FDD or 9.1.2 for UTRA TDD			
Information Element	Value/Remark	Comment	Condition
N308	1		
Redirection info			
Frequency info	Omitted		
Inter-RAT info	E-UTRA		
E-UTRA target info			
E-UTRA Target Frequency Info List	1 Entry		
FDD			E-UTRA-FDD
DL Carrier frequency	The DL Carrier frequency of Cell 1		
Blacklisted cells per freq list	Omitted		
TDD			E-UTRA-TDD
DL Carrier frequency	The DL Carrier frequency of Cell 1		
Blacklisted cells per freq list	Omitted		

Table 8.1.3.7.3.3-5: PHYSICAL CHANNEL RECONFIGURATION (step 6a1, Table 8.1.3.7.3.2-1)

Derivation path: 36.508, clause 4.7B.1 Table 4.7B.1-5			
Information Element	Value/Remark	Comment	Condition
CHOICE UL/DL Mode	UL and DL, UL only or DL only (depending on the UE capability)		
Downlink compressed mode method	SF_2(or not sent, depending on the UE capability)		
Uplink compressed mode method	SF_2(or not sent, depending on the UE capability)		

8.1.3.8 RRC connection release / Redirection from E-UTRAN to GERAN

8.1.3.8.1 Test Purpose (TP)

(1)

```

with { UE in E-UTRA RRC_CONNECTED state }
ensure that {
  when { UE receives an RRCConnectionRelease message including an IE redirectedCarrierInfo set to geran }
  then { UE enters Idle mode on GERAN Cell included in IE redirectedCarrierInfo }
}

```

8.1.3.8.2 Conformance requirements

References: The conformance requirements covered in the current TC are specified in: TS 36.331, clause 5.3.8.3, 5.3.12 and TS 36.304, clause 5.2.7.

[TS 36.331, clause 5.3.8.3]

The UE shall:

- 1> delay the following actions defined in this sub-clause 60ms from the moment the *RRConnectionRelease* message was received or optionally when lower layers indicate that the receipt of the *RRConnectionRelease* message has been successfully acknowledged, whichever is earlier;
- 1> if the *RRConnectionRelease* message includes the *idleModeMobilityControlInfo*:
 - ...
- 1> else:
 - 2> apply the cell reselection priority information broadcast in the system information;
- 1> if the *releaseCause* received in the *RRConnectionRelease* message indicates '*loadBalancingTAURequired*':
 - ...
- 1> else:
 - 2> perform the actions upon leaving RRC_CONNECTED as specified in 5.3.12, with release cause 'other'.

[TS 36.331, clause 5.3.12]

Upon leaving RRC_CONNECTED, the UE shall:

- ...
- 1> indicate the release of the RRC connection to upper layers together with the release cause;
- 1> if leaving RRC_CONNECTED was not triggered by reception of the *MobilityFromEUTRACommand* message:
- 2> enter RRC_IDLE by performing cell selection in accordance with the cell selection process, defined for the case of leaving RRC_CONNECTED, as specified in TS 36.304 [4].

[TS 36.304, clause 5.2.7]

On transition from RRC_CONNECTED to RRC_IDLE, a UE shall attempt to camp on the last cell for which it was in RRC_CONNECTED or any cell on a frequency or frequency of RAT assigned by RRC in the state transition message.

...

8.1.3.8.3 Test description

8.1.3.8.3.1 Pre-test conditions

System Simulator:

- 2 cells, one E-UTRA and one GERAN cell and different location areas:
 - Cell 1 E-UTRA serving cell (priority 4 default)
 - Cell 24 GERAN neighbouring cell (priority 3)
 - The parameters settings and power levels for Cell 1 and Cell 24 are selected according to [18], [5], [25] and Table 8.1.3.8.3.2-0 so that camping on Cell 1 is guaranteed and no cell re-selection to Cell 24 can take place (GERAN priority is lower than serving and $S_{Cell\ 1} > Thresh_{Cell\ 1,low}$)
 - System information combination 5 as defined in TS 36.508 [18] clause 4.4.3.1 is used in E-UTRA cells.

UE:

None.

Preamble:

- The UE is in state Generic RB Established (state 3) on cell 1 according to [18].

8.1.3.8.3.2 Test procedure sequence

Table 8.1.3.6.3.2-0 shows the cell power levels after the preamble.

Table 8.1.3.8.3.2-0: Time instances of cell power level and parameter changes

	Parameter	Unit	Cell 1	Cell 24	Remark
T0	Cell-specific RS EPRE	dBm/15kHz	-75	-	The power levels are such that camping on Cell 1 is guaranteed.
	GERAN Cell Power	dBm	-	-70	
T1	Cell-specific RS EPRE	dBm/15kHz	-115	-	The power levels are such that reselection back to cell 1 should not occur
	GERAN Cell Power	dBm		-70	

Table 8.1.3.8.3.2-1: Main behaviour

St	Procedure	Message Sequence		TP	Verdict
		U - S	Message		
1	SS transmits an <i>RRConnectionRelease</i> message (IE <i>redirectedCarrierInfo</i> including <i>startingARFCN</i> of Cell 24).	<--	<i>RRConnectionRelease</i>	-	-
1A	The UE sends a CHANNEL REQUEST message on the cell 24	-->	CHANNEL REQUEST	-	-
1B	An uplink TBF is established in order to allow the UE to transmit a ROUTING AREA UPDATE REQUEST message signalling.	-	-	-	-
1C	The UE transmits a ROUTING AREA UPDATE REQUEST message.	-->	ROUTING AREA UPDATING REQUEST	-	-
1D	The SS changes cell 1 level according to the row "T1" in table 8.1.3.8.3.2-0				
2	Check: Does the test result of generic test procedure in TS 36.508 subclause 6.4.2.9 steps 4-11 indicate that the UE is camped on GERAN Cell 24? NOTE: The UE completes the RAU procedure.	-	-	1	-

8.1.3.8.3.3 Specific message or IE contents

Table 8.1.3.8.3.3-1: Void**Table 8.1.3.8.3.3-2: SystemInformationBlockType7 for cell 1 (preamble and all steps, Table 8.1.3.8.3.2-1)**

Derivation Path: 36.508 table 4.4.3.3-6			
Information Element	Value/remark	Comment	Condition
SystemInformationBlockType7 ::= SEQUENCE {			
carrierFreqsInfoList SEQUENCE (SIZE (1..maxGNFG)) OF SEQUENCE {			
carrierFreqs SEQUENCE [n] {			
startingARFCN	Same as cell 24		
bandIndicator	Same as cell 24		
followingARFCNs CHOICE {			
equallySpacedARFCNs SEQUENCE {			
arfcn-Spacing	Same as cell 24		
numberOfFollowingARFCNs	Same as cell 24		
}			
}			
}			
commonInfo SEQUENCE {			
cellReselectionPriority	3		
}			
}			

Table 8.1.3.8.3.3-3: RRCConnectionRelease message (step 1, Table 8.1.3.8.3.2-1)

Derivation Path: 36.508 table 4.6.1-15			
Information Element	Value/remark	Comment	Condition
RRCConnectionRelease ::= SEQUENCE {			
criticalExtensions CHOICE {			
c1 CHOICE {			
rrcConnectionRelease-r8 SEQUENCE {			
redirectedCarrierInfo CHOICE {			
geran SEQUENCE {			
startingARFCN	Downlink ARFCN of Cell 24		
bandIndicator	The same band indicator of the Cell 24		
followingARFCNs CHOICE {			
explicitListOfARFCNs	0 Entries		
}			
}			
}			
}			
}			
}			
}			

8.1.3.9 RRC connection release / Redirection from E-UTRAN to CDMA2000-HRPD

8.1.3.9.1 Test Purpose (TP)

(1)

```

with { UE in E-UTRA RRC_CONNECTED state }
ensure that {
  when { UE receives an RRCConnectionRelease message including an IE redirectedCarrierInfo set to cdma2000-HRPD }
  then { UE enters cdma2000-HRPD mode }
}

```

8.1.3.9.2 Conformance requirements

References: The conformance requirements covered in the current TC are specified in: TS 36.331, clause 5.3.8.3, 5.3.12 and TS 36.304, clause 5.2.7.

[TS 36.331, clause 5.3.8.3]

The UE shall:

- 1> delay the following actions defined in this sub-clause 60ms from the moment the *RRConnectionRelease* message was received or optionally when lower layers indicate that the receipt of the *RRConnectionRelease* message has been successfully acknowledged, whichever is earlier;
- 1> if the *RRConnectionRelease* message includes the *idleModeMobilityControlInfo*:
 - ...
- 1> else:
 - 2> use the idle mobility parameters broadcast in the system information;
- 1> if the *releaseCause* received in the *RRConnectionRelease* message indicates '*loadBalancingTAURequired*':
 - ...
- 1> else:
 - 2> perform the actions upon leaving RRC_CONNECTED as specified in 5.3.12, with release cause 'other'.

[TS 36.331, clause 5.3.12]

Upon leaving RRC_CONNECTED, the UE shall:

- ...
- 1> indicate the release of the RRC connection to upper layers together with the release cause;
- 1> if leaving RRC_CONNECTED was not triggered by reception of the *MobilityFromEUTRACommand* message:
- 2> enter RRC_IDLE by performing cell selection in accordance with the cell selection process, defined for the case of leaving RRC_CONNECTED, as specified in TS 36.304 [4].

[TS 36.304, clause 5.2.7]

On transition from RRC_CONNECTED to RRC_IDLE, a UE shall attempt to camp on the last cell for which it was in RRC_CONNECTED or any cell on a frequency or frequency of RAT assigned by RRC in the state transition message.

...

8.1.3.9.3 Test description

8.1.3.9.3.1 Pre-test conditions

System Simulator:

- 2 cells, one E-UTRA and one HRPD cell:
 - Cell 1 E-UTRA serving cell
 - Cell 15 suitable neighbour HRPD cell
- The parameters settings and power levels for Cell 1 and Cell 15 are selected according to [18], [xx] and Table 8.1.3.9.3.2-1 so that camping on Cell 1 is guaranteed and no cell re-selection to Cell 15 can take place (hrpd priority is lower than serving and $S_{Cell\ 1} > Thresh_{Cell\ 1,low}$).
- System information combination 6 as defined in TS 36.508 [18] clause 4.4.3.1 is used in E-UTRA cells.

UE:

None.

Preamble:

- The UE is in state Generic RB Established (state 3) on Cell 1 according to [18].

Note: UE is not pre-registered in Cell 15.

8.1.3.9.3.2 Test procedure sequence

Table 8.1.3.9.3.2-1 shows the cell power levels after the preamble.

Table 8.1.3.9.3.2-1: Time instances of cell power level and parameter changes

	Parameter	Unit	Cell 1	Cell 15	Remark
T0	Cell-specific RS EPRE	dBm/15kHz	-75	-	The power levels are such that camping on Cell 1 is guaranteed.
	Ior/loc	dB	-	-5	
	loc	dBm/1.23 MHz	-	-55	
	Pilot Ec /Io (Note 1)	dB	-	-6	
Note 1: This parameter is not directly settable, but is derived by calculation from the other parameters set by the SS.					

Table 8.1.3.9.3.2-2: Main behaviour

St	Procedure	Message Sequence		TP	Verdict
		U - S	Message		
1	SS transmits an <i>RRConnectionRelease</i> message (IE <i>redirectedCarrierInfo</i> including <i>cdma2000-HRPD</i> of Cell 15).	<--	<i>RRConnectionRelease</i>	-	-
2	Check: Does the UE transmit an Access Probe on Cell 15 to initiate registration?	-->	<i>Access Probe</i>	1	P

8.1.3.9.3.3 Specific message or IE contents

Table 8.1.3.9.3.3-1: Void

Table 8.1.3.9.3.3-2: RRConnectionRelease (step 1, Table 8.1.3.9.3.2-2)

Derivation Path: 36.508 table 4.6.1-15			
Information Element	Value/remark	Comment	Condition
RRConnectionRelease ::= SEQUENCE {			
criticalExtensions CHOICE {			
c1 CHOICE {			
rrcConnectionRelease-r8 SEQUENCE {			
redirectedCarrierInfo CHOICE {			
cdma2000-HRPD	cdma2000-CarrierInfo for Cell 15		
}			
}			
}			
}			
}			

8.1.3.10 RRC connection release / Redirection from E-UTRAN to CDMA2000-1xRTT

8.1.3.10.1 Test Purpose (TP)

(1)

```
with { UE in E-UTRA RRC_CONNECTED state }
ensure that {
  when { UE receives an RRConnectionRelease message including an IE redirectedCarrierInfo set to cdma2000-1xRTT }
  then { UE enters cdma2000-1xRTT mode }
```

}

8.1.3.10.2 Conformance requirements

References: The conformance requirements covered in the current TC are specified in: TS 36.331, clause 5.3.8.3, 5.3.12 and TS 36.304, clause 5.2.7.

[TS 36.331, clause 5.3.8.3]

The UE shall:

1> delay the following actions defined in this sub-clause 60ms from the moment the *RRConnectionRelease* message was received or optionally when lower layers indicate that the receipt of the *RRConnectionRelease* message has been successfully acknowledged, whichever is earlier;

1> if the *RRConnectionRelease* message includes the *idleModeMobilityControlInfo*:

...

1> else:

2> apply the cell reselection priority information broadcast in the system information;

1> if the *releaseCause* received in the *RRConnectionRelease* message indicates '*loadBalancingTAURequired*':

...

1> else:

2> perform the actions upon leaving RRC_CONNECTED as specified in 5.3.12, with release cause 'other'.

[TS 36.331, clause 5.3.12]

Upon leaving RRC_CONNECTED, the UE shall:

...

1> indicate the release of the RRC connection to upper layers together with the release cause;

1> if leaving RRC_CONNECTED was not triggered by reception of the *MobilityFromEUTRACommand* message:

2> enter RRC_IDLE by performing cell selection in accordance with the cell selection process, defined for the case of leaving RRC_CONNECTED, as specified in TS 36.304 [4].

[TS 36.304, clause 5.2.7]

On transition from RRC_CONNECTED to RRC_IDLE, a UE shall attempt to camp on the last cell for which it was in RRC_CONNECTED or any cell on a frequency or frequency of RAT assigned by RRC in the state transition message.

...

8.1.3.10.3 Test description

8.1.3.10.3.1 Pre-test conditions

System Simulator:

- 2 cells, one E-UTRA and one 1xRTT cell:
 - Cell 1 E-UTRA serving cell
 - Cell 19 suitable neighbour 1xRTT cell
 - The parameters settings and power levels for Cell 1 and Cell 19 are selected according to [18] and Table 8.1.3.10.3.2-1 so that camping on Cell 1 is guaranteed and no cell re-selection to Cell 19 can take place (1xRTT priority is lower than serving and $S_{Cell\ 1} > Thresh_{Cell\ 1,low}$).
 - System information combination 6 as defined in TS 36.508 [18] clause 4.4.3.1 is used in E-UTRA cells.

UE:

- UE is not pre-registered in Cell 19.

Preamble:

- The UE is in state Generic RB Established (state 3) on cell 1 according to [18].

8.1.3.10.3.2 Test procedure sequence

Table 8.1.3.10.3.2-1 shows the cell power levels after the preamble.

Table 8.1.3.10.3.2-1: Time instances of cell power level and parameter changes

	Parameter	Unit	Cell 1	Cell 19	Remark
T0	Cell-specific RS EPRE	dBm/15kHz	-75	-	The power levels are such that camping on Cell 1 is guaranteed.
	Ior/Ioc	dB	-	0	
	Pilot Ec/ Ior	dB	-	-7	
	Ioc	dBm/1.23 MHz	-	-75	
	CPICH_Ec/Io (Note 1)	dB	-	-10	
Note 1: This parameter is not directly settable, but is derived by calculation from the other parameters set by the SS.					

Table 8.1.3.10.3.2-2: Main behaviour

St	Procedure	Message Sequence		TP	Verdict
		U - S	Message		
1	SS transmits an <i>RRConnectionRelease</i> message.	<--	<i>RRConnectionRelease</i>	-	-
2	Check: Does the UE transmit an Access Probe on Cell 19 to initiate registration?	-->	<i>Access Probe</i>	1	P

8.1.3.10.3.3 Specific message or IE contents

Table 8.1.3.10.3.3-1: Void

Table 8.1.3.10.3.3-2: RRConnectionRelease (step 1, Table 8.1.3.10.3.2-1)

Derivation Path: 36.508 table 4.6.1-15			
Information Element	Value/remark	Comment	Condition
RRConnectionRelease ::= SEQUENCE {			
criticalExtensions CHOICE {			
c1 CHOICE {			
rrcConnectionRelease-r8 SEQUENCE {			
redirectedCarrierInfo CHOICE {			
cdma2000-1xRTT	cdma2000-CarrierInfo for Cell 19		
}			
}			
}			
}			
}			

8.1.3.11 RRC connection release / Redirection to another E-UTRAN band

8.1.3.11.1 Test Purpose (TP)

(1)

```

with { UE in E-UTRA RRC_CONNECTED state }
ensure that {
  when { UE receives an RRConnectionRelease message including an IE redirectedCarrierInfo with E-UTRA CarrierFreq on different E-UTRAN band }
  then { UE enters RRC_IDLE state on new E-UTRA frequency included in IE redirectedCarrierInfo }
}

```

8.1.3.11.2 Conformance requirements

References: The conformance requirements covered in the current TC are specified in: TS 36.331, clauses 5.3.8.3, 5.3.12 and TS 36.304, clauses 5.2.4.1, 5.2.7.

[TS 36.331, clause 5.3.8.3]

The UE shall:

- 1> delay the following actions defined in this sub-clause 60ms from the moment the *RRCConnectionRelease* message was received or optionally when lower layers indicate that the receipt of the *RRCConnectionRelease* message has been successfully acknowledged, whichever is earlier;
- 1> if the *RRCConnectionRelease* message includes the *idleModeMobilityControlInfo*:
 - ...
- 1> else:
 - 2> apply the cell reselection priority information broadcast in the system information;
- 1> if the *releaseCause* received in the *RRCConnectionRelease* message indicates '*loadBalancingTAURequired*':
 - ...
- 1> else:
 - 2> perform the actions upon leaving RRC_CONNECTED as specified in 5.3.12, with release cause 'other'.

[TS 36.331, clause 5.3.12]

Upon leaving RRC_CONNECTED, the UE shall:

- ...
- 1> indicate the release of the RRC connection to upper layers together with the release cause;
- 1> if leaving RRC_CONNECTED was not triggered by reception of the *MobilityFromEUTRACommand* message:
 - 2> enter RRC_IDLE by performing cell selection in accordance with the cell selection process, defined for the case of leaving RRC_CONNECTED, as specified in TS 36.304 [4].

[TS 36.304, clause 5.2.4.1]

...

UE shall only perform cell reselection evaluation for E-UTRAN frequencies and inter-RAT frequencies that are given in system information and for which the UE has a priority provided.

...

[TS 36.304, clause 5.2.7]

On transition from RRC_CONNECTED to RRC_IDLE, UE shall select a suitable cell to camp on according to *redirectedCarrierInfo*, if included in the *RRCConnectionRelease* message. Otherwise UE shall select a suitable cell on an EUTRA carrier. If no suitable cell is found, the UE shall perform a cell selection starting with Stored Information Cell Selection procedure in order to find a suitable cell to camp on.

...

8.1.3.11.3 Test description

8.1.3.11.3.1 Pre-test conditions

System Simulator:

- 2 cells on different E-UTRA frequencies and different tracking areas:

- Cell 1 serving cell
- Cell 10 suitable neighbour inter-band cell
- Cell power levels are selected according to [18] so that camping on Cell 1 is guaranteed
- System information combination 3 as defined in TS 36.508 [18] clause 4.4.3.1 is used in E-UTRA cells.

UE:

None.

Preamble:

- The UE is in state Generic RB Established (state 3) according to [18] on cell 1.

8.1.3.11.3.2 Test procedure sequence

Table 8.1.3.11.3.2-1: Main behaviour

St	Procedure	Message Sequence		TP	Verdict
		U - S	Message		
1	SS transmits an <i>RRCCConnectionRelease</i> message (IE <i>redirectedCarrierInfo</i> including <i>utra</i> of Cell 10).	<--	<i>RRCCConnectionRelease</i>	-	-
2	Check: does the test result of generic test procedure in TS 36.508 subclause 6.4.2.7 indicate that the UE is camped on E-UTRAN Cell 10?	-	-	1	-

8.1.3.11.3.3 Specific message contents

Table 8.1.3.11.3.3-1: Conditions for table 8.1.3.11.3.3-3

Condition descriptions
Cell 1 This condition applies to system information transmitted on Cell 1.
Cell 10 This condition applies to system information transmitted on Cell 10.

Table 8.1.3.11.3.3-2: SystemInformationBlockType5 for cells 1 and 10 (preamble and all steps, Table 8.1.3.11.3.2-1)

Derivation Path: 36.508 table 4.4.3.3-4			
Information Element	Value/remark	Comment	Condition
SystemInformationBlockType5 ::= SEQUENCE {			
interFreqCarrierFreqList SEQUENCE (SIZE (1..maxFreq)) OF SEQUENCE {			
dl-CarrierFreq[n]	Same downlink EARFCN as used for Cell 10		Cell 1
	Same downlink EARFCN as used for Cell 1		Cell 10
cellReselectionPriority[n]	3		Cell 1
cellReselectionPriority[n]	3		Cell 10
}			
}			

Table 8.1.3.11.3.3-3: *RRCConnectionRelease* message (step 1, Table 8.1.3.11.3.2-1)

Derivation Path: 36.508 table 4.6.1-15			
Information Element	Value/remark	Comment	Condition
<i>RRCConnectionRelease</i> ::= SEQUENCE {			
criticalExtensions CHOICE {			
c1 CHOICE {			
rrcConnectionRelease-r8 SEQUENCE {			
redirectedCarrierInfo ::= CHOICE {			
eutra	Downlink EARFCN of cell 10		
}			
}			
}			
}			
}			

8.1.3.11a RRC connection release / Redirection to another E-UTRAN band / Between FDD and TDD

8.1.3.11a.1 Test Purpose (TP)

(1)

```
with { UE in E-UTRA FDD RRC_CONNECTED state }
ensure that {
  when { UE receives an RRCConnectionRelease message including an IE redirectedCarrierInfo with E-UTRA CarrierFreq on different E-UTRAN TDD band }
  then { UE enters RRC_IDLE state on new E-UTRA TDD frequency included in IE redirectedCarrierInfo }
}
```

(2)

```
with { UE in E-UTRA TDD RRC_CONNECTED state }
ensure that {
  when { UE receives an RRCConnectionRelease message including an IE redirectedCarrierInfo with E-UTRA CarrierFreq on different E-UTRAN FDD band }
  then { UE enters RRC_IDLE state on new E-UTRA FDD frequency included in IE redirectedCarrierInfo }
}
```

8.1.3.11a.2 Conformance requirements

References: The conformance requirements covered in the current TC are specified in: TS 36.331, clauses 5.3.8.3, 5.3.12 and TS 36.304, clauses 5.2.4.1, 5.2.7.

[TS 36.331, clause 5.3.8.3]

The UE shall:

1> delay the following actions defined in this sub-clause 60ms from the moment the *RRCConnectionRelease* message was received or optionally when lower layers indicate that the receipt of the *RRCConnectionRelease* message has been successfully acknowledged, whichever is earlier;

1> if the *RRCConnectionRelease* message includes the *idleModeMobilityControlInfo*:

...

1> else:

2> apply the cell reselection priority information broadcast in the system information;

1> if the *releaseCause* received in the *RRCConnectionRelease* message indicates '*loadBalancingTAURequired*':

...

1> else:

2> perform the actions upon leaving RRC_CONNECTED as specified in 5.3.12, with release cause 'other'.

[TS 36.331, clause 5.3.12]

Upon leaving RRC_CONNECTED, the UE shall:

...

1> indicate the release of the RRC connection to upper layers together with the release cause;

1> if leaving RRC_CONNECTED was not triggered by reception of the *MobilityFromEUTRACommand* message:

2> enter RRC_IDLE by performing cell selection in accordance with the cell selection process, defined for the case of leaving RRC_CONNECTED, as specified in TS 36.304 [4].

[TS 36.304, clause 5.2.4.1]

...

UE shall only perform cell reselection evaluation for E-UTRAN frequencies and inter-RAT frequencies that are given in system information and for which the UE has a priority provided.

...

[TS 36.304, clause 5.2.7]

On transition from RRC_CONNECTED to RRC_IDLE, UE shall select a suitable cell to camp on according to *redirectedCarrierInfo*, if included in the *RRCConnectionRelease* message. Otherwise UE shall select a suitable cell on an EUTRA carrier. If no suitable cell is found, the UE shall perform a cell selection starting with Stored Information Cell Selection procedure in order to find a suitable cell to camp on.

...

8.1.3.11a.3 Test description

8.1.3.11a.3.1 Pre-test conditions

System Simulator:

- 2 cells on different E-UTRA bands which are in different E-UTRA mode (E-UTRA FDD and E-UTRA TDD) and PLMNs, both PLMNs are UE's EPLMN.
- Cell 1 is FDD cell and Cell 28 is TDD cell
-
- Each cell has only a single PLMN identity. The PLMNs are identified in the test by the identifiers in Table 8.1.3.11a.3.1-1.

Table 8.1.3.11a.3.1-1: PLMN identifiers

Cell	PLMN name
1	PLMN1
28	PLMN2

- System information combination 3 as defined in TS 36.508 [18] clause 4.4.3.1 and Table 6.3.1.2-2 is used in E-UTRA cells.

UE:

None.

Preamble:

- The UE is registered on PLMN1 (Cell 1) using the procedure described in TS 36.508[18] clause 4.5.2.3 except that the ATTACH ACCEPT message indicates PLMN2 in the Equivalent PLMN list as described in Table 8.1.3.11a.3.3-3.
- The UE is in state Generic RB Established (state 3) according to [18] on Cell 1.

8.1.3.11a.3.2 Test procedure sequence

Table 8.1.3.11a.3.2-1: Main behaviour

St	Procedure	Message Sequence		TP	Verdict
		U - S	Message		
1	SS transmits an <i>RRConnectionRelease</i> message (IE <i>redirectedCarrierInfo</i> including eutra CarrierFreq of Cell 28).	<--	<i>RRConnectionRelease</i>	-	-
2	Check: Does the test result of generic test procedure in TS 36.508 subclause 6.4.2.7 indicate that the UE is camped on E-UTRAN Cell 28? NOTE: The TAU is accepted with PLMN1 listed as an Equivalent PLMN	-	-	1	-
3	Generic test procedure in TS 36.508 subclause 4.5.3.3 is performed to make the UE enter state Generic RB Established (state 3) on Cell 28.	-	-	-	-
4	SS transmits an <i>RRConnectionRelease</i> message (IE <i>redirectedCarrierInfo</i> including eutra CarrierFreq of Cell 1).	<--	<i>RRConnectionRelease</i>	-	-
5	Check: Does the test result of generic test procedure in TS 36.508 subclause 6.4.2.7 indicate that the UE is camped on E-UTRAN Cell 1? NOTE: The TAU is accepted with PLMN2 listed as an Equivalent PLMN	-	-	2	-

8.1.3.11a.3.3 Specific message contents

Table 8.1.3.11a.3.3-1: *RRConnectionRelease* message (step 1, Table 8.1.3.11a.3.2-1)

Derivation Path: 36.508 table 4.6.1-15			
Information Element	Value/remark	Comment	Condition
<i>RRConnectionRelease</i> ::= SEQUENCE {			
criticalExtensions CHOICE {			
c1 CHOICE {			
rrcConnectionRelease-r8 SEQUENCE {			
redirectedCarrierInfo ::= CHOICE {			
eutra	Downlink EARFCN of Cell 28		
}			
}			
}			
}			

Table 8.1.3.11a.3.3-2: RRCConnectionRelease message (step 4, Table 8.1.3.11a.3.2-1)

Derivation Path: 36.508 table 4.6.1-15			
Information Element	Value/remark	Comment	Condition
RRCConnectionRelease ::= SEQUENCE {			
criticalExtensions CHOICE {			
c1 CHOICE {			
rrcConnectionRelease-r8 SEQUENCE {			
redirectedCarrierInfo ::= CHOICE {			
eutra	Downlink EARFCN of cell 1		
}			
}			
}			
}			
}			

Table 8.1.3.11a.3.3-3: ATTACH ACCEPT for Cell 1 (preamble)

Derivation path: 36.508 Table 4.7.2-1			
Information Element	Value/Remark	Comment	Condition
Equivalent PLMNs	PLMN2		

Table 8.1.3.11a.3.3-4: TRACKING AREA UPDATE ACCEPT for Cell 28 (step 2, Table 8.1.3.11a.3.2-2)

Derivation path: 36.508 Table 4.7.2-24			
Information Element	Value/Remark	Comment	Condition
Equivalent PLMNs	PLMN1		

Table 8.1.3.11a.3.3-5: TRACKING AREA UPDATE ACCEPT for Cell 1 (step 5, Table 8.1.3.11a.3.2-2)

Derivation path: 36.508 Table 4.7.2-24			
Information Element	Value/Remark	Comment	Condition
Equivalent PLMNs	PLMN2		

8.1.3.12 RRC connection release / Success / With priority information / Inter-band

8.1.3.12.1 Test Purpose (TP)

(1)

```

with { UE in E-UTRA RRC_IDLE state having received an RRCConnectionRelease message with the
freqPriorityListEUTRA with higher priority frequency in different band}
ensure that {
  when { UE detects the cell re-selection criteria are met for the cell which belongs to the higher
priority band }
  then { UE reselects the cell which belongs to the higher priority band}
}

```

8.1.3.12.2 Conformance requirements

References: The conformance requirements covered in the present TC are specified in: TS 36.331, clause 5.3.8.3 and TS 36.304, clause 5.2.4.1, 5.2.4.2 and 5.2.4.5.

[TS 36.331, clause 5.3.8.3]

The UE shall:

- 1> delay the following actions defined in this sub-clause 60 ms from the moment the *RRCConnectionRelease* message was received or optionally when lower layers indicate that the receipt of the *RRCConnectionRelease* message has been successfully acknowledged, whichever is earlier;
- 1> if the *RRCConnectionRelease* message includes the *idleModeMobilityControlInfo*:

2> store the cell reselection priority information provided by the *idleModeMobilityControlInfo*;

2> if the *t320* is included:

3> start timer T320, with the timer value set according to the value of *t320*;

1> else:

...

1> if the *releaseCause* received in the *RRCConnectionRelease* message indicates '*loadBalancingTAURequired*':

2> perform the actions upon leaving RRC_CONNECTED as specified in 5.3.12, with release cause 'load balancing TAU required';

1> else:

2> perform the actions upon leaving RRC_CONNECTED as specified in 5.3.12, with release cause 'other';

[TS 36.304, clause 5.2.4.1]

Absolute priorities of different E-UTRAN frequencies or inter-RAT frequencies may be provided to the UE in the system information, in the *RRCConnectionRelease* message, or by inheriting from another RAT at inter-RAT cell (re)selection. In the case of system information, an E-UTRAN frequency or inter-RAT frequency may be listed without providing a priority (i.e. the field *cellReselectionPriority* is absent for that frequency). If priorities are provided in dedicated signalling, the UE shall ignore all the priorities provided in system information. If UE is in *camped on any cell* state, UE shall only apply the priorities provided by system information from current cell, and the UE preserves priorities provided by dedicated signalling unless specified otherwise. When the UE in *camped normally* state, has only dedicated priorities other than for the current frequency, the UE shall consider the current frequency to be the lowest priority frequency (i.e. lower than the eight network configured values). While the UE is camped on a suitable CSG cell, the UE shall always consider the current frequency to be the highest priority frequency (i.e. higher than the eight network configured values), irrespective of any other priority value allocated to this frequency. The UE shall delete priorities provided by dedicated signalling when:

- the UE enters RRC_CONNECTED state; or
- the optional validity time of dedicated priorities (T320) expires; or
- a PLMN selection is performed on request by NAS [5].

NOTE 1: Equal priorities between RATs are not supported.

The UE shall only perform cell reselection evaluation for E-UTRAN frequencies and inter-RAT frequencies that are given in system information and for which the UE has a priority provided.

The UE shall not consider any black listed cells as candidate for cell reselection.

The UE shall inherit the priorities provided by dedicated signalling and the remaining validity time (i.e., T320 in E-UTRA, T322 in UTRA and T3230 in GERAN), if configured, at inter-RAT cell (re)selection.

NOTE 2: The network may assign dedicated cell reselection priorities for frequencies not configured by system information.

[TS 36.304, clause 5.2.4.2]

When evaluating *Srxlev* and *Squal* of non-serving cells for reselection purposes, the UE shall use parameters provided by the serving cell.

Following rules are used by the UE to limit needed measurements:

- If the serving cell fulfils $S_{rxlev} > S_{IntraSearchP}$ and $S_{qual} > S_{IntraSearchQ}$, the UE may choose not to perform intra-frequency measurements.
- Otherwise, the UE shall perform intra-frequency measurements.
- The UE shall apply the following rules for E-UTRAN inter-frequencies and inter-RAT frequencies which are indicated in system information and for which the UE has priority provided as defined in 5.2.4.1:

- For an E-UTRAN inter-frequency or inter-RAT frequency with a reselection priority higher than the reselection priority of the current E-UTRA frequency the UE shall perform measurements of higher priority E-UTRAN inter-frequency or inter-RAT frequencies according to [10].
- For an E-UTRAN inter-frequency with an equal or lower reselection priority than the reselection priority of the current E-UTRA frequency and for inter-RAT frequency with lower reselection priority than the reselection priority of the current E-UTRAN frequency:
 - If the serving cell fulfils $S_{rxlev} > S_{nonIntraSearchP}$ and $S_{qual} > S_{nonIntraSearchQ}$, the UE may choose not to perform measurements of E-UTRAN inter-frequencies or inter-RAT frequency cells of equal or lower priority.
 - Otherwise, the UE shall perform measurements of E-UTRAN inter-frequencies or inter-RAT frequency cells of equal or lower priority according to [10].

[TS 36.304, clause 5.2.4.5]

If *threshServingLowQ* is provided in *SystemInformationBlockType3*, cell reselection to a cell on a higher priority E-UTRAN frequency or inter-RAT frequency than the serving frequency shall be performed if:

- A cell of a higher priority EUTRAN or UTRAN RAT/ frequency fulfils $S_{qual} > Thresh_{X, HighQ}$ during a time interval $T_{reselection_{RAT}}$; or
- A cell of a higher priority GERAN or CDMA2000 RAT/ frequency fulfils $S_{rxlev} > Thresh_{X, HighP}$ during a time interval $T_{reselection_{RAT}}$; and
- More than 1 second has elapsed since the UE camped on the current serving cell.

Otherwise, cell reselection to a cell on a higher priority E-UTRAN frequency or inter-RAT frequency than the serving frequency shall be performed if:

- A cell of a higher priority RAT/ frequency fulfils $S_{rxlev} > Thresh_{X, HighP}$ during a time interval $T_{reselection_{RAT}}$; and

More than 1 second has elapsed since the UE camped on the current serving cell.

Cell reselection to a cell on an equal priority E-UTRAN frequency shall be based on ranking for Intra-frequency cell reselection as defined in sub-clause 5.2.4.6.

If *threshServingLowQ* is provided in *SystemInformationBlockType3*, cell reselection to a cell on a lower priority E-UTRAN frequency or inter-RAT frequency than the serving frequency shall be performed if:

- The serving cell fulfils $S_{qual} < Thresh_{Serving, LowQ}$ and a cell of a lower priority EUTRAN or UTRAN RAT/ frequency fulfils $S_{qual} > Thresh_{X, LowQ}$ during a time interval $T_{reselection_{RAT}}$; or
- The serving cell fulfils $S_{qual} < Thresh_{Serving, LowQ}$ and a cell of a lower priority GERAN or CDMA2000 RAT/ frequency fulfils $S_{rxlev} > Thresh_{X, LowP}$ during a time interval $T_{reselection_{RAT}}$; and
- More than 1 second has elapsed since the UE camped on the current serving cell.

Otherwise, cell reselection to a cell on a lower priority E-UTRAN frequency or inter-RAT frequency than the serving frequency shall be performed if:

- The serving cell fulfils $S_{rxlev} < Thresh_{Serving, LowP}$ and a cell of a lower priority RAT/ frequency fulfils $S_{rxlev} > Thresh_{X, LowP}$ during a time interval $T_{reselection_{RAT}}$; and
- More than 1 second has elapsed since the UE camped on the current serving cell.

Cell reselection to a higher priority RAT/ frequency shall take precedence over a lower priority RAT/ frequency, if multiple cells of different priorities fulfil the cell reselection criteria.

For cdma2000 RATs, S_{rxlev} is equal to $-FLOOR(-2 \times 10 \times \log_{10} E_c/I_o)$ in units of 0.5 dB, as defined in [18], with E_c/I_o referring to the value measured from the evaluated cell.

For cdma2000 RATs, $Thresh_{X, HighP}$ and $Thresh_{X, LowP}$ are equal to -1 times the values signalled for the corresponding parameters in the system information.

In all the above criteria the value of $T_{reselection_{RAT}}$ is scaled when the UE is in the medium or high mobility state as defined in subclause 5.2.4.3.1. If more than one cell meets the above criteria, the UE shall reselect a cell as follows:

- If the highest-priority frequency is an E-UTRAN frequency, a cell ranked as the best cell among the cells on the highest priority frequency(ies) meeting the criteria according to section 5.2.4.6;
- If the highest-priority frequency is from another RAT, a cell ranked as the best cell among the cells on the highest priority frequency(ies) meeting the criteria of that RAT.

8.1.3.12.3 Test description

8.1.3.12.3.1 Pre-test conditions

System Simulator:

- Cell 1, Cell 3 and Cell 10.
- System information combination 3 as defined in TS 36.508 [18] clause 4.4.3.1 is used in E-UTRA cells.

NOTE 3: For Cell 10 TAI is set to TAI-2

UE:

None.

Preamble:

- The UE is in state Generic RB Established (state 3) on Cell 1 according to [18].

8.1.3.12.3.2 Test procedure sequence

Table 8.1.3.12.3.2-1 illustrates the downlink power levels and other changing parameters to be applied for the cells at various time instants of the test execution. Row marked "T0" denotes the initial conditions after preamble, while columns marked "T1" is to be applied subsequently. The exact instants on which these values shall be applied are described in the texts in this clause.

Table 8.1.3.12.3.2-1: Time instances of cell power level and parameter changes

	Parameter	Unit	Cell 1	Cell 3	Cell 10	Remark
T0	Cell-specific RS EPRE	dBm/ 15kHz z	-85	"off"	"off"	The power level values are assigned to satisfy $S_{rxlev_{Cell 1}} > S_{nonintrasearch}$. (NOTE 1)
T1	Cell-specific RS EPRE	dBm/ 15kHz z	-85	-73	-73	The power level values are assigned to satisfy both $Thresh_{x, low} < S_{rxlev_{Cell 3}}$ and $Thresh_{x, high} < S_{rxlev_{Cell 10}}$.

NOTE 1: Power level "Off" is defined in TS36.508 Table 6.2.2.1-1.

Table 8.1.3.12.3.2-2: Main behaviour

St	Procedure	Message Sequence		TP	Verdict
		U - S	Message		
1	The SS transmits an <i>RRCCONNECTIONRELEASE</i> message including the <i>freqPriorityListEUTRA</i> on Cell 1.	<--	<i>RRCCONNECTIONRELEASE</i>	-	-
2	Wait for 5 s for the UE to enter E-UTRA RRC_IDLE state on Cell 1.	-	-	-	-
3	The SS changes Cell 1, Cell 3 and Cell 10 level according to the row "T1" in table 8.1.3.12.3.2-1.	-	-	-	-
4	Check: Does the test result of generic test procedure in TS 36.508 subclause 6.4.2.7 indicate that the UE is camped on E-UTRAN Cell 10?	-	-	1	-

8.1.3.12.3.3 Specific message contents

Table 8.1.3.12.3.3-1: RRCConnectionRelease (step 1, Table 8.1.3.12.3.2-2)

Derivation Path: 36.508 Table 4.6.1-15			
Information Element	Value/remark	Comment	Condition
RRCConnectionRelease ::= SEQUENCE {			
criticalExtensions CHOICE {			
c1 CHOICE {			
rrcConnectionRelease-r8 SEQUENCE {			
idleModeMobilityControlInfo SEQUENCE {			
freqPriorityListEUTRA SEQUENCE (SIZE (1..maxFreq)) OF SEQUENCE {	3 entries		
carrierFreq[1]	Same downlink EARFCN as used for Cell 1		
cellReselectionPriority[1]	4		
carrierFreq[2]	Same downlink EARFCN as used for Cell 10		
cellReselectionPriority[2]	5		
carrierFreq[3]	Same downlink EARFCN as used for Cell 3		
cellReselectionPriority[3]	1		
}			
freqPriorityListGERAN	Not present		
freqPriorityListUTRA-FDD	Not present		
freqPriorityListUTRA-TDD	Not present		
bandClassPriorityListHRPD	Not present		
bandClassPriorityList1XRTT	Not present		
t320	Not present		
}			
}			
}			
}			
}			

Table 8.1.3.12.3.3-2: SystemInformationBlockType5 for Cell 1 (preamble and all steps, Table 8.1.3.12.3.2-2)

Derivation path: 36.508 table 4.4.3.3-4			
Information Element	Value/Remark	Comment	Condition
SystemInformationBlockType5 ::= SEQUENCE {			
interFreqCarrierFreqList SEQUENCE (SIZE (1..maxFreq)) OF SEQUENCE {			
dl-CarrierFreq[1]	Same downlink EARFCN as used for Cell 3		
dl-CarrierFreq[2]	Same downlink EARFCN as used for Cell 10		
threshX-Low[1]	11		
threshX-High[2]	11		
}			
}			

Table 8.1.3.12.3.3-3: *SystemInformationBlockType5* for Cell 10 (all steps, Table 8.1.3.12.3.2-2)

Derivation path: 36.508 table 4.4.3.3-4			
Information Element	Value/Remark	Comment	Condition
SystemInformationBlockType5 ::= SEQUENCE { interFreqCarrierFreqList SEQUENCE (SIZE (1..maxFreq)) OF SEQUENCE { dl-CarrierFreq[1] dl-CarrierFreq[2] cellReselectionPriority [2] } }	2 entries Same downlink EARFCN as used for Cell 1 Same downlink EARFCN as used for Cell 3 1		

8.1.3.12a RRC connection release / Success / With priority information / Inter- band / Between FDD and TDD

8.1.3.12a.1 Test Purpose (TP)

(1)

```
with { UE in E-UTRA RRC_IDLE state in LTE FDD mode having received an RRCConnectionRelease message
with the freqPriorityListEUTRA with higher priority frequency on different LTE TDD band }
ensure that {
  when { UE detects the cell re-selection criteria are met for the cell which belongs to the higher
priority frequency on different LTE TDD band }
  then { UE reselects the cell which belongs to the higher priority frequency on different LTE TDD
band }
}
```

(2)

```
with { UE in E-UTRA RRC_IDLE state in LTE TDD mode having received an RRCConnectionRelease message
with the freqPriorityListEUTRA with lower priority frequency on different LTE FDD band }
ensure that {
  when { UE detects the cell re-selection criteria are met for the cell which belongs to the lower
priority frequency on different LTE FDD band }
  then { UE reselects the cell which belongs to the lower priority frequency on different LTE FDD
band }
}
```

8.1.3.12a.2 Conformance requirements

References: The conformance requirements covered in the present TC are specified in: TS 36.331, clause 5.3.8.3 and TS 36.304, clause 5.2.4.1, 5.2.4.2 and 5.2.4.5.

[TS 36.331, clause 5.3.8.3]

The UE shall:

1> delay the following actions defined in this sub-clause 60 ms from the moment the *RRCConnectionRelease* message was received or optionally when lower layers indicate that the receipt of the *RRCConnectionRelease* message has been successfully acknowledged, whichever is earlier;

1> if the *RRCConnectionRelease* message includes the *idleModeMobilityControlInfo*:

2> store the cell reselection priority information provided by the *idleModeMobilityControlInfo*;

2> if the *t320* is included:

3> start timer T320, with the timer value set according to the value of *t320*;

1> else:

...

1> if the *releaseCause* received in the *RRCConnectionRelease* message indicates '*loadBalancingTAURequired*':

2> perform the actions upon leaving RRC_CONNECTED as specified in 5.3.12, with release cause 'load balancing TAU required';

1> else:

2> perform the actions upon leaving RRC_CONNECTED as specified in 5.3.12, with release cause 'other';

[TS 36.304, clause 5.2.4.1]

Absolute priorities of different E-UTRAN frequencies or inter-RAT frequencies may be provided to the UE in the system information, in the *RRCConnectionRelease* message, or by inheriting from another RAT at inter-RAT cell (re)selection. In the case of system information, an E-UTRAN frequency or inter-RAT frequency may be listed without providing a priority (i.e. the field *cellReselectionPriority* is absent for that frequency). If priorities are provided in dedicated signalling, the UE shall ignore all the priorities provided in system information. If UE is in *camped on any cell* state, UE shall only apply the priorities provided by system information from current cell, and the UE preserves priorities provided by dedicated signalling unless specified otherwise. When the UE is in *camped normally* state, has only dedicated priorities other than for the current frequency, the UE shall consider the current frequency to be the lowest priority frequency (i.e. lower than the eight network configured values). While the UE is camped on a suitable CSG cell, the UE shall always consider the current frequency to be the highest priority frequency (i.e. higher than the eight network configured values), irrespective of any other priority value allocated to this frequency. The UE shall delete priorities provided by dedicated signalling when:

- the UE enters RRC_CONNECTED state; or
- the optional validity time of dedicated priorities (T320) expires; or
- a PLMN selection is performed on request by NAS [5].

NOTE 1: Equal priorities between RATs are not supported.

The UE shall only perform cell reselection evaluation for E-UTRAN frequencies and inter-RAT frequencies that are given in system information and for which the UE has a priority provided.

The UE shall not consider any black listed cells as candidate for cell reselection.

The UE shall inherit the priorities provided by dedicated signalling and the remaining validity time (i.e., T320 in E-UTRA, T322 in UTRA and T3230 in GERAN), if configured, at inter-RAT cell (re)selection.

NOTE 2: The network may assign dedicated cell reselection priorities for frequencies not configured by system information.

[TS 36.304, clause 5.2.4.2]

When evaluating *Srxlev* and *Squal* of non-serving cells for reselection purposes, the UE shall use parameters provided by the serving cell.

Following rules are used by the UE to limit needed measurements:

- If the serving cell fulfils $S_{rxlev} > S_{IntraSearchP}$ and $S_{qual} > S_{IntraSearchQ}$, the UE may choose not to perform intra-frequency measurements.
- Otherwise, the UE shall perform intra-frequency measurements.
- The UE shall apply the following rules for E-UTRAN inter-frequencies and inter-RAT frequencies which are indicated in system information and for which the UE has priority provided as defined in 5.2.4.1:
 - For an E-UTRAN inter-frequency or inter-RAT frequency with a reselection priority higher than the reselection priority of the current E-UTRA frequency the UE shall perform measurements of higher priority E-UTRAN inter-frequency or inter-RAT frequencies according to [10].
 - For an E-UTRAN inter-frequency with an equal or lower reselection priority than the reselection priority of the current E-UTRA frequency and for inter-RAT frequency with lower reselection priority than the reselection priority of the current E-UTRAN frequency:

- If the serving cell fulfils $S_{rxlev} > S_{nonIntraSearchP}$ and $S_{qual} > S_{nonIntraSearchQ}$, the UE may choose not to perform measurements of E-UTRAN inter-frequencies or inter-RAT frequency cells of equal or lower priority.
- Otherwise, the UE shall perform measurements of E-UTRAN inter-frequencies or inter-RAT frequency cells of equal or lower priority according to [10].

[TS 36.304, clause 5.2.4.5]

If *threshServingLowQ* is provided in *SystemInformationBlockType3*, cell reselection to a cell on a higher priority E-UTRAN frequency or inter-RAT frequency than the serving frequency shall be performed if:

- A cell of a higher priority EUTRAN or UTRAN RAT/ frequency fulfils $S_{qual} > Thresh_{X, HighQ}$ during a time interval $T_{reselection_{RAT}}$; or
- A cell of a higher priority GERAN or CDMA2000 RAT/ frequency fulfils $S_{rxlev} > Thresh_{X, HighP}$ during a time interval $T_{reselection_{RAT}}$; and
- More than 1 second has elapsed since the UE camped on the current serving cell.

Otherwise, cell reselection to a cell on a higher priority E-UTRAN frequency or inter-RAT frequency than the serving frequency shall be performed if:

- A cell of a higher priority RAT/ frequency fulfils $S_{rxlev} > Thresh_{X, HighP}$ during a time interval $T_{reselection_{RAT}}$; and

More than 1 second has elapsed since the UE camped on the current serving cell.

Cell reselection to a cell on an equal priority E-UTRAN frequency shall be based on ranking for Intra-frequency cell reselection as defined in sub-clause 5.2.4.6.

If *threshServingLowQ* is provided in *SystemInformationBlockType3*, cell reselection to a cell on a lower priority E-UTRAN frequency or inter-RAT frequency than the serving frequency shall be performed if:

- The serving cell fulfils $S_{qual} < Thresh_{Serving, LowQ}$ and a cell of a lower priority EUTRAN or UTRAN RAT/ frequency fulfils $S_{qual} > Thresh_{X, LowQ}$ during a time interval $T_{reselection_{RAT}}$; or
- The serving cell fulfils $S_{qual} < Thresh_{Serving, LowQ}$ and a cell of a lower priority GERAN or CDMA2000 RAT/ frequency fulfils $S_{rxlev} > Thresh_{X, LowP}$ during a time interval $T_{reselection_{RAT}}$; and
- More than 1 second has elapsed since the UE camped on the current serving cell.

Otherwise, cell reselection to a cell on a lower priority E-UTRAN frequency or inter-RAT frequency than the serving frequency shall be performed if:

- The serving cell fulfils $S_{rxlev} < Thresh_{Serving, LowP}$ and a cell of a lower priority RAT/ frequency fulfils $S_{rxlev} > Thresh_{X, LowP}$ during a time interval $T_{reselection_{RAT}}$; and
- More than 1 second has elapsed since the UE camped on the current serving cell.

Cell reselection to a higher priority RAT/ frequency shall take precedence over a lower priority RAT/ frequency, if multiple cells of different priorities fulfil the cell reselection criteria.

For cdma2000 RATs, S_{rxlev} is equal to $-FLOOR(-2 \times 10 \times \log_{10} E_c/I_o)$ in units of 0.5 dB, as defined in [18], with E_c/I_o referring to the value measured from the evaluated cell.

For cdma2000 RATs, $Thresh_{X, HighP}$ and $Thresh_{X, LowP}$ are equal to -1 times the values signalled for the corresponding parameters in the system information.

In all the above criteria the value of $T_{reselection_{RAT}}$ is scaled when the UE is in the medium or high mobility state as defined in subclause 5.2.4.3.1. If more than one cell meets the above criteria, the UE shall reselect a cell as follows:

- If the highest-priority frequency is an E-UTRAN frequency, a cell ranked as the best cell among the cells on the highest priority frequency(ies) meeting the criteria according to section 5.2.4.6;
- If the highest-priority frequency is from another RAT, a cell ranked as the best cell among the cells on the highest priority frequency(ies) meeting the criteria of that RAT.

8.1.3.12a.3 Test description

8.1.3.12a.3.1 Pre-test conditions

System Simulator:

- Cell 1 and Cell 2 are FDD cell and Cell 10 is TDD cell
- System information combination 3 as defined in TS 36.508 [18] clause 4.4.3.1 and Table 6.3.1.2-2 is used in E-UTRA cells.

NOTE 1: For Cell 10 TAI is set to TAI-2

UE:

None.

Preamble:

- The UE is in state Generic RB Established (state 3) on Cell 1 according to [18].

8.1.3.12a.3.2 Test procedure sequence

Table 8.1.3.12a.3.2-1 illustrates the downlink power levels and other changing parameters to be applied for the cells at various time instants of the test execution. Row marked "T0" denotes the initial conditions after preamble, while columns marked "T1" is to be applied subsequently. The exact instants on which these values shall be applied are described in the texts in this clause.

Table 8.1.3.12a.3.2-1: Time instances of cell power level and parameter changes

	Parameter	Unit	Cell 1	Cell 2	Cell 10	Remark
T0	Cell-specific RS EPRE	dBm/15k Hz	-79	"off"	"off"	The power level values are assigned to satisfy $S_{rxlev_{Cell\ 1}} > S_{intrasearch}$. (NOTE 1)
T1	Cell-specific RS EPRE	dBm/15k Hz	-79	-73	-73	The power level values are assigned to satisfy $S_{rxlev_{Cell\ 10}} > Thresh_{x, high}$ when reselect to higher priority Cell 10 from lower priority Cell 1
T2	Cell-specific RS EPRE	dBm/15k Hz	-79	-73	-85	The power level values are assigned to satisfy both $S_{rxlev_{Cell\ 2}} > Thresh_{x, low}$ (good enough) and $S_{rxlev_{Cell\ 10}} < Thresh_{serving, low}$ (bad enough)
NOTE 1: Power level "Off" is defined in TS36.508 Table 6.2.2.1-1.						

Table 8.1.3.12a.3.2-2: Main behaviour

St	Procedure	Message Sequence		TP	Verdict
		U - S	Message		
1	The SS transmits an <i>RRCConnectionRelease</i> message including the <i>freqPriorityListEUTRA</i> on Cell 1.	<--	<i>RRCConnectionRelease</i>	-	-
2	Wait for 5 s for the UE to enter E-UTRA RRC_IDLE state on Cell 1.	-	-	-	-
3	The SS changes Cell 2 and Cell 10 levels according to the row "T1" in table 8.1.3.12a.3.2-1.	-	-	-	-
4-8	Check: Does the test result of generic test procedure in TS 36.508 steps 1 to 5 of subclause 6.4.2.7 indicate that the UE is camped on E-UTRAN Cell 10?"	-	-	1	-
9	The SS transmits an <i>RRCConnectionRelease</i> message including the <i>freqPriorityListEUTRA</i> on Cell 10.	<--	<i>RRCConnectionRelease</i>	-	-
10	Wait for 5 s for the UE to enter E-UTRA RRC_IDLE state on Cell 10.	-	-	-	-
11	The SS changes Cell 1 and Cell 10 level according to the row "T2" in table 8.1.3.12a.3.2-1.	-	-	-	-
12-17	Check: Does the test result of generic test procedure in TS 36.508 subclause 6.4.2.7 indicate that the UE is camped on E-UTRAN Cell 2?	-	-	2	-

8.1.3.12a.3.3 Specific message contents

Table 8.1.3.12a.3.3-1: *RRCConnectionRelease* (step 1 and step 9, Table 8.1.3.12a.3.2-2)

Derivation Path: 36.508 Table 4.6.1-15			
Information Element	Value/remark	Comment	Condition
<i>RRCConnectionRelease</i> ::= SEQUENCE {			
criticalExtensions CHOICE {			
c1 CHOICE {			
<i>rrcConnectionRelease-r8</i> SEQUENCE {			
<i>idleModeMobilityControlInfo</i> SEQUENCE {			
<i>freqPriorityListEUTRA</i> SEQUENCE (SIZE (1..maxFreq)) OF SEQUENCE {	2 entries		
<i>carrierFreq</i> [1]	Same downlink EARFCN as used for Cell 1		
<i>cellReselectionPriority</i> [1]	4		
<i>carrierFreq</i> [2]	Same downlink EARFCN as used for Cell 10		
<i>cellReselectionPriority</i> [2]	5		
}			
<i>freqPriorityListGERAN</i>	Not present		
<i>freqPriorityListUTRA-FDD</i>	Not present		
<i>freqPriorityListUTRA-TDD</i>	Not present		
<i>bandClassPriorityListHRPD</i>	Not present		
<i>bandClassPriorityList1XRTT</i>	Not present		
t320	Not present		
}			
}			
}			
}			

Table 8.1.3.12a.3.3-2: SystemInformationBlockType5 for Cell 1 (preamble and all steps, Table 8.1.3.12a.3.2-2)

Derivation path: 36.508 table 4.4.3.3-4			
Information Element	Value/Remark	Comment	Condition
SystemInformationBlockType5 ::= SEQUENCE {			
interFreqCarrierFreqList SEQUENCE (SIZE (1..maxFreq)) OF SEQUENCE {			
dl-CarrierFreq[1]	Same downlink EARFCN as used for Cell 10		
threshX-High[1]	11	Actual value of threshold = IE value * 2 [dB]	
threshX-Low[1]	11	Actual value of threshold = IE value * 2 [dB]	
}			
}			

Table 8.1.3.12a.3.3-3: SystemInformationBlockType3 for Cell 10 (preamble and all steps, Table 8.1.3.12a.3.2-2)

Derivation Path: TS 36.508 [7] clause 4.4.3.3, Table 4.4.3.3-2			
Information Element	Value/remark	Comment	Condition
cellReselectionServingFreqInfo SEQUENCE {			
threshServingLow	14 (28 dB)	28 is actual value in dB (14 * 2 dB)	
}			
intraFreqCellReselectionInfo SEQUENCE {			
s-IntraSearch	0 (0 dB)		
}			

Table 8.1.3.12a.3.3-4: SystemInformationBlockType5 for Cell 10 (preamble and all steps, Table 8.1.3.12a.3.2-2)

Derivation path: 36.508 table 4.4.3.3-4			
Information Element	Value/Remark	Comment	Condition
SystemInformationBlockType5 ::= SEQUENCE {			
interFreqCarrierFreqList SEQUENCE (SIZE (1..maxFreq)) OF SEQUENCE {			
dl-CarrierFreq[1]	Same downlink EARFCN as used for Cell 1		
threshX-High[1]	11	Actual value of threshold = IE value * 2 [dB]	
threshX-Low[1]	11	Actual value of threshold = IE value * 2 [dB]	
}			
}			

Table 8.1.3.12a.3.3-5: SystemInformationBlockType3 for Cells 1 and 2 (preamble and all steps, Table 8.1.3.12a.3.2-2)

Derivation Path: TS 36.508 [7] clause 4.4.3.3, Table 4.4.3.3-2			
Information Element	Value/remark	Comment	Condition
intraFreqCellReselectionInfo SEQUENCE {			
s-IntraSearch	0 (0 dB)		
}			

8.2 RRC connection reconfiguration

8.2.1 Radio bearer establishment

8.2.1.1 RRC connection reconfiguration / Radio bearer establishment for transition from RRC_IDLE to RRC_CONNECTED / Success / Default bearer / Early bearer establishment

8.2.1.1.1 Test Purpose (TP)

(1)

```
with { UE having completed the RRC connection establishment procedure }
ensure that {
  when { SS sends in sequence a SecurityModeCommand and an RRCConnectionReconfiguration message }
  then { UE establishes the initial security configuration in accordance with the received
securityConfigSMC included in SecurityModeCommand and successfully completes the connection
reconfiguration }
}
```

8.2.1.1.2 Conformance requirements

References: The conformance requirements covered in the present TC are specified in: 3GPP TS 36.331 clauses 5.1.2, 5.3.1.1, 5.3.5.3, 5.3.10.1 and 5.3.10.3. The following represent an extraction of the requirements relevant to the test purpose.

[TS 36.331, clause 5.1.2]

The UE shall:

- 1> process the received messages in order of reception by RRC, i.e. the processing of a message shall be completed before starting the processing of a subsequent message;

NOTE 1: E-UTRAN may initiate a subsequent procedure prior to receiving the UEs response of a previously initiated procedure.

[TS 36.331, clause 5.3.1.1]

After having initiated the initial security activation procedure, E-UTRAN initiates the establishment of SRB2 and DRBs, i.e. E-UTRAN may do this prior to receiving the confirmation of the initial security activation from the UE. In any case, E-UTRAN will apply both ciphering and integrity protection for the RRC connection reconfiguration messages used to establish SRB2 and DRBs.

[TS 36.331, clause 5.3.5.3]

If the *RRCConnectionReconfiguration* message does not include the *mobilityControlInfo* and the UE is able to comply with the configuration included in this message, the UE shall:

- 1> if this is the first *RRCConnectionReconfiguration* message after successful completion of the RRC Connection Re-establishment procedure:

...

- 1> else:

- 2> If the *RRCConnectionReconfiguration* message includes the *radioResourceConfigDedicated*:

- 3> perform the radio resource configuration procedure as specified in 5.3.10;

NOTE 2: If the *RRCConnectionReconfiguration* message includes the establishment of radio bearers other than SRB1, the UE may start using these radio bearers immediately, i.e. there is no need to wait for an outstanding acknowledgment of the *SecurityModeComplete* message.

...

- 1> submit the *RRCConnectionReconfigurationComplete* message to lower layers for transmission using the new configuration, upon which the procedure ends;

[TS 36.331, clause 5.3.10.1]

The UE shall:

- 1> for each *srb-Identity* value included in the *srb-ToAddModList* that is not part of the current UE configuration (SRB establishment):
 - 2> apply the specified configuration defined in 9.1.2 for the corresponding SRB;
 - 2> establish a PDCP entity and configure it with the current security configuration, if applicable;
 - 2> establish an RLC entity in accordance with the received *rlc-Config*;
 - 2> establish a DCCCH logical channel in accordance with the received *logicalChannelConfig* and with the logical channel identity set in accordance with 9.1.2

[TS 36.331, clause 5.3.10.3]

The UE shall:

- 1> for each *drb-Identity* value included in the *drb-ToAddModList* that is not part of the current UE configuration (DRB establishment):
 - 2> establish a PDCP entity and configure it with the current security configuration and in accordance with the received *pdcp-Config*;
 - 2> establish an RLC entity in accordance with the received *rlc-Config*;
 - 2> establish a DTCH logical channel in accordance with the received *logicalChannelIdentity* and the received *logicalChannelConfig*;
- 1> indicate the establishment of the DRB(s) and the *eps-BearerIdentity* of the established DRB(s) to upper layers;

8.2.1.1.3 Test description

8.2.1.1.3.1 Pre-test conditions

System Simulator:

- Cell 1

UE:

None.

Preamble:

- The UE is in state Registered, Idle mode (state 2) according to [18].

8.2.1.1.3.2 Test procedure sequence

Table 8.2.1.1.3.2-1: Main behaviour

St	Procedure	Message Sequence		TP	Verdict
		U - S	Message		
1	SS sends a <i>Paging</i> message to the UE on the appropriate paging block, and including the UE identity in one entry of the IE <i>pagingRecordLists</i> .	<--	<i>Paging</i>	-	-
2	UE transmits an <i>RRCConnectionRequest</i> message.	-->	<i>RRCConnectionRequest</i>	-	-
3	SS transmit an <i>RRCConnectionSetup</i> message	<--	<i>RRCConnectionSetup</i>	-	-
4	The UE transmits an <i>RRCConnectionSetupComplete</i> to confirm the successful completion of the connection establishment. (Note 1)	-->	<i>RRCConnectionSetupComplete</i>	-	-
5	SS transmits a <i>SecurityModeCommand</i> message to activate AS security.	<--	<i>SecurityModeCommand</i>	-	-
6	Using the same TTI as the <i>SecurityModeCommand</i> message in step 5, the SS transmits an <i>RRCConnectionReconfiguration</i> message to establish a data radio bearer.	<--	<i>RRCConnectionReconfiguration</i>	-	-
7	Check: Does the UE transmit a <i>SecurityModeComplete</i> message?	-->	<i>SecurityModeComplete</i>	1	P
8	Check: Does the UE transmit an <i>RRCConnectionReconfigurationComplete</i> message to confirm the establishment of data radio bearer?	-->	<i>RRCConnectionReconfigurationComplete</i>	1	P
9	Check: Does the test result of CALL generic procedure in TS 36.508 subclause 6.4.2.3 indicate that UE is in E-UTRA RRC_CONNECTED state?	-	-	1	-

Note 1: Contains a SERVICE REQUEST NAS message.

8.2.1.1.3.3 Specific message contents

Table 8.2.1.1.3.3-1: *RRCConnectionReconfiguration* (step 6, Table 8.2.1.1.3.2-1)

Derivation Path: 36.508 table 4.6.1-8, condition SRB2-DRB(1, 0)

8.2.1.2 Void

8.2.1.3 RRC connection reconfiguration / Radio bearer establishment / Success / Dedicated bearer

8.2.1.3.1 Test Purpose (TP)

(1)

```

with { UE in E-UTRA RRC_CONNECTED state }
ensure that {
  when { SS sends an RRCConnectionReconfiguration message including a drb-Identity that is not part
of the current UE configuration and a dedicatedInfoNASList }
  then { UE successfully establish the radio bearer according to IE radioResourceConfigDedicated }
}

```

8.2.1.3.2 Conformance requirements

References: The conformance requirements covered in the present TC are specified in: 3GPP TS 36.331 clauses 5.3.5.3 and 5.3.10.3.

The following represent an extraction of the requirements relevant to the test purpose.

[TS 36.331, clause 5.3.5.3]

If the *RRConnectionReconfiguration* message does not include the *mobilityControlInformation* and the UE is able to comply with the configuration included in this message, the UE shall:

- 1> if this is the first *RRConnectionReconfiguration* message after successful completion of the RRC Connection Re-establishment procedure:

...

- 1> else:

- 2> If the *RRConnectionReconfiguration* message includes the *radioResourceConfigDedicated*:

- 3> perform the radio resource configuration procedure as specified in 5.3.10;

NOTE 2: If the *RRConnectionReconfiguration* message includes the establishment of radio bearers other than SRB1, the UE may start using these radio bearers immediately, i.e. there is no need to wait for an outstanding acknowledgment of the *SecurityModeComplete* message.

- 1> if the *RRConnectionReconfiguration* message includes the *dedicatedInfoNASList*:

- 2> forward each element of the *dedicatedInfoNASList* to upper layers;

...

- 1> submit the *RRConnectionReconfigurationComplete* message to lower layers for transmission using the new configuration, upon which the procedure ends;

[TS 36.331, clause 5.3.10.3]

The UE shall:

- 1> for each *drb-Identity* value included in the *drb-ToAddModList* that is not part of the current UE configuration (DRB establishment):

- 2> establish a PDCP entity and configure it with the current security configuration and in accordance with the received *pdc-Config*;

- 2> establish an RLC entity in accordance with the received *rlc-Config*;

- 2> establish a DTCH logical channel in accordance with the received *logicalChannelIdentity* and the received *logicalChannelConfig*;

- 1> indicate the establishment of the DRB(s) and the *eps-BearerIdentity* of the established DRB(s) to upper layers;

8.2.1.3.3 Test description

8.2.1.3.3.1 Pre-test conditions

System Simulator:

- Cell 1

UE:

None.

Preamble:

- The UE is in state Generic RB Established (state 3) according to [18].

8.2.1.3.3.2 Test procedure sequence

Table 8.2.1.3.3.2-1: Main behaviour

St	Procedure	Message Sequence		TP	Verdict
		U - S	Message		
1	The SS transmits an <i>RRCCONNECTIONRECONFIGURATION</i> message to establish a data radio bearer.	<--	<i>RRCCONNECTIONRECONFIGURATION</i>	-	-
2	Check: Does the UE transmit an <i>RRCCONNECTIONRECONFIGURATIONCOMPLETE</i> message?	-->	<i>RRCCONNECTIONRECONFIGURATIONCOMPLETE</i>	1	P
3	The UE transmits an <i>ULINFORMATIONTRANSFER</i> message. This message includes an ACTIVATE DEDICATED EPS BEARER CONTEXT ACCEPT message.	-->	<i>ULINFORMATIONTRANSFER</i>	-	-
4	Check: Does the test result of generic test procedure in TS 36.508 subclause 6.4.2.3 indicate that the UE is in E-UTRA RRC_CONNECTED state on Cell 1?	-	-	1	-

8.2.1.3.3.3 Specific message contents

Table 8.2.1.3.3.3-1: *RRCCONNECTIONRECONFIGURATION* (step 1, Table 8.2.1.3.3.2-1)

Derivation Path: 36.508 table 4.6.1-8, condition DRB(1,0)			
Information Element	Value/remark	Comment	Condition
<i>RRCCONNECTIONRECONFIGURATION</i> ::= SEQUENCE {			
criticalExtensions CHOICE {			
c1 CHOICE{			
rrcConnectionReconfiguration-r8 SEQUENCE {			
dedicatedInfoNASList SEQUENCE	1 entry		
(SIZE(1..maxDRB)) OF			
dedicatedInfoNAS [1]	ACTIVATE DEDICATED EPS BEARER CONTEXT REQUEST with EPS bearer identity corresponding to drb-Identity 2	According 36.508 table 4.7.3-3	
}			
}			
}			
}			

8.2.1.4 Void

8.2.1.5 RRC connection reconfiguration / Radio bearer establishment for transition from RRC_Idle to RRC_CONNECTED / Success / Latency check

8.2.1.5.1 Test Purpose (TP)

(1)

```
with { UE in E-UTRA RRC_IDLE state and has sent an RRCCONNECTIONREQUEST message }
ensure that {
  when { UE receive a RRCCONNECTIONSETUP message and 16 subframes later receives an UL grant }
  then { UE successfully transmit RRCCONNECTIONSETUPCOMPLETE message }
}
```

(2)

```
with { UE in E-UTRA RRC_CONNECTED state }
ensure that {
  when { UE receive a SECURITYMODECOMMAND message and 11 subframes later receives an UL grant }
```

```

    then { UE successfully establish the initial AS security activation according to IE
    securityConfigSMC }
  }

```

(3)

```

with { UE in E-UTRA RRC_CONNECTED state }
ensure that {
  when { UE receive a RRCConnectionReconfiguration message including a drb-Identity that is not part
of the current UE configuration and a nas-DedicatedInformation and 16 subframes later receives an UL
grant }
  then { UE successfully establish the radio bearer according to IE radioResourceConfiguration }
}

```

(4)

```

with { UE in E-UTRA RRC_CONNECTED state }
ensure that {
  when { UE receives an UECapabilityEnquiry message after AS security is activated and at 11
subframes later receives an UL grant }
  then { UE successfully transmits an UECapabilityInformation message including UE radio access
capability information corresponding to the ue-RadioAccessCapRequest variable }
}

```

8.2.1.5.2 Conformance requirements

References: The conformance requirements covered in the present TC are specified in: TS 36.331, clause 5.3.3.4, 5.3.4.3, 5.3.5.3, 5.6.3.3 and 11.2.

[TS 36.331, clause 5.3.3.4]

The UE shall:

- 1> perform the radio resource configuration procedure in accordance with the received *radioResourceConfigDedicated* and as specified in 5.3.10;
- 1> if stored, discard the cell reselection priority information provided by the *idleModeMobilityControlInfo* or inherited from another RAT;
- 1> stop timer T300;
- 1> stop timer T302, if running;
- 1> stop timer T303, if running;
- 1> stop timer T305, if running;
- 1> perform the actions as specified in 5.3.3.7;
- 1> stop timer T320, if running;
- 1> enter RRC_CONNECTED;
- 1> stop the cell re-selection procedure;
- 1> set the content of *RRCConnectionSetupComplete* message as follows:
 - 2> set the *selectedPLMN-Identity* to the PLMN selected by upper layers (see TS 23.122 [11], TS 24.301 [35]) from the PLMN(s) included in the *plmn-IdentityList* in *SystemInformationBlockType1*;
 - 2> if upper layers provide the 'Registered MME', include and set the *registeredMME* as follows:
 - 3> if the PLMN identity of the 'Registered MME' is different from the PLMN selected by the upper layers:
 - 4> include the *plmnIdentity* in the *registeredMME* and set it to the value of the PLMN identity in the 'Registered MME' received from upper layers;
 - 3> set the *mmegi* and the *mmec* to the value received from upper layers;

- 2> set the *dedicatedInfoNAS* to include the information received from upper layers;
- 2> submit the *RRCConnectionSetupComplete* message to lower layers for transmission, upon which the procedure ends;

[TS 36.331, clause 5.3.4.3]

The UE shall:

- 1> derive the K_{eNB} key, as specified in TS 33.401 [32];
- 1> derive the K_{RRCint} key associated with the *integrityProtAlgorithm* indicated in the *SecurityModeCommand* message, as specified in TS 33.401 [32];
- 1> request lower layers to verify the integrity protection of the *SecurityModeCommand* message, using the algorithm indicated by the *integrityProtAlgorithm* as included in the *SecurityModeCommand* message and the K_{RRCint} key;
- 1> if the *SecurityModeCommand* message passes the integrity protection check:
 - 2> derive the K_{RRCenc} key and the K_{UPenc} key associated with the *cipheringAlgorithm* indicated in the *SecurityModeCommand* message, as specified in TS 33.401 [32];
 - 2> configure lower layers to apply integrity protection using the indicated algorithm and the K_{RRCint} key immediately, i.e. integrity protection shall be applied to all subsequent messages received and sent by the UE, including the *SecurityModeComplete* message;
 - 2> configure lower layers to apply ciphering using the indicated algorithm, the K_{RRCenc} key and the K_{UPenc} key after completing the procedure, i.e. ciphering shall be applied to all subsequent messages received and sent by the UE, except for the *SecurityModeComplete* message which is sent unciphered;
 - 2> consider AS security to be activated;
 - 2> submit the *SecurityModeComplete* message to lower layers for transmission, upon which the procedure ends;

[TS 36.331, clause 5.3.5.3]

If the *RRCConnectionReconfiguration* message does not include the *mobilityControlInfo* and the UE is able to comply with the configuration included in this message, the UE shall:

- 1> if this is the first *RRCConnectionReconfiguration* message after successful completion of the RRC Connection Re-establishment procedure:

...

- 1> else:

- 2> if the *RRCConnectionReconfiguration* message includes the *radioResourceConfigDedicated*:
 - 3> perform the radio resource configuration procedure as specified in 5.3.10;

NOTE 2: If the *RRCConnectionReconfiguration* message includes the establishment of radio bearers other than SRB1, the UE may start using these radio bearers immediately, i.e. there is no need to wait for an outstanding acknowledgment of the *SecurityModeComplete* message.

- 1> if the *RRCConnectionReconfiguration* message includes the *dedicatedInfoNASList*:

- 2> forward each element of the *dedicatedInfoNASList* to upper layers;

...

- 1> submit the *RRCConnectionReconfigurationComplete* message to lower layers for transmission using the new configuration, upon which the procedure ends;

[TS 36.331, clause 5.6.3.3]

The UE shall:

- 1> set the contents of *UECapabilityInformation* message as follows:
 - 2> if the *ue-CapabilityRequest* includes 'eutra':
 - 3> include the *UE-EUTRA-Capability* within a *ue-CapabilityRAT-Container* and with the *rat-Type* set to 'eutra';
 - 2> if the *ue-CapabilityRequest* includes 'geran-cs' and if the UE supports GERAN CS domain:
 - 3> include the UE radio access capabilities for GERAN CS within a *ue-CapabilityRAT-Container* and with the *rat-Type* set to 'geran-cs';
 - 2> if the *ue-CapabilityRequest* includes 'geran-ps' and if the UE supports GERAN PS domain:
 - 3> include the UE radio access capabilities for GERAN PS within a *ue-CapabilityRAT-Container* and with the *rat-Type* set to 'geran-ps';
 - 2> if the *ue-CapabilityRequest* includes 'utra' and if the UE supports UTRA:
 - 3> include the UE radio access capabilities for UTRA within a *ue-CapabilityRAT-Container* and with the *rat-Type* set to 'utra';
 - ...
 - 1> submit the *UECapabilityInformation* message to lower layers for transmission, upon which the procedure ends;
- [TS 36.331, clause 11.2]

The UE performance requirements for RRC procedures are specified in the following table, by means of a value N:

N = the number of 1ms subframes from the end of reception of the E-UTRAN -> UE message on the UE physical layer up to when the UE shall be ready for the reception of uplink grant for the UE -> E-UTRAN response message with no access delay other than the TTI-alignment (e.g. excluding delays caused by scheduling, the random access procedure or physical layer synchronisation).

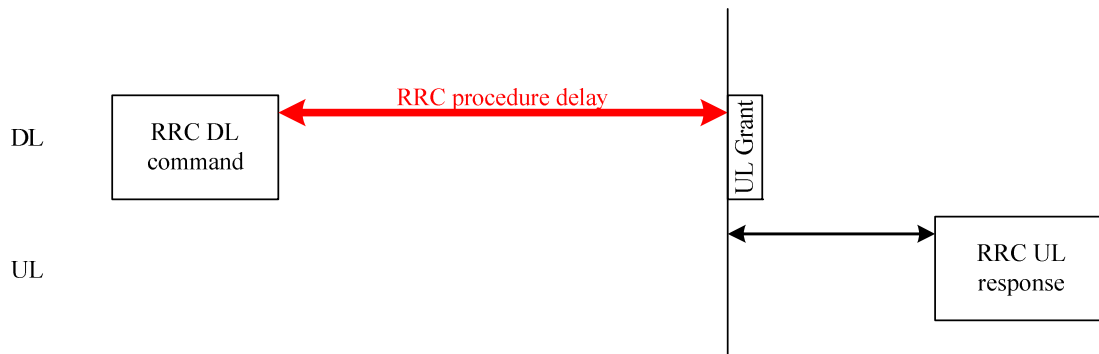

Figure 11.2-1: Illustration of RRC procedure delay

Procedure title:	E-UTRAN -> UE	UE -> E-UTRAN	N	Notes
RRC Connection Control Procedures				
RRC connection establishment	<i>RRConnectionSetup</i>	<i>RRConnectionSetupComplete</i>	15	
RRC connection re-configuration (radio resource configuration)	<i>RRConnectionReconfiguration</i>	<i>RRConnectionReconfigurationComplete</i>	15	
Initial security activation	<i>SecurityModeCommand</i>	<i>SecurityModeCommandComplete/SecurityModeCommandFailure</i>	10	
Other procedures				
UE capability transfer	<i>UECapabilityEnquiry</i>	<i>UECapabilityInformation</i>	10	

8.2.1.5.3 Test description

8.2.1.5.3.1 Pre-test conditions

System Simulator:

- Cell 1

UE:

None.

Preamble:

- The UE is in state Registered, Idle mode (state 2) according to [18].

8.2.1.5.3.2 Test procedure sequence

Table 8.2.1.5.3.2-1: Main behaviour

St	Procedure	Message Sequence		TP	Verdict
		U - S	Message		
1	The SS sends a <i>Paging</i> message to the UE on the appropriate paging block, and including the UE identity in one entry of the IE <i>pagingRecordList</i> .	<--	<i>Paging</i>	-	-
2	The UE transmits an <i>RRCConectionRequest</i> message.	-->	<i>RRCConectionRequest</i>	-	-
3	The SS transmit an <i>RRCConectionSetup</i> message. (Note 3)	<--	<i>RRCConectionSetup</i>		
4	Check: Does the UE transmit an <i>RRCConectionSetupComplete</i> message within 20 (FDD)/23 (TDD) subframes after successful completion of step 3? (Note 2)	-->	<i>RRCConectionSetupComplete</i>	1	P
5	The SS transmits a <i>SecurityModeCommand</i> message to activate AS security. (Note 3)	<--	<i>SecurityModeCommand</i>		
6	Check: Does the UE transmit a <i>SecurityModeComplete</i> message within 15 (FDD)/18 (TDD) subframes after successful completion of step 5? (Note 2)	-->	<i>SecurityModeComplete</i>	2	P
7	The SS transmits an <i>RRCConectionReconfiguration</i> message to establish a data radio bearer. (Note 3)	<--	<i>RRCConectionReconfiguration</i>	-	-
8	Check: Does the UE transmit an <i>RRCConectionReconfigurationComplete</i> message within 20 (FDD)/23 (TDD) subframes after successful completion of step 7? (Note 2)	-->	<i>RRCConectionReconfigurationComplete</i>	3	P
9	The SS transmits a <i>UECapabilityEnquiry</i> message to request UE radio access capability information for E UTRA only. (Note 3)	<--	<i>UECapabilityEnquiry</i>	-	-
10	Check: Does the UE transmit a <i>UECapabilityInformation</i> message within 15 (FDD)/18 (TDD) subframes after successful completion of step 9? (Note 2)	-->	<i>UECapabilityInformation</i>	4	P
<p>Note 1: The SS is configured for RRC procedure delay testing according to TS 36.523-3 clause 7.12.1.</p> <p>Note 2: 5 (FDD) / 8 (TDD) subframes is added on top of RRC processing delay requirement, because UL grant is allocated for the next subframe after RRC procedure delay and because of transmission delay after UL grant. For TDD, consider the max 7 TTI transmission delay after UL grant.</p> <p>Note 3: The DL resource allocation sent on PDCCH is big enough to guarantee transmission of all DL RRC PDU in single TTI.</p>					

8.2.1.5.3.3 Specific message contents

Table 8.2.1.5.3.3-1: RRCConnectionRequest (step 2, Table 8.2.1.5.3.2-1)

Derivation Path: 36.508, Table 4.6.1-16			
Information Element	Value/remark	Comment	Condition
RRCConnectionRequest ::= SEQUENCE {			
criticalExtensions CHOICE {			
rrcConnectionRequest-r8 SEQUENCE {			
establishmentCause	mt-Access		
}			
}			
}			

Table 8.2.1.5.3.3-2: RRCConnectionSetup (step 3, Table 8.2.1.5.3.2-1)

Derivation Path: 36.508, Table 4.6.1-17			
Information Element	Value/remark	Comment	Condition
RRCConnectionSetup ::= SEQUENCE {			
criticalExtensions CHOICE {			
c1 CHOICE {			
rrcConnectionSetup-r8 SEQUENCE {			
radioResourceConfigDedicated SEQUENCE {			
mac-MainConfig CHOICE {			
timeAlignmentTimerDedicated	Infinity		
}			
}			
}			
}			
}			

Table 8.2.1.5.3.3-3: RRCConnectionReconfiguration (step 7, Table 8.2.1.5.3.2-1)

Derivation Path: 36.508 table 4.6.1-8, condition SRB2-DRB(1, 0)			
Information Element	Value/Remark	Comment	Condition
RRCConnectionReconfiguration ::= SEQUENCE {			
criticalExtensions CHOICE {			
c1 CHOICE{			
rrcConnectionReconfiguration-r8 SEQUENCE {			
RadioResourceConfigDedicated SEQUENCE {			
mac-MainConfig CHOICE {			
drx-Config	Not present		
timeAlignmentTimerDedicated	Infinity		
}			
}			
}			
}			
}			

Table 8.2.1.5.3.3-4: RRCConnectionReconfiguration (preamble: Table 4.5.2.3-1 [18], step 14)

Derivation Path: 36.508 table 4.6.1-8, condition SRB2-DRB(1, 0)			
Information Element	Value/Remark	Comment	Condition
RRCConnectionReconfiguration ::= SEQUENCE {			
criticalExtensions CHOICE {			
c1 CHOICE{			
rrcConnectionReconfiguration-r8 SEQUENCE {			
RadioResourceConfigDedicated SEQUENCE {			
mac-MainConfig CHOICE {			
drx-Config	Not present		
}			
}			
}			
}			
}			
}			
}			

8.2.1.6 RRC connection reconfiguration / Radio bearer establishment for transition from RRC_Idle to RRC CONNECTED / Success / Latency check / SecurityModeCommand and RRCConnectionReconfiguration transmitted in the same TTI

8.2.1.6.1 Test Purpose (TP)

(1)

```
with { UE in E-UTRA RRC_CONNECTED state }
ensure that {
  when { UE received SecurityModeCommand message and RRCConnectionReconfiguration message including
a drb-Identity that is not part of the current UE configuration and a nas-DedicatedInformation in
the same TTI and 21 subframes later receives an UL grant }
  then { UE successfully establish the initial AS security activation according to IE
securityConfigSMC and the radio bearer according to IE radioResourceConfiguration }
}
```

8.2.1.6.2 Conformance requirements

References: The conformance requirements covered in the present TC are specified in: TS 36.331, clause 5.3.4.3, 5.3.5.3 and 11.2.

[TS 36.331, clause 5.3.4.3]

The UE shall:

- 1> derive the K_{eNB} key, as specified in TS 33.401 [32];
- 1> derive the K_{RRCint} key associated with the *integrityProtAlgorithm* indicated in the *SecurityModeCommand* message, as specified in TS 33.401 [32];
- 1> request lower layers to verify the integrity protection of the *SecurityModeCommand* message, using the algorithm indicated by the *integrityProtAlgorithm* as included in the *SecurityModeCommand* message and the K_{RRCint} key;
- 1> if the *SecurityModeCommand* message passes the integrity protection check:
 - 2> derive the K_{RRCenc} key and the K_{UPenc} key associated with the *cipheringAlgorithm* indicated in the *SecurityModeCommand* message, as specified in TS 33.401 [32];
 - 2> configure lower layers to apply integrity protection using the indicated algorithm and the K_{RRCint} key immediately, i.e. integrity protection shall be applied to all subsequent messages received and sent by the UE, including the *SecurityModeComplete* message;

- 2> configure lower layers to apply ciphering using the indicated algorithm, the K_{RRCEnc} key and the K_{UPenc} key after completing the procedure, i.e. ciphering shall be applied to all subsequent messages received and sent by the UE, except for the *SecurityModeComplete* message which is sent unciphered;
- 2> consider AS security to be activated;
- 2> submit the *SecurityModeComplete* message to lower layers for transmission, upon which the procedure ends;

[TS 36.331, clause 5.3.5.3]

If the *RRCCONNECTIONRECONFIGURATION* message does not include the *mobilityControlInfo* and the UE is able to comply with the configuration included in this message, the UE shall:

- 1> if this is the first *RRCCONNECTIONRECONFIGURATION* message after successful completion of the RRC Connection Re-establishment procedure:

...

- 1> else:

- 2> if the *RRCCONNECTIONRECONFIGURATION* message includes the *radioResourceConfigDedicated*:

- 3> perform the radio resource configuration procedure as specified in 5.3.10;

NOTE 2: If the *RRCCONNECTIONRECONFIGURATION* message includes the establishment of radio bearers other than SRB1, the UE may start using these radio bearers immediately, i.e. there is no need to wait for an outstanding acknowledgment of the *SecurityModeComplete* message.

- 1> if the *RRCCONNECTIONRECONFIGURATION* message includes the *dedicatedInfoNASList*:

- 2> forward each element of the *dedicatedInfoNASList* to upper layers;

...

- 1> submit the *RRCCONNECTIONRECONFIGURATIONCOMPLETE* message to lower layers for transmission using the new configuration, upon which the procedure ends;

[TS 36.331, clause 11.2]

The UE performance requirements for RRC procedures are specified in the following table, by means of a value N:

N = the number of 1ms subframes from the end of reception of the E-UTRAN -> UE message on the UE physical layer up to when the UE shall be ready for the reception of uplink grant for the UE -> E-UTRAN response message with no access delay other than the TTI-alignment (e.g. excluding delays caused by scheduling, the random access procedure or physical layer synchronisation).

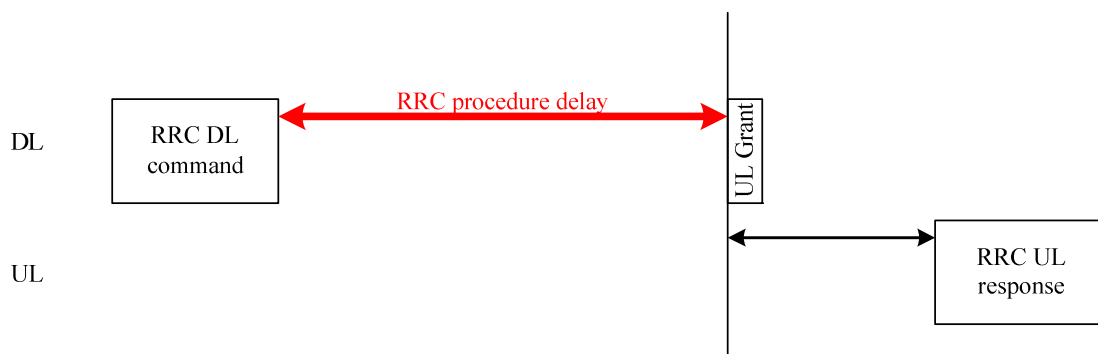

Figure 11.2-1: Illustration of RRC procedure delay

Procedure title:	E-UTRAN -> UE	UE -> E-UTRAN	N	Notes
------------------	---------------	---------------	---	-------

Procedure title:	E-UTRAN -> UE	UE -> E-UTRAN	N	Notes
RRC Connection Control Procedures				
Initial security activation + RRC connection re-configuration (RB establishment)	<i>SecurityModeCommand, RRCConnectionReconfiguration</i>	<i>RRCCONNECTIONRECONFIGURATIONCOMPLETE</i>	20	The two DL messages are transmitted in the same TTI

8.2.1.6.3 Test description

8.2.1.6.3.1 Pre-test conditions

System Simulator:

- Cell 1

UE:

None.

Preamble:

- The UE is in state Registered, Idle mode (state 2) according to [18].

8.2.1.6.3.2 Test procedure sequence

Table 8.2.1.6.3.2-1: Main behaviour

St	Procedure	Message Sequence		TP	Verdict
		U - S	Message		
1	The SS sends a <i>Paging</i> message to the UE on the appropriate paging block, and including the UE identity in one entry of the IE <i>pagingRecordList</i> .	<--	<i>Paging</i>	-	-
2	The UE transmits an <i>RRCCONNECTIONREQUEST</i> message.	-->	<i>RRCCONNECTIONREQUEST</i>	-	-
3	The SS transmit an <i>RRCCONNECTIONSETUP</i> message.	<--	<i>RRCCONNECTIONSETUP</i>	-	-
4	The UE transmit an <i>RRCCONNECTIONSETUPCOMPLETE</i> message.	-->	<i>RRCCONNECTIONSETUPCOMPLETE</i>	-	-
5	The SS transmits a <i>SecurityModeCommand</i> message to activate AS security. (Note 3)	<--	<i>SecurityModeCommand</i>	-	-
6	The SS transmits a <i>RRCCONNECTIONRECONFIGURATION</i> message to establish a data radio bearer. (Note 3)	<--	<i>RRCCONNECTIONRECONFIGURATION</i>	-	-
7	Check: Does the UE transmit an <i>SecurityModeComplete</i> message within 25 (FDD)/28 (TDD) subframes after successful completion of step 5? (Note 2)	-->	<i>SecurityModeComplete</i>	1	P
8	Check: Does the UE transmit an <i>RRCCONNECTIONRECONFIGURATIONCOMPLETE</i> message within 25 (FDD)/28 (TDD) subframes after successful completion of step 6? (Note 2)	-->	<i>RRCCONNECTIONRECONFIGURATIONCOMPLETE</i>	1	P
<p>Note 1: The SS is configured for RRC procedure delay testing according to TS 36.523-3 clause 7.12.1.</p> <p>Note 2: 5 (FDD) / 8 (TDD) subframes is added on top of RRC processing delay requirement, because UL grant is allocated for the next subframe after RRC procedure delay and because of transmission delay after UL grant. For TDD, consider the max 7 TTI transmission delay after UL grant.</p> <p>Note 3: The DL resource allocation sent on PDCCH is big enough to guarantee transmission of all DL RRC PDU in single TTI.</p>					

8.2.1.6.3.3 Specific message contents

Table 8.2.1.6.3.3-1: RRCConnectionRequest (step 2, Table 8.2.1.6.3.2-1)

Derivation Path: 36.508, Table 4.6.1-16			
Information Element	Value/remark	Comment	Condition
RRCConnectionRequest ::= SEQUENCE {			
criticalExtensions CHOICE {			
rrcConnectionRequest-r8 SEQUENCE {			
establishmentCause	mt-Access		
}			
}			
}			

Table 8.2.1.6.3.3-2: RRCConnectionSetup (step 3, Table 8.2.1.6.3.2-1)

Derivation Path: 36.508, Table 4.6.1-17			
Information Element	Value/remark	Comment	Condition
RRCConnectionSetup ::= SEQUENCE {			
criticalExtensions CHOICE {			
c1 CHOICE {			
rrcConnectionSetup-r8 SEQUENCE {			
radioResourceConfigDedicated SEQUENCE {			
mac-MainConfig CHOICE {			
timeAlignmentTimerDedicated	Infinity		
}			
}			
}			
}			
}			

Table 8.2.1.6.3.3-3: RRCConnectionReconfiguration (step 6, Table 8.2.1.6.3.2-1)

Derivation Path: 36.508 table 4.6.1-8, condition SRB2-DRB(1, 0)			
Information Element	Value/Remark	Comment	Condition
RRCConnectionReconfiguration ::= SEQUENCE {			
criticalExtensions CHOICE {			
c1 CHOICE{			
rrcConnectionReconfiguration-r8 SEQUENCE {			
RadioResourceConfigDedicated SEQUENCE {			
mac-MainConfig CHOICE {			
drx-Config	Not present		
timeAlignmentTimerDedicated	Infinity		
}			
}			
}			
}			
}			

Table 8.2.1.6.3.3-4: RRCConnectionReconfiguration (preamble: Table 4.5.2.3-1 [18], step 14)

Derivation Path: 36.508 table 4.6.1-8, condition SRB2-DRB(1, 0)			
Information Element	Value/Remark	Comment	Condition
RRCConnectionReconfiguration ::= SEQUENCE {			
criticalExtensions CHOICE {			
c1 CHOICE{			
rrcConnectionReconfiguration-r8 SEQUENCE {			
RadioResourceConfigDedicated SEQUENCE {			
mac-MainConfig CHOICE {			
drx-Config	Not present		
}			
}			
}			
}			
}			
}			

8.2.1.7 RRC connection reconfiguration / Radio bearer establishment / Success / SRB2

8.2.1.7.1 Test Purpose (TP)

```
with { UE in E-UTRA RRC_CONNECTED state without SRB2}
ensure that {
  when { SS sends an RRCConnectionReconfiguration message including SRB2 configuration }
  then { UE successfully establish the signalling radio bearer }
}
```

8.2.1.7.2 Conformance requirements

References: The conformance requirements covered in the present TC are specified in: 3GPP TS 36.331 clauses 5.3.5.3, and 5.3.10.1.

The following represent an extraction of the requirements relevant to the test purpose.

[TS 36.331, clause 5.3.5.3]

If the *RRCConnectionReconfiguration* message does not include the *mobilityControlInfo* and the UE is able to comply with the configuration included in this message, the UE shall:

- 1> if this is the first *RRCConnectionReconfiguration* message after successful completion of the RRC Connection Re-establishment procedure:

...

- 1> else:

- 2> if the *RRCConnectionReconfiguration* message includes the *radioResourceConfigDedicated*:

- 3> perform the radio resource configuration procedure as specified in 5.3.10;

NOTE 2: If the *RRCConnectionReconfiguration* message includes the establishment of radio bearers other than SRB1, the UE may start using these radio bearers immediately, i.e. there is no need to wait for an outstanding acknowledgment of the *SecurityModeComplete* message.

...

- 1> submit the *RRCConnectionReconfigurationComplete* message to lower layers for transmission using the new configuration, upon which the procedure ends;

[TS 36.331, clause 5.3.10.1]

The UE shall:

- 1> for each *srb-Identity* value included in the *srb-ToAddModList* that is not part of the current UE configuration (SRB establishment):

- 2> apply the specified configuration defined in 9.1.2 for the corresponding SRB;
- 2> establish a PDCP entity and configure it with the current security configuration, if applicable;
- 2> establish an RLC entity in accordance with the received *rlc-Config*;
- 2> establish a DCCH logical channel in accordance with the received *logicalChannelConfig* and with the logical channel identity set in accordance with 9.1.2;

8.2.1.7.3 Test description

8.2.1.7.3.1 Pre-test conditions

System Simulator:

- Cell 1

UE:

None.

Preamble:

- The UE is in state Registered, Idle Mode (State 2) according to [18].

8.2.1.7.3.2 Test procedure sequence

Table 8.2.1.7.3.2-1: Main behaviour

St	Procedure	Message Sequence		TP	Verdict
		U - S	Message		
1-7	Generic Radio Bearer Establishment (State 3) step 1 to 7 in TS 36.508 subclause 4.5.3.3.			-	-
8	The SS transmits an <i>RRCConnectionReconfiguration</i> message to establish SRB2.	<--	<i>RRCConnectionReconfiguration</i>	-	-
9	Check: Does the UE transmits an <i>RRCConnectionReconfigurationComplete</i> message?	-->	<i>RRCConnectionReconfigurationComplete</i>	1	P
10	Check: Does the test result of CALL generic procedure in TS 36.508 subclause 6.4.2.3 indicates that UE is in E-UTRA RRC_CONNECTED state on Cell 1?	-	-	1	-

8.2.1.7.3.3 Specific message contents

Table 8.2.1.7.3.3-1: RRCConnectionReconfiguration (step 8, Table 8.2.1.7.3.2-1))

Derivation Path: 36.508 table 4.6.1-6, condition SRB2-DRB(1, 0)			
Information Element	Value/remark	Comment	Condition
RRCConnectionReconfiguration ::= SEQUENCE {			
criticalExtensions CHOICE {			
C1 CHOICE{			
rrcConnectionReconfiguration-r8 SEQUENCE {			
radioResourceConfigDedicated SEQUENCE {			
srb-ToAddModList SEQUENCE (SIZE (1..2))			
OF SEQUENCE {			
srb-ToAddMod[1] SEQUENCE {			
rlc-Config CHOICE {			
explicitValue	RLC-Config-NON-DEFAULT-SRB2		
}			
}			
}			
}			
}			
}			

Table 8.2.1.7.3.3-2: RLC-Config-NON-DEFAULT-SRB2 (Table 8.2.1.7.3.3-1))

Derivation Path: 36.331 clauses 6.3.2, 9.2.1.2			
Information Element	Value/remark	Comment	Condition
RLC-Config-NON-DEFAULT-SRB2 ::= CHOICE {			
am SEQUENCE {			
ul-AM-RLC SEQUENCE {			
t-PollRetransmit	ms100		
pollPDU	p16		
pollByte	kb500		
maxRetxThreshold	t6		
}			
dl-AM-RLC SEQUENCE {			
t-Reordering	ms100		
t-StatusProhibit	ms200		
}			
}			
}			

8.2.1.8 RRC connection reconfiguration / Radio bearer establishment / Success / Dedicated bearer / ROHC configured

8.2.1.8.1 Test Purpose (TP)

(1)

```

with { UE in E-UTRA RRC_CONNECTED state }
ensure that {
  when { UE receives an RRCConnectionReconfiguration message including IE headerCompression set to "rohc" }
  then { UE transmits an RRCConnectionReconfigurationComplete message }
}

```

8.2.1.8.2 Conformance requirements

References: The conformance requirements covered in the present TC are specified in: TS 36.331, clause 5.3.5.3, clause 5.3.10.0, clause 5.3.10.3, TS 36.323, clause 5.5.1, 5.5.2 and TS 36.306, clause 4.3.1.1.

[TS 36.331, clause 5.3.5.3]

If the *RRCCONNECTIONRECONFIGURATION* message does not include the *mobilityControlInfo* and the UE is able to comply with the configuration included in this message, the UE shall:

- 1> if this is the first *RRCCONNECTIONRECONFIGURATION* message after successful completion of the RRC Connection Re-establishment procedure:

...

- 1> else:

- 2> if the *RRCCONNECTIONRECONFIGURATION* message includes the *radioResourceConfigDedicated*:

- 3> perform the radio resource configuration procedure as specified in 5.3.10;

[TS 36.331, clause 5.3.10.0]

The UE shall:

...

- 1> if the received *radioResourceConfigDedicated* includes the *drb-ToAddModList*:

- 2> perform DRB addition or reconfiguration as specified in 5.3.10.3;

[TS 36.331, clause 5.3.10.3]

The UE shall:

- 1> for each *drb-Identity* value included in the *drb-ToAddModList* that is not part of the current UE configuration (DRB establishment including the case when full configuration option is used):

- 2> establish a PDCP entity and configure it with the current security configuration and in accordance with the received *pdcp-Config*;

[TS 36.323, clause 5.5.1]

The header compression protocol is based on the Robust Header Compression (ROHC) framework [7]. There are multiple header compression algorithms, called profiles, defined for the ROHC framework. Each profile is specific to the particular network layer, transport layer or upper layer protocol combination e.g. TCP/IP and RTP/UDP/IP.

The detailed definition of the ROHC channel is specified as part of the ROHC framework in RFC 4995 [7]. This includes how to multiplex different flows (header compressed or not) over the ROHC channel, as well as how to associate a specific IP flow with a specific context state during initialization of the compression algorithm for that flow.

The implementation of the functionality of the ROHC framework and of the functionality of the supported header compression profiles is not covered in this specification.

In this version of the specification the support of the following profiles is described:

Table 5.5.1.1: Supported header compression protocols and profiles

Profile Identifier	Usage:	Reference
0x0000	No compression	RFC 4995
0x0001	RTP/UDP/IP	RFC 3095, RFC 4815
0x0002	UDP/IP	RFC 3095, RFC 4815
0x0003	ESP/IP	RFC 3095, RFC 4815
0x0004	IP	RFC 3843, RFC 4815
0x0006	TCP/IP	RFC 4996
0x0101	RTP/UDP/IP	RFC 5225
0x0102	UDP/IP	RFC 5225
0x0103	ESP/IP	RFC 5225
0x0104	IP	RFC 5225

[TS 36.323, clause 5.5.2]

PDCP entities associated with DRBs can be configured by upper layers [3] to use header compression.

[TS 36.306, clause 4.3.1.1]

This field defines which ROHC profiles from the list below are supported by the UE.

- 0x0000 ROHC uncompressed (RFC 4995)
- 0x0001 ROHC RTP (RFC 3095, RFC 4815)
- 0x0002 ROHC UDP (RFC 3095, RFC 4815)

...

'IMS capable UEs supporting voice' shall support ROHC profiles 0x0000, 0x0001, 0x0002 and be able to compress and decompress headers of PDCP SDUs at a PDCP SDU rate corresponding to supported IMS voice codecs.

8.2.1.8.3 Test description

8.2.1.8.3.1 Pre-test conditions

System Simulator:

- Cell 1

UE:

None.

Preamble:

- The UE is in state Generic RB Established (state 3) according to [18].

8.2.1.8.3.2 Test procedure sequence

Table 8.2.1.8.3.2-1: Main behaviour

St	Procedure	Message Sequence		TP	Verdict
		U - S	Message		
1	The SS transmits an <i>RRCCONNECTIONRECONFIGURATION</i> message to establish a data radio bearer.	<--	<i>RRCCONNECTIONRECONFIGURATION</i>	-	-
2	Check: Does the UE transmit an <i>RRCCONNECTIONRECONFIGURATIONCOMPLETE</i> message?	-->	<i>RRCCONNECTIONRECONFIGURATIONCOMPLETE</i>	1	P
3	The UE transmits an <i>ULINFORMATIONTRANSFER</i> message. This message includes an ACTIVATE DEDICATED EPS BEARER CONTEXT ACCEPT message.	-->	<i>ULINFORMATIONTRANSFER</i>	-	-
4	Check: Does the test result of generic test procedure in TS 36.508 subclause 6.4.2.3 indicate that the UE is in E-UTRA RRC_CONNECTED state?	-	-	1	-

8.2.1.8.3.3 Specific message contents

Table 8.2.1.8.3.3-1: *RRCCONNECTIONRECONFIGURATION* (step 1, Table 8.2.1.8.3.2-1)

Derivation Path: TS 36.508 Table 4.6.1-8, condition DRB(0, 1)			
Information Element	Value/remark	Comment	Condition
<i>RRCCONNECTIONRECONFIGURATION</i> ::= SEQUENCE {			
criticalExtensions CHOICE {			
c1 CHOICE{			
rrcConnectionReconfiguration-r8 SEQUENCE {			
dedicatedInfoNASList SEQUENCE	1 entry		

(SIZE(1..maxDRB)) OF DedicatedInfoNAS[1]	ACTIVATE DEDICATED EPS BEARER CONTEXT REQUEST with EPS bearer identity corresponding to drb- Identity 2	According 36.508 table 4.7.3-3	
}			
}			
}			
}			

Table 8.2.1.8.3.3-2: PDCP-Config (Table 8.2.1.8.3.3-1)

Derivation Path: TS 36.508 Table 4.8.2.1.2.1-1			
Information Element	Value/remark	Comment	Condition
PDCP-Config-DRB-UM ::= SEQUENCE {			
rlc-UM SEQUENCE {			
pdcpc-SN-Size	len7bits		
}			
headerCompression CHOICE {			
rohc SEQUENCE {			
maxCID	15	DEFAULT 15	
profiles SEQUENCE {		IMS capable UEs supporting voice shall support ROHC profiles 0x0000, 0x0001, 0x0002.	
profile0x0001	TRUE		
profile0x0002	TRUE		
profile0x0003	FALSE		
profile0x0004	FALSE		
profile0x0006	FALSE		
profile0x0101	FALSE		
profile0x0102	FALSE		
profile0x0103	FALSE		
profile0x0104	FALSE		
}			
}			
}			
}			

Table 8.2.1.8.3.3-3: RLC-Config (Table 8.2.1.8.3.3-1)

Derivation Path: TS 36.508 Table 4.8.2.1.3.1-1			
Information Element	Value/remark	Comment	Condition
RLC-Config-DRB-UM ::= CHOICE {			
um-Bi-Directional SEQUENCE {			
ul-UM-RLC SEQUENCE {			
sn-FieldLength	size5		
}			
dl-UM-RLC SEQUENCE {			
sn-FieldLength	size5		
}			
}			
}			

8.2.2 Radio resource reconfiguration

8.2.2.1 RRC connection reconfiguration / Radio resource reconfiguration / Success

8.2.2.1.1 Test Purpose (TP)

(1)

```
with { UE in E-UTRA RRC_CONNECTED state }
ensure that {
  when { UE receives an RRCCConnectionReconfiguration message including a
radioResourceConfigDedicated with SRB, DRB, transport channel and physical channel reconfiguration }
  then { UE reconfigures the data and signalling radio bearers and sends an
RRCCConnectionReconfigurationComplete message }
}
```

8.2.2.1.2 Conformance requirements

References: The conformance requirements covered in the present TC are specified in: TS 36.331 clause 5.3.5.3, 5.3.10.1, 5.3.10.3, 5.3.10.4 and 5.3.10.6.

The following represent an extraction of the requirements relevant to the test purpose.

[TS 36.331, clause 5.3.5.3]

If the *RRCCConnectionReconfiguration* message does not include the *mobilityControlInfo* and the UE is able to comply with the configuration included in this message, the UE shall:

- 1> if this is the first *RRCCConnectionReconfiguration* message after successful completion of the RRC Connection Re-establishment procedure:

...

1> else:

- 2> If the *RRCCConnectionReconfiguration* message includes the *radioResourceConfigDedicated*:
- 3> perform the radio resource configuration procedure as specified in 5.3.10;

...

- 1> submit the *RRCCConnectionReconfigurationComplete* message to lower layers for transmission using the new configuration, upon which the procedure ends;

[TS 36.331, clause 5.3.10.1]

The UE shall:

...

- 1> for each *srb-Identity* value included in the *srb-ToAddModList* that is part of the current UE configuration (SRB reconfiguration):
 - 2> reconfigure the RLC entity in accordance with the received *rlc-Config*;
 - 2> reconfigure the DCCH logical channel in accordance with the received *logicalChannelConfig*;

[TS 36.331, clause 5.3.10.3]

...

- 1> for each *drb-Identity* value included in the *drb-ToAddModList* that is part of the current UE configuration (DRB reconfiguration):
 - 2> if the *pdcp-Config* is included:
 - 3> reconfigure the PDCP entity in accordance with the received *pdcp-Config*;
 - 2> if the *rlc-Config* is included:

3> reconfigure the RLC entity or entities in accordance with the received *rlc-Config*;

2> if the *logicalChannelConfig* is included:

3> reconfigure the DTCH logical channel in accordance with the received *logicalChannelConfig*;

NOTE: Removal and addition of the same *drb-Identity* in single *radioResourceConfiguration* is not supported.

[TS 36.331, clause 5.3.10.4]

1> reconfigure the MAC main configuration in accordance with the received *mac-MainConfig*;

[TS 36.331, clause 5.3.10.6]

The UE shall:

1> reconfigure the physical channel configuration in accordance with the received *physicalConfigDedicated*;

8.2.2.1.3 Test description

8.2.2.1.3.1 Pre-test conditions

System Simulator:

- Cell 1

UE:

None.

Preamble:

- The UE is in state Generic RB Established (state 3) according to [18].
- The condition SRB2-DRB(2, 0) is used for step 8 in 4.5.3.3 according to [18].

8.2.2.1.3.2 Test procedure sequence

Table 8.2.2.1.3.2-1: Main behaviour

St	Procedure	Message Sequence		TP	Verdict
		U - S	Message		
1	The SS transmits an <i>RRCCONNECTIONRECONFIGURATION</i> message containing a <i>RADIORESOURCECONFIGDEDICATED</i> with SRBs, DRB, transport channel and physical channel reconfiguration.	<--	<i>RRCCONNECTIONRECONFIGURATION</i>	-	-
2	Check: Does the UE transmit an <i>RRCCONNECTIONRECONFIGURATIONCOMPLETE</i> message?	-->	<i>RRCCONNECTIONRECONFIGURATIONCOMPLETE</i>	1	P
3	Check: Does the test result of generic test procedure in TS 36.508 subclause 6.4.2.3 indicate that the UE is in E-UTRA RRC_CONNECTED state on Cell 1?	-	-	1	-

8.2.2.1.3.3 Specific message contents

Table 8.2.2.1.3.3-1: RRCConnectionReconfiguration (step 1, Table 8.2.2.1.3.2-1)

Derivation Path: 36.508 table 4.6.1-8			
Information Element	Value/remark	Comment	Condition
RRCConnectionReconfiguration ::= SEQUENCE {			
criticalExtensions CHOICE {			
c1 CHOICE{			
rrcConnectionReconfiguration-r8 SEQUENCE {			
radioResourceConfigDedicated	RadioResourceConfigDe dicated-RECONFIG		
}			
}			
}			
}			

Table 8.2.2.1.3.3-2: RadioResourceConfigDedicated-RECONFIG (Table 8.2.2.1.3.3-1)

Derivation Path: 36.331 clause 6.3.2			
Information Element	Value/remark	Comment	Condition
RadioResourceConfigDedicated ::= SEQUENCE {			
srb-ToAddModList	SRB-ToAddModList- RECONFIG	TS 36.508 Table 4.6.3-22A	
drb-ToAddModList	DRB-ToAddModList- RECONFIG	TS 36.508 Table 4.6.3-2A	
drb-ToReleaseList	Not present		
mac-MainConfig CHOICE {			
explicitValue	MAC-MainConfig- RECONFIG		
}			
sps-Config	Not present		
physicalConfigDedicated	PhysicalConfigDedicated -RECONFIG		
}			

Table 8.2.2.1.3.3-3: MAC-MainConfig-RECONFIG (Table 8.2.2.1.3.3-2)

Derivation Path: 36.508 table 4.8.2.1.5-1			
Information Element	Value/remark	Comment	Condition
MAC-MainConfig ::= SEQUENCE {			
ul-SCH-Config SEQUENCE {			
periodicBSR-Timer	sf32		
retxB SR-Timer	sf2560		
}			
phr-Config CHOICE {			
setup SEQUENCE {			
periodicPHR-Timer	sf1000		
prohibitPHR-Timer	sf500		
}			
}			
}			

Table 8.2.2.1.3.3-4: PhysicalConfigDedicated-RECONFIG (Table 8.2.2.1.3.3-2)

Derivation Path: 36.331 clause 6.3.2			
Information Element	Value/remark	Comment	Condition
PhysicalConfigDedicated ::= SEQUENCE {			
pdsch-ConfigDedicated	PDSCH-ConfigDedicated-RECONFIG		
pucch-ConfigDedicated	Not present		
pusch-ConfigDedicated	Not present		
uplinkPowerControlDedicated	Not present		
tpc-PDCCH-ConfigPUCCH	Not present		
tpc-PDCCH-ConfigPUSCH	Not present		
cqi-ReportConfig	Not present		
soundingRsUL-ConfigDedicated	Not present		
antennaInfo CHOICE {			
defaultValue	NULL		
}			
schedulingRequestConfig	Not present		
}			

Table 8.2.2.1.3.3-5: PDSCH-ConfigDedicated-RECONFIG (Table 8.2.2.1.3.3-4)

Derivation Path: 36.508 table 4.6.3-6			
Information Element	Value/remark	Comment	Condition
PDSCH-ConfigDedicated ::= SEQUENCE {			
p-a	dB1		
}			

8.2.2.2 RRC connection reconfiguration / SRB/DRB reconfiguration / Success

8.2.2.2.1 Test Purpose (TP)

(1)

```
with { UE in E-UTRA RRC_CONNECTED state }
ensure that {
  when { UE receives an RRCConnectionReconfiguration message containing SRB reconfiguration }
  then { UE reconfigures affected SRBs and sends an RRCConnectionReconfigurationComplete message }
}
```

(2)

```
with { UE in E-UTRA RRC_CONNECTED state }
ensure that {
  when { UE receives an RRCConnectionReconfiguration message containing DRB reconfiguration }
  then { UE reconfigures affected DRBs and sends an RRCConnectionReconfigurationComplete message }
}
```

8.2.2.2.2 Conformance requirements

References: The conformance requirements covered in the current TC is specified in: TS 36.331, clauses 5.3.5.3, 5.3.10.1 and 5.3.10.3.

[TS 36.331, clause 5.3.5.3]

If the *RRCConnectionReconfiguration* message does not include the *mobilityControlInfo* and the UE is able to comply with the configuration included in this message, the UE shall:

...

1> else:

2> if the *RRCConnectionReconfiguration* message includes the *radioResourceConfigDedicated*:

3>perform the Radio resource configuration procedure as specified in 5.3.10;

[TS 36.331, clause 5.3.10.1]

The UE shall:

...

- 1> for each *srb-Identity* value included in the *srb-ToAddModList* that is part of the current UE configuration (SRB reconfiguration):
 - 2> reconfigure the RLC entity in accordance with the received *rlc-Config*;
 - 2> reconfigure the DCCH logical channel in accordance with the received *logicalChannelConfig*;

[TS 36.331, clause 5.3.10.3]

The UE shall:

...

- 1> for each *drb-Identity* value included in the *drb-ToAddModList* that is part of the current UE configuration (DRB reconfiguration):
 - 2> if the *pdcp-Config* is included:
 - 3> reconfigure the PDCP entity in accordance with the received *pdcp-Config*;
 - 2> if the *rlc-Config* is included:
 - 3> reconfigure the RLC entity or entities in accordance with the received *rlc-Config*;
 - 2> if the *logicalChannelConfig* is included:
 - 3> reconfigure the DTCH logical channel in accordance with the received *logicalChannelConfig*;

NOTE: Removal and addition of the same *drb-Identity* in single *radioResourceConfiguration* is not supported.

8.2.2.2.3 Test Description

8.2.2.2.3.1 Pre-test conditions

System Simulator:

- Cell 1

UE:

None.

Preamble:

- The UE is in state Generic RB Established (state 3) according to [18].
- The condition SRB2-DRB(2, 0) is used for step 8 in 4.5.3.3 according to [8].

8.2.2.2.3.2 Test procedure sequence

Table 8.2.2.2.3.2-1: Main behaviour

St	Procedure	Message Sequence		TP	Verdict
		U - S	Message		
1	The SS transmits an <i>RRConnectionReconfiguration</i> message containing a <i>radioResourceConfigDedicated</i> with SRB reconfiguration.	<--	<i>RRConnectionReconfiguration</i>	-	-
2	Check: Does the UE transmit an <i>RRConnectionReconfigurationComplete</i> message?	-->	<i>RRConnectionReconfigurationComplete</i>	1	P
3	SS transmits <i>RRConnectionReconfiguration</i> message containing a <i>radioResourceConfigDedicated</i> with DRB reconfiguration.	<--	<i>RRConnectionReconfiguration</i>	-	-
4	Check: Does the UE transmit an <i>RRConnectionReconfigurationComplete</i> message?	-->	<i>RRConnectionReconfigurationComplete</i>	2	P

8.2.2.2.3.3 Specific message contents

Table 8.2.2.2.3.3-1: *RRConnectionReconfiguration* (step 1, Table 8.2.2.2.3.2-1)

Derivation Path: 36.508 table 4.6.1-8			
Information Element	Value/remark	Comment	Condition
<i>RRConnectionReconfiguration</i> ::= SEQUENCE {			
criticalExtensions CHOICE {			
c1 CHOICE{			
rrcConnectionReconfiguration-r8 SEQUENCE {			
radioResourceConfigDedicated	RadioResourceConfigDedicated-SRBRECONFIG		
}			
}			
}			
}			

Table 8.2.2.2.3.3-2: *RadioResourceConfigDedicated-SRBRECONFIG* (Table 8.2.2.2.3.3-1)

Derivation Path: 36.331 clause 6.3.2			
Information Element	Value/remark	Comment	Condition
<i>RadioResourceConfigDedicated</i> ::= SEQUENCE {			
srb-ToAddModList	SRB-ToAddModList-RECONFIG	TS 36.508 Table 4.6.3-22A	
drb-ToAddModList	Not present		
drb-ToReleaseList	Not present		
mac-MainConfig	Not present		
sps-Config	Not present		
physicalConfigDedicated	Not present		
}			

Table 8.2.2.3.3-3: RRCConnectionReconfiguration (step 3, Table 8.2.2.3.2-1)

Derivation Path: 36.508 table 4.6.1-8			
Information Element	Value/remark	Comment	Condition
RRCConnectionReconfiguration ::= SEQUENCE {			
criticalExtensions CHOICE {			
c1 CHOICE{			
rrcConnectionReconfiguration-r8 SEQUENCE {			
radioResourceConfigDedicated	RadioResourceConfigDe dicated-DRBRECONFIG		
}			
}			
}			
}			

Table 8.2.2.3.3-4: RadioResourceConfigDedicated-DRBRECONFIG (Table 8.2.2.3.3-3)

Derivation Path: 36.331 clause 6.3.2			
Information Element	Value/remark	Comment	Condition
RadioResourceConfigDedicated ::= SEQUENCE {			
srb-ToAddModList	Not present		
drb-ToAddModList	DRB-ToAddModList- RECONFIG	TS 36.508 Table 4.6.3-2A	
drb-ToReleaseList	Not present		
mac-MainConfig	Not present		
sps-Config	Not present		
physicalConfigDedicated	Not present		
}			

Table 8.2.2.3.3-5: Void**Table 8.2.2.3.3-6: Void**

8.2.2.3 CA / RRC connection reconfiguration / SCell addition/modification/release / Success

8.2.2.3.1 CA / RRC connection reconfiguration / SCell addition/modification/release / Success / Intra-band Contiguous CA

8.2.2.3.1 Test Purpose (TP)

(1)

```
with { UE in E-UTRA RRC_CONNECTED state }
ensure that {
  when { UE receives an RRCConnectionReconfiguration message containing sCellToAddModList with a
  SCell addition }
  then { UE adds the new SCell, configures lower layers to consider the SCell to be in deactivated
  state and sends an RRCConnectionReconfigurationComplete message }
}
```

(2)

```
with { UE in E-UTRA RRC_CONNECTED state }
ensure that {
  when { UE receives an RRCConnectionReconfiguration message containing sCellToAddModList with SCell
  modification }
  then { UE modifies the affected SCell dedicated configurations and sends an
  RRCConnectionReconfigurationComplete message }
}
```

(3)

```
with { UE in E-UTRA RRC_CONNECTED state }
ensure that {
```

```

when { UE receives an RRCCONNECTIONRECONFIGURATION message containing sCellToReleaseList with a
sCellIndex equaling to one of the current UE SCell configuration }
  then { UE releases this SCell and sends an RRCCONNECTIONRECONFIGURATIONCOMPLETE message }
    }

```

8.2.2.3.1.2 Conformance requirements

References: The conformance requirements covered in the current TC is specified in: TS 36.331, clauses 5.3.5.3, 5.3.10.3a and 5.3.10.3b

[TS 36.331, clause 5.3.5.3]

If the *RRCCONNECTIONRECONFIGURATION* message does not include the *mobilityControlInfo* and the UE is able to comply with the configuration included in this message, the UE shall:

...

1> if the received *RRCCONNECTIONRECONFIGURATION* includes the *sCellToReleaseList*:

2> perform SCell release as specified in 5.3.10.3a;

1> if the received *RRCCONNECTIONRECONFIGURATION* includes the *sCellToAddModList*:

2> perform SCell addition or modification as specified in 5.3.10.3b;

...

1> submit the *RRCCONNECTIONRECONFIGURATIONCOMPLETE* message to lower layers for transmission using the new configuration, upon which the procedure ends;

[TS 36.331, clause 5.3.10.3a]

The UE shall:

1> if the release is triggered by reception of the *sCellToReleaseList*:

2> for each *sCellIndex* value included in the *sCellToReleaseList*:

3> if the current UE configuration includes an SCell with value *sCellIndex*:

4> release the SCell;

1> if the release is triggered by RRC connection re-establishment:

2> release all SCells that are part of the current UE configuration;

[TS 36.331, clause 5.3.10.3b]

The UE shall:

1> for each *sCellIndex* value included in the *sCellToAddModList* that is not part of the current UE configuration (SCell addition):

2> add the SCell, corresponding to the *cellIdentification*, in accordance with the received *radioResourceConfigCommonSCell* and *radioResourceConfigDedicatedSCell*;

2> configure lower layers to consider the SCell to be in deactivated state;

1> for each *sCellIndex* value included in the *sCellToAddModList* that is part of the current UE configuration (SCell modification):

2> modify the SCell configuration in accordance with the received *radioResourceConfigDedicatedSCell*;

8.2.2.3.1.3 Test Description

8.2.2.3.1.3.1 Pre-test conditions

System Simulator:

- Cell 1 is the PCell, Cell3 is the SCell to be added.
- Cell 3 is an Inactive SCell according to [18] cl. 6.3.4.
- System information combination 3 as defined in TS 36.508 [18] clause 4.4.3.1 is used in E-UTRA cells.

UE:

None.

Preamble:

- The UE is in state Generic RB Established (state 3) on Cell 1 according to [18].

8.2.2.3.1.3.2 Test procedure sequence

Table 8.2.2.3.1.3.2-1 illustrates the downlink power levels and other changing parameters to be applied for the cells at various time instants of the test execution. Row marked "T0" denotes the initial conditions after preamble, while the configuration marked "T1" and "T2" are applied at the point indicated in the Main behaviour description in Table 8.2.2.3.1.3.2-2.

Table 8.2.2.3.1.3.2-1: Time instances of cell power level and parameter changes

	Parameter	Unit	Cell 1	Cell 3	Remark
T0	Cell-specific RS EPRE	dBm/15k Hz	-79	Off	The power level values are such that camping on Cell 1 is guarantee.
T1	Cell-specific RS EPRE	dBm/15k Hz	-79	-85	The power level values are such that measurement results for Cell 1 (M1) and Cell 3 (M3) satisfy entry condition for event A3 ($M3 > M1$).
T2	Cell-specific RS EPRE	dBm/15k Hz	-79	-97	The power level values are such that measurement results for Cell 1 (M1) and Cell 3 (M3) satisfy the leave condition for event A3 ($M3 < M1$).

Table 8.2.2.3.1.3.2-2: Main behaviour

St	Procedure	Message Sequence		TP	Verdict
		U - S	Message		
1	The SS transmits an <i>RRCCONNECTIONRECONFIGURATION</i> message on Cell 1 to setup inter Frequency measurement.	<--	<i>RRCCONNECTIONRECONFIGURATION</i>	-	-
2	The UE transmits an <i>RRCCONNECTIONRECONFIGURATIONCOMPLETE</i> message on Cell 1.	-->	<i>RRCCONNECTIONRECONFIGURATIONCOMPLETE</i>	-	-
3	The SS changes Cell 3 parameters according to the row "T1" in table 8.2.2.3.1.3.2-1.	-	-	-	-
4	The UE transmits a <i>MEASUREMENTREPORT</i> message on Cell 1 to report event A3 with the measured RSRP, RSRQ value for Cell 3.	-->	<i>MEASUREMENTREPORT</i>	-	-
5	The SS transmits an <i>RRCCONNECTIONRECONFIGURATION</i> message containing an <i>sCELLTOADDMODLIST</i> with SCell Cell 3 addition.	<--	<i>RRCCONNECTIONRECONFIGURATION</i>	-	-
6	Check: Does the UE transmit an <i>RRCCONNECTIONRECONFIGURATIONCOMPLETE</i> message?	-->	<i>RRCCONNECTIONRECONFIGURATIONCOMPLETE</i>	1	P
7	The SS transmits an <i>RRCCONNECTIONRECONFIGURATION</i> message containing an <i>sCELLTOADDMODLIST</i> with SCell Cell 3 modification and including <i>measConfig</i> to release measurement gap.	<--	<i>RRCCONNECTIONRECONFIGURATION</i>	-	-
8	Check: Does the UE transmit an <i>RRCCONNECTIONRECONFIGURATIONCOMPLETE</i> message?	-->	<i>RRCCONNECTIONRECONFIGURATIONCOMPLETE</i>	2	P
9	The SS changes Cell 3 parameters according to the row "T2" in table 8.2.2.3.1.3.2-1.	-	-	-	-
10	The UE transmits a <i>MEASUREMENTREPORT</i> message on Cell 1 to report event A3 with the measured RSRP, RSRQ value for Cell 3.	-->	<i>MEASUREMENTREPORT</i>	-	-
11	The SS transmits an <i>RRCCONNECTIONRECONFIGURATION</i> message containing an <i>sCELLTORELEASELIST</i> with an <i>sCELLINDEX</i> equalling to the Cell 3 cell index in the current UE configuration.	<--	<i>RRCCONNECTIONRECONFIGURATION</i>	-	-
12	Check: Does the UE transmit an <i>RRCCONNECTIONRECONFIGURATIONCOMPLETE</i> message?	-->	<i>RRCCONNECTIONRECONFIGURATIONCOMPLETE</i>	3	P
13	Check: Does the test result of generic test procedure in TS 36.508 subclause 6.4.2.3 indicate that the UE is in E-UTRA RRC_CONNECTED state on Cell 1?	-	-	1	-

8.2.2.3.1.3.3 Specific message contents

Table 8.2.2.3.1.3.3-0: Conditions for specific message contents in Tables 8.2.2.3.1.3.3-7, 8.2.2.3.1.3.3-8 and 8.2.2.3.1.3.3-11

Condition	Explanation
Uplink_CA	The UE supports carrier aggregation in UL under the test band.

Table 8.2.2.3.1.3.3-1: *RRCCONNECTIONRECONFIGURATION* (step 1, Table 8.2.2.3.1.3.2-2)

Derivation Path: 36.508 clause 4.6.1 table 4.6.1-8 with condition MEAS
--

Table 8.2.2.3.1.3.3-2: *MeasConfig* (Table 8.2.2.3.1.3.3-1)

Derivation path: 36.508 clause 4.6.6 table 4.6.6-1, condition INTER-FREQ			
Information Element	Value/Remark	Comment	Condition
MeasConfig ::= SEQUENCE {			
measObjectToAddModList SEQUENCE (SIZE (1..maxObjectId)) OF SEQUENCE {	2 entries		
measObjectId[1]	IdMeasObject-f1		
measObject[1]	MeasObjectEUTRA-GENERIC(f1)	Cell 1	
measObjectId[2]	IdMeasObject-f2		
measObject[2]	MeasObjectEUTRA-GENERIC(f2)	Cell 3	
}			
reportConfigToAddModList SEQUENCE (SIZE (1..maxReportConfigId)) OF SEQUENCE {	1 entry		
reportConfigId[1]	IdReportConfig-A3		
reportConfig[1]	ReportConfig-A3		
}			
measIdToAddModList SEQUENCE (SIZE (1..maxMeasId)) OF SEQUENCE {	1 entry		
measId[1]	1		
measObjectId[1]	IdMeasObject-f2		
reportConfigId[1]	IdReportConfig-A3		
}			
}			

Table 8.2.2.3.1.3.3-3: *ReportConfig-A3* (step 1, Table 8.2.2.3.1.3.2-2)

Derivation Path: 36.508 clause 4.6.6 table 4.6.6-6			
Information Element	Value/remark	Comment	Condition
ReportConfigEUTRA-A3 ::= SEQUENCE {			
triggerType CHOICE {			
event SEQUENCE {			
eventId CHOICE {			
eventA SEQUENCE {			
a3-Offset	-24 (-12 dB)		
reportOnLeave	TRUE		
}			
}			
}			
}			
}			

Table 8.2.2.3.1.3.3-4: MeasurementReport (step 4, Table 8.2.2.3.1.3.2-2)

Derivation Path: 36.508 clause 4.6.1 table 4.6.1-5			
Information Element	Value/remark	Comment	Condition
MeasurementReport ::= SEQUENCE {			
criticalExtensions CHOICE {			
c1 CHOICE {			
measurementReport-r8 SEQUENCE {			
measResults ::= SEQUENCE {			
measId	1		
measResultPCell ::= SEQUENCE {		Report Cell 1	
rsrpResult	(0..97)		
rsrqResult	(0..34)		
}			
measResultNeighCells CHOICE {			
measResultListEUTRA ::= SEQUENCE (SIZE (1..maxCellReport)) OF SEQUENCE {		Report Cell 3	
physCellId [1]	physicalCellId of Cell 3		
cgi-Info [1] SEQUENCE {}	Not present		
measResult [1] SEQUENCE {			
rsrpResult	(0..97)		
rsrqResult	(0..34)		
additionalSI-Info-r9 SEQUENCE {}	Not present		
}			
}			
}			
measResultForECID-r9 SEQUENCE {}	Not present		
locationInfo-r10 SEQUENCE {}	Not present		
measResultServFreqList-r10 SEQUENCE {}	Not present		
}			
}			
}			
}			

Table 8.2.2.3.1.3.3-5: RRCConnectionReconfiguration (step 5, Table 8.2.2.3.1.3.2-2)

Derivation Path: 36.508 clause 4.6.1 table 4.6.1-8			
Information Element	Value/remark	Comment	Condition
RRCConnectionReconfiguration ::= SEQUENCE {			
criticalExtensions CHOICE {			
c1 CHOICE{			
rrcConnectionReconfiguration-r8 SEQUENCE {			
nonCriticalExtension SEQUENCE {			
nonCriticalExtension SEQUENCE {			
nonCriticalExtension SEQUENCE {			
sCellToReleaseList-r10	Not present		
sCellToAddModList-r10	SCellToAddMod-r10-f2-Add	SCell addition for Cell 3	
nonCriticalExtension SEQUENCE {}	Not present		
}			
}			
}			
}			
}			
}			
}			

Table 8.2.2.3.1.3.3-6: SCellToAddMod-r10-f2-Add (Table 8.2.2.3.1.3.3-5)

Derivation Path: 36.508 clause 4.6.1 table 4.6.3-19D SCellToAddMod-r10-DEFAULT			
Information Element	Value/remark	Comment	Condition
SCellToAddMod-r10 ::= SEQUENCE (SIZE (1..maxSCell-r10)) OF SEQUENCE {	1 entry		
sCellIndex-r10	1		
cellIdentification-r10 SEQUENCE {			
physCellId-r10	Physical Cell Identity of Cell 3		
dl-CarrierFreq-r10	Same downlink EARFCN as used for Cell 3		
}			
radioResourceConfigCommonSCell-r10	RadioResourceConfigCommonSCell-r10-f2		
radioResourceConfigDedicatedSCell-r10	RadioResourceConfigDedicatedSCell-r10-f2		
}			

Table 8.2.2.3.1.3.3-7: RadioResourceConfigCommonSCell-r10-f2 (Table 8.2.2.3.1.3.3-6)

Derivation Path: 36.508 clause 4.6.3 table 4.6.3-13A			
Information Element	Value/remark	Comment	Condition
RadioResourceConfigCommonSCell-r10 ::= SEQUENCE {			
nonUL-Configuration-r10 SEQUENCE {			
dl-Bandwidth-r10	Same downlink system bandwidth as used for Cell 3		
}			
UI-Configuration-r10	Not present		
ul-Configuration-r10 SEQUENCE {			Uplink_CA
ul-FreqInfo-r10 SEQUENCE {			
ul-CarrierFreq-r10	Same uplink EARFCN as used for Cell 3	OP	FDD
	Not present		TDD
ul-Bandwidth-r10	Same uplink system bandwidth as used for Cell 3	optional	FDD
	Not present		TDD
additionalSpectrumEmissionSCell-r10	Same additionalSpectrumEmission as used for Cell 3		
}			
}			
}			

Table 8.2.2.3.1.3.3-8: RadioResourceConfigDedicatedSCell-r10-f2 (Table 8.2.2.3.1.3.3-6)

Derivation Path: 36.508 clause 4.6.3 table 4.6.3-19AA			
Information Element	Value/remark	Comment	Condition
RadioResourceConfigDedicatedSCell-r10 ::= SEQUENCE {			
physicalConfigDedicatedSCell-r10 SEQUENCE {			
ul-Configuration-r10	Not present		
ul-Configuration-r10 SEQUENCE {			Uplink_CA
antennaInfoUL-r10	Not present		
pusch-ConfigDedicatedSCell-r10	Not present		
uplinkPowerControlDedicatedSCell-r10	UplinkPowerControlDedicatedSCell-r10-DEFAULT		
cqi-ReportConfigSCell-r10	CQI-ReportConfigSCell-r10-DEFAULT		
soundingRS-UL-ConfigDedicated-r10	Not present		
soundingRS-UL-ConfigDedicated-v1020	Not present		
soundingRS-UL-ConfigDedicatedAperiodic-r10	Not present		
}			
}			
}			

Table 8.2.2.3.1.3.3-9: RRCConnectionReconfiguration (step 7, Table 8.2.2.3.1.3.2-2)

Derivation Path: 36.508 clause 4.6.1 table 4.6.1-8			
Information Element	Value/remark	Comment	Condition
RRCConnectionReconfiguration ::= SEQUENCE {			
criticalExtensions CHOICE {			
c1 CHOICE {			
rrcConnectionReconfiguration-r8 SEQUENCE {			
measConfig SEQUENCE {			
measGapConfig CHOICE {			
release	NULL		
}			
}			
nonCriticalExtension SEQUENCE {			
nonCriticalExtension SEQUENCE {			
nonCriticalExtension SEQUENCE {			
sCellToReleaseList-r10	Not present		
sCellToAddModList-r10	SCellToAddMod-r10-f2-Mod	SCell modification for Cell 3	
nonCriticalExtension SEQUENCE {}	Not present		
}			
}			
}			
}			

Table 8.2.2.3.1.3.3-10: SCellToAddMod-r10-f2-Mod (Table 8.2.2.3.1.3.3-9)

Derivation Path: 36.508 clause 4.6.1 table 4.6.3-19D SCellToAddMod-r10-DEFAULT			
Information Element	Value/remark	Comment	Condition
SCellToAddMod-r10 ::= SEQUENCE (SIZE (1..maxSCell-r10)) OF SEQUENCE {	1 entry		
sCellIndex-r10	1		
cellIdentification-r10 SEQUENCE {			
physCellId-r10	Physical Cell Identity of Cell 3		
dl-CarrierFreq-r10	Same downlink EARFCN as used for Cell 3		
}			
radioResourceConfigCommonSCell-r10	Not present		
radioResourceConfigDedicatedSCell-r10	RadioResourceConfigDedicatedSCell-r10-f2-Mod		pc_FeatGrp_102
}			

Table 8.2.2.3.1.3.3-11: RadioResourceConfigDedicatedSCell-r10-f2-Mod (Table 8.2.2.3.1.3.3-10)

Derivation Path: 36.508 clause 4.6.3 table 4.6.3-19AA			
Information Element	Value/remark	Comment	Condition
RadioResourceConfigDedicatedSCell-r10 ::= SEQUENCE {			
physicalConfigDedicatedSCell-r10 SEQUENCE {			
nonUL-Configuration-r10 SEQUENCE {			
antennaInfo-r10 SEQUENCE {			
antennaPortsCount	an2		
}			
crossCarrierSchedulingConfig-r10	Not present		
csi-RS-Config-r10	Not present		
pdsch-ConfigDedicated-r10	Not present		
}			
ul-Configuration-r10	Not present		
ul-Configuration-r10 SEQUENCE {			Uplink_CA
antennaInfoUL-r10 SEQUENCE {			
transmissionModeUL-r10	tm1		
fourAntennaPortActivated-r10	Not present	OP setup	
}			
pusch-ConfigDedicatedSCell-r10	PUSCH-ConfigDedicated-DEFAULT		
uplinkPowerControlDedicatedSCell-r10	Not present		
cqi-ReportConfigSCell-r10	Not present		
soundingRS-UL-ConfigDedicated-r10	Not present		
}	SoundingRS-UL-ConfigDedicated-Mod		pc_FeatGrp_113
soundingRS-UL-ConfigDedicated-v1020	Not present		
}	SoundingRS-UL-ConfigDedicated-v1020-Mod		pc_FeatGrp_113
soundingRS-UL-ConfigDedicatedAperiodic-r10	Not present		
}			
}			
}			

Table 8.2.2.3.1.3.3-11A: SoundingRS-UL-ConfigDedicated-Mod (Table 8.2.2.3.1.3.3-11)

Derivation Path: 36.508, Table 4.6.3-22			
Information Element	Value/remark	Comment	Condition
SoundingRS-UL-ConfigDedicated ::= CHOICE {			
setup SEQUENCE {			
srs-Bandwidth	bw3		
srs-HoppingBandwidth	hbw3		
freqDomainPosition	0		
duration	TRUE		
srs-ConfigIndex	7		
transmissionComb	0		
cyclicShift	cs0		
}			
}			

Table 8.2.2.3.1.3.3-11B: SoundingRS-UL-ConfigDedicated-v1020-Mod (Table 8.2.2.3.1.3.3-11)

Derivation Path: 36.331, clause 6.3.2			
Information Element	Value/remark	Comment	Condition
SoundingRS-UL-ConfigDedicated-v1020 ::= SEQUENCE {			
srs-AntennaPort-r10	an1		
}			

Table 8.2.2.3.1.3.3-12: MeasurementReport (step 10, Table 8.2.2.3.1.3.2-2)

Derivation path: 36.508 4.6.1 table 4.6.1-5			
Information Element	Value/Remark	Comment	Condition
MeasurementReport ::= SEQUENCE {			
criticalExtensions CHOICE {			
c1 CHOICE {			
measurementReport-r8 SEQUENCE {			
measResults ::= SEQUENCE {			
measId	1		
measResultPCell ::= SEQUENCE {		Report Cell 1	
rsrpResult	(0..97)		
rsrqResult	(0..34)		
}			
measResultForECID-r9	Not present		
locationInfo-r10	Not present		
measResultServFreqList-r10 SEQUENCE (SIZE (1..maxServCell-r10)) OF SEQUENCE {			
servFreqId-r10	1		
measResultSCell-r10 SEQUENCE {		Cell 3	
rsrpResultSCell-r10	(0..97)		
rsrqResultSCell-r10	(0..34)		
}			
}			
}			
}			
}			

Table 8.2.2.3.1.3.3-13: RRCConnectionReconfiguration (step 11, Table 8.2.2.3.1.3.2-2)

Derivation Path: 36.508 clause 4.6.1 table 4.6.1-8			
Information Element	Value/remark	Comment	Condition
RRCConnectionReconfiguration ::= SEQUENCE {			
criticalExtensions CHOICE {			
c1 CHOICE {			
rrcConnectionReconfiguration-r8 SEQUENCE {			
nonCriticalExtension SEQUENCE {			
nonCriticalExtension SEQUENCE {			
nonCriticalExtension SEQUENCE {			
sCellToReleaseList-r10 SEQUENCE (SIZE (1..maxSCell-r10) OF SEQUENCE {	1 entry		
sCellIndex-r10[1]	1	SCell release for Cell 3	
}			
sCellToAddModList-r10	Not present		
nonCriticalExtension SEQUENCE {}	Not present		
}			
}			
}			
}			
}			

8.2.2.3.2 CA / RRC connection reconfiguration / SCell addition/modification/release / Success / Inter-Band CA

8.2.2.3.2.1 Test Purpose (TP)

Same as TC 8.2.2.3.1 but applied to Inter-band CA case.

8.2.2.3.2.2 Conformance requirements

Same as TC 8.2.2.3.1 but applied to Inter-band CA case.

8.2.2.3.2.3 Test description

8.2.2.3.2.3.1 Pre-test conditions

Same as test case 8.2.2.3.1 with the following differences:

- CA configuration: Inter-band CA replaces Intra-band Contiguous CA
- Cells configuration: Cell 10 replaces Cell 3
- Cell 10 is an Inactive SCell according to [18] cl. 6.3.4

8.2.2.3.2.3.2 Test procedure sequence

Same as test case 8.2.2.3.1 with the following differences:

- CA configuration: Inter-band CA replaces Inter-band Contiguous CA
- Cells configuration: Cell 10 replaces Cell 3.

8.2.2.3.2.3.3 Specific message contents

Table 8.2.2.3.2.3.3-1: *MeasConfig* (Table 8.2.2.3.1.3.3-1)

Derivation path: 36.508 clause 4.6.6 table 4.6.6-1, condition INTER-FREQ			
Information Element	Value/Remark	Comment	Condition
<i>MeasConfig</i> ::= SEQUENCE {			
<i>measObjectToAddModList</i> SEQUENCE (SIZE (1.. <i>maxObjectId</i>)) OF SEQUENCE {	2 entries		
<i>measObjectId</i> [1]	IdMeasObject-f1		
<i>measObject</i> [1]	MeasObjectEUTRA-GENERIC(f1)	Cell 1	
<i>measObjectId</i> [2]	IdMeasObject-f5		
<i>measObject</i> [2]	MeasObjectEUTRA-GENERIC(f5)	Cell 10	
}			
<i>reportConfigToAddModList</i> SEQUENCE (SIZE (1.. <i>maxReportConfigId</i>)) OF SEQUENCE {	1 entry		
<i>reportConfigId</i> [1]	IdReportConfig-A3		
<i>reportConfig</i> [1]	ReportConfig-A3		
}			
<i>measIdToAddModList</i> SEQUENCE (SIZE (1.. <i>maxMeasId</i>)) OF SEQUENCE {	1 entry		
<i>measId</i> [1]	1		
<i>measObjectId</i> [1]	IdMeasObject-f5		
<i>reportConfigId</i> [1]	IdReportConfig-A3		
}			
}			

8.2.2.4 CA / RRC connection reconfiguration / SCell SI change / Success

8.2.2.4.1 CA / RRC connection reconfiguration / SCell SI change / Success / Intra-band Contiguous CA

8.2.2.4.1.1 Test Purpose (TP)

(1)

```

with { UE in E-UTRA RRC_CONNECTED state with SCell(s) configured }
ensure that {
  when { UE receives an RRCConnectionReconfiguration message including sCellToReleaseList and
sCellToAddModList with the same concerned SCell to release and add, and with the change of the
relevant system information of the configured SCell }
  then { UE first releases the concerned SCell and then adds the concerned SCell, configures lower
layers to consider the concerned SCell to be in deactivated state and sends an
RRCConnectionReconfigurationComplete message }
}

```

8.2.2.4.1.2 Conformance requirements

References: The conformance requirements covered in the current TC is specified in: TS 36.331, clauses 5.2.1.1, clauses 5.3.5.3, 5.3.10.3a and 5.3.10.3b.

[TS 36.331, clause 5.2.1.1]

The UE applies the system information acquisition and change monitoring procedures for the PCell only. For an SCell, E-UTRAN provides, via dedicated signalling, all system information relevant for operation in RRC_CONNECTED when adding the SCell. Upon change of the relevant system information of a configured SCell, E-UTRAN releases and subsequently adds the concerned SCell, which may be done with a single *RRCConnectionReconfiguration* message.

NOTE 2: E-UTRAN may configure via dedicated signalling different parameter values than the ones broadcast in the concerned SCell.

[TS 36.331, clause 5.3.5.3]

If the *RRCCONNECTIONRECONFIGURATION* message does not include the *mobilityControlInfo* and the UE is able to comply with the configuration included in this message, the UE shall:

...

1> if the received *RRCCONNECTIONRECONFIGURATION* includes the *sCellToReleaseList*:

2> perform SCell release as specified in 5.3.10.3a;

1> if the received *RRCCONNECTIONRECONFIGURATION* includes the *sCellToAddModList*:

2> perform SCell addition or modification as specified in 5.3.10.3b;

...

1> submit the *RRCCONNECTIONRECONFIGURATIONCOMPLETE* message to lower layers for transmission using the new configuration, upon which the procedure ends;

[TS 36.331, clause 5.3.10.3a]

The UE shall:

1> if the release is triggered by reception of the *sCellToReleaseList*:

2> for each *sCellIndex* value included in the *sCellToReleaseList*:

3> if the current UE configuration includes an SCell with value *sCellIndex*:

4> release the SCell;

1> if the release is triggered by RRC connection re-establishment:

2> release all SCells that are part of the current UE configuration;

[TS 36.331, clause 5.3.10.3b]

The UE shall:

1> for each *sCellIndex* value included in the *sCellToAddModList* that is not part of the current UE configuration (SCell addition):

2> add the SCell, corresponding to the *cellIdentification*, in accordance with the received *radioResourceConfigCommonSCell* and *radioResourceConfigDedicatedSCell*;

2> configure lower layers to consider the SCell to be in deactivated state;

1> for each *sCellIndex* value included in the *sCellToAddModList* that is part of the current UE configuration (SCell modification):

2> modify the SCell configuration in accordance with the received *radioResourceConfigDedicatedSCell*;

8.2.2.4.1.3 Test Description

8.2.2.4.1.3.1 Pre-test conditions

System Simulator:

- Cell 1 is the PCell, Cell 3 is the SCell to be added.
- Cell 3 is an Inactive SCell according to [18] cl. 6.3.4
- System information combination 3 as defined in TS 36.508 [18] clause 4.4.3.1 is used in E-UTRA cells.

UE:

None.

Preamble:

- The UE is in state Generic RB Established (state 3) on Cell 1 according to [18].

8.2.2.4.1.3.2 Test procedure sequence

Table 8.2.2.4.1.3.2-1: Main behaviour

St	Procedure	Message Sequence		TP	Verdict
		U - S	Message		
1	The SS transmits an <i>RRConnectionReconfiguration</i> message containing a <i>sCellToAddModList</i> with Cell 3 as SCell addition.	<--	<i>RRConnectionReconfiguration</i>	-	-
2	The UE transmits an <i>RRConnectionReconfigurationComplete</i> message	-->	<i>RRConnectionReconfigurationComplete</i>	-	-
3	The SS transmits an <i>RRConnectionReconfiguration</i> message containing a <i>sCellToReleaseList</i> with a SCell release and a <i>sCellToAddModList</i> with a SCell addition for SCell relevant system information changes, the <i>SCellIndex-r10</i> in both IEs indicate the same SCell as configured in step 1.	<--	<i>RRConnectionReconfiguration</i>	-	-
4	Check: Does the UE transmit an <i>RRConnectionReconfigurationComplete</i> message?	-->	<i>RRConnectionReconfigurationComplete</i>	1	P

8.2.2.4.1.3.3 Specific message contents

Table 8.2.2.4.1.3.3-0: Conditions for specific message contents in Tables 8.2.2.4.1.3.3-3, 8.2.2.4.1.3.3-4 and 8.2.2.4.1.3.3-7

Condition	Explanation
Uplink_CA	The UE supports carrier aggregation in UL under the test band.

Table 8.2.2.4.1.3.3-1: *RRConnectionReconfiguration* (step 1, Table 8.2.2.4.1.3.2-1)

Derivation Path: 36.508 clause 4.6.1 table 4.6.1-8			
Information Element	Value/remark	Comment	Condition
<i>RRConnectionReconfiguration</i> ::= SEQUENCE {			
criticalExtensions CHOICE {			
c1 CHOICE{			
rrcConnectionReconfiguration-r8 SEQUENCE {			
nonCriticalExtension SEQUENCE {			
nonCriticalExtension SEQUENCE {			
nonCriticalExtension SEQUENCE {			
sCellToReleaseList-r10	Not present		
sCellToAddModList-r10	SCellToAddMod-r10-f2-Add	SCell addition for Cell 3	
nonCriticalExtension SEQUENCE {}	Not present		
}			
}			
}			
}			
}			
}			
}			

Table 8.2.2.4.1.3.3-2: SCellToAddMod-r10-f2-Add (Table 8.2.2.4.1.3.3-1)

Derivation Path: 36.508 clause 4.6.1 table 4.6.3-19D SCellToAddMod-r10-DEFAULT			
Information Element	Value/remark	Comment	Condition
SCellToAddMod-r10 ::= SEQUENCE (SIZE (1..maxSCell-r10)) OF SEQUENCE {	1 entry		
sCellIndex-r10	1		
cellIdentification-r10 SEQUENCE {			
physCellId-r10	Physical Cell Identity of Cell 3		
dl-CarrierFreq-r10	Same downlink EARFCN as used for Cell 3		
}			
radioResourceConfigCommonSCell-r10	RadioResourceConfigCommonSCell-r10-f2		
radioResourceConfigDedicatedSCell-r10	RadioResourceConfigDedicatedSCell-r10-f2		
}			

Table 8.2.2.4.1.3.3-3: RadioResourceConfigCommonSCell-r10-f2 (Table 8.2.2.4.1.3.3-2)

Derivation Path: 36.508 clause 4.6.3 table 4.6.3-13A			
Information Element	Value/remark	Comment	Condition
RadioResourceConfigCommonSCell-r10 ::= SEQUENCE {			
nonUL-Configuration-r10 SEQUENCE {			
dl-Bandwidth-r10	Same downlink system bandwidth as used for Cell 3		
}			
ul-Configuration-r10	Not present		
ul-Configuration-r10 SEQUENCE {			Uplink_CA
ul-FreqInfo-r10 SEQUENCE {			
ul-CarrierFreq-r10	Same uplink EARFCN as used for Cell 3		FDD
	Not present		TDD
ul-Bandwidth-r10	Same uplink system bandwidth as used for Cell 3	optional	FDD
	Not present		TDD
additionalSpectrumEmissionSCell-r10	Same additionalSpectrumEmission as used for Cell 3		
}			
}			
}			

Table 8.2.2.4.1.3.3-4: RadioResourceConfigDedicatedSCell-r10-f2 (Table 8.2.2.4.1.3.3-2)

Derivation Path: 36.508 clause 4.6.3 table 4.6.3-19AA			
Information Element	Value/remark	Comment	Condition
RadioResourceConfigDedicatedSCell-r10 ::= SEQUENCE {			
physicalConfigDedicatedSCell-r10 SEQUENCE {			
ul-Configuration-r10	Not present		
ul-Configuration-r10 SEQUENCE {			Uplink_CA
antennaInfoUL-r10	Not present		
pusch-ConfigDedicatedSCell-r10	Not present		
uplinkPowerControlDedicatedSCell-r10	UplinkPowerControlDedicatedSCell-r10-DEFAULT		
cqi-ReportConfigSCell-r10	CQI-ReportConfigSCell-r10-DEFAULT		
soundingRS-UL-ConfigDedicated-r10	Not present		
soundingRS-UL-ConfigDedicated-v1020	Not present		
soundingRS-UL-ConfigDedicatedAperiodic-r10	Not present		
}			
}			
}			

Table 8.2.2.4.1.3.3-5: RRCConnectionReconfiguration (step 3, Table 8.2.2.4.1.3.2-2)

Derivation Path: 36.508 clause 4.6.1 table 4.6.1-8			
Information Element	Value/remark	Comment	Condition
RRCConnectionReconfiguration ::= SEQUENCE {			
criticalExtensions CHOICE {			
c1 CHOICE {			
rrcConnectionReconfiguration-r8 SEQUENCE {			
nonCriticalExtension SEQUENCE {			
nonCriticalExtension SEQUENCE {			
sCellToReleaseList-r10 SEQUENCE (SIZE (1..maxSCell-r10) OF SEQUENCE {	1 entry		
sCellIndex-r10[1]	1	SCell release for Cell 3	
}			
sCellToAddModList-r10	SCellToAddMod-r10-f2-Add-SIchange	SCell addition for Cell 3	
}	Not present		
}			
}			
}			
}			
}			

Table 8.2.2.4.1.3.3-6: SCellToAddMod-r10-f2-Add-SIchange (Table 8.2.2.4.1.3.3-5)

Derivation Path: 36.508 clause 4.6.1 table 4.6.3-19D SCellToAddMod-r10-DEFAULT			
Information Element	Value/remark	Comment	Condition
SCellToAddMod-r10 ::= SEQUENCE (SIZE (1..maxSCell-r10)) OF SEQUENCE {	1 entry		
sCellIndex-r10	1		
cellIdentification-r10 SEQUENCE {			
physCellId-r10	Physical Cell Identity of Cell 3		
dl-CarrierFreq-r10	Same downlink EARFCN as used for Cell 3		
}			
radioResourceConfigCommonSCell-r10	RadioResourceConfigCommonSCell-r10-f2-SIchange		
}			

Table 8.2.2.4.1.3.3-7: RadioResourceConfigCommonSCell-r10-f2-SIchange (Table 8.2.2.4.1.3.3-6)

Derivation Path: 36.508 clause 4.6.3 table 4.6.3-13A			
Information Element	Value/remark	Comment	Condition
RadioResourceConfigCommonSCell-r10 ::= SEQUENCE {			
nonUL-Configuration-r10 SEQUENCE {			
dl-Bandwidth-r10	Same downlink system bandwidth as used for Cell 3		
antennaInfoCommon-r10 SEQUENCE {			
antennaPortsCount	an1		
}			
ul-Configuration-r10	Not present		
ul-Configuration-r10 SEQUENCE {			Uplink_CA
ul-FreqInfo-r10 SEQUENCE {			
ul-CarrierFreq-r10	Same uplink EARFCN as used for Cell 3		FDD
	Not present		TDD
ul-Bandwidth-r10	Same uplink system bandwidth as used for Cell 3	optional	FDD
	Not present		TDD
additionalSpectrumEmissionSCell-r10	Same additionalSpectrumEmission as used for Cell 3		
}			
}			

8.2.2.4.2 CA / RRC connection reconfiguration / SCell SI change / Success / Inter-Band CA

The scope and description of the present TC is the same as test case 8.2.2.4.1 with the following differences:

- CA configuration: Inter-band CA replaces Intra-band Contiguous CA
- Cells configuration: Cell 10 replaces Cell 3
- Cell 10 is an Inactive SCell according to [18] cl. 6.3.4

8.2.2.5 CA / RRC connection reconfiguration / SCell addition without UL / Success

8.2.2.5.1 CA / RRC connection reconfiguration / SCell addition without UL / Success / Intra-band Contiguous CA

8.2.2.5.1.1 Test Purpose (TP)

(1)

```
with { UE in E-UTRA RRC_CONNECTED state }
ensure that {
  when { UE receives an RRCConnectionReconfiguration message containing sCellToAddModList with SCell
  addition without UL carrier }
  then { UE adds the new SCell and sends an RRCConnectionReconfigurationComplete message }
}
```

8.2.2.5.1.2 Conformance requirements

References: The conformance requirements covered in the current TC is specified in: TS 36.331, clauses 5.3.5.3, 5.3.10.3b.

[TS 36.331, clause 5.3.5.3]

If the *RRCConnectionReconfiguration* message does not include the *mobilityControlInfo* and the UE is able to comply with the configuration included in this message, the UE shall:

...

1> if the received *RRCConnectionReconfiguration* includes the *sCellToAddModList*:

2> perform SCell addition or modification as specified in 5.3.10.3b;

...

1> submit the *RRCConnectionReconfigurationComplete* message to lower layers for transmission using the new configuration, upon which the procedure ends;

[TS 36.331, clause 5.3.10.3b]

The UE shall:

1> for each *sCellIndex* value included in the *sCellToAddModList* that is not part of the current UE configuration (SCell addition):

2> add the SCell, corresponding to the *cellIdentification*, in accordance with the received *radioResourceConfigCommonSCell* and *radioResourceConfigDedicatedSCell*;

2> configure lower layers to consider the SCell to be in deactivated state;

1> for each *sCellIndex* value included in the *sCellToAddModList* that is part of the current UE configuration (SCell modification):

2> modify the SCell configuration in accordance with the received *radioResourceConfigDedicatedSCell*;

8.2.2.5.1.3 Test Description

8.2.2.5.1.3.1 Pre-test conditions

System Simulator:

- Cell 1 is the PCell, Cell 3 is the SCell to be added.
- Cell 3 is an Inactive SCell according to [18] cl. 6.3.4
- System information combination 3 as defined in TS 36.508 [18] clause 4.4.3.1 is used in E-UTRA cells.

UE:

None.

Preamble:

- The UE is in state Generic RB Established (state 3) on Cell 1 according to [18].

8.2.2.5.1.3.2 Test procedure sequence

Table 8.2.2.5.1.3.2-1: Main behaviour

St	Procedure	Message Sequence		TP	Verdict
		U - S	Message		
1	The SS transmits an <i>RRCCONNECTIONRECONFIGURATION</i> message containing a <i>sCellToAddModList</i> with SCell Cell 3 addition without UL carrier.	<--	<i>RRCCONNECTIONRECONFIGURATION</i>	-	-
2	Check: Does the UE transmit an <i>RRCCONNECTIONRECONFIGURATIONCOMPLETE</i> message?	-->	<i>RRCCONNECTIONRECONFIGURATIONCOMPLETE</i>	1	P

8.2.2.5.1.3.3 Specific message contents

Table 8.2.2.5.1.3.3-1: *RRCCONNECTIONRECONFIGURATION* (step 1, Table 8.2.2.5.1.3.2-1)

Derivation Path: 36.331 clause 6.2.2			
Information Element	Value/remark	Comment	Condition
<i>RRCCONNECTIONRECONFIGURATION</i> ::= SEQUENCE {			
criticalExtensions CHOICE {			
c1 CHOICE{			
rrcConnectionReconfiguration-r8 SEQUENCE {			
nonCriticalExtension SEQUENCE {			
nonCriticalExtension SEQUENCE {			
nonCriticalExtension SEQUENCE {			
sCellToReleaseList-r10	Not present		
sCellToAddModList-r10	SCellToAddMod-r10-f2-Add	SCell addition for Cell 3 without UL carrier	
nonCriticalExtension SEQUENCE {}	Not present		
}			
}			
}			
}			
}			
}			
}			

Table 8.2.2.5.1.3.3-2: SCellToAddMod-r10-f2-Add (Table 8.2.2.5.1.3.3-1)

Derivation Path: 36.508 clause 4.6.1 table 4.6.3-19D SCellToAddMod-r10-DEFAULT			
Information Element	Value/remark	Comment	Condition
SCellToAddMod-r10 ::= SEQUENCE (SIZE (1..maxSCell-r10)) OF SEQUENCE {	1 entry		
sCellIndex-r10	1		
cellIdentification-r10 SEQUENCE {			
physCellId-r10	Physical Cell Identity of Cell 3		
dl-CarrierFreq-r10	Same downlink EARFCN as used for Cell 3		
}			
radioResourceConfigCommonSCell-r10	RadioResourceConfigCommonSCell-r10-f2		
radioResourceConfigDedicatedSCell-r10	RadioResourceConfigDedicatedSCell-r10-f2		
}			

Table 8.2.2.5.1.3.3-3: RadioResourceConfigCommonSCell-r10-f2 (Table 8.2.2.5.1.3.3-2)

Derivation Path: 36.508 clause 4.6.3 table 4.6.3-13A			
Information Element	Value/remark	Comment	Condition
RadioResourceConfigCommonSCell-r10 ::= SEQUENCE {			
nonUL-Configuration-r10 SEQUENCE {			
dl-Bandwidth-r10	Same downlink system bandwidth as used for Cell 3		
}			
UI-Configuration-r10	Not present		
}			

Table 8.2.2.5.1.3.3-4: RadioResourceConfigDedicatedSCell-r10-f2 (Table 8.2.2.5.1.3.3-2)

Derivation Path: 36.508 clause 4.6.3 table 4.6.3-19AA			
Information Element	Value/remark	Comment	Condition
RadioResourceConfigDedicatedSCell-r10 ::= SEQUENCE {			
physicalConfigDedicatedSCell-r10 SEQUENCE {			
ul-Configuration-r10	Not present		
}			
}			

8.2.2.5.2 CA / RRC connection reconfiguration / SCell addition without UL / Success / Inter-band CA

The scope and description of the present TC is the same as test case 8.2.2.5.1 with the following differences:

- CA configuration: Inter-band CA replaces Intra-band Contiguous CA
- Cells configuration: Cell 10 replaces Cell 3
- Cell 10 is an Inactive SCell according to [18] cl. 6.3.4

8.2.2.6 RRC connection reconfiguration/ UE Assistance Information

8.2.2.6.1 RRC connection reconfiguration/ UE Assistance Information/power preference indication setup and release

8.2.2.6.1.1 Test Purpose (TP)

(1)

```
with { UE in E-UTRA RRC_CONNECTED state and it is not configured to provide power preference
indications }
ensure that {
  when { UE is caused to send UEAssistanceInformation message indicating "lowPowerConsumption" }
  then { the UE does not transmit a UEAssistanceInformation message }
}
```

(2)

```
with { UE in E-UTRA RRC_CONNECTED state and it is configured to provide power preference indications
with T340 set to 0s}
ensure that {
  when { UE prefers a configuration primarily optimised for power saving and sends the message
UEAssistanceInformation }
  then { the UE includes powerPrefIndication set to lowPowerConsumption in the message
UEAssistanceInformation }
}
```

(3)

```
with { UE in E-UTRA RRC_CONNECTED state and it is configured to provide power preference indications
and it has previously sent UEAssistanceInformation message indicating "lowPowerConsumption" }
ensure that {
  when { UE is caused to send UEAssistanceInformation message indicating "lowPowerConsumption" }
  then { the UE does not transmit a UEAssistanceInformation message with powerPrefIndication set
to lowPowerConsumption }
}
```

(4)

```
with { UE in E-UTRA RRC_CONNECTED state and it is configured to provide power preference indications
}
ensure that {
  when { UE receives an RRCCConnectionReconfiguration message containing a otherConfig that includes
the powerPrefIndicationConfig set to Release }
  then { the UE does not transmit any more UEAssistanceInformation message }
}
```

8.2.2.6.1.2 Conformance requirements

References: The conformance requirements covered in the current TC is specified in: TS 36.331, clauses 5.3.10.9, 5.6.10.2, 5.6.10.3 and 6.3.6. Unless otherwise stated these are Rel-11 requirements.

[TS 36.331, clause 5.3.10.9]

The UE shall:

...

- 1> if the received *otherConfig* includes the *powerPrefIndicationConfig*:
- 2> if *powerPrefIndicationConfig* is set to *setup*:
 - 3> consider itself to be configured to provide power preference indications in accordance with 5.6.10;
- 2> else:
 - 3> consider itself not to be configured to provide power preference indications;

[TS 36.331, clause 5.6.10.2]

A UE capable of providing power preference indications in RRC_CONNECTED may initiate the procedure in several cases including upon being configured to provide power preference indications and upon change of power preference.

Upon initiating the procedure, the UE shall:

- 1> if configured to provide power preference indications:
 - 2> if the UE did not transmit a *UEAssistanceInformation* message since it was configured to provide power preference indications; or
 - 2> if the current power preference is different from the one indicated in the last transmission of the *UEAssistanceInformation* message and timer T340 is not running;
 - 3> initiate transmission of the *UEAssistanceInformation* message in accordance with 5.6.10.3;

[TS 36.331, clause 5.6.10.3]

The UE shall set the contents of the *UEAssistanceInformation* message:

- 1> if the UE prefers a configuration primarily optimised for power saving:
 - 2> set *powerPrefIndication* to *lowPowerConsumption*;
- 1> else:
 - 2> start or restart timer T340 with the timer value set to the *powerPrefIndicationTimer*;
 - 2> set *powerPrefIndication* to *normal*;

The UE shall submit the *UEAssistanceInformation* message to lower layers for transmission.

[TS 36.331, clause 6.3.6]

powerPrefIndicationTimer

Prohibit timer for Power Preference Indication reporting. Value in seconds. Value s0 means prohibit timer is set to 0 second or not set, value s0dot5 means prohibit timer is set to 0.5 second, value s1 means prohibit timer is set to 1 second and so on.

8.2.2.6.1.3 Test Description

8.2.2.6.1.3.1 Pre-test conditions

System Simulator:

- Cell 1

UE:

None.

Preamble:

- The UE is in state Generic RB Established (state 3) on Cell 1 according to [18].

8.2.2.6.1.3.2 Test procedure sequence

Table 8.2.2.6.1.3.2-1: Main behaviour

St	Procedure	Message Sequence		TP	Verdict
		U - S	Message		
1	Cause the UE to send <i>UEAssistanceInformation</i> message indicating "lowPowerConsumption". (Note 1)			-	-
2	Check: Does the UE send a <i>UEAssistanceInformation</i> message within the next 5s?	-->	<i>UEAssistanceInformation</i>	1	F
3	The SS transmits an <i>RRCCConnectionReconfiguration</i> message containing a <i>otherConfig</i> includes the <i>powerPrefIndicationConfig</i> set to <i>Setup</i>	<--	<i>RRCCConnectionReconfiguration</i>		
4	The UE transmits an <i>RRCCConnectionReconfigurationComplete</i> message.	-->	<i>RRCCConnectionReconfigurationComplete</i>	-	-
5	Cause the UE to send <i>UEAssistanceInformation</i> message indicating "lowPowerConsumption". (Note 1)			-	-
6	Check: Does the UE transmit a <i>UEAssistanceInformation</i> message with <i>powerPrefIndication</i> set to <i>lowPowerConsumption</i> ?	-->	<i>UEAssistanceInformation</i>	2	P
7	Cause the UE to send <i>UEAssistanceInformation</i> message indicating "lowPowerConsumption". (Note 1)				
8	Check: Does the UE send a <i>UEAssistanceInformation</i> message within the next 5s?	-->	<i>UEAssistanceInformation</i>	3	F
9	The SS transmits an <i>RRCCConnectionReconfiguration</i> message containing a <i>otherConfig</i> includes the <i>powerPrefIndicationConfig</i> set to <i>Release</i> .	<--	<i>RRCCConnectionReconfiguration</i>	-	-
10	The UE transmits an <i>RRCCConnectionReconfigurationComplete</i> message	-->	<i>RRCCConnectionReconfigurationComplete</i>	-	-
11	Cause the UE to send <i>UEAssistanceInformation</i> message indicating "normal". (Note 2)			-	-
12	Check: Does the UE send a <i>UEAssistanceInformation</i> message within the next 5s?	-->	<i>UEAssistanceInformation</i>	4	F
13	Cause the UE to send <i>UEAssistanceInformation</i> message indicating "lowPowerConsumption". (Note 1)			-	-
14	Check: Does the UE send a <i>UEAssistanceInformation</i> message within the next 5s?	-->	<i>UEAssistanceInformation</i>	4	F

Note 1: This indication may be triggered with the AT command +CEPPI/+CNMPD or any alternative way.

Note 2: This indication may be triggered with the AT command +CEPPI or any alternative way.

8.2.2.6.1.3.3 Specific message contents

Table 8.2.2.6.1.3.3-1: *RRCCConnectionReconfiguration* (Steps 3 and 9, Table 8.2.2.6.1.3.2-1)

Derivation Path: 36.508, Table 4.6.1-8, condition OtherConfig

Table 8.2.2.6.1.3.3-2: OtherConfig-r9 (step 3, Table 8.2.2.6.1.3.2-1)

Derivation Path: 36.508, Table 4.6.3-28 condition Setup			
Information Element	Value/remark	Comment	Condition
OtherConfig-r9 SEQUENCE {			
PowerPrefIndicationConfig-r11 CHOICE {			
setup SEQUENCE {			
powerPrefIndicationTimer-r11	s0		
}			
}			
}			

Table 8.2.2.6.1.3.3-2: UEAssistanceInformation (Step 6, Table 8.2.2.6.1.3.2-1)

Derivation Path: 36.508, Table 4.6.1-26 condition Low_Power

Table 8.2.2.6.1.3.3-3: OtherConfig-r9 (Step 9, Table 8.2.2.6.1.3.2-3)

Derivation Path: 36.508, Table 4.6.3-28 condition Release

8.2.2.6.2 RRC connection reconfiguration/ UE Assistance Information/power preference indication release on connection re-establishment

8.2.2.6.2.1 Test Purpose (TP)

(1)

```
with { UE in E-UTRA RRC_Connected state & configured to provide power preference indication }
ensure that {
  when { RRC Connection re-establishment procedure is initiated }
  then { UE shall stop T340 }
}
```

(2)

```
with { UE in E-UTRA RRC_Connected state & configured to provide power preference indication }
ensure that {
  when { RRC Connection re-establishment procedure is initiated }
  then { UE shall release the powerPrefIndicationConfig }
}
```

8.2.2.6.2.2 Conformance requirements

References: The conformance requirements covered in the present TC are specified in: TS 36.331 clause 5.6.10.1, 5.6.10.2, 5.6.10.3 and 5.3.7.2. Unless otherwise stated these are Rel-11 requirements.

[TS 36.331 clause 5.6.10.1]

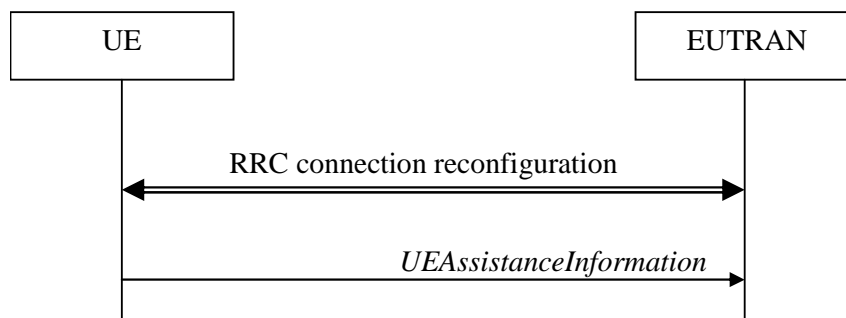

Figure 5.6.10.1-1: UE Assistance Information

The purpose of this procedure is to inform E-UTRAN of the UE's power saving preference. Upon configuring the UE to provide power preference indications E-UTRAN may consider that the UE does not prefer a configuration primarily optimised for power saving until the UE explicitly indicates otherwise.

[TS 36.331 clause 5.6.10.2]

A UE capable of providing power preference indications in RRC_CONNECTED may initiate the procedure in several cases including upon being configured to provide power preference indications and upon change of power preference.

Upon initiating the procedure, the UE shall:

- 1> if configured to provide power preference indications:
 - 2> if the UE did not transmit a *UEAssistanceInformation* message since it was configured to provide power preference indications; or
 - 2> if the current power preference is different from the one indicated in the last transmission of the *UEAssistanceInformation* message and timer T340 is not running:
 - 3> initiate transmission of the *UEAssistanceInformation* message in accordance with 5.6.10.3;

[TS 36.331 clause 5.6.10.3]

The UE shall set the contents of the *UEAssistanceInformation* message:

- 1> if the UE prefers a configuration primarily optimised for power saving:
 - 2> set *powerPrefIndication* to *lowPowerConsumption*;
- 1> else:
 - 2> start or restart timer T340 with the timer value set to the *powerPrefIndicationTimer*;
 - 2> set *powerPrefIndication* to *normal*;

The UE shall submit the *UEAssistanceInformation* message to lower layers for transmission.

[TS 36.331 clause 5.3.7.2]

The UE shall only initiate the procedure when AS security has been activated. The UE initiates the procedure when one of the following conditions is met:

- 1> upon detecting radio link failure, in accordance with 5.3.11; or
- 1> upon handover failure, in accordance with 5.3.5.6; or
- 1> upon mobility from E-UTRA failure, in accordance with 5.4.3.5; or
- 1> upon integrity check failure indication from lower layers; or
- 1> upon an RRC connection reconfiguration failure, in accordance with 5.3.5.5;

Upon initiation of the procedure, the UE shall:

- 1> stop timer T310, if running;
- 1> start timer T311;
- 1> suspend all RBs except SRB0;
- 1> reset MAC;
- 1> release the SCell(s), if configured, in accordance with 5.3.10.3a;
- 1> apply the default physical channel configuration as specified in 9.2.4;
- 1> apply the default semi-persistent scheduling configuration as specified in 9.2.3;

- 1> apply the default MAC main configuration as specified in 9.2.2;
- 1> release *powerPrefIndicationConfig*, if configured and stop timer T340, if running;
- 1> release *reportProximityConfig* and clear any associated proximity status reporting timer;
- 1> release *obtainLocationConfig*, if configured;
- 1> release *idc-Config*, if configured;
- 1> release *measSubframePatternPCell*, if configured;
- 1> if connected as an RN and configured with an RN subframe configuration:
 - 2> release the RN subframe configuration;
- 1> perform cell selection in accordance with the cell selection process as specified in TS 36.304 [4];

8.2.2.6.2.3 Test description

8.2.2.6.2.3.1 Pre-test conditions

System Simulator:

- Cell 1 & Cell 3.
- System information combination 2 as defined in TS 36.508[18] clause 4.4.3.1 is used in E-UTRA Cell 1.

UE:

- The UE supporting power preference indication.

Preamble:

- The UE is in state Generic RB Established (state 3) on Cell 1 according to [18].

8.2.2.6.2.3.2 Test procedure sequence

Table 8.2.2.6.2.3.2-1 illustrates the downlink power levels and other changing parameters to be applied for the cells at various time instants of the test execution. Row marked "T0" denotes the initial conditions after preamble, while columns marked "T1", and "T2" are to be applied subsequently. The exact instants on which these values shall be applied are described in the texts in this clause.

Table 8.2.2.6.2.3.2-1: Time instances of cell power level and parameter changes

	Parameter	Unit	Cell 1	Cell 3	Remark
T0	Cell-specific RS EPRE	dBm/15kHz	-85	-91	The power level values are such that measurement results for Cell 1 (M1) and Cell 3 (M3) satisfy exit condition for event A3 ($M3 < M1$).
T1	Cell-specific RS EPRE	dBm/15kHz	-85	-79	The power level values are such that measurement results for Cell 1 (M1) and Cell 3 (M3) satisfy entry condition for event A3 ($M3 > M1$).
T2	Cell-specific RS EPRE	dBm/15kHz	-85	"Off"	The power level values are assigned to satisfy $SrxlevCell\ 3 < 0$ such that selecting Cell 1 is guaranteed (NOTE 1).

NOTE 1: Power level "Off" is defined in TS36.508 Table 6.2.2.1-1.

Table 8.2.2.6.2.3.2-2: Main behaviour

St	Procedure	Message Sequence		TP	Verdict
		U - S	Message		
1	The SS transmits an <i>RRCCONNECTIONRECONFIGURATION</i> message to setup intra frequency measurement on Cell 1 & to configure power preference indication.	<--	<i>RRCCONNECTIONRECONFIGURATION</i>	-	-
2	The UE transmits an <i>RRCCONNECTIONRECONFIGURATIONCOMPLETE</i> message on Cell 1.	-->	<i>RRCCONNECTIONRECONFIGURATIONCOMPLETE</i>	-	-
3	Cause the UE to send <i>UEASSISTANCEINFORMATION</i> message indicating "lowPowerConsumption". (Note1).	-	-	-	-
4	UE transmits <i>UEASSISTANCEINFORMATION</i> message with <i>powerPrefIndication</i> IE set to <i>lowPowerConsumption</i> .	-->	<i>UEASSISTANCEINFORMATION</i>	-	-
5	Cause the UE to send <i>UEASSISTANCEINFORMATION</i> message indicating "normal"(Note2).	-	-	-	-
6	UE transmits <i>UEASSISTANCEINFORMATION</i> message with <i>powerPrefIndication</i> IE set to <i>normal</i> and starts timer T340 with the timer value set to the <i>powerPrefIndicationTimer</i> .	-->	<i>UEASSISTANCEINFORMATION</i>	-	-
7	The SS changes Cell 1 and Cell 3 parameters according to the row "T1" in table 8.2.2.6.2.3.2-1.	-	-	-	-
8	The UE transmits a <i>MEASUREMENTREPORT</i> message on Cell 1 to report event A3 with the measured RSRP, RSRQ value for Cell 3.	-->	<i>MEASUREMENTREPORT</i>	-	-
9	The SS transmits an <i>RRCCONNECTIONRECONFIGURATION</i> message on Cell 1 to order the UE to perform intra frequency handover to Cell 3.	<--	<i>RRCCONNECTIONRECONFIGURATION</i>	-	-
-	EXCEPTION: In parallel to the events described in step 9 the steps specified in Table 8.2.2.6.2.3.2-3 should take place.	-	-	-	-
10	The SS changes Cell 1 and Cell 3 parameters according to the row "T2" in table 8.2.2.6.2.3.2-1.	-	-	-	-
11	The UE releases the configured <i>powerPrefIndicationConfig</i> , stops timer T340 and transmit an <i>RRCCONNECTIONREESTABLISHMENTREQUEST</i> message on Cell 1.	-->	<i>RRCCONNECTIONREESTABLISHMENTREQUEST</i>	-	-
12	The SS transmits an <i>RRCCONNECTIONREESTABLISHMENT</i> message to resume SRB1 operation and re-activate security on Cell 1.	<--	<i>RRCCONNECTIONREESTABLISHMENT</i>	-	-
13	The UE transmits an <i>RRCCONNECTIONREESTABLISHMENTCOMPLETE</i> message on Cell 1.	-->	<i>RRCCONNECTIONREESTABLISHMENTCOMPLETE</i>	-	-
14	Cause the UE to send <i>UEASSISTANCEINFORMATION</i> message indicating "lowPowerConsumption". (Note1).	-	-	-	-
15	Check: Does the UE transmit <i>UEASSISTANCEINFORMATION</i> message? (Note 3).	-->	<i>UEASSISTANCEINFORMATION</i>	2	F
16	The SS transmits an <i>RRCCONNECTIONRECONFIGURATION</i> message to resume existing radio bearer on Cell 1 & to configure power preference indication.	<--	<i>RRCCONNECTIONRECONFIGURATION</i>	-	-
17	The UE transmits an <i>RRCCONNECTIONRECONFIGURATIONCOMPLETE</i> message on Cell 1.	-->	<i>RRCCONNECTIONRECONFIGURATIONCOMPLETE</i>	-	-
18	Cause the UE to send <i>UEASSISTANCEINFORMATION</i> message indicating "lowPowerConsumption". (Note1).	-	-	-	-

19	Check: Does the UE transmit <i>UEAssistanceInformation</i> message with <i>powerPrefIndication</i> IE set to <i>lowPowerConsumption</i> ? (Note 4).	-->	<i>UEAssistanceInformation</i>	1	P
<p>Note 1: This indication may be triggered with the AT command +CEPPI/+CNMPD or any alternative way.</p> <p>Note 2: This indication may be triggered with the AT command +CEPPI or any alternative way.</p> <p>Note 3: This is a negative check for TP2 to make sure that the UE has released the configured <i>powerPrefIndicationConfig</i> at step 11.</p> <p>Note 4: The total time to execute step 6 – step 17 should be less than the T340 timer value <i>powerPrefIndicationTimer</i> configured at step 1 and started at step 6. This is to make sure that timer T340 has been stopped successfully at step 11 and only then UE will initiate <i>UEAssistanceInformation</i> message with <i>powerPrefIndication</i> IE set to <i>lowPowerConsumption</i> at step 17.</p>					

Table 8.2.2.6.2.3.2-3: Parallel behaviour

St	Procedure	Message Sequence		TP	Verdict
		U - S	Message		
-	EXCEPTION: The steps 1 and 2 below are repeated for the duration of T304.	-	-	-	-
1	The UE attempts to perform the intra frequency handover using MAC Random Access Preamble on Cell 3.	-	-	-	-
2	The SS does not respond.	-	-	-	-

8.2.2.6.2.3.3 Specific message contents

Table 8.2.2.6.2.3.3-1: *RRCConnectionReconfiguration* (step 1, Table 8.2.2.6.2.3.2-2)

Derivation Path: 36.508, Table 4.6.1-8, conditions MEAS & OtherConfig

Table 8.2.2.6.2.3.3-2: *MeasConfig* (Table 8.2.2.6.2.3.3-1)

Derivation Path: 36.508, Table 4.6.6-1			
Information Element	Value/remark	Comment	Condition
MeasConfig SEQUENCE {			
measObjectToAddModList SEQUENCE (SIZE (1..maxObjectld)) OF SEQUENCE {	1 entry		
measObjectld[1]	ldMeasObject-f1		
measObject[1]	MeasObjectEUTRA-GENERIC(f1)		
}			
reportConfigToAddModList SEQUENCE (SIZE (1..maxReportConfigld)) OF SEQUENCE {	1 entry		
reportConfigld[1]	ldReportConfig-A3		
reportConfig[1]	ReportConfigEUTRA-A3		
}			
measldToAddModList SEQUENCE (SIZE (1..maxMeasld)) OF SEQUENCE {	1 entry		
measld[1]	1		
measObjectld[1]	ldMeasObject-f1		
reportConfigld[1]	ldReportConfig-A3		
}			
}			

Table 8.2.2.6.2.3.3-3: OtherConfig-r9 (Table 8.2.2.6.2.3.3-1)

Derivation Path: 36.508, Table 4.6.3-28 condition Setup			
Information Element	Value/remark	Comment	Condition
OtherConfig-r9 SEQUENCE {			
PowerPrefIndicationConfig-r11 CHOICE {			
setup SEQUENCE {			
powerPrefIndicationTimer-r11	s600		
}			
}			
}			

Table 8.2.2.6.2.3.3-4: UEAssistanceInformation (step 4, 15 & 19, Table 8.2.2.6.2.3.2-2)

Derivation Path: 36.508, Table 4.6.1-26 condition Low_Power			
Information Element	Value/remark	Comment	Condition
powerPreferenceIndication-r11	lowPowerConsumption		

Table 8.2.2.6.2.3.3-5: UEAssistanceInformation (step 6, Table 8.2.2.6.2.3.2-2)

Derivation Path: 36.508, Table 4.6.1-26 condition Normal			
Information Element	Value/remark	Comment	Condition
powerPreferenceIndication-r11	normal		

Table 8.2.2.6.2.3.3-6: MeasurementReport (step 8, Table 8.2.2.6.2.3.2-2)

Derivation Path: 36.508, Table 4.6.1-5			
Information Element	Value/remark	Comment	Condition
MeasurementReport ::= SEQUENCE {			
criticalExtensions CHOICE {			
c1 CHOICE{			
measurementReport-r8 SEQUENCE {			
measResults SEQUENCE {			
measId	1		
measResultServCell SEQUENCE {			
rsrpResult	(0..97)		
rsrqResult	(0..34)		
}			
measResultNeighCells CHOICE {			
measResultListEUTRA SEQUENCE (SIZE (1..maxCellReport)) OF SEQUENCE {	1 entry		
physCellId[1]	PhysicalCellId of Cell 3		
cgi-Info[1]	Not present		
measResult[1] SEQUENCE {			
rsrpResult	(0..97)		
rsrqResult	(0..34)		
}			
}			
}			
}			
}			

Table 8.2.2.6.2.3.3-7: RRCConnectionReconfiguration (step 9, Table 8.2.2.6.2.3.2-2)

Derivation Path: 36.508, Table 4.6.1-8, condition HO			
--	--	--	--

Table 8.2.2.6.2.3.3-8: MobilityControlInfo (8.2.2.6.2.3.3-7)

Derivation Path: 36.508, Table 4.6.5-1			
Information Element	Value/remark	Comment	Condition
MobilityControlInfo ::= SEQUENCE {			
targetPhysCellId	PhysicalCellIdentity of Cell 3		
carrierFreq	Not present		
}			

Table 8.2.2.6.2.3.3-9: RRCConnectionReestablishmentRequest (step 11, Table 8.2.2.6.2.3.2-2)

Derivation Path: 36.508, Table 4.6.1-13			
Information Element	Value/remark	Comment	Condition
RRCConnectionReestablishmentRequest ::= SEQUENCE {			
criticalExtensions CHOICE {			
rrcConnectionReestablishmentRequest-r8 SEQUENCE {			
ue-Identity SEQUENCE {			
c-RNTI	the value of the C-RNTI of the UE		
physCellId	PhysicalCellIdentity of Cell 1		
shortMAC-I	The same value as the 16 least significant bits of the XMAC-I value calculated by SS.		
}			
reestablishmentCause	handoverFailure		
}			
}			

Table 8.2.2.6.2.3.3-10: RRCConnectionReestablishmentComplete (step 13, Table 8.2.2.6.2.3.2-2)

Derivation Path: 36.508, Table 4.6.1-11			
Information Element	Value/remark	Comment	Condition
RRCConnectionReestablishmentComplete ::= SEQUENCE {			
criticalExtensions CHOICE {			
rrcConnectionReestablishmentComplete-r8 SEQUENCE {			
nonCriticalExtension SEQUENCE {	Not present		
}			
}			
}			

Table 8.2.2.6.2.3.3-11: RRCConnectionReconfiguration (step 16, Table 8.2.2.6.2.3.2-2)

Derivation Path: 36.508, Table 4.6.1-8 & condition OtherConfig			
Information Element	Value/remark	Comment	Condition
RRCConnectionReconfiguration ::= SEQUENCE {			
criticalExtensions CHOICE {			
c1 CHOICE {			
rrcConnectionReconfiguration-r8 SEQUENCE {			
radioResourceConfigDedicated	RadioResourceConfigDedicated-HO		
}			
}			
}			
}			

Table 8.2.2.6.2.3.3-12: *OtherConfig-r9* (Table 8.2.2.6.2.3.3-11)

Derivation Path: 36.508, Table 4.6.3-28, condition Setup			
Information Element	Value/remark	Comment	Condition
OtherConfig-r9 SEQUENCE {			
PowerPrefIndicationConfig-r11 CHOICE {			
setup SEQUENCE {			
powerPrefIndicationTimer-r11	s10		
}			
}			
}			

8.2.2.6.3 RRC connection reconfiguration/ UE Assistance Information/T340 running

8.2.2.6.3.1 Test Purpose (TP)

(1)

```
with { UE in E-UTRA RRC_CONNECTED state and T340 is running }
ensure that {
  when { UE is caused to send UEAssistanceInformation message }
  then { the UE does not transmit a UEAssistanceInformation message }
}
```

(2)

```
with { UE in E-UTRA RRC_CONNECTED state and the UE has received a new value for
powerPrefIndicationTimer}
ensure that {
  when { UE is caused to send UEAssistanceInformation message indicating "lowPowerConsumption" after
T340 expired }
  then { the UE does transmits a UEAssistanceInformation message with powerPrefIndication set to
lowPowerConsumption}
}
```

8.2.2.6.3.2 Conformance requirements

References: The conformance requirements covered in the current TC is specified in: TS 36.331, clauses 5.6.10.2 and 5.6.10.3. Unless otherwise stated these are Rel-11 requirements.

[TS 36.331, clause 5.6.10.2]

A UE capable of providing power preference indications in RRC_CONNECTED may initiate the procedure in several cases including upon being configured to provide power preference indications and upon change of power preference.

Upon initiating the procedure, the UE shall:

- 1> if configured to provide power preference indications:
 - 2> if the UE did not transmit a *UEAssistanceInformation* message since it was configured to provide power preference indications; or
 - 2> if the current power preference is different from the one indicated in the last transmission of the *UEAssistanceInformation* message and timer T340 is not running:
 - 3> initiate transmission of the *UEAssistanceInformation* message in accordance with 5.6.10.3;

[TS 36.331, clause 5.6.10.3]

The UE shall set the contents of the *UEAssistanceInformation* message:

- 1> if the UE prefers a configuration primarily optimised for power saving:
 - 2> set *powerPrefIndication* to *lowPowerConsumption*;
- 1> else:

2> start or restart timer T340 with the timer value set to the *powerPrefIndicationTimer*;

2> set *powerPrefIndication* to *normal*;

The UE shall submit the *UEAssistanceInformation* message to lower layers for transmission.

8.2.2.6.3.3 Test Description

8.2.2.6.3.3.1 Pre-test conditions

System Simulator:

- Cell 1

UE:

None.

Preamble:

- The UE is in state Generic RB Established (state 3) on Cell 1 according to [18].

8.2.2.6.3.3.2 Test procedure sequence

Table 8.2.2.6.3.3.2-1: Main behaviour

St	Procedure	Message Sequence		TP	Verdict
		U - S	Message		
1	The SS transmits an <i>RRCCONNECTIONRECONFIGURATION</i> message containing a <i>otherConfig</i> includes the <i>powerPrefIndicationConfig</i> set to <i>Setup</i>	<--	<i>RRCCONNECTIONRECONFIGURATION</i>		
2	The UE transmits an <i>RRCCONNECTIONRECONFIGURATIONCOMPLETE</i> message.	-->	<i>RRCCONNECTIONRECONFIGURATIONCOMPLETE</i>	-	-
3	Cause the UE to send <i>UEASSISTANCEINFORMATION</i> message indicating " <i>lowPowerConsumption</i> ". (Note 1)			-	-
4	The UE transmits a <i>UEASSISTANCEINFORMATION</i> message with <i>powerPrefIndication</i> set to <i>lowPowerConsumption</i> .	-->	<i>UEASSISTANCEINFORMATION</i>	-	-
5	Cause the UE to send <i>UEASSISTANCEINFORMATION</i> message indicating " <i>normal</i> ". (Note 2)			-	-
6	The UE transmits a <i>UEASSISTANCEINFORMATION</i> message with <i>powerPrefIndication</i> set to <i>normal</i> . The UE starts T340.	-->	<i>UEASSISTANCEINFORMATION</i>	-	-
7	Before T340 expires, cause the UE to send <i>UEASSISTANCEINFORMATION</i> message indicating " <i>lowPowerConsumption</i> ". (Note 1)			-	-
8	Check: Does the UE send a <i>UEASSISTANCEINFORMATION</i> message before T340 expires?	-->	<i>UEASSISTANCEINFORMATION</i>	1	F
9	Cause the UE to send <i>UEASSISTANCEINFORMATION</i> message indicating " <i>lowPowerConsumption</i> " after T340 has expired. (Note 1)			-	-
10	The UE transmits a <i>UEASSISTANCEINFORMATION</i> message with <i>powerPrefIndication</i> set to <i>lowPowerConsumption</i> .	-->	<i>UEASSISTANCEINFORMATION</i>	-	-
11	The SS transmits an <i>RRCCONNECTIONRECONFIGURATION</i> message containing a <i>otherConfig</i> includes the <i>powerPrefIndicationConfig</i> set to <i>Setup</i> and a new value for <i>powerPrefIndicationTimer</i> .	<--	<i>RRCCONNECTIONRECONFIGURATION</i>		
12	The UE transmits an <i>RRCCONNECTIONRECONFIGURATIONCOMPLETE</i> message.	-->	<i>RRCCONNECTIONRECONFIGURATIONCOMPLETE</i>	-	-
13	Cause the UE to send <i>UEASSISTANCEINFORMATION</i> message indicating " <i>normal</i> ". (Note 2)			-	-
14	The UE transmits a <i>UEASSISTANCEINFORMATION</i> message with <i>powerPrefIndication</i> set to <i>normal</i> . The UE starts T340. Start timer T=300s(this is the same value as the <i>powerPrefIndicationTimer</i> value set in Step 1).	-->	<i>UEASSISTANCEINFORMATION</i>	-	-
15	After T340 expires but before T expires cause the UE to send <i>UEASSISTANCEINFORMATION</i> message indicating " <i>lowPowerConsumption</i> ". (Note 1)			-	-
16	Check: Does the UE send a <i>UEASSISTANCEINFORMATION</i> message with	-->	<i>UEASSISTANCEINFORMATION</i>	2	P

<i>powerPrefIndication</i> set to <i>lowPowerConsumption</i> ?				
Note 1: This indication may be triggered with the AT command +CEPPI/+CNMPD or any alternative way. Note 2: This indication may be triggered with the AT command +CEPPI or any alternative way.				

8.2.2.6.3.3.3 Specific message contents

Table 8.2.2.6.3.3.3-1: RRCConnectionReconfiguration (Steps 1 and 11 Table 8.2.2.6.3.3.2-1)

Derivation Path: 36.508, Table 4.6.1-8, condition OtherConfig

Table 8.2.2.6.3.3.3-2: OtherConfig-r9 (Step 1, Table 8.2.2.6.3.3.2-1)

Derivation Path: 36.508, Table 4.6.3-28 condition Setup			
Information Element	Value/remark	Comment	Condition
OtherConfig-r9 SEQUENCE {			
PowerPrefIndicationConfig-r11 CHOICE {			
setup SEQUENCE {			
powerPrefIndicationTimer-r11	s300		
}			
}			
}			

Table 8.2.2.6.3.3.3-3: UEAssistanceInformation (Steps 4 and 10 Table 8.2.2.6.3.3.2-1)

Derivation Path: 36.508, Table 4.6.1-26 condition Low_Power

Table 8.2.2.6.3.3.3-4: UEAssistanceInformation (Steps 6 and 14, Table 8.2.2.6.3.3.2-1)

Derivation Path: 36.508, Table 4.6.1-26 condition Normal

Table 8.2.2.6.3.3.3-5: OtherConfig-r9 (Step 11, Table 8.2.2.6.3.3.2-1)

Derivation Path: 36.508, Table 4.6.3-28 condition Setup			
Information Element	Value/remark	Comment	Condition
OtherConfig-r9 SEQUENCE {			
PowerPrefIndicationConfig-r11 CHOICE {			
setup SEQUENCE {			
powerPrefIndicationTimer-r11	s30		
}			
}			
}			

8.2.3 Radio bearer release

8.2.3.1 RRC connection reconfiguration / Radio bearer release / Success

8.2.3.1.1 Test Purpose (TP)

(1)

```
with { UE in E-UTRA RRC_CONNECTED state }
ensure that {
  when { UE receives an RRCConnectionReconfiguration message including a drb-ToReleaseList }
  then { for each drb-Identity release the PDCP entity and RLC entity and DTCH logical channel
and indicate release of the DRB(s) to upper layers }
}
```

8.2.3.1.2 Conformance requirements

References: The conformance requirements covered in the present TC are specified in: 3GPP TS 36.331 clause 5.3.5.3 and 5.3.10.2.

[TS 36.331, clause 5.3.5.3]

If the *RRCCConnectionReconfiguration* message does not include the *mobilityControlInfo* and the UE is able to comply with the configuration included in this message, the UE shall:

- 2> if this is the first *RRCCConnectionReconfiguration* message after successful completion of the RRC Connection Re-establishment procedure:

...

1> else:

- 2> If the *RRCCConnectionReconfiguration* message includes the *radioResourceConfigDedicated*:

- 3> perform the radio resource configuration procedure as specified in 5.3.10;

...

1> submit the *RRCCConnectionReconfigurationComplete* message to lower layers for transmission using the new configuration, upon which the procedure ends;

[TS 36.331, clause 5.3.10.2]

The UE shall:

- 1> for each *drb-Identity* value included in the *drb-ToReleaseList* that is part of the current UE configuration (DRB release):
 - 2> release the PDCP entity;
 - 2> release the RLC entity;
 - 2> release the DTCH logical channel;
- 1> indicate the release of the DRB(s) and the *eps-BearerIdentity* of the released DRB(s) to upper layers;

8.2.3.1.3 Test description

8.2.3.1.3.1 Pre-test conditions

System Simulator:

- Cell 1

UE:

None.

Preamble:

- The UE is in state Generic RB Established (state 3) according to [18].
- The condition SRB2-DRB(2, 0) is used for step 8 in 4.5.3.3 according to [18].

8.2.3.1.3.2 Test procedure sequence

Table 8.2.3.1.3.2-1: Main behaviour

St	Procedure	Message Sequence		TP	Verdict
		U - S	Message		
1	The SS transmits an <i>RRCCONNECTIONRECONFIGURATION</i> message with a <i>drb-ToReleaseList</i> .	<--	<i>RRCCONNECTIONRECONFIGURATION</i>	-	-
2	Check: Does the UE transmit an <i>RRCCONNECTIONRECONFIGURATIONCOMPLETE</i> message?	-->	<i>RRCCONNECTIONRECONFIGURATIONCOMPLETE</i>	1	P
2a	The UE transmits an <i>ULINFORMATIONTRANSFER</i> message.	-->	<i>ULINFORMATIONTRANSFER</i>	-	-
3	Check: Does the test result of generic test procedure in TS 36.508 subclause 6.4.2.3 indicate that the UE is in E-UTRA RRC_CONNECTED state on Cell 1?	-	-	1	-

8.2.3.1.3.3 Specific message contents

Table 8.2.3.1.3.3-1: *RRCCONNECTIONRECONFIGURATION* (step 1, Table 8.2.3.1.3.2-1)

Derivation Path: 36.508 table 4.6.1-8			
Information Element	Value/remark	Comment	Condition
<i>RRCCONNECTIONRECONFIGURATION</i> ::= SEQUENCE {			
<i>criticalExtensions</i> CHOICE {			
<i>c1</i> CHOICE {			
<i>rrcConnectionReconfiguration-r8</i> SEQUENCE {			
<i>dedicatedInfoNASList</i> SEQUENCE (SIZE(1..maxDRB)) OF	1 entry		
<i>DedicatedInfoNAS</i> [1]	DEACTIVATE EPS BEARER CONTEXT REQUEST with EPS bearer identity corresponding to <i>drb-Identity 2</i> and ESM cause #36	According 36.508 table 4.7.3-12 and regular deactivation of a second DRB	
<i>radioResourceConfigDedicated</i>	<i>RadioResourceConfigDedicated-DRB-RELEASE</i>	Table 8.2.3.1.3.3-2	
}			
}			
}			
}			

Table 8.2.3.1.3.3-2: *RadioResourceConfigDedicated-DRB-RELEASE* (Table 8.2.3.1.3.3-1)

Derivation Path: 36.331 clause 6.3.2			
Information Element	Value/remark	Comment	Condition
<i>RadioResourceConfigDedicated</i> ::= SEQUENCE {			
<i>srb-ToAddModList</i>	Not present		
<i>drb-ToAddModList</i>	Not present		
<i>drb-ToReleaseList</i> SEQUENCE (SIZE (1..maxDRB)) OF	1 entry		
<i>drb-Identity</i> [1]	2		
<i>mac-MainConfig</i> CHOICE { }	Not present		
<i>sps-Config</i>	Not present		
<i>physicalConfigDedicated</i>	Not present		
}			

8.2.4 Handover

8.2.4.1 RRC connection reconfiguration / Handover / Success / Dedicated preamble

8.2.4.1.1 Test Purpose (TP)

(1)

```
with { UE having completed the radio bearer establishment and initial security activation procedure
and performed the intra frequency measurement }
ensure that {
  when { UE receives an RRCConnectionReconfiguration message including a mobilityControlInfo with a
rach-ConfigDedicated }
  then { UE transmits an RRCConnectionReconfigurationComplete message }
}
```

(2)

```
with { UE having completed the radio bearer establishment and initial security activation procedure
and performed the intra frequency measurement }
ensure that {
  when { UE receives an RRCConnectionReconfiguration message including a nextHopChainingCount which
is different from the NCC associated with the currently active  $K_{eNB}$  }
  then { UE derives new  $K_{eNB}$  key from the nextHopChainingCount }
}
```

(3)

```
with { UE having completed the radio bearer establishment and initial security activation procedure
and performed the intra frequency measurement }
ensure that {
  when { UE receives an RRCConnectionReconfiguration message including a nextHopChainingCount which
is same as the NCC associated with the currently active  $K_{eNB}$  }
  then { UE derives new  $K_{eNB}$  key from the currently active  $K_{eNB}$  }
}
```

8.2.4.1.2 Conformance requirements

References: The conformance requirements covered in the present TC are specified in: TS 36.331, clauses 5.3.5.4, 5.3.10.4 and 5.3.10.6.

[TS 36.331, clause 5.3.5.4]

If the *RRCConnectionReconfiguration* message includes the *mobilityControlInfo* and the UE is able to comply with the configuration included in this message, the UE shall:

- 1> stop timer T310, if running;
- 1> start timer T304 with the timer value set to *t304*, as included in the *mobilityControlInfo*;
- 1> if the *carrierFreq* is included:
 - 2> consider the target cell to be one on the frequency indicated by the *carrierFreq* with a physical cell identity indicated by the *targetPhysCellId*;
- 1> else:
 - 2> consider the target cell to be one on the current frequency with a physical cell identity indicated by the *targetPhysCellId*;
- 1> start synchronising to the DL of the target cell;

NOTE 1: The UE should perform the handover as soon as possible following the reception of the RRC message triggering the handover, which could be before confirming successful reception (HARQ and ARQ) of this message.

- 1> reset MAC;
- 1> re-establish PDCP for all RBs that are established;

NOTE 2: The handling of the radio bearers after the successful completion of the PDCP re-establishment, e.g. the re-transmission of unacknowledged PDCP SDUs (as well as the associated status reporting), the handling of the SN and the HFN, is specified in TS 36.323 [8].

- 1> re-establish RLC for all RBs that are established;
- 1> apply the value of the *newUE-Identity* as the C-RNTI;
- 1> configure lower layers in accordance with the received *radioResourceConfigCommon*;
- 1> configure lower layers in accordance with any additional fields, not covered in the previous, if included in the received *mobilityControlInfo*;
- 1> if the *RRCCoReconfiguration* message includes the *radioResourceConfigDedicated*:
 - 2> perform the radio resource configuration procedure as specified in 5.3.10;
- 1> if the *keyChangeIndicator* received in the *securityConfigHO* is set to *TRUE*:
 - 2> update the K_{eNB} key based on the fresh K_{ASME} key taken into use with the previous successful NAS SMC procedure, as specified in TS 33.401 [32];
- 1> else:
 - 2> update the K_{eNB} key based on the current K_{eNB} or the NH, using the *nextHopChainingCount* value indicated in the *securityConfigHO*, as specified in TS 33.401 [32];
- 1> store the *nextHopChainingCount* value;
- 1> if the *securityAlgorithmConfig* is included in the *securityConfigHO*:
 - 2> derive the K_{RRcint} key associated with the *integrityProtAlgorithm*, as specified in TS 33.401 [32];
 - 2> derive the K_{RRcenc} key and the K_{UPenc} key associated with the *cipheringAlgorithm*, as specified in TS 33.401 [32];
- 1> else:
 - 2> derive the K_{RRcint} key associated with the current integrity algorithm, as specified in TS 33.401 [32];
 - 2> derive the K_{RRcenc} key and the K_{UPenc} key associated with the current ciphering algorithm, as specified in TS 33.401 [32];
- 1> configure lower layers to apply the integrity protection algorithm and the K_{RRcint} key, i.e. the integrity protection configuration shall be applied to all subsequent messages received and sent by the UE, including the message used to indicate the successful completion of the procedure;
- 1> configure lower layers to apply the ciphering algorithm, the K_{RRcenc} key and the K_{UPenc} key, i.e. the ciphering configuration shall be applied to all subsequent messages received and sent by the UE, including the message used to indicate the successful completion of the procedure;
- 1> perform the measurement related actions as specified in 5.5.6.1;
- 1> if the *RRCCoReconfiguration* message includes the *measConfig*:
 - 2> perform the measurement configuration procedure as specified in 5.5.2;
- 1> submit the *RRCCoReconfigurationComplete* message to lower layers for transmission;
- 1> if MAC successfully completes the random access procedure:
 - 2> stop timer T304;
 - 2> apply the parts of the CQI reporting configuration, the scheduling request configuration and the sounding RS configuration that do not require the UE to know the SFN of the target cell, if any;

- 2> apply the parts of the measurement and the radio resource configuration that require the UE to know the SFN of the target cell (e.g. measurement gaps, periodic CQI reporting, scheduling request configuration, sounding RS configuration), if any, upon acquiring the SFN of the target cell;

NOTE 3: Whenever the UE shall setup or reconfigure a configuration in accordance with a field that is received it applies the new configuration, except for the cases addressed by the above statements.

- 2> the procedure ends;

NOTE 4: The UE is not required to determine the SFN of the target cell by acquiring system information from that cell before performing RACH access in the target cell.

[TS 36.331, clause 5.3.10.4]

The UE shall:

- 1> reconfigure the MAC main configuration in accordance with the received *mac-MainConfig*;

[TS 36.331, clause 5.3.10.6]

The UE shall:

- 1> reconfigure the physical channel configuration in accordance with the received *physicalConfigDedicated*;

- 1> if the *antennaInfo* is included and set to '*explicitValue*':

- 2> if the configured *transmissionMode* is not '*tm3*' or '*tm4*' release *ri-ConfigIndex* in *cqi-ReportPeriodic*, if previously configured;

- 1> else if the *antennaInfo* is included and set to '*defaultValue*':

- 2> release *ri-ConfigIndex* in *cqi-ReportPeriodic*, if previously configured;

8.2.4.1.3 Test description

8.2.4.1.3.1 Pre-test conditions

System Simulator:

- Cell 1, Cell 4 and Cell 11.

UE:

None.

Preamble:

- The UE is in state Generic RB Established (state 3) on Cell 1 according to [18].

8.2.4.1.3.2 Test procedure sequence

Table 8.2.4.1.3.2-1 illustrates the downlink power levels and other changing parameters to be applied for the cells at various time instants of the test execution. Row marked "T0" denotes the initial conditions after preamble, while columns marked "T1", "T2", and "T3" are to be applied subsequently. The exact instants on which these values shall be applied are described in the texts in this clause.

Table 8.2.4.1.3.2-1: Time instances of cell power level and parameter changes

	Parameter	Unit	Cell 1	Cell 4	Cell 11	Remark
T0	Cell-specific RS EPRE	dBm/15k Hz	-85	-91	"Off"	The power level values are such that measurement results for Cell 1 (M1) and Cell 4 (M4) satisfy exit condition for event A3 ($M4 < M1$)(NOTE 1).
T1	Cell-specific RS EPRE	dBm/15k Hz	-85	-79	"Off"	The power level values are such that measurement results for Cell 1 (M1) and Cell 4 (M4) satisfy entry condition for event A3 ($M4 > M1$)(NOTE 1).
T2	Cell-specific RS EPRE	dBm/15k Hz	-85	-91	"Off"	The power level values are such that measurement results for Cell 1 (M1) and Cell 4 (M4) satisfy entry condition for event A3 ($M1 > M4$)(NOTE 1).
T3	Cell-specific RS EPRE	dBm/15k Hz	-85	"Off"	-79	The power level value are such that measurement results for Cell 1 (M1) and Cell 11 (M11) satisfy entry condition for event A3 ($M11 > M1$).
NOTE 1: Power level "Off" is defined in TS36.508 Table 6.2.2.1-1.						

Table 8.2.4.1.3.2-2: Main behaviour

St	Procedure	Message Sequence		TP	Verdict
		U - S	Message		
1	The SS transmits an <i>RRConnectionReconfiguration</i> message to setup intra frequency measurement on Cell 1.	<--	<i>RRConnectionReconfiguration</i>	-	-
2	The UE transmits an <i>RRConnectionReconfigurationComplete</i> message on Cell 1.	-->	<i>RRConnectionReconfigurationComplete</i>	-	-
3	The SS changes Cell 1, Cell 4 and Cell 11 parameters according to the row "T1" in table 8.2.4.1.3.2-1.	-	-	-	-
4	The UE transmits a <i>MeasurementReport</i> message to report event A3 on Cell 1 with the measured RSRP, RSRQ value for Cell 4.	-->	<i>MeasurementReport</i>	-	-
5	The SS transmits an <i>RRConnectionReconfiguration</i> message to order the UE to perform intra frequency handover to Cell 4.	<--	<i>RRConnectionReconfiguration</i>	-	-
6	Check: Does the UE transmit an <i>RRConnectionReconfigurationComplete</i> message on Cell 4 using dedicated preamble to confirm the successful completion of the intra frequency handover? Check2: Does the UE transmit an <i>RRConnectionReconfigurationComplete</i> using the security key derived from the currently active K_{eNB} ?	-->	<i>RRConnectionReconfigurationComplete</i>	1,3	P
7	The SS changes Cell 1, Cell 4 and Cell 11 parameters according to the row "T2" in table 8.2.4.1.3.2-1.	-	-	-	-
8	The UE transmits a <i>MeasurementReport</i> message to report event A3 on Cell 4 with the measured RSRP, RSRQ value for Cell 1.	-->	<i>MeasurementReport</i>	-	-
9	The SS transmits an <i>RRConnectionReconfiguration</i> message to order the UE to perform intra frequency handover to Cell 1.	<--	<i>RRConnectionReconfiguration</i>	-	-
10	Check: Does the UE transmit an <i>RRConnectionReconfigurationComplete</i> message on Cell 1 using dedicated preamble to confirm the successful completion of the intra frequency handover? Check2: Does the UE transmit an <i>RRConnectionReconfigurationComplete</i> using the security key derived from the <i>nextHopChainingCount</i> ?	-->	<i>RRConnectionReconfigurationComplete</i>	1,2	P
11	The SS changes Cell 1 and Cell 11 parameters and switches Cell 4 off according to the row "T3" in table 8.2.4.1.3.2-1.	-	-	-	-
12	The UE transmits a <i>MeasurementReport</i> message to report event A3 on Cell 1 with the measured RSRP, RSRQ value for Cell 11.	-->	<i>MeasurementReport</i>	-	-
13	The SS transmits an <i>RRConnectionReconfiguration</i> message to order the UE to perform intra frequency handover to Cell 11.	<--	<i>RRConnectionReconfiguration</i>	-	-
14	Check: Does the UE transmit an <i>RRConnectionReconfigurationComplete</i> message on Cell 11 using dedicated preamble to confirm the successful completion of the intra frequency handover? Check2: Does the UE transmit an <i>RRConnectionReconfigurationComplete</i> using the security key derived from the <i>nextHopChainingCount</i> ?	-->	<i>RRConnectionReconfigurationComplete</i>	1,2	P
14A	The UE transmit a TRACKING AREA UPDATE	-	-	-	-

	REQUEST message on Cell 11.				
14B	SS responds with a TRACKING AREA UPDATE ACCEPT message.	-	-	-	-
14C	The UE transmits a TRACKING AREA UPDATE COMPLETE message.	-	-	-	-
15	Check: Does the test result of generic test procedure in TS 36.508 subclause 6.4.2.3 indicate that the UE is in E-UTRA RRC_CONNECTED state on Cell 11?	-	-	1	-

8.2.4.1.3.3 Specific message contents

Table 8.2.4.1.3.3-1: RRCConnectionReconfiguration (step 1, Table 8.2.4.1.3.2-2)

Derivation Path: 36.508, Table 4.6.1-8, condition MEAS

Table 8.2.4.1.3.3-2: MeasConfig (Table 8.2.4.1.3.3-1)

Derivation Path: 36.508, Table 4.6.6-1			
Information Element	Value/remark	Comment	Condition
MeasConfig ::= SEQUENCE {			
measObjectToAddModList SEQUENCE (SIZE (1..maxObjectId)) OF SEQUENCE {	1 entry		
measObjectId[1]	IdMeasObject-f1		
measObject[1]	MeasObjectEUTRA-GENERIC(f1)		
}			
reportConfigToAddModList SEQUENCE (SIZE (1..maxReportConfigId)) OF SEQUENCE {	1 entry		
reportConfigId[1]	IdReportConfig-A3		
reportConfig[1]	ReportConfigEUTRA-A3		
}			
measIdToAddModList SEQUENCE (SIZE (1..maxMeasId)) OF SEQUENCE {	1 entry		
measId[1]	1		
measObjectId[1]	IdMeasObject-f1		
reportConfigId[1]	IdReportConfig-A3		
}			
}			

Table 8.2.4.1.3.3-3: MeasurementReport (step 4, Table 8.2.4.1.3.2-2)

Derivation Path: 36.508, Table 4.6.1-5			
Information Element	Value/remark	Comment	Condition
MeasurementReport ::= SEQUENCE {			
criticalExtensions CHOICE {			
c1 CHOICE{			
measurementReport-r8 SEQUENCE {			
measResults SEQUENCE {			
measId	1		
measResultServCell SEQUENCE {			
rsrpResult	(0..97)		
rsrqResult	(0..34)		
}			
measResultNeighCells CHOICE {			
measResultListEUTRA SEQUENCE (SIZE (1..maxCellReport)) OF SEQUENCE {	1 entry		
physCellId[1]	PhysicalCellIdentity of Cell 4		
cgi-Info[1]	Not present		
measResult[1] SEQUENCE {			
rsrpResult	(0..97)		
rsrqResult	(0..34)		
}			
}			
}			
}			
}			
}			
}			

Table 8.2.4.1.3.3-4: RRCConnectionReconfiguration (step 5, Table 8.2.4.1.3.2-2)

Derivation Path: 36.508, Table 4.6.1-8, condition HO
--

Table 8.2.4.1.3.3-5: MobilityControlInfo (Table 8.2.4.1.3.3-4)

Derivation Path: 36.508, Table 4.6.5-1			
Information Element	Value/remark	Comment	Condition
MobilityControlInfo ::= SEQUENCE {			
targetPhysCellId	PhysicalCellIdentity of Cell 4		
carrierFreq	Not present		
rach-ConfigDedicated SEQUENCE {			
ra-PreambleIndex	63		
ra-PRACH-MaskIndex	0		
}			
}			

Table 8.2.4.1.3.3-6: MeasurementReport (step 8, Table 8.2.4.1.3.2-2)

Derivation Path: 36.508, Table 4.6.1-5			
Information Element	Value/remark	Comment	Condition
MeasurementReport ::= SEQUENCE {			
criticalExtensions CHOICE {			
c1 CHOICE{			
measurementReport-r8 SEQUENCE {			
measResults SEQUENCE {			
measId	1		
measResultServCell SEQUENCE {			
rsrpResult	(0..97)		
rsrqResult	(0..34)		
}			
measResultNeighCells CHOICE {			
measResultListEUTRA SEQUENCE (SIZE (1..maxCellReport)) OF SEQUENCE {	1 entry		
physCellId[1]	PhysicalCellIdentity of Cell 1		
cgi-Info[1]	Not present		
measResult[1] SEQUENCE {			
rsrpResult	(0..97)		
rsrqResult	(0..34)		
}			
}			
}			
}			
}			
}			
}			

Table 8.2.4.1.3.3-7: RRCConnectionReconfiguration (step 9, Table 8.2.4.1.3.2-2)

Derivation Path: 36.508, Table 4.6.1-8, condition HO
--

Table 8.2.4.1.3.3-8: MobilityControlInfo (Table 8.2.4.1.3.3-7)

Derivation Path: 36.508, Table 4.6.5-1			
Information Element	Value/remark	Comment	Condition
MobilityControlInfo ::= SEQUENCE {			
targetPhysCellId	PhysicalCellIdentity of Cell 1		
carrierFreq	Not present		
rach-ConfigDedicated SEQUENCE {			
ra-PreambleIndex	63		-
ra-PRACH-MaskIndex	0		
}			
}			

Table 8.2.4.1.3.3-9: SecurityConfigHO (step 9, Table 8.2.4.1.3.2-2)

Derivation Path: 36.508, Table 4.6.4-1			
Information Element	Value/remark	Comment	Condition
SecurityConfigHO ::= SEQUENCE {			
handoverType CHOICE {			
intraLTE SEQUENCE {			
nextHopChainingCount	2		
}			
}			
}			

Table 8.2.4.1.3.3-10: MeasurementReport (step 12, Table 8.2.4.1.3.2-2)

Derivation Path: 36.508, Table 4.6.1-5			
Information Element	Value/remark	Comment	Condition
MeasurementReport ::= SEQUENCE {			
criticalExtensions CHOICE {			
c1 CHOICE{			
measurementReport-r8 SEQUENCE {			
measuredResults SEQUENCE {			
measId	1		
measResultServCell SEQUENCE {			
rsrpResult	(0..97)		
rsrqResult	(0..34)		
}			
measResultNeighCells CHOICE {			
measResultListEUTRA SEQUENCE (SIZE (1..maxCellReport)) OF SEQUENCE {	1 entry		
physCellId[1]	PhysicalCellIdentity of Cell 11		
cgi-Info[1]	Not present		
measResult[1] SEQUENCE {			
rsrpResult	(0..97)		
rsrqResult	(0..34)		
}			
}			
}			
}			
}			
}			
}			

Table 8.2.4.1.3.3-11: RRCConnectionReconfiguration (step 13, Table 8.2.4.1.3.2-2)

Derivation Path: 36.508, Table 4.6.1-8, condition HO
--

Table 8.2.4.1.3.3-12: MobilityControlInfo (Table 8.2.4.1.3.3-11)

Derivation Path: 36.508, Table 4.6.5-1			
Information Element	Value/remark	Comment	Condition
MobilityControlInfo ::= SEQUENCE {			
targetPhysCellId	PhysicalCellIdentity of Cell 11		
carrierFreq	Not present		
rach-ConfigDedicated SEQUENCE {			
ra-PreambleIndex	63		
ra-PRACH-MaskIndex	0		
}			
}			

Condition	Explanation
FDD	FDD cell environment
TDD	TDD cell environment

Table 8.2.4.1.3.3-13: *SecurityConfigHO* (Table 8.2.4.1.3.3-11)

Derivation Path: 36.508, Table 4.6.4-1			
Information Element	Value/remark	Comment	Condition
SecurityConfigHO ::= SEQUENCE {			
handoverType CHOICE {			
intraLTE SEQUENCE {			
nextHopChainingCount	3		
}			
}			
}			

8.2.4.2 RRC connection reconfiguration / Handover / Success / Common preamble

8.2.4.2.1 Test Purpose (TP)

(1)

```

with { UE having completed the radio bearer establishment and initial security activation procedure
and performed the intra frequency measurement }
ensure that {
  when { UE receives an RRCConnectionReconfiguration message including a mobilityControlInfo without
a rach-ConfigDedicated }
    then { UE transmits an RRCConnectionReconfigurationComplete message }
}

```

8.2.4.2.2 Conformance requirements

References: The conformance requirements covered in the present TC are specified in: TS 36.331, clauses 5.3.5.4, 5.3.10.4 and 5.3.10.6.

[TS 36.331, clause 5.3.5.4]

If the *RRCConnectionReconfiguration* message includes the *mobilityControlInfo* and the UE is able to comply with the configuration included in this message, the UE shall:

- 1> stop timer T310, if running;
- 1> start timer T304 with the timer value set to *t304*, as included in the *mobilityControlInfo*;
- 1> if the *carrierFreq* is included:
 - 2> consider the target cell to be one on the frequency indicated by the *carrierFreq* with a physical cell identity indicated by the *targetPhysCellId*;
- 1> else:
 - 2> consider the target cell to be one on the current frequency with a physical cell identity indicated by the *targetPhysCellId*;
- 1> start synchronising to the DL of the target cell;

NOTE 1: The UE should perform the handover as soon as possible following the reception of the RRC message triggering the handover, which could be before confirming successful reception (HARQ and ARQ) of this message.

- 1> reset MAC;
- 1> re-establish PDCP for all RBs that are established;

NOTE 2: The handling of the radio bearers after the successful completion of the PDCP re-establishment, e.g. the re-transmission of unacknowledged PDCP SDUs (as well as the associated status reporting), the handling of the SN and the HFN, is specified in TS 36.323 [8].

- 1> re-establish RLC for all RBs that are established;
- 1> apply the value of the *newUE-Identity* as the C-RNTI;

- 1> configure lower layers in accordance with the received *radioResourceConfigCommon*;
 - 1> configure lower layers in accordance with any additional fields, not covered in the previous, if included in the received *mobilityControlInfo*;
 - 1> if the *RRCCConnectionReconfiguration* message includes the *radioResourceConfigDedicated*:
 - 2> perform the radio resource configuration procedure as specified in 5.3.10;
 - 1> if the *keyChangeIndicator* received in the *securityConfigHO* is set to *TRUE*:
 - 2> update the K_{eNB} key based on the fresh K_{ASME} key taken into use with the previous successful NAS SMC procedure, as specified in TS 33.401 [32];
 - 1> else:
 - 2> update the K_{eNB} key based on the current K_{eNB} or the NH, using the *nextHopChainingCount* value indicated in the *securityConfigHO*, as specified in TS 33.401 [32];
 - 1> store the *nextHopChainingCount* value;
 - 1> if the *securityAlgorithmConfig* is included in the *securityConfigHO*:
 - 2> derive the K_{RRCint} key associated with the *integrityProtAlgorithm*, as specified in TS 33.401 [32];
 - 2> derive the K_{RRCenc} key and the K_{UPenc} key associated with the *cipheringAlgorithm*, as specified in TS 33.401 [32];
 - 1> else:
 - 2> derive the K_{RRCint} key associated with the current integrity algorithm, as specified in TS 33.401 [32];
 - 2> derive the K_{RRCenc} key and the K_{UPenc} key associated with the current ciphering algorithm, as specified in TS 33.401 [32];
 - 1> configure lower layers to apply the integrity protection algorithm and the K_{RRCint} key, i.e. the integrity protection configuration shall be applied to all subsequent messages received and sent by the UE, including the message used to indicate the successful completion of the procedure;
 - 1> configure lower layers to apply the ciphering algorithm, the K_{RRCenc} key and the K_{UPenc} key, i.e. the ciphering configuration shall be applied to all subsequent messages received and sent by the UE, including the message used to indicate the successful completion of the procedure;
 - 1> perform the measurement related actions as specified in 5.5.6.1;
 - 1> if the *RRCCConnectionReconfiguration* message includes the *measConfig*:
 - 2> perform the measurement configuration procedure as specified in 5.5.2;
 - 1> submit the *RRCCConnectionReconfigurationComplete* message to lower layers for transmission;
 - 1> if MAC successfully completes the random access procedure:
 - 2> stop timer T304;
 - 2> apply the parts of the CQI reporting configuration, the scheduling request configuration and the sounding RS configuration that do not require the UE to know the SFN of the target cell, if any;
 - 2> apply the parts of the measurement and the radio resource configuration that require the UE to know the SFN of the target cell (e.g. measurement gaps, periodic CQI reporting, scheduling request configuration, sounding RS configuration), if any, upon acquiring the SFN of the target cell;
- NOTE 3: Whenever the UE shall setup or reconfigure a configuration in accordance with a field that is received it applies the new configuration, except for the cases addressed by the above statements.
- 2> the procedure ends;

...

[TS 36.331, clause 5.3.10.4]

The UE shall:

- 1> reconfigure the MAC main configuration in accordance with the received *mac-MainConfig*;

[TS 36.331, clause 5.3.10.6]

The UE shall:

- 1> reconfigure the physical channel configuration in accordance with the received *physicalConfigDedicated*;
- 1> if the *antennaInfo* is included and set to '*explicitValue*':
 - 2> if the configured *transmissionMode* is not '*tm3*' or '*tm4*' release *ri-ConfigIndex* in *cqi-ReportPeriodic*, if previously configured;
- 1> else if the *antennaInfo* is included and set to '*defaultValue*':
 - 2> release *ri-ConfigIndex* in *cqi-ReportPeriodic*, if previously configured;

8.2.4.2.3 Test description

8.2.4.2.3.1 Pre-test conditions

System Simulator:

- Cell 1 and Cell 2.

UE:

None.

Preamble:

- The UE is in state Generic RB Established (state 3) on Cell 1 according to [18].

8.2.4.2.3.2 Test procedure sequence

Table 8.2.4.2.3.2-1 illustrates the downlink power levels and other changing parameters to be applied for the cells at various time instants of the test execution. Row marked "T0" denotes the initial conditions after preamble, while columns marked "T1" is to be applied subsequently. The exact instants on which these values shall be applied are described in the texts in this clause.

Table 8.2.4.2.3.2-1: Time instances of cell power level and parameter changes

	Parameter	Unit	Cell 1	Cell 2	Remark
T0	Cell-specific RS EPRE	dBm/15k Hz	-85	-91	The power level values are such that measurement results for Cell 1 (M1) and Cell 2 (M2) satisfy exit condition for event A3 ($M2 < M1$).
T1	Cell-specific RS EPRE	dBm/15k Hz	-85	-79	The power level values are such that measurement results for Cell 1 (M1) and Cell 2 (M2) satisfy entry condition for event A3 ($M2 > M1$).

Table 8.2.4.2.3.2-2: Main behaviour

St	Procedure	Message Sequence		TP	Verdict
		U - S	Message		
1	The SS transmits an <i>RRCCONNECTIONRECONFIGURATION</i> message on Cell 1 to setup intra frequency measurement.	<--	<i>RRCCONNECTIONRECONFIGURATION</i>	-	-
2	The UE transmits an <i>RRCCONNECTIONRECONFIGURATIONCOMPLETE</i> message on Cell 1.	-->	<i>RRCCONNECTIONRECONFIGURATIONCOMPLETE</i>	-	-
3	The SS changes Cell 1 and Cell 2 parameters according to the row "T1" in table 8.2.4.2.3.2-1.	-	-	-	-
4	The UE transmits a <i>MEASUREMENTREPORT</i> message on Cell 1 to report event A3 with the measured RSRP, RSRQ value for Cell 2.	-->	<i>MEASUREMENTREPORT</i>	-	-
5	The SS transmits an <i>RRCCONNECTIONRECONFIGURATION</i> message on Cell 1 to order the UE to perform intra frequency handover to Cell 2.	<--	<i>RRCCONNECTIONRECONFIGURATION</i>	-	-
6	Check: Does the UE transmit an <i>RRCCONNECTIONRECONFIGURATIONCOMPLETE</i> message on Cell 2 using common preamble to confirm the successful completion of the intra frequency handover?	-->	<i>RRCCONNECTIONRECONFIGURATIONCOMPLETE</i>	1	P
7	Check: Does the test result of generic test procedure in TS 36.508 subclause 6.4.2.3 indicate that the UE is in E-UTRA RRC_CONNECTED state on Cell 2?	-	-	1	-

8.2.4.2.3.3 Specific message contents

Table 8.2.4.2.3.3-1: *RRCCONNECTIONRECONFIGURATION* (step 1, Table 8.2.4.2.3.2-2)

Derivation Path: 36.508, Table 4.6.1-8, condition MEAS

Table 8.2.4.2.3.3-2: *MeasConfig* (Table 8.2.4.2.3.3-1)

Derivation Path: 36.508, Table 4.6.6-1			
Information Element	Value/remark	Comment	Condition
MeasConfig SEQUENCE {			
measObjectToAddModList SEQUENCE (SIZE (1..maxObjectld)) OF SEQUENCE {	1 entry		
measObjectld[1]	ldMeasObject-f1		
measObject[1]	MeasObjectEUTRA-GENERIC(f1)		
}			
reportConfigToAddModList SEQUENCE (SIZE (1..maxReportConfigld)) OF SEQUENCE {	1 entry		
reportConfigld[1]	ldReportConfig-A3		
reportConfig[1]	ReportConfigEUTRA-A3		
}			
measldToAddModList SEQUENCE (SIZE (1..maxMeasld)) OF SEQUENCE {	1 entry		
measld[1]	1		
measObjectld[1]	ldMeasObject-f1		
reportConfigld[1]	ldReportConfig-A3		
}			
}			

Table 8.2.4.2.3.3-3 MeasurementReport (step 4, Table 8.2.4.2.3.2-2)

Derivation Path: 36.508, Table 4.6.1-5			
Information Element	Value/remark	Comment	Condition
MeasurementReport ::= SEQUENCE {			
criticalExtensions CHOICE {			
c1 CHOICE{			
measurementReport-r8 SEQUENCE {			
measResults SEQUENCE {			
measId	1		
measResultServCell SEQUENCE {			
rsrpResult	(0..97)		
rsrqResult	(0..34)		
}			
measResultNeighCells CHOICE {			
measResultListEUTRA SEQUENCE (SIZE (1..maxCellReport)) OF SEQUENCE {	1 entry		
physCellId[1]	PhysicalCellIdentity of Cell 2		
cgi-Info[1]	Not present		
measResult[1] SEQUENCE {			
rsrpResult	(0..97)		
rsrqResult	(0..34)		
}			
}			
}			
}			
}			
}			
}			

Table 8.2.4.2.3.3-4: RRCConnectionReconfiguration (step 5, Table 8.2.4.2.3.2-2)

Derivation Path: 36.508, Table 4.6.1-8, condition HO
--

Table 8.2.4.2.3.3-5: MobilityControlInfo (Table 8.2.4.2.3.3-4)

Derivation Path: 36.508 clause 4.6.5-1			
Information Element	Value/remark	Comment	Condition
MobilityControlInfo ::= SEQUENCE {			
targetPhysCellId	PhysicalCellIdentity of Cell 2		
carrierFreq	Not present		
}			

8.2.4.3 RRC connection reconfiguration / Handover / Success / Intra-cell / Security reconfiguration

8.2.4.3.1 Test Purpose (TP)

(1)

```

with { UE having completed the radio bearer establishment and initial security activation procedure
}
ensure that {
  when { UE receives an RRCConnectionReconfiguration message including a securityConfigHO }
  then { UE transmits an RRCConnectionReconfigurationComplete message }
}

```

8.2.4.3.2 Conformance requirements

References: The conformance requirements covered in the present TC are specified in: TS 36.331, clauses 5.3.5.4.

[TS 36.331, clause 5.3.5.4]

If the *RRConnectionReconfiguration* message includes the *mobilityControlInfo* and the UE is able to comply with the configuration included in this message, the UE shall:

- 1> stop timer T310, if running;
- 1> start timer T304 with the timer value set to *t304*, as included in the *mobilityControlInfo*;
- 1> if the *carrierFreq* is included:
 - 2> consider the target cell to be one on the frequency indicated by the *eutra-CarrierFreq* with a physical cell identity indicated by the *targetPhysCellId*;
- 1> else:
 - 2> consider the target cell to be one on the current frequency with a physical cell identity indicated by the *targetPhysCellId*;
 - 1> start synchronising to the DL of the target cell;

NOTE 1: The UE should perform the handover as soon as possible following the reception of the RRC message triggering the handover, which could be before confirming successful reception (HARQ and ARQ) of this message.

- 1> reset MAC;
- 1> re-establish PDCP for all RBs that are established;

NOTE 2: The handling of the radio bearers after the successful completion of the PDCP re-establishment, e.g. the re-transmission of unacknowledged PDCP SDUs (as well as the associated status reporting), the handling of the SN and the HFN, is specified in TS 36.323 [8].

- 1> re-establish RLC for all RBs that are established;
- 1> apply the value of the *newUE-Identity*; as the C-RNTI
- 1> configure lower layers in accordance with the received *radioResourceConfigCommon*;
- 1> if the *RRConnectionReconfiguration* message includes the *radioResourceConfigDedicated*:
 - 2> perform the radio resource configuration procedure as specified in 5.3.10;
- 1> if the *keyChangeIndicator* received in the *securityConfigHO* is set to *TRUE*:
 - 2> update the K_{eNB} key based on the K_{ASME} key taken into use with the previous successful NAS SMC procedure, as specified in TS 33.401 [32];
- 1> else:
 - 2> update the K_{eNB} key based on the K_{ASME} key to which the current K_{eNB} is associated, using the *nextHopChainingCount* value indicated in the *securityConfigHO*, as specified in TS 33.401 [32];
- 1> store the *nextHopChainingCount* value;
- 1> if the *securityAlgorithmConfig* is included in the *securityConfigHO*:
 - 2> derive the K_{RRcint} key associated with the *integrityProtAlgorithm*, as specified in TS 33.401 [32];
 - 2> derive the K_{RRcenc} key and the K_{UPenc} key associated with the *cipheringAlgorithm*, as specified in TS 33.401 [32];
- 1> else:
 - 2> derive the K_{RRcint} key associated with the current integrity algorithm, as specified in TS 33.401 [32];
 - 2> derive the K_{RRcenc} key and the K_{UPenc} key associated with the current ciphering algorithm, as specified in TS 33.401 [32];

- 1> configure lower layers to apply the integrity protection algorithm and the K_{RRCint} key, i.e. the integrity protection configuration shall be applied to all subsequent messages received and sent by the UE, including the message used to indicate the successful completion of the procedure;
- 1> configure lower layers to apply the ciphering algorithm, the K_{RRCenc} key and the K_{UPenc} key, i.e. the ciphering configuration shall be applied to all subsequent messages received and sent by the UE, including the message used to indicate the successful completion of the procedure;
- 1> perform the measurement related actions as specified in 5.5.6.1;
- 1> if the *RRCCONNECTIONRECONFIGURATION* message includes the *measConfig*:
 - 2> perform the measurement configuration procedure as specified in 5.5.2;
- 1> submit the *RRCCONNECTIONRECONFIGURATIONCOMPLETE* message to lower layers for transmission;
- 1> if MAC successfully completes the random access procedure:
 - 2> stop timer T304;
 - 2> apply the parts of the configuration that do not require the UE to know the SFN of the target cell;
 - 2> apply the parts of the measurement and the radio resource configuration that require the UE to know the SFN of the target cell (e.g. measurement gaps, periodic CQI reporting, scheduling request configuration, sounding RS configuration), if any, upon acquiring the SFN of the target cell;
 - 2> the procedure ends;

...

8.2.4.3.3 Test description

8.2.4.3.3.1 Pre-test conditions

System Simulator:

- Cell 1.

UE:

None.

Preamble:

- The UE is in state Generic RB Established (state 3) on Cell 1 according to [18].

8.2.4.3.3.2 Test procedure sequence

Table 8.2.4.3.3.2-1: Main behaviour

St	Procedure	Message Sequence		TP	Verdict
		U - S	Message		
1	The SS transmits an AUTHENTICATION REQUEST message to initiate the EPS authentication and AKA procedure.	<--	<i>DLInformationTransfer</i>	-	-
2	The UE transmits an AUTHENTICATION RESPONSE message and re-establishes mutual authentication.	-->	<i>ULInformationTransfer</i>	-	-
3	The SS transmits a NAS SECURITY MODE COMMAND message to reactivate NAS security.	<--	<i>DLInformationTransfer</i>	-	-
4	The UE transmits a NAS SECURITY MODE COMPLETE message and re-establishes the security configuration.	-->	<i>ULInformationTransfer</i>	-	-
5	The SS transmits an <i>RRCCoReonfiguration</i> message to perform intra cell handover and security reconfiguration.	<--	<i>RRCCoReonfiguration</i>	-	-
6	Check: Does the UE transmit an <i>RRCCoReonfigurationComplete</i> message using the security key indicated by the <i>keyChangeIndicator</i> and <i>nextHopChainingCount</i> , as well as the indicated algorithms, to confirm the successful completion of the intra cell handover and security reconfiguration?	-->	<i>RRCCoReonfigurationComplete</i>	1	P
7	Check: Does the test result of generic test procedure in TS 36.508 subclause 6.4.2.3 indicate that the UE is in E-UTRA RRC_CONNECTED state?	-	-	1	-

8.2.4.3.3.3 Specific message contents

Table 8.2.4.3.3.3-1: *RRCCoReonfiguration* (step 5, Table 8.2.4.3.3.2-1)

Derivation Path: 36.508, Table 4.6.1-8, condition HO

Table 8.2.4.3.3.3-2: *MobilityControllInfo* (Table 8.2.4.3.3.3-1)

Derivation Path: 36.508, Table 4.6.5-1			
Information Element	Value/remark	Comment	Condition
<i>MobilityControllInfo</i> ::= SEQUENCE {			
<i>targetPhysCellId</i>	PhysicalCellId of Cell 1		
<i>carrierFreq</i>	Not present		
}			

Table 8.2.4.3.3.3-3: *SecurityConfigHO* (Table 8.2.4.3.3.3-1)

Derivation Path: 36.508, Table 4.6.4-1			
Information Element	Value/remark	Comment	Condition
<i>SecurityConfigHO</i> ::= SEQUENCE {			
<i>handoverType</i> CHOICE {			
<i>intraLTE</i> SEQUENCE {			
<i>keyChangeIndicator</i>	TRUE		
<i>nextHopChainingCount</i>	0		
}			
}			
}			

8.2.4.4 RRC connection reconfiguration / Handover / Failure / Intra-cell / Security reconfiguration

8.2.4.4.1 Test Purpose (TP)

(1)

```
with { UE having completed the radio bearer establishment and initial security activation procedure
and after receiving an RRCConnectionReconfiguration message including a SecurityConfigHO }
ensure that {
  when { UE detects handover failure and the initial cell is selectable }
  then { UE performs an RRC connection re-establishment procedure and remains in the E-UTRA
RRC_CONNECTED state }
}
```

8.2.4.4.2 Conformance requirements

References: The conformance requirements covered in the present TC are specified in: TS 36.331, clauses 5.3.5.3, 5.3.5.4, 5.3.5.6, 5.3.7.4 and 5.3.7.5.

[TS 36.331, clause 5.3.5.3]

If the *RRCConnectionReconfiguration* message does not include the *mobilityControlInfo* and the UE is able to comply with the configuration included in this message, the UE shall:

- 1> if this is the first *RRCConnectionReconfiguration* message after successful completion of the RRC Connection Re-establishment procedure:
 - 2> re-establish PDCP for SRB2 and for all DRBs that are established, if any;
 - 2> re-establish RLC for SRB2 and for all DRBs that are established, if any;
- 2> if the *RRCConnectionReconfiguration* message includes the *radioResourceConfigDedicated*:
 - 3> perform the radio resource configuration procedure as specified in 5.3.10;
- 2> resume SRB2 and all DRBs that are suspended, if any;

NOTE 1: The handling of the radio bearers after the successful completion of the PDCP re-establishment, e.g. the re-transmission of unacknowledged PDCP SDUs (as well as the associated status reporting), the handling of the SN and the HFN, is specified in TS 36.323 [8].

...

[TS 36.331, clause 5.3.5.4]

If the *RRCConnectionReconfiguration* message includes the *mobilityControlInfo* and the UE is able to comply with the configuration included in this message, the UE shall:

- 1> stop timer T310, if running;
- 1> start timer T304 with the timer value set to *t304*, as included in the *mobilityControlInfo*;
- 1> if the *carrierFreq* is included:
 - 2> consider the target cell to be one on the frequency indicated by the *carrierFreq* with a physical cell identity indicated by the *targetPhysCellId*;
- 1> else:
 - 2> consider the target cell to be one on the current frequency with a physical cell identity indicated by the *targetPhysCellId*;
- 1> start synchronising to the DL of the target cell;

NOTE 1: The UE should perform the handover as soon as possible following the reception of the RRC message triggering the handover, which could be before confirming successful reception (HARQ and ARQ) of this message.

1> reset MAC;

1> re-establish PDCP for all RBs that are established;

NOTE 2: The handling of the radio bearers after the successful completion of the PDCP re-establishment, e.g. the re-transmission of unacknowledged PDCP SDUs (as well as the associated status reporting), the handling of the SN and the HFN, is specified in TS 36.323 [8].

1> re-establish RLC for all RBs that are established;

1> apply the value of the *newUE-Identity* as the C-RNTI;

1> configure lower layers in accordance with the received *radioResourceConfigCommon*;

1> configure lower layers in accordance with any additional fields, not covered in the previous, if included in the received *mobilityControlInfo*;

1> if the *RRCCConnectionReconfiguration* message includes the *radioResourceConfigDedicated*:

2> perform the radio resource configuration procedure as specified in 5.3.10;

1> if the *keyChangeIndicator* received in the *securityConfigHO* is set to *TRUE*:

2> update the K_{eNB} key based on the fresh K_{ASME} key taken into use with the previous successful NAS SMC procedure, as specified in TS 33.401 [32];

1> else:

2> update the K_{eNB} key based on the current K_{eNB} or the NH, using the *nextHopChainingCount* value indicated in the *securityConfigHO*, as specified in TS 33.401 [32];

1> store the *nextHopChainingCount* value;

1> if the *securityAlgorithmConfig* is included in the *securityConfigHO*:

2> derive the K_{RRcint} key associated with the *integrityProtAlgorithm*, as specified in TS 33.401 [32];

2> derive the K_{RRcenc} key and the K_{UPenc} key associated with the *cipheringAlgorithm*, as specified in TS 33.401 [32];

1> else:

2> derive the K_{RRcint} key associated with the current integrity algorithm, as specified in TS 33.401 [32];

2> derive the K_{RRcenc} key and the K_{UPenc} key associated with the current ciphering algorithm, as specified in TS 33.401 [32];

1> configure lower layers to apply the integrity protection algorithm and the K_{RRcint} key, i.e. the integrity protection configuration shall be applied to all subsequent messages received and sent by the UE, including the message used to indicate the successful completion of the procedure;

1> configure lower layers to apply the ciphering algorithm, the K_{RRcenc} key and the K_{UPenc} key, i.e. the ciphering configuration shall be applied to all subsequent messages received and sent by the UE, including the message used to indicate the successful completion of the procedure;

1> perform the measurement related actions as specified in 5.5.6.1;

1> if the *RRCCConnectionReconfiguration* message includes the *measConfig*:

2> perform the measurement configuration procedure as specified in 5.5.2;

1> submit the *RRCCConnectionReconfigurationComplete* message to lower layers for transmission;

1> if MAC successfully completes the random access procedure:

2> stop timer T304;

- 2> apply the parts of the CQI reporting configuration, the scheduling request configuration and the sounding RS configuration that do not require the UE to know the SFN of the target cell, if any;
- 2> apply the parts of the measurement and the radio resource configuration that require the UE to know the SFN of the target cell (e.g. measurement gaps, periodic CQI reporting, scheduling request configuration, sounding RS configuration), if any, upon acquiring the SFN of the target cell;

NOTE 3: Whenever the UE shall setup or reconfigure a configuration in accordance with a field that is received it applies the new configuration, except for the cases addressed by the above statements.

- 2> the procedure ends;

...

[TS 36.331, clause 5.3.5.6]

The UE shall:

- 1> if T304 expires (handover failure):

NOTE: Following T304 expiry any dedicated preamble, if provided within the *rach-ConfigDedicated*, is not available for use by the UE anymore.

- 2> revert back to the configuration used in the source cell, excluding the configuration configured by the *physicalConfigDedicated*, the *mac-MainConfig* and the *sps-Config*;
- 2> initiate the connection re-establishment procedure as specified in 5.3.7, upon which the RRC connection reconfiguration procedure ends;

[TS 36.331, clause 5.3.7.4]

The UE shall set the contents of *RRCCConnectionReestablishmentRequest* message as follows:

- 1> set the *ue-Identity* as follows:

- 2> set the *c-RNTI* to the C-RNTI used in the source cell (handover and mobility from E-UTRA failure) or used in the cell in which the trigger for the re-establishment occurred (other cases);
- 2> set the *physCellId* to the physical cell identity of the source cell (handover and mobility from E-UTRA failure) or of the cell in which the trigger for the re-establishment occurred (other cases);
- 2> set the *shortMAC-I* to the 16 least significant bits of the MAC-I calculated:
 - 3> over the ASN.1 encoded as per section 8 (i.e., a multiple of 8 bits) *VarShortMAC-Input*;
 - 3> with the $K_{RRCCint}$ key and integrity protection algorithm that was used in the source cell (handover and mobility from E-UTRA failure) or of the cell in which the trigger for the re-establishment occurred (other cases); and
 - 3> with all input bits for COUNT, BEARER and DIRECTION set to binary ones;

- 1> set the *reestablishmentCause* as follows:

- 2> if the re-establishment procedure was initiated due to reconfiguration failure as specified in 5.3.5.5 (the UE is unable to comply with the reconfiguration):
 - 3> set the *reestablishmentCause* to the value '*reconfigurationFailure*';
- 2> else if the re-establishment procedure was initiated due to handover failure as specified in 5.3.5.6 (intra-LTE handover failure) or 5.4.3.5 (inter-RAT mobility from EUTRA failure):
 - 3> set the *reestablishmentCause* to the value '*handoverFailure*';
- 2> else:
 - 3> set the *reestablishmentCause* to the value '*otherFailure*';

The UE shall submit the *RRCCConnectionReestablishmentRequest* message to lower layers for transmission.

[TS 36.331, clause 5.3.7.5]

NOTE: Prior to this, lower layer signalling is used to allocate a C-RNTI. For further details see TS 36.321 [6];

The UE shall:

- 1> stop timer T301;
- 1> re-establish PDCP for SRB1;
- 1> re-establish RLC for SRB1;
- 1> perform the radio resource configuration procedure in accordance with the received *radioResourceConfigDedicated* and as specified in 5.3.10;
- 1> resume SRB1;
- 1> update the K_{eNB} key based on the K_{ASME} key to which the current K_{eNB} is associated, using the *nextHopChainingCount* value indicated in the *RRCConectionReestablishment* message, as specified in TS 33.401 [32];
- 1> store the *nextHopChainingCount* value;
- 1> derive the K_{RRCint} key associated with the previously configured integrity algorithm, as specified in TS 33.401 [32];
- 1> derive the K_{RRCenc} key and the K_{UPenc} key associated with the previously configured ciphering algorithm, as specified in TS 33.401 [32];
- 1> configure lower layers to activate integrity protection using the previously configured algorithm and the K_{RRCint} key immediately, i.e., integrity protection shall be applied to all subsequent messages received and sent by the UE, including the message used to indicate the successful completion of the procedure;
- 1> configure lower layers to apply ciphering using the previously configured algorithm, the K_{RRCenc} key and the K_{UPenc} key immediately, i.e., ciphering shall be applied to all subsequent messages received and sent by the UE, including the message used to indicate the successful completion of the procedure;
- 1> perform the measurement related actions as specified in 5.5.6.1;
- 1> submit the *RRCConectionReestablishmentComplete* message to lower layers for transmission, upon which the procedure ends;

8.2.4.4.3 Test description

8.2.4.4.3.1 Pre-test conditions

System Simulator:

- Cell 1.

UE:

None.

Preamble:

- The UE is in state Generic RB Established (state 3) according to [18].

8.2.4.4.3.2 Test procedure sequence

Table 8.2.4.4.3.2-1: Main behaviour

St	Procedure	Message Sequence		TP	Verdict
		U - S	Message		
1	The SS transmits an <i>RRCCONNECTIONRECONFIGURATION</i> message to perform intra cell handover and security reconfiguration.	<--	<i>RRCCONNECTIONRECONFIGURATION</i>	-	-
-	EXCEPTION: In parallel to the events described in step 2 the steps specified in Table 8.2.4.4.3.2-2 should take place.	-	-	-	-
2	Wait for 1 s to ensure that T304 expires.	-	-	-	-
3	Check: Does the UE transmit an <i>RRCCONNECTIONREESTABLISHMENTREQUEST</i> message?	-->	<i>RRCCONNECTIONREESTABLISHMENTREQUEST</i>	1	P
4	The SS transmits an <i>RRCCONNECTIONREESTABLISHMENT</i> message to resume SRB1 operation and reactivate security.	<--	<i>RRCCONNECTIONREESTABLISHMENT</i>	-	-
5	The UE transmits an <i>RRCCONNECTIONREESTABLISHMENTCOMPLETE</i> message.	-->	<i>RRCCONNECTIONREESTABLISHMENTCOMPLETE</i>	-	-
6	The SS transmits an <i>RRCCONNECTIONRECONFIGURATION</i> message to resume the existing radio bearer.	<--	<i>RRCCONNECTIONRECONFIGURATION</i>	-	-
7	The UE transmits an <i>RRCCONNECTIONRECONFIGURATIONCOMPLETE</i> message.	-->	<i>RRCCONNECTIONRECONFIGURATIONCOMPLETE</i>	-	-
8	Check: Does the test result of generic test procedure in TS 36.508 subclause 6.4.2.3 indicates that the UE is in E-UTRA RRC_CONNECTED state?	-	-	1	-

Table 8.2.4.4.3.2-2: Parallel behaviour

St	Procedure	Message Sequence		TP	Verdict
		U - S	Message		
-	EXCEPTION: The steps 1 and 2 below are repeated for the duration of T304.	-	-	-	-
1	The UE attempts to perform the intra cell handover using MAC Random Access Preamble.	-	-	-	-
2	The SS does not respond.	-	-	-	-

8.2.4.4.3.3 Specific message contents

Table 8.2.4.4.3.3-1: *RRCCONNECTIONRECONFIGURATION* (step 1, Table 8.2.4.4.3.2-1)

Derivation Path: 36.508, Table 4.6.1-8, condition HO
--

Table 8.2.4.4.3.3-2: *MOBILITYCONTROLLINFO* (Table 8.2.4.4.3.3-1)

Derivation Path: 36.508, Table 4.6.5-1			
Information Element	Value/remark	Comment	Condition
<i>MOBILITYCONTROLLINFO</i> ::= SEQUENCE {			
targetPhysCellId	PhysicalCellId of Cell 1		
carrierFreq	Not present		
}			

Table 8.2.4.4.3.3-3: *SecurityConfigHO* (Table 8.2.4.4.3.3-1)

Derivation Path: 36.508, Table 4.6.4-1			
Information Element	Value/remark	Comment	Condition
SecurityConfigHO ::= SEQUENCE {			
handoverType CHOICE {			
intraLTE SEQUENCE {			
nextHopChainingCount	2		
}			
}			
}			

Table 8.2.4.4.3.3-4: *RRCConnectionReestablishmentRequest* (step 3, Table 8.2.4.4.3.2-1)

Derivation Path: 36.508, Table 4.6.1-13			
Information Element	Value/remark	Comment	Condition
RRCConnectionReestablishmentRequest ::= SEQUENCE {			
criticalExtensions CHOICE {			
rrcConnectionReestablishmentRequest-r8 SEQUENCE {			
ue-Identity SEQUENCE {			
c-RNTI	the value of the C-RNTI of the UE		
physCellId	PhysicalCellIdentity of Cell 1		
shortMAC-I	The same value as the 16 least significant bits of the XMAC-I value calculated by SS.		
}			
reestablishmentCause	handoverFailure		
}			
}			
}			

Table 8.2.4.4.3.3-5: *RRCConnectionReconfiguration* (step 6, Table 8.2.4.4.3.2-1)

Derivation Path: 36.508, Table 4.6.1-8			
Information Element	Value/remark	Comment	Condition
RRCConnectionReconfiguration ::= SEQUENCE {			
criticalExtensions CHOICE {			
c1 CHOICE {			
rrcConnectionReconfiguration-r8 SEQUENCE {			
radioResourceConfigDedicated	RadioResourceConfigDedicated-HO		
}			
}			
}			
}			

8.2.4.5 RRC connection reconfiguration / Handover / All parameters included

8.2.4.5.1 Test Purpose (TP)

(1)

```

with { UE having completed the radio bearer establishment and initial security activation procedure
and performed the intra frequency measurement }
ensure that {
  when { UE receives an RRCConnectionReconfiguration message including a mobilityControlInfo is
provided with all parameters included }
  then { UE transmits an RRCConnectionReconfigurationComplete message }
}

```

8.2.4.5.2 Conformance requirements

References: The conformance requirements covered in the present TC are specified in: TS 36.331, clauses 5.3.5.4, 5.3.10.4 and 5.3.10.6.

[TS 36.331, clause 5.3.5.4]

If the *RRCConnectionReconfiguration* message includes the *mobilityControlInfo* and the UE is able to comply with the configuration included in this message, the UE shall:

- 1> stop timer T310, if running;
- 1> start timer T304 with the timer value set to *t304*, as included in the *mobilityControlInfo*;
- 1> if the *carrierFreq* is included:
 - 2> consider the target cell to be one on the frequency indicated by the *carrierFreq* with a physical cell identity indicated by the *targetPhysCellId*;
- 1> else:
 - 2> consider the target cell to be one on the current frequency with a physical cell identity indicated by the *targetPhysCellId*;
- 1> start synchronising to the DL of the target cell;

NOTE 1: The UE should perform the handover as soon as possible following the reception of the RRC message triggering the handover, which could be before confirming successful reception (HARQ and ARQ) of this message.

- 1> reset MAC;
- 1> re-establish PDCP for all RBs that are established;

NOTE 2: The handling of the radio bearers after the successful completion of the PDCP re-establishment, e.g. the re-transmission of unacknowledged PDCP SDUs (as well as the associated status reporting), the handling of the SN and the HFN, is specified in TS 36.323 [8].

- 1> re-establish RLC for all RBs that are established;
- 1> apply the value of the *newUE-Identity* as the C-RNTI;
- 1> configure lower layers in accordance with the received *radioResourceConfigCommon*;
- 1> configure lower layers in accordance with any additional fields, not covered in the previous, if included in the received *mobilityControlInfo*;
- 1> if the *RRCConnectionReconfiguration* message includes the *radioResourceConfigDedicated*:
 - 2> perform the radio resource configuration procedure as specified in 5.3.10;
- 1> if the *keyChangeIndicator* received in the *securityConfigHO* is set to *TRUE*:
 - 2> update the K_{eNB} key based on the fresh K_{ASME} key taken into use with the previous successful NAS SMC procedure, as specified in TS 33.401 [32];
- 1> else:
 - 2> update the K_{eNB} key based on the current K_{eNB} or the NH, using the *nextHopChainingCount* value indicated in the *securityConfigHO*, as specified in TS 33.401 [32];
- 1> store the *nextHopChainingCount* value;
- 1> if the *securityAlgorithmConfig* is included in the *securityConfigHO*:
 - 2> derive the K_{RRcInt} key associated with the *integrityProtAlgorithm*, as specified in TS 33.401 [32];

- 2> derive the K_{RRCEnc} key and the K_{UPenc} key associated with the *cipheringAlgorithm*, as specified in TS 33.401 [32];
 - 1> else:
 - 2> derive the K_{RRCint} key associated with the current integrity algorithm, as specified in TS 33.401 [32];
 - 2> derive the K_{RRCEnc} key and the K_{UPenc} key associated with the current ciphering algorithm, as specified in TS 33.401 [32];
 - 1> configure lower layers to apply the integrity protection algorithm and the K_{RRCint} key, i.e. the integrity protection configuration shall be applied to all subsequent messages received and sent by the UE, including the message used to indicate the successful completion of the procedure;
 - 1> configure lower layers to apply the ciphering algorithm, the K_{RRCEnc} key and the K_{UPenc} key, i.e. the ciphering configuration shall be applied to all subsequent messages received and sent by the UE, including the message used to indicate the successful completion of the procedure;
 - 1> perform the measurement related actions as specified in 5.5.6.1;
 - 1> if the *RRCCONNECTIONRECONFIGURATION* message includes the *measConfig*:
 - 2> perform the measurement configuration procedure as specified in 5.5.2;
 - 1> submit the *RRCCONNECTIONRECONFIGURATIONCOMPLETE* message to lower layers for transmission;
 - 1> if MAC successfully completes the random access procedure:
 - 2> stop timer T304;
 - 2> apply the parts of the CQI reporting configuration, the scheduling request configuration and the sounding RS configuration that do not require the UE to know the SFN of the target cell, if any;
 - 2> apply the parts of the measurement and the radio resource configuration that require the UE to know the SFN of the target cell (e.g. measurement gaps, periodic CQI reporting, scheduling request configuration, sounding RS configuration), if any, upon acquiring the SFN of the target cell;
- NOTE 3: Whenever the UE shall setup or reconfigure a configuration in accordance with a field that is received it applies the new configuration, except for the cases addressed by the above statements.
- 2> the procedure ends;

...

[TS 36.331, clause 5.3.10.4]

The UE shall:

- 1> reconfigure the MAC main configuration in accordance with the received *mac-MainConfig*;

[TS 36.331, clause 5.3.10.6]

The UE shall:

- 1> reconfigure the physical channel configuration in accordance with the received *physicalConfigDedicated*;
- 1> if the *antennaInfo* is included and set to 'explicitValue':
 - 2> if the configured *transmissionMode* is not 'tm3' or 'tm4' release *ri-ConfigIndex* in *cqi-ReportPeriodic*, if previously configured;
- 1> else if the *antennaInfo* is included and set to 'defaultValue':
 - 2> release *ri-ConfigIndex* in *cqi-ReportPeriodic*, if previously configured;

8.2.4.5.3 Test description

8.2.4.5.3.1 Pre-test conditions

System Simulator:

- Cell 1 and Cell 2.

UE:

None.

Preamble:

- The UE is in state Generic RB Established (state 3) on Cell 1 according to [18].

8.2.4.5.3.2 Test procedure sequence

Table 8.2.4.5.3.2-1 illustrates the downlink power levels and other changing parameters to be applied for the cells at various time instants of the test execution. Row marked "T0" denotes the initial conditions after preamble, while columns marked "T1" is to be applied subsequently. The exact instants on which these values shall be applied are described in the texts in this clause.

Table 8.2.4.5.3.2-1: Time instances of cell power level and parameter changes

	Parameter	Unit	Cell 1	Cell 2	Remark
T0	Cell-specific RS EPRE	dBm/15k Hz	-85	-91	The power level values are such that measurement results for Cell 1 (M1) and Cell 2 (M2) satisfy exit condition for event A3 ($M2 < M1$).
T1	Cell-specific RS EPRE	dBm/15k Hz	-85	-79	The power level values are such that measurement results for Cell 1 (M1) and Cell 2 (M2) satisfy entry condition for event A3 ($M2 > M1$).

Table 8.2.4.5.3.2-2: Main behaviour

St	Procedure	Message Sequence		TP	Verdict
		U - S	Message		
1	The SS transmits an <i>RRCCONNECTIONRECONFIGURATION</i> message on Cell 1 to setup intra frequency measurement.	<--	<i>RRCCONNECTIONRECONFIGURATION</i>	-	-
2	The UE transmits an <i>RRCCONNECTIONRECONFIGURATIONCOMPLETE</i> message on Cell 1 to confirm the setup of intra frequency measurement.	-->	<i>RRCCONNECTIONRECONFIGURATIONCOMPLETE</i>	-	-
3	The SS changes Cell 1 and Cell 2 parameters according to the row "T1" in table 8.2.4.5.3.2-1.	-	-	-	-
4	The UE transmits a <i>MEASUREMENTREPORT</i> message on Cell 1 to report event A3 with the measured RSRP and RSRQ values for Cell 2.	-->	<i>MEASUREMENTREPORT</i>	-	-
5	The SS transmits an <i>RRCCONNECTIONRECONFIGURATION</i> message on Cell 1 to order the UE to perform intra frequency handover to Cell 2.	<--	<i>RRCCONNECTIONRECONFIGURATION</i>	-	-
6	Check: Does the UE transmit an <i>RRCCONNECTIONRECONFIGURATIONCOMPLETE</i> message on Cell 2 to confirm the successful completion of the intra frequency handover?	-->	<i>RRCCONNECTIONRECONFIGURATIONCOMPLETE</i>	1	P
7	Check: Does the test result of generic test procedure in TS 36.508 subclause 6.4.2.3 indicate that the UE is in E-UTRA RRC_CONNECTED state on Cell 2?	-	-	1	-

8.2.4.5.3.3 Specific message contents

Table 8.2.4.5.3.3-1: RRCConnectionReconfiguration (step 1, Table 8.2.4.5.3.2-2)

Derivation Path: 36.508, Table 4.6.1-8, condition MEAS

Table 8.2.4.5.3.3-2: MeasConfig (Table 8.2.4.5.3.3-1)

Derivation Path: 36.508, Table 4.6.6-1			
Information Element	Value/remark	Comment	Condition
MeasConfig SEQUENCE {			
measObjectToAddModList SEQUENCE (SIZE (1..maxObjectId)) OF SEQUENCE {	1 entry		
measObjectId[1]	IdMeasObject-f1		
measObject[1]	MeasObjectEUTRA-GENERIC(f1)		
}			
reportConfigToAddModList SEQUENCE (SIZE (1..maxReportConfigId)) OF SEQUENCE {	1 entry		
reportConfigId[1]	IdReportConfig-A3		
reportConfig[1]	ReportConfigEUTRA-A3		
}			
measIdToAddModList SEQUENCE (SIZE (1..maxMeasId)) OF SEQUENCE {	1 entry		
measId[1]	1		
measObjectId[1]	IdMeasObject-f1		
reportConfigId[1]	IdReportConfig-A3		
}			
}			

Table 8.2.4.5.3.3-3: MeasurementReport (step 4, Table 8.2.4.5.3.2-2)

Derivation Path: 36.508, Table 4.6.1-5			
Information Element	Value/remark	Comment	Condition
MeasurementReport ::= SEQUENCE {			
criticalExtensions CHOICE {			
c1 CHOICE {			
measurementReport-r8 SEQUENCE {			
measResults SEQUENCE {			
measId	1		
measResultServCell SEQUENCE {			
rsrpResult	(0..97)		
rsrqResult	(0..34)		
}			
measResultNeighCells CHOICE {			
measResultListEUTRA SEQUENCE (SIZE (1..maxCellReport)) OF SEQUENCE {	1 entry		
physCellId[1]	PhysicalCellIdentity of Cell 2		
cgi-Info[1]	Not present		
measResult[1] SEQUENCE {			
rsrpResult	(0..97)		
rsrqResult	(0..34)		
}			
}			
}			
}			
}			
}			
}			
}			

Table 8.2.4.5.3.3-4: RRCConnectionReconfiguration (step 5, Table 8.2.4.5.3.2-2)

Derivation Path: 36.508, Table 4.6.1-8, condition HO

Table 8.2.4.5.3.3-5: MobilityControlInfo (Table 8.2.4.5.3.3-4)

Derivation Path: 36.331 clause 4.6.5-1			
Information Element	Value/remark	Comment	Condition
MobilityControlInfo ::= SEQUENCE {			
targetPhysCellId	PhysicalCellId of Cell 2		
carrierFreq SEQUENCE {			
dl-CarrierFreq	Same downlink EARFCN as used for Cell 2		
ul-CarrierFreq	Same uplink EARFCN as used for Cell 2		FDD
ul-CarrierFreq	Not present		TDD
}			
carrierBandwidth SEQUENCE {			
dl-Bandwidth	Same downlink system bandwidth as used for Cell 2		
ul-Bandwidth	Same uplink system bandwidth as used for Cell 2		FDD
ul-Bandwidth	Not present		TDD
}			
additionalSpectrumEmission	Same additionalSpectrumEmission as used for Cell 2		
t304	ms1000		
newUE-Identity	SS arbitrarily selects a value between '003C'H and 'FFF2'H.		
radioResourceConfigCommon SEQUENCE {			
rach-ConfigCommon	RACH-ConfigCommon-DEFAULT		
prach-Config	PRACH-Config-DEFAULT		
pdsch-ConfigCommon	PDSCH-ConfigCommon-DEFAULT		
pusch-ConfigCommon	PUSCH-ConfigCommon-DEFAULT		
phich-Config	PHICH-Config-DEFAULT		
pucch-ConfigCommon	PUCCH-ConfigCommon-DEFAULT		
soundingRS-UL-ConfigCommon	SoundingRsUL-ConfigCommon-DEFAULT		
uplinkPowerControlCommon	UplinkPowerControlCommon-DEFAULT		
antennaInfoCommon SEQUENCE {			
antennaPortsCount	an1		
}			
p-Max	Not present		
tdd-Config	Not present		FDD
	TDD-Config-DEFAULT		TDD
ul-CyclicPrefixLength	len1		
}			
rach-ConfigDedicated	Not present		
}			

Condition	Explanation
FDD	FDD cell environment
TDD	TDD cell environment

8.2.4.6 RRC connection reconfiguration / Handover / Success / Inter-frequency

8.2.4.6.1 Test Purpose (TP)

(1)

```
with { UE having completed the radio bearer establishment and initial security activation procedure
and performed the inter frequency measurement }
ensure that {
  when { UE receives an RRCCONNECTIONRECONFIGURATION message including a MOBILITYCONTROLINFO
indicating a different E-UTRA frequency}
  then { UE transmits an RRCCONNECTIONRECONFIGURATIONCOMPLETE message }
}
```

8.2.4.6.2 Conformance requirements

References: The conformance requirements covered in the present TC are specified in: TS 36.331, clauses 5.3.5.4, 5.3.10.4 and 5.3.10.6.

[TS 36.331, clause 5.3.5.4]

If the *RRCCONNECTIONRECONFIGURATION* message includes the *MOBILITYCONTROLINFO* and the UE is able to comply with the configuration included in this message, the UE shall:

- 1> stop timer T310, if running;
- 1> start timer T304 with the timer value set to *t304*, as included in the *MOBILITYCONTROLINFO*;
- 1> if the *CARRIERFREQ* is included:
 - 2> consider the target cell to be one on the frequency indicated by the *CARRIERFREQ* with a physical cell identity indicated by the *TARGETPHYSCELLID*;
- 1> else:
 - 2> consider the target cell to be one on the current frequency with a physical cell identity indicated by the *TARGETPHYSCELLID*;
- 1> start synchronising to the DL of the target cell;

NOTE 1: The UE should perform the handover as soon as possible following the reception of the RRC message triggering the handover, which could be before confirming successful reception (HARQ and ARQ) of this message.

- 1> reset MAC;
- 1> re-establish PDCP for all RBs that are established;

NOTE 2: The handling of the radio bearers after the successful completion of the PDCP re-establishment, e.g. the re-transmission of unacknowledged PDCP SDUs (as well as the associated status reporting), the handling of the SN and the HFN, is specified in TS 36.323 [8].

- 1> re-establish RLC for all RBs that are established;
- 1> apply the value of the *NEWUE-IDENTITY* as the C-RNTI;
- 1> configure lower layers in accordance with the received *RADIORESOURCECONFIGCOMMON*;
- 1> configure lower layers in accordance with any additional fields, not covered in the previous, if included in the received *MOBILITYCONTROLINFO*;
- 1> if the *RRCCONNECTIONRECONFIGURATION* message includes the *RADIORESOURCECONFIGDEDICATED*:

- 2> perform the radio resource configuration procedure as specified in 5.3.10;
 - 1> if the *keyChangeIndicator* received in the *securityConfigHO* is set to *TRUE*:
 - 2> update the K_{eNB} key based on the fresh K_{ASME} key taken into use with the previous successful NAS SMC procedure, as specified in TS 33.401 [32];
 - 1> else:
 - 2> update the K_{eNB} key based on the current K_{eNB} or the NH, using the *nextHopChainingCount* value indicated in the *securityConfigHO*, as specified in TS 33.401 [32];
 - 1> store the *nextHopChainingCount* value;
 - 1> if the *securityAlgorithmConfig* is included in the *securityConfigHO*:
 - 2> derive the K_{RRCint} key associated with the *integrityProtAlgorithm*, as specified in TS 33.401 [32];
 - 2> derive the K_{RRCenc} key and the K_{UPenc} key associated with the *cipheringAlgorithm*, as specified in TS 33.401 [32];
 - 1> else:
 - 2> derive the K_{RRCint} key associated with the current integrity algorithm, as specified in TS 33.401 [32];
 - 2> derive the K_{RRCenc} key and the K_{UPenc} key associated with the current ciphering algorithm, as specified in TS 33.401 [32];
 - 1> configure lower layers to apply the integrity protection algorithm and the K_{RRCint} key, i.e. the integrity protection configuration shall be applied to all subsequent messages received and sent by the UE, including the message used to indicate the successful completion of the procedure;
 - 1> configure lower layers to apply the ciphering algorithm, the K_{RRCenc} key and the K_{UPenc} key, i.e. the ciphering configuration shall be applied to all subsequent messages received and sent by the UE, including the message used to indicate the successful completion of the procedure;
 - 1> perform the measurement related actions as specified in 5.5.6.1;
 - 1> if the *RRCCConnectionReconfiguration* message includes the *measConfig*:
 - 2> perform the measurement configuration procedure as specified in 5.5.2;
 - 1> submit the *RRCCConnectionReconfigurationComplete* message to lower layers for transmission;
 - 1> if MAC successfully completes the random access procedure:
 - 2> stop timer T304;
 - 2> apply the parts of the CQI reporting configuration, the scheduling request configuration and the sounding RS configuration that do not require the UE to know the SFN of the target cell, if any;
 - 2> apply the parts of the measurement and the radio resource configuration that require the UE to know the SFN of the target cell (e.g. measurement gaps, periodic CQI reporting, scheduling request configuration, sounding RS configuration), if any, upon acquiring the SFN of the target cell;
- NOTE 3: Whenever the UE shall setup or reconfigure a configuration in accordance with a field that is received it applies the new configuration, except for the cases addressed by the above statements.
- 2> the procedure ends;

...

[TS 36.331, clause 5.3.10.4]

The UE shall:

- 1> reconfigure the MAC main configuration in accordance with the received *mac-MainConfig*;

[TS 36.331, clause 5.3.10.6]

The UE shall:

- 1> reconfigure the physical channel configuration in accordance with the received physicalConfigDedicated;
- 1> if the antennaInfo is included and set to 'explicitValue':
 - 2> if the configured *transmissionMode* is not 'tm3' or 'tm4' release *ri-ConfigIndex* in *cqi-ReportPeriodic*, if previously configured;
- 1> else if the *antennaInfo* is included and set to 'defaultValue':
 - 2> release *ri-ConfigIndex* in *cqi-ReportPeriodic*, if previously configured;

8.2.4.6.3 Test description

8.2.4.6.3.1 Pre-test conditions

System Simulator:

- Cell 1 and Cell 3.
- System information combination 3 as defined in TS 36.508 [18] clause 4.4.3.1 is used in E-UTRA cells.

UE:

None.

Preamble:

- The UE is in state Generic RB Established (state 3) on Cell 1 according to [18].

8.2.4.6.3.2 Test procedure sequence

Table 8.2.4.6.3.2-1 illustrates the downlink power levels and other changing parameters to be applied for the cells at various time instants of the test execution. Row marked "T0" denotes the initial conditions after preamble, while columns marked "T1" is to be applied subsequently. The exact instants on which these values shall be applied are described in the texts in this clause.

Table 8.2.4.6.3.2-1: Time instances of cell power level and parameter changes

	Parameter	Unit	Cell 1	Cell 3	Remark
T0	Cell-specific RS EPRE	dBm/15k Hz	-85	-97	The power level values are such that measurement results for Cell 1 (M1) and Cell 3 (M3) satisfy exit condition for event A3 ($M3 < M1$).
T1	Cell-specific RS EPRE	dBm/15k Hz	-85	-73	The power level values are such that measurement results for Cell 1 (M1) and Cell 3 (M3) satisfy entry condition for event A3 ($M3 > M1$).

Table 8.2.4.6.3.2-2: Main behaviour

St	Procedure	Message Sequence		TP	Verdict
		U - S	Message		
1	The SS transmits an <i>RRConnectionReconfiguration</i> message on Cell 1 to setup inter frequency measurement.	<--	<i>RRConnectionReconfiguration</i>	-	-
2	The UE transmits an <i>RRConnectionReconfigurationComplete</i> message on Cell 1.	-->	<i>RRConnectionReconfigurationComplete</i>	-	-
3	The SS changes Cell 1 and Cell 3 parameters according to the row "T1" in table 8.2.4.6.3.2-1.	-	-	-	-
4	The UE transmits a <i>MeasurementReport</i> message on Cell 1 to report event A3 with the measured RSRP, RSRQ value for Cell 3.	-->	<i>MeasurementReport</i>	-	-
5	The SS transmits an <i>RRConnectionReconfiguration</i> message on Cell 1 to order the UE to perform inter frequency handover to Cell 3.	<--	<i>RRConnectionReconfiguration</i>	-	-
6	Check: Does the UE transmit an <i>RRConnectionReconfigurationComplete</i> message on Cell 3 to confirm the successful completion of the inter frequency handover?	-->	<i>RRConnectionReconfigurationComplete</i>	1	P
7	Check: Does the test result of generic test procedure in TS 36.508 subclause 6.4.2.3 indicates that the UE is in E-UTRA RRC_CONNECTED state on Cell 3?	-	-	1	-

8.2.4.6.3.3 Specific message contents

Table 8.2.4.6.3.3-1: *RRConnectionReconfiguration* (step 1, Table 8.2.4.6.3.2-2)

Derivation Path: 36.508, Table 4.6.1-8, condition MEAS

Table 8.2.4.6.3.3-2: *MeasConfig* (Table 8.2.4.6.3.3-1)

Derivation Path: 36.508, Table 4.6.6-1 condition INTER-FREQ			
Information Element	Value/remark	Comment	Condition
MeasConfig SEQUENCE {			
measObjectToAddModList SEQUENCE (SIZE (1..maxObjectId)) OF SEQUENCE {	2 entries		
measObjectId[1]	IdMeasObject-f1		
measObject[1]	MeasObjectEUTRA-GENERIC(f1)		
measObjectId[2]	IdMeasObject-f2		
measObject[2]	MeasObjectEUTRA-GENERIC(f2)		
}			
reportConfigToAddModList SEQUENCE (SIZE (1..maxReportConfigId)) OF SEQUENCE {	1 entry		
reportConfigId[1]	IdReportConfig-A3		
reportConfig[1]	ReportConfigEUTRA-A3		
}			
measIdToAddModList SEQUENCE (SIZE (1..maxMeasId)) OF SEQUENCE {	1 entry		
measId[1]	1		
measObjectId[1]	IdMeasObject-f2		
reportConfigId[1]	IdReportConfig-A3		
}			
}			

Table 8.2.4.6.3.3-3: MeasurementReport (step 4, Table 8.2.4.6.3.2-2)

Derivation Path: 36.508, Table 4.6.1-5			
Information Element	Value/remark	Comment	Condition
MeasurementReport ::= SEQUENCE {			
criticalExtensions CHOICE {			
c1 CHOICE{			
measurementReport-r8 SEQUENCE {			
measResults SEQUENCE {			
measId	1		
measResultServCell SEQUENCE {			
rsrpResult	(0..97)		
rsrqResult	(0..34)		
}			
measResultNeighCells CHOICE {			
measResultListEUTRA SEQUENCE (SIZE (1..maxCellReport)) OF SEQUENCE {	1 entry		
physCellId[1]	PhysicalCellIdentity of Cell 3		
cgi-Info[1]	Not present		
measResult[1] SEQUENCE {			
rsrpResult	(0..97)		
rsrqResult	(0..34)		
}			
}			
}			
}			
}			
}			
}			

Table 8.2.4.6.3.3-4: RRCConnectionReconfiguration (step 5, Table 8.2.4.6.3.2-2)

Derivation Path: 36.508, Table 4.6.1-8, condition HO
--

Table 8.2.4.6.3.3-5: MobilityControlInfo (Table 8.2.4.6.3.3-5)

Derivation Path: 36.508, Table 4.6.5-1			
Information Element	Value/remark	Comment	Condition
MobilityControlInfo ::= SEQUENCE {			
targetPhysCellId	PhysicalCellIdentity of Cell 3		
carrierFreq SEQUENCE {			
dl-CarrierFreq	Same downlink EARFCN as used for Cell 3		
ul-CarrierFreq	Not present		
}			
}			

8.2.4.7 RRC connection reconfiguration / Handover / Failure / Re-establishment successful

8.2.4.7.1 Test Purpose (TP)

(1)

```

with { UE having completed the radio bearer establishment and initial security activation procedure
and after receiving an RRCConnectionReconfiguration message including a mobilityControlInfo
indicating a different E-UTRA cell having attempted intra frequency handover }
ensure that {
  when { UE detects handover failure and the initial cell is selectable }
  then { UE performs an RRC connection re-establishment procedure and remains in the E-UTRA
RRC_CONNECTED state }

```



```
    }
```

(2)

```
with { UE having transmitted an RRCCConnectionReestablishmentRequest message }
ensure that {
  when { UE receives an RRCCConnectionReestablishment message with a nextHopChainingCount which is
different from the NCC associated with the currently active  $K_{eNB}$  }
  then { UE derives new  $K_{eNB}$  from the nextHopChainingCount }
}
```

(3)

```
with { UE having transmitted an RRCCConnectionReestablishmentRequest message }
ensure that {
  when { UE receives an RRCCConnectionReestablishment message with a nextHopChainingCount which is
same as the NCC associated with the currently active  $K_{eNB}$  }
  then { UE derives new  $K_{eNB}$  from the currently active  $K_{eNB}$  }
}
```

8.2.4.7.2 Conformance requirements

References: The conformance requirements covered in the present TC are specified in: TS 36.331, clauses 5.3.5.4, 5.3.5.6, 5.3.7.2, 5.3.7.4, 5.3.7.5, 5.3.10.4 and 5.3.10.6.

[TS 36.331, clause 5.3.5.4]

If the *RRCCConnectionReconfiguration* message includes the *mobilityControlInfo* and the UE is able to comply with the configuration included in this message, the UE shall:

- 1> stop timer T310, if running;
- 1> start timer T304 with the timer value set to *t304*, as included in the *mobilityControlInfo*;
- 1> if the *carrierFreq* is included:
 - 2> consider the target cell to be one on the frequency indicated by the *carrierFreq* with a physical cell identity indicated by the *targetPhysCellId*;
- 1> else:
 - 2> consider the target cell to be one on the current frequency with a physical cell identity indicated by the *targetPhysCellId*;
- 1> start synchronising to the DL of the target cell;

NOTE 1: The UE should perform the handover as soon as possible following the reception of the RRC message triggering the handover, which could be before confirming successful reception (HARQ and ARQ) of this message.

- 1> reset MAC;
- 1> re-establish PDCP for all RBs that are established;

NOTE 2: The handling of the radio bearers after the successful completion of the PDCP re-establishment, e.g. the re-transmission of unacknowledged PDCP SDUs (as well as the associated status reporting), the handling of the SN and the HFN, is specified in TS 36.323 [8].

- 1> re-establish RLC for all RBs that are established;
- 1> apply the value of the *newUE-Identity* as the C-RNTI;
- 1> configure lower layers in accordance with the received *radioResourceConfigCommon*;
- 1> configure lower layers in accordance with any additional fields, not covered in the previous, if included in the received *mobilityControlInfo*;
- 1> if the *RRCCConnectionReconfiguration* message includes the *radioResourceConfigDedicated*:
 - 2> perform the radio resource configuration procedure as specified in 5.3.10;

- 1> if the *keyChangeIndicator* received in the *securityConfigHO* is set to *TRUE*:
 - 2> update the K_{eNB} key based on the fresh K_{ASME} key taken into use with the previous successful NAS SMC procedure, as specified in TS 33.401 [32];
- 1> else:
 - 2> update the K_{eNB} key based on the current K_{eNB} or the NH, using the *nextHopChainingCount* value indicated in the *securityConfigHO*, as specified in TS 33.401 [32];
- 1> store the *nextHopChainingCount* value;
- 1> if the *securityAlgorithmConfig* is included in the *securityConfigHO*:
 - 2> derive the K_{RRcint} key associated with the *integrityProtAlgorithm*, as specified in TS 33.401 [32];
 - 2> derive the K_{RRcenc} key and the K_{UPenc} key associated with the *cipheringAlgorithm*, as specified in TS 33.401 [32];
- 1> else:
 - 2> derive the K_{RRcint} key associated with the current integrity algorithm, as specified in TS 33.401 [32];
 - 2> derive the K_{RRcenc} key and the K_{UPenc} key associated with the current ciphering algorithm, as specified in TS 33.401 [32];
- 1> configure lower layers to apply the integrity protection algorithm and the K_{RRcint} key, i.e. the integrity protection configuration shall be applied to all subsequent messages received and sent by the UE, including the message used to indicate the successful completion of the procedure;
- 1> configure lower layers to apply the ciphering algorithm, the K_{RRcenc} key and the K_{UPenc} key, i.e. the ciphering configuration shall be applied to all subsequent messages received and sent by the UE, including the message used to indicate the successful completion of the procedure;
- 1> perform the measurement related actions as specified in 5.5.6.1;
- 1> if the *RRCConnectionReconfiguration* message includes the *measConfig*:
 - 2> perform the measurement configuration procedure as specified in 5.5.2;
- 1> submit the *RRCConnectionReconfigurationComplete* message to lower layers for transmission;
- 1> if MAC successfully completes the random access procedure:
 - 2> stop timer T304;
 - 2> apply the parts of the CQI reporting configuration, the scheduling request configuration and the sounding RS configuration that do not require the UE to know the SFN of the target cell, if any;
 - 2> apply the parts of the measurement and the radio resource configuration that require the UE to know the SFN of the target cell (e.g. measurement gaps, periodic CQI reporting, scheduling request configuration, sounding RS configuration), if any, upon acquiring the SFN of the target cell;

NOTE 3: Whenever the UE shall setup or reconfigure a configuration in accordance with a field that is received it applies the new configuration, except for the cases addressed by the above statements.

- 2> the procedure ends;

...

[TS 36.331, clause 5.3.5.6]

The UE shall:

- 1> if T304 expires (handover failure):

NOTE: Following T304 expiry any dedicated preamble, if provided within the *rach-ConfigDedicated*, is not available for use by the UE anymore.

- 2> revert back to the configuration used in the source cell, excluding the configuration configured by the *physicalConfigDedicated*, the *mac-MainConfig* and the *sps-Config*;
- 2> initiate the connection re-establishment procedure as specified in 5.3.7, upon which the RRC connection reconfiguration procedure ends;

[TS 36.331, clause 5.3.7.2]

The UE shall only initiate the procedure when AS security has been activated. The UE initiates the procedure when one of the following conditions is met:

...

- 1> upon handover failure, in accordance with 5.3.5.6; or

...

Upon initiation of the procedure, the UE shall:

- 1> stop timer T310, if running;
- 1> start timer T311;
- 1> suspend all RBs except SRB0;
- 1> reset MAC;
- 1> apply the default physical channel configuration as specified in 9.2.4;
- 1> apply the default semi-persistent scheduling configuration as specified in 9.2.3;
- 1> apply the default MAC main configuration as specified in 9.2.2;
- 1> perform cell selection in accordance with the cell selection process as specified in TS 36.304 [4];

[TS 36.331, clause 5.3.7.4]

The UE shall set the contents of *RRCConnectionReestablishmentRequest* message as follows:

- 1> set the *ue-Identity* as follows:
 - 2> set the *c-RNTI* to the C-RNTI used in the source cell (handover and mobility from E-UTRA failure) or used in the cell in which the trigger for the re-establishment occurred (other cases);
 - 2> set the *physCellId* to the physical cell identity of the source cell (handover and mobility from E-UTRA failure) or of the cell in which the trigger for the re-establishment occurred (other cases);
 - 2> set the *shortMAC-I* to the 16 least significant bits of the MAC-I calculated:
 - 3> over the ASN.1 encoded as per section 8 (i.e., a multiple of 8 bits) *VarShortMAC-Input*;
 - 3> with the K_{RRCint} key and integrity protection algorithm that was used in the source cell (handover and mobility from E-UTRA failure) or of the cell in which the trigger for the re-establishment occurred (other cases); and
 - 3> with all input bits for COUNT, BEARER and DIRECTION set to binary ones;
- 1> set the *reestablishmentCause* as follows:
 - 2> if the re-establishment procedure was initiated due to reconfiguration failure as specified in 5.3.5.5 (the UE is unable to comply with the reconfiguration):
 - 3> set the *reestablishmentCause* to the value '*reconfigurationFailure*';
 - 2> else if the re-establishment procedure was initiated due to handover failure as specified in 5.3.5.6 (intra-LTE handover failure) or 5.4.3.5 (inter-RAT mobility from EUTRA failure):
 - 3> set the *reestablishmentCause* to the value '*handoverFailure*';

...

The UE shall submit the *RRCCConnectionReestablishmentRequest* message to lower layers for transmission.

[TS 36.331, clause 5.3.7.5]

NOTE: Prior to this, lower layer signalling is used to allocate a C-RNTI. For further details see TS 36.321 [6];

The UE shall:

- 1> stop timer T301;
- 1> re-establish PDCP for SRB1;
- 1> re-establish RLC for SRB1;
- 1> perform the radio resource configuration procedure in accordance with the received *radioResourceConfigDedicated* and as specified in 5.3.10;
- 1> resume SRB1;
- 1> update the K_{eNB} key based on the K_{ASME} key to which the current K_{eNB} is associated, using the *nextHopChainingCount* value indicated in the *RRCCConnectionReestablishment* message, as specified in TS 33.401 [32];
- 1> store the *nextHopChainingCount* value;
- 1> derive the K_{RRCint} key associated with the previously configured integrity algorithm, as specified in TS 33.401 [32];
- 1> derive the K_{RRCenc} key and the K_{UPenc} key associated with the previously configured ciphering algorithm, as specified in TS 33.401 [32];
- 1> configure lower layers to activate integrity protection using the previously configured algorithm and the K_{RRCint} key immediately, i.e., integrity protection shall be applied to all subsequent messages received and sent by the UE, including the message used to indicate the successful completion of the procedure;
- 1> configure lower layers to apply ciphering using the previously configured algorithm, the K_{RRCenc} key and the K_{UPenc} key immediately, i.e., ciphering shall be applied to all subsequent messages received and sent by the UE, including the message used to indicate the successful completion of the procedure;
- 1> perform the measurement related actions as specified in 5.5.6.1;
- 1> submit the *RRCCConnectionReestablishmentComplete* message to lower layers for transmission, upon which the procedure ends;

[TS 36.331, clause 5.3.10.4]

The UE shall:

- 1> reconfigure the MAC main configuration in accordance with the received *mac-MainConfig*;

[TS 36.331, clause 5.3.10.6]

The UE shall:

- 1> reconfigure the physical channel configuration in accordance with the received *physicalConfigDedicated*;
- 1> if the *antennaInfo* is included and set to 'explicitValue':
 - 2> if the configured *transmissionMode* is not 'tm3' or 'tm4' release *ri-ConfigIndex* in *cqi-ReportPeriodic*, if previously configured;
- 1> else if the *antennaInfo* is included and set to 'defaultValue':
 - 2> release *ri-ConfigIndex* in *cqi-ReportPeriodic*, if previously configured;

8.2.4.7.3 Test description

8.2.4.7.3.1 Pre-test conditions

System Simulator:

- Cell 1, Cell 4 and Cell 11.

UE:

None.

Preamble:

- The UE is in state Generic RB Established (state 3) on Cell 1 according to [18].

8.2.4.7.3.2 Test procedure sequence

Table 8.2.4.7.3.2-1 illustrates the downlink power levels and other changing parameters to be applied for the cells at various time instants of the test execution. Row marked "T0" denotes the initial conditions after preamble, while columns marked "T1", "T2", "T3", "T4", "T5" and "T6" are to be applied subsequently. The exact instants on which these values shall be applied are described in the texts in this clause.

Table 8.2.4.7.3.2-1: Time instances of cell power level and parameter changes

	Parameter	Unit	Cell 1	Cell 4	Cell 11	Remark
T0	Cell-specific RS EPRE	dBm/15kHz	-85	-91	-91	The power level values are such that measurement results for Cell 1 (M1) Cell 4 (M4) and Cell 11(M11) satisfy exit condition for event A3 ($M4 < M1$ and $M11 < M1$).
T1	Cell-specific RS EPRE	dBm/15kHz	-85	-79	-91	The power level values are such that measurement results for Cell 1 (M1) and Cell 4 (M4) satisfy entry condition for event A3 ($M4 > M1$).
T2	Cell-specific RS EPRE	dBm/15kHz	"Off"	-79	"Off"	The power level values are assigned to satisfy $SrxlevCell\ 1 < 0$ and $SrxlevCell\ 11 < 0$ such that selecting Cell 4 is guaranteed (NOTE 1).
T3	Cell-specific RS EPRE	dBm/15kHz	-73	-79	"Off"	The power level values are such that measurement results for Cell 1 (M1) and Cell 4 (M4) satisfy entry condition for event A3 ($M1 > M4$). (NOTE 1).
T4	Cell-specific RS EPRE	dBm/15kHz	-73	"Off"	"Off"	The power level values are assigned to satisfy $SrxlevCell\ 4 < 0$ and $SrxlevCell\ 11 < 0$ such that selecting Cell 1 is guaranteed. (NOTE 1).
T5	Cell-specific RS EPRE	dBm/15kHz	-73	"Off"	-67	The power level values are such that measurement results for Cell 1 (M1) and Cell 11 (M11) satisfy entry condition for event A3 ($M11 > M1$). (NOTE 1).
T6	Cell-specific RS EPRE	dBm/15kHz	"Off"	"Off"	-67	The power level values are assigned to satisfy $SrxlevCell\ 1 < 0$ and $SrxlevCell\ 4 < 0$ such that selecting Cell 11 is guaranteed. (NOTE 1).

NOTE 1: Power level "Off" is defined in TS36.508 Table 6.2.2.1-1.

Table 8.2.4.7.3.2-2: Main behaviour

St	Procedure	Message Sequence		TP	Verdict
		U - S	Message		
1	The SS transmits an <i>RRConnectionReconfiguration</i> message to setup intra frequency measurement on Cell 1.	<--	<i>RRConnectionReconfiguration</i>	-	-
2	The UE transmits an <i>RRConnectionReconfigurationComplete</i> message on Cell 1.	-->	<i>RRConnectionReconfigurationComplete</i>	-	-
3	The SS changes Cell 1, Cell 4 and Cell 11 parameters according to the row "T1" in table 8.2.4.7.3.2-1.	-	-	-	-
4	The UE transmits a <i>MeasurementReport</i> message on Cell 1 to report event A3 with the measured RSRP, RSRQ value for Cell 4.	-->	<i>MeasurementReport</i>	-	-
5	The SS transmits an <i>RRConnectionReconfiguration</i> message on Cell 1 to order the UE to perform intra frequency handover to Cell 4.	<--	<i>RRConnectionReconfiguration</i>	-	-
-	EXCEPTION: In parallel to the events described in step 6 the steps specified in Table 8.2.4.7.3.2-3 should take place.	-	-	-	-
6	The SS changes Cell 1, Cell 4 and Cell 11 parameters according to the row "T2" in table 8.2.4.7.3.2-1.	-	-	-	-
7	Check: Does the UE transmit an <i>RRConnectionReestablishmentRequest</i> message on Cell 4?	-->	<i>RRConnectionReestablishmentRequest</i>	1	P
8	The SS transmits an <i>RRConnectionReestablishment</i> message to resume SRB1 operation and re-activate security on Cell 4.	<--	<i>RRConnectionReestablishment</i>	-	-
9	Check: Does the UE transmit an <i>RRConnectionReestablishmentComplete</i> message using the security key derived from the currently active K_{eNB} on Cell 4?	-->	<i>RRConnectionReestablishmentComplete</i>	3	P
10	The SS transmits an <i>RRConnectionReconfiguration</i> message to resume existing radio bearer on Cell 4.	<--	<i>RRConnectionReconfiguration</i>	-	-
11	The UE transmits an <i>RRConnectionReconfigurationComplete</i> message on Cell 4.	-->	<i>RRConnectionReconfigurationComplete</i>	-	-
12	The SS changes Cell 1, Cell 4 and Cell 11 parameters according to the row "T3" in table 8.2.4.7.3.2-1.	-	-	-	-
13	The UE transmits a <i>MeasurementReport</i> message on Cell 4 to report event A3 with the measured RSRP, RSRQ value for Cell 1.	-->	<i>MeasurementReport</i>	-	-
14	The SS transmits an <i>RRConnectionReconfiguration</i> message on Cell 4 to order the UE to perform intra frequency handover to Cell 1.	<--	<i>RRConnectionReconfiguration</i>	-	-
-	EXCEPTION: In parallel to the events described in step 15 the steps specified in Table 8.2.4.7.3.2-4 should take place.	-	-	-	-
15	The SS changes Cell 1, Cell 4 and Cell 11 parameters according to the row "T4" in table 8.2.4.7.3.2-1.	-	-	-	-
16	Check: Does the UE transmit an <i>RRConnectionReestablishmentRequest</i> message on Cell 1?	-->	<i>RRConnectionReestablishmentRequest</i>	1	P
17	The SS transmits an <i>RRConnectionReestablishment</i> message to resume SRB1 operation and re-activate security on Cell 1.	<--	<i>RRConnectionReestablishment</i>	-	-
18	Check: Does the UE transmit an	-->	<i>RRConnectionReestablishment</i>	2	P

	<i>RRConnectionReestablishmentComplete</i> message using the security key derived from the <i>nextHopChainingCount</i> on Cell 1?		<i>Complete</i>		
19	The SS transmits an <i>RRConnectionReconfiguration</i> message to resume existing radio bearer on Cell 1.	<--	<i>RRConnectionReconfiguration</i>	-	-
20	The UE transmits an <i>RRConnectionReconfigurationComplete</i> message on Cell 1.	-->	<i>RRConnectionReconfigurationComplete</i>	-	-
21	The SS changes Cell 1, Cell 4 and Cell 11 parameters according to the row "T5" in table 8.2.4.7.3.2-1.	-	-	-	-
22	The UE transmits a <i>MeasurementReport</i> message on Cell 1 to report event A3 with the measured RSRP, RSRQ value for Cell 11.	-->	<i>MeasurementReport</i>	-	-
23	The SS transmits an <i>RRConnectionReconfiguration</i> message on Cell 1 to order the UE to perform intra frequency handover to Cell 11.	<--	<i>RRConnectionReconfiguration</i>	-	-
-	EXCEPTION: In parallel to the events described in step 24 the steps specified in Table 8.2.4.7.3.2-5 should take place.	-	-	-	-
24	The SS changes Cell 1, Cell 4 and Cell 11 parameters according to the row "T6" in table 8.2.4.7.3.2-1.	-	-	-	-
25	Check: Does the UE transmit an <i>RRConnectionReestablishmentRequest</i> message on Cell 11?	-->	<i>RRConnectionReestablishmentRequest</i>	1	P
26	The SS transmits an <i>RRConnectionReestablishment</i> message to resume SRB1 operation and re-activate security on Cell 11.	<--	<i>RRConnectionReestablishment</i>	-	-
27	Check: Does the UE transmit an <i>RRConnectionReestablishmentComplete</i> message using the security key derived from the <i>nextHopChainingCount</i> on Cell 11?	-->	<i>RRConnectionReestablishmentComplete</i>	2	P
28	The SS transmits an <i>RRConnectionReconfiguration</i> message to resume existing radio bearer on Cell 11.	<--	<i>RRConnectionReconfiguration</i>	-	-
29	The UE transmits an <i>RRConnectionReconfigurationComplete</i> message on Cell 11.	-->	<i>RRConnectionReconfigurationComplete</i>	-	-
29A	The UE transmit a TRACKING AREA UPDATE REQUEST message on Cell 11.	-	-	-	-
29B	SS responds with TRACKING AREA UPDATE ACCEPT message.	-	-	-	-
29C	The UE transmits a TRACKING AREA UPDATE COMPLETE.	-	-	-	-
30	Check: Does the test result of generic test procedure in TS 36.508 subclause 6.4.2.3 indicate that the UE is in E-UTRA RRC_CONNECTED state on Cell 11?	-	-	1	-

Table 8.2.4.7.3.2-3: Parallel behaviour

St	Procedure	Message Sequence		TP	Verdict
		U - S	Message		
-	EXCEPTION: The steps 1 and 2 below are repeated for the duration of T304.	-	-	-	-
1	The UE attempts to perform the intra frequency handover using MAC Random Access Preamble on Cell 4.	-	-	-	-
2	The SS does not respond.	-	-	-	-

Table 8.2.4.7.3.2-4: Parallel behaviour

St	Procedure	Message Sequence		TP	Verdict
		U - S	Message		
-	EXCEPTION: The steps 1 and 2 below are repeated for the duration of T304.	-	-	-	-
1	The UE attempts to perform the intra frequency handover using MAC Random Access Preamble on Cell 1.	-	-	-	-
2	The SS does not respond.	-	-	-	-

Table 8.2.4.7.3.2-5: Parallel behaviour

St	Procedure	Message Sequence		TP	Verdict
		U - S	Message		
-	EXCEPTION: The steps 1 and 2 below are repeated for the duration of T304.	-	-	-	-
1	The UE attempts to perform the intra frequency handover using MAC Random Access Preamble on Cell 11.	-	-	-	-
2	The SS does not respond.	-	-	-	-

8.2.4.7.3.3 Specific message contents

Table 8.2.4.7.3.3-0: *SystemInformationBlockType2* for Cell 1, cell 4 and Cell 11 (preamble and all the steps in Table 8.2.4.7.3.2-2)

Derivation Path: 36.508, Table 4.6.3-12			
Information Element	Value/remark	Comment	Condition
ra-SupervisionInfo SEQUENCE {			
preambleTransMax	n50		
}			

Table 8.2.4.7.3.3-1: *RRCConnectionReconfiguration* (step 1, Table 8.2.4.7.3.2-2)

Derivation Path: 36.508, Table 4.6.1-8, condition MEAS
--

Table 8.2.4.7.3.3-2: *MeasConfig* (Table 8.2.4.7.3.3-1)

Derivation Path: 36.508, Table 4.6.6-1			
Information Element	Value/remark	Comment	Condition
MeasConfig SEQUENCE {			
measObjectToAddModList SEQUENCE (SIZE (1..maxObjectId)) OF SEQUENCE {	1 entry		
measObjectId[1]	IdMeasObject-f1		
measObject[1]	MeasObjectEUTRA-GENERIC(f1)		
}			
reportConfigToAddModList SEQUENCE (SIZE (1..maxReportConfigId)) OF SEQUENCE {	1 entry		
reportConfigId[1]	IdReportConfig-A3		
reportConfig[1]	ReportConfigEUTRA-A3		
}			
measIdToAddModList SEQUENCE (SIZE (1..maxMeasId)) OF SEQUENCE {	1 entry		
measId[1]	1		
measObjectId[1]	IdMeasObject-f1		
reportConfigId[1]	IdReportConfig-A3		
}			
}			

Table 8.2.4.7.3.3-3: MeasurementReport (step 4, Table 8.2.4.7.3.2-2)

Derivation Path: 36.508, Table 4.6.1-5			
Information Element	Value/remark	Comment	Condition
MeasurementReport ::= SEQUENCE {			
criticalExtensions CHOICE {			
c1 CHOICE{			
measurementReport-r8 SEQUENCE {			
measResults SEQUENCE {			
measId	1		
measResultServCell SEQUENCE {			
rsrpResult	(0..97)		
rsrqResult	(0..34)		
}			
measResultNeighCells CHOICE {			
measResultListEUTRA SEQUENCE (SIZE (1..maxCellReport)) OF SEQUENCE {	1 entry		
physCellId[1]	PhysicalCellIdentity of Cell 4		
cgi-Info[1]	Not present		
measResult[1] SEQUENCE {			
rsrpResult	(0..97)		
rsrqResult	(0..34)		
}			
}			
}			
}			
}			
}			
}			

Table 8.2.4.7.3.3-4: RRCConnectionReconfiguration (step 5, Table 8.2.4.7.3.2-2)

Derivation Path: 36.508, Table 4.6.1-8, condition HO
--

Table 8.2.4.7.3.3-5: MobilityControlInfo (Table 8.2.4.7.3.3-4)

Derivation Path: 36.308, Table 4.6.5-1			
Information Element	Value/remark	Comment	Condition
MobilityControlInfo ::= SEQUENCE {			
targetPhysCellId	PhysicalCellIdentity of Cell 4		
carrierFreq	Not present		
rach-ConfigDedicated SEQUENCE {			
ra-PreambleIndex	63		
ra-PRACH-MaskIndex	0		
}			
}			

Table 8.2.4.7.3.3-6: RRCConnectionReestablishmentRequest (step 7, Table 8.2.4.7.3.2-2)

Derivation Path: 36.508, Table 4.6.1-13			
Information Element	Value/remark	Comment	Condition
RRCConnectionReestablishmentRequest ::= SEQUENCE {			
criticalExtensions CHOICE {			
rrcConnectionReestablishmentRequest-r8			
SEQUENCE {			
ue-Identity SEQUENCE {			
c-RNTI	the value of the C-RNTI of the UE		
physCellId	PhysicalCellIdentity of Cell 1		
shortMAC-I	The same value as the 16 least significant bits of the XMAC-I value calculated by SS.		
}			
reestablishmentCause	handoverFailure		
}			
}			

Table 8.2.4.7.3.3-7: RRCConnectionReestablishment (step 8, Table 8.2.4.7.3.2-2)

Derivation Path: 36.508, Table 4.6.1-10			
Information Element	Value/remark	Comment	Condition
RRCConnectionReestablishment ::= SEQUENCE {			
criticalExtensions CHOICE {			
c1 CHOICE{			
rrcConnectionReestablishment-r8 SEQUENCE {			
nextHopChainingCount	0		
}			
}			
}			
}			

Table 8.2.4.7.3.3-8: RRCConnectionReconfiguration (step 10, step 19 and step 28, Table 8.2.4.7.3.2-2)

Derivation Path: 36.508, Table 4.6.1-8			
Information Element	Value/remark	Comment	Condition
RRCConnectionReconfiguration ::= SEQUENCE {			
criticalExtensions CHOICE {			
c1 CHOICE{			
rrcConnectionReconfiguration-r8 SEQUENCE {			
radioResourceConfigDedicated	RadioResourceConfigDedicated-HO		
}			
}			
}			
}			

Table 8.2.4.7.3.3-9: MeasurementReport (step 13, Table 8.2.4.7.3.2-2)

Derivation Path: 36.508, Table 4.6.1-5			
Information Element	Value/remark	Comment	Condition
MeasurementReport ::= SEQUENCE {			
criticalExtensions CHOICE {			
c1 CHOICE{			
measurementReport-r8 SEQUENCE {			
measResults SEQUENCE {			
measId	1		
measResultServCell SEQUENCE {			
rsrpResult	(0..97)		
rsrqResult	(0..34)		
}			
measResultNeighCells CHOICE {			
measResultListEUTRA SEQUENCE (SIZE (1..maxCellReport)) OF SEQUENCE {	1 entry		
physCellId[1]	PhysicalCellIdentity of Cell 1		
cgi-Info[1]	Not present		
measResult[1] SEQUENCE {			
rsrpResult	(0..97)		
rsrqResult	(0..34)		
}			
}			
}			
}			
}			
}			
}			

Table 8.2.4.7.3.3-10: RRCConnectionReconfiguration (step 14, Table 8.2.4.7.3.2-2)

Derivation Path: 36.508, Table 4.6.1-8, condition HO
--

Table 8.2.4.7.3.3-11: MobilityControlInfo (Table 8.2.4.7.3.3-10)

Derivation Path: 36.308, Table 4.6.5-1			
Information Element	Value/remark	Comment	Condition
MobilityControlInfo ::= SEQUENCE {			
targetPhysCellId	PhysicalCellIdentity of Cell 1		
carrierFreq	Not present		
rach-ConfigDedicated SEQUENCE {			
ra-PreambleIndex	63		
ra-PRACH-MaskIndex	0		
}			
}			

Table 8.2.4.7.3.3-12: RRCConnectionReestablishmentRequest (step 16, Table 8.2.4.7.3.2-2)

Derivation Path: 36.508, Table 4.6.1-13			
Information Element	Value/remark	Comment	Condition
RRCConnectionReestablishmentRequest ::= SEQUENCE {			
criticalExtensions CHOICE {			
rrcConnectionReestablishmentRequest-r8			
SEQUENCE {			
ue-Identity SEQUENCE {			
c-RNTI	the value of the C-RNTI of the UE		
physCellId	PhysicalCellIdentity of Cell 4		
shortMAC-I	The same value as the 16 least significant bits of the XMAC-I value calculated by SS.		
}			
reestablishmentCause	handoverFailure		
}			
}			

Table 8.2.4.7.3.3-13: RRCConnectionReestablishment (step 17, Table 8.2.4.7.3.2-2)

Derivation Path: 36.508, Table 4.6.1-10			
Information Element	Value/remark	Comment	Condition
RRCConnectionReestablishment ::= SEQUENCE {			
criticalExtensions CHOICE {			
c1 CHOICE{			
rrcConnectionReestablishment-r8 SEQUENCE {			
nextHopChainingCount	2		
}			
}			
}			
}			

Table 8.2.4.7.3.3-14: MeasurementReport (step 22, Table 8.2.4.7.3.2-2)

Derivation Path: 36.508, Table 4.6.1-5			
Information Element	Value/remark	Comment	Condition
MeasurementReport ::= SEQUENCE {			
criticalExtensions CHOICE {			
c1 CHOICE{			
measurementReport-r8 SEQUENCE {			
measResults SEQUENCE {			
measId	1		
measResultServCell SEQUENCE {			
rsrpResult	(0..97)		
rsrqResult	(0..34)		
}			
measResultNeighCells CHOICE {			
measResultListEUTRA SEQUENCE (SIZE (1..maxCellReport)) OF SEQUENCE {	1 entry		
physCellId[1]	PhysicalCellIdentity of Cell 11		
cgi-Info[1]	Not present		
measResult[1] SEQUENCE {			
rsrpResult	(0..97)		
rsrqResult	(0..34)		
}			
}			
}			
}			
}			
}			
}			

Table 8.2.4.7.3.3-15: RRCConnectionReconfiguration (step 23, Table 8.2.4.7.3.2-2)

Derivation Path: 36.508, Table 4.6.1-8, condition HO
--

Table 8.2.4.7.3.3-16: MobilityControlInfo (Table 8.2.4.7.3.3-15)

Derivation Path: 36.308, Table 4.6.5-1			
Information Element	Value/remark	Comment	Condition
MobilityControlInfo ::= SEQUENCE {			
targetPhysCellId	PhysicalCellIdentity of Cell 11		
carrierFreq	Not present		
rach-ConfigDedicated SEQUENCE {			
ra-PreambleIndex	63		
ra-PRACH-MaskIndex	0		
}			
}			

Table 8.2.4.7.3.3-17: RRCConnectionReestablishmentRequest (step 25, Table 8.2.4.7.3.2-2)

Derivation Path: 36.508, Table 4.6.1-13			
Information Element	Value/remark	Comment	Condition
RRCConnectionReestablishmentRequest ::= SEQUENCE {			
criticalExtensions CHOICE {			
rrcConnectionReestablishmentRequest-r8			
SEQUENCE {			
ue-Identity SEQUENCE {			
c-RNTI	the value of the C-RNTI of the UE		
physCellId	PhysicalCellIdentity of Cell 1		
shortMAC-I	The same value as the 16 least significant bits of the XMAC-I value calculated by SS.		
}			
reestablishmentCause	handoverFailure		
}			
}			

Table 8.2.4.7.3.3-18: RRCConnectionReestablishment (step 26, Table 8.2.4.7.3.2-2)

Derivation Path: 36.508, Table 4.6.1-10			
Information Element	Value/remark	Comment	Condition
RRCConnectionReestablishment ::= SEQUENCE {			
criticalExtensions CHOICE {			
c1 CHOICE{			
rrcConnectionReestablishment-r8 SEQUENCE {			
nextHopChainingCount	3		
}			
}			
}			
}			

8.2.4.8 RRC connection reconfiguration / Handover / Failure / Re-establishment failure

8.2.4.8.1 Test Purpose (TP)

(1)

```

with { UE having completed the radio bearer establishment and initial security activation procedure
and after receiving an RRCConnectionReconfiguration message including an IE
mobilityControlInformation indicating a different E-UTRA cell having attempted intra frequency
handover }
ensure that {
  when { UE detects handover failure and fails an RRC connection re-establishment procedure }
    then { UE enters the E-UTRA RRC_IDLE state and trigger TAU procedure in order to recover RRC
connection }
}

```

8.2.4.8.2 Conformance requirements

References: The conformance requirements covered in the present TC are specified in: 3GPP TS 36.331 clauses 5.3.5.4, 5.3.5.6, 5.3.7.2, 5.3.7.3, 5.3.7.4, 5.3.7.7 and 5.3.12.

[TS 36.331, clause 5.3.5.4]

...

If the *RRCConnectionReconfiguration* message includes the *mobilityControlInformation* and the UE is able to comply with the configuration included in this message, the UE shall:

1> stop timer T310, if running;

1> start timer T304 with the timer value set to t304, as included in the *mobilityControlInformation*;

1> request PDCP to initiate the PDCP Re-establishment procedure for all RBs that are established;

NOTE 2: The handling of the radio bearers after the successful completion of the L2 re-establishment, e.g. the re-transmission of unacknowledged PDCP SDUs (as well as the associated status reporting), the handling of the SN and the HFN, is specified in [8].

1> reset MAC and re-establish RLC for all RBs that are established;

1> If the *RRCConnectionReconfiguration* message includes the *radioResourceConfiguration*:

2> perform the Radio resource configuration procedure as specified in 5.3.10;

1> set the C-RNTI to the value of the *newUE-Identity*;

1> if the *eutra-CarrierFreq* is included:

2> consider the target cell to be one on the frequency indicated by the *eutra-CarrierFreq* with a physical cell identity indicated by the *targetCellIdentity*;

1> else:

2> consider the target cell to be one on the current frequency with a physical cell identity indicated by the *targetCellIdentity*;

1> if the *dl-Bandwidth* is included:

2> for the target cell, apply the downlink bandwidth indicated by the *dl-Bandwidth*;

1> else:

2> for the target cell, apply the same downlink bandwidth as for the current cell;

1> if the *ul-Bandwidth* is included:

2> for the target cell, apply the uplink bandwidth indicated by the *ul-Bandwidth*;

1> else:

2> for the target cell, apply the same uplink bandwidth as for the current cell;

1> configure lower layers in accordance with the received *radioResourceConfigCommon*;

1> If the *RRCConnectionReconfiguration* message includes the *securityConfiguration*:

2> apply the AS-derived keys associated with the AS-base key indicated by the *keyIndicator*;

2> configure lower layers to apply the indicated integrity protection algorithm, i.e. the indicated integrity protection configuration shall be applied to all subsequent messages received and sent by the UE in the target cell, including the message used to indicate the successful completion of the procedure;

2> configure lower layers to apply the indicated ciphering algorithm, i.e. the indicated ciphering configuration shall be applied to all subsequent messages received and sent by the UE in the target cell, including the message used to indicate the successful completion of the procedure;

1> If the *RRCConnectionReconfiguration* message includes the *measurementConfiguration*:

2> perform the Measurement configuration procedure as specified in 5.5.2;

1> synchronise to the DL of the target cell;

1> submit the *RRCConnectionReconfigurationComplete* message to lower layers for transmission using the new configuration;

1> If MAC successfully completes the random access procedure:

- 2> stop timer T304;
- 2> If the *physicalConfigDedicated* is included in the *RRCConnectionReconfiguration* message:
 - 3> If the UE needs the SFN of the target cell to apply the PUCCH and Sounding RS configuration:
 - 4> apply the new PUCCH and Sounding RS configuration upon acquiring the SFN of the target cell;
 - 3> else:
 - 4> apply the new PUCCH and Sounding RS configuration;
- 2> indicate to PDCP to complete the PDCP Re-establishment procedure for all DRBs that are established, if any;
- 2> the procedure ends.

...

[TS 36.331, clause 5.3.5.6]

The UE shall:

- 1> If T304 expires (handover failure):

NOTE 1: Following T304 expiry dedicated preambles, if provided within the *rach-ConfigDedicated*, are not available for use by the UE anymore.

- 2> revert back to the configuration used in the source cell, excluding the physical layer configuration;

NOTE 2: The UE reverts to the RRC configuration as well as the layer 2 configuration (PDCP/RLC/MAC) used in the source cell.

- 2> initiate the connection re-establishment procedure as specified in 5.3.7, upon which the RRC connection reconfiguration procedure ends.

[TS 36.331, clause 5.3.7.2]

The UE shall only initiate the procedure when security has been activated. The UE initiates the procedure when one of the following conditions is met:

...

- 1> upon handover failure, in accordance with 5.3.5.6; or

...

Upon initiation of the procedure, the UE shall:

...

- 1> start timer T311;

- 1> request PDCP to initiate the PDCP Re-establishment procedure for all RBs that are established;

NOTE 1: The handling of the radio bearers after the successful completion of the L2 re-establishment, e.g. the re-transmission of unacknowledged PDCP SDUs (as well as the associated status reporting), the handling of the SN and the HFN, is specified in [8].

- 1> reset MAC and re-establish RLC for all RBs that are established;

- 1> select a suitable cell in accordance with the cell selection process as specified in [4];

[TS 36.331, clause 5.3.7.3]

...

- 2> initiate transmission of the *RRCConnectionReestablishmentRequest* message in accordance with 5.3.7.4;

...

[TS 36.331, clause 5.3.7.4]

The UE shall set the contents of *RRCCConnectionReestablishmentRequest* message as follows:

1> set the IE *ue-Identity* as follows:

- 2> set the *c-RNTI* to the C-RNTI used in the source cell (handover failure case) or used in the cell in which the trigger for the re-establishment occurred (other cases);
- 2> set the *cellIdentity* to the Physical layer identity of the source cell (handover failure case) or of the cell in which the trigger for the re-establishment occurred (other cases);
- 2> set the *shortMAC-I* to the 16 least significant bits of the MAC-I calculated:
 - 3> over the concatenation of the ASN.1 encoded *CellIdentity* of the current cell, *PhysicalCellIdentity* of the cell the UE was connected to prior to the failure and C-RNTI that the UE had in the cell it was connected to prior to the failure;
 - 3> with the integrity protection key and integrity protection algorithm that was used in the cell the UE was connected to prior to the failure; and
 - 3> with all input bits for COUNT, BEARER and DIRECTION set to binary ones.

1> set the IE *reestablishmentCause* as follows:

...

- 2> else if the re-establishment procedure was initiated due to handover failure as specified in 5.3.5.6 (intra-LTE handover failure) or 5.4.3.5 (inter-RAT mobility from EUTRA failure):
 - 3> set the *reestablishmentCause* to the value '*handoverFailure*';

...

The UE shall submit the *RRCCConnectionReestablishmentRequest* message to lower layers for transmission.

[TS 36.331, clause 5.3.7.7]

Upon T311 expiry, the UE shall:

- 1> perform the actions upon moving from RRC_CONNECTED to RRC_IDLE as specified in 5.3.12.

...

[TS 36.331, clause 5.3.12]

Upon moving from RRC_CONNECTED to RRC_IDLE, the UE shall:

- 1> reset MAC and re-establish RLC for all RBs that are established;

...

- 1> stop all timers that are running except T320;
- 1> release all radio resources, including release of the RLC entity and the associated PDCP entity for all established RBs;
- 1> indicate the release of the RRC connection to upper layers;
- 1> enter RRC_IDLE.

8.2.4.8.3 Test description

8.2.4.8.3.1 Pre-test conditions

System Simulator:

- Cell 1 and Cell 2

UE:

None.

Preamble:

- The UE is in state Generic RB Established (state 3) on Cell 1 according to [18].

8.2.4.8.3.2 Test procedure sequence

Table 8.2.4.8.3.2-1 illustrates the downlink power levels and other changing parameters to be applied for the cells at various time instants of the test execution. Row marked "T0" denotes the initial conditions, while columns marked "T1" and "T2" are to be applied subsequently. The exact instants on which these values shall be applied are described in the texts in this clause.

Table 8.2.4.8.3.2-1: Time instances of cell power level and parameter changes

	Parameter	Unit	Cell 1	Cell 2	Remark
T0	Cell-specific RS EPRE	dBm/15 kHz	-85	-91	The power level values are such that measurement results for Cell 1 (M1) and Cell 2 (M2) satisfy entry condition for event A3 (M1 > M2)
T1	Cell-specific RS EPRE	dBm/15 kHz	-85	-79	The power level values are such that measurement results for Cell 1 (M1) and Cell 2 (M2) satisfy entry condition for event A3 (M2 > M1)
T2	Cell-specific RS EPRE	dBm/15 kHz	-85	"Off"	The power level values are such that $Srxlev_{Cell\ 1} > Srxlev_{Cell\ 2}$ and $Srxlev_{Cell\ 2} < 0$. (NOTE 1).
NOTE 1: Power level "Off" is defined in TS36.508 Table 6.2.2.1-1.					

Table 8.2.4.8.3.2-2: Main behaviour

St	Procedure	Message Sequence		TP	Verdict
		U - S	Message		
1	The SS transmits an <i>RRConnectionReconfiguration</i> message to setup intra frequency measurement on Cell 1.	<--	<i>RRConnectionReconfiguration</i>	-	-
2	The UE transmits an <i>RRConnectionReconfigurationComplete</i> message on Cell 1.	-->	<i>RRConnectionReconfigurationComplete</i>	-	-
3	The SS changes Cell 1 and Cell 2 parameters according to the row "T1" in table 8.2.4.8.3.2-1.	-	-	-	-
4	The UE transmits a <i>MeasurementReport</i> message on Cell 1 to report event A3 with the measured RSRP and RSRQ value for Cell 2.	-->	<i>MeasurementReport</i>	-	-
5	The SS transmits an <i>RRConnectionReconfiguration</i> message on Cell 1 to order the UE to perform intra frequency handover to Cell 2.	<--	<i>RRConnectionReconfiguration</i>	-	-
-	EXCEPTION: In parallel to the events described in step 6 the steps specified in Table 8.2.4.8.3.2-3 should take place.	-	-	-	-
6	The SS changes Cell 1 and Cell 2 parameters according to the row "T2" in table 8.2.4.8.3.2-1.	-	-	-	-
7	The UE transmits an <i>RRConnectionReestablishmentRequest</i> message on Cell 1.	-->	<i>RRConnectionReestablishmentRequest</i>	-	-
8	The SS does not respond to any <i>RRConnectionReestablishmentRequest</i> message and waits for 1s to ensure that T301 expires and the UE goes to RRC_IDLE state on Cell 1.	-	-	-	-
9-13	The UE will perform TAU procedure based on steps 1 to 5 of subclause 6.4.2.7 in TS 36.508 on Cell 1. NOTE: The UE performs a TAU procedure due to NAS signalling connection recovery.	-	-	-	-
14	Check: Does the test result of generic test procedure in TS 36.508 subclause 6.4.2.3 indicate that the UE is in E-UTRA RRC_CONNECTED state on Cell 1?	-	-	1	-
-	At the end of this test procedure sequence, the UE is in end state E-UTRA connected (E2_T3440) according to TS 36.508.	-	-	-	-

Table 8.2.4.8.3.2-3: Parallel behaviour

St	Procedure	Message Sequence		TP	Verdict
		U - S	Message		
-	EXCEPTION: The steps 1 and 2 below are repeated for the duration of T304	-	-	-	-
1	The UE attempts to perform the intra frequency handover using MAC Random Access Preamble on Cell 2	-	-	-	-
2	The SS does not respond.	-	-	-	-

8.2.4.8.3.3 Specific message contents

Table 8.2.4.8.3.3-1: *RRConnectionReconfiguration* (step 1, Table 8.2.4.8.3.2-2)

Derivation path: 36.508 Table 4.6.1-8, condition MEAS

Table 8.2.4.8.3.3-1A: MeasConfig (Table 8.2.4.8.3.3-1)

Derivation Path: 36.508, Table 4.6.6-1			
Information Element	Value/remark	Comment	Condition
MeasConfig ::= SEQUENCE {			
measObjectToAddModList SEQUENCE (SIZE (1..maxObjectId)) OF SEQUENCE {	1 entry		
measObjectId[1]	IdMeasObject-f1		
measObject[1]	MeasObjectEUTRA-GENERIC(f1)		
}			
reportConfigToAddModList SEQUENCE (SIZE (1..maxReportConfigId)) OF SEQUENCE {	1 entry		
reportConfigId[1]	IdReportConfig-A3		
reportConfig[1]	ReportConfigEUTRA-A3		
}			
measIdToAddModList SEQUENCE (SIZE (1..maxMeasId)) OF SEQUENCE {	1 entry		
measId[1]	1		
measObjectId[1]	IdMeasObject-f1		
reportConfigId[1]	IdReportConfig-A3		
}			
}			

Table 8.2.4.8.3.3-2: MeasurementReport (step 4, Table 8.2.4.8.3.2-2)

Derivation path: 36.508 Table 4.6.1-5			
Information Element	Value/Remark	Comment	Condition
MeasurementReport ::= SEQUENCE {			
criticalExtensions CHOICE {			
c1 CHOICE{			
measurementReport-r8 SEQUENCE {			
measResults SEQUENCE {			
measId	1		
measResultServCell SEQUENCE {			
rsrpResult	(0..97)		
rsrqResult	(0..34)		
}			
measResultNeighCells CHOICE {			
measResultListEUTRA SEQUENCE (SIZE (1..maxCellReport)) OF SEQUENCE {	1 entry		
physCellId[1]	PhysicalCellIdentity of Cell 2		
cgi-Info[1]	Not present		
measResult[1] SEQUENCE {			
rsrpResult	(0..97)		
rsrqResult	(0..34)		
}			
}			
}			
}			
}			
}			
}			

Table 8.2.4.8.3.3-3: RRCConnectionReconfiguration (step 5, Table 8.2.4.8.3.2-2)

Derivation path: 36.508 Table 4.6.1-8, condition HO

Table 8.2.4.8.3.3-3A: *MobilityControlInfo* (Table 8.2.4.8.3.3-4)

Derivation Path: 36.508 Table 4.6.5-1			
Information Element	Value/remark	Comment	Condition
MobilityControlInfo ::= SEQUENCE {			
targetPhysCellId	PhysicalCellIdentity of Cell 2		
carrierFreq	Not present		
}			

Table 8.2.4.8.3.3-4: Void**Table 8.2.4.8.3.3-5: *RRCConnectionReestablishmentRequest* (step 7, Table 8.2.4.8.3.2-2)**

Derivation path: 36.508 Table 4.6.1-13			
Information Element	Value/Remark	Comment	Condition
RRCConnectionReestablishmentRequest ::= SEQUENCE {			
criticalExtensions CHOICE {			
rrcConnectionReestablishmentRequest-r8			
SEQUENCE {			
ue-Identity SEQUENCE {			
c-RNTI	The value of the C-RNTI of the UE.		
physCellId	PhysicalCellIdentity of Cell 1		
shortMAC-I	The same value as the 16 least significant bits of the XMAC-I value calculated by SS		
}			
reestablishmentCause	handoverFailure		
}			
}			

8.2.4.9 RRC connection reconfiguration / Handover / Inter-band blind handover / Success

8.2.4.9.1 Test Purpose (TP)

(1)

```

with { UE having completed the radio bearer establishment and initial security activation procedure
}
ensure that {
  when { UE receives an RRCConnectionReconfiguration message including a mobilityControlInfo
indicating an E-UTRA frequency on different frequency band }
  then { UE transmits an RRCConnectionReconfigurationComplete message }
}

```

8.2.4.9.2 Conformance requirements

References: The conformance requirements covered in the present TC are specified in: TS 36.331, clauses 5.3.5.4, 5.3.10.4 and 5.3.10.6.

[TS 36.331, clause 5.3.5.4]

If the *RRCConnectionReconfiguration* message includes the *mobilityControlInfo* and the UE is able to comply with the configuration included in this message, the UE shall:

- 1> stop timer T310, if running;

1> start timer T304 with the timer value set to $t304$, as included in the *mobilityControlInfo*;

1> if the *carrierFreq* is included:

2> consider the target cell to be one on the frequency indicated by the *carrierFreq* with a physical cell identity indicated by the *targetPhysCellId*;

1> else:

2> consider the target cell to be one on the current frequency with a physical cell identity indicated by the *targetPhysCellId*;

1> start synchronising to the DL of the target cell;

NOTE 1: The UE should perform the handover as soon as possible following the reception of the RRC message triggering the handover, which could be before confirming successful reception (HARQ and ARQ) of this message.

1> reset MAC;

1> re-establish PDCP for all RBs that are established;

NOTE 2: The handling of the radio bearers after the successful completion of the PDCP re-establishment, e.g. the re-transmission of unacknowledged PDCP SDUs (as well as the associated status reporting), the handling of the SN and the HFN, is specified in TS 36.323 [8].

1> re-establish RLC for all RBs that are established;

1> apply the value of the *newUE-Identity* as the C-RNTI;

1> configure lower layers in accordance with the received *radioResourceConfigCommon*;

...

1> if the *keyChangeIndicator* received in the *securityConfigHO* is set to *TRUE*:

2> update the K_{eNB} key based on the fresh K_{ASME} key taken into use with the previous successful NAS SMC procedure, as specified in TS 33.401 [32];

1> else:

2> update the K_{eNB} key based on the current K_{eNB} or the NH, using the *nextHopChainingCount* value indicated in the *securityConfigHO*, as specified in TS 33.401 [32];

1> store the *nextHopChainingCount* value;

1> if the *securityAlgorithmConfig* is included in the *securityConfigHO*:

2> derive the K_{RRcint} key associated with the *integrityProtAlgorithm*, as specified in TS 33.401 [32];

2> derive the K_{RRcenc} key and the K_{UPenc} key associated with the *cipheringAlgorithm*, as specified in TS 33.401 [32];

1> else:

2> derive the K_{RRcint} key associated with the current integrity algorithm, as specified in TS 33.401 [32];

2> derive the K_{RRcenc} key and the K_{UPenc} key associated with the current ciphering algorithm, as specified in TS 33.401 [32];

1> configure lower layers to apply the integrity protection algorithm and the K_{RRcint} key, i.e. the integrity protection configuration shall be applied to all subsequent messages received and sent by the UE, including the message used to indicate the successful completion of the procedure;

1> configure lower layers to apply the ciphering algorithm, the K_{RRcenc} key and the K_{UPenc} key, i.e. the ciphering configuration shall be applied to all subsequent messages received and sent by the UE, including the message used to indicate the successful completion of the procedure;

- 1> perform the measurement related actions as specified in 5.5.6.1;
 - 1> if the *RRCCConnectionReconfiguration* message includes the *measConfig*:
 - 2> perform the measurement configuration procedure as specified in 5.5.2;
 - 1> submit the *RRCCConnectionReconfigurationComplete* message to lower layers for transmission;
 - 1> if MAC successfully completes the random access procedure:
 - 2> stop timer T304;
 - 2> apply the parts of the CQI reporting configuration, the scheduling request configuration and the sounding RS configuration that do not require the UE to know the SFN of the target cell, if any;
 - 2> apply the parts of the measurement and the radio resource configuration that require the UE to know the SFN of the target cell (e.g. measurement gaps, periodic CQI reporting, scheduling request configuration, sounding RS configuration), if any, upon acquiring the SFN of the target cell;
- NOTE 3: Whenever the UE shall setup or reconfigure a configuration in accordance with a field that is received it applies the new configuration, except for the cases addressed by the above statements.
- 2> the procedure ends;

...

[TS 36.331, clause 5.3.10.4]

The UE shall:

- 1> reconfigure the MAC main configuration in accordance with the received *mac-MainConfig*;

[TS 36.331, clause 5.3.10.6]

The UE shall:

- 1> reconfigure the physical channel configuration in accordance with the received *physicalConfigDedicated*;
- 1> if the *antennaInfo* is included and set to '*explicitValue*':
 - 2> if the configured *transmissionMode* is not '*tm3*' or '*tm4*' release *ri-ConfigIndex* in *cqi-ReportPeriodic*, if previously configured;
- 1> else if the *antennaInfo* is included and set to '*defaultValue*':
 - 2> release *ri-ConfigIndex* in *cqi-ReportPeriodic*, if previously configured;

8.2.4.9.3 Test description

8.2.4.9.3.1 Pre-test conditions

System Simulator:

- Cell 1 and Cell 10.
- System information combination 3 as defined in TS 36.508 [18] clause 4.4.3.1 is used in E-UTRA cells.

UE:

None.

Preamble:

- The UE is in state Generic RB Established (state 3) on Cell 1 according to [18].

8.2.4.9.3.2 Test procedure sequence

Table 8.2.4.9.3.2-1: Main behaviour

St	Procedure	Message Sequence		TP	Verdict
		U - S	Message		
1	The SS transmits an <i>RRCCONNECTIONRECONFIGURATION</i> message on Cell 1 to order the UE to perform inter band handover to Cell 10.	<--	<i>RRCCONNECTIONRECONFIGURATION</i>	-	-
2	Check: Does the UE transmit an <i>RRCCONNECTIONRECONFIGURATIONCOMPLETE</i> message on Cell 10?	-->	<i>RRCCONNECTIONRECONFIGURATIONCOMPLETE</i>	1	P
3	Check: Does the test result of generic test procedure in TS 36.508 subclause 6.4.2.3 indicate that the UE is in E-UTRA RRC_CONNECTED state on Cell 10?	-	-	1	-

8.2.4.9.3.3 Specific message contents

Table 8.2.4.9.3.3-1: *RRCCONNECTIONRECONFIGURATION* (step 1, Table 8.2.4.9.3.2-1)

Derivation Path: 36.508, Table 4.6.1-8, condition HO
--

Table 8.2.4.9.3.3-2: *MOBILITYCONTROLLINFO* (Table 8.2.4.9.3.3-1)

Derivation Path: 36.508, Table 4.6.5-1			
Information Element	Value/remark	Comment	Condition
<i>MOBILITYCONTROLLINFO</i> ::= SEQUENCE {			
<i>targetPhysCellId</i>	PhysicalCellIdentity of Cell 10		
<i>carrierFreq</i> SEQUENCE {			
<i>dl-CarrierFreq</i>	Same downlink EARFCN as used for Cell 10		
<i>ul-CarrierFreq</i>	Not present		
}			
}			

8.2.4.10 RRC connection reconfiguration / Handover (between FDD and TDD)

8.2.4.10.1 Test Purpose (TP)

(1)

```

with { UE having completed the radio bearer establishment and initial security activation procedure
in FDD mode }
ensure that {
  when { UE receives an RRCCONNECTIONRECONFIGURATION message including an IE
MOBILITYCONTROLINFORMATION with TDD configuration parameters included }
  then { UE transmits an RRCCONNECTIONRECONFIGURATIONCOMPLETE message }
}

```

(2)

```

with { UE having completed the radio bearer establishment and initial security activation procedure
in TDD mode }
ensure that {
  when { UE receives an RRCCONNECTIONRECONFIGURATION message including an IE
MOBILITYCONTROLINFORMATION with FDD configuration parameters included }
  then { UE transmits an RRCCONNECTIONRECONFIGURATIONCOMPLETE message }
}

```

8.2.4.10.2 Conformance requirements

References: The conformance requirements covered in the present TC are specified in: 3GPP TS 36.331 clauses 5.3.5.4, 5.3.10.4 and 5.3.10.6.

[TS 36.331, clause 5.3.5.4]

If the *RRCConnectionReconfiguration* message includes the *mobilityControlInfo* and the UE is able to comply with the configuration included in this message, the UE shall:

- 1> stop timer T310, if running;
- 1> start timer T304 with the timer value set to *t304*, as included in the *mobilityControlInfo*;
- 1> if the *carrierFreq* is included:
 - 2> consider the target cell to be one on the frequency indicated by the *carrierFreq* with a physical cell identity indicated by the *targetPhysCellId*;
- 1> else:
 - 2> consider the target cell to be one on the current frequency with a physical cell identity indicated by the *targetPhysCellId*;
- 1> start synchronising to the DL of the target cell;

NOTE 1: The UE should perform the handover as soon as possible following the reception of the RRC message triggering the handover, which could be before confirming successful reception (HARQ and ARQ) of this message.

- 1> reset MAC;
- 1> re-establish PDCP for all RBs that are established;

NOTE 2: The handling of the radio bearers after the successful completion of the PDCP re-establishment, e.g. the re-transmission of unacknowledged PDCP SDUs (as well as the associated status reporting), the handling of the SN and the HFN, is specified in TS 36.323 [8].

- 1> re-establish RLC for all RBs that are established;
- 1> apply the value of the *newUE-Identity* as the C-RNTI;
- 1> configure lower layers in accordance with the received *radioResourceConfigCommon*;
- 1> configure lower layers in accordance with any additional fields, not covered in the previous, if included in the received *mobilityControlInfo*;
- 1> if the *RRCConnectionReconfiguration* message includes the *radioResourceConfigDedicated*:
 - 2> perform the radio resource configuration procedure as specified in 5.3.10;
- 1> if the *keyChangeIndicator* received in the *securityConfigHO* is set to *TRUE*:
 - 2> update the K_{eNB} key based on the fresh K_{ASME} key taken into use with the previous successful NAS SMC procedure, as specified in TS 33.401 [32];
- 1> else:
 - 2> update the K_{eNB} key based on the current K_{eNB} or the NH, using the *nextHopChainingCount* value indicated in the *securityConfigHO*, as specified in TS 33.401 [32];
- 1> store the *nextHopChainingCount* value;
- 1> if the *securityAlgorithmConfig* is included in the *securityConfigHO*:
 - 2> derive the K_{RRcInt} key associated with the *integrityProtAlgorithm*, as specified in TS 33.401 [32];

- 2> derive the K_{RRCEnc} key and the K_{UPenc} key associated with the *cipheringAlgorithm*, as specified in TS 33.401 [32];
 - 1> else:
 - 2> derive the K_{RRCint} key associated with the current integrity algorithm, as specified in TS 33.401 [32];
 - 2> derive the K_{RRCEnc} key and the K_{UPenc} key associated with the current ciphering algorithm, as specified in TS 33.401 [32];
 - 1> configure lower layers to apply the integrity protection algorithm and the K_{RRCint} key, i.e. the integrity protection configuration shall be applied to all subsequent messages received and sent by the UE, including the message used to indicate the successful completion of the procedure;
 - 1> configure lower layers to apply the ciphering algorithm, the K_{RRCEnc} key and the K_{UPenc} key, i.e. the ciphering configuration shall be applied to all subsequent messages received and sent by the UE, including the message used to indicate the successful completion of the procedure;
 - 1> perform the measurement related actions as specified in 5.5.6.1;
 - 1> if the *RRConnectionReconfiguration* message includes the *measConfig*:
 - 2> perform the measurement configuration procedure as specified in 5.5.2;
 - 1> submit the *RRConnectionReconfigurationComplete* message to lower layers for transmission;
 - 1> if MAC successfully completes the random access procedure:
 - 2> stop timer T304;
 - 2> apply the parts of the CQI reporting configuration, the scheduling request configuration and the sounding RS configuration that do not require the UE to know the SFN of the target cell, if any;
 - 2> apply the parts of the measurement and the radio resource configuration that require the UE to know the SFN of the target cell (e.g. measurement gaps, periodic CQI reporting, scheduling request configuration, sounding RS configuration), if any, upon acquiring the SFN of the target cell;
- NOTE 3: Whenever the UE shall setup or reconfigure a configuration in accordance with a field that is received it applies the new configuration, except for the cases addressed by the above statements.
- 2> the procedure ends;
- NOTE 4: The UE is not required to determine the SFN of the target cell by acquiring system information from that cell before performing RACH access in the target cell.

[TS 36.331, clause 5.3.10.4]

The UE shall:

- 1> reconfigure the MAC main configuration in accordance with the received *mac-MainConfig*;

[TS 36.331, clause 5.3.10.6]

The UE shall:

- 1> reconfigure the physical channel configuration in accordance with the received *physicalConfigDedicated*;
- 1> if the *antennaInfo* is included and set to '*explicitValue*':
 - 2> if the configured *transmissionMode* is not '*tm3*' or '*tm4*' release *ri-ConfigIndex* in *cqi-ReportPeriodic*, if previously configured;
- 1> else if the *antennaInfo* is included and set to '*defaultValue*':
 - 2> release *ri-ConfigIndex* in *cqi-ReportPeriodic*, if previously configured;

8.2.4.10.3 Test description

8.2.4.10.3.1 Pre-test conditions

System Simulator:

- Cell 1 in FDD and Cell 10 in TDD
- System information combination 3 as defined in TS 36.508 [18] clause 4.4.3.1 is used in E-UTRA cells.

UE:

None.

Preamble:

- The UE is in state Generic RB Established (state 3) on cell 1 according to [18].

8.2.4.10.3.2 Test procedure sequence

Table 8.2.4.10.3.2-1: Main behaviour

St	Procedure	Message Sequence		TP	Verdict
		U - S	Message		
1	The SS transmits an <i>RRConnectionReconfiguration</i> message including TDD-Config to order the UE to perform inter band handover to Cell 10.	<--	<i>RRConnectionReconfiguration</i>	-	-
2	Check: Does the UE transmit an <i>RRConnectionReconfigurationComplete</i> message on Cell 10?	-->	<i>RRConnectionReconfigurationComplete</i>	1	P
3	Check: Does the test result of generic test procedure in TS 36.508 subclause 6.4.2.3 indicate that the UE is in E-UTRA RRC_CONNECTED state on Cell 10?	-	-	1	-
4	The SS transmits an <i>RRConnectionReconfiguration</i> message without including TDD-Config to order the UE to perform inter band handover to Cell 1.	<--	<i>RRConnectionReconfiguration</i>	-	-
5	Check: Does the UE transmit an <i>RRConnectionReconfigurationComplete</i> message on Cell 1?	-->	<i>RRConnectionReconfigurationComplete</i>	2	P
6	Check: Does the test result of generic test procedure in TS 36.508 subclause 6.4.2.3 indicate that the UE is in E-UTRA RRC_CONNECTED state on Cell 1?	-	-	2	-

8.2.4.10.3.3 Specific message content

Table 8.2.4.10.3.3-1: *RRConnectionReconfiguration* (step 1, Table 8.2.4.10.3.2-1)

Derivation Path: 36.508, Table 4.6.1-8, condition HO
--

Table 8.2.4.10.3.3-2: *MobilityControlInfo* (Table 8.2.4.10.3.3-1)

Derivation Path: 36.508, Table 4.6.5-1			
Information Element	Value/remark	Comment	Condition
MobilityControlInfo-HO ::= SEQUENCE {			
targetPhysCellId	PhysicalCellIdentity of Cell 10		
carrierFreq SEQUENCE {			
dl-CarrierFreq	Same downlink EARFCN as used for Cell 10		
ul-CarrierFreq	Not present		
}			
carrierBandwidth SEQUENCE {			
dl-Bandwidth	Same downlink system bandwidth as used for Cell 10		
ul-Bandwidth	Not present		
}			
additionalSpectrumEmission	Same additionalSpectrumEmission as used for Cell 10		
radioResourceConfigCommon	RadioResourceConfigCommon-withTDDconfig		
}			

Table 8.2.4.10.3.3-2A: *RadioResourceConfigCommon-withTDDconfig* (Table 8.2.4.10.3.3-2)

Derivation Path: 36.508, Table 4.6.3-13			
Information Element	Value/remark	Comment	Condition
RadioResourceConfigCommon-DEFAULT ::= SEQUENCE {			
tdd-Config	TDD-Config-DEFAULT		
}			

Table 8.2.4.10.3.3-3: *RRCConnectionReconfiguration* (step 4, Table 8.2.4.10.3.2-1)

Derivation Path: 36.508, Table 4.6.1-8, condition HO			

Table 8.2.4.10.3.3-4: *MobilityControlInfo* (Table 8.2.4.10.3.3-3)

Derivation Path: 36.508, Table 4.6.5-1			
Information Element	Value/remark	Comment	Condition
MobilityControlInfo-HO ::= SEQUENCE {			
targetPhysCellId	PhysicalCellIdentity of Cell 1		
carrierFreq SEQUENCE {			
dl-CarrierFreq	Same downlink EARFCN as used for Cell 1		
ul-CarrierFreq	Same uplink EARFCN as used for Cell 1		
}			
carrierBandwidth SEQUENCE {			
dl-Bandwidth	Same downlink system bandwidth as used for Cell 1		
ul-Bandwidth	Same uplink system bandwidth as used for Cell 1		
}			
additionalSpectrumEmission	Same additionalSpectrumEmission as used for Cell 1		
radioResourceConfigCommon	RadioResourceConfigCommon-withoutTDDconfig		
}			

Table 8.2.4.10.3.3-5: RadioResourceConfigCommon-withoutTDDconfig (Table 8.2.4.10.3.3-4)

Derivation Path: 36.508, Table 4.6.3-13			
Information Element	Value/remark	Comment	Condition
RadioResourceConfigCommon-DEFAULT ::= SEQUENCE {			
tdd-Config	Not present		
}			

8.2.4.11 Void

8.2.4.12 RRC connection reconfiguration / Handover / Setup and release of MIMO

8.2.4.12.1 Test Purpose (TP)

(1)

```
with { UE having completed the radio bearer establishment and initial security activation procedure
}
ensure that {
  when { UE receives an RRCCONNECTIONRECONFIGURATION message including a mobilityControlInfo
indicating a cell with 2 antenna ports }
  then { UE transmits an RRCCONNECTIONRECONFIGURATIONCOMPLETE message }
}
```

(2)

```
with { UE having completed the radio bearer establishment and initial security activation procedure
}
ensure that {
  when { UE receives an RRCCONNECTIONRECONFIGURATION message including a mobilityControlInfo
indicating a cell with 1 antenna port }
  then { UE transmits an RRCCONNECTIONRECONFIGURATIONCOMPLETE message }
}
```

8.2.4.12.2 Conformance requirements

References: The conformance requirements covered in the present TC are specified in: 3GPP TS 36.331 clauses 5.3.5.4 and 5.3.10.6.

[TS 36.331, clause 5.3.5.4]

If the *RRCCONNECTIONRECONFIGURATION* message includes the *mobilityControlInfo* and the UE is able to comply with the configuration included in this message, the UE shall:

1> stop timer T310, if running;

1> start timer T304 with the timer value set to *t304*, as included in the *mobilityControlInfo*;

...

1> else:

2> consider the target cell to be one on the current frequency with a physical cell identity indicated by the *targetPhysCellId*;

1> start synchronising to the DL of the target cell;

NOTE 1: The UE should perform the handover as soon as possible following the reception of the RRC message triggering the handover, which could be before confirming successful reception (HARQ and ARQ) of this message.

1> reset MAC;

1> re-establish PDCP for all RBs that are established;

NOTE 2: The handling of the radio bearers after the successful completion of the PDCP re-establishment, e.g. the re-transmission of unacknowledged PDCP SDUs (as well as the associated status reporting), the handling of the SN and the HFN, is specified in TS 36.323.

1> re-establish RLC for all RBs that are established;

1> apply the value of the *newUE-Identity* as the C-RNTI;

...

1> configure lower layers in accordance with the received *radioResourceConfigCommon*;

1> configure lower layers in accordance with any additional fields, not covered in the previous, if included in the received *mobilityControlInfo*;

1> if the *RRCCONNECTIONRECONFIGURATION* message includes the *radioResourceConfigDedicated*:

2> perform the radio resource configuration procedure as specified in 5.3.10;

...

1> else:

2> update the K_{eNB} key based on the current K_{eNB} or the NH, using the *nextHopChainingCount* value indicated in the *securityConfigHO*, as specified in TS 33.401 [32];

1> store the *nextHopChainingCount* value;

...

1> else:

2> derive the K_{RRcint} key associated with the current integrity algorithm, as specified in TS 33.401 [32];

2> derive the K_{RRcenc} key and the K_{UPenc} key associated with the current ciphering algorithm, as specified in TS 33.401 [32];

1> configure lower layers to apply the integrity protection algorithm and the K_{RRcint} key, i.e. the integrity protection configuration shall be applied to all subsequent messages received and sent by the UE, including the message used to indicate the successful completion of the procedure;

1> configure lower layers to apply the ciphering algorithm, the K_{RRcenc} key and the K_{UPenc} key, i.e. the ciphering configuration shall be applied to all subsequent messages received and sent by the UE, including the message used to indicate the successful completion of the procedure;

1> perform the measurement related actions as specified in 5.5.6.1;

...

1> submit the *RRCCONNECTIONRECONFIGURATIONCOMPLETE* message to lower layers for transmission;

1> if MAC successfully completes the random access procedure:

2> stop timer T304;

2> apply the parts of the CQI reporting configuration, the scheduling request configuration and the sounding RS configuration that do not require the UE to know the SFN of the target cell, if any;

2> apply the parts of the measurement and the radio resource configuration that require the UE to know the SFN of the target cell (e.g. measurement gaps, periodic CQI reporting, scheduling request configuration, sounding RS configuration), if any, upon acquiring the SFN of the target cell;

NOTE 3: Whenever the UE shall setup or reconfigure a configuration in accordance with a field that is received it applies the new configuration, except for the cases addressed by the above statements.

2> the procedure ends;

NOTE 4: The UE is not required to determine the SFN of the target cell by acquiring system information from that cell before performing RACH access in the target cell.

[TS 36.331, clause 5.3.10.6]

The UE shall:

- 1> reconfigure the physical channel configuration in accordance with the received *physicalConfigDedicated*;
- 1> if the *antennaInfo* is included and set to 'explicitValue':
 - 2> if the configured *transmissionMode* is not 'tm3' or 'tm4' or 'tm8':
 - 3> release *ri-ConfigIndex* in *cqi-ReportPeriodic*, if previously configured;
 - 2> if the configured *transmissionMode* is 'tm8' and *pmi-RI-Report* is not present:
 - 3> release *ri-ConfigIndex* in *cqi-ReportPeriodic*, if previously configured;
- 1> else if the *antennaInfo* is included and set to 'defaultValue':
 - 2> release *ri-ConfigIndex* in *cqi-ReportPeriodic*, if previously configured;

8.2.4.12.3 Test description

8.2.4.12.3.1 Pre-test conditions

System Simulator:

- Cell 1 and Cell 2 (2 antenna ports MIMO)

UE:

None.

Preamble:

- The UE is in state Generic RB Established (state 3) on cell 1 according to [18].

8.2.4.12.3.2 Test procedure sequence

Table 8.2.4.12.3.2-0 illustrates the downlink power levels and other changing parameters to be applied for the cells at various time instants of the test execution. Row marked "T0" denotes the initial conditions after preamble, while columns marked "T1" is to be applied subsequently. The exact instants on which these values shall be applied are described in the texts in this clause.

Table 8.2.4.12.3.2-0: Time instances of cell power level and parameter changes

	Parameter	Unit	Cell 1	Cell 2
T0	Cell-specific RS EPRE	dBm/15k Hz	-91	-85
T1	Cell-specific RS EPRE	dBm/15k Hz	-85	-91

Table 8.2.4.12.3.2-1: Main behaviour

St	Procedure	Message Sequence		TP	Verdict
		U - S	Message		
1	The SS transmits an <i>RRConnectionReconfiguration</i> message to order the UE to perform intra frequency handover to Cell 2.	<--	<i>RRConnectionReconfiguration</i>	-	-
2	Check: Does the UE transmit an <i>RRConnectionReconfigurationComplete</i> message on Cell 2?	-->	<i>RRConnectionReconfigurationComplete</i>	1	P
3	Check: Does the test result of generic test procedure in TS 36.508 subclause 6.4.2.3 indicate that the UE is in E-UTRA RRC_CONNECTED state on Cell 2?	-	-	1	-
3A	The SS changes Cell 1 and Cell 2 parameters according to the row "T1" in table 8.2.4.12.3.2-0.	-	-	-	-
4	The SS transmits an <i>RRConnectionReconfiguration</i> message to order the UE to perform intra frequency handover to Cell 1.	<--	<i>RRConnectionReconfiguration</i>	-	-
5	Check: Does the UE transmit an <i>RRConnectionReconfigurationComplete</i> message on Cell 1?	-->	<i>RRConnectionReconfigurationComplete</i>	2	P
6	Check: Does the test result of generic test procedure in TS 36.508 subclause 6.4.2.3 indicate that the UE is in E-UTRA RRC_CONNECTED state on Cell 1?	-	-	2	-

8.2.4.12.3.3 Specific message content

Table 8.2.4.12.3.3-1: *RRConnectionReconfiguration* (step 1, Table 8.4.2.12.3.2-1)

Derivation Path: 36.508, Table 4.6.1-8, condition HO
--

Table 8.2.4.12.3.3-2: *MobilityControlInfo* (Table 8.2.4.12.3.3-1)

Derivation Path: 36.508, Table 4.6.5-1			
Information Element	Value/remark	Comment	Condition
<i>MobilityControlInfo</i> -HO ::= SEQUENCE {			
<i>targetPhysCellId</i>	PhysicalCellIdentity of Cell 2		
<i>carrierFreq</i>	Not present		
<i>radioResourceConfigCommon</i>	RadioResourceConfigCommon-DEFAULT		
}			

Table 8.2.4.12.3.3-3: *RadioResourceConfigCommon-DEFAULT* (Table 8.2.4.12.3.3-2)

Derivation Path: 36.508, Table 4.6.3-13, condition 2TX
--

Table 8.2.4.12.3.3-4: *RRConnectionReconfiguration* (step 4, Table 8.4.2.12.3.2-1)

Derivation Path: 36.508, Table 4.6.1-8, condition HO
--

Table 8.2.4.12.3.3-5: *MobilityControlInfo* (Table 8.2.4.12.3.3-4)

Derivation Path: 36.508, Table 4.6.5-1			
Information Element	Value/remark	Comment	Condition
<i>MobilityControlInfo</i> ::= SEQUENCE {			
targetPhysCellId	PhysicalCellId of Cell 1		
carrierFreq	Not present		
radioResourceConfigCommon	RadioResourceConfigCommon-DEFAULT		
}			

Table 8.2.4.12.3.3-6: *RadioResourceConfigCommon-DEFAULT* (Table 8.2.4.12.3.3-5)

Derivation Path: 36.508, Table 4.6.3-1			
Information Element	Value/remark	Comment	Condition
antennaInfoCommon SEQUENCE {			
antennaPortsCount	an1		
}			

8.2.4.13 RRC connection reconfiguration / Handover / Success (with measurement) / Inter-band

8.2.4.13.1 Test Purpose (TP)

(1)

```

with { UE having completed the radio bearer establishment and initial security activation procedure
and performed the inter-band measurement }
ensure that {
  when { UE receives an RRCConnectionReconfiguration message including a mobilityControlInfo
indicating an E-UTRA frequency on different frequency band }
    then { UE transmits an RRCConnectionReconfigurationComplete message }
}

```

8.2.4.13.2 Conformance requirements

References: The conformance requirements covered in the present TC are specified in: TS 36.331, clauses 5.3.5.4, 5.3.10.4 and 5.3.10.6.

[TS 36.331, clause 5.3.5.4]

If the *RRCConnectionReconfiguration* message includes the *mobilityControlInfo* and the UE is able to comply with the configuration included in this message, the UE shall:

- 1> stop timer T310, if running;
- 1> start timer T304 with the timer value set to *t304*, as included in the *mobilityControlInfo*;
- 1> if the *carrierFreq* is included:
 - 2> consider the target cell to be one on the frequency indicated by the *carrierFreq* with a physical cell identity indicated by the *targetPhysCellId*;
- 1> else:
 - 2> consider the target cell to be one on the current frequency with a physical cell identity indicated by the *targetPhysCellId*;
- 1> start synchronising to the DL of the target cell;

NOTE 1: The UE should perform the handover as soon as possible following the reception of the RRC message triggering the handover, which could be before confirming successful reception (HARQ and ARQ) of this message.

1> reset MAC;

1> re-establish PDCP for all RBs that are established;

NOTE 2: The handling of the radio bearers after the successful completion of the PDCP re-establishment, e.g. the re-transmission of unacknowledged PDCP SDUs (as well as the associated status reporting), the handling of the SN and the HFN, is specified in TS 36.323 [8].

1> re-establish RLC for all RBs that are established;

1> apply the value of the *newUE-Identity* as the C-RNTI;

1> if the *RRCCONNECTIONRECONFIGURATION* message includes the *fullConfig*:

2> perform the radio configuration procedure as specified in section 5.3.5.8;

1> configure lower layers in accordance with the received *radioResourceConfigCommon*;

1> configure lower layers in accordance with any additional fields, not covered in the previous, if included in the received *mobilityControlInfo*;

1> if the *RRCCONNECTIONRECONFIGURATION* message includes the *radioResourceConfigDedicated*:

2> perform the radio resource configuration procedure as specified in 5.3.10;

1> if the *keyChangeIndicator* received in the *securityConfigHO* is set to *TRUE*:

2> update the K_{eNB} key based on the fresh K_{ASME} key taken into use with the previous successful NAS SMC procedure, as specified in TS 33.401 [32];

1> else:

2> update the K_{eNB} key based on the current K_{eNB} or the NH, using the *nextHopChainingCount* value indicated in the *securityConfigHO*, as specified in TS 33.401 [32];

1> store the *nextHopChainingCount* value;

1> if the *securityAlgorithmConfig* is included in the *securityConfigHO*:

2> derive the K_{RRcInt} key associated with the *integrityProtAlgorithm*, as specified in TS 33.401 [32];

2> derive the K_{RRcEnc} key and the K_{UPenc} key associated with the *cipheringAlgorithm*, as specified in TS 33.401 [32];

1> else:

2> derive the K_{RRcInt} key associated with the current integrity algorithm, as specified in TS 33.401 [32];

2> derive the K_{RRcEnc} key and the K_{UPenc} key associated with the current ciphering algorithm, as specified in TS 33.401 [32];

1> configure lower layers to apply the integrity protection algorithm and the K_{RRcInt} key, i.e. the integrity protection configuration shall be applied to all subsequent messages received and sent by the UE, including the message used to indicate the successful completion of the procedure;

1> configure lower layers to apply the ciphering algorithm, the K_{RRcEnc} key and the K_{UPenc} key, i.e. the ciphering configuration shall be applied to all subsequent messages received and sent by the UE, including the message used to indicate the successful completion of the procedure;

1> perform the measurement related actions as specified in 5.5.6.1;

1> if the *RRCCONNECTIONRECONFIGURATION* message includes the *measConfig*:

2> perform the measurement configuration procedure as specified in 5.5.2;

1> release *reportProximityConfig* and clear any associated proximity status reporting timer;

1> if the *RRCCONNECTIONRECONFIGURATION* message includes the *reportProximityConfig*:

- 2> perform the proximity indication in accordance with the received *reportProximityConfig*;
- 1> submit the *RRCCONNECTIONRECONFIGURATIONCOMPLETE* message to lower layers for transmission;
- 1> if MAC successfully completes the random access procedure:
 - 2> stop timer T304;
 - 2> apply the parts of the CQI reporting configuration, the scheduling request configuration and the sounding RS configuration that do not require the UE to know the SFN of the target cell, if any;
 - 2> apply the parts of the measurement and the radio resource configuration that require the UE to know the SFN of the target cell (e.g. measurement gaps, periodic CQI reporting, scheduling request configuration, sounding RS configuration), if any, upon acquiring the SFN of the target cell;

NOTE 3: Whenever the UE shall setup or reconfigure a configuration in accordance with a field that is received it applies the new configuration, except for the cases addressed by the above statements.

- 2> the procedure ends;

[TS 36.331, clause 5.3.10.4]

The UE shall:

- 1> reconfigure the MAC main configuration in accordance with the received *mac-MainConfig*;

[TS 36.331, clause 5.3.10.6]

The UE shall:

- 1> reconfigure the physical channel configuration in accordance with the received *physicalConfigDedicated*;
- 1> if the *antennaInfo* is included and set to '*explicitValue*':
 - 2> if the configured *transmissionMode* is not '*tm3*' or '*tm4*' or '*tm8*':
 - 3> release *ri-ConfigIndex* in *cqi-ReportPeriodic*, if previously configured;
 - 2> if the configured *transmissionMode* is '*tm8*' and *pmi-RI-Report* is not present:
 - 3> release *ri-ConfigIndex* in *cqi-ReportPeriodic*, if previously configured;
- 1> else if the *antennaInfo* is included and set to '*defaultValue*':
 - 2> release *ri-ConfigIndex* in *cqi-ReportPeriodic*, if previously configured;

8.2.4.13.3 Test description

8.2.4.13.3.1 Pre-test conditions

System Simulator:

- Cell 1 and Cell 10.
- System information combination 3 as defined in TS 36.508 [18] clause 4.4.3.1 is used in E-UTRA cells.

UE:

None.

Preamble:

- The UE is in state Generic RB Established (state 3) on Cell 1 according to [18].

8.2.4.13.3.2 Test procedure sequence

Table 8.2.4.13.3.2-1 illustrates the downlink power levels and other changing parameters to be applied for the cells at various time instants of the test execution. Row marked "T0" denotes the initial conditions after preamble, while

columns marked "T1" is to be applied subsequently. The exact instants on which these values shall be applied are described in the texts in this clause.

Table 8.2.4.13.3.2-1: Time instances of cell power level and parameter changes

	Parameter	Unit	Cell 1	Cell 10	Remark
T0	Cell-specific RS EPRE	dBm/15k Hz	-85	-97	The power level values are such that measurement results for Cell 1 (M1) and Cell 10 (M10) satisfy exit condition for event A3 ($M10 < M1$).
T1	Cell-specific RS EPRE	dBm/15k Hz	-85	-73	The power level values are such that measurement results for Cell 1 (M1) and Cell 10 (M10) satisfy entry condition for event A3 ($M10 > M1$).

Table 8.2.4.13.3.2-2: Main behaviour

St	Procedure	Message Sequence		TP	Verdict
		U - S	Message		
1	The SS transmits an <i>RRCCONNECTIONRECONFIGURATION</i> message on Cell 1 to setup inter-band measurement.	<--	<i>RRCCONNECTIONRECONFIGURATION</i>	-	-
2	The UE transmits an <i>RRCCONNECTIONRECONFIGURATIONCOMPLETE</i> message on Cell 1.	-->	<i>RRCCONNECTIONRECONFIGURATIONCOMPLETE</i>	-	-
3	The SS changes Cell 1 and Cell 10 parameters according to the row "T1" in table 8.2.4.13.3.2-1.	-	-	-	-
4	The UE transmits a <i>MEASUREMENTREPORT</i> message on Cell 1 to report event A3 with the measured RSRP, RSRQ value for Cell 10.	-->	<i>MEASUREMENTREPORT</i>	-	-
5	The SS transmits an <i>RRCCONNECTIONRECONFIGURATION</i> message on Cell 1 to order the UE to perform inter-band handover to Cell 10.	<--	<i>RRCCONNECTIONRECONFIGURATION</i>	-	-
6	Check: Does the UE transmit an <i>RRCCONNECTIONRECONFIGURATIONCOMPLETE</i> message on Cell 10 to confirm the successful completion of the inter-band handover?	-->	<i>RRCCONNECTIONRECONFIGURATIONCOMPLETE</i>	1	P
7	Check: Does the test result of generic test procedure in TS 36.508 subclause 6.4.2.3 indicates that the UE is in E-UTRA RRC_CONNECTED state on Cell 10?	-	-	1	-

8.2.4.13.3.3 Specific message contents

Table 8.2.4.13.3.3-1: *RRCCONNECTIONRECONFIGURATION* (step 1, Table 8.2.4.13.3.2-2)

Derivation Path: 36.508, Table 4.6.1-8, condition MEAS
--

Table 8.2.4.13.3.3-2: MeasConfig (Table 8.2.4.13.3.3-1)

Derivation Path: 36.508, Table 4.6.6-1 condition INTER-FREQ			
Information Element	Value/remark	Comment	Condition
MeasConfig ::= SEQUENCE {			
measObjectToAddModList SEQUENCE (SIZE (1..maxObjectId)) OF SEQUENCE {	2 entries		
measObjectId[1]	IdMeasObject-f1		
measObject[1]	MeasObjectEUTRA-GENERIC(f1)		
measObjectId[2]	IdMeasObject-f5		
measObject[2]	MeasObjectEUTRA-GENERIC(f5)		
}			
reportConfigToAddModList SEQUENCE (SIZE (1..maxReportConfigId)) OF SEQUENCE {	1 entry		
reportConfigId[1]	IdReportConfig-A3		
reportConfig[1]	ReportConfigEUTRA-A3		
}			
measIdToAddModList SEQUENCE (SIZE (1..maxMeasId)) OF SEQUENCE {	1 entry		
measId[1]	1		
measObjectId[1]	IdMeasObject-f5		
reportConfigId[1]	IdReportConfig-A3		
}			
}			

Table 8.2.4.13.3.3-3: MeasurementReport (step 4, Table 8.2.4.13.3.2-2)

Derivation Path: 36.508, Table 4.6.1-5			
Information Element	Value/remark	Comment	Condition
MeasurementReport ::= SEQUENCE {			
criticalExtensions CHOICE {			
c1 CHOICE{			
measurementReport-r8 SEQUENCE {			
measResults SEQUENCE {			
measId	1		
measResultServCell SEQUENCE {			
rsrpResult	(0..97)		
rsrqResult	(0..34)		
}			
measResultNeighCells CHOICE {			
measResultListEUTRA SEQUENCE (SIZE (1..maxCellReport)) OF SEQUENCE {	1 entry		
physCellId[1]	PhysicalCellIdentity of Cell 10		
cgi-Info[1]	Not present		
measResult[1] SEQUENCE {			
rsrpResult	(0..97)		
rsrqResult	(0..34)		
additionalSI-Info-r9	Not present		
}			
}			
}			
measResultForECID-r9	Not present		
}			
}			

Table 8.2.4.13.3.3-4: RRCConnectionReconfiguration (step 5, Table 8.2.4.13.3.2-2)

Derivation Path: 36.508, Table 4.6.1-8, condition HO
--

Table 8.2.4.13.3.3-5: MobilityControlInfo (Table 8.2.4.13.3.3-4)

Derivation Path: 36.508, Table 4.6.5-1			
Information Element	Value/remark	Comment	Condition
MobilityControlInfo ::= SEQUENCE {			
targetPhysCellId	PhysicalCellId of Cell 10		
carrierFreq SEQUENCE {			
dl-CarrierFreq	Same downlink EARFCN as used for Cell 10		
ul-CarrierFreq	Not present		
}			
}			

8.2.4.13a RRC connection reconfiguration / Handover / Success (with measurement) / Inter-band / Between FDD and TDD

8.2.4.13a.1 Test Purpose (TP)

(1)

```
with { UE in E-UTRA FDD RRC_CONNECTED state and having completed the radio bearer establishment and
initial security activation procedure and performed the inter band LTE TDD measurement }
ensure that {
  when { UE receives an RRCConnectionReconfiguration message including a mobilityControlInfo
indicating a different E-UTRA TDD frequency }
    then { UE transmits an RRCConnectionReconfigurationComplete message }
}
```

(2)

```
with { UE in E-UTRA TDD RRC_CONNECTED state and having completed the radio bearer establishment and
initial security activation procedure and performed the inter band LTE FDD measurement }
ensure that {
  when { UE receives an RRCConnectionReconfiguration message including a mobilityControlInfo
indicating a different E-UTRA FDD frequency }
    then { UE transmits an RRCConnectionReconfigurationComplete message }
}
```

8.2.4.13a.2 Conformance requirements

References: The conformance requirements covered in the present TC are specified in: TS 36.331, clauses 5.3.5.4, 5.3.10.4 and 5.3.10.6.

[TS 36.331, clause 5.3.5.4]

If the *RRCConnectionReconfiguration* message includes the *mobilityControlInfo* and the UE is able to comply with the configuration included in this message, the UE shall:

1> stop timer T310, if running;

1> start timer T304 with the timer value set to *t304*, as included in the *mobilityControlInfo*;

1> if the *carrierFreq* is included:

2> consider the target cell to be one on the frequency indicated by the *carrierFreq* with a physical cell identity indicated by the *targetPhysCellId*;

1> else:

2> consider the target cell to be one on the current frequency with a physical cell identity indicated by the *targetPhysCellId*;

1> start synchronising to the DL of the target cell;

NOTE 1: The UE should perform the handover as soon as possible following the reception of the RRC message triggering the handover, which could be before confirming successful reception (HARQ and ARQ) of this message.

1> reset MAC;

1> re-establish PDCP for all RBs that are established;

NOTE 2: The handling of the radio bearers after the successful completion of the PDCP re-establishment, e.g. the re-transmission of unacknowledged PDCP SDUs (as well as the associated status reporting), the handling of the SN and the HFN, is specified in TS 36.323 [8].

1> re-establish RLC for all RBs that are established;

1> apply the value of the *newUE-Identity* as the C-RNTI;

1> configure lower layers in accordance with the received *radioResourceConfigCommon*;

1> configure lower layers in accordance with any additional fields, not covered in the previous, if included in the received *mobilityControlInfo*;

1> if the *RRCConnectionReconfiguration* message includes the *radioResourceConfigDedicated*:

2> perform the radio resource configuration procedure as specified in 5.3.10;

1> if the *keyChangeIndicator* received in the *securityConfigHO* is set to *TRUE*:

2> update the K_{eNB} key based on the fresh K_{ASME} key taken into use with the previous successful NAS SMC procedure, as specified in TS 33.401 [32];

1> else:

2> update the K_{eNB} key based on the current K_{eNB} or the NH, using the *nextHopChainingCount* value indicated in the *securityConfigHO*, as specified in TS 33.401 [32];

1> store the *nextHopChainingCount* value;

1> if the *securityAlgorithmConfig* is included in the *securityConfigHO*:

2> derive the K_{RRcint} key associated with the *integrityProtAlgorithm*, as specified in TS 33.401 [32];

2> derive the K_{RRcenc} key and the K_{UPenc} key associated with the *cipheringAlgorithm*, as specified in TS 33.401 [32];

1> else:

2> derive the K_{RRcint} key associated with the current integrity algorithm, as specified in TS 33.401 [32];

2> derive the K_{RRcenc} key and the K_{UPenc} key associated with the current ciphering algorithm, as specified in TS 33.401 [32];

1> configure lower layers to apply the integrity protection algorithm and the K_{RRcint} key, i.e. the integrity protection configuration shall be applied to all subsequent messages received and sent by the UE, including the message used to indicate the successful completion of the procedure;

1> configure lower layers to apply the ciphering algorithm, the K_{RRcenc} key and the K_{UPenc} key, i.e. the ciphering configuration shall be applied to all subsequent messages received and sent by the UE, including the message used to indicate the successful completion of the procedure;

1> perform the measurement related actions as specified in 5.5.6.1;

1> if the *RRCConnectionReconfiguration* message includes the *measConfig*:

2> perform the measurement configuration procedure as specified in 5.5.2;

1> submit the *RRCConnectionReconfigurationComplete* message to lower layers for transmission;

1> if MAC successfully completes the random access procedure:

2> stop timer T304;

2> apply the parts of the CQI reporting configuration, the scheduling request configuration and the sounding RS configuration that do not require the UE to know the SFN of the target cell, if any;

2> apply the parts of the measurement and the radio resource configuration that require the UE to know the SFN of the target cell (e.g. measurement gaps, periodic CQI reporting, scheduling request configuration, sounding RS configuration), if any, upon acquiring the SFN of the target cell;

NOTE 3: Whenever the UE shall setup or reconfigure a configuration in accordance with a field that is received it applies the new configuration, except for the cases addressed by the above statements.

2> the procedure ends;

...

[TS 36.331, clause 5.3.10.4]

The UE shall:

1> reconfigure the MAC main configuration in accordance with the received *mac-MainConfig*;

[TS 36.331, clause 5.3.10.6]

The UE shall:

1> reconfigure the physical channel configuration in accordance with the received *physicalConfigDedicated*;

1> if the *antennaInfo* is included and set to 'explicitValue':

2> if the configured *transmissionMode* is not 'tm3' or 'tm4' release *ri-ConfigIndex* in *cqi-ReportPeriodic*, if previously configured;

1> else if the *antennaInfo* is included and set to 'defaultValue':

2> release *ri-ConfigIndex* in *cqi-ReportPeriodic*, if previously configured;

8.2.4.13a.3 Test description

8.2.4.13a.3.1 Pre-test conditions

System Simulator:

- Cell 1 is FDD cell and Cell 28 is TDD cell.
- Each cell has only a single PLMN identity. The PLMNs are identified in the test by the identifiers in Table 8.2.4.13a.3.1-1.

Table 8.2.4.13a.3.1-1: PLMN identifiers

Cell	PLMN name
1	PLMN1
28	PLMN2

- System information combination 3 as defined in TS 36.508 [18] clause 4.4.3.1 and Table 6.3.1.2-2 is used in E-UTRA cells.

UE:

None.

Preamble:

- The UE is registered on PLMN1 (Cell 1) using the procedure described in TS 36.508[18] clause 4.5.2.3 except that the ATTACH ACCEPT message indicates PLMN2 in the Equivalent PLMN list as described in Table 8.2.4.13a.3.3-9.
- The UE is in state Generic RB Established (state 3) on Cell 1 according to [18].

8.2.4.13a.3.2 Test procedure sequence

Table 8.2.4.13a.3.2-1 illustrates the downlink power levels and other changing parameters to be applied for the cells at various time instants of the test execution. Row marked "T0" denotes the initial conditions after preamble, while columns marked "T1" is to be applied subsequently. The exact instants on which these values shall be applied are described in the texts in this clause.

Table 8.2.4.13a.3.2-1: Time instances of cell power level and parameter changes

	Parameter	Unit	Cell 1	Cell 28	Remark
T0	Cell-specific RS EPRE	dBm/15k Hz	-85	-97	The power level values are such that measurement results for Cell 1 (M1) and Cell 28 (M28) satisfy exit condition for event A3 ($M28 < M1$).
T1	Cell-specific RS EPRE	dBm/15k Hz	-85	-73	The power level values are such that measurement results for Cell 1 (M1) and Cell 28 (M28) satisfy entry condition for event A3 ($M28 > M1$).
T2	Cell-specific RS EPRE	dBm/15k Hz	-73	-85	The power level values are such that measurement results for Cell 1 (M1) and Cell 28 (M28) satisfy entry condition for event A3 ($M1 > M28$).

Table 8.2.4.13a.3.2-2: Main behaviour

St	Procedure	Message Sequence		TP	Verdict
		U - S	Message		
1	The SS transmits an <i>RRConnectionReconfiguration</i> message on Cell 1 to setup inter band measurement.	<--	<i>RRConnectionReconfiguration</i>	-	-
2	The UE transmits an <i>RRConnectionReconfigurationComplete</i> message on Cell 1.	-->	<i>RRConnectionReconfigurationComplete</i>	-	-
3	The SS changes Cell 28 power level according to the row "T1" in table 8.2.4.13a.3.2-1.	-	-	-	-
4	The UE transmits a <i>MeasurementReport</i> message on Cell 1 to report event A3 with the measured RSRP, RSRQ values for Cell 28.	-->	<i>MeasurementReport</i>	-	-
5	The SS transmits an <i>RRConnectionReconfiguration</i> message on Cell 1 to order the UE to perform inter band handover to Cell 28.	<--	<i>RRConnectionReconfiguration</i>	-	-
6	Check: Does the UE transmit an <i>RRConnectionReconfigurationComplete</i> message on Cell 28 to confirm the successful completion of the inter band handover?	-->	<i>RRConnectionReconfigurationComplete</i>	1	P
6A	The UE transmits a TRACKING AREA UPDATE REQUEST message on Cell 28.	-	-	-	-
6B	SS responds with a TRACKING AREA UPDATE ACCEPT message. NOTE: The TAU is accepted with PLMN1 listed as an Equivalent PLMN.	-	-	-	-
6C	The UE transmits a TRACKING AREA UPDATE COMPLETE message.	-	-	-	-
7	Check: Does the test result of generic test procedure in TS 36.508 subclause 6.4.2.3 indicate that the UE is in E-UTRA RRC_CONNECTED state on Cell 28?	-	-	1	-
8	The SS transmits an <i>RRConnectionReconfiguration</i> message on Cell 28 to setup inter band measurement.	<--	<i>RRConnectionReconfiguration</i>	-	-
9	The UE transmits an <i>RRConnectionReconfigurationComplete</i> message on Cell 28.	-->	<i>RRConnectionReconfigurationComplete</i>	-	-
10	The SS changes Cell 1 and Cell 28 power levels according to the row "T2" in table 8.2.4.13a.3.2-1.	-	-	-	-
11	The UE transmits a <i>MeasurementReport</i> message on Cell 28 to report event A3 with the measured RSRP, RSRQ values for Cell 1.	-->	<i>MeasurementReport</i>	-	-
12	The SS transmits an <i>RRConnectionReconfiguration</i> message on Cell 28 to order the UE to perform inter band handover to Cell 1.	<--	<i>RRConnectionReconfiguration</i>	-	-
13	Check: Does the UE transmit an <i>RRConnectionReconfigurationComplete</i> message on Cell 1 to confirm the successful completion of the inter band handover?	-->	<i>RRConnectionReconfigurationComplete</i>	2	P
13A	The UE transmits a TRACKING AREA UPDATE REQUEST message on Cell 1.	-	-	-	-
13B	SS responds with a TRACKING AREA UPDATE ACCEPT message. NOTE: The TAU is accepted with PLMN2 listed as an Equivalent PLMN.	-	-	-	-
13C	The UE transmits a TRACKING AREA UPDATE COMPLETE message.	-	-	-	-
14	Check: Does the test result of generic test procedure in TS 36.508 subclause 6.4.2.3 indicates that the UE is in E-UTRA RRC_CONNECTED state on Cell 1?	-	-	2	-

8.2.4.13a.3.3 Specific message contents

Table 8.2.4.13a.3.3-1: RRCConnectionReconfiguration (step 1 and step 8, Table 8.2.4.13a.3.2-2)

Derivation Path: 36.508, Table 4.6.1-8, condition MEAS

Table 8.2.4.13a.3.3-2: MeasConfig (step 1, Table 8.2.4.13a.3.3-1)

Derivation Path: 36.508, Table 4.6.6-1 condition INTER-FREQ			
Information Element	Value/remark	Comment	Condition
MeasConfig SEQUENCE {			
measObjectToAddModList SEQUENCE (SIZE (1..maxObjectId)) OF SEQUENCE {	2 entries		
measObjectId[1]	IdMeasObject-f1		
measObject[1]	MeasObjectEUTRA-GENERIC(f1)		
measObjectId[2]	IdMeasObject-f6		
measObject[2]	MeasObjectEUTRA-GENERIC(f6)		
}			
reportConfigToAddModList SEQUENCE (SIZE (1..maxReportConfigId)) OF SEQUENCE {	1 entry		
reportConfigId[1]	IdReportConfig-A3		
reportConfig[1]	ReportConfigEUTRA-A3		
}			
measIdToAddModList SEQUENCE (SIZE (1..maxMeasId)) OF SEQUENCE {	1 entry		
measId[1]	1		
measObjectId[1]	IdMeasObject-f6		
reportConfigId[1]	IdReportConfig-A3		
}			
}			

Table 8.2.4.13a.3.3-3: MeasurementReport (step 4, Table 8.2.4.13a.3.2-2)

Derivation Path: 36.508, Table 4.6.1-5			
Information Element	Value/remark	Comment	Condition
MeasurementReport ::= SEQUENCE {			
criticalExtensions CHOICE {			
c1 CHOICE{			
measurementReport-r8 SEQUENCE {			
measResults SEQUENCE {			
measId	1		
measResultServCell SEQUENCE {		Cell 1	
rsrpResult	(0..97)		
rsrqResult	(0..34)		
}			
measResultNeighCells CHOICE {			
measResultListEUTRA SEQUENCE (SIZE (1..maxCellReport)) OF SEQUENCE {	1 entry		
physCellId[1]	PhysicalCellIdentity of Cell 28		
cgi-Info[1]	Not present		
measResult[1] SEQUENCE {			
rsrpResult	(0..97)		
rsrqResult	(0..34)		
}			
}			
}			
}			
}			
}			
}			

Table 8.2.4.13a.3.3-4: RRCConnectionReconfiguration (step 5 and step 12, Table 8.2.4.13a.3.2-2)

Derivation Path: 36.508, Table 4.6.1-8, condition HO
--

Table 8.2.4.13a.3.3-5: MobilityControlInfo (step 5, Table 8.2.4.13a.3.3-4)

Derivation Path: 36.508, Table 4.6.5-1			
Information Element	Value/remark	Comment	Condition
MobilityControlInfo ::= SEQUENCE {			
targetPhysCellId	PhysicalCellIdentity of Cell 28		
carrierFreq SEQUENCE {			
dl-CarrierFreq	Same downlink EARFCN as used for Cell 28		
ul-CarrierFreq	Not present		
}			
}			

Table 8.2.4.13a.3.3-6: MeasConfig (step 8, Table 8.2.4.13a.3.3-1)

Derivation Path: 36.508, Table 4.6.6-1 condition INTER-FREQ			
Information Element	Value/remark	Comment	Condition
MeasConfig SEQUENCE {			
measObjectToAddModList SEQUENCE (SIZE (1..maxObjectId)) OF SEQUENCE {	2 entry		
measObjectId[1]	IdMeasObject-f6		
measObject[1]	MeasObjectEUTRA-GENERIC(f6)		
measObjectId[2]	IdMeasObject-f1		
measObject[2]	MeasObjectEUTRA-GENERIC(f1)		
}			
reportConfigToAddModList SEQUENCE (SIZE (1..maxReportConfigId)) OF SEQUENCE {	1 entry		
reportConfigId[1]	IdReportConfig-A3		
reportConfig[1]	ReportConfigEUTRA-A3		
}			
measIdToAddModList SEQUENCE (SIZE (1..maxMeasId)) OF SEQUENCE {	1 entry		
measId[1]	1		
measObjectId[1]	IdMeasObject-f1		
reportConfigId[1]	IdReportConfig-A3		
}			
}			

Table 8.2.4.13a.3.3-7: MeasurementReport (step 11, Table 8.2.4.13a.3.2-2)

Derivation Path: 36.508, Table 4.6.1-5			
Information Element	Value/remark	Comment	Condition
MeasurementReport ::= SEQUENCE {			
criticalExtensions CHOICE {			
c1 CHOICE{			
measurementReport-r8 SEQUENCE {			
measResults SEQUENCE {			
measId	1		
measResultServCell SEQUENCE {		Cell 28	
rsrpResult	(0..97)		
rsrqResult	(0..34)		
}			
measResultNeighCells CHOICE {			
measResultListEUTRA SEQUENCE (SIZE (1..maxCellReport)) OF SEQUENCE {	1 entry		
physCellId[1]	PhysicalCellIdentity of Cell 1		
cgi-Info[1]	Not present		
measResult[1] SEQUENCE {			
rsrpResult	(0..97)		
rsrqResult	(0..34)		
}			
}			
}			
}			
}			

Table 8.2.4.13a.3.3-8: *MobilityControlInfo* (step 12, Table 8.2.4.13a.3.3-4)

Derivation Path: 36.508, Table 4.6.5-1			
Information Element	Value/remark	Comment	Condition
<i>MobilityControlInfo</i> ::= SEQUENCE {			
targetPhysCellId	PhysicalCellId of Cell 1		
carrierFreq SEQUENCE {			
dl-CarrierFreq	Same downlink EARFCN as used for Cell 1		
ul-CarrierFreq	Not present		
}			
}			

Table 8.2.4.13a.3.3-9: ATTACH ACCEPT for Cell 1 (preamble)

Derivation path: 36.508 Table 4.7.2-1			
Information Element	Value/Remark	Comment	Condition
Equivalent PLMNs	PLMN2		

Table 8.2.4.13a.3.3-10: TRACKING AREA UPDATE ACCEPT for Cell 28 (step 6B, Table 8.2.4.13a.3.2-2)

Derivation path: 36.508 Table 4.7.2-24			
Information Element	Value/Remark	Comment	Condition
Equivalent PLMNs	PLMN1		

Table 8.2.4.13a.3.3-11: TRACKING AREA UPDATE ACCEPT for Cell 1 (step 13B, Table 8.2.4.13a.3.2-2)

Derivation path: 36.508 Table 4.7.2-24			
Information Element	Value/Remark	Comment	Condition
Equivalent PLMNs	PLMN2		

8.2.4.14 RRC connection reconfiguration / Handover / Failure / Re-establishment successful / Inter-band

8.2.4.14.1 Test Purpose (TP)

(1)

```

with { UE having completed the radio bearer establishment and initial security activation procedure
and after receiving an RRCConnectionReconfiguration message including a mobilityControlInfo
indicating a different E-UTRA cell having attempted inter-band handover }
ensure that {
  when { UE detects handover failure and the target cell is selectable }
  then { UE performs an RRC connection re-establishment procedure and remains in the E-UTRA
RRC_CONNECTED state }
}

```

8.2.4.14.2 Conformance requirements

References: The conformance requirements covered in the present TC are specified in: TS 36.331, clauses 5.3.5.4, 5.3.5.6, 5.3.7.2, 5.3.7.4, 5.3.7.5, 5.3.10.4 and 5.3.10.6.

[TS 36.331, clause 5.3.5.4]

If the *RRCConnectionReconfiguration* message includes the *mobilityControlInfo* and the UE is able to comply with the configuration included in this message, the UE shall:

- 1> stop timer T310, if running;
- 1> start timer T304 with the timer value set to *t304*, as included in the *mobilityControlInfo*;
- 1> if the *carrierFreq* is included:

2> consider the target cell to be one on the frequency indicated by the *carrierFreq* with a physical cell identity indicated by the *targetPhysCellId*;

1> else:

2> consider the target cell to be one on the current frequency with a physical cell identity indicated by the *targetPhysCellId*;

1> start synchronising to the DL of the target cell;

NOTE 1: The UE should perform the handover as soon as possible following the reception of the RRC message triggering the handover, which could be before confirming successful reception (HARQ and ARQ) of this message.

1> reset MAC;

1> re-establish PDCP for all RBs that are established;

NOTE 2: The handling of the radio bearers after the successful completion of the PDCP re-establishment, e.g. the re-transmission of unacknowledged PDCP SDUs (as well as the associated status reporting), the handling of the SN and the HFN, is specified in TS 36.323 [8].

1> re-establish RLC for all RBs that are established;

1> apply the value of the *newUE-Identity* as the C-RNTI;

1> if the *RRCConnectionReconfiguration* message includes the *fullConfig*:

2> perform the radio configuration procedure as specified in section 5.3.5.8;

1> configure lower layers in accordance with the received *radioResourceConfigCommon*;

1> configure lower layers in accordance with any additional fields, not covered in the previous, if included in the received *mobilityControlInfo*;

1> if the *RRCConnectionReconfiguration* message includes the *radioResourceConfigDedicated*:

2> perform the radio resource configuration procedure as specified in 5.3.10;

1> if the *keyChangeIndicator* received in the *securityConfigHO* is set to *TRUE*:

2> update the K_{eNB} key based on the fresh K_{ASME} key taken into use with the previous successful NAS SMC procedure, as specified in TS 33.401 [32];

1> else:

2> update the K_{eNB} key based on the current K_{eNB} or the NH, using the *nextHopChainingCount* value indicated in the *securityConfigHO*, as specified in TS 33.401 [32];

1> store the *nextHopChainingCount* value;

1> if the *securityAlgorithmConfig* is included in the *securityConfigHO*:

2> derive the K_{RRcint} key associated with the *integrityProtAlgorithm*, as specified in TS 33.401 [32];

2> derive the K_{RRcenc} key and the K_{UPenc} key associated with the *cipheringAlgorithm*, as specified in TS 33.401 [32];

1> else:

2> derive the K_{RRcint} key associated with the current integrity algorithm, as specified in TS 33.401 [32];

2> derive the K_{RRcenc} key and the K_{UPenc} key associated with the current ciphering algorithm, as specified in TS 33.401 [32];

1> configure lower layers to apply the integrity protection algorithm and the K_{RRcint} key, i.e. the integrity protection configuration shall be applied to all subsequent messages received and sent by the UE, including the message used to indicate the successful completion of the procedure;

- 1> configure lower layers to apply the ciphering algorithm, the K_{RRCEnc} key and the K_{UPenc} key, i.e. the ciphering configuration shall be applied to all subsequent messages received and sent by the UE, including the message used to indicate the successful completion of the procedure;
- 1> perform the measurement related actions as specified in 5.5.6.1;
- 1> if the *RRCCConnectionReconfiguration* message includes the *measConfig*:
 - 2> perform the measurement configuration procedure as specified in 5.5.2;
- 1> release *reportProximityConfig* and clear any associated proximity status reporting timer;
- 1> if the *RRCCConnectionReconfiguration* message includes the *reportProximityConfig*:
 - 2> perform the proximity indication in accordance with the received *reportProximityConfig*;
- 1> submit the *RRCCConnectionReconfigurationComplete* message to lower layers for transmission;
- 1> if MAC successfully completes the random access procedure:
 - 2> stop timer T304;
 - 2> apply the parts of the CQI reporting configuration, the scheduling request configuration and the sounding RS configuration that do not require the UE to know the SFN of the target cell, if any;
 - 2> apply the parts of the measurement and the radio resource configuration that require the UE to know the SFN of the target cell (e.g. measurement gaps, periodic CQI reporting, scheduling request configuration, sounding RS configuration), if any, upon acquiring the SFN of the target cell;

NOTE 3: Whenever the UE shall setup or reconfigure a configuration in accordance with a field that is received it applies the new configuration, except for the cases addressed by the above statements.

- 2> the procedure ends;

[TS 36.331, clause 5.3.5.6]

The UE shall:

- 1> if T304 expires (handover failure):

NOTE 4: Following T304 expiry any dedicated preamble, if provided within the *rach-ConfigDedicated*, is not available for use by the UE anymore.

- 2> revert back to the configuration used in the source cell, excluding the configuration configured by the *physicalConfigDedicated*, the *mac-MainConfig* and the *sps-Config*;
- 2> store the following handover failure information in *VarRLF-Report* by setting its fields as follows:
 - 3> clear the information included in *VarRLF-Report*, if any;
 - 3> set the *plmn-IdentityList* to include the list of EPLMNs stored by the UE (i.e. includes the RPLMN);
 - 3> set the *measResultLastServCell* to include the RSRP and RSRQ, if available, of the PCell based on measurements collected up to the moment the UE detected handover failure;

...

- 2> initiate the connection re-establishment procedure as specified in 5.3.7, upon which the RRC connection reconfiguration procedure ends;

[TS 36.331, clause 5.3.7.2]

The UE shall only initiate the procedure when AS security has been activated. The UE initiates the procedure when one of the following conditions is met:

...

- 1> upon handover failure, in accordance with 5.3.5.6; or

...

Upon initiation of the procedure, the UE shall:

- 1> stop timer T310, if running;
- 1> start timer T311;
- 1> suspend all RBs except SRB0;
- 1> reset MAC;
- 1> apply the default physical channel configuration as specified in 9.2.4;
- 1> apply the default semi-persistent scheduling configuration as specified in 9.2.3;
- 1> apply the default MAC main configuration as specified in 9.2.2;
- 1> release *reportProximityConfig* and clear any associated proximity status reporting timer;
- 1> perform cell selection in accordance with the cell selection process as specified in TS 36.304 [4];

[TS 36.331, clause 5.3.7.4]

The UE shall set the contents of *RRCCConnectionReestablishmentRequest* message as follows:

- 1> set the *ue-Identity* as follows:
 - 2> set the *c-RNTI* to the C-RNTI used in the source cell (handover and mobility from E-UTRA failure) or used in the cell in which the trigger for the re-establishment occurred (other cases);
 - 2> set the *physCellId* to the physical cell identity of the source cell (handover and mobility from E-UTRA failure) or of the cell in which the trigger for the re-establishment occurred (other cases);
 - 2> set the *shortMAC-I* to the 16 least significant bits of the MAC-I calculated:
 - 3> over the ASN.1 encoded as per section 8 (i.e., a multiple of 8 bits) *VarShortMAC-Input*;
 - 3> with the $K_{RRCCint}$ key and integrity protection algorithm that was used in the source cell (handover and mobility from E-UTRA failure) or of the cell in which the trigger for the re-establishment occurred (other cases); and
 - 3> with all input bits for COUNT, BEARER and DIRECTION set to binary ones;
- 1> set the *reestablishmentCause* as follows:
 - 2> if the re-establishment procedure was initiated due to reconfiguration failure as specified in 5.3.5.5 (the UE is unable to comply with the reconfiguration):
 - 3> set the *reestablishmentCause* to the value '*reconfigurationFailure*';
 - 2> else if the re-establishment procedure was initiated due to handover failure as specified in 5.3.5.6 (intra-LTE handover failure) or 5.4.3.5 (inter-RAT mobility from EUTRA failure):
 - 3> set the *reestablishmentCause* to the value '*handoverFailure*';

...

The UE shall submit the *RRCCConnectionReestablishmentRequest* message to lower layers for transmission.

[TS 36.331, clause 5.3.7.5]

NOTE 5: Prior to this, lower layer signalling is used to allocate a C-RNTI. For further details see TS 36.321 [6];

The UE shall:

- 1> stop timer T301;
- 1> re-establish PDCP for SRB1;

- 1> re-establish RLC for SRB1;
- 1> perform the radio resource configuration procedure in accordance with the received *radioResourceConfigDedicated* and as specified in 5.3.10;
- 1> resume SRB1;

NOTE 6: E-UTRAN should not transmit any message on SRB1 prior to receiving the *RRCCConnectionReestablishmentComplete* message.

- 1> update the K_{eNB} key based on the K_{ASME} key to which the current K_{eNB} is associated, using the *nextHopChainingCount* value indicated in the *RRCCConnectionReestablishment* message, as specified in TS 33.401 [32];
- 1> store the *nextHopChainingCount* value;
- 1> derive the K_{RRcInt} key associated with the previously configured integrity algorithm, as specified in TS 33.401 [32];
- 1> derive the K_{RRcEnc} key and the K_{UPenc} key associated with the previously configured ciphering algorithm, as specified in TS 33.401 [32];
- 1> configure lower layers to activate integrity protection using the previously configured algorithm and the K_{RRcInt} key immediately, i.e., integrity protection shall be applied to all subsequent messages received and sent by the UE, including the message used to indicate the successful completion of the procedure;
- 1> configure lower layers to apply ciphering using the previously configured algorithm, the K_{RRcEnc} key and the K_{UPenc} key immediately, i.e., ciphering shall be applied to all subsequent messages received and sent by the UE, including the message used to indicate the successful completion of the procedure;
- 1> set the content of *RRCCConnectionReestablishmentComplete* message as follows:
 - 2> if the UE has radio link failure or handover failure information available in *VarRLF-Report* and if the RPLMN is included in *plmn-IdentityList* stored in *VarRLF-Report*:
 - 3> include the *rlf-InfoAvailable*;
 - ...
- 1> perform the measurement related actions as specified in 5.5.6.1;
- 1> perform the measurement identity autonomous removal as specified in 5.5.2.2a;
- 1> submit the *RRCCConnectionReestablishmentComplete* message to lower layers for transmission, upon which the procedure ends;

[TS 36.331, clause 5.3.10.4]

The UE shall:

- 1> reconfigure the MAC main configuration in accordance with the received *mac-MainConfig*;

[TS 36.331, clause 5.3.10.6]

The UE shall:

- 1> reconfigure the physical channel configuration in accordance with the received *physicalConfigDedicated*;
- 1> if the *antennaInfo* is included and set to '*explicitValue*':
 - 2> if the configured *transmissionMode* is not '*tm3*' or '*tm4*' or '*tm8*':
 - 3> release *ri-ConfigIndex* in *cqi-ReportPeriodic*, if previously configured;
 - 2> if the configured *transmissionMode* is '*tm8*' and *pmi-RI-Report* is not present:
 - 3> release *ri-ConfigIndex* in *cqi-ReportPeriodic*, if previously configured;

1> else if the *antennaInfo* is included and set to '*defaultValue*':

2> release *ri-ConfigIndex* in *cqi-ReportPeriodic*, if previously configured;

8.2.4.14.3 Test description

8.2.4.14.3.1 Pre-test conditions

System Simulator:

- Cell 1 and Cell 10.
- System information combination 3 as defined in TS 36.508 [18] clause 4.4.3.1 is used in E-UTRA cells.

UE:

None.

Preamble:

- The UE is in state Generic RB Established (state 3) on Cell 1 according to [18].

8.2.4.14.3.2 Test procedure sequence

Table 8.2.4.14.3.2-1 illustrates the downlink power levels and other changing parameters to be applied for the cells at various time instants of the test execution. Row marked "T0" denotes the initial conditions after preamble, while columns marked "T1" and "T2" are to be applied subsequently. The exact instants on which these values shall be applied are described in the texts in this clause.

Table 8.2.4.14.3.2-1: Time instances of cell power level and parameter changes

	Parameter	Unit	Cell 1	Cell 10	Remark
T0	Cell-specific RS EPRE	dBm/15kHz	-85	-91	The power level values are such that measurement results for Cell 1 (M1) and Cell 10 (M10) satisfy exit condition for event A3 ($M10 < M1$).
T1	Cell-specific RS EPRE	dBm/15kHz	-85	-79	The power level values are such that measurement results for Cell 1 (M1) and Cell 10 (M10) satisfy entry condition for event A3 ($M10 > M1$).
T2	Cell-specific RS EPRE	dBm/15kHz	"Off"	-79	The power level values are assigned to satisfy $SrxlevCell\ 1 < 0$ such that selecting Cell 10 is guaranteed (NOTE 1).
NOTE 1: Power level "Off" is defined in TS36.508 Table 6.2.2.1-1.					

Table 8.2.4.14.3.2-2: Main behaviour

St	Procedure	Message Sequence		TP	Verdict
		U - S	Message		
1	The SS transmits an <i>RRConnectionReconfiguration</i> message to setup inter-band measurement on Cell 1.	<--	<i>RRConnectionReconfiguration</i>	-	-
2	The UE transmits an <i>RRConnectionReconfigurationComplete</i> message on Cell 1.	-->	<i>RRConnectionReconfigurationComplete</i>	-	-
3	The SS changes Cell 1 and Cell 10 parameters according to the row "T1" in table 8.2.4.14.3.2-1.	-	-	-	-
4	The UE transmits a <i>MeasurementReport</i> message on Cell 1 to report event A3 with the measured RSRP, RSRQ value for Cell 10.	-->	<i>MeasurementReport</i>	-	-
5	The SS transmits an <i>RRConnectionReconfiguration</i> message on Cell 1 to order the UE to perform inter-band handover to Cell 10.	<--	<i>RRConnectionReconfiguration</i>	-	-
-	EXCEPTION: In parallel to the events described in step 6 the steps specified in Table 8.2.4.14.3.2-3 should take place.	-	-	-	-
6	The SS changes Cell 1 and Cell 10 parameters according to the row "T2" in table 8.2.4.14.3.2-1.	-	-	-	-
7	Check: Does the UE transmit an <i>RRConnectionReestablishmentRequest</i> message on Cell 10?	-->	<i>RRConnectionReestablishmentRequest</i>	1	P
8	The SS transmits an <i>RRConnectionReestablishment</i> message to resume SRB1 operation and re-activate security on Cell 10.	<--	<i>RRConnectionReestablishment</i>	-	-
9	The UE transmits an <i>RRConnectionReestablishmentComplete</i> message on Cell 10.	-->	<i>RRConnectionReestablishmentComplete</i>	-	-
10	The SS transmits an <i>RRConnectionReconfiguration</i> message to resume existing radio bearer on Cell 10.	<--	<i>RRConnectionReconfiguration</i>	-	-
11	The UE transmits an <i>RRConnectionReconfigurationComplete</i> message on Cell 10.	-->	<i>RRConnectionReconfigurationComplete</i>	-	-
12	Check: Does the test result of generic test procedure in TS 36.508 subclause 6.4.2.3 indicate that the UE is in E-UTRA RRC_CONNECTED state on Cell 10?	-	-	1	-

Table 8.2.4.14.3.2-3: Parallel behaviour

St	Procedure	Message Sequence		TP	Verdict
		U - S	Message		
-	EXCEPTION: The steps 1 and 2 below are repeated for the duration of T304.	-	-	-	-
1	The UE attempts to perform the inter-band handover using MAC Random Access Preamble on Cell 10.	-	-	-	-
2	The SS does not respond.	-	-	-	-

8.2.4.14.3.3 Specific message contents

Table 8.2.4.14.3.3-1: SystemInformationBlockType2 for Cell 10 (preamble and all the steps in Table 8.2.4.14.3.2-2)

Derivation Path: 36.508, Table 4.4.3.3-1			
Information Element	Value/remark	Comment	Condition
SystemInformationBlockType2 ::= SEQUENCE {			
radioResourceConfigCommon SEQUENCE {			
rach-ConfigCommon SEQUENCE {			
ra-SupervisionInfo SEQUENCE {			
preambleTransMax	n50		
}			
}			
}			
lateNonCriticalExtension	Not present		
ssac-BarringForMMTEL-Voice-r9	Not present		
ssac-BarringForMMTEL-Video-r9	Not present		
}			

Table 8.2.4.14.3.3-2: RRCConnectionReconfiguration (step 1, Table 8.2.4.14.3.2-2)

Derivation Path: 36.508, Table 4.6.1-8, condition MEAS
--

Table 8.2.4.14.3.3-3: MeasConfig (Table 8.2.4.14.3.3-2)

Derivation Path: 36.508, Table 4.6.6-1 condition INTER-FREQ			
Information Element	Value/remark	Comment	Condition
MeasConfig ::= SEQUENCE {			
measObjectToAddModList SEQUENCE (SIZE (1..maxObjectId)) OF SEQUENCE {	2 entries		
measObjectId[1]	IdMeasObject-f1		
measObject[1]	MeasObjectEUTRA-GENERIC(f1)		
measObjectId[2]	IdMeasObject-f5		
measObject[2]	MeasObjectEUTRA-GENERIC(f5)		
}			
reportConfigToAddModList SEQUENCE (SIZE (1..maxReportConfigId)) OF SEQUENCE {	1 entry		
reportConfigId[1]	IdReportConfig-A3		
reportConfig[1]	ReportConfigEUTRA-A3		
}			
measIdToAddModList SEQUENCE (SIZE (1..maxMeasId)) OF SEQUENCE {	1 entry		
measId[1]	1		
measObjectId[1]	IdMeasObject-f5		
reportConfigId[1]	IdReportConfig-A3		
}			
}			

Table 8.2.4.14.3.3-4: MeasurementReport (step 4, Table 8.2.4.14.3.2-2)

Derivation Path: 36.508, Table 4.6.1-5			
Information Element	Value/remark	Comment	Condition
MeasurementReport ::= SEQUENCE {			
criticalExtensions CHOICE {			
c1 CHOICE{			
measurementReport-r8 SEQUENCE {			
measResults SEQUENCE {			
measId	1		
measResultServCell SEQUENCE {			
rsrpResult	(0..97)		
rsrqResult	(0..34)		
}			
measResultNeighCells CHOICE {			
measResultListEUTRA SEQUENCE (SIZE (1..maxCellReport)) OF SEQUENCE {	1 entry		
physCellId[1]	PhysicalCellIdentity of Cell 10		
cgi-Info[1]	Not present		
measResult[1] SEQUENCE {			
rsrpResult	(0..97)		
rsrqResult	(0..34)		
additionalSI-Info-r9	Not present		
}			
}			
}			
measResultForECID-r9	Not present		
}			
}			
}			

Table 8.2.4.14.3.3-5: RRCConnectionReconfiguration (step 5, Table 8.2.4.14.3.2-2)

Derivation Path: 36.508, Table 4.6.1-8, condition HO
--

Table 8.2.4.14.3.3-6: MobilityControlInfo (Table 8.2.4.14.3.3-5)

Derivation Path: 36.308, Table 4.6.5-1			
Information Element	Value/remark	Comment	Condition
MobilityControlInfo ::= SEQUENCE {			
targetPhysCellId	PhysicalCellIdentity of Cell 10		
carrierFreq SEQUENCE {			
dl-CarrierFreq	Same downlink EARFCN as used for Cell 10		
ul-CarrierFreq	Not present		
}			
rach-ConfigDedicated SEQUENCE {			
ra-PreambleIndex	63		
ra-PRACH-MaskIndex	0		
}			
}			

Table 8.2.4.14.3.3-7: RRCConnectionReestablishmentRequest (step 7, Table 8.2.4.14.3.2-2)

Derivation Path: 36.508, Table 4.6.1-13			
Information Element	Value/remark	Comment	Condition
RRCConnectionReestablishmentRequest ::= SEQUENCE {			
criticalExtensions CHOICE {			
rrcConnectionReestablishmentRequest-r8 SEQUENCE {			
ue-Identity SEQUENCE {			
c-RNTI	the value of the C-RNTI of the UE		
physCellId	PhysicalCellIdentity of Cell 1		
shortMAC-I	The same value as the 16 least significant bits of the XMAC-I value calculated by SS.		
}			
reestablishmentCause	handoverFailure		
}			
}			
}			

Table 8.2.4.14.3.3-8: RRCConnectionReestablishmentComplete (step 9, Table 8.2.4.14.3.2-2)

Derivation Path: 36.508, Table 4.6.1-11			
Information Element	Value/remark	Comment	Condition
RRCConnectionReestablishmentComplete ::= SEQUENCE {			
criticalExtensions CHOICE {			
rrcConnectionReestablishmentComplete-r8 SEQUENCE {			
nonCriticalExtension SEQUENCE {}	Not present		Rel-8 or Rel-9
nonCriticalExtension SEQUENCE {}			Rel-10 and above
rlf-InfoAvailable-r9	true		
nonCriticalExtension	Not present		
}			
}			
}			

Table 8.2.4.14.3.3-9: RRCConnectionReconfiguration (step 10, Table 8.2.4.14.3.2-2)

Derivation Path: 36.508, Table 4.6.1-8			
Information Element	Value/remark	Comment	Condition
RRCConnectionReconfiguration ::= SEQUENCE {			
criticalExtensions CHOICE {			
c1 CHOICE {			
rrcConnectionReconfiguration-r8 SEQUENCE {			
radioResourceConfigDedicated	RadioResourceConfigDedicated-HO		
}			
}			
}			
}			

8.2.4.14a RRC connection reconfiguration / Handover / Failure / Re-establishment successful / Inter-band / Between FDD and TDD

8.2.4.14a.1 Test Purpose (TP)

(1)

```
with { UE in E-UTRA FDD RRC_CONNECTED state and having completed the radio bearer establishment and
initial security activation procedure and after receiving an RRCConnectionReconfiguration message
including a mobilityControlInfo indicating a different E-UTRA TDD cell having attempted inter-mode
handover }
ensure that {
  when { UE detects handover failure and the initial E-UTRA TDD cell is selectable }
  then { UE performs an RRC connection re-establishment procedure and remains in the E-UTRA
RRC_CONNECTED state on the E-UTRA TDD cell }
}
```

(2)

```
with { UE in E-UTRA FDD RRC_CONNECTED state and having transmitted an
RRCConnectionReestablishmentRequest message on E-UTRA TDD cell }
ensure that {
  when { UE receives an RRCConnectionReestablishment message with a nextHopChainingCount which is
same as the NCC associated with the currently active KeNB }
  then { UE derives new KeNB from the currently active KeNB }
}
```

(3)

```
with { UE in E-UTRA TDD RRC_CONNECTED state and having completed the radio bearer establishment and
initial security activation procedure and after receiving an RRCConnectionReconfiguration message
including a mobilityControlInfo indicating a different E-UTRA FDD cell having attempted inter-mode
handover }
ensure that {
  when { UE detects handover failure and the initial E-UTRA FDD cell is selectable }
  then { UE performs an RRC connection re-establishment procedure and remains in the E-UTRA
RRC_CONNECTED state on the E-UTRA FDD cell }
}
```

(4)

```
with { UE in E-UTRA TDD RRC_CONNECTED state and having transmitted an
RRCConnectionReestablishmentRequest message on E-UTRA FDD cell }
ensure that {
  when { UE receives an RRCConnectionReestablishment message with a nextHopChainingCount which is
different from the NCC associated with the currently active KeNB }
  then { UE derives new KeNB from the nextHopChainingCount }
}
```

8.2.4.14a.2 Conformance requirements

References: The conformance requirements covered in the present TC are specified in: TS 36.331, clauses 5.3.5.4, 5.3.5.6, 5.3.7.2, 5.3.7.4, 5.3.7.5, 5.3.10.4 and 5.3.10.6.

[TS 36.331, clause 5.3.5.4]

If the *RRCConnectionReconfiguration* message includes the *mobilityControlInfo* and the UE is able to comply with the configuration included in this message, the UE shall:

- 1> stop timer T310, if running;
- 1> start timer T304 with the timer value set to *t304*, as included in the *mobilityControlInfo*;
- 1> if the *carrierFreq* is included:
 - 2> consider the target cell to be one on the frequency indicated by the *carrierFreq* with a physical cell identity indicated by the *targetPhysCellId*;
- 1> else:

- 2> consider the target cell to be one on the current frequency with a physical cell identity indicated by the *targetPhysCellId*;
 - 1> start synchronising to the DL of the target cell;
- NOTE 1: The UE should perform the handover as soon as possible following the reception of the RRC message triggering the handover, which could be before confirming successful reception (HARQ and ARQ) of this message.
- 1> reset MAC;
 - 1> re-establish PDCP for all RBs that are established;
- NOTE 2: The handling of the radio bearers after the successful completion of the PDCP re-establishment, e.g. the re-transmission of unacknowledged PDCP SDUs (as well as the associated status reporting), the handling of the SN and the HFN, is specified in TS 36.323 [8].
- 1> re-establish RLC for all RBs that are established;
 - 1> apply the value of the *newUE-Identity* as the C-RNTI;
 - 1> configure lower layers in accordance with the received *radioResourceConfigCommon*;
 - 1> configure lower layers in accordance with any additional fields, not covered in the previous, if included in the received *mobilityControlInfo*;
 - 1> if the *RRCConnectionReconfiguration* message includes the *radioResourceConfigDedicated*:
 - 2> perform the radio resource configuration procedure as specified in 5.3.10;
 - 1> if the *keyChangeIndicator* received in the *securityConfigHO* is set to *TRUE*:
 - 2> update the K_{eNB} key based on the fresh K_{ASME} key taken into use with the previous successful NAS SMC procedure, as specified in TS 33.401 [32];
 - 1> else:
 - 2> update the K_{eNB} key based on the current K_{eNB} or the NH, using the *nextHopChainingCount* value indicated in the *securityConfigHO*, as specified in TS 33.401 [32];
 - 1> store the *nextHopChainingCount* value;
 - 1> if the *securityAlgorithmConfig* is included in the *securityConfigHO*:
 - 2> derive the K_{RRcint} key associated with the *integrityProtAlgorithm*, as specified in TS 33.401 [32];
 - 2> derive the K_{RRcenc} key and the K_{UPenc} key associated with the *cipheringAlgorithm*, as specified in TS 33.401 [32];
 - 1> else:
 - 2> derive the K_{RRcint} key associated with the current integrity algorithm, as specified in TS 33.401 [32];
 - 2> derive the K_{RRcenc} key and the K_{UPenc} key associated with the current ciphering algorithm, as specified in TS 33.401 [32];
 - 1> configure lower layers to apply the integrity protection algorithm and the K_{RRcint} key, i.e. the integrity protection configuration shall be applied to all subsequent messages received and sent by the UE, including the message used to indicate the successful completion of the procedure;
 - 1> configure lower layers to apply the ciphering algorithm, the K_{RRcenc} key and the K_{UPenc} key, i.e. the ciphering configuration shall be applied to all subsequent messages received and sent by the UE, including the message used to indicate the successful completion of the procedure;
 - 1> perform the measurement related actions as specified in 5.5.6.1;
 - 1> if the *RRCConnectionReconfiguration* message includes the *measConfig*:

- 2> perform the measurement configuration procedure as specified in 5.5.2;
- 1> submit the *RRConnectionReconfigurationComplete* message to lower layers for transmission;
- 1> if MAC successfully completes the random access procedure:
 - 2> stop timer T304;
 - 2> apply the parts of the CQI reporting configuration, the scheduling request configuration and the sounding RS configuration that do not require the UE to know the SFN of the target cell, if any;
 - 2> apply the parts of the measurement and the radio resource configuration that require the UE to know the SFN of the target cell (e.g. measurement gaps, periodic CQI reporting, scheduling request configuration, sounding RS configuration), if any, upon acquiring the SFN of the target cell;

NOTE 3: Whenever the UE shall setup or reconfigure a configuration in accordance with a field that is received it applies the new configuration, except for the cases addressed by the above statements.

- 2> the procedure ends;

...

[TS 36.331, clause 5.3.5.6]

The UE shall:

- 1> if T304 expires (handover failure):

NOTE: Following T304 expiry any dedicated preamble, if provided within the *rach-ConfigDedicated*, is not available for use by the UE anymore.

- 2> revert back to the configuration used in the source cell, excluding the configuration configured by the *physicalConfigDedicated*, the *mac-MainConfig* and the *sps-Config*;
- 2> initiate the connection re-establishment procedure as specified in 5.3.7, upon which the RRC connection reconfiguration procedure ends;

[TS 36.331, clause 5.3.7.2]

The UE shall only initiate the procedure when AS security has been activated. The UE initiates the procedure when one of the following conditions is met:

...

- 1> upon handover failure, in accordance with 5.3.5.6; or

...

Upon initiation of the procedure, the UE shall:

- 1> stop timer T310, if running;
- 1> start timer T311;
- 1> suspend all RBs except SRB0;
- 1> reset MAC;
- 1> apply the default physical channel configuration as specified in 9.2.4;
- 1> apply the default semi-persistent scheduling configuration as specified in 9.2.3;
- 1> apply the default MAC main configuration as specified in 9.2.2;
- 1> perform cell selection in accordance with the cell selection process as specified in TS 36.304 [4];

[TS 36.331, clause 5.3.7.4]

The UE shall set the contents of *RRConnectionReestablishmentRequest* message as follows:

- 1> set the *ue-Identity* as follows:
 - 2> set the *c-RNTI* to the C-RNTI used in the source cell (handover and mobility from E-UTRA failure) or used in the cell in which the trigger for the re-establishment occurred (other cases);
 - 2> set the *physCellId* to the physical cell identity of the source cell (handover and mobility from E-UTRA failure) or of the cell in which the trigger for the re-establishment occurred (other cases);
 - 2> set the *shortMAC-I* to the 16 least significant bits of the MAC-I calculated:
 - 3> over the ASN.1 encoded as per section 8 (i.e., a multiple of 8 bits) *VarShortMAC-Input*;
 - 3> with the K_{RRcint} key and integrity protection algorithm that was used in the source cell (handover and mobility from E-UTRA failure) or of the cell in which the trigger for the re-establishment occurred (other cases); and
 - 3> with all input bits for COUNT, BEARER and DIRECTION set to binary ones;
- 1> set the *reestablishmentCause* as follows:
 - 2> if the re-establishment procedure was initiated due to reconfiguration failure as specified in 5.3.5.5 (the UE is unable to comply with the reconfiguration):
 - 3> set the *reestablishmentCause* to the value '*reconfigurationFailure*';
 - 2> else if the re-establishment procedure was initiated due to handover failure as specified in 5.3.5.6 (intra-LTE handover failure) or 5.4.3.5 (inter-RAT mobility from EUTRA failure):
 - 3> set the *reestablishmentCause* to the value '*handoverFailure*';

...

The UE shall submit the *RRConnectionReestablishmentRequest* message to lower layers for transmission.

[TS 36.331, clause 5.3.7.5]

NOTE: Prior to this, lower layer signalling is used to allocate a C-RNTI. For further details see TS 36.321 [6];

The UE shall:

- 1> stop timer T301;
- 1> re-establish PDCP for SRB1;
- 1> re-establish RLC for SRB1;
- 1> perform the radio resource configuration procedure in accordance with the received *radioResourceConfigDedicated* and as specified in 5.3.10;
- 1> resume SRB1;
- 1> update the K_{eNB} key based on the K_{ASME} key to which the current K_{eNB} is associated, using the *nextHopChainingCount* value indicated in the *RRConnectionReestablishment* message, as specified in TS 33.401 [32];
- 1> store the *nextHopChainingCount* value;
- 1> derive the K_{RRcint} key associated with the previously configured integrity algorithm, as specified in TS 33.401 [32];
- 1> derive the K_{RRcenc} key and the K_{UPenc} key associated with the previously configured ciphering algorithm, as specified in TS 33.401 [32];
- 1> configure lower layers to activate integrity protection using the previously configured algorithm and the K_{RRcint} key immediately, i.e., integrity protection shall be applied to all subsequent messages received and sent by the UE, including the message used to indicate the successful completion of the procedure;

- 1> configure lower layers to apply ciphering using the previously configured algorithm, the K_{RRCEnc} key and the K_{UPenc} key immediately, i.e., ciphering shall be applied to all subsequent messages received and sent by the UE, including the message used to indicate the successful completion of the procedure;
- 1> perform the measurement related actions as specified in 5.5.6.1;
- 1> submit the *RRConnectionReestablishmentComplete* message to lower layers for transmission, upon which the procedure ends;

[TS 36.331, clause 5.3.10.4]

The UE shall:

- 1> reconfigure the MAC main configuration in accordance with the received *mac-MainConfig*;

[TS 36.331, clause 5.3.10.6]

The UE shall:

- 1> reconfigure the physical channel configuration in accordance with the received *physicalConfigDedicated*;
- 1> if the *antennaInfo* is included and set to '*explicitValue*':
 - 2> if the configured *transmissionMode* is not '*tm3*' or '*tm4*' release *ri-ConfigIndex* in *cqi-ReportPeriodic*, if previously configured;
- 1> else if the *antennaInfo* is included and set to '*defaultValue*':
 - 2> release *ri-ConfigIndex* in *cqi-ReportPeriodic*, if previously configured;

8.2.4.14a.3 Test description

8.2.4.14a.3.1 Pre-test conditions

System Simulator:

- Cell 1 is FDD cell and Cell 28 is TDD cell.
- Cell 28 has a valid UE context
- Each cell has only a single PLMN identity. The PLMNs are identified in the test by the identifiers in Table 8.2.4.14a.3.1-1.

Table 8.2.4.14a.3.1-1: PLMN identifiers

Cell	PLMN name
1	PLMN1
28	PLMN2

- System information combination 3 as defined in TS 36.508 [18] clause 4.4.3.1 and Table 6.3.1.2-2 is used in E-UTRA cells.

UE:

None.

Preamble:

- The UE is registered on PLMN1 (Cell 1) using the procedure described in TS 36.508[18] clause 4.5.2.3 except that the ATTACH ACCEPT message indicates PLMN2 in the Equivalent PLMN list as described in Table 8.2.4.14a.3.3-15.
- The UE is in state Generic RB Established (state 3) on Cell 1 according to [18].

8.2.4.14a.3.2 Test procedure sequence

Table 8.2.4.14a.3.2-1 illustrates the downlink power levels and other changing parameters to be applied for the cells at various time instants of the test execution. Row marked "T0" denotes the initial conditions after preamble, while columns marked "T1", "T2", "T3" and "T4" are to be applied subsequently. The exact instants on which these values shall be applied are described in the texts in this clause.

Table 8.2.4.14a.3.2-1: Time instances of cell power level and parameter changes

	Parameter	Unit	Cell 1	Cell 28	Remark
T0	Cell-specific RS EPRE	dBm/15kHz	-85	-97	The power level values are such that measurement results for Cell 1 (M1) and Cell 28 (M28) satisfy exit condition for event A3 ($M28 < M1$).
T1	Cell-specific RS EPRE	dBm/15kHz	-85	-73	The power level values are such that measurement results for Cell 1 (M1) and Cell 28 (M28) satisfy entry condition for event A3 ($M28 > M1$).
T2	Cell-specific RS EPRE	dBm/15kHz	"Off"	-73	The power level values are assigned to satisfy $SrxlevCell\ 1 < 0$ such that selecting Cell 28 is guaranteed (NOTE 1).
T3	Cell-specific RS EPRE	dBm/15kHz	-85	-97	The power level values are such that measurement results for Cell 1 (M1) and Cell 28 (M28) satisfy entry condition for event A3 ($M1 > M28$).
T4	Cell-specific RS EPRE	dBm/15kHz	-85	"Off"	The power level values are assigned to satisfy $SrxlevCell\ 28 < 0$ such that selecting Cell 1 is guaranteed. (NOTE 1).
NOTE 1: Power level "Off" is defined in TS36.508 Table 6.2.2.1-1.					

Table 8.2.4.14a.3.2-2: Main behaviour

St	Procedure	Message Sequence		TP	Verdict
		U - S	Message		
1	The SS transmits an <i>RRConnectionReconfiguration</i> message to setup inter-band measurement on Cell 1.	<--	<i>RRConnectionReconfiguration</i>	-	-
2	The UE transmits an <i>RRConnectionReconfigurationComplete</i> message on Cell 1.	-->	<i>RRConnectionReconfigurationComplete</i>	-	-
3	The SS changes Cell 28 power level according to the row "T1" in table 8.2.4.14a.3.2-1.	-	-	-	-
4	The UE transmits a <i>MeasurementReport</i> message on Cell 1 to report event A3 with the measured RSRP, RSRQ value for Cell 28.	-->	<i>MeasurementReport</i>	-	-
5	The SS transmits an <i>RRConnectionReconfiguration</i> message on Cell 1 to order the UE to perform inter-band handover to Cell 28.	<--	<i>RRConnectionReconfiguration</i>	-	-
-	EXCEPTION: In parallel to the events described in step 6 the steps specified in Table 8.2.4.14a.3.2-3 should take place.	-	-	-	-
6	The SS changes Cell 1 power level according to the row "T2" in table 8.2.4.14a.3.2-1.	-	-	-	-
7	Check: Does the UE transmit an <i>RRConnectionReestablishmentRequest</i> message on Cell 28?	-->	<i>RRConnectionReestablishmentRequest</i>	1	P
8	The SS transmits an <i>RRConnectionReestablishment</i> message to resume SRB1 operation and re-activate security on Cell 28.	<--	<i>RRConnectionReestablishment</i>	-	-
9	Check: Does the UE transmit an <i>RRConnectionReestablishmentComplete</i> message using the security key derived from the currently active K_{eNB} on Cell 28?	-->	<i>RRConnectionReestablishmentComplete</i>	2	P
10	The SS transmits an <i>RRConnectionReconfiguration</i> message to resume existing radio bearer on Cell 28.	<--	<i>RRConnectionReconfiguration</i>	-	-
11	The UE transmits an <i>RRConnectionReconfigurationComplete</i> message on Cell 28.	-->	<i>RRConnectionReconfigurationComplete</i>	-	-
11A	The UE transmits a TRACKING AREA UPDATE REQUEST message on Cell 28.	-	-	-	-
11B	SS responds with a TRACKING AREA UPDATE ACCEPT message. NOTE: The TAU is accepted with PLMN1 listed as an Equivalent PLMN	-	-	-	-
11C	The UE transmits a TRACKING AREA UPDATE COMPLETE message.	-	-	-	-
12	The SS changes Cell 1 and Cell 28 power levels according to the row "T3" in table 8.2.4.14a.3.2-1.	-	-	-	-
13	The UE transmits a <i>MeasurementReport</i> message on Cell 28 to report event A3 with the measured RSRP, RSRQ value for Cell 1.	-->	<i>MeasurementReport</i>	-	-
14	The SS transmits an <i>RRConnectionReconfiguration</i> message on Cell 28 to order the UE to perform inter-band handover to Cell 1.	<--	<i>RRConnectionReconfiguration</i>	-	-
-	EXCEPTION: In parallel to the events described in step 15 the steps specified in Table 8.2.4.14a.3.2-4 should take place.	-	-	-	-
15	The SS changes Cell 28 power level according to the row "T4" in table 8.2.4.14a.3.2-1.	-	-	-	-
16	Check: Does the UE transmit an <i>RRConnectionReestablishmentRequest</i> message on Cell 1?	-->	<i>RRConnectionReestablishmentRequest</i>	3	P

17	The SS transmits an <i>RRCCConnectionReestablishment</i> message to resume SRB1 operation and re-activate security on Cell 1.	<--	<i>RRCCConnectionReestablishment</i>	-	-
18	Check: Does the UE transmit an <i>RRCCConnectionReestablishmentComplete</i> message using the security key derived from the <i>nextHopChainingCount</i> on Cell 1?	-->	<i>RRCCConnectionReestablishmentComplete</i>	4	P
19	The SS transmits an <i>RRCCConnectionReconfiguration</i> message to resume existing radio bearer on Cell 1.	<--	<i>RRCCConnectionReconfiguration</i>	-	-
20	The UE transmits an <i>RRCCConnectionReconfigurationComplete</i> message on Cell 1.	-->	<i>RRCCConnectionReconfigurationComplete</i>	-	-
20A	The UE transmits a TRACKING AREA UPDATE REQUEST message on Cell 1.	-	-	-	-
20B	SS responds with a TRACKING AREA UPDATE ACCEPT message. NOTE: The TAU is accepted with PLMN2 listed as an Equivalent PLMN	-	-	-	-
20C	The UE transmits a TRACKING AREA UPDATE COMPLETE message.	-	-	-	-
21	Check: Does the test result of generic test procedure in TS 36.508 subclause 6.4.2.3 indicate that the UE is in E-UTRA RRC_CONNECTED state on Cell 1?	-	-	3	-

Table 8.2.4.14a.3.2-3: Parallel behaviour

St	Procedure	Message Sequence		TP	Verdict
		U - S	Message		
-	EXCEPTION: The steps 1 and 2 below are repeated for the duration of T304.	-	-	-	-
1	The UE attempts to perform the inter-band handover using MAC Random Access Preamble on Cell 28.	-	-	-	-
2	The SS does not respond.	-	-	-	-

Table 8.2.4.14a.3.2-4: Parallel behaviour

St	Procedure	Message Sequence		TP	Verdict
		U - S	Message		
-	EXCEPTION: The steps 1 and 2 below are repeated for the duration of T304.	-	-	-	-
1	The UE attempts to perform the inter-band handover using MAC Random Access Preamble on Cell 1.	-	-	-	-
2	The SS does not respond.	-	-	-	-

8.2.4.14a.3.3 Specific message contents

Table 8.2.4.14a.3.3-0: SystemInformationBlockType2 for Cell 1 and Cell 28 (preamble and all the steps in Table 8.2.4.14a.3.2-2)

Derivation Path: 36.508, Table 4.6.3-12			
Information Element	Value/remark	Comment	Condition
ra-SupervisionInfo SEQUENCE {			
preambleTransMax	n50		
}			

Table 8.2.4.14a.3.3-1: RRCConnectionReconfiguration (step 1, Table 8.2.4.14a.3.2-2)

Derivation Path: 36.508, Table 4.6.1-8, condition MEAS

Table 8.2.4.14a.3.3-2: MeasConfig (Table 8.2.4.14a.3.3-1)

Derivation Path: 36.508, Table 4.6.6-1, condition INTER-FREQ			
Information Element	Value/remark	Comment	Condition
MeasConfig SEQUENCE {			
measObjectToAddModList SEQUENCE (SIZE (1..maxObjectId)) OF SEQUENCE {	2 entries		
measObjectId[1]	IdMeasObject-f1		
measObject[1]	MeasObjectEUTRA-GENERIC(f1)		
measObjectId[2]	IdMeasObject-f6		
measObject[2]	MeasObjectEUTRA-GENERIC(f6)		
}			
reportConfigToAddModList SEQUENCE (SIZE (1..maxReportConfigId)) OF SEQUENCE {	1 entry		
reportConfigId[1]	IdReportConfig-A3		
reportConfig[1]	ReportConfigEUTRA-A3		
}			
measIdToAddModList SEQUENCE (SIZE (1..maxMeasId)) OF SEQUENCE {	1 entry		
measId[1]	1		
measObjectId[1]	IdMeasObject-f6		
reportConfigId[1]	IdReportConfig-A3		
}			
}			

Table 8.2.4.14a.3.3-3: MeasurementReport (step 4, Table 8.2.4.14a.3.2-2)

Derivation Path: 36.508, Table 4.6.1-5			
Information Element	Value/remark	Comment	Condition
MeasurementReport ::= SEQUENCE {			
criticalExtensions CHOICE {			
c1 CHOICE{			
measurementReport-r8 SEQUENCE {			
measResults SEQUENCE {			
measId	1		
measResultServCell SEQUENCE {		Cell 1	
rsrpResult	(0..97)		
rsrqResult	(0..34)		
}			
measResultNeighCells CHOICE {			
measResultListEUTRA SEQUENCE (SIZE (1..maxCellReport)) OF SEQUENCE {	1 entry		
physCellId[1]	PhysicalCellIdentity of Cell 28		
cgi-Info[1]	Not present		
measResult[1] SEQUENCE {			
rsrpResult	(0..97)		
rsrqResult	(0..34)		
}			
}			
}			
}			
}			
}			

Table 8.2.4.14a.3.3-4: RRCConnectionReconfiguration (step 5, Table 8.2.4.14a.3.2-2)

Derivation Path: 36.508, Table 4.6.1-8, condition HO

Table 8.2.4.14a.3.3-5: MobilityControlInfo (Table 8.2.4.14a.3.3-4)

Derivation Path: 36.308, Table 4.6.5-1			
Information Element	Value/remark	Comment	Condition
MobilityControlInfo ::= SEQUENCE {			
targetPhysCellId	PhysicalCellId of Cell 28		
carrierFreq SEQUENCE {			
dl-CarrierFreq	Same downlink EARFCN as used for Cell 28		
ul-CarrierFreq	Not present		
}			
rach-ConfigDedicated SEQUENCE {			
ra-PreambleIndex	63		
ra-PRACH-MaskIndex	0		
}			
}			

Table 8.2.4.14a.3.3-6: RRCConnectionReestablishmentRequest (step 7, Table 8.2.4.14a.3.2-2)

Derivation Path: 36.508, Table 4.6.1-13			
Information Element	Value/remark	Comment	Condition
RRCConnectionReestablishmentRequest ::= SEQUENCE {			
criticalExtensions CHOICE {			
rrcConnectionReestablishmentRequest-r8 SEQUENCE {			
ue-Identity SEQUENCE {			
c-RNTI	the value of the C-RNTI of the UE		
physCellId	PhysicalCellId of Cell 1		
shortMAC-I	The same value as the 16 least significant bits of the XMAC-I value calculated by SS.		
}			
reestablishmentCause	handoverFailure		
}			
}			
}			

Table 8.2.4.14a.3.3-7: RRCConnectionReestablishment (step 8, Table 8.2.4.14a.3.2-2)

Derivation Path: 36.508, Table 4.6.1-10			
Information Element	Value/remark	Comment	Condition
RRCConnectionReestablishment ::= SEQUENCE {			
criticalExtensions CHOICE {			
c1 CHOICE {			
rrcConnectionReestablishment-r8 SEQUENCE {			
nextHopChainingCount	0		
}			
}			
}			
}			

Table 8.2.4.14a.3.3-7A: RRCConnectionReestablishmentComplete (step 9 and step 18, Table 8.2.4.14a.3.2-2)

Derivation Path: 36.508, Table 4.6.1-11			
Information Element	Value/remark	Comment	Condition
RRCConnectionReestablishmentComplete ::= SEQUENCE {			
criticalExtensions CHOICE {			
rrcConnectionReestablishmentComplete-r8 = SEQUENCE {			
nonCriticalExtension SEQUENCE {}	Not present		
}			
}			
}			

Table 8.2.4.14a.3.3-8: RRCConnectionReconfiguration (step 10 and step 19, Table 8.2.4.14a.3.2-2)

Derivation Path: 36.508, Table 4.6.1-8, condition MEAS			
Information Element	Value/remark	Comment	Condition
RRCConnectionReconfiguration ::= SEQUENCE {			
criticalExtensions CHOICE {			
c1 CHOICE{			
rrcConnectionReconfiguration-r8 SEQUENCE {			
radioResourceConfigDedicated	RadioResourceConfigDedicated-HO		
}			
}			
}			
}			

Table 8.2.4.14a.3.3-9: MeasConfig (Table 8.2.4.14a.3.3-8)

Derivation Path: 36.508, Table 4.6.6-1, condition INTER-FREQ			
--	--	--	--

Table 8.2.4.14a.3.3-10: MeasurementReport (step 13, Table 8.2.4.14a.3.2-2)

Derivation Path: 36.508, Table 4.6.1-5			
Information Element	Value/remark	Comment	Condition
MeasurementReport ::= SEQUENCE {			
criticalExtensions CHOICE {			
c1 CHOICE{			
measurementReport-r8 SEQUENCE {			
measResults SEQUENCE {			
measId	1		
measResultServCell SEQUENCE {		Cell 28	
rsrpResult	(0..97)		
rsrqResult	(0..34)		
}			
measResultNeighCells CHOICE {			
measResultListEUTRA SEQUENCE (SIZE (1..maxCellReport)) OF SEQUENCE {	1 entry		
physCellId[1]	PhysicalCellIdentity of Cell 1		
cgi-Info[1]	Not present		
measResult[1] SEQUENCE {			
rsrpResult	(0..97)		
rsrqResult	(0..34)		
}			
}			
}			
}			
}			
}			
}			

Table 8.2.4.14a.3.3-11: RRCConnectionReconfiguration (step 14, Table 8.2.4.14a.3.2-2)

Derivation Path: 36.508, Table 4.6.1-8, condition HO
--

Table 8.2.4.14a.3.3-12: MobilityControlInfo (Table 8.2.4.14a.3.3-10)

Derivation Path: 36.308, Table 4.6.5-1			
Information Element	Value/remark	Comment	Condition
MobilityControlInfo ::= SEQUENCE {			
targetPhysCellId	PhysicalCellIdentity of Cell 1		
carrierFreq SEQUENCE {			
dl-CarrierFreq	Same downlink EARFCN as used for Cell 1		
ul-CarrierFreq	Not present		
}			
rach-ConfigDedicated SEQUENCE {			
ra-PreambleIndex	63		
ra-PRACH-MaskIndex	0		
}			
}			

Table 8.2.4.14a.3.3-13: RRCConnectionReestablishmentRequest (step 16, Table 8.2.4.14a.3.2-2)

Derivation Path: 36.508, Table 4.6.1-13			
Information Element	Value/remark	Comment	Condition
RRCConnectionReestablishmentRequest ::= SEQUENCE {			
criticalExtensions CHOICE {			
rrcConnectionReestablishmentRequest-r8			
SEQUENCE {			
ue-Identity SEQUENCE {			
c-RNTI	the value of the C-RNTI of the UE		
physCellId	PhysicalCellIdentity of Cell 28		
shortMAC-I	The same value as the 16 least significant bits of the XMAC-I value calculated by SS.		
}			
reestablishmentCause	handoverFailure		
}			
}			

Table 8.2.4.14a.3.3-14: RRCConnectionReestablishment (step 17, Table 8.2.4.14a.3.2-2)

Derivation Path: 36.508, Table 4.6.1-10			
Information Element	Value/remark	Comment	Condition
RRCConnectionReestablishment ::= SEQUENCE {			
criticalExtensions CHOICE {			
c1 CHOICE{			
rrcConnectionReestablishment-r8 SEQUENCE {			
nextHopChainingCount	2		
}			
}			
}			
}			

Table 8.2.4.14a.3.3-15: ATTACH ACCEPT for Cell 1 (preamble)

Derivation path: 36.508 Table 4.7.2-1			
Information Element	Value/Remark	Comment	Condition
Equivalent PLMNs	PLMN2		

Table 8.2.4.14a.3.3-16: TRACKING AREA UPDATE ACCEPT for Cell 28 (step 11B, Table 8.2.4.14a.3.2-2)

Derivation path: 36.508 Table 4.7.2-24			
Information Element	Value/Remark	Comment	Condition
Equivalent PLMNs	PLMN1		

Table 8.2.4.14a.3.3-17: TRACKING AREA UPDATE ACCEPT for Cell 1 (step 20B, Table 8.2.4.14a.3.2-2)

Derivation path: 36.508 Table 4.7.2-24			
Information Element	Value/Remark	Comment	Condition
Equivalent PLMNs	PLMN2		

8.2.4.15 RRC connection reconfiguration / Handover / Failure / Re-establishment failure / Inter-band

8.2.4.15.1 Test Purpose (TP)

(1)

```
with { UE having completed the radio bearer establishment and initial security activation procedure
and after receiving an RRCConnectionReconfiguration message including an IE
mobilityControlInformation indicating a different E-UTRA cell having attempted inter-band handover }
ensure that {
  when { UE detects handover failure and fails an RRC connection re-establishment procedure }
  then { UE enters the E-UTRA RRC_IDLE state and trigger TAU procedure in order to recover RRC
connection }
}
```

8.2.4.15.2 Conformance requirements

References: The conformance requirements covered in the present TC are specified in: TS 36.331 clauses 5.3.5.4, 5.3.5.6, 5.3.7.2, 5.3.7.3, 5.3.7.4, 5.3.7.7 and 5.3.12

[TS 36.331, clause 5.3.5.4]

If the *RRCConnectionReconfiguration* message includes the *mobilityControlInfo* and the UE is able to comply with the configuration included in this message, the UE shall:

- 1> stop timer T310, if running;
- 1> start timer T304 with the timer value set to *t304*, as included in the *mobilityControlInfo*;
- 1> if the *carrierFreq* is included:
 - 2> consider the target cell to be one on the frequency indicated by the *carrierFreq* with a physical cell identity indicated by the *targetPhysCellId*;
- 1> else:
 - 2> consider the target cell to be one on the current frequency with a physical cell identity indicated by the *targetPhysCellId*;
- 1> start synchronising to the DL of the target cell;

NOTE 1: The UE should perform the handover as soon as possible following the reception of the RRC message triggering the handover, which could be before confirming successful reception (HARQ and ARQ) of this message.

- 1> reset MAC;
- 1> re-establish PDCP for all RBs that are established;

NOTE 2: The handling of the radio bearers after the successful completion of the PDCP re-establishment, e.g. the re-transmission of unacknowledged PDCP SDUs (as well as the associated status reporting), the handling of the SN and the HFN, is specified in TS 36.323 [8].

- 1> re-establish RLC for all RBs that are established;
- 1> apply the value of the *newUE-Identity* as the C-RNTI;
- 1> if the *RRCConnectionReconfiguration* message includes the *fullConfig*:
 - 2> perform the radio configuration procedure as specified in section 5.3.5.8;
- 1> configure lower layers in accordance with the received *radioResourceConfigCommon*;
- 1> configure lower layers in accordance with any additional fields, not covered in the previous, if included in the received *mobilityControlInfo*;
- 1> if the *RRCConnectionReconfiguration* message includes the *radioResourceConfigDedicated*:

- 2> perform the radio resource configuration procedure as specified in 5.3.10;
- 1> if the *keyChangeIndicator* received in the *securityConfigHO* is set to *TRUE*:
 - 2> update the K_{eNB} key based on the fresh K_{ASME} key taken into use with the previous successful NAS SMC procedure, as specified in TS 33.401 [32];
- 1> else:
 - 2> update the K_{eNB} key based on the current K_{eNB} or the NH, using the *nextHopChainingCount* value indicated in the *securityConfigHO*, as specified in TS 33.401 [32];
- 1> store the *nextHopChainingCount* value;
- 1> if the *securityAlgorithmConfig* is included in the *securityConfigHO*:
 - 2> derive the K_{RRCint} key associated with the *integrityProtAlgorithm*, as specified in TS 33.401 [32];
 - 2> derive the K_{RRCenc} key and the K_{UPenc} key associated with the *cipheringAlgorithm*, as specified in TS 33.401 [32];
- 1> else:
 - 2> derive the K_{RRCint} key associated with the current integrity algorithm, as specified in TS 33.401 [32];
 - 2> derive the K_{RRCenc} key and the K_{UPenc} key associated with the current ciphering algorithm, as specified in TS 33.401 [32];
- 1> configure lower layers to apply the integrity protection algorithm and the K_{RRCint} key, i.e. the integrity protection configuration shall be applied to all subsequent messages received and sent by the UE, including the message used to indicate the successful completion of the procedure;
- 1> configure lower layers to apply the ciphering algorithm, the K_{RRCenc} key and the K_{UPenc} key, i.e. the ciphering configuration shall be applied to all subsequent messages received and sent by the UE, including the message used to indicate the successful completion of the procedure;
- 1> perform the measurement related actions as specified in 5.5.6.1;
- 1> if the *RRCCConnectionReconfiguration* message includes the *measConfig*:
 - 2> perform the measurement configuration procedure as specified in 5.5.2;
- 1> release *reportProximityConfig* and clear any associated proximity status reporting timer;
- 1> if the *RRCCConnectionReconfiguration* message includes the *reportProximityConfig*:
 - 2> perform the proximity indication in accordance with the received *reportProximityConfig*;
- 1> submit the *RRCCConnectionReconfigurationComplete* message to lower layers for transmission;
- 1> if MAC successfully completes the random access procedure:
 - 2> stop timer T304;
 - 2> apply the parts of the CQI reporting configuration, the scheduling request configuration and the sounding RS configuration that do not require the UE to know the SFN of the target cell, if any;
 - 2> apply the parts of the measurement and the radio resource configuration that require the UE to know the SFN of the target cell (e.g. measurement gaps, periodic CQI reporting, scheduling request configuration, sounding RS configuration), if any, upon acquiring the SFN of the target cell;

NOTE 3: Whenever the UE shall setup or reconfigure a configuration in accordance with a field that is received it applies the new configuration, except for the cases addressed by the above statements.

- 2> the procedure ends;

NOTE 4: The UE is not required to determine the SFN of the target cell by acquiring system information from that cell before performing RACH access in the target cell.

[TS 36.331, clause 5.3.5.6]

The UE shall:

1> if T304 expires (handover failure):

NOTE 5: Following T304 expiry any dedicated preamble, if provided within the *rach-ConfigDedicated*, is not available for use by the UE anymore.

2> revert back to the configuration used in the source cell, excluding the configuration configured by the *physicalConfigDedicated*, the *mac-MainConfig* and the *sps-Config*;

2> initiate the connection re-establishment procedure as specified in 5.3.7, upon which the RRC connection reconfiguration procedure ends;

[TS 36.331, clause 5.3.7.2]

The UE shall only initiate the procedure when AS security has been activated. The UE initiates the procedure when one of the following conditions is met:

...

1> upon handover failure, in accordance with 5.3.5.6; or

...

Upon initiation of the procedure, the UE shall:

1> stop timer T310, if running;

1> start timer T311;

1> suspend all RBs except SRB0;

1> reset MAC;

1> apply the default physical channel configuration as specified in 9.2.4;

1> apply the default semi-persistent scheduling configuration as specified in 9.2.3;

1> apply the default MAC main configuration as specified in 9.2.2;

1> release *reportProximityConfig* and clear any associated proximity status reporting timer;

1> perform cell selection in accordance with the cell selection process as specified in TS 36.304 [4];

[TS 36.331, clause 5.3.7.3]

Upon selecting a suitable E-UTRA cell, the UE shall:

1> stop timer T311;

1> start timer T301;

1> apply the *timeAlignmentTimerCommon* included in *SystemInformationBlockType2*;

1> initiate transmission of the *RRCCConnectionReestablishmentRequest* message in accordance with 5.3.7.4;

NOTE 6: This procedure applies also if the UE returns to the source cell.

[TS 36.331, clause 5.3.7.4]

The UE shall set the contents of *RRCCConnectionReestablishmentRequest* message as follows:

1> set the *ue-Identity* as follows:

2> set the *c-RNTI* to the C-RNTI used in the source cell (handover and mobility from E-UTRA failure) or used in the cell in which the trigger for the re-establishment occurred (other cases);

- 2> set the *physCellId* to the physical cell identity of the source cell (handover and mobility from E-UTRA failure) or of the cell in which the trigger for the re-establishment occurred (other cases);
- 2> set the *shortMAC-I* to the 16 least significant bits of the MAC-I calculated:
 - 3> over the ASN.1 encoded as per section 8 (i.e., a multiple of 8 bits) *VarShortMAC-Input*;
 - 3> with the K_{RRCint} key and integrity protection algorithm that was used in the source cell (handover and mobility from E-UTRA failure) or of the cell in which the trigger for the re-establishment occurred (other cases); and
 - 3> with all input bits for COUNT, BEARER and DIRECTION set to binary ones;
- 1> set the *reestablishmentCause* as follows:
 - 2> if the re-establishment procedure was initiated due to reconfiguration failure as specified in 5.3.5.5 (the UE is unable to comply with the reconfiguration):
 - 3> set the *reestablishmentCause* to the value '*reconfigurationFailure*';
 - 2> else if the re-establishment procedure was initiated due to handover failure as specified in 5.3.5.6 (intra-LTE handover failure) or 5.4.3.5 (inter-RAT mobility from EUTRA failure):
 - 3> set the *reestablishmentCause* to the value '*handoverFailure*';
 - 2> else:
 - 3> set the *reestablishmentCause* to the value '*otherFailure*';

The UE shall submit the *RRCConnectionReestablishmentRequest* message to lower layers for transmission.

[TS 36.331, clause 5.3.7.6]

Upon T311 expiry, the UE shall:

- 1> perform the actions upon leaving RRC_CONNECTED as specified in 5.3.12, with release cause 'RRC connection failure';

[TS 36.331, clause 5.3.12]

Upon leaving RRC_CONNECTED, the UE shall:

- 1> reset MAC;
- 1> stop all timers that are running except T320;
- 1> release all radio resources, including release of the RLC entity, the MAC configuration and the associated PDCP entity for all established RBs;
- 1> indicate the release of the RRC connection to upper layers together with the release cause;
- 1> if leaving RRC_CONNECTED was not triggered by reception of the *MobilityFromEUTRACommand* message:
 - 2> enter RRC_IDLE and perform procedures as specified in TS 36.304 [4, 5.2.7];

8.2.4.15.3 Test description

8.2.4.15.3.1 Pre-test conditions

System Simulator:

- Cell 1 and Cell 10
- System information combination 3 as defined in TS 36.508 [18] clause 4.4.3.1 is used in E-UTRA cells.

UE:

None.

Preamble:

- The UE is in state Generic RB Established (state 3) on Cell 1 according to [18].

8.2.4.15.3.2 Test procedure sequence

Table 8.2.4.15.3.2-1 illustrates the downlink power levels and other changing parameters to be applied for the cells at various time instants of the test execution. Row marked "T0" denotes the initial conditions, while columns marked "T1" and "T2" are to be applied subsequently. The exact instants on which these values shall be applied are described in the texts in this clause.

Table 8.2.4.15.3.2-1: Time instances of cell power level and parameter changes

	Parameter	Unit	Cell 1	Cell 10	Remark
T0	Cell-specific RS EPRE	dBm/15 kHz	-85	-97	The power level values are such that measurement results for Cell 1 (M1) and Cell 10 (M10) satisfy exit condition for event A3 ($M1 > M10$)
T1	Cell-specific RS EPRE	dBm/15 kHz	-85	-73	The power level values are such that measurement results for Cell 1 (M1) and Cell 10 (M10) satisfy entry condition for event A3 ($M10 > M1$)
T2	Cell-specific RS EPRE	dBm/15 kHz	-85	"Off"	The power level values are such that $Srxlev_{Cell\ 1} > Srxlev_{Cell\ 10}$ and $Srxlev_{Cell\ 10} < 0$. (NOTE 1)
NOTE 1: Power level "Off" is defined in TS36.508 Table 6.2.2.1-1.					

Table 8.2.4.15.3.2-2: Main behaviour

St	Procedure	Message Sequence		TP	Verdict
		U - S	Message		
1	The SS transmits an <i>RRConnectionReconfiguration</i> message to setup inter-band measurement on Cell 1.	<--	<i>RRConnectionReconfiguration</i>	-	-
2	The UE transmits an <i>RRConnectionReconfigurationComplete</i> message on Cell 1.	-->	<i>RRConnectionReconfigurationComplete</i>	-	-
3	The SS changes Cell 1 and Cell 10 parameters according to the row "T1" in table 8.2.4.15.3.2-1.	-	-	-	-
4	The UE transmits a <i>MeasurementReport</i> message on Cell 1 to report event A3 with the measured RSRP and RSRQ value for Cell 10.	-->	<i>MeasurementReport</i>	-	-
5	The SS transmits an <i>RRConnectionReconfiguration</i> message on Cell 1 to order the UE to perform inter-band handover to Cell 10.	<--	<i>RRConnectionReconfiguration</i>	-	-
-	EXCEPTION: In parallel to the events described in step 6 the steps specified in Table 8.2.4.15.3.2-3 should take place.	-	-	-	-
6	The SS changes Cell 1 and Cell 10 parameters according to the row "T2" in table 8.2.4.15.3.2-1.	-	-	-	-
7	The UE transmits an <i>RRConnectionReestablishmentRequest</i> message on Cell 1.	-->	<i>RRConnectionReestablishmentRequest</i>	-	-
8	The SS does not respond to any <i>RRConnectionReestablishmentRequest</i> message and waits for 1s to ensure that T301 expires and the UE goes to RRC_IDLE state on Cell 1.	-	-	-	-
9-13	The UE will perform TAU procedure based on steps 1 to 5 of subclause 6.4.2.7 in TS 36.508 on Cell 1. NOTE: The UE performs a TAU procedure due to NAS signalling connection recovery.	-	-	-	-
14	Check: Does the test result of generic test procedure in TS 36.508 subclause 6.4.2.3 indicate that the UE is in E-UTRA RRC_CONNECTED state on Cell 1?	-	-	1	-
-	At the end of this test procedure sequence, the UE is in end state E-UTRA connected (E2_T3440) according to TS 36.508.	-	-	-	-

Table 8.2.4.15.3.2-3: Parallel behaviour

St	Procedure	Message Sequence		TP	Verdict
		U - S	Message		
-	EXCEPTION: The steps 1 and 2 below are repeated for the duration of T304	-	-	-	-
1	The UE attempts to perform the inter-band handover using MAC Random Access Preamble on Cell 10	-	-	-	-
2	The SS does not respond.	-	-	-	-

8.2.4.15.3.3 Specific message contents

Table 8.2.4.15.3.3-1: *RRConnectionReconfiguration* (step 1, Table 8.2.4.15.3.2-2)

Derivation Path: 36.508 Table 4.6.1-8, condition MEAS

Table 8.2.4.15.3.3-2: MeasConfig (Table 8.2.4.15.3.3-1)

Derivation Path: 36.508, Table 4.6.6-1, condition INTER-FREQ			
Information Element	Value/Remark	Comment	Condition
MeasConfig ::= SEQUENCE {			
measObjectToAddModList SEQUENCE (SIZE (1..maxObjectId)) OF SEQUENCE {	2 entries		
measObjectId[1]	IdMeasObject-f1		
measObject[1]	MeasObjectEUTRA-GENERIC(f1)		
measObjectId[2]	IdMeasObject-f5		
measObject[2]	MeasObjectEUTRA-GENERIC(f5)		
}			
reportConfigToAddModList SEQUENCE (SIZE (1..maxReportConfigId)) OF SEQUENCE {	1 entry		
reportConfigId[1]	IdReportConfig-A3		
reportConfig[1]	ReportConfig-A3		
}			
measIdToAddModList SEQUENCE (SIZE (1..maxMeasId)) OF SEQUENCE {	1 entry		
measId[1]	1		
measObjectId[1]	IdMeasObject-f5		
reportConfigId[1]	IdReportConfig-A3		
}			
}			

Table 8.2.4.15.3.3-3: MeasurementReport (step 4, Table 8.2.4.15.3.2-2)

Derivation Path: 36.508 Table 4.6.1-5			
Information Element	Value/remark	Comment	Condition
MeasurementReport ::= SEQUENCE {			
criticalExtensions CHOICE {			
c1 CHOICE{			
measurementReport-r8 SEQUENCE {			
measResults SEQUENCE {			
measId	1		
measResultServCell SEQUENCE {			
rsrpResult	(0..97)		
rsrqResult	(0..34)		
}			
measResultNeighCells CHOICE {			
measResultListEUTRA SEQUENCE (SIZE (1..maxCellReport)) OF SEQUENCE {	1 entry		
physCellId[1]	PhysicalCellIdentity of Cell 10		
cgi-Info[1]	Not present		
measResult[1] SEQUENCE {			
rsrpResult	(0..97)		
rsrqResult	(0..34)		
additionalSI-Info-r9	Not present		
}			
}			
}			
measResultForECID-r9	Not present		
}			
}			

Table 8.2.4.15.3.3-4: RRCConnectionReconfiguration (step 5, Table 8.2.4.15.3.2-2)

Derivation path: 36.508 Table 4.6.1-8, condition HO

Table 8.2.4.15.3.3-5: MobilityControlInfo (Table 8.2.4.15.3.3-4)

Derivation Path: 36.508 Table 4.6.5-1			
Information Element	Value/remark	Comment	Condition
MobilityControlInfo ::= SEQUENCE {			
targetPhysCellId	PhysicalCellId of Cell 10		
carrierFreq SEQUENCE {			
dl-CarrierFreq	Same downlink EARFCN as used for Cell 10		
ul-CarrierFreq	Not present		
}			
}			

Table 8.2.4.15.3.3-6: RRCConnectionReestablishmentRequest (step 7, Table 8.2.4.15.3.2-2)

Derivation Path: 36.508, Table 4.6.1-13			
Information Element	Value/remark	Comment	Condition
RRCConnectionReestablishmentRequest ::= SEQUENCE {			
criticalExtensions CHOICE {			
rrcConnectionReestablishmentRequest-r8 SEQUENCE {			
ue-Identity SEQUENCE {			
c-RNTI	The value of the C-RNTI of the UE		
physCellId	PhysicalCellId of Cell 1		
shortMAC-I	The same value as the 16 least significant bits of the XMAC-I value calculated by SS		
}			
reestablishmentCause	handoverFailure		
}			
}			
}			

8.2.4.15a RRC connection reconfiguration / Handover / Failure / Re-establishment failure / Inter-band / Between FDD and TDD

8.2.4.15a.1 Test Purpose (TP)

(1)

```

with { UE in E-UTRA FDD RRC_CONNECTED state and having completed the radio bearer establishment and initial security activation procedure on E-UTRA FDD cell and after receiving an RRCConnectionReconfiguration message including an IE mobilityControlInfo indicating a different E-UTRA TDD cell having attempted inter-mode handover }
ensure that {
  when { UE detects handover failure and fails an RRC connection re-establishment procedure }
  then { UE enters the E-UTRA FDD RRC_IDLE state and trigger TAU procedure in order to recover RRC connection on E-UTRA FDD cell }
}

```

(2)

```

with { UE in E-UTRA TDD RRC_CONNECTED state and having completed the radio bearer establishment and initial security activation procedure on E-UTRA TDD cell and after receiving an RRCConnectionReconfiguration message including an IE mobilityControlInfo indicating a different E-UTRA FDD cell having attempted inter-mode handover }

```

```

ensure that {
  when { UE detects handover failure and fails an RRC connection re-establishment procedure }
  then { UE enters the E-UTRA TDD RRC_IDLE state and trigger TAU procedure in order to recover RRC
connection on E-UTRA TDD cell }
}

```

8.2.4.15a.2 Conformance requirements

References: The conformance requirements covered in the present TC are specified in: 3GPP TS 36.331 clauses 5.3.5.4, 5.3.5.6, 5.3.7.2, 5.3.7.3, 5.3.7.4, 5.3.7.7 and 5.3.12.

[TS 36.331, clause 5.3.5.4]

...

If the *RRCCONNECTIONRECONFIGURATION* message includes the *mobilityControlInformation* and the UE is able to comply with the configuration included in this message, the UE shall:

1> stop timer T310, if running;

1> start timer T304 with the timer value set to t304, as included in the *mobilityControlInformation*;

1> request PDCP to initiate the PDCP Re-establishment procedure for all RBs that are established;

NOTE 2: The handling of the radio bearers after the successful completion of the L2 re-establishment, e.g. the re-transmission of unacknowledged PDCP SDUs (as well as the associated status reporting), the handling of the SN and the HFN, is specified in [8].

1> reset MAC and re-establish RLC for all RBs that are established;

1> If the *RRCCONNECTIONRECONFIGURATION* message includes the *radioResourceConfiguration*:

2> perform the Radio resource configuration procedure as specified in 5.3.10;

1> set the C-RNTI to the value of the *newUE-Identity*;

1> if the *eutra-CarrierFreq* is included:

2> consider the target cell to be one on the frequency indicated by the *eutra-CarrierFreq* with a physical cell identity indicated by the *targetCellIdentity*;

1> else:

2> consider the target cell to be one on the current frequency with a physical cell identity indicated by the *targetCellIdentity*;

1> if the *dl-Bandwidth* is included:

2> for the target cell, apply the downlink bandwidth indicated by the *dl-Bandwidth*;

1> else:

2> for the target cell, apply the same downlink bandwidth as for the current cell;

1> if the *ul-Bandwidth* is included:

2> for the target cell, apply the uplink bandwidth indicated by the *ul-Bandwidth*;

1> else:

2> for the target cell, apply the same uplink bandwidth as for the current cell;

1> configure lower layers in accordance with the received *radioResourceConfigCommon*;

1> If the *RRCCONNECTIONRECONFIGURATION* message includes the *securityConfiguration*:

2> apply the AS-derived keys associated with the AS-base key indicated by the *keyIndicator*;

- 2> configure lower layers to apply the indicated integrity protection algorithm, i.e. the indicated integrity protection configuration shall be applied to all subsequent messages received and sent by the UE in the target cell, including the message used to indicate the successful completion of the procedure;
- 2> configure lower layers to apply the indicated ciphering algorithm, i.e. the indicated ciphering configuration shall be applied to all subsequent messages received and sent by the UE in the target cell, including the message used to indicate the successful completion of the procedure;
- 1> If the *RRCCONNECTIONRECONFIGURATION* message includes the *MEASUREMENTCONFIGURATION*:
 - 2> perform the Measurement configuration procedure as specified in 5.5.2;
- 1> synchronise to the DL of the target cell;
- 1> submit the *RRCCONNECTIONRECONFIGURATIONCOMPLETE* message to lower layers for transmission using the new configuration;
- 1> If MAC successfully completes the random access procedure:
 - 2> stop timer T304;
 - 2> If the *PHYSICALCONFIGDEDICATED* is included in the *RRCCONNECTIONRECONFIGURATION* message:
 - 3> If the UE needs the SFN of the target cell to apply the PUCCH and Sounding RS configuration:
 - 4> apply the new PUCCH and Sounding RS configuration upon acquiring the SFN of the target cell;
 - 3> else:
 - 4> apply the new PUCCH and Sounding RS configuration;
 - 2> indicate to PDCP to complete the PDCP Re-establishment procedure for all DRBs that are established, if any;
 - 2> the procedure ends.

...

[TS 36.331, clause 5.3.5.6]

The UE shall:

- 1> If T304 expires (handover failure):

NOTE 1: Following T304 expiry dedicated preambles, if provided within the *rach-ConfigDedicated*, are not available for use by the UE anymore.

- 2> revert back to the configuration used in the source cell, excluding the physical layer configuration;

NOTE 2: The UE reverts to the RRC configuration as well as the layer 2 configuration (PDCP/RLC/MAC) used in the source cell.

- 2> initiate the connection re-establishment procedure as specified in 5.3.7, upon which the RRC connection reconfiguration procedure ends.

[TS 36.331, clause 5.3.7.2]

The UE shall only initiate the procedure when security has been activated. The UE initiates the procedure when one of the following conditions is met:

...

- 1> upon handover failure, in accordance with 5.3.5.6; or

...

Upon initiation of the procedure, the UE shall:

...

1> start timer T311;

1> request PDCP to initiate the PDCP Re-establishment procedure for all RBs that are established;

NOTE 1: The handling of the radio bearers after the successful completion of the L2 re-establishment, e.g. the re-transmission of unacknowledged PDCP SDUs (as well as the associated status reporting), the handling of the SN and the HFN, is specified in [8].

1> reset MAC and re-establish RLC for all RBs that are established;

1> select a suitable cell in accordance with the cell selection process as specified in [4];

[TS 36.331, clause 5.3.7.3]

...

2> initiate transmission of the *RRCCConnectionReestablishmentRequest* message in accordance with 5.3.7.4;

...

[TS 36.331, clause 5.3.7.4]

The UE shall set the contents of *RRCCConnectionReestablishmentRequest* message as follows:

1> set the IE *ue-Identity* as follows:

2> set the *c-RNTI* to the C-RNTI used in the source cell (handover failure case) or used in the cell in which the trigger for the re-establishment occurred (other cases);

2> set the *cellIdentity* to the Physical layer identity of the source cell (handover failure case) or of the cell in which the trigger for the re-establishment occurred (other cases);

2> set the *shortMAC-I* to the 16 least significant bits of the MAC-I calculated:

3> over the concatenation of the ASN.1 encoded *CellIdentity* of the current cell, *PhysicalCellIdentity* of the cell the UE was connected to prior to the failure and C-RNTI that the UE had in the cell it was connected to prior to the failure;

3> with the integrity protection key and integrity protection algorithm that was used in the cell the UE was connected to prior to the failure; and

3> with all input bits for COUNT, BEARER and DIRECTION set to binary ones.

1> set the IE *reestablishmentCause* as follows:

...

2> else if the re-establishment procedure was initiated due to handover failure as specified in 5.3.5.6 (intra-LTE handover failure) or 5.4.3.5 (inter-RAT mobility from EUTRA failure):

3> set the *reestablishmentCause* to the value '*handoverFailure*';

...

The UE shall submit the *RRCCConnectionReestablishmentRequest* message to lower layers for transmission.

[TS 36.331, clause 5.3.7.7]

Upon T311 expiry, the UE shall:

1> perform the actions upon moving from RRC_CONNECTED to RRC_IDLE as specified in 5.3.12.

...

[TS 36.331, clause 5.3.12]

Upon moving from RRC_CONNECTED to RRC_IDLE, the UE shall:

1> reset MAC and re-establish RLC for all RBs that are established;

...

1> stop all timers that are running except T320;

1> release all radio resources, including release of the RLC entity and the associated PDCP entity for all established RBs;

1> indicate the release of the RRC connection to upper layers;

1> enter RRC_IDLE.

8.2.4.15a.3 Test description

8.2.4.15a.3.1 Pre-test conditions

System Simulator:

- Cell 1 is an LTE FDD cell, Cell 10 and Cell 30 are LTE TDD cells.
- Each cell has only a single PLMN identity. The PLMNs are identified in the test by the identifiers in Table 8.2.4.15 a.3.1-1.

Table 8.2.4.15 a.3.1-1: PLMN identifiers

Cell	PLMN name
1	PLMN1
10	PLMN1
30	PLMN2

- System information combination 3 as defined in TS 36.508 [18] clause 4.4.3.1 and Table 6.3.1.2-2 is used in E-UTRA cells.

UE:

None.

Preamble:

- The UE is registered on PLMN1 (Cell 1) using the procedure described in TS 36.508[18] clause 4.5.2.3 except that the ATTACH ACCEPT message indicates PLMN2 in the Equivalent PLMN list as described in Table 8.2.4.15a.3.3-13.
- The UE is in state Generic RB Established (state 3) on Cell 1 according to [18].

8.2.4.15a.3.2 Test procedure sequence

Table 8.2.4.15a.3.2-1 illustrates the downlink power levels and other changing parameters to be applied for the cells at various time instants of the test execution. Row marked "T0" denotes the initial conditions, while columns marked "T1", "T2", "T3", "T4" and "T5" are to be applied subsequently. The exact instants on which these values shall be applied are described in the texts in this clause.

Table 8.2.4.15a.3.2-1: Time instances of cell power level and parameter changes

	Parameter	Unit	Cell 1	Cell 10	Cell 30	Remark
T0	Cell-specific RS EPRE	dBm/15k Hz	-85	-97	"Off"	The power level values are such that measurement results for Cell 1 (M1) and Cell 10 (M10) satisfy exit condition for event A3 ($M10 < M1$).
T1	Cell-specific RS EPRE	dBm/15k Hz	-85	-73	"Off"	The power level values are such that measurement results for Cell 1 (M1) and Cell 10 (M10) satisfy entry condition for event A3 ($M10 > M1$).
T2	Cell-specific RS EPRE	dBm/15k Hz	-85	"Off"	"Off"	The power level values are assigned to satisfy $SrxlevCell\ 10 < 0$ such that selecting Cell 1 is guaranteed (NOTE 1).
T3	Cell-specific RS EPRE	dBm/15k Hz	-85	"Off"	-73	The power level values are such that measurement results for Cell 1 (M1) and Cell 30 (M30) satisfy entry condition for event A3 ($M30 > M1$). (NOTE 1).
T4	Cell-specific RS EPRE	dBm/15k Hz	-73	"Off"	-85	The power level values are such that measurement results for Cell 30 (M30) satisfy entry condition for event A3 ($M1 > M30$). (NOTE 1).
T5	Cell-specific RS EPRE	dBm/15k Hz	"Off"	"Off"	-85	The power level values are assigned to satisfy $SrxlevCell\ 1 < 0$ such that selecting Cell 30 is guaranteed (NOTE 1).
NOTE 1: Power level "Off" is defined in TS36.508 Table 6.2.2.1-1.						

Table 8.2.4.15a.3.2-2: Main behaviour

St	Procedure	Message Sequence		TP	Verdict
		U - S	Message		
1	The SS transmits an <i>RRConnectionReconfiguration</i> message to setup inter-band measurement on Cell 1 for Cell 10.	<--	<i>RRConnectionReconfiguration</i>	-	-
2	The UE transmits an <i>RRConnectionReconfigurationComplete</i> message on Cell 1.	-->	<i>RRConnectionReconfigurationComplete</i>	-	-
3	The SS changes Cell 10 parameters according to the row "T1" in table 8.2.4.15a.3.2-1.	-	-	-	-
4	The UE transmits a <i>MeasurementReport</i> message on Cell 1 to report event A3 with the measured RSRP and RSRQ value for Cell 10.	-->	<i>MeasurementReport</i>	-	-
5	The SS transmits an <i>RRConnectionReconfiguration</i> message on Cell 1 to order the UE to perform inter-band handover to Cell 10.	<--	<i>RRConnectionReconfiguration</i>	-	-
-	EXCEPTION: In parallel to the events described in step 6 the steps specified in Table 8.2.4.15a.3.2-3 should take place.	-	-	-	-
6	The SS changes Cell 10 parameters according to the row "T2" in table 8.2.4.15a.3.2-1.	-	-	-	-
7	The UE transmits an <i>RRConnectionReestablishmentRequest</i> message on Cell 1.	-->	<i>RRConnectionReestablishmentRequest</i>	-	-
8	The SS does not respond to any <i>RRConnectionReestablishmentRequest</i> message and waits for 1s to ensure that T301 expires and the UE goes to RRC_IDLE state on Cell 1.	-	-	-	-
9	Generic test procedure described in TS 36.508 subclause 6.4.2.7 is performed on Cell 1 NOTE: The UE performs a TAU procedure due to NAS signalling connection recovery. NOTE: The TAU is accepted with PLMN2 listed as an Equivalent PLMN	-	-	-	-
10	Generic test procedure described in TS 36.508 subclause 4.5.3.3 is executed	-	-	1	-
11	The SS transmits an <i>RRConnectionReconfiguration</i> message to setup inter-band measurement on Cell 1 for Cell 30.	<--	<i>RRConnectionReconfiguration</i>	-	-
12	The UE transmits an <i>RRConnectionReconfigurationComplete</i> message on Cell 1.	-->	<i>RRConnectionReconfigurationComplete</i>	-	-
13	The SS changes Cell 30 parameters according to the row "T3" in table 8.2.4.15a.3.2-1.	-	-	-	-
14	The UE transmits a <i>MeasurementReport</i> message on Cell 1 to report event A3 with the measured RSRP and RSRQ value for Cell 30.	-->	<i>MeasurementReport</i>	-	-
15	The SS transmits an <i>RRConnectionReconfiguration</i> message on Cell 1 to order the UE to perform inter-band handover to Cell 30.	<--	<i>RRConnectionReconfiguration</i>	-	-
16	The UE transmits an <i>RRConnectionReconfigurationComplete</i> message on Cell 30 to confirm the successful handover	-->	<i>RRConnectionReconfigurationComplete</i>	-	-
17	The UE transmits a TRACKING AREA UPDATE REQUEST message on Cell 30.	-	-	-	-
18	SS responds with a TRACKING AREA UPDATE ACCEPT message. NOTE: The TAU is accepted with PLMN1 listed as an Equivalent PLMN	-	-	-	-

19	The UE transmits a TRACKING AREA UPDATE COMPLETE message.	-	-	-	-
20	The SS changes Cell 1 and Cell 30 parameters according to the row "T4" in table 8.2.4.15a.3.2-1.	-	-	-	-
21	The UE transmits a <i>MeasurementReport</i> message on Cell 30 to report event A3 with the measured RSRP and RSRQ value for Cell 1.	-->	<i>MeasurementReport</i>	-	-
22	The SS transmits an <i>RRCCONNECTIONRECONFIGURATION</i> message on Cell 30 to order the UE to perform inter-band handover to Cell 1.	<--	<i>RRCCONNECTIONRECONFIGURATION</i>	-	-
-	EXCEPTION: In parallel to the events described in step 26 the steps specified in Table 8.2.4.15a.3.2-4 should take place.	-	-	-	-
23	The SS changes Cell 1 parameters according to the row "T5" in table 8.2.4.15a.3.2-1.	-	-	-	-
24	The UE transmits an <i>RRCCONNECTIONREESTABLISHMENTREQUEST</i> message on Cell 30.	-->	<i>RRCCONNECTIONREESTABLISHMENTREQUEST</i>	-	-
25	The SS does not respond to any <i>RRCCONNECTIONREESTABLISHMENTREQUEST</i> message and waits for 1s to ensure that T301 expires and the UE goes to RRC_IDLE state on Cell 30.	-	-	-	-
26-30	The UE will perform TAU procedure based on steps 1 to 5 of subclause 6.4.2.7 in TS 36.508 on Cell 30. NOTE: The UE performs a TAU procedure due to NAS signalling connection recovery or TAI change. NOTE: The TAU is accepted with PLMN1 listed as an Equivalent PLMN	-	-	-	-
31	Check: Does the test result of generic test procedure in TS 36.508 subclause 6.4.2.3 indicate that the UE is in E-UTRA RRC_CONNECTED state on Cell 30?	-	-	2	-
-	At the end of this test procedure sequence, the UE is in end state E-UTRA connected (E2_T3440) according to TS 36.508.	-	-	-	-

Table 8.2.4.15a.3.2-3: Parallel behaviour

St	Procedure	Message Sequence		TP	Verdict
		U - S	Message		
-	EXCEPTION: The steps 1 and 2 below are repeated for the duration of T304	-	-	-	-
1	The UE attempts to perform the inter-band handover using MAC Random Access Preamble on Cell 10	-	-	-	-
2	The SS does not respond.	-	-	-	-

Table 8.2.4.15a.3.2-4: Parallel behaviour

St	Procedure	Message Sequence		TP	Verdict
		U - S	Message		
-	EXCEPTION: The steps 1 and 2 below are repeated for the duration of T304	-	-	-	-
1	The UE attempts to perform the inter-band handover using MAC Random Access Preamble on Cell 1	-	-	-	-
2	The SS does not respond.	-	-	-	-

8.2.4.15a.3.3 Specific message contents

Table 8.2.4.15a.3.3-1: RRCConnectionReconfiguration (step 1 and step 11, Table 8.2.4.15a.3.2-2)

Derivation path: 36.508 Table 4.6.1-8, condition MEAS

Table 8.2.4.15a.3.3-2: MeasConfig (step 1 and step 11, Table 8.2.4.15a.3.3-1)

Derivation Path: 36.508, Table 4.6.6-1, condition INTER-FREQ			
Information Element	Value/remark	Comment	Condition
MeasConfig ::= SEQUENCE {			
measObjectToAddModList SEQUENCE (SIZE (1..maxObjectId)) OF SEQUENCE {	2 entries		
measObjectId[1]	IdMeasObject-f1		
measObject[1]	MeasObjectEUTRA-GENERIC(f1)		
measObjectId[2]	IdMeasObject-f5		
measObject[2]	MeasObjectEUTRA-GENERIC(f5)		
}			
reportConfigToAddModList SEQUENCE (SIZE (1..maxReportConfigId)) OF SEQUENCE {	1 entry		
reportConfigId[1]	IdReportConfig-A3		
reportConfig[1]	ReportConfigEUTRA-A3		
}			
measIdToAddModList SEQUENCE (SIZE (1..maxMeasId)) OF SEQUENCE {	1 entry		
measId[1]	1		
measObjectId[1]	IdMeasObject-f5		
reportConfigId[1]	IdReportConfig-A3		
}			
}			

Table 8.2.4.15a.3.3-3: MeasurementReport (step 4, Table 8.2.4.15a.3.2-2)

Derivation path: 36.508 Table 4.6.1-5			
Information Element	Value/Remark	Comment	Condition
MeasurementReport ::= SEQUENCE {			
criticalExtensions CHOICE {			
c1 CHOICE{			
measurementReport-r8 SEQUENCE {			
measResults SEQUENCE {			
measId	1		
measResultServCell SEQUENCE {		Cell 1	
rsrpResult	(0..97)		
rsrqResult	(0..34)		
}			
measResultNeighCells CHOICE {			
measResultListEUTRA SEQUENCE (SIZE (1..maxCellReport)) OF SEQUENCE {	1 entry		
physCellId[1]	PhysicalCellIdentity of Cell 10		
cgi-Info[1]	Not present		
measResult[1] SEQUENCE {			
rsrpResult	(0..97)		
rsrqResult	(0..34)		
}			
}			
}			
}			
}			
}			

Table 8.2.4.15a.3.3-4: RRCConnectionReconfiguration (step 5 and step 22, Table 8.2.4.15a.3.2-2)

Derivation path: 36.508 Table 4.6.1-8, condition HO

Table 8.2.4.15a.3.3-4A: RRCConnectionReconfiguration (step 15, Table 8.2.4.15a.3.2-2)

Derivation path: 36.508 Table 4.6.1-8, condition HO and condition MEAS
--

Table 8.2.4.15a.3.3-4B: MeasConfig (step 15 Table 8.2.4.15a.3.3-4A)

Derivation Path: 36.508, Table 4.6.6-1, condition INTER-FREQ
--

Table 8.2.4.15a.3.3-5: MobilityControlInfo (step 5, Table 8.2.4.15a.3.3-4)

Derivation Path: 36.508 Table 4.6.5-1			
Information Element	Value/remark	Comment	Condition
MobilityControlInfo ::= SEQUENCE {			
targetPhysCellId	PhysicalCellIdentity of Cell 10		
carrierFreq SEQUENCE {			
dl-CarrierFreq	Same downlink EARFCN as used for Cell 10		
ul-CarrierFreq	Not present		
}			
}			

Table 8.2.4.15a.3.3-6: RRCConnectionReestablishmentRequest (step 7, Table 8.2.4.15a.3.2-2)

Derivation path: 36.508 Table 4.6.1-13			
Information Element	Value/Remark	Comment	Condition
RRCConnectionReestablishmentRequest ::= SEQUENCE { criticalExtensions CHOICE { rrcConnectionReestablishmentRequest-r8 SEQUENCE { ue-Identity SEQUENCE { c-RNTI physCellId shortMAC-I } reestablishmentCause } } }			
c-RNTI	The value of the C-RNTI of the UE.		
physCellId	PhysicalCellIdentity of Cell 1		
shortMAC-I	The same value as the 16 least significant bits of the XMAC-I value calculated by SS		
reestablishmentCause	handoverFailure		

Table 8.2.4.15a.3.3-7: MeasurementReport (step 14, Table 8.2.4.15a.3.2-2)

Derivation path: 36.508 Table 4.6.1-5			
Information Element	Value/Remark	Comment	Condition
MeasurementReport ::= SEQUENCE { criticalExtensions CHOICE { c1 CHOICE { measurementReport-r8 SEQUENCE { measResults SEQUENCE { measId measResultServCell SEQUENCE { rsrpResult rsrqResult } measResultNeighCells CHOICE { measResultListEUTRA SEQUENCE (SIZE (1..maxCellReport)) OF SEQUENCE { physCellId[1] cgi-Info[1] measResult[1] SEQUENCE { rsrpResult rsrqResult } } } } } }			
measId	1		
measResultServCell		Cell 1	
rsrpResult	(0..97)		
rsrqResult	(0..34)		
measResultListEUTRA	1 entry		
physCellId[1]	PhysicalCellIdentity of Cell 30		
cgi-Info[1]	Not present		
measResult[1]			
rsrpResult	(0..97)		
rsrqResult	(0..34)		

Table 8.2.4.15a.3.3-8: *MobilityControlInfo* (step 15, Table 8.2.4.15a.3.3-4A)

Derivation Path: 36.508 Table 4.6.5-1			
Information Element	Value/remark	Comment	Condition
MobilityControlInfo ::= SEQUENCE {			
targetPhysCellId	PhysicalCellIdentity of Cell 30		
carrierFreq SEQUENCE {			
dl-CarrierFreq	Same downlink EARFCN as used for Cell 30		
ul-CarrierFreq	Not present		
}			
}			

Table 8.2.4.15a.3.3-9: *MeasurementReport* (step 21, Table 8.2.4.15a.3.2-2)

Derivation path: 36.508 Table 4.6.1-5			
Information Element	Value/Remark	Comment	Condition
MeasurementReport ::= SEQUENCE {			
criticalExtensions CHOICE {			
c1 CHOICE{			
measurementReport-r8 SEQUENCE {			
measResults SEQUENCE {			
measId	1		
measResultServCell SEQUENCE {		Cell 30	
rsrpResult	(0..97)		
rsrqResult	(0..34)		
}			
measResultNeighCells CHOICE {			
measResultListEUTRA SEQUENCE (SIZE (1..maxCellReport)) OF SEQUENCE {	1 entry		
physCellId[1]	PhysicalCellIdentity of Cell 1	Cell 1	
cgi-Info[1]	Not present		
measResult[1] SEQUENCE {			
rsrpResult	(0..97)		
rsrqResult	(0..34)		
}			
}			
}			
}			
}			
}			
}			

Table 8.2.4.15a.3.3-10: *MobilityControlInfo* (step 22, Table 8.2.4.15a.3.3-4)

Derivation Path: 36.508 Table 4.6.5-1			
Information Element	Value/remark	Comment	Condition
MobilityControlInfo ::= SEQUENCE {			
targetPhysCellId	PhysicalCellIdentity of Cell 1		
carrierFreq SEQUENCE {			
dl-CarrierFreq	Same downlink EARFCN as used for Cell 1		
ul-CarrierFreq	Not present		
}			
}			

Table 8.2.4.15a.3.3-11: RRCConnectionReestablishmentRequest (step 24, Table 8.2.4.15a.3.2-2)

Derivation path: 36.508 Table 4.6.1-13			
Information Element	Value/Remark	Comment	Condition
RRCConnectionReestablishmentRequest ::= SEQUENCE { criticalExtensions CHOICE { rrcConnectionReestablishmentRequest-r8 SEQUENCE { ue-Identity SEQUENCE { c-RNTI physCellId shortMAC-I } reestablishmentCause } } }			
c-RNTI	The value of the C-RNTI of the UE.		
physCellId	PhysicalCellIdentity of Cell 30		
shortMAC-I	The same value as the 16 least significant bits of the XMAC-I value calculated by SS		
reestablishmentCause	handoverFailure		

Table 8.2.4.15a.3.3-12: ATTACH ACCEPT for Cell 1 (preamble)

Derivation path: 36.508 Table 4.7.2-1			
Information Element	Value/Remark	Comment	Condition
Equivalent PLMNs	PLMN2		

Table 8.2.4.15a.3.3-13: TRACKING AREA UPDATE ACCEPT for Cell 1 (steps 9, Table 8.2.4.15a.3.2-2)

Derivation path: 36.508 Table 4.7.2-24			
Information Element	Value/Remark	Comment	Condition
Equivalent PLMNs	PLMN2		

Table 8.2.4.15a.3.3-14: TRACKING AREA UPDATE ACCEPT for Cell 30 (step 18, Table 8.2.4.15a.3.2-2)

Derivation path: 36.508 Table 4.7.2-24			
Information Element	Value/Remark	Comment	Condition
Equivalent PLMNs	PLMN1		

Table 8.2.4.15a.3.3-15: TRACKING AREA UPDATE ACCEPT for Cell 30 (steps 26-30, Table 8.2.4.15a.3.2-2)

Derivation path: 36.508 Table 4.7.2-24			
Information Element	Value/Remark	Comment	Condition
Equivalent PLMNs	PLMN1		

8.2.4.16 CA / RRC connection reconfiguration / Setup and Change of MIMO

8.2.4.16.1 CA / RRC connection reconfiguration / Setup and Change of MIMO / Intra-band Contiguous CA

8.2.4.16.1.1 Test Purpose (TP)

(1)

with { UE having completed the radio bearer establishment and initial security activation procedure and configured an Scell }

```

ensure that {
  when { UE receives an RRCConnectionReconfiguration message indicating PCell and Scell TM
modification}
  then { UE sends an RRCConnectionReconfigurationComplete message and changes transmission mode of
the Pcell and SCell}
}

```

8.2.4.16.1.2 Conformance requirements

References: The conformance requirements covered in the present TC are specified in: TS 36.331, clause 5.3.10.6.

[TS 36.331, clause 5.3.10.6]

The UE shall:

- 1> if the *antennaInfo-r10* is included in the received *physicalConfigDedicated* and the previous version of this field that was received by the UE was *antennaInfo* (without suffix i.e. the version defined in REL-8):
 - 2> apply the default antenna configuration as specified in section 9.2.4;
- 1> if the *cqi-ReportConfig-r10* is included in the received *physicalConfigDedicated* and the previous version of this field that was received by the UE was *cqi-ReportConfig* (without suffix i.e. the version defined in REL-8):
 - 2> apply the default CQI reporting configuration as specified in 9.2.4;

NOTE: Application of the default configuration involves release of all extensions introduced in REL-9 and later.

- 1> reconfigure the physical channel configuration in accordance with the received *physicalConfigDedicated*;

- 1> if the *antennaInfo* is included and set to *explicitValue*:

- 2> if the configured *transmissionMode* is not *tm3* or *tm4* or *tm8* or *tm9*; or
- 2> if the configured *transmissionMode* is *tm8* and *pmi-RI-Report* is not present; or
- 2> if the configured *transmissionMode* is *tm9* and *pmi-RI-Report* is not present; or
- 2> if the configured *transmissionMode* is *tm9* and *pmi-RI-Report* is present and *antennaPortsCount* within *csi-RS* is set to *an1*:
 - 3> release *ri-ConfigIndex* in *cqi-ReportPeriodic*, if previously configured;

- 1> else if the *antennaInfo* is included and set to *defaultValue*:

- 2> release *ri-ConfigIndex* in *cqi-ReportPeriodic*, if previously configured;

8.2.4.16.1.3 Test description

8.2.4.16.1.3.1 Pre-test conditions

System Simulator:

- Cell 1 and Cell 3
- System information combination 3 as defined in TS 36.508 [18] clause 4.4.3.1 is used in E-UTRA cells.

UE:

None.

Preamble:

- The UE is in state Generic RB Established (state 3) on Cell 1 in TM2 according to [18].

8.2.4.16.1.3.2 Test procedure sequence

Table 8.2.4.16.1.3.2-1 illustrates the downlink power levels and other changing parameters to be applied for the cells at various time instants of the test execution. Row marked "T0" denotes the initial conditions. The exact instants on which these values shall be applied are described in the texts in this clause.

Table 8.2.4.16.1.3.2-1: Time instances of cell power level and parameter changes

	Parameter	Unit	Cell 1	Cell 3
T0	Cell-specific RS EPRE	dBm/15k Hz	-85	-107
T1	Cell-specific RS EPRE	dBm/15k Hz	-85	-91

Table 8.2.4.16.1.3.2-2: Main behaviour

St	Procedure	Message Sequence		TP	Verdict
		U - S	Message		
1	The SS changes Cell 1 and Cell 3 parameters according to the row "T1" in table 8.2.4.16.3.2-1.				
2	The SS transmits an <i>RRCCONNECTIONRECONFIGURATION</i> message on Cell 1 to reconfigure Cell 3 as a Scell and reconfiguring transmission mode for both PCell and SCell.	<--	<i>RRCCONNECTIONRECONFIGURATION</i>	1	P
3	The UE transmits an <i>RRCCONNECTIONRECONFIGURATIONCOMPLETE</i> message on Cell 1.	-->	<i>RRCCONNECTIONRECONFIGURATIONCOMPLETE</i>	-	-
4	The SS transmits an <i>RRCCONNECTIONRECONFIGURATION</i> message to reconfigure transmission mode on both PCell and SCell.	<--	<i>RRCCONNECTIONRECONFIGURATION</i>	-	-
5	The UE transmits an <i>RRCCONNECTIONRECONFIGURATIONCOMPLETE</i> message on Cell 1.	-->	<i>RRCCONNECTIONRECONFIGURATIONCOMPLETE</i>	1	P

8.2.4.16.1.3.3 Specific message contents

Table 8.2.4.16.1.3.3-1: *RRCCONNECTIONRECONFIGURATION* (step 1, Table 8.2.4.16.1.3.2-2)

Derivation Path: 36.508 Table 4.6.1-8, condition SCell_AddMod			
Information Element	Value/remark	Comment	Condition
<i>RRCCONNECTIONRECONFIGURATION</i> ::= SEQUENCE {			
<i>rrc-TransactionIdentifier</i>	RRC-TransactionIdentifier-DL		
criticalExtensions CHOICE {			
c1 CHOICE{			
<i>rrcConnectionReconfiguration-r8</i> SEQUENCE {			
RadioResourceConfigCommon-DEFAULT ::= SEQUENCE {			
PhysicalConfigDedicated ::= SEQUENCE {			
antennaInfo-r10	TM3		
}			
}			
}			
}			
}			
}			

Table 8.2.4.16.1.3.3-2: SCellToAddMod-r10 (Table 8.2.4.16.1.3.3-1)

Derivation Path: 36.508, Table 4.6.3-19D			
Information Element	Value/remark	Comment	Condition
SCellToAddMod-r10 ::= SEQUENCE {			
sCellIndex-r10	1		
cellIdentification-r10 SEQUENCE {			
physCellId-r10	PhysicalCellIdentity of Cell 3		
dl-CarrierFreq-r10	DEFAULT EARFCN		
}			
}			

Table 8.2.4.16.1.3.3-3: RadioResourceConfigDedicatedSCell-r10 (Table 8.2.4.16.1.3.3-1)

Derivation Path: 36.508, Table 4.6.3-19AA			
Information Element	Value/remark	Comment	Condition
RadioResourceConfigDedicatedSCell-r10 ::= SEQUENCE {			
PhysicalConfigDedicatedSCell-r10 ::= SEQUENCE {			
nonUL-Configuration-r10 SEQUENCE {			
antennaInfo-r10 {			
transmissionMode-r10	TM2		
}			
}			
}			
}			

Table 8.2.4.16.1.3.3-4: RRCConnectionReconfiguration (step 3, Table 8.2.4.16.1.3.2-2)

Derivation Path: 36.508, Table 4.6.1-8, condition SCell_AddMod			
Information Element	Value/remark	Comment	Condition
RRCConnectionReconfiguration ::= SEQUENCE {			
criticalExtensions CHOICE {			
c1 CHOICE {			
rrcConnectionReconfiguration-r8 SEQUENCE {			
RadioResourceConfigCommon-DEFAULT ::= SEQUENCE {			
PhysicalConfigDedicated ::= SEQUENCE {			
antennaInfo-r10	TM2		
}			
}			
}			
}			
}			
}			

Table 8.2.4.16.1.3.3-5: SCellToAddMod-r10 (Table 8.2.4.16.1.3.3-5)

Derivation Path: 36.508, Table 4.6.3-19D			
Information Element	Value/remark	Comment	Condition
SCellToAddMod-r10 ::= SEQUENCE {			
sCellIndex-r10	1		
cellIdentification-r10 SEQUENCE {			
physCellId-r10	PhysicalCellIdentity of Cell 3		
dl-CarrierFreq-r10	DEFAULT EARFCN		
}			
}			

Table 8.2.4.16.1.3.3-6: RadioResourceConfigDedicatedSCell-r10 (Table 8.2.4.16.1.3.3-5)

Derivation Path: 36.508, Table 4.6.3-19AA			
Information Element	Value/remark	Comment	Condition
RadioResourceConfigDedicatedSCell-r10 ::= SEQUENCE {			
PhysicalConfigDedicatedSCell-r10 ::= SEQUENCE {			
nonUL-Configuration-r10 SEQUENCE {			
antennaInfo-r10 {			
transmissionMode-r10	TM3		
}			
}			
}			
}			
}			
}			

8.2.4.16.2 CA / RRC connection reconfiguration / Setup and Change of MIMO / Inter-band CA

The scope and description of the present TC is the same as test case 8.2.4.16.1 with the following differences:

- CA configuration: Inter-band CA replaces Intra-band Contiguous CA.
- Cells configuration: Cell 10 replaces Cell 3.

8.2.4.17 CA / RRC connection reconfiguration / Handover / Success / PCell Change and SCell addition

8.2.4.17.1 CA / RRC connection reconfiguration / Handover / Success / PCell Change and SCell addition / Intra-band Contiguous CA

8.2.4.17.1.1 Test Purpose (TP)

(1)

```
with { UE having completed the radio bearer establishment and initial security activation procedure
and performed the inter frequency measurement }
ensure that {
  when { UE receives an RRCCONNECTIONRECONFIGURATION message including a mobilityControlInfo
indicating a different E-UTRA frequency to be handover to one of the SCell and sCellToAddModList
with an SCell addition }
  then { UE transmits an RRCCONNECTIONRECONFIGURATIONCOMPLETE message }
}
```

8.2.4.17.1.2 Conformance requirements

References: The conformance requirements covered in the present TC are specified in: TS 36.331, clauses 5.3.5.4

[TS 36.331, clause 5.3.5.4]

If the *RRCCONNECTIONRECONFIGURATION* message includes the *mobilityControlInfo* and the UE is able to comply with the configuration included in this message, the UE shall:

- 1> stop timer T310, if running;
- 1> start timer T304 with the timer value set to *t304*, as included in the *mobilityControlInfo*;
- 1> if the *carrierFreq* is included:
 - 2> consider the target PCell to be one on the frequency indicated by the *carrierFreq* with a physical cell identity indicated by the *targetPhysCellId*;
- 1> else:

2> consider the target PCell to be one on the frequency of the source PCell with a physical cell identity indicated by the *targetPhysCellId*;

1> start synchronising to the DL of the target PCell;

NOTE 1: The UE should perform the handover as soon as possible following the reception of the RRC message triggering the handover, which could be before confirming successful reception (HARQ and ARQ) of this message.

1> reset MAC;

1> re-establish PDCP for all RBs that are established;

NOTE 2: The handling of the radio bearers after the successful completion of the PDCP re-establishment, e.g. the re-transmission of unacknowledged PDCP SDUs (as well as the associated status reporting), the handling of the SN and the HFN, is specified in TS 36.323 [8].

1> re-establish RLC for all RBs that are established;

1> configure lower layers to consider the SCell(s), if configured, to be in deactivated state;

1> apply the value of the *newUE-Identity* as the C-RNTI;

1> if the *RRCConnectionReconfiguration* message includes the *fullConfig*:

2> perform the radio configuration procedure as specified in section 5.3.5.8;

1> configure lower layers in accordance with the received *radioResourceConfigCommon*;

1> configure lower layers in accordance with any additional fields, not covered in the previous, if included in the received *mobilityControlInfo*;

1> if the *RRCConnectionReconfiguration* message includes the *radioResourceConfigDedicated*:

2> perform the radio resource configuration procedure as specified in 5.3.10;

1> if the *keyChangeIndicator* received in the *securityConfigHO* is set to *TRUE*:

2> update the K_{eNB} key based on the fresh K_{ASME} key taken into use with the previous successful NAS SMC procedure, as specified in TS 33.401 [32];

1> else:

2> update the K_{eNB} key based on the current K_{eNB} or the NH, using the *nextHopChainingCount* value indicated in the *securityConfigHO*, as specified in TS 33.401 [32];

1> store the *nextHopChainingCount* value;

1> if the *securityAlgorithmConfig* is included in the *securityConfigHO*:

2> derive the K_{RRcint} key associated with the *integrityProtAlgorithm*, as specified in TS 33.401 [32];

2> if connected as an RN:

3> derive the K_{UPint} key associated with the *integrityProtAlgorithm*, as specified in TS 33.401 [32];

2> derive the K_{RRcenc} key and the K_{UPenc} key associated with the *cipheringAlgorithm*, as specified in TS 33.401 [32];

1> else:

2> derive the K_{RRcint} key associated with the current integrity algorithm, as specified in TS 33.401 [32];

2> if connected as an RN:

3> derive the K_{UPint} key associated with the current integrity algorithm, as specified in TS 33.401 [32];

- 2> derive the K_{RRcenc} key and the K_{UPenc} key associated with the current ciphering algorithm, as specified in TS 33.401 [32];
 - 1> configure lower layers to apply the integrity protection algorithm and the K_{RRcint} key, i.e. the integrity protection configuration shall be applied to all subsequent messages received and sent by the UE, including the message used to indicate the successful completion of the procedure;
 - 1> configure lower layers to apply the ciphering algorithm, the K_{RRcenc} key and the K_{UPenc} key, i.e. the ciphering configuration shall be applied to all subsequent messages received and sent by the UE, including the message used to indicate the successful completion of the procedure;
 - 1> if connected as an RN:
 - 2> configure lower layers to apply the integrity protection algorithm and the K_{UPint} key, for current or subsequently established DRBs that are configured to apply integrity protection, if any;
 - 1> if the received *RRCCONNECTIONRECONFIGURATION* includes the *sCellToReleaseList*:
 - 2> perform SCell release as specified in 5.3.10.3a;
 - 1> if the received *RRCCONNECTIONRECONFIGURATION* includes the *sCellToAddModList*:
 - 2> perform SCell addition or modification as specified in 5.3.10.3b;
 - 1> perform the measurement related actions as specified in 5.5.6.1;
 - 1> if the *RRCCONNECTIONRECONFIGURATION* message includes the *measConfig*:
 - 2> perform the measurement configuration procedure as specified in 5.5.2;
 - 1> perform the measurement identity autonomous removal as specified in 5.5.2.2a;
 - 1> release *reportProximityConfig* and clear any associated proximity status reporting timer;
 - 1> if the *RRCCONNECTIONRECONFIGURATION* message includes the *reportProximityConfig*:
 - 2> perform the proximity indication in accordance with the received *reportProximityConfig*;
 - 1> set the content of *RRCCONNECTIONRECONFIGURATIONCOMPLETE* message as follows:
 - 2> if the UE has radio link failure or handover failure information available in *VarRLF-Report* and *plmn-Identity* stored in *VarRLF-Report* is equal to the RPLMN:
 - 3> include *rlf-InfoAvailable*;
 - 2> if the UE has logged measurements available for E-UTRA and *plmn-Identity* stored in *VarLogMeasReport* is equal to the RPLMN:
 - 3> include the *logMeasAvailable*;
 - 1> submit the *RRCCONNECTIONRECONFIGURATIONCOMPLETE* message to lower layers for transmission;
 - 1> if MAC successfully completes the random access procedure:
 - 2> stop timer T304;
 - 2> apply the parts of the CQI reporting configuration, the scheduling request configuration and the sounding RS configuration that do not require the UE to know the SFN of the target PCell, if any;
 - 2> apply the parts of the measurement and the radio resource configuration that require the UE to know the SFN of the target PCell (e.g. measurement gaps, periodic CQI reporting, scheduling request configuration, sounding RS configuration), if any, upon acquiring the SFN of the target PCell;
- NOTE 3: Whenever the UE shall setup or reconfigure a configuration in accordance with a field that is received it applies the new configuration, except for the cases addressed by the above statements.
- 2> the procedure ends;

NOTE 4: The UE is not required to determine the SFN of the target PCell by acquiring system information from that cell before performing RACH access in the target PCell.

8.2.4.17.1.3 Test description

8.2.4.17.1.3.1 Pre-test conditions

System Simulator:

- Cell 1 is the PCell and Cell 3 SCell
- System information combination 3 as defined in TS 36.508 [18] clause 4.4.3.1 is used in E-UTRA cells.

UE:

None.

Preamble:

- The UE is in state Generic RB Established (state 3) on Cell 1 according to [18].

8.2.4.17.1.3.2 Test procedure sequence

Table 8.2.4.17.1.3.2-1 illustrates the downlink power levels and other changing parameters to be applied for the cells at various time instants of the test execution. Row marked "T0" denotes the initial conditions after preamble, while columns marked "T1" is to be applied subsequently. The exact instants on which these values shall be applied are described in the texts in this clause.

Table 8.2.4.17.1.3.2-1: Time instances of cell power level and parameter changes

	Parameter	Unit	Cell 1	Cell 3	Remark
T0	Cell-specific RS EPRE	dBm/15k Hz	-85	Off	The power level values are such that camping on Cell 1 is guarantee.
T1	Cell-specific RS EPRE	dBm/15k Hz	-85	-79	Power levels are such that entry condition for event A3 (measId 1) is satisfied: $Mn + Ofn + Ocn - Hys > Ms + ofs + Ocs + C$

Table 8.2.4.17.1.3.2-2: Main behaviour

St	Procedure	Message Sequence		TP	Verdict
		U - S	Message		
1	The SS transmits an <i>RRConnectionReconfiguration</i> message including <i>sCellToAddModList</i> with Cell 3 as SCell addition.	<--	<i>RRConnectionReconfiguration</i>	-	-
2	The UE transmits an <i>RRConnectionReconfigurationComplete</i> message	-->	<i>RRConnectionReconfigurationComplete</i>	-	-
3	The SS transmits an <i>RRConnectionReconfiguration</i> message on Cell 1 to setup event A3 reporting configuration.	<--	<i>RRConnectionReconfiguration</i>	-	-
4	The UE transmits an <i>RRConnectionReconfigurationComplete</i> message on Cell 1.	-->	<i>RRConnectionReconfigurationComplete</i>	-	-
5	The SS changes Cell 3 parameters according to the row "T1" in table 8.2.4.17.1.3.2-1.	-	-	-	-
6	The UE transmits a <i>MeasurementReport</i> message on Cell 1 to report event A3 with the measured RSRP, RSRQ value for Cell 3.	-->	<i>MeasurementReport</i>	-	-
7	The SS transmits an <i>RRConnectionReconfiguration</i> message on Cell 1 to order the UE to perform handover to Cell 3 with Cell 1 as SCell addition at the same time.	<--	<i>RRConnectionReconfiguration</i>	-	-
8	Check: Does the UE transmit an <i>RRConnectionReconfigurationComplete</i> message on Cell 3 to confirm the successful completion of the handover and SCell addition of Cell 1?	-->	<i>RRConnectionReconfigurationComplete</i>	1	P
9	Check: Does the test result of generic test procedure in TS 36.508 subclause 6.4.2.3 indicates that the UE is in E-UTRA RRC_CONNECTED state on Cell 3?	-	-	1	-

8.2.4.17.1.3.3 Specific message contents

Table 8.2.4.17.1.3.3-1: *RRConnectionReconfiguration* (step 1, Table 8.2.4.17.1.3.2-2)

Derivation Path: 36.508 clause 4.6.1 table 4.6.1-8			
Information Element	Value/remark	Comment	Condition
<i>RRConnectionReconfiguration</i> ::= SEQUENCE {			
<i>criticalExtensions</i> CHOICE {			
<i>c1</i> CHOICE {			
<i>rrcConnectionReconfiguration-r8</i> SEQUENCE {			
<i>nonCriticalExtension</i> SEQUENCE {			
<i>nonCriticalExtension</i> SEQUENCE {			
<i>nonCriticalExtension</i> SEQUENCE {			
<i>sCellToReleaseList-r10</i>	Not present		
<i>sCellToAddModList-r10</i>	<i>SCellToAddMod-r10-f2</i>	SCell addition for Cell 3	
<i>nonCriticalExtension</i> SEQUENCE {	Not present		
}			
}			
}			
}			
}			
}			

Table 8.2.4.17.1.3.3-2: SCellToAddMod-r10-f2 (Table 8.2.4.17.1.3.3-1)

Derivation Path: 36.508 clause 4.6.1 table 4.6.3-19D SCellToAddMod-r10-DEFAULT			
Information Element	Value/remark	Comment	Condition
SCellToAddMod-r10 ::= SEQUENCE (SIZE (1..maxSCell-r10)) OF SEQUENCE {	1 entry		
sCellIndex-r10[1]	1		
cellIdentification-r10[1] SEQUENCE {			
physCellId-r10[1]	Physical Cell Identity of Cell 3		
dl-CarrierFreq-r10[1]	Same downlink EARFCN as used for Cell 3		
}			
radioResourceConfigCommonSCell-r10[1]	RadioResourceConfigCommonSCell-r10-f2		
}			

Table 8.2.4.17.1.3.3-3: RadioResourceConfigCommonSCell-r10-f2 (Table 8.2.4.17.1.3.3-2)

Derivation Path: 36.508 clause 4.6.3 table 4.6.3-13A			
Information Element	Value/remark	Comment	Condition
RadioResourceConfigCommonSCell-r10 ::= SEQUENCE {			
nonUL-Configuration-r10 SEQUENCE {			
dl-Bandwidth-r10	Same downlink system bandwidth as used for Cell 3		
}			
}			

Table 8.2.4.17.1.3.3-4: Void**Table 8.2.4.17.1.3.3-5: RRCConnectionReconfiguration (step 3, Table 8.2.4.17.1.3.2-2)**

Derivation Path: 36.508, Table 4.6.1-8, condition MEAS
--

Table 8.2.4.17.1.3.3-6: MeasConfig (Table 8.2.4.17.1.3.3-5)

Derivation Path: 36.508, Table 4.6.6-1 condition INTER-FREQ			
Information Element	Value/remark	Comment	Condition
MeasConfig SEQUENCE {			
measObjectToAddModList SEQUENCE (SIZE (1..maxObjectId)) OF SEQUENCE {	3 entries		
measObjectId[1]	IdMeasObject-f1		
measObject[1]	MeasObjectEUTRA-GENERIC(f1)	Cell 1	
measObjectId[2]	IdMeasObject-f2		
measObject[2]	MeasObjectEUTRA-GENERIC(f2)	Cell 3	
}			
reportConfigToAddModList SEQUENCE (SIZE (1..maxReportConfigId)) OF SEQUENCE {	1 entry		
reportConfigId[1]	IdReportConfig-A3		
reportConfig[1]	ReportConfigEUTRA-A3		
}			
measIdToAddModList SEQUENCE (SIZE (1..maxMeasId)) OF SEQUENCE {	1 entry		
measId[1]	1		
measObjectId[1]	IdMeasObject-f2		
reportConfigId[1]	IdReportConfig-A3		
}			
}			

Table 8.2.4.17.1.3.3-7: MeasurementReport (step 6, Table 8.2.4.17.1.3.2-2)

Derivation Path: 36.508, Table 4.6.1-5			
Information Element	Value/remark	Comment	Condition
MeasurementReport ::= SEQUENCE {			
criticalExtensions CHOICE {			
c1 CHOICE{			
measurementReport-r8 SEQUENCE {			
measResults ::= SEQUENCE {			
measId	1		
measResultPCell ::= SEQUENCE {		Report Cell 1	
rsrpResult	(0..97)		
rsrqResult	(0..34)		
}			
measResultNeighCells CHOICE {			
measResultListEUTRA ::= SEQUENCE (SIZE (1..maxCellReport)) OF SEQUENCE {	1 entry		
physCellId[1]	physicalCellId of Cell 3		
cgi-Info[1]	Not present		
measResult[1] SEQUENCE {			
rsrpResult	(0..97)		
rsrqResult	(0..34)		
}			
}			
measResultForECID-r9	Not present		
locationInfo-r10	Not present		
measResultServFreqList-r10 SEQUENCE (SIZE (1..maxServCell-r10)) OF SEQUENCE {			
servFreqId-r10	1		
measResultSCell-r10 SEQUENCE {		Cell 3	
rsrpResultSCell-r10	(0..97)		
rsrqResultSCell-r10	(0..34)		
}			
}			
}			
}			
}			
}			

Table 8.2.4.17.1.3.3-8: RRCConnectionReconfiguration (step 7, Table 8.2.4.17.1.3.2-2)

Derivation Path: 36.508 Table 4.6.1-8 condition HO			
Information Element	Value/remark	Comment	Condition
RRCConnectionReconfiguration ::= SEQUENCE {			
criticalExtensions CHOICE {			
c1 CHOICE {			
rrcConnectionReconfiguration-r8 SEQUENCE {			
nonCriticalExtension SEQUENCE {			
nonCriticalExtension SEQUENCE {			
nonCriticalExtension SEQUENCE {			
sCellToReleaseList-r10 SEQUENCE (SIZE (1..maxSCell-r10)) OF SEQUENCE {			
SCellIndex-r10[1]	1		
}			
sCellToAddModList-r10	SCellToAddMod-r10-f1	SCell addition for Cell 1	
}	Not present		
}			
}			
}			
}			
}			

Table 8.2.4.17.1.3.3-9: MobilityControlInfo (Table 8.2.4.17.1.3.3-8)

Derivation Path: 36.508, Table 4.6.5-1			
Information Element	Value/remark	Comment	Condition
MobilityControlInfo ::= SEQUENCE {			
targetPhysCellId	PhysicalCellId of Cell 3		
carrierFreq SEQUENCE {			
dl-CarrierFreq	Same downlink EARFCN as used for Cell 3		
ul-CarrierFreq	Not present		
}			
}			

Table 8.2.4.17.1.3.3-10: SCellToAddMod-r10-f1 (Table 8.2.4.17.1.3.3-8)

Derivation Path: 36.508 clause 4.6.1 table 4.6.3-19D SCellToAddMod-r10-DEFAULT			
Information Element	Value/remark	Comment	Condition
SCellToAddMod-r10 ::= SEQUENCE (SIZE (1..maxSCell-r10)) OF SEQUENCE {	1 entry		
sCellIndex-r10[1]	1		
cellIdentification-r10[1] SEQUENCE {			
physCellId-r10[1]	Physical Cell Identity of Cell 1		
dl-CarrierFreq-r10[1]	Same downlink EARFCN as used for Cell 1		
}			
radioResourceConfigCommonSCell-r10[1]	RadioResourceConfigCommonSCell-r10-f1		
}			

Table 8.2.4.17.1.3.3-11: RadioResourceConfigCommonSCell-r10-f3 (Table 8.2.4.17.1.3.3-10)

Derivation Path: 36.508 clause 4.6.3 table 4.6.3-13A			
Information Element	Value/remark	Comment	Condition
RadioResourceConfigCommonSCell-r10 ::= SEQUENCE {			
nonUL-Configuration-r10 SEQUENCE {			
dl-Bandwidth-r10	Same downlink system bandwidth as used for Cell 1		
}			
}			

8.2.4.17.2 CA / RRC connection reconfiguration / Handover / Success / PCell Change and SCell addition / Inter-band CA

The scope and description of the present TC is the same as test case 8.2.4.17.1 with the following differences:

- CA configuration: Inter-band CA replaces Intra-band Contiguous CA
- Cells configuration: Cell 10 replaces Cell 3

8.2.4.18 CA / RRC connection reconfiguration / Handover / Success / SCell release

8.2.4.18.1 CA / RRC connection reconfiguration / Handover / Success / SCell release / Intra-band Contiguous CA

8.2.4.18.1.1 Test Purpose (TP)

(1)

```
with { UE having completed the radio bearer establishment and initial security activation procedure,
performed the intra-frequency measurement and configured an SCell }
ensure that {
  when { UE receives an RRCConnectionReconfiguration message including a mobilityControlInfo and
including sCellToReleaseList with an sCellIndex set to the configured SCell }
    then { UE sends an RRCConnectionReconfigurationComplete message }
}
```

8.2.4.18.1.2 Conformance requirements

References: The conformance requirements covered in the present TC are specified in: TS 36.331, clauses 5.3.5.4 and 5.3.10.3a.

[TS 36.331, clause 5.3.5.4]

If the *RRCConnectionReconfiguration* message includes the *mobilityControlInfo* and the UE is able to comply with the configuration included in this message, the UE shall:

- 1> stop timer T310, if running;
- 1> start timer T304 with the timer value set to *t304*, as included in the *mobilityControlInfo*;
- 1> if the *carrierFreq* is included:
 - 2> consider the target PCell to be one on the frequency indicated by the *carrierFreq* with a physical cell identity indicated by the *targetPhysCellId*;
- 1> else:
 - 2> consider the target PCell to be one on the frequency of the source PCell with a physical cell identity indicated by the *targetPhysCellId*;
- 1> start synchronising to the DL of the target PCell;

NOTE 1: The UE should perform the handover as soon as possible following the reception of the RRC message triggering the handover, which could be before confirming successful reception (HARQ and ARQ) of this message.

1> reset MAC;

1> re-establish PDCP for all RBs that are established;

NOTE 2: The handling of the radio bearers after the successful completion of the PDCP re-establishment, e.g. the re-transmission of unacknowledged PDCP SDUs (as well as the associated status reporting), the handling of the SN and the HFN, is specified in TS 36.323 [8].

1> re-establish RLC for all RBs that are established;

1> configure lower layers to consider the SCell(s), if configured, to be in deactivated state;

1> apply the value of the *newUE-Identity* as the C-RNTI;

1> if the *RRCConnectionReconfiguration* message includes the *fullConfig*:

2> perform the radio configuration procedure as specified in section 5.3.5.8;

1> configure lower layers in accordance with the received *radioResourceConfigCommon*;

1> configure lower layers in accordance with any additional fields, not covered in the previous, if included in the received *mobilityControlInfo*;

1> if the *RRCConnectionReconfiguration* message includes the *radioResourceConfigDedicated*:

2> perform the radio resource configuration procedure as specified in 5.3.10;

1> if the *keyChangeIndicator* received in the *securityConfigHO* is set to *TRUE*:

2> update the K_{eNB} key based on the fresh K_{ASME} key taken into use with the previous successful NAS SMC procedure, as specified in TS 33.401 [32];

1> else:

2> update the K_{eNB} key based on the current K_{eNB} or the NH, using the *nextHopChainingCount* value indicated in the *securityConfigHO*, as specified in TS 33.401 [32];

1> store the *nextHopChainingCount* value;

1> if the *securityAlgorithmConfig* is included in the *securityConfigHO*:

2> derive the K_{RRcint} key associated with the *integrityProtAlgorithm*, as specified in TS 33.401 [32];

2> if connected as an RN:

3> derive the K_{UPint} key associated with the *integrityProtAlgorithm*, as specified in TS 33.401 [32];

2> derive the K_{RRcenc} key and the K_{UPenc} key associated with the *cipheringAlgorithm*, as specified in TS 33.401 [32];

1> else:

2> derive the K_{RRcint} key associated with the current integrity algorithm, as specified in TS 33.401 [32];

2> if connected as an RN:

3> derive the K_{UPint} key associated with the current integrity algorithm, as specified in TS 33.401 [32];

2> derive the K_{RRcenc} key and the K_{UPenc} key associated with the current ciphering algorithm, as specified in TS 33.401 [32];

1> configure lower layers to apply the integrity protection algorithm and the K_{RRcint} key, i.e. the integrity protection configuration shall be applied to all subsequent messages received and sent by the UE, including the message used to indicate the successful completion of the procedure;

- 1> configure lower layers to apply the ciphering algorithm, the K_{RRcenc} key and the K_{UPenc} key, i.e. the ciphering configuration shall be applied to all subsequent messages received and sent by the UE, including the message used to indicate the successful completion of the procedure;
 - 1> if connected as an RN:
 - 2> configure lower layers to apply the integrity protection algorithm and the K_{UPint} key, for current or subsequently established DRBs that are configured to apply integrity protection, if any;
 - 1> if the received *RRConnectionReconfiguration* includes the *sCellToReleaseList*:
 - 2> perform SCell release as specified in 5.3.10.3a;
 - 1> if the received *RRConnectionReconfiguration* includes the *sCellToAddModList*:
 - 2> perform SCell addition or modification as specified in 5.3.10.3b;
 - 1> perform the measurement related actions as specified in 5.5.6.1;
 - 1> if the *RRConnectionReconfiguration* message includes the *measConfig*:
 - 2> perform the measurement configuration procedure as specified in 5.5.2;
 - 1> perform the measurement identity autonomous removal as specified in 5.5.2.2a;
 - 1> release *reportProximityConfig* and clear any associated proximity status reporting timer;
 - 1> if the *RRConnectionReconfiguration* message includes the *reportProximityConfig*:
 - 2> perform the proximity indication in accordance with the received *reportProximityConfig*;
 - 1> set the content of *RRConnectionReconfigurationComplete* message as follows:
 - 2> if the UE has radio link failure or handover failure information available in *VarRLF-Report* and *plmn-Identity* stored in *VarRLF-Report* is equal to the RPLMN:
 - 3> include *rlf-InfoAvailable*;
 - 2> if the UE has logged measurements available for E-UTRA and *plmn-Identity* stored in *VarLogMeasReport* is equal to the RPLMN:
 - 3> include the *logMeasAvailable*;
 - 1> submit the *RRConnectionReconfigurationComplete* message to lower layers for transmission;
 - 1> if MAC successfully completes the random access procedure:
 - 2> stop timer T304;
 - 2> apply the parts of the CQI reporting configuration, the scheduling request configuration and the sounding RS configuration that do not require the UE to know the SFN of the target PCell, if any;
 - 2> apply the parts of the measurement and the radio resource configuration that require the UE to know the SFN of the target PCell (e.g. measurement gaps, periodic CQI reporting, scheduling request configuration, sounding RS configuration), if any, upon acquiring the SFN of the target PCell;
- NOTE 3: Whenever the UE shall setup or reconfigure a configuration in accordance with a field that is received it applies the new configuration, except for the cases addressed by the above statements.
- 2> the procedure ends;
- NOTE 4: The UE is not required to determine the SFN of the target PCell by acquiring system information from that cell before performing RACH access in the target PCell.

[TS 36.331, clause 5.3.10.3a]

The UE shall:

- 1> if the release is triggered by reception of the *sCellToReleaseList*:
- 2> for each *sCellIndex* value included in the *sCellToReleaseList*:
 - 3> if the current UE configuration includes an SCell with value *sCellIndex*:
 - 4> release the SCell;

8.2.4.18.1.3 Test description

8.2.4.18.1.3.1 Pre-test conditions

System Simulator:

- Cell 1 is PCell, Cell 2 is intra-frequency cell of PCell, and Cell 3 is SCell to be added
- Cell 3 is an Inactive SCell according to [18] cl. 6.3.4
- System information combination 3 as defined in TS 36.508 [18] clause 4.4.3.1 is used in E-UTRA cells.

UE:

None.

Preamble:

- The UE is in state Generic RB Established (state 3) on Cell 1 according to [18].

8.2.4.18.1.3.2 Test procedure sequence

Table 8.2.4.18.1.3.2-1 illustrates the downlink power levels and other changing parameters to be applied for the cells at various time instants of the test execution. Row marked "T0" denotes the conditions after preamble, while columns marked "T1" is to be applied subsequently. The exact instants on which these values shall be applied are described in the texts in this clause.

Table 8.2.4.18.1.3.2-1: Time instances of cell power level and parameter changes

	Parameter	Unit	Cell 1	Cell 2	Cell 3	Remark
T0	Cell-specific RS EPRE	dBm/15k Hz	-85	-91	-97	The power level values are such that measurement results for Cell 1 (M1) and Cell 2 (M2) do not satisfy entry condition for event A3 ($M2 < M1$).
T1	Cell-specific RS EPRE	dBm/15k Hz	-85	-79	-97	The power level values are such that measurement results for Cell 1 (M1) and Cell 2 (M2) satisfy entry condition for event A3 ($M2 > M1$).

Table 8.2.4.18.1.3.2-2: Main behaviour

St	Procedure	Message Sequence		TP	Verdict
		U - S	Message		
1	The SS transmits an <i>RRConnectionReconfiguration</i> message on Cell 1 to configure Cell 3 as a SCell.	<--	<i>RRConnectionReconfiguration</i>	-	-
2	The UE transmits an <i>RRConnectionReconfigurationComplete</i> message on Cell 1.	-->	<i>RRConnectionReconfigurationComplete</i>	-	-
3	The SS transmits an <i>RRConnectionReconfiguration</i> message to setup intra-frequency measurement reporting for event A3 on Cell 1.	<--	<i>RRConnectionReconfiguration</i>	-	-
4	The UE transmits an <i>RRConnectionReconfigurationComplete</i> message on Cell 1.	-->	<i>RRConnectionReconfigurationComplete</i>	-	-
5	The SS changes Cell 2 level according to row "T1" in Table 8.2.4.18.1.3.2-1.	-	-	-	-
6	The UE transmits a <i>MeasurementReport</i> message on Cell 1 to report event A3.	-->	<i>MeasurementReport</i>	-	-
7	The SS transmits an <i>RRConnectionReconfiguration</i> message to perform intra-frequency handover and SCell release on Cell 1.	<--	<i>RRConnectionReconfiguration</i>	-	-
8	Check: Does the UE transmit an <i>RRConnectionReconfigurationComplete</i> message on Cell 2?	-->	<i>RRConnectionReconfigurationComplete</i>	1	P
9	Check: Does the test result of generic test procedure in TS 36.508 subclause 6.4.2.3 indicates that the UE is in E-UTRA RRC_CONNECTED state on Cell 2?	-	-	1	-

8.2.4.18.1.3.3 Specific message contents

Table 8.2.4.18.1.3.3-1: *RRConnectionReconfiguration* (step 1, Table 8.2.4.18.1.3.2-2)

Derivation Path: 36.508 Table 4.6.1-8, condition SCell_AddMod

Table 8.2.4.18.1.3.3-2: *SCellToAddMod-r10* (Table 8.2.4.18.1.3.3-1)

Derivation Path: 36.508, Table 4.6.3-19D			
Information Element	Value/remark	Comment	Condition
<i>SCellToAddMod-r10</i> ::= SEQUENCE {			
<i>sCellIndex-r10</i>	1		
<i>cellIdentification-r10</i> SEQUENCE {			
<i>physCellId-r10</i>	PhysicalCellIdentity of Cell 3		
<i>dl-CarrierFreq-r10</i>	Same downlink EARFCN as used for Cell 3		
}			
}			

Table 8.2.4.18.1.3.3-3: RadioResourceConfigCommonSCell-r10 (Table 8.2.4.18.1.3.3-2)

Derivation Path: 36.508, Table 4.6.3-13A			
Information Element	Value/remark	Comment	Condition
RadioResourceConfigCommonSCell-r10 ::= SEQUENCE {			
nonUL-Configuration-r10 SEQUENCE {			
dl-Bandwidth-r10	Same downlink system bandwidth as used for Cell 3		
}			
}			

Table 8.2.4.18.1.3.3-4: RRCConnectionReconfiguration (step 3, Table 8.2.4.18.1.3.2-2)

Derivation Path: 36.508, Table 4.6.1-8, condition MEAS
--

Table 8.2.4.18.1.3.3-5: MeasConfig (Table 8.2.4.18.1.3.3-4)

Derivation Path: 36.508, Table 4.6.6-1			
Information Element	Value/remark	Comment	Condition
MeasConfig ::= SEQUENCE {			
measObjectToAddModList SEQUENCE (SIZE (1..maxObjectId)) OF SEQUENCE {	2 entries		
measObjectId[1]	IdMeasObject-f1		
measObject[1]	MeasObjectEUTRA-GENERIC(f1)		
measObjectId[2]	IdMeasObject-f2		
measObject[2]	MeasObjectEUTRA-GENERIC(f2)	Cell 3	
}			
reportConfigToAddModList SEQUENCE (SIZE (1..maxReportConfigId)) OF SEQUENCE {	1 entry		
reportConfigId[1]	IdReportConfig-A3		
reportConfig[1]	ReportConfigEUTRA-A3		
}			
measIdToAddModListSEQUENCE (SIZE (1..maxMeasId)) OF SEQUENCE {			
measId[1]	1		
measObjectId[1]	IdMeasObject-f1		
reportConfigId[1]	IdReportConfig-A3		
}			
}			

Table 8.2.4.18.1.3.3-6: MeasurementReport (step 6, Table 8.2.4.18.1.3.2-2)

Derivation Path: 36.508, Table 4.6.1-5			
Information Element	Value/remark	Comment	Condition
MeasurementReport ::= SEQUENCE {			
criticalExtensions CHOICE {			
c1 CHOICE{			
measurementReport-r8 SEQUENCE {			
measResults SEQUENCE {			
measId	1		
measResultPCell SEQUENCE {			
rsrpResult	(0..97)		
rsrqResult	(0..34)		
}			
measResultNeighCells CHOICE {			
measResultListEUTRA SEQUENCE (SIZE (1..maxCellReport)) OF SEQUENCE {	1 entry		
physCellId[1]	PhysicalCellIdentity of Cell 2		
cgi-Info[1]	Not present		
measResult[1] SEQUENCE {			
rsrpResult	(0..97)		
rsrqResult	(0..34)		
additionalSI-Info-r9	Not present		
}			
}			
}			
measResultForECID-r9	Not present		
locationInfo-r10	Not present		
measResultServFreqList-r10 SEQUENCE (SIZE (1..maxServCell-r10)) OF SEQUENCE {	1 entry		
servFreqId-r10[1]	1	Cell 3	
measResultSCell-r10[1] SEQUENCE {			
rsrpResultSCell-r10	(0..97)		
rsrqResultSCell-r10	(0..34)		
}			
measResultBestNeighCell-r10[1]	Not present		
}			
}			
}			
}			
}			

Table 8.2.4.18.1.3.3-7: RRCConnectionReconfiguration (step 7, Table 8.2.4.18.1.3.2-2)

Derivation Path: 36.508, Table 4.6.1-8, condition HO			
Information Element	Value/remark	Comment	Condition
RRCConnectionReconfiguration ::= SEQUENCE {			
criticalExtensions CHOICE {			
c1 CHOICE{			
rrcConnectionReconfiguration-r8 SEQUENCE {			
nonCriticalExtension SEQUENCE {			
lateNonCriticalExtension	Not present		
nonCriticalExtension SEQUENCE {			
otherConfig-r9	Not present		
fullConfig-r9	Not present		
nonCriticalExtension SEQUENCE {			
sCellToReleaseList-r10 SEQUENCE (SIZE (1..maxSCell-r10)) OF SEQUENCE {	1 entry		
SCellIndex-r10[1]	1		
}			
sCellToAddModList-r10	Not present		
nonCriticalExtension	Not present		
}			
}			
}			
}			
}			

Table 8.2.4.18.1.3.3-8: MobilityControlInfo (Table 8.2.4.18.1.3.3-7)

Derivation Path: 36.508, Table 4.6.5-1			
Information Element	Value/remark	Comment	Condition
MobilityControlInfo ::= SEQUENCE {			
targetPhysCellId	PhysicalCellIdentity of Cell 2		
carrierFreq	Not present		
}			

8.2.4.18.2 CA / RRC connection reconfiguration / Handover / Success / SCell release / Inter-band CA

The scope and description of the present TC is the same as test case 8.2.4.18.1 with the following differences:

- CA configuration: Inter-band CA replaces Intra-band Contiguous CA
- Cells configuration: Cell 10 replaces Cell 3
- Cell 10 is an Inactive SCell according to [18] cl. 6.3.4

8.2.4.19 CA / RRC connection reconfiguration / Handover / Success / PCell Change / SCell no Change

8.2.4.19.1 CA / RRC connection reconfiguration / Handover / Success / PCell Change / SCell no Change / Intra-band Contiguous CA

8.2.4.19.1.1 Test Purpose (TP)

(1)

```
with { UE having completed the radio bearer establishment and initial security activation procedure,
performed the inter-frequency measurement and configured an SCell }
ensure that {
  when { UE receives an RRCConnectionReconfiguration message including mobilityControlInfo
indicating change of the PCell and sCellToAddModList with an SCell same from configured SCell
representing an intra-band contiguous CA }
```

```

then { UE sends an RRCConnectionReconfigurationComplete message and does not change SCell }
}

```

8.2.4.19.1.2 Conformance requirements

References: The conformance requirements covered in the present TC are specified in TS 36.331, clauses 5.3.5.4 and 5.3.10.3b.

[TS 36.331, clause 5.3.5.4]

If the *RRCConnectionReconfiguration* message includes the *mobilityControlInfo* and the UE is able to comply with the configuration included in this message, the UE shall:

- 1> stop timer T310, if running;
- 1> start timer T304 with the timer value set to *t304*, as included in the *mobilityControlInfo*;
- 1> if the *carrierFreq* is included:
 - 2> consider the target PCell to be one on the frequency indicated by the *carrierFreq* with a physical cell identity indicated by the *targetPhysCellId*;
- 1> else:
 - 2> consider the target PCell to be one on the frequency of the source PCell with a physical cell identity indicated by the *targetPhysCellId*;
- 1> start synchronising to the DL of the target PCell;

NOTE 1: The UE should perform the handover as soon as possible following the reception of the RRC message triggering the handover, which could be before confirming successful reception (HARQ and ARQ) of this message.

- 1> reset MAC;
- 1> re-establish PDCP for all RBs that are established;

NOTE 2: The handling of the radio bearers after the successful completion of the PDCP re-establishment, e.g. the re-transmission of unacknowledged PDCP SDUs (as well as the associated status reporting), the handling of the SN and the HFN, is specified in TS 36.323 [8].

- 1> re-establish RLC for all RBs that are established;
- 1> configure lower layers to consider the SCell(s), if configured, to be in deactivated state;
- 1> apply the value of the *newUE-Identity* as the C-RNTI;
- 1> if the *RRCConnectionReconfiguration* message includes the *fullConfig*:
 - 2> perform the radio configuration procedure as specified in section 5.3.5.8;
- 1> configure lower layers in accordance with the received *radioResourceConfigCommon*;
- 1> configure lower layers in accordance with any additional fields, not covered in the previous, if included in the received *mobilityControlInfo*;
- 1> if the *RRCConnectionReconfiguration* message includes the *radioResourceConfigDedicated*:
 - 2> perform the radio resource configuration procedure as specified in 5.3.10;
- 1> if the *keyChangeIndicator* received in the *securityConfigHO* is set to *TRUE*:
 - 2> update the K_{eNB} key based on the fresh K_{ASME} key taken into use with the previous successful NAS SMC procedure, as specified in TS 33.401 [32];

- 1> else:

- 2> update the K_{eNB} key based on the current K_{eNB} or the NH, using the *nextHopChainingCount* value indicated in the *securityConfigHO*, as specified in TS 33.401 [32];
- 1> store the *nextHopChainingCount* value;
- 1> if the *securityAlgorithmConfig* is included in the *securityConfigHO*:
 - 2> derive the K_{RRcint} key associated with the *integrityProtAlgorithm*, as specified in TS 33.401 [32];
 - 2> if connected as an RN:
 - 3> derive the K_{UPint} key associated with the *integrityProtAlgorithm*, as specified in TS 33.401 [32];
 - 2> derive the K_{RRcenc} key and the K_{UPenc} key associated with the *cipheringAlgorithm*, as specified in TS 33.401 [32];
- 1> else:
 - 2> derive the K_{RRcint} key associated with the current integrity algorithm, as specified in TS 33.401 [32];
 - 2> if connected as an RN:
 - 3> derive the K_{UPint} key associated with the current integrity algorithm, as specified in TS 33.401 [32];
 - 2> derive the K_{RRcenc} key and the K_{UPenc} key associated with the current ciphering algorithm, as specified in TS 33.401 [32];
- 1> configure lower layers to apply the integrity protection algorithm and the K_{RRcint} key, i.e. the integrity protection configuration shall be applied to all subsequent messages received and sent by the UE, including the message used to indicate the successful completion of the procedure;
- 1> configure lower layers to apply the ciphering algorithm, the K_{RRcenc} key and the K_{UPenc} key, i.e. the ciphering configuration shall be applied to all subsequent messages received and sent by the UE, including the message used to indicate the successful completion of the procedure;
- 1> if connected as an RN:
 - 2> configure lower layers to apply the integrity protection algorithm and the K_{UPint} key, for current or subsequently established DRBs that are configured to apply integrity protection, if any;
- 1> if the received *RRCCConnectionReconfiguration* includes the *sCellToReleaseList*:
 - 2> perform SCell release as specified in 5.3.10.3a;
- 1> if the received *RRCCConnectionReconfiguration* includes the *sCellToAddModList*:
 - 2> perform SCell addition or modification as specified in 5.3.10.3b;
- 1> perform the measurement related actions as specified in 5.5.6.1;
- 1> if the *RRCCConnectionReconfiguration* message includes the *measConfig*:
 - 2> perform the measurement configuration procedure as specified in 5.5.2;
- 1> perform the measurement identity autonomous removal as specified in 5.5.2.2a;
- 1> release *reportProximityConfig* and clear any associated proximity status reporting timer;
- 1> if the *RRCCConnectionReconfiguration* message includes the *reportProximityConfig*:
 - 2> perform the proximity indication in accordance with the received *reportProximityConfig*;
- 1> set the content of *RRCCConnectionReconfigurationComplete* message as follows:
 - 2> if the UE has radio link failure or handover failure information available in *VarRLF-Report* and *plmn-Identity* stored in *VarRLF-Report* is equal to the RPLMN:
 - 3> include *rlf-InfoAvailable*;

2> if the UE has logged measurements available for E-UTRA and *plmn-Identity* stored in *VarLogMeasReport* is equal to the RPLMN:

3> include the *logMeasAvailable*;

1> submit the *RRConnectionReconfigurationComplete* message to lower layers for transmission;

1> if MAC successfully completes the random access procedure:

2> stop timer T304;

2> apply the parts of the CQI reporting configuration, the scheduling request configuration and the sounding RS configuration that do not require the UE to know the SFN of the target PCell, if any;

2> apply the parts of the measurement and the radio resource configuration that require the UE to know the SFN of the target PCell (e.g. measurement gaps, periodic CQI reporting, scheduling request configuration, sounding RS configuration), if any, upon acquiring the SFN of the target PCell;

NOTE 3: Whenever the UE shall setup or reconfigure a configuration in accordance with a field that is received it applies the new configuration, except for the cases addressed by the above statements.

2> the procedure ends;

NOTE 4: The UE is not required to determine the SFN of the target PCell by acquiring system information from that cell before performing RACH access in the target PCell.

[TS 36.331, clause 5.3.10.3b]

The UE shall:

1> for each *sCellIndex* value included in the *sCellToAddModList* that is not part of the current UE configuration (SCell addition):

2> add the SCell, corresponding to the *cellIdentification*, in accordance with the received *radioResourceConfigCommonSCell* and *radioResourceConfigDedicatedSCell*;

2> configure lower layers to consider the SCell to be in deactivated state;

1> for each *sCellIndex* value included in the *sCellToAddModList* that is part of the current UE configuration (SCell modification):

2> modify the SCell configuration in accordance with the received *radioResourceConfigDedicatedSCell*;

8.2.4.19.1.3 Test description

8.2.4.19.1.3.1 Pre-test conditions

System Simulator:

- Cell 3 is the PCell, Cell 1 is the SCell to be added and Cell 6 is the inter-frequency neighbour cell.
- Cell 1 is an Inactive SCell according to [18] cl. 6.3.4
- System information combination 3 as defined in TS 36.508 [18] clause 4.4.3.1 is used in E-UTRA cells.

UE:

None.

Preamble:

- The UE is in state Generic RB Established (state 3) on Cell 3 according to [18].

8.2.4.19.1.3.2 Test procedure sequence

Table 8.2.4.19.1.3.2-1 illustrates the downlink power levels and other changing parameters to be applied for the cells at various time instants of the test execution. Row marked "T0" denotes the initial conditions after preamble, while

columns marked "T1" is to be applied subsequently. The exact instants on which these values shall be applied are described in the texts in this clause.

Table 8.2.4.19.1.3.2-1: Time instances of cell power level and parameter changes

	Parameter	Unit	Cell 1	Cell 3	Cell 6	Remark
T0	Cell-specific RS EPRE	dBm/15k Hz	-91	-85	-97	The power level values are such that measurement results for Cell 3 (M1) and Cell 1 (M2) do not satisfy entry condition for event A3 ($M2 < M1$).
T1	Cell-specific RS EPRE	dBm/15k Hz	-91	-85	-79	The power level values are such that measurement results for Cell 3 (M1) and Cell 6 (M3) satisfy entry condition for event A3 ($M3 > M1$).

Table 8.2.4.19.1.3.2-2: Main behaviour

St	Procedure	Message Sequence		TP	Verdict
		U - S	Message		
1	The SS transmits an <i>RRCCONNECTIONRECONFIGURATION</i> message on Cell 3 to configure Cell 1 as an SCell.	<--	<i>RRCCONNECTIONRECONFIGURATION</i>	-	-
2	The UE transmits an <i>RRCCONNECTIONRECONFIGURATIONCOMPLETE</i> message on Cell 3.	-->	<i>RRCCONNECTIONRECONFIGURATIONCOMPLETE</i>	-	-
3	The SS transmits an <i>RRCCONNECTIONRECONFIGURATION</i> message to setup inter-frequency measurement reporting for event A3 on Cell 3.	<--	<i>RRCCONNECTIONRECONFIGURATION</i>	-	-
4	The UE transmits an <i>RRCCONNECTIONRECONFIGURATIONCOMPLETE</i> message on Cell 3.	-->	<i>RRCCONNECTIONRECONFIGURATIONCOMPLETE</i>	-	-
5	The SS changes Cell 6 level according to row "T1" in Table 8.2.4.19.1.3.2-1.	-	-	-	-
6	The UE transmits a <i>MEASUREMENTREPORT</i> message on Cell 3 to report event A3.	-->	<i>MEASUREMENTREPORT</i>	-	-
7	The SS transmits an <i>RRCCONNECTIONRECONFIGURATION</i> message to perform inter-frequency handover.	<--	<i>RRCCONNECTIONRECONFIGURATION</i>	-	-
8	Check: Does the UE transmit an <i>RRCCONNECTIONRECONFIGURATIONCOMPLETE</i> message on Cell 6?	-->	<i>RRCCONNECTIONRECONFIGURATIONCOMPLETE</i>	1	P
9	Check: Does the test result of generic test procedure in TS 36.508 subclause 6.4.2.3 indicates that the UE is in E-UTRA RRC_CONNECTED state on Cell 6?	-	-	1	-

8.2.4.19.1.3.3 Specific message contents

Table 8.2.4.19.1.3.3-1: *RRCCONNECTIONRECONFIGURATION* (step 1, Table 8.2.4.19.1.3.2-2)

Derivation Path: 36.508 Table 4.6.1-8, condition SCell_AddMod

Table 8.2.4.19.1.3.3-2: SCellToAddMod-r10 (Table 8.2.4.19.1.3.3-1)

Derivation Path: 36.508, Table 4.6.3-19D			
Information Element	Value/remark	Comment	Condition
SCellToAddMod-r10 ::= SEQUENCE {			
sCellIndex-r10	1		
cellIdentification-r10 SEQUENCE {			
physCellId-r10	PhysicalCellIdentity of Cell 1		
dl-CarrierFreq-r10	Same downlink EARFCN as used for Cell 1		
}			
}			

Table 8.2.4.19.1.3.3-3: RadioResourceConfigCommonSCell-r10 (Table 8.2.4.19.1.3.3-2)

Derivation Path: 36.508, Table 4.6.3-13A			
Information Element	Value/remark	Comment	Condition
RadioResourceConfigCommonSCell-r10 ::= SEQUENCE {			
nonUL-Configuration-r10 SEQUENCE {			
dl-Bandwidth-r10	Same downlink system bandwidth as used for Cell 1		
}			
}			

Table 8.2.4.19.1.3.3-4: Void**Table 8.2.4.19.1.3.3-5: RRCConnectionReconfiguration (step 3, Table 8.2.4.19.1.3.2-2)**

Derivation Path: 36.508, Table 4.6.1-8, condition MEAS
--

Table 8.2.4.19.1.3.3-6: MeasConfig (Table 8.2.4.19.1.3.3-5)

Derivation Path: 36.508, Table 4.6.6-1			
Information Element	Value/remark	Comment	Condition
MeasConfig ::= SEQUENCE {			
measObjectToAddModList SEQUENCE (SIZE (1..maxObjectId)) OF SEQUENCE {	3 entries		
measObjectId[1]	IdMeasObject-f1		
measObject[1]	MeasObjectEUTRA-GENERIC(f1)		
measObjectId[2]	IdMeasObject-f2		
measObject[2]	MeasObjectEUTRA-GENERIC(f2)		
measObjectId[3]	IdMeasObject-f3		
measObject[3]	MeasObjectEUTRA-GENERIC(f3)		
}			
reportConfigToAddModList SEQUENCE (SIZE (1..maxReportConfigId)) OF SEQUENCE {	1 entry		
reportConfigId[1]	IdReportConfig-A3		
reportConfig[1]	ReportConfigEUTRA-A3		
}			
measIdToAddModList SEQUENCE (SIZE (1..maxMeasId)) OF SEQUENCE {			
measId[1]	1		
measObjectId[1]	IdMeasObject-f3		
reportConfigId[1]	IdReportConfig-A3		
}			
}			

Table 8.2.4.19.1.3.3-7: MeasurementReport (step 6, Table 8.2.4.19.1.3.2-2)

Derivation Path: 36.508, Table 4.6.1-5			
Information Element	Value/remark	Comment	Condition
MeasurementReport ::= SEQUENCE {			
criticalExtensions CHOICE {			
c1 CHOICE{			
measurementReport-r8 SEQUENCE {			
measResults SEQUENCE {			
measId	1		
measResultPCell SEQUENCE {		Cell 3	
rsrpResult	(0..97)		
rsrqResult	(0..34)		
}			
measResultNeighCells CHOICE {			
measResultListEUTRA SEQUENCE (SIZE (1..maxCellReport)) OF SEQUENCE {	1 entry		
physCellId[1]	PhysicalCellIdentity of Cell 6	Cell 6	
cgi-Info[1]	Not present		
measResult[1] SEQUENCE {			
rsrpResult	(0..97)		
rsrqResult	(0..34)		
additionalSI-Info-r9	Not present		
}			
}			
}			
measResultForECID-r9	Not present		
locationInfo-r10	Not present		
measResultServFreqList-r10 SEQUENCE (SIZE (1..maxServCell-r10)) OF SEQUENCE {	1 entry		
servFreqId-r10[1]	1		
measResultSCell-r10[1] SEQUENCE {		Cell 1	
rsrpResultSCell-r10	(0..97)		
rsrqResultSCell-r10	(0..34)		
}			
measResultBestNeighCell-r10[1]	Not present		
}			
}			
}			
}			

Table 8.2.4.19.1.3.3-7: RRCConnectionReconfiguration (step 7, Table 8.2.4.19.1.3.2-2)

Derivation Path: 36.508, Table 4.6.1-8, condition HO

Table 8.2.4.19.1.3.3-8: MobilityControlInfo (Table 8.2.4.19.1.3.3-7)

Derivation Path: 36.508, Table 4.6.5-1			
Information Element	Value/remark	Comment	Condition
MobilityControlInfo ::= SEQUENCE {			
targetPhysCellId	PhysicalCellIdentity of Cell 6		
carrierFreq	Same DL EARFCN as used for Cell 6		
}			

8.2.4.19.2 CA / RRC connection reconfiguration / Handover / Success / PCell Change / SCell no Change / Inter-band CA

The scope and description of the present TC is the same as test case 8.2.4.19.1 with the following differences:

- CA configuration: Inter-band CA replaces Intra-band Contiguous CA
- Cells configuration: Cell 10 replaces Cell 1 & Cell 1 replaces Cell 6.
- Cell 10 is an Inactive SCell according to [18] cl. 6.3.4

8.2.4.20 CA / RRC connection reconfiguration / Handover / Success / SCell Change

8.2.4.20.1 CA / RRC connection reconfiguration / Handover / Success / SCell Change / Intra-band Contiguous CA

8.2.4.20.1.1 Test Purpose (TP)

(1)

```
with { UE having completed the radio bearer establishment and initial security activation procedure
and performed the inter frequency measurement }
ensure that {
  when { UE receives an RRCCONNECTIONRECONFIGURATION message including a mobilityControlInfo and
sCellToAddModList with an SCell different from configured SCell }
  then { UE sends an RRCCONNECTIONRECONFIGURATIONCOMPLETE message and changes SCell }
}
```

8.2.4.20.1.2 Conformance requirements

References: The conformance requirements covered in the present TC are specified in: TS 36.331, clause 5.3.10.3b.

[TS 36.331, clause 5.3.10.3b]

The UE shall:

- 1> for each *sCellIndex* value included in the *sCellToAddModList* that is not part of the current UE configuration (SCell addition):
 - 2> add the SCell, corresponding to the *cellIdentification*, in accordance with the received *radioResourceConfigCommonSCell* and *radioResourceConfigDedicatedSCell*;
 - 2> configure lower layers to consider the SCell to be in deactivated state;
- 1> for each *sCellIndex* value included in the *sCellToAddModList* that is part of the current UE configuration (SCell modification):
 - 2> modify the SCell configuration in accordance with the received *radioResourceConfigDedicatedSCell*;

8.2.4.20.1.3 Test description

8.2.4.20.1.3.1 Pre-test conditions

System Simulator:

- Cell 1 is the PCell, Cell 3 is the SCell to be added and Cell 12 is the intra-frequency neighbour cell of Cell 3.
- Cell 1 and Cell 3 are Inactive SCells according to [18] cl. 6.3.4
- System information combination 3 as defined in TS 36.508 [18] clause 4.4.3.1 is used in E-UTRA cells.

UE:

None.

Preamble:

- The UE is in state Generic RB Established (state 3) on Cell 1 according to [18].

8.2.4.20.1.3.2 Test procedure sequence

Table 8.2.4.20.1.3.2-1 illustrates the downlink power levels and other changing parameters to be applied for the cells at various time instants of the test execution. Row marked "T0" denotes the initial conditions after preamble, while

columns marked "T1" is to be applied subsequently. The exact instants on which these values shall be applied are described in the texts in this clause.

Table 8.2.4.20.1.3.2-1: Time instances of cell power level and parameter changes

	Parameter	Unit	Cell 1	Cell 3	Cell 12	Remark
T0	Cell-specific RS EPRE	dBm/15k Hz	-85	-91	-97	The power level values are such that measurement results for Cell 12 (M12) and Cell 3 (M2) do not satisfy entry condition for event A6.
T1	Cell-specific RS EPRE	dBm/15k Hz	-85	-85	-79	The power level values are such that measurement results for Cell 12 (M12) and Cell 3 (M3) satisfy entry condition for event A6.

Table 8.2.4.20.1.3.2-2: Main behaviour

St	Procedure	Message Sequence		TP	Verdict
		U - S	Message		
1	Wait 1 s to allow for the switching of cells.	-	-	-	-
2	The SS transmits an <i>RRCCONNECTIONRECONFIGURATION</i> message on Cell 1 to configure Cell 3 as an SCell.	<--	<i>RRCCONNECTIONRECONFIGURATION</i>	-	-
3	The UE transmits an <i>RRCCONNECTIONRECONFIGURATIONCOMPLETE</i> message on Cell 1.	-->	<i>RRCCONNECTIONRECONFIGURATIONCOMPLETE</i>	-	-
	EXCEPTION: If UE does not support FGI bit 111, i.e. Event A6, the following step 4 to step 7 except step 6 should not be executed				
4	The SS transmits an <i>RRCCONNECTIONRECONFIGURATION</i> message to setup intra-frequency measurement reporting for event A6 on Cell 1.	<--	<i>RRCCONNECTIONRECONFIGURATION</i>	-	-
5	The UE transmits an <i>RRCCONNECTIONRECONFIGURATIONCOMPLETE</i> message on Cell 1.	-->	<i>RRCCONNECTIONRECONFIGURATIONCOMPLETE</i>	-	-
6	The SS changes power level according to row "T1" in Table 8.2.4.20.3.2-1.	-	-	-	-
7	The UE transmits a <i>MEASUREMENTREPORT</i> message on Cell 1 to report event A6.	-->	<i>MEASUREMENTREPORT</i>	-	-
8	The SS transmits an <i>RRCCONNECTIONRECONFIGURATION</i> message to perform inter-frequency handover to Cell 12 with original SCell Cell 3 release and new SCell Cell1 addition.	<--	<i>RRCCONNECTIONRECONFIGURATION</i>	-	-
9	Check: Does the UE transmit an <i>RRCCONNECTIONRECONFIGURATIONCOMPLETE</i> message on Cell 12?	-->	<i>RRCCONNECTIONRECONFIGURATIONCOMPLETE</i>	1	P
10	The UE transmits a TRACKING AREA UPDATE REQUEST message to update the registration of the actual tracking area.	-	-	-	-
11	The SS responds with TRACKING AREA UPDATE ACCEPT message.	-	-	-	-
12	The UE transmits a TRACKING AREA UPDATE COMPLETE.	-	-	-	-
13	Check: Does the test result of generic test procedure in TS 36.508 subclause 6.4.2.3 indicates that the UE is in E-UTRA RRC_CONNECTED state on Cell 12?	-	-	1	-

8.2.4.20.1.3.3 Specific message contents

Table 8.2.4.20.1.3.3-1: *RRCCONNECTIONRECONFIGURATION* (step 2, Table 8.2.4.20.1.3.2-2)

Derivation Path: 36.508 Table 4.6.1-8, condition SCell_AddMod

Table 8.2.4.20.1.3.3-2: SCellToAddMod-r10 (Table 8.2.4.20.1.3.3-1)

Derivation Path: 36.508, Table 4.6.3-19D			
Information Element	Value/remark	Comment	Condition
SCellToAddMod-r10 ::= SEQUENCE {			
sCellIndex-r10	1		
cellIdentification-r10 SEQUENCE {			
physCellId-r10	PhysicalCellIdentity of Cell 3		
dl-CarrierFreq-r10	Same downlink EARFCN as used for Cell 3		
}			
}			

Table 8.2.4.20.1.3.3-3: RadioResourceConfigCommonSCell-r10 (Table 8.2.4.20.1.3.3-2)

Derivation Path: 36.508, Table 4.6.3-13A			
Information Element	Value/remark	Comment	Condition
RadioResourceConfigCommonSCell-r10 ::= SEQUENCE {			
nonUL-Configuration-r10 SEQUENCE {			
dl-Bandwidth-r10	Same downlink system bandwidth as used for Cell 3		
}			
}			

Table 8.2.4.20.1.3.3-4: RRCConnectionReconfiguration (step 4, Table 8.2.4.20.1.3.2-2)

Derivation Path: 36.508, Table 4.6.1-8, condition MEAS			
--	--	--	--

Table 8.2.4.20.1.3.3-5: MeasConfig (Table 8.2.4.20.1.3.3-4)

Derivation Path: 36.508 clause 4.6.6 table 4.6.6-1			
Information Element	Value/remark	Comment	Condition
MeasConfig ::= SEQUENCE {			
measObjectToAddModList SEQUENCE (SIZE (1..maxObjectId)) OF SEQUENCE {	2 entries		
measObjectId[1]	IdMeasObject-f1		
measObject[1]	MeasObjectEUTRA-GENERIC(f1)		
}			
{			
measObjectId[2]	IdMeasObject-f2		
measObject[2]	MeasObjectEUTRA-GENERIC(f2)		
}			
reportConfigToAddModList SEQUENCE (SIZE (1..maxReportConfigId)) OF SEQUENCE {	1 entry		
reportConfigId[1]	IdReportConfig-A6		
reportConfig[1]	ReportConfigEUTRA-A6		
}			
measIdToAddModList SEQUENCE (SIZE (1..maxMeasId)) OF SEQUENCE {			
measId[1]	1		
measObjectId[2]	IdMeasObject-f2		
reportConfigId[1]	IdReportConfig-A6		
}			
}			

Table 8.2.4.20.1.3.3-6: MeasurementReport (step 7, Table 8.2.4.20.1.3.2-2)

Derivation Path: 36.508, clause 4.6.1 table 4.6.1-5			
Information Element	Value/remark	Comment	Condition
MeasurementReport ::= SEQUENCE {			
criticalExtensions CHOICE {			
c1 CHOICE{			
measurementReport-r8 SEQUENCE {			
measResults SEQUENCE {			
measId	1		
measResultPCell SEQUENCE {		Cell 1	
rsrpResult	(0..97)		
rsrqResult	(0..34)		
}			
measResultNeighCells CHOICE {			
measResultListEUTRA SEQUENCE (SIZE (1..maxCellReport)) OF SEQUENCE {	1 entry		
physCellId[1]	PhysicalCellIdentity of Cell 12	Cell 12	
cgi-Info[1]	Not present		
measResult[1] SEQUENCE {			
rsrpResult	(0..97)		
rsrqResult	(0..34)		
additionalSI-Info-r9	Not present		
}			
}			
}			
measResultForECID-r9	Not present		
locationInfo-r10	Not present		
measResultServFreqList-r10 SEQUENCE (SIZE (1..maxServCell-r10)) OF SEQUENCE {	1 entry		
servFreqId-r10[1]	1		
measResultSCell-r10[1] SEQUENCE {		Cell 3	
rsrpResultSCell-r10	(0..97)		
rsrqResultSCell-r10	(0..34)		
}			
measResultBestNeighCell-r10[1]	Not present		
}			
}			
}			
}			

Table 8.2.4.20.1.3.3-7: RRCConnectionReconfiguration (step 8, Table 8.2.4.20.1.3.2-2)

Derivation Path: 36.508, Table 4.6.1-8, condition HO			
Information Element	Value/remark	Comment	Condition
RRCConnectionReconfiguration ::= SEQUENCE {			
criticalExtensions CHOICE {			
c1 CHOICE{			
rrcConnectionReconfiguration-r8 SEQUENCE {			
nonCriticalExtension SEQUENCE {			
lateNonCriticalExtension			
nonCriticalExtension SEQUENCE {			
nonCriticalExtension SEQUENCE {			
SCellToReleaseList-r10 ::= SEQUENCE			
(SIZE (1..maxSCell-r10)) OF SEQUENCE {			
SCellIndex-r10[1]	1		
}			
SCellToAddModList-r10	SCellToAddMod-r10-f1		
}			
}			
}			
}			
}			
}			

Table 8.2.4.20.1.3.3-8: MobilityControlInfo (Table 8.2.4.20.1.3.3-7)

Derivation Path: clause 4.6.5-1			
Information Element	Value/remark	Comment	Condition
MobilityControlInfo ::= SEQUENCE {			
targetPhysCellId	PhysicalCellIdentity of Cell 12		
carrierFreq	Same DL EARFCN as used for Cell 12		
}			

Table 8.2.4.20.1.3.3-9: SCellToAddMod-r10-f1 (Table 8.2.4.20.1.3.3-7)

Derivation Path: 36.508 clause 4.6.1 table 4.6.3-19D SCellToAddMod-r10-DEFAULT			
Information Element	Value/remark	Comment	Condition
SCellToAddMod-r10 ::= SEQUENCE (SIZE (1..maxSCell-r10)) OF SEQUENCE {	1 entry		
sCellIndex-r10[1]	1		
cellIdentification-r10[1] SEQUENCE {			
physCellId-r10[1]	Physical Cell Identity of Cell 1		
dl-CarrierFreq-r10[1]	Same downlink EARFCN as used for Cell 1		
}			
radioResourceConfigCommonSCell-r10[1]	RadioResourceConfigCommonSCell-r10-f1		
}			

Table 8.2.4.20.1.3.3-10: *RadioResourceConfigCommonSCell-r10-f1* (Table 8.2.4.20.1.3.3-9)

Derivation Path: 36.508 clause 4.6.3 table 4.6.3-13A			
Information Element	Value/remark	Comment	Condition
RadioResourceConfigCommonSCell-r10 ::= SEQUENCE {			
nonUL-Configuration-r10 SEQUENCE {			
dl-Bandwidth-r10	Same downlink system bandwidth as used for Cell 1		
}			

8.2.4.20.2 CA / RRC connection reconfiguration / Handover / Success / SCell Change / Inter-band CA

The scope and description of the present TC is the same as test case 8.2.4.20.1 with the following differences:

- CA configuration: Inter-band CA replaces Intra-band Contiguous CA
- Cells configuration: Cell 10 replaces Cell 3& Cell 30 replaces Cell 12.
- Cell 1 and Cell 10 are Inactive SCells according to [18] cl. 6.3.4

8.2.4.21 CA / RRC connection reconfiguration / Handover / Success / SCell release

8.2.4.21.1 CA / RRC connection reconfiguration / Handover / Success / SCell release / Intra-band Contiguous CA

8.2.4.21.1.1 Test Purpose (TP)

(1)

```
with { UE having completed the radio bearer establishment and initial security activation procedure,
performed the inter-frequency measurement and configured an SCell }
ensure that {
  when { UE receives an RRCConnectionReconfiguration message including a mobilityControlInfo and
including sCellToReleaseList with an sCellIndex set to the configured SCell }
    then { UE sends an RRCConnectionReconfigurationComplete message }
}
```

8.2.4.21.1.2 Conformance requirements

References: The conformance requirements covered in the present TC are specified in: TS 36.331, clauses 5.3.5.4 and 5.3.10.3a.

[TS 36.331, clause 5.3.5.4]

If the *RRCConnectionReconfiguration* message includes the *mobilityControlInfo* and the UE is able to comply with the configuration included in this message, the UE shall:

- 1> stop timer T310, if running;
- 1> start timer T304 with the timer value set to *t304*, as included in the *mobilityControlInfo*;
- 1> if the *carrierFreq* is included:
 - 2> consider the target PCell to be one on the frequency indicated by the *carrierFreq* with a physical cell identity indicated by the *targetPhysCellId*;
- 1> else:
 - 2> consider the target PCell to be one on the frequency of the source PCell with a physical cell identity indicated by the *targetPhysCellId*;
- 1> start synchronising to the DL of the target PCell;

NOTE 1: The UE should perform the handover as soon as possible following the reception of the RRC message triggering the handover, which could be before confirming successful reception (HARQ and ARQ) of this message.

1> reset MAC;

1> re-establish PDCP for all RBs that are established;

NOTE 2: The handling of the radio bearers after the successful completion of the PDCP re-establishment, e.g. the re-transmission of unacknowledged PDCP SDUs (as well as the associated status reporting), the handling of the SN and the HFN, is specified in TS 36.323 [8].

1> re-establish RLC for all RBs that are established;

1> configure lower layers to consider the SCell(s), if configured, to be in deactivated state;

1> apply the value of the *newUE-Identity* as the C-RNTI;

1> if the *RRCConnectionReconfiguration* message includes the *fullConfig*:

2> perform the radio configuration procedure as specified in section 5.3.5.8;

1> configure lower layers in accordance with the received *radioResourceConfigCommon*;

1> configure lower layers in accordance with any additional fields, not covered in the previous, if included in the received *mobilityControlInfo*;

1> if the *RRCConnectionReconfiguration* message includes the *radioResourceConfigDedicated*:

2> perform the radio resource configuration procedure as specified in 5.3.10;

1> if the *keyChangeIndicator* received in the *securityConfigHO* is set to *TRUE*:

2> update the K_{eNB} key based on the fresh K_{ASME} key taken into use with the previous successful NAS SMC procedure, as specified in TS 33.401 [32];

1> else:

2> update the K_{eNB} key based on the current K_{eNB} or the NH, using the *nextHopChainingCount* value indicated in the *securityConfigHO*, as specified in TS 33.401 [32];

1> store the *nextHopChainingCount* value;

1> if the *securityAlgorithmConfig* is included in the *securityConfigHO*:

2> derive the K_{RRCint} key associated with the *integrityProtAlgorithm*, as specified in TS 33.401 [32];

2> if connected as an RN:

3> derive the K_{UPint} key associated with the *integrityProtAlgorithm*, as specified in TS 33.401 [32];

2> derive the K_{RRCenc} key and the K_{UPenc} key associated with the *cipheringAlgorithm*, as specified in TS 33.401 [32];

1> else:

2> derive the K_{RRCint} key associated with the current integrity algorithm, as specified in TS 33.401 [32];

2> if connected as an RN:

3> derive the K_{UPint} key associated with the current integrity algorithm, as specified in TS 33.401 [32];

2> derive the K_{RRCenc} key and the K_{UPenc} key associated with the current ciphering algorithm, as specified in TS 33.401 [32];

1> configure lower layers to apply the integrity protection algorithm and the K_{RRCint} key, i.e. the integrity protection configuration shall be applied to all subsequent messages received and sent by the UE, including the message used to indicate the successful completion of the procedure;

- 1> configure lower layers to apply the ciphering algorithm, the K_{RRcenc} key and the K_{UPenc} key, i.e. the ciphering configuration shall be applied to all subsequent messages received and sent by the UE, including the message used to indicate the successful completion of the procedure;
 - 1> if connected as an RN:
 - 2> configure lower layers to apply the integrity protection algorithm and the K_{UPint} key, for current or subsequently established DRBs that are configured to apply integrity protection, if any;
 - 1> if the received *RRConnectionReconfiguration* includes the *sCellToReleaseList*:
 - 2> perform SCell release as specified in 5.3.10.3a;
 - 1> if the received *RRConnectionReconfiguration* includes the *sCellToAddModList*:
 - 2> perform SCell addition or modification as specified in 5.3.10.3b;
 - 1> perform the measurement related actions as specified in 5.5.6.1;
 - 1> if the *RRConnectionReconfiguration* message includes the *measConfig*:
 - 2> perform the measurement configuration procedure as specified in 5.5.2;
 - 1> perform the measurement identity autonomous removal as specified in 5.5.2.2a;
 - 1> release *reportProximityConfig* and clear any associated proximity status reporting timer;
 - 1> if the *RRConnectionReconfiguration* message includes the *reportProximityConfig*:
 - 2> perform the proximity indication in accordance with the received *reportProximityConfig*;
 - 1> set the content of *RRConnectionReconfigurationComplete* message as follows:
 - 2> if the UE has radio link failure or handover failure information available in *VarRLF-Report* and *plmn-Identity* stored in *VarRLF-Report* is equal to the RPLMN:
 - 3> include *rlf-InfoAvailable*;
 - 2> if the UE has logged measurements available for E-UTRA and *plmn-Identity* stored in *VarLogMeasReport* is equal to the RPLMN:
 - 3> include the *logMeasAvailable*;
 - 1> submit the *RRConnectionReconfigurationComplete* message to lower layers for transmission;
 - 1> if MAC successfully completes the random access procedure:
 - 2> stop timer T304;
 - 2> apply the parts of the CQI reporting configuration, the scheduling request configuration and the sounding RS configuration that do not require the UE to know the SFN of the target PCell, if any;
 - 2> apply the parts of the measurement and the radio resource configuration that require the UE to know the SFN of the target PCell (e.g. measurement gaps, periodic CQI reporting, scheduling request configuration, sounding RS configuration), if any, upon acquiring the SFN of the target PCell;
- NOTE 3: Whenever the UE shall setup or reconfigure a configuration in accordance with a field that is received it applies the new configuration, except for the cases addressed by the above statements.
- 2> the procedure ends;
- NOTE 4: The UE is not required to determine the SFN of the target PCell by acquiring system information from that cell before performing RACH access in the target PCell.

[TS 36.331, clause 5.3.10.3a]

The UE shall:

- 1> if the release is triggered by reception of the *sCellToReleaseList*:
 - 2> for each *sCellIndex* value included in the *sCellToReleaseList*:
 - 3> if the current UE configuration includes an SCell with value *sCellIndex*:
 - 4> release the SCell;
- 1> if the release is triggered by RRC connection re-establishment:
 - 2> release all SCells that are part of the current UE configuration;

8.2.4.21.1.3 Test description

8.2.4.21.1.3.1 Pre-test conditions

System Simulator:

- Cell 1 is the PCell, Cell 3 is the SCell to be added and Cell 6 is the inter-frequency neighbour cell of PCell.
- System information combination 3 as defined in TS 36.508 [18] clause 4.4.3.1 is used in E-UTRA cells.

UE:

None.

Preamble:

- The UE is in state Generic RB Established (state 3) on Cell 1 according to [18].

8.2.4.21.1.3.2 Test procedure sequence

Table 8.2.4.21.1.3.2-1 illustrates the downlink power levels and other changing parameters to be applied for the cells at various time instants of the test execution. Row marked "T0" denotes the initial conditions after preamble, while columns marked "T1" is to be applied subsequently. The exact instants on which these values shall be applied are described in the texts in this clause.

Table 8.2.4.21.1.3.2-1: Time instances of cell power level and parameter changes

	Parameter	Unit	Cell 1	Cell 3	Cell 6	Remark
T0	Cell-specific RS EPRE	dBm/15k Hz	-85	-91	-97	The power level values are such that measurement results for Cell 1 (M1) and Cell 6 (M6) do not satisfy entry condition for event A5.
T1	Cell-specific RS EPRE	dBm/15k Hz	-85	-85	-79	The power level values are such that measurement results for Cell 1 (M1) and Cell 6 (M6) satisfy entry condition for event A5.

Table 8.2.4.21.1.3.2-2: Main behaviour

St	Procedure	Message Sequence		TP	Verdict
		U - S	Message		
1	The SS transmits an <i>RRCCONNECTIONRECONFIGURATION</i> message on Cell 1 to configure Cell 3 as an SCell.	<--	<i>RRCCONNECTIONRECONFIGURATION</i>	-	-
2	The UE transmits an <i>RRCCONNECTIONRECONFIGURATIONCOMPLETE</i> message on Cell 1.	-->	<i>RRCCONNECTIONRECONFIGURATIONCOMPLETE</i>	-	-
3	The SS transmits an <i>RRCCONNECTIONRECONFIGURATION</i> message to setup inter-frequency measurement reporting for event A5 on Cell 1.	<--	<i>RRCCONNECTIONRECONFIGURATION</i>	-	-
4	The UE transmits an <i>RRCCONNECTIONRECONFIGURATIONCOMPLETE</i> message on Cell 1.	-->	<i>RRCCONNECTIONRECONFIGURATIONCOMPLETE</i>	-	-
5	The SS changes Cell 6 level according to row "T1" in Table 8.2.4.21.1.3.2-1.	-	-	-	-
6	The UE transmits a <i>MEASUREMENTREPORT</i> message on Cell 1 to report event A5.	-->	<i>MEASUREMENTREPORT</i>	-	-
7	The SS transmits an <i>RRCCONNECTIONRECONFIGURATION</i> message to perform inter-frequency handover to Cell 6 and release SCell Cell 3.	<--	<i>RRCCONNECTIONRECONFIGURATION</i>	-	-
8	Check: Does the UE transmit an <i>RRCCONNECTIONRECONFIGURATIONCOMPLETE</i> message on Cell 6?	-->	<i>RRCCONNECTIONRECONFIGURATIONCOMPLETE</i>	1	P
9	Check: Does the test result of generic test procedure in TS 36.508 subclause 6.4.2.3 indicates that the UE is in E-UTRA RRC_CONNECTED state on Cell 6?	-	-	1	-

8.2.4.21.1.3.3 Specific message contents

Table 8.2.4.21.1.3.3-1: *RRCCONNECTIONRECONFIGURATION* (step 1, Table 8.2.4.21.1.3.2-2)

Derivation Path: 36.508 Table 4.6.1-8, condition SCell_AddMod

Table 8.2.4.21.1.3.3-2: *SCellToAddMod-r10* (Table 8.2.4.21.1.3.3-1)

Derivation Path: 36.508, Table 4.6.3-19D			
Information Element	Value/remark	Comment	Condition
<i>SCellToAddMod-r10</i> ::= SEQUENCE {			
<i>sCellIndex-r10</i>	1		
<i>cellIdentification-r10</i> SEQUENCE {			
<i>physCellId-r10</i>	PhysicalCellIdentity of Cell 3		
<i>dl-CarrierFreq-r10</i>	Same downlink EARFCN as used for Cell 3		
}			
}			

Table 8.2.4.21.1.3.3-3: RadioResourceConfigCommonSCell-r10 (Table 8.2.4.21.1.3.3-2)

Derivation Path: 36.508, Table 4.6.3-13A			
Information Element	Value/remark	Comment	Condition
RadioResourceConfigCommonSCell-r10 ::= SEQUENCE {			
nonUL-Configuration-r10 SEQUENCE {			
dl-Bandwidth-r10	Same downlink system bandwidth as used for Cell 3		
}			
}			

Table 8.2.4.21.1.3.3-4: RRCConnectionReconfiguration (step 3, Table 8.2.4.21.1.3.2-2)

Derivation Path: 36.508 Table 4.6.1-8, condition MEAS

Table 8.2.4.21.1.3.3-5: MeasConfig (step 3, Table 8.2.4.21.1.3.2-4)

Derivation path: 36.508 clause 4.6.6 table 4.6.6-1			
Information Element	Value/Remark	Comment	Condition
measConfig ::= SEQUENCE {			
measObjectToAddModList SEQUENCE (SIZE (1..maxObjectId)) OF SEQUENCE {	3 entries		
measObjectId[1]	IdMeasObject-f1		
measObject[1]	MeasObjectEUTRA-GENERIC(f1)	Cell 1	
measObjectId[2]	IdMeasObject-f2		
measObject[2]	MeasObjectEUTRA-GENERIC(f2)	Cell 3	
measObjectId[3]	IdMeasObject-f3		
measObject[3]	MeasObjectEUTRA-GENERIC(f3)	Cell 6	
}			
reportConfigToAddModList SEQUENCE (SIZE (1..maxReportConfigId)) OF SEQUENCE {	1 entry		
reportConfigId[1]	IdReportConfig-A5		
reportConfig[1]	ReportConfig-A5		
}			
measIdToAddModList SEQUENCE (SIZE (1..maxMeasId)) OF SEQUENCE {	1 entry		
measId[1]	1		
measObjectId[1]	IdMeasObject-f3		
reportConfigId[1]	IdReportConfig-A5		
}			
}			

Table 8.2.4.21.1.3.3-6: ReportConfig-A5 (step 3, Table 8.2.4.21.1.3.2-5)

Derivation path: 36.508 clause 4.6.6 table ReportConfigEUTRA-A5(-76, -88)			
Information Element	Value/Remark	Comment	Condition
ReportConfigEUTRA ::= SEQUENCE {			
reportAmount	infinity		
}			

Table 8.2.4.21.1.3.3-7: MeasurementReport (step 6, Table 8.2.4.21.1.3.2-2)

Derivation Path: 36.508, clause 4.6.1 table 4.6.1-5			
Information Element	Value/remark	Comment	Condition
MeasurementReport ::= SEQUENCE {			
criticalExtensions CHOICE {			
c1 CHOICE{			
measurementReport-r8 SEQUENCE {			
measResults SEQUENCE {			
measId	1		
measResultPCell SEQUENCE {			
rsrpResult	(0..97)		
rsrqResult	(0..34)		
}			
measResultNeighCells CHOICE {			
measResultListEUTRA SEQUENCE (SIZE (1..maxCellReport)) OF SEQUENCE {	1 entry		
physCellId[1]	PhysicalCellIdentity of Cell 6		
cgi-Info[1]	Not present		
measResult[1] SEQUENCE {			
rsrpResult	(0..97)		
rsrqResult	(0..34)		
additionalSI-Info-r9	Not present		
}			
}			
}			
measResultForECID-r9	Not present		
locationInfo-r10	Not present		
measResultServFreqList-r10 SEQUENCE (SIZE (1..maxServCell-r10)) OF SEQUENCE {	1 entry		
servFreqId-r10[1]	1		
measResultSCell-r10[1] SEQUENCE {		Cell 3	
rsrpResultSCell-r10	(0..97)		
rsrqResultSCell-r10	(0..34)		
}			
measResultBestNeighCell-r10[1]	Not present		
}			
}			
}			
}			

Table 8.2.4.21.1.3.3-8: RRCConnectionReconfiguration (step 7, Table 8.2.4.21.1.3.2-2)

Derivation Path: 36.508, Table 4.6.1-8, condition HO			
Information Element	Value/remark	Comment	Condition
RRCConnectionReconfiguration ::= SEQUENCE {			
criticalExtensions CHOICE {			
c1 CHOICE{			
rrcConnectionReconfiguration-r8 SEQUENCE {			
MeasConfig ::= SEQUENCE {			
measObjectToRemoveList SEQUENCE (SIZE (1..maxObjectId)) OF SEQUENCE {	3 entries		
measObjectId[1]	IdMeasObject-f1	Cell 1	
measObjectId[2]	IdMeasObject-f2	Cell 3	
measObjectId[3]	IdMeasObject-f3	Cell 6	
}			
reportConfigToRemoveList ::= SEQUENCE (SIZE (1..maxReportConfigId)) OF SEQUENCE {	1 entry		
reportConfigId	IdReportConfig-A5		
}			
measIdToRemoveList SEQUENCE (SIZE (1..maxMeasId)) OF SEQUENCE {	1 entry		
measId[1]	1		
}			
}			
nonCriticalExtension SEQUENCE {			
lateNonCriticalExtension			
nonCriticalExtension SEQUENCE {			
nonCriticalExtension SEQUENCE {			
SCellToReleaseList-r10 ::= SEQUENCE (SIZE (1..maxSCell-r10)) OF SEQUENCE {			
SCellIndex-r10[1]	1		
}			
SCellToAddModList-r10	Not present		
}			
}			
}			
}			
}			
}			

Table 8.2.4.21.1.3.3-9: MobilityControlInfo (Table 8.2.4.21.1.3.3-8)

Derivation Path: 36.508, Table 4.6.5-1			
Information Element	Value/remark	Comment	Condition
MobilityControlInfo ::= SEQUENCE {			
targetPhysCellId	PhysicalCellIdentity of Cell 6		
carrierFreq	Same DL EARFCN as used for Cell 6		
}			

8.2.4.21.2 CA / RRC connection reconfiguration / Handover / Success / SCell release / Inter-band CA

The scope and description of the present TC is the same as test case 8.2.4.21.1 with the following differences:

- CA configuration: Inter-band CA replaces Intra-band Contiguous CA
- Cells configuration:
- Cell 10 replaces Cell 3, and then

- If f6 is supported as per TS 36.508 Table 6.2.3.2-2 by the band combination in which the test case is executed, then Cell 28 replaces Cell 6; otherwise Cell 3 replaces Cell 6.

8.2.4.22 RRC connection reconfiguration / Handover / MFBI / Target cell broadcasting information disregarded by the UE

8.2.4.22.1 Test Purpose (TP)

(1)

```
with {UE in RRC_CONNECTED and T311 is not running, and the UE supports multi-band cells as defined
by bit 31 in featureGroupIndicators}
ensure that {
  when { UE receives freqBandIndicator and multiBandInfoList from SystemInformationBlockType1 and
additionalSpectrumEmission and ul-CarrierFreq from SystemInformationBlockType2 }
  then { the UE disregard the related system information fields and continues connected mode
operations}
}
```

8.2.4.22.2 Conformance requirements

References: The conformance requirements covered in the present TC are specified in: TS 36.331, clauses 5.2.2.7, 5.2.2.9. Unless otherwise stated these are Rel-8 requirements.

[TS 36.331, clause 5.2.2.7]

Upon receiving the *SystemInformationBlockType1* either via broadcast or via dedicated signalling, the UE shall:

- 1> if in RRC_CONNECTED while T311 is not running, and the UE supports multi-band cells as defined by bit 31 in *featureGroupIndicators*:
 - 2> disregard the *freqBandIndicator* and *multiBandInfoList*, if received, while in RRC_CONNECTED;
 - 2> forward the *cellIdentity* to upper layers;
 - 2> forward the *trackingAreaCode* to upper layers;
- 1> else:
 - 2> if the frequency band indicated in the *freqBandIndicator* is part of the frequency bands supported by the UE;
or
 - 2> if the UE supports *multiBandInfoList*, and if one or more of the frequency bands indicated in the *multiBandInfoList* are part of the frequency bands supported by the UE:
 - 3> forward the *cellIdentity* to upper layers;
 - 3> forward the *trackingAreaCode* to upper layers;
 - 2> else:
 - 3> consider the cell as barred in accordance with TS 36.304 [4]; and
 - 3> perform barring as if *intraFreqReselection* is set to *notAllowed*, and as if the *csg-Indication* is set to *FALSE*;

[TS 36.331, clause 5.2.2.9]

Upon receiving *SystemInformationBlockType2*, the UE shall:

- 1> apply the configuration included in the *radioResourceConfigCommon*;
- 1> if upper layers indicate that a (UE specific) paging cycle is configured:
 - 2> apply the shortest of the (UE specific) paging cycle and the *defaultPagingCycle* included in the *radioResourceConfigCommon*;
- 1> if the *mbsfn-SubframeConfigList* is included:

2> consider that DL assignments may occur in the MBSFN subframes indicated in the *mbsfn-SubframeConfigList* under the conditions specified in [23, 7.1];

1> apply the specified PCCH configuration defined in 9.1.1.3;

1> not apply the *timeAlignmentTimerCommon*;

1> if in RRC_CONNECTED and UE is configured with RLF timers and constants values received within *rlf-TimersAndConstants*:

2> not update its values of the timers and constants in *ue-TimersAndConstants* except for the value of timer T300;

1> if in RRC_CONNECTED while T311 is not running; and the UE supports multi-band cells as defined by bit 31 in *featureGroupIndicators*:

2> disregard the *additionalSpectrumEmission* and *ul-CarrierFreq*, if received, while in RRC_CONNECTED;

8.2.4.22.3 Test description

8.2.4.22.3.1 Pre-test conditions

System Simulator:

- Cell 1 and Cell 2.

UE:

None.

Preamble:

- The UE is in state Generic RB Established (state 3) on Cell 1 according to [18].
- Cell 2: *freqBandIndicator* and *multiBandInfoList* from *SystemInformationBlockType1* and *additionalSpectrumEmission* and *ul-CarrierFreq* from *SystemInformationBlockType2* are set to values not supported by the UE

8.2.4.22.3.2 Test procedure sequence

Table 8.2.4.22.3.2-1 illustrates the downlink power levels and other changing parameters to be applied for the cells at various time instants of the test execution. Row marked "T0" denotes the initial conditions after preamble, while columns marked "T1" is to be applied subsequently. The exact instants on which these values shall be applied are described in the texts in this clause.

Table 8.2.4.22.3.2-1: Time instances of cell power level and parameter changes

	Parameter	Unit	Cell 1	Cell 2	Remark
T0	Cell-specific RS EPRE	dBm/15k Hz	-85	-91	The power level values are such that measurement results for Cell 1 (M1) and Cell 2 (M2) satisfy exit condition for event A3 (M2 < M1).
T1	Cell-specific RS EPRE	dBm/15k Hz	-85	-79	The power level values are such that measurement results for Cell 1 (M1) and Cell 2 (M2) satisfy entry condition for event A3 (M2 > M1).

Table 8.2.4.22.3.2-2: Main behaviour

St	Procedure	Message Sequence		TP	Verdict
		U - S	Message		
1	The SS transmits an <i>RRCConnectionReconfiguration</i> message on Cell 1 to setup intra frequency measurement.	<--	<i>RRCConnectionReconfiguration</i>	-	-
2	The UE transmits an <i>RRCConnectionReconfigurationComplete</i> message on Cell 1.	-->	<i>RRCConnectionReconfigurationComplete</i>	-	-
3	The SS changes Cell 1 and Cell 2 parameters according to the row "T1" in table 8.2.4.22.3.2-1.	-	-	-	-
4	The UE transmits a <i>MeasurementReport</i> message on Cell 1 to report event A3 with the measured RSRP, RSRQ value for Cell 2.	-->	<i>MeasurementReport</i>	-	-
5	The SS transmits an <i>RRCConnectionReconfiguration</i> message on Cell 1 to order the UE to perform intra frequency handover to Cell 2.	<--	<i>RRCConnectionReconfiguration</i>	-	-
6	Check: Does the UE transmit an <i>RRCConnectionReconfigurationComplete</i> message on Cell 2 using common preamble to confirm the successful completion of the intra frequency handover?	-->	<i>RRCConnectionReconfigurationComplete</i>	-	-
7	Wait 10 secs in order that the UE receives system information from the Cell 2 and ignores not supported freqBandIndicator and multiBandInfoList from SystemInformationBlockType1 and additionalSpectrumEmission and ul-CarrierFreq from SystemInformationBlockType2.	-	-	-	-
8	Check: Does the test result of generic test procedure in TS 36.508 subclause 6.4.2.3 indicate that the UE is in E-UTRA RRC_CONNECTED state on Cell 2?	-	-	1	P

8.2.4.22.3.3 Specific message contents

Table 8.2.4.22.3.3-1: *RRCConnectionReconfiguration* (step 1, Table 8.2.4.22.3.2-2)

Derivation Path: 36.508, Table 4.6.1-8, condition MEAS
--

Table 8.2.4.22.3.3-2: MeasConfig (Table 8.2.4.22.3.3-1)

Derivation Path: 36.508, Table 4.6.6-1			
Information Element	Value/remark	Comment	Condition
MeasConfig SEQUENCE {			
measObjectToAddModList SEQUENCE (SIZE (1..maxObjectId)) OF SEQUENCE {	1 entry		
measObjectId[1]	IdMeasObject-f1		
measObject[1]	MeasObjectEUTRA-GENERIC(f1)		
}			
reportConfigToAddModList SEQUENCE (SIZE (1..maxReportConfigId)) OF SEQUENCE {	1 entry		
reportConfigId[1]	IdReportConfig-A3		
reportConfig[1]	ReportConfigEUTRA-A3		
}			
measIdToAddModList SEQUENCE (SIZE (1..maxMeasId)) OF SEQUENCE {	1 entry		
measId[1]	1		
measObjectId[1]	IdMeasObject-f1		
reportConfigId[1]	IdReportConfig-A3		
}			
}			

Table 8.2.4.22.3.3-3 MeasurementReport (step 4, Table 8.2.4.22.3.2-2)

Derivation Path: 36.508, Table 4.6.1-5			
Information Element	Value/remark	Comment	Condition
MeasurementReport ::= SEQUENCE {			
criticalExtensions CHOICE {			
c1 CHOICE{			
measurementReport-r8 SEQUENCE {			
measResults SEQUENCE {			
measId	1		
measResultServCell SEQUENCE {			
rsrpResult	(0..97)		
rsrqResult	(0..34)		
}			
measResultNeighCells CHOICE {			
measResultListEUTRA SEQUENCE (SIZE (1..maxCellReport)) OF SEQUENCE {	1 entry		
physCellId[1]	PhysicalCellIdentity of Cell 2		
cgi-Info[1]	Not present		
measResult[1] SEQUENCE {			
rsrpResult	(0..97)		
rsrqResult	(0..34)		
}			
}			
}			
}			
}			
}			
}			

Table 8.2.4.22.3.3-4: RRCConnectionReconfiguration (step 5, Table 8.2.4.22.3.2-2)

Derivation Path: 36.508, Table 4.6.1-8, condition HO
--

Table 8.2.4.22.3.3-5: *MobilityControlInfo* (Table 8.2.4.22.3.3-4)

Derivation Path: 36.508 clause 4.6.5-1			
Information Element	Value/remark	Comment	Condition
MobilityControlInfo ::= SEQUENCE {			
targetPhysCellId	PhysicalCellIdentity of Cell 2		
carrierFreq	Not present		
}			

8.3 Measurement configuration control and reporting

8.3.1 Intra E-UTRAN measurements

8.3.1.1 Measurement configuration control and reporting / Intra E-UTRAN measurements / Event A1

8.3.1.1.1 Test Purpose (TP)

(1)

```
with { UE in E-UTRA RRC_CONNECTED state and measurement configured for event A1 with event based
periodical reporting }
ensure that {
  when { Serving cell becomes better than absolute threshold plus hysteresis }
  then { UE sends MeasurementReport message at regular intervals while entering conditions for
event A1 are satisfied }
}
```

(2)

```
with { UE in E-UTRA RRC_CONNECTED state and periodical measurement reporting triggered by event A1
ongoing}
ensure that {
  when { Serving cell becomes worse than absolute threshold minus hysteresis }
  then { UE stops sending MeasurementReport message }
}
```

8.3.1.1.2 Conformance requirements

References: The conformance requirements covered in the current TC are specified in: TS 36.331, clauses 5.3.5.3, 5.5.4.1, 5.5.4.2 and 5.5.5.

[TS 36.331, clause 5.3.5.3]

If the *RRConnectionReconfiguration* message does not include the *mobilityControlInfo* and the UE is able to comply with the configuration included in this message, the UE shall:

...

- 1> if the *RRConnectionReconfiguration* message includes the *measConfig*:
- 2> perform the measurement configuration procedure as specified in 5.5.2;

...

[TS 36.331, clause 5.5.4.1]

The UE shall:

- 1> for each *measId* included in the *measIdList* within *VarMeasConfig*:
 - ...
 - 2> else:
 - ...
 - 3> if the corresponding *measObject* concerns EUTRA:
 - 4> consider any neighbouring cell detected on the associated frequency to be applicable when the concerned cell is not included in the *blackCellsToAddModList* defined within the *VarMeasConfig* for this *measId*;
 - ...
 - 2> if the *triggerType* is set to 'event' and if the entry condition applicable for this event, i.e. the event corresponding with the *eventId* of the corresponding *reportConfig* within *VarMeasConfig*, is fulfilled for one

or more applicable cells for all measurements after layer 3 filtering taken during *timeToTrigger* defined for this event within the *VarMeasConfig*, while the *VarMeasReportList* does not include an entry for this *measId* (a first cell triggers the event):

- 3> include a measurement reporting entry within the *VarMeasReportList* for this *measId*;
 - 3> set the *numberOfReportsSent* defined within the *VarMeasReportList* for this *measId* to 0;
 - 3> include the concerned cell(s) in the *cellsTriggeredList* defined within the *VarMeasReportList* for this *measId*;
 - 3> initiate the measurement reporting procedure, as specified in 5.5.5;
- 2> if the *triggerType* is set to 'event' and if the entry condition applicable for this event, i.e. the event corresponding with the *eventId* of the corresponding *reportConfig* within *VarMeasConfig*, is fulfilled for one or more applicable cells not included in the *cellsTriggeredList* for all measurements after layer 3 filtering taken during *timeToTrigger* defined for this event within the *VarMeasConfig* (a subsequent cell triggers the event):
- 3> set the *numberOfReportsSent* defined within the *VarMeasReportList* for this *measId* to 0;
 - 3> include the concerned cell(s) in the *cellsTriggeredList* defined within the *VarMeasReportList* for this *measId*;
 - 3> initiate the measurement reporting procedure, as specified in 5.5.5;
- 2> if the *triggerType* is set to 'event' and if the leaving condition applicable for this event is fulfilled for one or more of the cells included in the *cellsTriggeredList* defined within the *VarMeasReportList* for this *measId* for all measurements after layer 3 filtering taken during of *timeToTrigger* defined within the *VarMeasurementConfiguration* for this event:
- 3> remove the concerned cell(s) in the *cellsTriggeredList* defined within the *VarMeasReportList* for this *measId*;
 - 3> if *reportOnLeave* is set to *TRUE* for the corresponding reporting configuration:
 - 4> initiate the measurement reporting procedure, as specified in 5.5.5;
 - 3> if the *cellsTriggeredList* defined within the *VarMeasReportList* for this *measId* is empty:
- 4> remove the measurement reporting entry within the *VarMeasReportList* for this *measId*;
- 4> stop the periodical reporting timer for this *measId*, if running;
- ...
- 2> upon expiry of the periodical reporting timer for this *measId*:
- 3> initiate the measurement reporting procedure, as specified in 5.5.5;
- ...

NOTE 2: The UE does not stop the periodical reporting with *triggerType* set to 'event' or to 'periodical' while the corresponding measurement is not performed due to the serving cell RSRP being equal to or better than *s-Measure* or due to the measurement gap not being setup.

...

[TS 36.331, clause 5.5.4.2]

The UE shall:

- 1> consider the entering condition for this event to be satisfied when condition A1-1, as specified below, is fulfilled;
- 1> consider the leaving condition for this event to be satisfied when condition A1-2, as specified below, is fulfilled;

InequalityA1-1 (Entering condition)

$$M_s - H_{ys} > Thresh$$

InequalityA1-2 (Leaving condition)

$$M_s + H_{ys} < Thresh$$

The variables in the formula are defined as follows:

M_s is the measurement result of the serving cell, not taking into account any offsets.

H_{ys} is the hysteresis parameter for this event (i.e. *hysteresis* as defined within *reportConfigEUTRA* for this event).

Thresh is the threshold parameter for this event (i.e. *a1-Threshold* as defined within *reportConfigEUTRA* for this event).

M_s is expressed in dBm in case of RSRP, or in dB in case of RSRQ.

H_{ys} is expressed in dB.

Thresh is expressed in the same unit as ***M_s***.

[TS 36.331, clause 5.5.5]

...

For the *measId* for which the measurement reporting procedure was triggered, the UE shall set the *measResults* within the *MeasurementReport* message as follows:

1> set the *measId* to the measurement identity that triggered the measurement reporting;

1> set the *measResultServCell* to include the quantities of serving cell;

1> if there is at least one applicable neighbouring cell to report:

...

1> increment the *numberOfReportsSent* as defined within the *VarMeasReportList* for this *measId* by 1;

1> stop the periodical reporting timer, if running;

1> if the *numberOfReportsSent* as defined within the *VarMeasReportList* for this *measId* is less than the *reportAmount* as defined within the corresponding *reportConfig* for this *measId*;

2> start the periodical reporting timer with the value of *reportInterval* as defined within the *reportConfig* for this *measId*;

...

1> submit the *MeasurementReport* message to lower layers for transmission, upon which the procedure ends.

8.3.1.1.3 Test description

8.3.1.1.3.1 Pre-test conditions

System Simulator:

- Cell 1

Preamble:

- The UE is in state Generic RB Established (state 3) according to [18].

8.3.1.1.3.2 Test procedure sequence

Table 8.3.1.1.3.2-1 illustrates the downlink power levels to be applied for Cell 1 at various time instants of the test execution. Row marked "T0" denotes the conditions after the preamble, while rows marked "T1" and "T2" are to be applied subsequently. The exact instants on which these values shall be applied are described in the texts in this clause.

Table 8.3.1.1.3.2-1: Power levels

	Parameter	Unit	Cell 1	Remark
T0	Cell-specific RS EPRE	dBm/15 kHz	-85	Power level is such that $M_s + H_{ys} < Thresh$
T1	Cell-specific RS EPRE	dBm/15 kHz	-59	Power level is such that entry condition for event A1 is satisfied $M_s - H_{ys} > Thresh$
T2	Cell-specific RS EPRE	dBm/15 kHz	-85	Power level is such that exit condition for event A1 is satisfied $M_s + H_{ys} < Thresh$

Note: The total test tolerance used is the sum of downlink signal level uncertainty (TS 36.508 clause 6.2.2.1) and absolute UE measurement accuracy (TS 36.133 clause 9).

Table 8.3.1.1.3.2-2: Main behaviour

St	Procedure	Message Sequence		TP	Verdict
		U - S	Message		
1	SS transmits an <i>RRCConnectionReconfiguration</i> message including <i>MeasConfig</i> to setup intra LTE measurement and reporting for event A1.	<--	<i>RRCConnectionReconfiguration</i>	-	-
2	The UE transmits an <i>RRCConnectionReconfigurationComplete</i> message.	-->	<i>RRCConnectionReconfigurationComplete</i>	-	-
3	SS re-adjusts the cell-specific reference signal level according to row "T1" in table 8.3.1.1.3.2-1.	-	-	-	-
4	Check: Does the UE transmit a <i>MeasurementReport</i> message to report event A1 with the measured RSRP and RSRQ value for Cell 1?	-->	<i>MeasurementReport</i>	1	P
-	EXCEPTION: Step 5 below is repeated until 3 <i>MeasurementReport</i> messages are received from the UE	-	-	-	-
5	Check: Does the UE transmit a <i>MeasurementReport</i> message, with the measured RSRP and RSRQ value for Cell 1?	-->	<i>MeasurementReport</i>	1	P
6	SS re-adjusts the cell-specific reference signal level according to row "T2" in table 8.3.1.1.3.2-1.	-	-	-	-
7	Wait and ignore <i>MeasurementReport</i> messages for 15 s to allow change of power levels for Cell 1 and UE measurement.	-	-	-	-
8	Check: Does the UE attempt to transmit an uplink message within the next 10s?	-	-	2	F

8.3.1.1.3.3 Specific message contents

Table 8.3.1.1.3.3-1: *RRCConnectionReconfiguration* (step 1, Table 8.3.1.1.3.2-2)

Derivation Path: 36.508 clause 4.6.1 table 4.6.1-8 with condition MEAS
--

Table 8.3.1.1.3.3-2: MeasConfig (step 1, Table 8.3.1.1.3.2-2)

Derivation path: 36.508 clause 4.6.6 table 4.6.6-1			
Information Element	Value/Remark	Comment	Condition
measConfig ::= SEQUENCE {			
measObjectToAddModList SEQUENCE (SIZE (1..maxObjectId)) OF SEQUENCE {	1 entry		
measObjectId[1]	IdMeasObject-f1		
measObject[1]	MeasObjectEUTRA-GENERIC(f1)		
}			
reportConfigToAddModList SEQUENCE (SIZE (1..maxReportConfigId)) OF SEQUENCE {	1 entry		
reportConfigId[1]	IdReportConfig-A1		
reportConfig[1]	ReportConfig-A1-H		
}			
measIdToAddModList SEQUENCE (SIZE (1..maxMeasId)) OF SEQUENCE {	1 entry		
measId[1]	1		
measObjectId[1]	IdMeasObject-f1		
reportConfigId[1]	IdReportConfig-A1		
}			
}			

Table 8.3.1.1.3.3-3: ReportConfig-A1-H (step 1, Table 8.3.1.1.3.2-2)

Derivation path: 36.508 clause 4.6.6 table 4.6.6-4 ReportConfigEUTRA-A1(-72)			
Information Element	Value/Remark	Comment	Condition
ReportConfigEUTRA ::= SEQUENCE {			
triggerType CHOICE {			
event SEQUENCE {			
hysteresis	6	3dB	
}			
}			
reportAmount	infinity		
}			

Table 8.3.1.1.3.3-4: MeasurementReport (steps 4 and 5, Table 8.3.1.1.3.2-2)

Derivation path: 36.508 4.6.1 table 4.6.1-5			
Information Element	Value/Remark	Comment	Condition
MeasurementReport ::= SEQUENCE {			
criticalExtensions CHOICE {			
c1 CHOICE {			
measurementReport-r8 SEQUENCE {			
measResults ::= SEQUENCE {			
measId	1		
measResultServCell ::= SEQUENCE {		Report Cell 1	
rsrpResult	(0..97)		
rsrqResult	(0..34)		
}			
measResultNeighCells CHOICE {}	Not present		
}			
}			
}			
}			

8.3.1.2 Measurement configuration control and reporting / Intra E-UTRAN measurements / Event A2

8.3.1.2.1 Test Purpose (TP)

(1)

```
with { UE in E-UTRA RRC_CONNECTED state and measurement configured for event A2 with event based
periodical reporting }
ensure that {
  when { Serving cell becomes worse than absolute threshold minus hysteresis }
  then { UE sends MeasurementReport message at regular intervals while entering conditions for
event A2 are satisfied }
}
```

(2)

```
with { UE in E-UTRA RRC_CONNECTED state and periodical measurement reporting triggered by event A2
ongoing}
ensure that {
  when { Serving cell becomes better than absolute threshold plus hysteresis }
  then { UE stops sending MeasurementReport message }
}
```

8.3.1.2.2 Conformance requirements

References: The conformance requirements covered in the current TC are specified in: TS 36.331, clauses 5.3.5.3, 5.5.4.1, 5.5.4.3 and 5.5.5.

[TS 36.331, clause 5.3.5.3]

If the *RRConnectionReconfiguration* message does not include the *mobilityControlInfo* and the UE is able to comply with the configuration included in this message, the UE shall:

...

- 1> if the *RRConnectionReconfiguration* message includes the *measConfig*:
- 2> perform the measurement configuration procedure as specified in 5.5.2;

...

[TS 36.331, clause 5.5.4.1]

The UE shall:

- 1> for each *measId* included in the *measIdList* within *VarMeasConfig*:

...

2> else:

- 3> if the corresponding *measObject* concerns EUTRA:

- 4> consider any neighbouring cell detected on the associated frequency to be applicable when the concerned cell is not included in the *blackCellsToAddModList* defined within the *VarMeasConfig* for this *measId*;

...

- 2> if the *triggerType* is set to 'event' and if the entry condition applicable for this event, i.e. the event corresponding with the *eventId* of the corresponding *reportConfig* within *VarMeasConfig*, is fulfilled for one or more applicable cells for all measurements after layer 3 filtering taken during *timeToTrigger* defined for this event within the *VarMeasConfig* while the *VarMeasReportList* does not include a measurement reporting entry for this *measId* (a first cell triggers the event):

- 3> include a measurement reporting entry within the *VarMeasReportList* for this *measId*;

- 3> set the *numberOfReportsSent* defined within the *VarMeasReportList* for this *measId* to 0;

- 3> include the concerned cell(s) in the *cellsTriggeredList* defined within the *VarMeasReportList* for this *measId*;
- 3> initiate the measurement reporting procedure, as specified in 5.5.5;
- 2> if the *triggerType* is set to 'event' and if the entry condition applicable for this event, i.e. the event corresponding with the *eventId* of the corresponding *reportConfig* within *VarMeasConfig*, is fulfilled for one or more applicable cells not included in the *cellsTriggeredList* for all measurements after layer 3 filtering taken during *timeToTrigger* defined for this event within the *VarMeasConfig* (a subsequent cell triggers the event):
 - 3> set the *numberOfReportsSent* defined within the *VarMeasReportList* for this *measId* to 0;
 - 3> include the concerned cell(s) in the *cellsTriggeredList* defined within the *VarMeasReportList* for this *measId*;
 - 3> initiate the measurement reporting procedure, as specified in 5.5.5;
- 2> if the *triggerType* is set to 'event' and if the leaving condition applicable for this event is fulfilled for one or more of the cells included in the *cellsTriggeredList* defined within the *VarMeasReportList* for this *measId* for all measurements after layer 3 filtering taken during *timeToTrigger* defined within the *VarMeasConfig* for this event:
 - 3> remove the concerned cell(s) in the *cellsTriggeredList* defined within the *VarMeasReportList* for this *measId*;
 - 3> if *reportOnLeave* is set to *TRUE* for the corresponding reporting configuration:
 - 4> initiate the measurement reporting procedure, as specified in 5.5.5;
 - 3> if the *cellsTriggeredList* defined within the *VarMeasReportList* for this *measId* is empty:
- 4> remove the measurement reporting entry within the *VarMeasReportList* for this *measId*;
- 4> stop the periodical reporting timer for this *measId*, if running;
- ...
- 2> upon expiry of the periodical reporting timer for this *measId*:
 - 3> initiate the measurement reporting procedure, as specified in 5.5.5;
- ...

NOTE 2: The UE does not stop the periodical reporting with *triggerType* set to 'event' or to 'periodical' while the corresponding measurement is not performed due to the serving cell RSRP being equal to or better than *s-Measure* or due to the measurement gap not being setup.

...

[TS 36.331, clause 5.5.4.3]

The UE shall:

- 1> consider the entering condition for this event to be satisfied when condition A2-1, as specified below, is fulfilled;
- 1> consider the leaving condition for this event to be satisfied when condition A2-2, as specified below, is fulfilled;

InequalityA2-1 (Entering condition)

$$M_s + H_{ys} < Thresh$$

InequalityA2-2 (Leaving condition)

$$M_s - H_{ys} > Thresh$$

The variables in the formula are defined as follows:

Ms is the measurement result of the serving cell, not taking into account any offsets.

Hys is the hysteresis parameter for this event (i.e. *hysteresis* as defined within the *reportConfigEUTRA* for this event).

Thresh is the threshold parameter for this event (i.e. *a2-Threshold* as defined within the *reportConfigEUTRA* for this event).

Ms is expressed in dBm in case of RSRP, or in dB in case of RSRQ.

Hys is expressed in dB.

Thresh is expressed in the same unit as *Ms*.

[TS 36.331, clause 5.5.5]

...

For the *measId* for which the measurement reporting procedure was triggered, the UE shall set the *measResults* within the *MeasurementReport* message as follows:

1> set the *measId* to the measurement identity that triggered the measurement reporting;

1> set the *measResultServCell* to include the quantities of serving cell;

1> if there is at least one applicable neighbouring cell to report:

...

1> increment the *numberOfReportsSent* as defined within the *VarMeasReportList* for this *measId* by 1;

1> stop the periodical reporting timer, if running;

1> if the *numberOfReportsSent* as defined within the *VarMeasReportList* for this *measId* is less than the *reportAmount* as defined within the corresponding *reportConfig* for this *measId* :

2> start the periodical reporting timer with the value of *reportInterval* as defined within the corresponding *reportConfig* for this *measId*;

...

1> submit the *MeasurementReport* message to lower layers for transmission, upon which the procedure ends.

8.3.1.2.3 Test description

8.3.1.2.3.1 Pre-test conditions

System Simulator:

- Cell 1

Preamble:

- The UE is in state Generic RB Established (state 3) according to [18].

8.3.1.2.3.2 Test procedure sequence

Table 8.3.1.2.3.2-1 illustrates the downlink power levels to be applied for Cell 1 at various time instants of the test execution. Row marked "T0" denotes the conditions after the preamble, while rows marked "T1" and "T2" are to be applied subsequently. The exact instants on which these values shall be applied are described in the texts in this clause.

Table 8.3.1.2.3.2-1: Power levels

	Parameter	Unit	Cell 1	Remark
T0	Cell-specific RS EPRE	dBm/15 kHz	-70	Power level is such that $M_s > Thresh + Hys$
T1			-96	Power level is such that entry condition for event A2 is satisfied $M_s + Hys < Thresh$
T2			-70	Power level is such that exit condition for event A2 is satisfied $M_s > Thresh + Hys$
Note:	The total tolerance used is the sum of downlink signal level uncertainty (TS 36.508 clause 6.2.2.1) and absolute UE measurement accuracy (TS 36.133 clause 9).			

Table 8.3.1.2.3.2-2: Main behaviour

St	Procedure	Message Sequence		TP	Verdict
		U - S	Message		
1	SS transmits an <i>RRCConnectionReconfiguration</i> message including <i>measConfig</i> to setup intra LTE measurement and reporting for event A2.	<--	<i>RRCConnectionReconfiguration</i>	-	-
2	The UE transmit an <i>RRCConnectionReconfigurationComplete</i> message.	-->	<i>RRCConnectionReconfigurationComplete</i>	-	-
3	SS re-adjusts the cell-specific reference signal level according to row "T1" in table 8.3.1.2.3.2-1.	-	-	-	-
4	Check: Does the UE transmit a <i>MeasurementReport</i> message to report event A2 with the measured RSRP and RSRQ value for Cell 1?	-->	<i>MeasurementReport</i>	1	P
-	EXCEPTION: Step 5 below is repeated until 3 <i>MeasurementReport</i> messages are received from the UE	-	-	-	-
5	Check: Does the UE transmit a <i>MeasurementReport</i> message, with the measured RSRP and RSRQ value for Cell 1?	-->	<i>MeasurementReport</i>	1	P
6	SS re-adjusts the cell-specific reference signal level according to row "T2" in table 8.3.1.2.3.2-1.	-	-	-	-
7	Wait and ignore <i>MeasurementReport</i> messages for 15 s to allow change of power levels for Cell 1 and UE measurement.	-	-	-	-
8	Check: Does the UE attempt to transmit an uplink message within the next 10s?	-	-	2	F

8.3.1.2.3.3 Specific message contents

Table 8.3.1.2.3.3-1: *RRCConnectionReconfiguration* (step 1, Table 8.3.1.2.3.2-2)

Derivation Path: 36.508 clause 4.6.1 table 4.6.1-8 with condition MEAS
--

Table 8.3.1.2.3.3-2: MeasConfig (step 1, Table 8.3.1.2.3.2-2)

Derivation path: 36.508 clause 4.6.6 table 4.6.6-1			
Information Element	Value/Remark	Comment	Condition
measConfig ::= SEQUENCE {			
measObjectToAddModList SEQUENCE (SIZE (1..maxObjectId)) OF SEQUENCE {	1 entry		
measObjectId[1]	IdMeasObject-f1		
measObject[1]	MeasObjectEUTRA-GENERIC(f1)		
}			
reportConfigToAddModList SEQUENCE (SIZE (1..maxReportConfigId)) OF SEQUENCE {	1 entry		
reportConfigId[1]	IdReportConfig-A2		
reportConfig[1]	ReportConfig-A2-H		
}			
measIdToAddModList SEQUENCE (SIZE (1..maxMeasId)) OF SEQUENCE {	1 entry		
measId[1]	1		
measObjectId[1]	IdMeasObject-f1		
reportConfigId[1]	IdReportConfig-A2		
}			
}			

Table 8.3.1.2.3.3-3: ReportConfig-A2-H (step 1, Table 8.3.1.2.3.2-2)

Derivation path: 36.508 clause 4.6.6 table 4.6.6-5 ReportConfigEUTRA-A2(-83)			
Information Element	Value/Remark	Comment	Condition
ReportConfigEUTRA ::= SEQUENCE {			
triggerType CHOICE {			
event SEQUENCE {			
hysteresis	6	3 dB	
}			
}			
reportAmount	infinity		
}			

Table 8.3.1.2.3.3-4: MeasurementReport (steps 4 and 5, Table 8.3.1.2.3.2-2)

Derivation path: 36.508 table clause 4.6.1 table 4.6.1-5			
Information Element	Value/Remark	Comment	Condition
MeasurementReport ::= SEQUENCE {			
criticalExtensions CHOICE {			
c1 CHOICE {			
measurementReport-r8 SEQUENCE {			
measResults ::= SEQUENCE {			
measId	1		
measResultServCell ::= SEQUENCE {		Report Cell 1	
rsrpResult	(0..97)		
rsrqResult	(0..34)		
}			
measResultNeighCells CHOICE {}	Not present		
}			
}			
}			
}			

8.3.1.3 Measurement configuration control and reporting / Intra E-UTRAN measurements / Two simultaneous events A3 (intra and inter-frequency measurements)

8.3.1.3.1 Test Purpose (TP)

(1)

```
with { UE in E-UTRA RRC_CONNECTED state and measurements configured for two event A3 at the same time}
ensure that {
  when { Entry condition for event A3 is not met }
  then { UE does not send MeasurementReport }
}
```

(2)

```
with { UE in E-UTRA RRC_CONNECTED state and measurements configured for two event A3 at the same time}
ensure that {
  when { Neighbour becomes offset better than serving }
  then { UE sends MeasurementReport with correct measId for event A3 }
}
```

8.3.1.3.2 Conformance requirements

References: The conformance requirements covered in the current TC are specified in: TS 36.331, clauses 5.3.5.3, 5.5.4.1, 5.5.4.4 and 5.5.5.

[TS 36.331, clause 5.3.5.3]

If the *RRCConnectionReconfiguration* message does not include the *mobilityControlInfo* and the UE is able to comply with the configuration included in this message, the UE shall:

...

- 1> If the *RRCConnectionReconfiguration* message includes the *measConfig*:
- 2> perform the Measurement configuration procedure as specified in 5.5.2;

...

[TS 36.331, clause 5.5.4.1]

The UE shall:

- 1> for each *measId* included in the *measIdList* within *VarMeasConfig*:
 - 2> if the corresponding *reportConfig* includes a purpose set to ‘*reportStrongestCellsForSON*’:
 - 3> consider any neighbouring cell detected on the associated frequency to be applicable;
 - 2> else if the corresponding *reportConfig* includes a purpose set to ‘*reportCGI*’:
 - 3> consider any neighbouring cell detected on the associated frequency/ set of frequencies (GERAN) which has a physical cell identity matching the value of the *cellForWhichToReportCGI* included in the corresponding *measObject* within the *VarMeasConfig* to be applicable;
 - 2> else:
 - 3> if the corresponding *measObject* concerns E-UTRA:
 - 4> consider any neighbouring cell detected on the associated frequency to be applicable when the concerned cell is not included in the *blackCellsToAddModList* defined within the *VarMeasConfig* for this *measId*;
 - 3> else if the corresponding *measObject* concerns UTRA or CDMA2000:

- 4> consider a neighbouring cell on the associated frequency to be applicable when the concerned cell is included in the *cellsToAddModList* defined within the *VarMeasConfig* for this *measId* (i.e. the cell is included in the white-list);
- 3> else if the corresponding *measObject* concerns GERAN:
 - 4> consider a neighbouring cell on the associated set of frequencies to be applicable when the concerned cell matches the *ncc-Permitted* defined within the *VarMeasConfig* for this *measId*;
- 2> if the *triggerType* is set to 'event' and if the entry condition applicable for this event, i.e. the event corresponding with the *eventId* of the corresponding *reportConfig* within *VarMeasConfig*, is fulfilled for one or more applicable cells for all measurements after layer 3 filtering taken during *timeToTrigger* defined for this event within the *VarMeasConfig*, while the *VarMeasReportList* does not include an measurement reporting entry for this *measId* (a first cell triggers the event):
 - 3> include a measurement reporting entry within the *VarMeasReportList* for this *measId*;
 - 3> set the *numberOfReportsSent* defined within the *VarMeasReportList* for this *measId* to 0;
 - 3> include the concerned cell(s) in the *cellsTriggeredList* defined within the *VarMeasReportList* for this *measId*;
 - 3> initiate the measurement reporting procedure, as specified in 5.5.5;
- 2> if the *triggerType* is set to 'event' and if the entry condition applicable for this event, i.e. the event corresponding with the *eventId* of the corresponding *reportConfig* within *VarMeasConfig*, is fulfilled for one or more applicable cells not included in the *cellsTriggeredList* for all measurements after layer 3 filtering taken during *timeToTrigger* defined for this event within the *VarMeasConfig* (a subsequent cell triggers the event):
 - 3> set the *numberOfReportsSent* defined within the *VarMeasReportList* for this *measId* to 0;
 - 3> include the concerned cell(s) in the *cellsTriggeredList* defined within the *VarMeasReportList* for this *measId*;
 - 3> initiate the measurement reporting procedure, as specified in 5.5.5;
- 2> if the *triggerType* is set to 'event' and if the leaving condition applicable for this event is fulfilled for one or more of the cells included in the *cellsTriggeredList* defined within the *VarMeasReportList* for this *measId* for all measurements after layer 3 filtering taken during *timeToTrigger* defined within the *VarMeasConfig* for this event:
 - 3> remove the concerned cell(s) in the *cellsTriggeredList* defined within the *VarMeasReportList* for this *measId*;
 - 3> if *reportOnLeave* is set to *TRUE* for the corresponding reporting configuration:
 - 4> initiate the measurement reporting procedure, as specified in 5.5.5;
 - 3> if the *cellsTriggeredList* defined within the *VarMeasReportList* for this *measId* is empty:
 - 4> remove the measurement reporting entry within the *VarMeasReportList* for this *measId*;
 - 4> stop the periodical reporting timer for this *measId*, if running;
- 2> if the *purpose* is included and set to 'reportStrongestCells' or to 'reportStrongestCellsForSON' and if a (first) measurement result is available for one or more applicable cells:
 - 3> include a measurement reporting entry within the *VarMeasReportList* for this *measId*;
 - 3> set the *numberOfReportsSent* defined within the *VarMeasReportList* for this *measId* to 0;
 - 3> initiate the measurement reporting procedure, as specified in 5.5.5;

NOTE 1: If the *purpose* is set to ‘*reportStrongestCells*’, the UE initiates a first measurement report immediately after the quantity to be reported becomes available for at least either serving cell or one of the applicable cells. If the *purpose* is set to ‘*reportStrongestCellsForSON*’, the UE initiates a first measurement report when it has determined the strongest cells on the associated frequency.

- 2> upon expiry of the periodical reporting timer for this *measId*:
 - 3> initiate the measurement reporting procedure, as specified in 5.5.5;
- 2> if the *purpose* is included and set to ‘*reportCGI*’ and if the UE acquired the information needed to set all fields of *cellGlobalId* for the requested cell:
 - 3> include a measurement reporting entry within the *VarMeasReportList* for this *measId*;
 - 3> set the *numberOfReportsSent* defined within the *VarMeasReportList* for this *measId* to 0;
 - 3> stop timer T321;
 - 3> initiate the measurement reporting procedure, as specified in 5.5.5;
- 2> upon expiry of the T321 for this *measId*:
 - 3> include a measurement reporting entry within the *VarMeasReportList* for this *measId*;
 - 3> set the *numberOfReportsSent* defined within the *VarMeasReportList* for this *measId* to 0;
 - 3> initiate the measurement reporting procedure, as specified in 5.5.5;

NOTE 2: The UE does not stop the periodical reporting with *triggerType* set to ‘*event*’ or to ‘*periodical*’ while the corresponding measurement is not performed due to the serving cell RSRP being equal to or better than *s-Measure* or due to the measurement gap not being setup.

NOTE 3: If the UE is configured with DRX, the UE may delay the measurement reporting for event triggered and periodical triggered measurements until the Active Time, which is defined in TS 36.321 [6].

[TS 36.331, clause 5.5.4.4]

The UE shall:

- 1> consider the entering condition for this event to be satisfied when condition A3-1, as specified below, is fulfilled;
- 1> consider the leaving condition for this event to be satisfied when condition A3-2, as specified below, is fulfilled;

Inequality A3-1 (Entering condition)

$$Mn + Ofn + Ocn - Hys > Ms + Ofs + Ocs + Off$$

Inequality A3-2 (Leaving condition)

$$Mn + Ofn + Ocn + Hys < Ms + Ofs + Ocs + Off$$

The variables in the formula are defined as follows:

Mn is the measurement result of the neighbouring cell, not taking into account any offsets.

Ofn is the frequency specific offset of the frequency of the neighbour cell (i.e. *offsetFreq* as defined within *measObjectEUTRA* corresponding to the frequency of the neighbour cell).

Ocn is the cell specific offset of the neighbour cell (i.e. *cellIndividualOffset* as defined within *measObjectEUTRA* corresponding to the frequency of the neighbour cell), and set to zero if not configured for the neighbour cell.

Ms is the measurement result of the serving cell, not taking into account any offsets.

Ofs is the frequency specific offset of the serving frequency (i.e. *offsetFreq* as defined within *measObjectEUTRA* corresponding to the serving frequency).

Ocs is the cell specific offset of the serving cell (i.e. *cellIndividualOffset* as defined within *measObjectEUTRA* corresponding to the serving frequency), and is set to zero if not configured for the serving cell.

Hys is the hysteresis parameter for this event (i.e. *hysteresis* as defined within *reportConfigEUTRA* for this event).

Off is the offset parameter for this event (i.e. *a3-Offset* as defined within *reportConfigEUTRA* for this event).

Mn, *Ms* are expressed in dBm in case of RSRP, or in dB in case of RSRQ.

Ofn, *Ocn*, *Ofs*, *Ocs*, *Hys*, *Off* are expressed in dB.

[TS 36.331, clause 5.5.5]

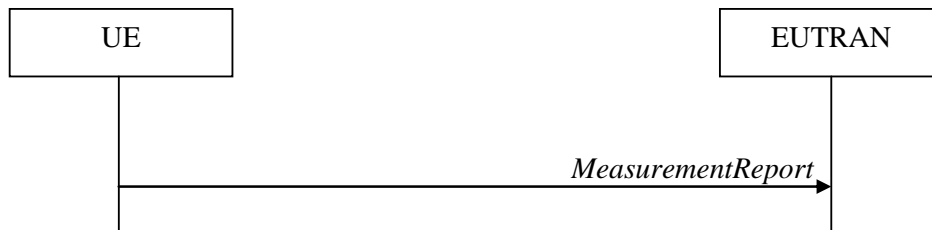

Figure 5.5.5-1: Measurement reporting

The purpose of this procedure is to transfer measurement results from the UE to E-UTRAN.

For the *measId* for which the measurement reporting procedure was triggered, the UE shall set the *measResults* within the *MeasurementReport* message as follows:

- 1> set the *measId* to the measurement identity that triggered the measurement reporting;
 - 1> set the *measResultServCell* to include the quantities of serving cell;
 - 1> if there is at least one applicable neighbouring cell to report:
 - 2> set the *measResultNeighCells* to include the best neighbouring cells up to *maxReportCells* in accordance with the following:
 - 3> if the *triggerType* is set to 'event':
 - 4> include the cells included in the *cellsTriggeredList* as defined within the *VarMeasReportList* for this *measId*;
 - 3> else:
 - 4> include the applicable cells for which the new measurement results became available since the last periodical reporting or since the measurement was initiated or reset;
- NOTE: The reliability of the report (i.e. the certainty it contains the strongest cells on the concerned frequency) depends on the measurement configuration i.e. the *reportInterval*. The related performance requirements are specified in TS 36.133 [16].
- 3> for each cell that is included in the *measResultNeighCells*, include the *physCellId*;
 - 3> if the *triggerType* is set to 'event'; or the *purpose* is set to 'reportStrongestCells' or to 'reportStrongestCellsForSON':
 - 4> for each included cell, include the layer 3 filtered measured results in accordance with the *reportConfig* for this *measId*, ordered as follows:
 - 5> if the *measObject* associated with this *measId* concerns E-UTRA:
 - 6> set the *measResult* to include the quantity(ies) indicated in the *reportQuantity* within the concerned *reportConfig* in order of decreasing *triggerQuantity*, i.e. the best cell is included first;
 - 5> else:

6> set the *measResult* to the quantity as configured for the concerned RAT within the *quantityConfig* in order of decreasing quantity, i.e. the best cell is included first;

3> else if the *purpose* is set to 'reportCGI':

4> if the mandatory present fields of the *cellGlobalId* for the cell indicated by the *cellForWhichToReportCGI* in the associated *measObject* have been obtained:

5> include the *cgi-Info* containing all the fields that have been successfully acquired;

1> increment the *numberOfReportsSent* as defined within the *VarMeasReportList* for this *measId* by 1;

1> stop the periodical reporting timer, if running;

1> if the *numberOfReportsSent* as defined within the *VarMeasReportList* for this *measId* is less than the *reportAmount* as defined within the corresponding *reportConfig* for this *measId*:

2> start the periodical reporting timer with the value of *reportInterval* as defined within the corresponding *reportConfig* for this *measId*;

1> else:

2> if the *triggerType* is set to 'periodical':

3> remove the entry within the *VarMeasReportList* for this *measId*;

3> remove this *measId* from the *measIdList* within *VarMeasConfig*;

1> if the measured results are for CDMA2000 HRPD:

2> set the *preRegistrationStatusHRPD* to the UE's CDMA2000 upper layer's HRPD *preRegistrationStatus*;

1> if the measured results are for CDMA2000 1xRTT:

2> set the *preRegistrationStatusHRPD* to 'FALSE';

1> submit the *MeasurementReport* message to lower layers for transmission, upon which the procedure ends;

8.3.1.3.3 Test description

8.3.1.3.3.1 Pre-test conditions

System Simulator:

- Cell 1, Cell 2 and Cell 3
- System information combination 3 as defined in TS 36.508 [18] clause 4.4.3.1 is used in E-UTRA cells.

UE:

None.

Preamble:

- The UE is in state Generic RB Established (state 3) on Cell 1 according to [18].

8.3.1.3.3.2 Test procedure sequence

Table 8.3.1.3.3.2-1 illustrates the downlink power levels to be applied for Cell 1, Cell 2 and Cell 3 at various time instants of the test execution. Row marked "T0" denotes the conditions after the preamble, while rows marked "T1" and "T2" are to be applied subsequently. The exact instants on which these values shall be applied are described in the texts in this clause.

Table 8.3.1.3.3.2-1: Power levels

	Parameter	Unit	Cell 1	Cell 2 (DL only)	Cell 3 (DL only)	Remark
T0	Cell-specific RS EPRE	dBm/15kHz	-85	-91	Off	Power levels are such that entry condition for event A3 (measId 1 & 2) is not satisfied: $Mn + Ofn + Ocn + Hys < Ms + Ofs + Ocs + Off$
T1	Cell-specific RS EPRE	dBm/15kHz	-85	-79	Off	Power levels are such that entry condition for event A3 (measId 1) is satisfied: $Mn + Ofn + Ocn - Hys > Ms + Ofs + Ocs + Off$
T2	Cell-specific RS EPRE	dBm/15kHz	-85	Off	-73	Power levels are such that entry condition for event A3 (measId 2) is satisfied: $Mn + Ofn + Ocn - Hys > Ms + Ofs + Ocs + Off$

Table 8.3.1.3.3.2-2: Main behaviour

St	Procedure	Message Sequence		TP	Verdict
		U - S	Message		
1	SS transmits an <i>RRCCConnectionReconfiguration</i> message including <i>MeasConfig</i> to setup intra E-UTRAN measurement and reporting for two event A3 (<i>measId 1</i> and <i>measId 2</i>) (intra and inter frequency measurement).	<--	<i>RRCCConnectionReconfiguration</i>	-	-
2	The UE transmits an <i>RCConnectionReconfigurationComplete</i> message.	-->	<i>RRCCConnectionReconfigurationComplete</i>	-	-
3	Check: Does the UE transmit a <i>MeasurementReport</i> message within the next 10s?	-->	<i>MeasurementReport</i>	1	F
4	SS re-adjusts the cell-specific reference signal level according to row "T1" in table 8.3.1.3.3.2-1.	-	-	-	-
5	Check: Does the UE transmit a <i>MeasurementReport</i> message to report event A3 (<i>measId 1</i>) with the measured RSRP value for Cell 2?	-->	<i>MeasurementReport</i>	2	P
6	SS re-adjusts the cell-specific reference signal level according to row "T2" in table 8.3.1.3.3.2-1.	-	-	-	-
7	Void	-	-	-	-
8	Check: Does the UE transmit a <i>MeasurementReport</i> message to report event A3 (<i>measId 2</i>) with the measured RSRP value for Cell 3?	-->	<i>MeasurementReport</i>	2	P

8.3.1.3.3.3 Specific message contents

Table 8.3.1.3.3.3-1: *RRCCConnectionReconfiguration* (step 1, Table 8.3.1.3.3.2-2)

Derivation Path: 36.508 clause 4.6.1 table 4.6.1-8 with condition MEAS
--

Table 8.3.1.3.3.3-2: *MeasConfig* (step 1, Table 8.3.1.3.3.2-2)

Derivation path: 36.508 clause 4.6.6 table 4.6.6-1, condition INTER-FREQ			
Information Element	Value/Remark	Comment	Condition
MeasConfig ::= SEQUENCE {			
measObjectToAddModList SEQUENCE (SIZE (1..maxObjectId)) OF SEQUENCE {	2 entries		
measObjectId[1]	IdMeasObject-f1		
measObject[1]	MeasObjectEUTRA-GENERIC(f1)		
measObjectId[2]	IdMeasObject-f2		
measObject[2]	MeasObjectEUTRA-GENERIC(f2)		
}			
reportConfigToAddModList SEQUENCE (SIZE (1..maxReportConfigId)) OF SEQUENCE {	1 entry		
reportConfigId[1]	IdReportConfig-A3		
reportConfig[1]	ReportConfig-A3-H		
}			
measIdToAddModList SEQUENCE (SIZE (1..maxMeasId)) OF SEQUENCE {	2 entries		
measId[1]	1		
measObjectId[1]	IdMeasObject-f1		
reportConfigId[1]	IdReportConfig-A3		
measId[2]	2		
measObjectId[2]	IdMeasObject-f2		
reportConfigId[2]	IdReportConfig-A3		
}			
}			

Table 8.3.1.3.3.3-3: *ReportConfig-A3-H* (step 1, Table 8.3.1.3.3.2-2)

Derivation path: 36.508 clause 4.6.6 table 4.6.6-6 ReportConfigEUTRA-A3			
Information Element	Value/remark	Comment	Condition
ReportConfigEUTRA-A3 ::= SEQUENCE {			
triggerType CHOICE {			
event SEQUENCE {			
timeToTrigger	ms0		
}			
}			
reportQuantity	sameAsTriggerQuantity		
}			

Table 8.3.1.3.3.3-4: MeasurementReport (step 5, Table 8.3.1.3.3.2-2)

Derivation path: 36.508 4.6.1 table 4.6.1-5			
Information Element	Value/Remark	Comment	Condition
MeasurementReport ::= SEQUENCE {			
criticalExtensions CHOICE {			
c1 CHOICE {			
measurementReport-r8 SEQUENCE {			
measResults ::= SEQUENCE {			
measId	1		
measResultServCell ::= SEQUENCE {		Report Cell 1	
rsrpResult	(0..97)		
rsrqResult	(0..34)		
}			
measResultNeighCells CHOICE {			
MeasResultEUTRA ::= SEQUENCE (SIZE (1..maxCellReport)) OF SEQUENCE {		Report Cell 2	
physCellId	physCellId of the Cell 2.		
measResult SEQUENCE{			
rsrpResult	(0..97)		
rsrqResult	Not present		
}			
}			
}			
}			
}			
}			

Table 8.3.1.3.3.3-5: MeasurementReport (step 8, Table 8.3.1.3.3.2-2)

Derivation path: 36.508 4.6.1 table 4.6.1-5			
Information Element	Value/Remark	Comment	Condition
MeasurementReport ::= SEQUENCE {			
criticalExtensions CHOICE {			
c1 CHOICE {			
measurementReport-r8 SEQUENCE {			
measResults ::= SEQUENCE {			
measId	2		
measResultServCell ::= SEQUENCE {		Report Cell 1	
rsrpResult	(0..97)		
rsrqResult	(0..34)		
}			
measResultNeighCells CHOICE {			
MeasResultEUTRA ::= SEQUENCE (SIZE (1..maxCellReport)) OF SEQUENCE {		Report Cell 3	
physCellId	physCellId of the Cell 3.		
measResult SEQUENCE{			
rsrpResult	(0..97)		
rsrqResult	Not present		
}			
}			
}			
}			
}			
}			

8.3.1.3a Measurement configuration control and reporting / Intra E-UTRAN measurements / Two simultaneous events A3 (intra and inter-frequency measurements) / RSRQ based measurements

8.3.1.3a.1 Test Purpose (TP)

(1)

```
with { UE in E-UTRA RRC_CONNECTED state, measurements configured for two event A3 at the same time
and triggerQuantity set to rsrq }
ensure that {
  when { Entry condition for event A3 is not met }
  then { UE does not send MeasurementReport }
}
```

(2)

```
with { UE in E-UTRA RRC_CONNECTED state, measurements configured for two event A3 at the same time
and triggerQuantity set to rsrq }
ensure that {
  when { Neighbour becomes offset better than serving }
  then { UE sends MeasurementReport with correct measId for event A3 }
}
```

8.3.1.3a.2 Conformance requirements

References: The conformance requirements covered in the present TC are specified in: TS 36.331, clause 5.3.5.3, 5.5.4.1, 5.5.4.4 and 5.5.5.

[TS 36.331, clause 5.3.5.3]

If the *RRConnectionReconfiguration* message does not include the *mobilityControlInfo* and the UE is able to comply with the configuration included in this message, the UE shall:

...

- 1> if the *RRConnectionReconfiguration* message includes the *measConfig*:
- 2> perform the measurement configuration procedure as specified in 5.5.2;

[TS 36.331, clause 5.5.4.1]

The UE shall:

- 1> for each *measId* included in the *measIdList* within *VarMeasConfig*:
 - 2> if the corresponding *reportConfig* includes a purpose set to '*reportStrongestCellsForSON*':
 - 3> consider any neighbouring cell detected on the associated frequency to be applicable;
 - 2> else if the corresponding *reportConfig* includes a purpose set to '*reportCGI*':
 - 3> consider any neighbouring cell detected on the associated frequency/ set of frequencies (GERAN) which has a physical cell identity matching the value of the *cellForWhichToReportCGI* included in the corresponding *measObject* within the *VarMeasConfig* to be applicable;
 - 2> else:
 - 3> if the corresponding *measObject* concerns E-UTRA:
 - 4> if the *ue-RxTxTimeDiffPeriodical*, *eventA1* or *eventA2* is configured in the corresponding *reportConfig*:
 - 5> consider only the serving cell to be applicable;
 - 4> else:

5> consider any neighbouring cell detected on the associated frequency to be applicable when the concerned cell is not included in the *blackCellsToAddModList* defined within the *VarMeasConfig* for this *measId*;

3> else if the corresponding *measObject* concerns UTRA or CDMA2000:

4> consider a neighbouring cell on the associated frequency to be applicable when the concerned cell is included in the *cellsToAddModList* defined within the *VarMeasConfig* for this *measId* (i.e. the cell is included in the white-list);

NOTE 0: The UE may also consider a neighbouring cell on the associated UTRA frequency to be applicable when the concerned cell is included in the *csg-allowedReportingCells* within the *VarMeasConfig* for this *measId*, if configured in the corresponding *measObjectUTRA* (i.e. the cell is included in the range of physical cell identities for which reporting is allowed).

3> else if the corresponding *measObject* concerns GERAN:

4> consider a neighbouring cell on the associated set of frequencies to be applicable when the concerned cell matches the *ncc-Permitted* defined within the *VarMeasConfig* for this *measId*;

2> if the *triggerType* is set to 'event' and if the entry condition applicable for this event, i.e. the event corresponding with the *eventId* of the corresponding *reportConfig* within *VarMeasConfig*, is fulfilled for one or more applicable cells for all measurements after layer 3 filtering taken during *timeToTrigger* defined for this event within the *VarMeasConfig*, while the *VarMeasReportList* does not include an measurement reporting entry for this *measId* (a first cell triggers the event):

3> include a measurement reporting entry within the *VarMeasReportList* for this *measId*;

3> set the *numberOfReportsSent* defined within the *VarMeasReportList* for this *measId* to 0;

3> include the concerned cell(s) in the *cellsTriggeredList* defined within the *VarMeasReportList* for this *measId*;

3> initiate the measurement reporting procedure, as specified in 5.5.5;

2> if the *triggerType* is set to 'event' and if the entry condition applicable for this event, i.e. the event corresponding with the *eventId* of the corresponding *reportConfig* within *VarMeasConfig*, is fulfilled for one or more applicable cells not included in the *cellsTriggeredList* for all measurements after layer 3 filtering taken during *timeToTrigger* defined for this event within the *VarMeasConfig* (a subsequent cell triggers the event):

3> set the *numberOfReportsSent* defined within the *VarMeasReportList* for this *measId* to 0;

3> include the concerned cell(s) in the *cellsTriggeredList* defined within the *VarMeasReportList* for this *measId*;

3> initiate the measurement reporting procedure, as specified in 5.5.5;

2> if the *triggerType* is set to 'event' and if the leaving condition applicable for this event is fulfilled for one or more of the cells included in the *cellsTriggeredList* defined within the *VarMeasReportList* for this *measId* for all measurements after layer 3 filtering taken during *timeToTrigger* defined within the *VarMeasConfig* for this event:

3> remove the concerned cell(s) in the *cellsTriggeredList* defined within the *VarMeasReportList* for this *measId*;

3> if *reportOnLeave* is set to *TRUE* for the corresponding reporting configuration:

4> initiate the measurement reporting procedure, as specified in 5.5.5;

3> if the *cellsTriggeredList* defined within the *VarMeasReportList* for this *measId* is empty:

4> remove the measurement reporting entry within the *VarMeasReportList* for this *measId*;

4> stop the periodical reporting timer for this *measId*, if running;

- 2> if the *purpose* is included and set to '*reportStrongestCells*' or '*reportStrongestCellsForSON*' and if a (first) measurement result is available for one or more applicable cells:
 - 3> include a measurement reporting entry within the *VarMeasReportList* for this *measId*;
 - 3> set the *numberOfReportsSent* defined within the *VarMeasReportList* for this *measId* to 0;
 - 3> initiate the measurement reporting procedure, as specified in 5.5.5;

NOTE 1: If the *purpose* is set to '*reportStrongestCells*', the UE initiates a first measurement report immediately after the quantity to be reported becomes available for at least either serving cell or one of the applicable cells. If the *purpose* is set to '*reportStrongestCellsForSON*', the UE initiates a first measurement report when it has determined the strongest cells on the associated frequency.

- 2> upon expiry of the periodical reporting timer for this *measId*:
 - 3> initiate the measurement reporting procedure, as specified in 5.5.5;
- 2> if the *purpose* is included and set to '*reportCGI*' and if the UE acquired the information needed to set all fields of *cgi-Info* for the requested cell:
 - 3> include a measurement reporting entry within the *VarMeasReportList* for this *measId*;
 - 3> set the *numberOfReportsSent* defined within the *VarMeasReportList* for this *measId* to 0;
 - 3> stop timer T321;
 - 3> initiate the measurement reporting procedure, as specified in 5.5.5;
- 2> upon expiry of the T321 for this *measId*:
 - 3> include a measurement reporting entry within the *VarMeasReportList* for this *measId*;
 - 3> set the *numberOfReportsSent* defined within the *VarMeasReportList* for this *measId* to 0;
 - 3> initiate the measurement reporting procedure, as specified in 5.5.5;

NOTE 2: The UE does not stop the periodical reporting with *triggerType* set to '*event*' or to '*periodical*' while the corresponding measurement is not performed due to the serving cell RSRP being equal to or better than *s-Measure* or due to the measurement gap not being setup.

NOTE 3: If the UE is configured with DRX, the UE may delay the measurement reporting for event triggered and periodical triggered measurements until the Active Time, which is defined in TS 36.321 [6].

[TS 36.331, clause 5.5.4.4]

The UE shall:

- 1> consider the entering condition for this event to be satisfied when condition A3-1, as specified below, is fulfilled;
- 1> consider the leaving condition for this event to be satisfied when condition A3-2, as specified below, is fulfilled;

Inequality A3-1 (Entering condition):

$$Mn + Ofn + Ocn - Hys > Ms + OfS + Ocs + Off$$

Inequality A3-2 (Leaving condition):

$$Mn + Ofn + Ocn + Hys < Ms + OfS + Ocs + Off$$

The variables in the formula are defined as follows:

Mn is the measurement result of the neighbouring cell, not taking into account any offsets.

Ofn is the frequency specific offset of the frequency of the neighbour cell (i.e. *offsetFreq* as defined within *measObjectEUTRA* corresponding to the frequency of the neighbour cell).

Ocn is the cell specific offset of the neighbour cell (i.e. *cellIndividualOffset* as defined within *measObjectEUTRA* corresponding to the frequency of the neighbour cell), and set to zero if not configured for the neighbour cell.

Ms is the measurement result of the serving cell, not taking into account any offsets.

Ofs is the frequency specific offset of the serving frequency (i.e. *offsetFreq* as defined within *measObjectEUTRA* corresponding to the serving frequency).

Ocs is the cell specific offset of the serving cell (i.e. *cellIndividualOffset* as defined within *measObjectEUTRA* corresponding to the serving frequency), and is set to zero if not configured for the serving cell.

Hys is the hysteresis parameter for this event (i.e. *hysteresis* as defined within *reportConfigEUTRA* for this event).

Off is the offset parameter for this event (i.e. *a3-Offset* as defined within *reportConfigEUTRA* for this event).

Mn, Ms are expressed in dBm in case of RSRP, or in dB in case of RSRQ.

Ofn, Ocn, Ofs, Ocs, Hys, Off are expressed in dB.

[TS 36.331, clause 5.5.5]

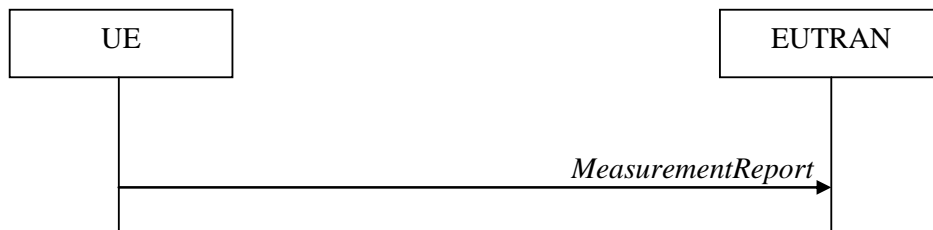

Figure 5.5.5-1: Measurement reporting

The purpose of this procedure is to transfer measurement results from the UE to E-UTRAN.

For the *measId* for which the measurement reporting procedure was triggered, the UE shall set the *measResults* within the *MeasurementReport* message as follows:

- 1> set the *measId* to the measurement identity that triggered the measurement reporting;
 - 1> set the *measResultServCell* to include the quantities of serving cell;
 - 1> if there is at least one applicable neighbouring cell to report:
 - 2> set the *measResultNeighCells* to include the best neighbouring cells up to *maxReportCells* in accordance with the following:
 - 3> if the *triggerType* is set to 'event':
 - 4> include the cells included in the *cellsTriggeredList* as defined within the *VarMeasReportList* for this *measId*;
 - 3> else:
 - 4> include the applicable cells for which the new measurement results became available since the last periodical reporting or since the measurement was initiated or reset;
- NOTE: The reliability of the report (i.e. the certainty it contains the strongest cells on the concerned frequency) depends on the measurement configuration i.e. the *reportInterval*. The related performance requirements are specified in TS 36.133 [16].
- 3> for each cell that is included in the *measResultNeighCells*, include the *physCellId*;
 - 3> if the *triggerType* is set to 'event'; or the *purpose* is set to 'reportStrongestCells' or to 'reportStrongestCellsForSON':

- 4> for each included cell, include the layer 3 filtered measured results in accordance with the *reportConfig* for this *measId*, ordered as follows:
 - 5> if the *measObject* associated with this *measId* concerns E-UTRA:
 - 6> set the *measResult* to include the quantity(ies) indicated in the *reportQuantity* within the concerned *reportConfig* in order of decreasing *triggerQuantity*, i.e. the best cell is included first;
 - 5> else:
 - 6> set the *measResult* to the quantity as configured for the concerned RAT within the *quantityConfig* in order of either decreasing quantity for UTRA and GERAN or increasing quantity for CDMA2000 *pilotStrength*, i.e. the best cell is included first;
- 3> else if the *purpose* is set to '*reportCGI*':
 - 4> if the mandatory present fields of the *cgi-Info* for the cell indicated by the *cellForWhichToReportCGI* in the associated *measObject* have been obtained:
 - 5> if the cell broadcasts a CSG identity:
 - 6> include the *csg-Identity*;
 - 6> include the *csg-MemberStatus* and set it to '*member*' if the cell is a CSG member cell;
 - 5> if the '*si-RequestForHO*' is configured within the *reportConfig* associated with this *measId*:
 - 6> include the *cgi-Info* containing all the fields that have been successfully acquired, except for the *plmn-IdentityList*;
 - 5> else:
 - 6> include the *cgi-Info* containing all the fields that have been successfully acquired;
 - 1> if the *ue-RxTxTimeDiffPeriodical* is configured within the corresponding *reportConfig* for this *measId*:
 - 2> set the *ue-RxTxTimeDiffResult* to the measurement result provided by lower layers;
 - 2> set the *currentSFN*;
 - 1> increment the *numberOfReportsSent* as defined within the *VarMeasReportList* for this *measId* by 1;
 - 1> stop the periodical reporting timer, if running;
 - 1> if the *numberOfReportsSent* as defined within the *VarMeasReportList* for this *measId* is less than the *reportAmount* as defined within the corresponding *reportConfig* for this *measId*:
 - 2> start the periodical reporting timer with the value of *reportInterval* as defined within the corresponding *reportConfig* for this *measId*;
 - 1> else:
 - 2> if the *triggerType* is set to '*periodical*':
 - 3> remove the entry within the *VarMeasReportList* for this *measId*;
 - 3> remove this *measId* from the *measIdList* within *VarMeasConfig*;
 - 1> if the measured results are for CDMA2000 HRPD:
 - 2> set the *preRegistrationStatusHRPD* to the UE's CDMA2000 upper layer's HRPD *preRegistrationStatus*;
 - 1> if the measured results are for CDMA2000 1xRTT:
 - 2> set the *preRegistrationStatusHRPD* to '*FALSE*';
 - 1> submit the *MeasurementReport* message to lower layers for transmission, upon which the procedure ends;

8.3.1.3a.3 Test description

8.3.1.3a.3.1 Pre-test conditions

System Simulator:

- Cell 1, Cell 2 and Cell 3
- System information combination 3 as defined in TS 36.508 [18] clause 4.4.3.1 is used in E-UTRA cells.

UE:

None.

Preamble:

- The UE is in state Generic RB Established (state 3) on Cell 1 according to [18].

8.3.1.3a.3.2 Test procedure sequence

Table 8.3.1.3a.3.2-1 illustrates the downlink power levels to be applied for Cell 1, Cell 2 and Cell 3 at various time instants of the test execution. Row marked "T0" denotes the conditions after the preamble, while rows marked "T1" and "T2" are to be applied subsequently. The exact instants on which these values shall be applied are described in the texts in this clause.

Table 8.3.1.3a.3.2-1: Time instances of cell power level and parameter changes

	Parameter	Unit	Cell 1	Cell 2 (DL only)	Cell 3 (DL only)	Remark
T0	Cell-specific RS EPRE	dBm/15 kHz	-85	-91	"Off"	Power levels are such that entry condition for event A3 (<i>measId</i> 1 & 2) is not satisfied: $Mn + Ofn + Ocn + Hys < Ms + Ofs + Ocs + Off$
	RSRQ	dB	-8	-14	-	
	Noc	dBm/15 kHz	-90	-90	-100	
T1	Cell-specific RS EPRE	dBm/15 kHz	-91	-85	"Off"	Power levels are such that entry condition for event A3 (<i>measId</i> 1) is satisfied: $Mn + Ofn + Ocn - Hys > Ms + Ofs + Ocs + Off$
	RSRQ	dB	-14]	-8	-	
T2	Cell-specific RS EPRE	dBm/15 kHz	-91	"Off"	-97	Power levels are such that entry condition for event A3 (<i>measId</i> 2) is satisfied: $Mn + Ofn + Ocn - Hys > Ms + Ofs + Ocs + Off$
	RSRQ	dB	-12.33	-	-3.76	
NOTE 1: Power level "Off" is defined in TS36.508 Table 6.2.2.1-1.						

Table 8.3.1.3a.3.2-2: Main behaviour

St	Procedure	Message Sequence		TP	Verdict
		U - S	Message		
1	The SS transmits an <i>RRCConnectionReconfiguration</i> message on Cell 1 including <i>MeasConfig</i> to setup intra E-UTRAN measurement and reporting for two event A3 (<i>measId 1</i> and <i>measId 2</i>) (intra and inter frequency measurement).	<--	<i>RRCConnectionReconfiguration</i>	-	-
2	The UE transmits an <i>RRCConnectionReconfigurationComplete</i> message on Cell 1.	-->	<i>RRCConnectionReconfigurationComplete</i>	-	-
3	Check: Does the UE transmit a <i>MeasurementReport</i> message on Cell 1 within the next 10s?	-->	<i>MeasurementReport</i>	1	F
3A	The SS notifies the UE of change of System Information and changes the system information 3. The <i>systemInfoValueTag</i> in the <i>SystemInformationBlockType1</i> is increased.	<--	<i>Paging</i>	-	-
4	The SS re-adjusts the cell-specific reference signal level according to row "T1" in table 8.3.1.3a.3.2-1.	-	-	-	-
5	Check: Does the UE transmit a <i>MeasurementReport</i> message on Cell 1 to report event A3 (<i>measId 1</i>) with the measured RSRP and RSRQ values for Cell 2?	-->	<i>MeasurementReport</i>	2	P
6	The SS re-adjusts the cell-specific reference signal level according to row "T2" in table 8.3.1.3a.3.2-1.	-	-	-	-
7	Check: Does the UE transmit a <i>MeasurementReport</i> message on Cell 1 to report event A3 (<i>measId 2</i>) with the measured RSRP and RSRQ values for Cell 3?	-->	<i>MeasurementReport</i>	2	P

8.3.1.3a.3.3 Specific message contents

Table 8.3.1.3a.3.3-1: *RRCConnectionReconfiguration* (step 1, Table 8.3.1.3a.3.2-2)

Derivation Path: 36.508, Table 4.6.1-8, condition MEAS
--

Table 8.3.1.3a.3.3-2: MeasConfig (Table 8.3.1.3a.3.3-1)

Derivation Path: 36.508, Table 4.6.6-1, condition INTER-FREQ			
Information Element	Value/remark	Comment	Condition
MeasConfig ::= SEQUENCE {			
measObjectToAddModList SEQUENCE (SIZE (1..maxObjectId)) OF SEQUENCE {	2 entries		
measObjectId[1]	IdMeasObject-f1		
measObject[1]	MeasObjectEUTRA-GENERIC(f1)		
measObjectId[2]	IdMeasObject-f2		
measObject[2]	MeasObjectEUTRA-GENERIC(f2)		
}			
reportConfigToAddModList SEQUENCE (SIZE (1..maxReportConfigId)) OF SEQUENCE {	1 entry		
reportConfigId[1]	IdReportConfig-A3		
reportConfig[1]	ReportConfigEUTRA-A3-RSRQ		
}			
measIdToAddModList SEQUENCE (SIZE (1..maxMeasId)) OF SEQUENCE {	2 entries		
measId[1]	1		
measObjectId[1]	IdMeasObject-f1		
reportConfigId[1]	IdReportConfig-A3		
measId[2]	2		
measObjectId[2]	IdMeasObject-f2		
reportConfigId[2]	IdReportConfig-A3		
}			
}			

Table 8.3.1.3a.3.3-3: ReportConfigEUTRA-A3-RSRQ (Table 8.3.1.3a.3.3-2)

Derivation Path: 36.508, Table 4.6.6-6			
Information Element	Value/remark	Comment	Condition
ReportConfigEUTRA-A3 ::= SEQUENCE {			
triggerQuantity	rsrq		
si-RequestForHO-r9	Not present		
ue-RxTxTimeDiffPeriodical-r9	Not present		
}			

Table 8.3.1.3a.3.3-3a: SystemInformationBlockType3 for Cell 1 (Step 3A, Table 6.1.2.18.3.2-2)

Derivation path: 36.508 table 4.4.3.3-2			
Information Element	Value/Remark	Comment	Condition
SystemInformationBlockType3 ::= SEQUENCE {			
lateNonCriticalExtension {			
q-QualMin-r9	-30 dB		
}			
}			

Table 8.3.1.3a.3.3-4: *MeasurementReport* (step 5, Table 8.3.1.3a.3.2-2)

Derivation Path: 36.508, Table 4.6.1-5			
Information Element	Value/remark	Comment	Condition
MeasurementReport ::= SEQUENCE {			
criticalExtensions CHOICE {			
c1 CHOICE{			
measurementReport-r8 SEQUENCE {			
measResults SEQUENCE {			
measId	1		
measResultServCell SEQUENCE {			
rsrpResult	(0..97)		
rsrqResult	(0..34)		
}			
measResultNeighCells CHOICE {			
measResultListEUTRA SEQUENCE (SIZE (1..maxCellReport)) OF SEQUENCE {	1 entry		
physCellId	PhysicalCellIdentity of Cell 2		
cgi-Info	Not present		
measResult SEQUENCE {			
rsrpResult	(0..97)		
rsrqResult	(0..34)		
additionalSI-Info-r9	Not present		
}			
}			
}			
measResultForECID-r9	Not present		
}			
}			
}			

Table 8.3.1.3a.3.3-5: *MeasurementReport* (step 7, Table 8.3.1.3a.3.2-2)

Derivation Path: 36.508, Table 4.6.1-5			
Information Element	Value/remark	Comment	Condition
MeasurementReport ::= SEQUENCE {			
criticalExtensions CHOICE {			
c1 CHOICE{			
measurementReport-r8 SEQUENCE {			
measResults SEQUENCE {			
measId	2		
measResultServCell SEQUENCE {			
rsrpResult	(0..97)		
rsrqResult	(0..34)		
}			
measResultNeighCells CHOICE {			
measResultListEUTRA SEQUENCE (SIZE (1..maxCellReport)) OF SEQUENCE {	1 entry		
physCellId	PhysicalCellIdentity of Cell 3		
cgi-Info	Not present		
measResult SEQUENCE {			
rsrpResult	(0..97)		
rsrqResult	(0..34)		
additionalSI-Info-r9	Not present		
}			
}			
}			
measResultForECID-r9	Not present		
}			
}			
}			

Table 8.3.1.3a.3.3-6: *Paging* (step 3A, Table 8.3.1.3a.3.2-2)

Derivation path: 36.508 Table 4.6.1-7			
Information Element	Value/Remark	Comment	Condition
Paging ::= SEQUENCE {			
pagingRecordList	Not present		
systemInfoModification	true		
}			

8.3.1.4 Measurement configuration control and reporting / Intra E-UTRAN measurements / Periodic reporting (intra and inter-frequency measurements)

8.3.1.4.1 Test Purpose (TP)

(1)

```
with { UE in E-UTRA RRC_CONNECTED state and measurement configured for periodic reporting of intra
frequency cells and inter frequency cells on specified frequency }
ensure that {
  when { The UE receives reference signal power for cells on the serving frequency and cells on the
frequency where measurements are configured }
  then { UE sends MeasurementReport message at regular intervals for these cells }
}
```

(2)

```
with { UE in E-UTRA RRC_CONNECTED state and a MeasurementReport message for a configured periodic
measurement reporting of intra and inter frequency cells was sent }
ensure that {
  when { A previously reported cell become unavailable or the UE receives reference signal power on
a reported frequency for a cell which was previously not reported }
  then { UE sends MeasurementReport message at regular intervals for the available intra and inter
frequency cells }
}
```

}

(3)

```

with { UE in E-UTRA RRC_CONNECTED state and periodic measurement reporting ongoing}
ensure that {
  when { The UE receives a RRCConnectionReconfiguration message removing measIds for periodic
reporting }
  then { UE stops sending MeasurementReport messages for these measIds }
}

```

8.3.1.4.2 Conformance requirements

References: The conformance requirements covered in the current TC are specified in: TS 36.331, clauses 5.3.5.3, 5.5.2.2, 5.5.4.1 and 5.5.5.

[TS 36.331, clause 5.3.5.3]

If the *RRCConnectionReconfiguration* message does not include the *mobilityControlInfo* and the UE is able to comply with the configuration included in this message, the UE shall:

...

- 1> If the *RRCConnectionReconfiguration* message includes the *measConfig*:
- 2> perform the Measurement configuration procedure as specified in 5.5.2;

...

[TS 36.331, clause 5.5.2.2]

The UE shall:

- 1> for each *measId* value included in the received *measIdToRemoveList* that is part of the current UE configuration in *varMeasConfig*:
- 2> remove the entry with the matching *measId* from the *measIdList* within the *VarMeasConfig*;
- 2> remove the measurement reporting entry for this *measId* from the *VarMeasReportList*, if included;
- 2> stop the periodical reporting timer or timer T321, whichever one is running, and reset the associated information (e.g. *timeToTrigger*) for this *measId*;

[TS 36.331, clause 5.5.4.1]

The UE shall:

- 1> for each *measId* included in the *measIdList* within *VarMeasConfig*:

...

- 2> else:
 - 3> if the corresponding *measObject* concerns E-UTRA:
 - 4> consider any neighbouring cell detected on the associated frequency to be applicable when the concerned cell is not included in the *blackCellsToAddModList* defined within the *VarMeasConfig* for this *measId*;

...

- 2> if the *purpose* is included and set to '*reportStrongestCells*' or to '*reportStrongestCellsForSON*' and if a (first) measurement result is available for one or more applicable cells:
 - 3> include a measurement reporting entry within the *VarMeasReportList* for this *measId*;
 - 3> set the *numberOfReportsSent* defined within the *VarMeasReportList* for this *measId* to 0;
 - 3> initiate the measurement reporting procedure, as specified in 5.5.5;

NOTE 1: If the *purpose* is set to ‘*reportStrongestCells*’, the UE initiates a first measurement report immediately after the quantity to be reported becomes available for at least either serving cell or one of the applicable cells. If the *purpose* is set to ‘*reportStrongestCellsForSON*’, the UE initiates a first measurement report when it has determined the strongest cells on the associated frequency.

2> upon expiry of the periodical reporting timer for this *measId*:

3> initiate the measurement reporting procedure, as specified in 5.5.5;

...

NOTE 2: The UE does not stop the periodical reporting with *triggerType* set to ‘*event*’ or to ‘*periodical*’ while the corresponding measurement is not performed due to the serving cell RSRP being equal to or better than *s-Measure* or due to the measurement gap not being setup.

...

[TS 36.331, clause 5.5.5]

...

For the *measId* for which the measurement reporting procedure was triggered, the UE shall set the *measuredResults* within the *MeasurementReport* message as follows:

1> set the *measId* to the measurement identity that triggered the measurement reporting;

1> set the *measResultServCell* to include the quantities of serving cell;

1> if there is at least one applicable neighbouring cell to report:

2> set the *measResultsNeighCells* to include the best neighbouring cells up to *maxReportCells* in accordance with the following:

3> if the *triggerType* is set to ‘*event*’:

4> include the cells included in the *cellsTriggeredList* as defined within the *VarMeasReportList* for this *measId*;

3> else:

4> include the applicable cells for which the new measurement results became available since the last periodical reporting or since the measurement was initiated or reset;

NOTE: The reliability of the report (i.e. the certainty it contains the strongest cells on the concerned frequency) depends on the measurement configuration i.e. the *reportInterval*. The related performance requirements are specified in TS 36.133 [16].

3> for each cell that is included in the *measResultsNeighCells*, include the *physCellId*;

3> if the *triggerType* is set to ‘*event*’; or the *purpose* is set to ‘*reportStrongestCells*’ or to ‘*reportStrongestCellsForSON*’:

4> for each included cell, include the layer 3 filtered measured results in accordance with the *reportConfig* for this *measId*, ordered as follows:

5> if the *measObject* associated with this *measId* concerns E-UTRA:

6> set the *measResult* to include the quantity(ies) indicated in the *reportQuantity* within the concerned *reportConfig* in order of decreasing *triggerQuantity*, i.e. the best cell is included first;

...

1> increment the *numberOfReportsSent* as defined within the *VarMeasReportList* for this *measId* by 1;

1> stop the periodical reporting timer, if running;

- 1> if the *numberOfReportsSent* as defined within the *VarMeasReportList* for this *measId* is less than to *reportAmount* as defined corresponding *reportConfig* for this *measId*:
- 2> start the periodical reporting timer with the value of *reportInterval* as defined within the corresponding *reportConfig* for this *measId*;

...

- 1> submit the MEASUREMENT REPORT message to lower layers for transmission, upon which the procedure ends.

8.3.1.4.3 Test description

8.3.1.4.3.1 Pre-test conditions

System Simulator:

- Cell 1, Cell 2, Cell 3, Cell 4 and Cell 6
- System information combination 3 as defined in TS 36.508 [18] clause 4.4.3.1 is used in E-UTRA cells.

UE:

None.

Preamble:

- The UE is in state Generic RB Established (state 3) according to [18] on Cell 1.

8.3.1.4.3.2 Test procedure sequence

Table 8.3.1.4.3.2-1 illustrates the downlink power levels to be applied for the cells at various time instants of the test execution. Row marked "T0" denotes the conditions after the preamble, while rows marked "T1" and "T2" are to be applied subsequently. The exact instants on which these values shall be applied are described in the texts in this clause.

Table 8.3.1.4.3.2-1: Power levels

	Parameter	Unit	Cell 1	Cell 2 (DL only)	Cell 3 (DL only)	Cell 4 (DL only)	Cell 6 (DL only)	Remark
T0	Cell-specific RS EPRE	dBm/ 15kHz z	-85	-91	-85	Off	Off	
T1	Cell-specific RS EPRE	dBm/ 15kHz z	-85	Off	-85	-91	Off	
T2	Cell-specific RS EPRE	dBm/ 15kHz z	-85	Off	Off	-91	-85	

Table 8.3.1.4.3.2-2: Main behaviour

St	Procedure	Message Sequence		TP	Verdict
		U - S	Message		
1	SS transmits an <i>RRCCONNECTIONRECONFIGURATION</i> message including <i>measConfig</i> to setup intra LTE measurements and periodical reporting for intra and inter frequency cells.	<--	<i>RRCCONNECTIONRECONFIGURATION</i>	-	-
2	The UE transmits an <i>RRCCONNECTIONRECONFIGURATIONCOMPLETE</i> message.	-->	<i>RRCCONNECTIONRECONFIGURATIONCOMPLETE</i>	-	-
2A	Wait and ignore <i>MEASUREMENTREPORT</i> messages for 8 s to allow for the switching of the cells and UE to measure the neighbouring cells.	-	-	-	-
-	EXCEPTION: In parallel to events described in step 3 the steps specified in table 8.3.1.4.3.2-3, 8.3.1.4.3.2-4 and the table 8.3.1.4.3.2-4A shall take place				
3	Wait for 30 s to ensure that the UE performs a periodical intra frequency reporting and a periodical inter frequency reporting.	-	-	1	-
4	SS sets the cell-specific reference signal levels and switches Cell 2 "Off" and Cell 4 "On" according to row "T1" in table 8.3.1.4.3.2-1.	-	-	-	-
5	Wait and ignore <i>MEASUREMENTREPORT</i> messages for 8 s to allow for the switching of cells and the UE measurement.	-	-	-	-
-	EXCEPTION: In parallel to events described in step 6 the steps specified in table 8.3.1.4.3.2-4, 8.3.1.4.3.2-4A and table 8.3.1.4.3.2-5 shall take place.				
6	Wait for 30 s to ensure that the UE performs a periodical intra frequency reporting and a periodical inter frequency reporting.	-	-	1, 2	-
7	SS sets the cell-specific reference signal levels and switches Cell 3 "Off" and Cell 6 "On" according to row "T2" in table 8.3.1.4.3.2-1.	-	-	-	-
8	Wait and ignore <i>MEASUREMENTREPORT</i> messages for 8 s to allow for the switching of cells and UE measurement.	-	-	-	-
-	EXCEPTION: In parallel to events described in steps 9 to 11 the steps specified in table 8.3.1.4.3.2-5 8.3.1.4.3.2-6 and the table 8.3.1.4.3.2-6A shall take place				
9	Wait for 30 s to ensure that the UE performs a periodical intra frequency reporting and a periodical inter frequency reporting.	-	-	1, 2	-
10	SS transmits an <i>RRCCONNECTIONRECONFIGURATION</i> message including <i>measConfig</i> to remove measIds for periodical reporting.	<--	<i>RRCCONNECTIONRECONFIGURATION</i>	-	-
11	The UE transmits an <i>RRCCONNECTIONRECONFIGURATIONCOMPLETE</i> message	-->	<i>RRCCONNECTIONRECONFIGURATIONCOMPLETE</i>	-	-
12	Check: Does the UE attempt to transmit an uplink message for the next 10s?	-	-	3	F

Table 8.3.1.4.3.2-3: Parallel behaviour

St	Procedure	Message Sequence		TP	Verdict
		U - S	Message		
-	EXCEPTION: After the 1st message is received, step 1 below shall be repeated every time the duration indicated in the IE <i>reportInterval</i> has elapsed	-	-	-	-
1	Check: Does the UE transmit a <i>MeasurementReport</i> message to perform periodical intra frequency reporting for Cell 2(NOTE1)?	-->	<i>MeasurementReport</i>	1	P

NOTE 1: In the first report UE may not include measResultNeighCells for cell 2.

Table 8.3.1.4.3.2-4: Parallel behaviour

St	Procedure	Message Sequence		TP	Verdict
		U - S	Message		
-	EXCEPTION: After the 1st message is received, step 1 below shall be repeated every time the duration indicated in the IE <i>reportInterval</i> has elapsed.	-	-	-	-
1	Check: Does the UE transmit a <i>MeasurementReport</i> message to perform periodical inter frequency reporting for Cell 3(NOTE2)?	-->	<i>MeasurementReport</i>	1	P

NOTE 2: In the first report UE may not include measResultNeighCells for the cell 3.

Table 8.3.1.4.3.2-4A: Parallel behaviour

St	Procedure	Message Sequence		TP	Verdict
		U - S	Message		
-	EXCEPTION: After the 1st message is received, step 1 below shall be repeated every time the duration indicated in the IE <i>reportInterval</i> has elapsed.	-	-	-	-
1	Check: Does the UE transmit a <i>MeasurementReport</i> message to perform periodical inter frequency reporting configured for cell 6 and without measResultNeighCells for the cell 6?	-->	<i>MeasurementReport</i>	1	P

Table 8.3.1.4.3.2-5: Parallel behaviour

St	Procedure	Message Sequence		TP	Verdict
		U - S	Message		
-	EXCEPTION: Step 1 below shall be repeated every time the duration indicated in the IE <i>reportInterval</i> has elapsed.	-	-	-	-
1	Check: Does the UE transmit a <i>MeasurementReport</i> message to perform periodical intra frequency reporting for Cell 4(NOTE3)?	-->	<i>MeasurementReport</i>	1, 2	P

NOTE 3: In the first report UE may not include measResultNeighCells for the cell 4.

Table 8.3.1.4.3.2-6: Parallel behaviour

St	Procedure	Message Sequence		TP	Verdict
		U - S	Message		
-	EXCEPTION: Step 1 below shall be repeated every time the duration indicated in the IE <i>reportInterval</i> has elapsed.				
1	Check: Does the UE transmit a <i>MeasurementReport</i> message to perform periodical inter frequency reporting for Cell 6 (NOTE4)?	-->	<i>MeasurementReport</i>	1, 2	P

NOTE 4: In the first report UE may not include measResultNeighCells for the cell 6.

Table 8.3.1.4.3.2-6A: Parallel behaviour

St	Procedure	Message Sequence		TP	Verdict
		U - S	Message		
-	EXCEPTION: After the 1st message is received, step 1 below shall be repeated every time the duration indicated in the IE <i>reportInterval</i> has elapsed.	-	-	-	-
1	Check: Does the UE transmit a <i>MeasurementReport</i> message to perform periodical inter frequency reporting configured for cell 3 and without measResultNeighCells for the cell 3?	-->	<i>MeasurementReport</i>	-	-

8.3.1.4.3.3 Specific message contents

Table 8.3.1.4.3.3-1: RRCConnectionReconfiguration (step 1 and step 10, Table 8.3.1.4.3.2-2)

Derivation Path: 36.508 clause 4.6.1 table 4.6.1-8 with condition MEAS
--

Table 8.3.1.4.3.3-2: *MeasConfig* (step 1, Table 8.3.1.4.3.2-2)

Derivation Path: 36.508, Table 4.6.6-1, condition INTER-FREQ			
Information Element	Value/remark	Comment	Condition
MeasConfig ::= SEQUENCE {			
measObjectToAddModList SEQUENCE (SIZE (1..maxObjectId)) OF SEQUENCE {	3 entries		
measObjectId[1]	IdMeasObject-f1		
measObject[1]	MeasObjectEUTRA-GENERIC(f1)		
measObjectId[2]	IdMeasObject-f2		
measObject[2]	MeasObjectEUTRA-GENERIC(f2)		
measObjectId[2]	IdMeasObject-f3		
measObject[2]	MeasObjectEUTRA-GENERIC(f3)		
}			
reportConfigToAddModList SEQUENCE (SIZE (1..maxReportConfigId)) OF SEQUENCE {	1 entry		
reportConfigId[1]	IdReportConfig-PERIODICAL		
reportConfig[1]	ReportConfigEUTRA-PERIODICAL		
}			
measIdToAddModList SEQUENCE (SIZE (1..maxMeasId)) OF SEQUENCE {	3 entries		
measId[1]	1		
measObjectId[1]	IdMeasObject-f1		
reportConfigId[1]	IdReportConfig-PERIODICAL		
measId[2]	2		
measObjectId[2]	IdMeasObject-f2		
reportConfigId[2]	IdReportConfig-PERIODICAL		
measId[3]	3		
measObjectId[3]	IdMeasObject-f3		
reportConfigId[3]	IdReportConfig-PERIODICAL		
}			
}			

Table 8.3.1.4.3.3-3 Void

Table 8.3.1.4.3.3-4: *MeasConfig* (step 10, Table 8.3.1.4.3.2-2)

Derivation Path: 36.508, Table 4.6.6-1			
Information Element	Value/remark	Comment	Condition
MeasConfig ::= SEQUENCE {			
measIdToRemoveList SEQUENCE (SIZE (1..maxMeasId)) OF SEQUENCE {	3 entries		
MeasId[1]	1		
MeasId[2]	2		
MeasId[3]	3		
}			
}			

Table 8.3.1.4.3.3-5: MeasurementReport (step 1, Table 8.3.1.4.3.2-3)

Derivation Path: 36.508 clause 4.6.1 table 4.6.1-5			
Information Element	Value/remark	Comment	Condition
MeasurementReport ::= SEQUENCE {			
criticalExtensions CHOICE {			
c1 CHOICE {			
measurementReport-r8 SEQUENCE {			
measResults ::= SEQUENCE {			
measId	1		
measResultServCell ::= SEQUENCE {		Report Cell 1	
rsrpResult	(0..97)		
rsrqResult	(0..34)		
}			
measResultNeighCells CHOICE {			
measResultListEUTRA ::= SEQUENCE (SIZE (1..maxCellReport)) OF SEQUENCE {		Report Cell 2	
physCellId [1]	physicalCellIdentity-Cell2		
measResult [1] SEQUENCE {			
rsrpResult	(0..97)		
rsrqResult	(0..34)		
}			
}			
}			
}			
}			
}			
}			

Table 8.3.1.4.3.3-6: MeasurementReport (step 1, Table 8.3.1.4.3.2-5)

Derivation Path: 36.508 clause 4.6.1 table 4.6.1-5			
Information Element	Value/remark	Comment	Condition
MeasurementReport ::= SEQUENCE {			
criticalExtensions CHOICE {			
c1 CHOICE {			
measurementReport-r8 SEQUENCE {			
measResults ::= SEQUENCE {			
measId	1		
measResultServCell ::= SEQUENCE {		Report Cell 1	
rsrpResult	(0..97)		
rsrqResult	(0..34)		
}			
measResultNeighCells CHOICE {			
measResultListEUTRA ::= SEQUENCE (SIZE (1..maxCellReport)) OF SEQUENCE {		Report Cell 4	
physCellId [1]	physicalCellIdentity-Cell4		
measResult [1] SEQUENCE {			
rsrpResult	(0..97)		
rsrqResult	(0..34)		
}			
}			
}			
}			
}			
}			
}			

Table 8.3.1.4.3.3-7: MeasurementReport (step 1, Table 8.3.1.4.3.2-4)

Derivation Path: 36.508 clause 4.6.1 table 4.6.1-5			
Information Element	Value/remark	Comment	Condition
MeasurementReport ::= SEQUENCE {			
criticalExtensions CHOICE {			
c1 CHOICE {			
measurementReport-r8 SEQUENCE {			
measResults ::= SEQUENCE {			
measId	2		
measResultServCell ::= SEQUENCE {		Report Cell 1	
rsrpResult	(0..97)		
rsrqResult	(0..34)		
}			
measResultNeighCells CHOICE {			
measResultListEUTRA ::= SEQUENCE (SIZE (1..maxCellReport)) OF SEQUENCE {		Report Cell 3	
physCellId [1]	physicalCellIdentity-Cell3		
measResult [1] SEQUENCE {			
rsrpResult	(0..97)		
rsrqResult	(0..34)		
}			
}			
}			
}			
}			
}			
}			

Table 8.3.1.4.3.3-7A: MeasurementReport (step 1, Table 8.3.1.4.3.2-4A)

Derivation Path: 36.508 clause 4.6.1 table 4.6.1-5			
Information Element	Value/remark	Comment	Condition
MeasurementReport ::= SEQUENCE {			
criticalExtensions CHOICE {			
c1 CHOICE {			
measurementReport-r8 SEQUENCE {			
measResults ::= SEQUENCE {			
measId	3		
measResultServCell ::= SEQUENCE {		Report Cell 1	
rsrpResult	(0..97)		
rsrqResult	(0..34)		
}			
measResultNeighCells CHOICE {}	Not present		
}			
}			
}			
}			

Table 8.3.1.4.3.3-8: MeasurementReport (step 1, Table 8.3.1.4.3.2-6)

Derivation Path: 36.508 clause 4.6.1 table 4.6.1-5			
Information Element	Value/remark	Comment	Condition
MeasurementReport ::= SEQUENCE {			
criticalExtensions CHOICE {			
c1 CHOICE {			
measurementReport-r8 SEQUENCE {			
measResults ::= SEQUENCE {			
measId	3		
measResultServCell ::= SEQUENCE {		Report Cell 1	
rsrpResult	(0..97)		
rsrqResult	(0..34)		
}			
measResultNeighCells CHOICE {			
measResultListEUTRA ::= SEQUENCE (SIZE (1..maxCellReport)) OF SEQUENCE {		Report Cell 6	
physCellId [1]	physicalCellIdentity-Cell6		
measResult [1] SEQUENCE {			
rsrpResult	(0..97)		
rsrqResult	(0..34)		
}			
}			
}			
}			
}			
}			
}			

Table 8.3.1.4.3.3-9: MeasurementReport (step 1, Table 8.3.1.4.3.2-6A)

Derivation Path: 36.508 clause 4.6.1 table 4.6.1-5			
Information Element	Value/remark	Comment	Condition
MeasurementReport ::= SEQUENCE {			
criticalExtensions CHOICE {			
c1 CHOICE {			
measurementReport-r8 SEQUENCE {			
measResults ::= SEQUENCE {			
measId	2		
measResultServCell ::= SEQUENCE {		Report Cell 1	
rsrpResult	(0..97)		
rsrqResult	(0..34)		
}			
measResultNeighCells CHOICE {}	Not present		
}			
}			
}			
}			

8.3.1.5 Measurement configuration control and reporting / Intra E-UTRAN measurements / Two simultaneous event A3 (intra-frequency measurements)

8.3.1.5.1 Test Purpose (TP)

(1)

```

with { UE in E-UTRA RRC_CONNECTED state and measurements configured for two event A3 at the same time}
ensure that {
  when { Entry condition for event A3 is not met }
  then { UE does not send MeasurementReport }
}
    
```

(2)

```

with { UE in E-UTRA RRC_CONNECTED state and measurements configured for two event A3 at the same
time}
ensure that {
  when { Neighbour becomes offset better than serving }
  then { UE sends MeasurementReport with correct measId for event A3 }
}

```

8.3.1.5.2 Conformance requirements

References: The conformance requirements covered in the current TC are specified in: TS 36.331, clauses 5.3.5.3, 5.5.4.1, 5.5.4.4 and 5.5.5.

[TS 36.331, clause 5.3.5.3]

If the *RRCCONNECTIONRECONFIGURATION* message does not include the *mobilityControlInfo* and the UE is able to comply with the configuration included in this message, the UE shall:

...

- 1> If the *RRCCONNECTIONRECONFIGURATION* message includes the *measConfig*:
- 2> perform the Measurement configuration procedure as specified in 5.5.2;

...

[TS 36.331, clause 5.5.4.1]

The UE shall:

- 1> for each *measId* included in the *measIdList* within *VarMeasConfig*:
 - 2> if the corresponding *reportConfig* includes a purpose set to ‘*reportStrongestCellsForSON*’:
 - 3> consider any neighbouring cell detected on the associated frequency to be applicable;
 - 2> else if the corresponding *reportConfig* includes a purpose set to ‘*reportCGI*’:
 - 3> consider any neighbouring cell detected on the associated frequency/ set of frequencies (GERAN) which has a physical cell identity matching the value of the *cellForWhichToReportCGI* included in the corresponding *measObject* within the *VarMeasConfig* to be applicable;
 - 2> else:
 - 3> if the corresponding *measObject* concerns E-UTRA:
 - 4> consider any neighbouring cell detected on the associated frequency to be applicable when the concerned cell is not included in the *blackCellsToAddModList* defined within the *VarMeasConfig* for this *measId*;
 - 3> else if the corresponding *measObject* concerns UTRA or CDMA2000:
 - 4> consider a neighbouring cell on the associated frequency to be applicable when the concerned cell is included in the *cellsToAddModList* defined within the *VarMeasConfig* for this *measId* (i.e. the cell is included in the white-list);
 - 3> else if the corresponding *measObject* concerns GERAN:
 - 4> consider a neighbouring cell on the associated set of frequencies to be applicable when the concerned cell matches the *ncc-Permitted* defined within the *VarMeasConfig* for this *measId*;
 - 2> if the *triggerType* is set to ‘*event*’ and if the entry condition applicable for this event, i.e. the event corresponding with the *eventId* of the corresponding *reportConfig* within *VarMeasConfig*, is fulfilled for one or more applicable cells for all measurements after layer 3 filtering taken during *timeToTrigger* defined for this event within the *VarMeasConfig*, while the *VarMeasReportList* does not include an measurement reporting entry for this *measId* (a first cell triggers the event):
 - 3> include a measurement reporting entry within the *VarMeasReportList* for this *measId*;

- 3> set the *numberOfReportsSent* defined within the *VarMeasReportList* for this *measId* to 0;
 - 3> include the concerned cell(s) in the *cellsTriggeredList* defined within the *VarMeasReportList* for this *measId*;
 - 3> initiate the measurement reporting procedure, as specified in 5.5.5;
 - 2> if the *triggerType* is set to 'event' and if the entry condition applicable for this event, i.e. the event corresponding with the *eventId* of the corresponding *reportConfig* within *VarMeasConfig*, is fulfilled for one or more applicable cells not included in the *cellsTriggeredList* for all measurements after layer 3 filtering taken during *timeToTrigger* defined for this event within the *VarMeasConfig* (a subsequent cell triggers the event):
 - 3> set the *numberOfReportsSent* defined within the *VarMeasReportList* for this *measId* to 0;
 - 3> include the concerned cell(s) in the *cellsTriggeredList* defined within the *VarMeasReportList* for this *measId*;
 - 3> initiate the measurement reporting procedure, as specified in 5.5.5;
 - 2> if the *triggerType* is set to 'event' and if the leaving condition applicable for this event is fulfilled for one or more of the cells included in the *cellsTriggeredList* defined within the *VarMeasReportList* for this *measId* for all measurements after layer 3 filtering taken during *timeToTrigger* defined within the *VarMeasConfig* for this event:
 - 3> remove the concerned cell(s) in the *cellsTriggeredList* defined within the *VarMeasReportList* for this *measId*;
 - 3> if *reportOnLeave* is set to *TRUE* for the corresponding reporting configuration:
 - 4> initiate the measurement reporting procedure, as specified in 5.5.5;
 - 3> if the *cellsTriggeredList* defined within the *VarMeasReportList* for this *measId* is empty:
 - 4> remove the measurement reporting entry within the *VarMeasReportList* for this *measId*;
 - 4> stop the periodical reporting timer for this *measId*, if running;
 - 2> if the *purpose* is included and set to 'reportStrongestCells' or to 'reportStrongestCellsForSON' and if a (first) measurement result is available for one or more applicable cells:
 - 3> include a measurement reporting entry within the *VarMeasReportList* for this *measId*;
 - 3> set the *numberOfReportsSent* defined within the *VarMeasReportList* for this *measId* to 0;
 - 3> initiate the measurement reporting procedure, as specified in 5.5.5;
- NOTE 1: If the *purpose* is set to 'reportStrongestCells', the UE initiates a first measurement report immediately after the quantity to be reported becomes available for at least either serving cell or one of the applicable cells. If the purpose is set to 'reportStrongestCellsForSON', the UE initiates a first measurement report when it has determined the strongest cells on the associated frequency.
- 2> upon expiry of the periodical reporting timer for this *measId*:
 - 3> initiate the measurement reporting procedure, as specified in 5.5.5;
 - 2> if the *purpose* is included and set to 'reportCGI' and if the UE acquired the information needed to set all fields of *cellGlobalId* for the requested cell:
 - 3> include a measurement reporting entry within the *VarMeasReportList* for this *measId*;
 - 3> set the *numberOfReportsSent* defined within the *VarMeasReportList* for this *measId* to 0;
 - 3> stop timer T321;
 - 3> initiate the measurement reporting procedure, as specified in 5.5.5;

2> upon expiry of the T321 for this *measId*:

3> include a measurement reporting entry within the *VarMeasReportList* for this *measId*;

3> set the *numberOfReportsSent* defined within the *VarMeasReportList* for this *measId* to 0;

3> initiate the measurement reporting procedure, as specified in 5.5.5;

NOTE 2: The UE does not stop the periodical reporting with *triggerType* set to 'event' or to 'periodical' while the corresponding measurement is not performed due to the serving cell RSRP being equal to or better than *s-Measure* or due to the measurement gap not being setup.

NOTE 3: If the UE is configured with DRX, the UE may delay the measurement reporting for event triggered and periodical triggered measurements until the Active Time, which is defined in TS 36.321 [6].

[TS 36.331, clause 5.5.4.4]

The UE shall:

1> consider the entering condition for this event to be satisfied when condition A3-1, as specified below, is fulfilled;

1> consider the leaving condition for this event to be satisfied when condition A3-2, as specified below, is fulfilled;

Inequality A3-1 (Entering condition)

$$Mn + Ofn + Ocn - Hys > Ms + Ofs + Ocs + Off$$

Inequality A3-2 (Leaving condition)

$$Mn + Ofn + Ocn + Hys < Ms + Ofs + Ocs + Off$$

The variables in the formula are defined as follows:

Mn is the measurement result of the neighbouring cell, not taking into account any offsets.

Ofn is the frequency specific offset of the frequency of the neighbour cell (i.e. *offsetFreq* as defined within *measObjectEUTRA* corresponding to the frequency of the neighbour cell).

Ocn is the cell specific offset of the neighbour cell (i.e. *cellIndividualOffset* as defined within *measObjectEUTRA* corresponding to the frequency of the neighbour cell), and set to zero if not configured for the neighbour cell.

Ms is the measurement result of the serving cell, not taking into account any offsets.

Ofs is the frequency specific offset of the serving frequency (i.e. *offsetFreq* as defined within *measObjectEUTRA* corresponding to the serving frequency).

Ocs is the cell specific offset of the serving cell (i.e. *cellIndividualOffset* as defined within *measObjectEUTRA* corresponding to the serving frequency), and is set to zero if not configured for the serving cell.

Hys is the hysteresis parameter for this event (i.e. *hysteresis* as defined within *reportConfigEUTRA* for this event).

Off is the offset parameter for this event (i.e. *a3-Offset* as defined within *reportConfigEUTRA* for this event).

Mn*, *Ms are expressed in dBm in case of RSRP, or in dB in case of RSRQ.

Ofn*, *Ocn*, *Ofs*, *Ocs*, *Hys*, *Off are expressed in dB.

[TS 36.331, clause 5.5.5]

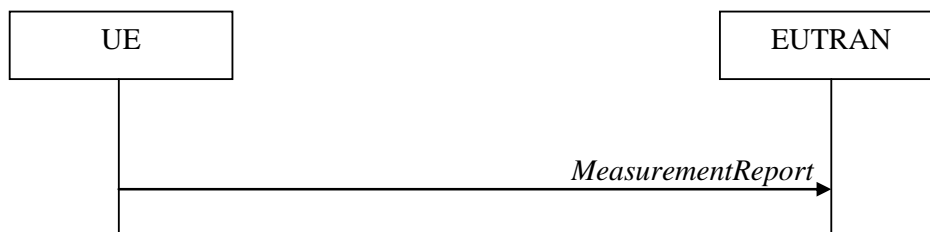

Figure 5.5.5-1: Measurement reporting

The purpose of this procedure is to transfer measurement results from the UE to E-UTRAN.

For the *measId* for which the measurement reporting procedure was triggered, the UE shall set the *measResults* within the *MeasurementReport* message as follows:

- 1> set the *measId* to the measurement identity that triggered the measurement reporting;
- 1> set the *measResultServCell* to include the quantities of serving cell;
- 1> if there is at least one applicable neighbouring cell to report:
 - 2> set the *measResultNeighCells* to include the best neighbouring cells up to *maxReportCells* in accordance with the following:
 - 3> if the *triggerType* is set to 'event':
 - 4> include the cells included in the *cellsTriggeredList* as defined within the *VarMeasReportList* for this *measId*;
 - 3> else:
 - 4> include the applicable cells for which the new measurement results became available since the last periodical reporting or since the measurement was initiated or reset;

NOTE: The reliability of the report (i.e. the certainty it contains the strongest cells on the concerned frequency) depends on the measurement configuration i.e. the *reportInterval*. The related performance requirements are specified in TS 36.133 [16].

- 3> for each cell that is included in the *measResultNeighCells*, include the *physCellId*;
- 3> if the *triggerType* is set to 'event'; or the *purpose* is set to 'reportStrongestCells' or to 'reportStrongestCellsForSON':
 - 4> for each included cell, include the layer 3 filtered measured results in accordance with the *reportConfig* for this *measId*, ordered as follows:
 - 5> if the *measObject* associated with this *measId* concerns E-UTRA:
 - 6> set the *measResult* to include the quantity(ies) indicated in the *reportQuantity* within the concerned *reportConfig* in order of decreasing *triggerQuantity*, i.e. the best cell is included first;
 - 5> else:
 - 6> set the *measResult* to the quantity as configured for the concerned RAT within the *quantityConfig* in order of decreasing quantity, i.e. the best cell is included first;
 - 3> else if the *purpose* is set to 'reportCGI':
 - 4> if the mandatory present fields of the *cellGlobalId* for the cell indicated by the *cellForWhichToReportCGI* in the associated *measObject* have been obtained:
 - 5> include the *cgi-Info* containing all the fields that have been successfully acquired;

- 1> increment the *numberOfReportsSent* as defined within the *VarMeasReportList* for this *measId* by 1;
- 1> stop the periodical reporting timer, if running;
- 1> if the *numberOfReportsSent* as defined within the *VarMeasReportList* for this *measId* is less than the *reportAmount* as defined within the corresponding *reportConfig* for this *measId*:
 - 2> start the periodical reporting timer with the value of *reportInterval* as defined within the corresponding *reportConfig* for this *measId*;
- 1> else:
 - 2> if the *triggerType* is set to 'periodical':
 - 3> remove the entry within the *VarMeasReportList* for this *measId*;
 - 3> remove this *measId* from the *measIdList* within *VarMeasConfig*;
- 1> if the measured results are for CDMA2000 HRPD:
 - 2> set the *preRegistrationStatusHRPD* to the UE's CDMA2000 upper layer's HRPD *preRegistrationStatus*;
- 1> if the measured results are for CDMA2000 1xRTT:
 - 2> set the *preRegistrationStatusHRPD* to 'FALSE';
- 1> submit the *MeasurementReport* message to lower layers for transmission, upon which the procedure ends;

8.3.1.5.3 Test description

8.3.1.5.3.1 Pre-test conditions

System Simulator:

- Cell 1 and Cell 2

UE:

None.

Preamble:

- The UE is in state Generic RB Established (state 3) on Cell 1 according to [18]

8.3.1.5.3.2 Test procedure sequence

Table 8.3.1.5.3.2-1 illustrates the downlink power levels to be applied for Cell 1 and Cell 2 at various time instants of the test execution. Row marked "T0" denotes the conditions after the preamble, while rows marked "T1" and "T2" are to be applied subsequently. The exact instants on which these values shall be applied are described in the texts in this clause.

Table 8.3.1.5.3.2-1: Power levels

	Parameter	Unit	Cell 1	Cell 2 (DL only)	Remark
T0	Cell-specific RS EPRE	dBm/1 5kHz	-85	-110	Power levels are such that entry condition for event A3 (<i>measId</i> 1 & 2) is not satisfied: $Mn + Ofn + Ocn + Hys < Ms + OfS + Ocs + Off$
T1	Cell-specific RS EPRE	dBm/1 5kHz	-85	-91	Power levels are such that entry condition for event A3 (<i>measId</i> 1) is satisfied: $Mn + Ofn + Ocn - Hys > Ms + OfS + Ocs + Off$
T2	Cell-specific RS EPRE	dBm/1 5kHz	-85	-79	Power levels are such that entry condition for event A3 (<i>measId</i> 2) is satisfied: $Mn + Ofn + Ocn - Hys > Ms + OfS + Ocs + Off$

Table 8.3.1.5.3.2-2: Main behaviour

St	Procedure	Message Sequence		TP	Verdict
		U - S	Message		
1	SS transmits an <i>RRCConnectionReconfiguration</i> message including <i>MeasConfig</i> to setup intra E-UTRAN measurement and reporting for two event A3 (<i>measId 1</i> and <i>measId 2</i>) with different parameters.	<--	<i>RRCConnectionReconfiguration</i>	-	-
2	The UE transmits an <i>RCConnectionReconfigurationComplete</i> message.	-->	<i>RRCConnectionReconfigurationComplete</i>	-	-
3	Check: Does the UE transmit a <i>MeasurementReport</i> message within the next 10s?	-->	<i>MeasurementReport</i>	1	F
4	SS re-adjusts the cell-specific reference signal level according to row "T1" in table 8.3.1.5.3.2-1.	-	-	-	-
5	Check: Does the UE transmit a <i>MeasurementReport</i> message to report event A3 (<i>measId 1</i>) with the measured RSRP value for Cell 2?	-->	<i>MeasurementReport</i>	2	P
6	SS re-adjusts the cell-specific reference signal level according to row "T2" in table 8.3.1.5.3.2-1.	-	-	-	-
7	Check: Does the UE transmit a <i>MeasurementReport</i> message to report event A3 (<i>measId 2</i>) with the measured RSRP value for Cell 2?	-->	<i>MeasurementReport</i>	2	P

8.3.1.5.3.3 Specific message contents

Table 8.3.1.5.3.3-1: *RRCConnectionReconfiguration* (step 1, Table 8.3.1.5.3.2-2)

Derivation Path: 36.508 clause 4.6.1 table 4.6.1-8 with condition MEAS
--

Table 8.3.1.5.3.3-2: MeasConfig (step 1, Table 8.3.1.5.3.2-2)

Derivation path: 36.508 clause 4.6.6 table 4.6.6-1			
Information Element	Value/Remark	Comment	Condition
MeasConfig ::= SEQUENCE {			
measObjectToAddModList SEQUENCE (SIZE (1..maxObjectId)) OF SEQUENCE {	1 entry		
measObjectId[1]	IdMeasObject-f1		
measObject[1]	MeasObjectEUTRA-GENERIC(f1)		
}			
reportConfigToAddModList SEQUENCE (SIZE (1..maxReportConfigId)) OF SEQUENCE {	2 entries		
reportConfigId[1]	1		
reportConfig[1]	ReportConfig-A3-Lowerthreshold		
reportConfigId[2]	2		
reportConfig[2]	ReportConfig-A3-Higherthreshold		
}			
measIdToAddModList SEQUENCE (SIZE (1..maxMeasId)) OF SEQUENCE {	2 entries		
measId[1]	1		
measObjectId[1]	IdMeasObject-f1		
reportConfigId[1]	IdReportConfig-A3-Lowerthreshold		
measId[2]	2		
measObjectId[2]	IdMeasObject-f1		
reportConfigId[2]	IdReportConfig-A3-Higherthreshold		
}			
}			

Table 8.3.1.5.3.3-3: ReportConfig-A3-Lowerthreshold (step 1, Table 8.3.1.5.3.2-2)

Derivation path: 36.508 clause 4.6.6 table 4.6.6-6 ReportConfigEUTRA-A3			
Information Element	Value/remark	Comment	Condition
ReportConfigEUTRA-A3 ::= SEQUENCE {			
triggerType CHOICE {			
event SEQUENCE {			
eventId CHOICE {			
eventA3 SEQUENCE {			
a3-Offset	-20	-10 dB	
}			
}			
}			
timeToTrigger	ms0		
}			
reportQuantity	sameAsTriggerQuantity		
}			

Table 8.3.1.5.3.3-4: ReportConfig-A3-Higherthreshold (step 1, Table 8.3.1.5.3.2-2)

Derivation path: 36.508 clause 4.6.6 table 4.6.6-6 ReportConfigEUTRA-A3			
Information Element	Value/remark	Comment	Condition
ReportConfigEUTRA-A3 ::= SEQUENCE {			
triggerType CHOICE {			
event SEQUENCE {			
eventId CHOICE {			
eventA3 SEQUENCE {			
a3-Offset	0	0 dB	
}			
}			
timeToTrigger	ms0		
}			
reportQuantity	sameAsTriggerQuantity		
}			

Table 8.3.1.5.3.3-5: MeasurementReport (step 5, Table 8.3.1.5.3.2-2)

Derivation path: 36.508 4.6.1 table 4.6.1-5			
Information Element	Value/Remark	Comment	Condition
MeasurementReport ::= SEQUENCE {			
criticalExtensions CHOICE {			
c1 CHOICE {			
measurementReport-r8 SEQUENCE {			
MeasResults ::= SEQUENCE {			
measId	1		
measResultServCell ::= SEQUENCE {		Report Cell 1	
rsrpResult	(0..97)		
rsrqResult	(0..34)		
}			
measResultNeighCells CHOICE {			
MeasResultEUTRA ::= SEQUENCE (SIZE (1..maxCellReport)) OF SEQUENCE {		Report Cell 2	
physCellId	PhysCellId of the Cell 2.		
measResult SEQUENCE {			
rsrpResult	(0..97)		
rsrqResult	Not present		
}			
}			
}			
}			
}			
}			
}			
}			

Table 8.3.1.5.3.3-6: *MeasurementReport* (step 7, Table 8.3.1.5.3.2-2)

Derivation path: 36.508 4.6.1 table 4.6.1-5			
Information Element	Value/Remark	Comment	Condition
MeasurementReport ::= SEQUENCE {			
criticalExtensions CHOICE {			
c1 CHOICE {			
measurementReport-r8 SEQUENCE {			
MeasResults ::= SEQUENCE {			
measId	2		
measResultServCell ::= SEQUENCE {		Report Cell 1	
rsrpResult	(0..97)		
rsrqResult	(0..34)		
}			
measResultNeighCells CHOICE {			
MeasResultEUTRA ::= SEQUENCE (SIZE (1..maxCellReport)) OF SEQUENCE {		Report Cell 2	
physCellId	PhysCellId of the Cell 2.		
measResult SEQUENCE{			
rsrpResult	(0..97)		
rsrqResult	Not present		
}			
}			
}			
}			
}			
}			
}			
}			

8.3.1.6 Measurement configuration control and reporting / Intra E-UTRAN measurements / Two simultaneous events A2 and A3 (inter-frequency measurements)

8.3.1.6.1 Test Purpose (TP)

(1)

```
with { UE in E-UTRA RRC_CONNECTED state and measurements configured for event A2 and event A3 }
ensure that {
  when { Serving becomes worse than threshold }
  then { UE sends MeasurementReport for event A2 }
}
```

(2)

```
with { UE in E-UTRA RRC_CONNECTED state and measurements configured for event A2 and event A3 }
ensure that {
  when { Neighbour becomes offset better than serving }
  then { UE sends MeasurementReport for event A3 }
}
```

8.3.1.6.2 Conformance requirements

References: The conformance requirements covered in the current TC are specified in: TS 36.331, clauses 5.3.5.3, 5.5.4.1, 5.5.4.3, 5.5.4.4 and 5.5.5.

[TS 36.331, clause 5.3.5.3]

If the *RRCCONNECTIONRECONFIGURATION* message does not include the *mobilityControlInfo* and the UE is able to comply with the configuration included in this message, the UE shall:

...

1> if the *RRCCONNECTIONRECONFIGURATION* message includes the *measConfig*:

2> perform the measurement configuration procedure as specified in 5.5.2;

...

[TS 36.331, clause 5.5.4.1]

The UE shall:

- 1> for each *measId* included in the *measIdList* within *VarMeasConfig*:
 - 2> else:
 - 3> if the corresponding *measObject* concerns E-UTRA:
 - 4> if the *ue-RxTxTimeDiffPeriodical*, *eventA1* or *eventA2* is configured in the corresponding *reportConfig*:
 - 5> consider only the serving cell to be applicable;
 - 4> else:
 - 5> consider any neighbouring cell detected on the associated frequency to be applicable when the concerned cell is not included in the *blackCellsToAddModList* defined within the *VarMeasConfig* for this *measId*;

...

 - 2> if the *triggerType* is set to 'event' and if the entry condition applicable for this event, i.e. the event corresponding with the *eventId* of the corresponding *reportConfig* within *VarMeasConfig*, is fulfilled for one or more applicable cells for all measurements after layer 3 filtering taken during *timeToTrigger* defined for this event within the *VarMeasConfig*, while the *VarMeasReportList* does not include an measurement reporting entry for this *measId* (a first cell triggers the event):
 - 3> include a measurement reporting entry within the *VarMeasReportList* for this *measId*;
 - 3> set the *numberOfReportsSent* defined within the *VarMeasReportList* for this *measId* to 0;
 - 3> include the concerned cell(s) in the *cellsTriggeredList* defined within the *VarMeasReportList* for this *measId*;
 - 3> initiate the measurement reporting procedure, as specified in 5.5.5;
 - 2> if the *triggerType* is set to 'event' and if the entry condition applicable for this event, i.e. the event corresponding with the *eventId* of the corresponding *reportConfig* within *VarMeasConfig*, is fulfilled for one or more applicable cells not included in the *cellsTriggeredList* for all measurements after layer 3 filtering taken during *timeToTrigger* defined for this event within the *VarMeasConfig* (a subsequent cell triggers the event):
 - 3> set the *numberOfReportsSent* defined within the *VarMeasReportList* for this *measId* to 0;
 - 3> include the concerned cell(s) in the *cellsTriggeredList* defined within the *VarMeasReportList* for this *measId*;
 - 3> initiate the measurement reporting procedure, as specified in 5.5.5;
 - 2> if the *triggerType* is set to 'event' and if the leaving condition applicable for this event is fulfilled for one or more of the cells included in the *cellsTriggeredList* defined within the *VarMeasReportList* for this *measId* for all measurements after layer 3 filtering taken during *timeToTrigger* defined within the *VarMeasConfig* for this event:
 - 3> remove the concerned cell(s) in the *cellsTriggeredList* defined within the *VarMeasReportList* for this *measId*;
 - 3> if *reportOnLeave* is set to *TRUE* for the corresponding reporting configuration:
 - 4> initiate the measurement reporting procedure, as specified in 5.5.5;
 - 3> if the *cellsTriggeredList* defined within the *VarMeasReportList* for this *measId* is empty:

- 4> remove the measurement reporting entry within the *VarMeasReportList* for this *measId*;
- 4> stop the periodical reporting timer for this *measId*, if running;
- 2> if the *purpose* is included and set to '*reportStrongestCells*' or '*reportStrongestCellsForSON*' and if a (first) measurement result is available for one or more applicable cells:
 - 3> include a measurement reporting entry within the *VarMeasReportList* for this *measId*;
 - 3> set the *numberOfReportsSent* defined within the *VarMeasReportList* for this *measId* to 0;
 - 3> initiate the measurement reporting procedure, as specified in 5.5.5;

NOTE 1: If the *purpose* is set to '*reportStrongestCells*', the UE initiates a first measurement report immediately after the quantity to be reported becomes available for at least either serving cell or one of the applicable cells. If the *purpose* is set to '*reportStrongestCellsForSON*', the UE initiates a first measurement report when it has determined the strongest cells on the associated frequency.

- 2> upon expiry of the periodical reporting timer for this *measId*:
 - 3> initiate the measurement reporting procedure, as specified in 5.5.5;
- 2> if the *purpose* is included and set to '*reportCGI*' and if the UE acquired the information needed to set all fields of *cgi-Info* for the requested cell:
 - 3> include a measurement reporting entry within the *VarMeasReportList* for this *measId*;
 - 3> set the *numberOfReportsSent* defined within the *VarMeasReportList* for this *measId* to 0;
 - 3> stop timer T321;
 - 3> initiate the measurement reporting procedure, as specified in 5.5.5;
- 2> upon expiry of the T321 for this *measId*:
 - 3> include a measurement reporting entry within the *VarMeasReportList* for this *measId*;
 - 3> set the *numberOfReportsSent* defined within the *VarMeasReportList* for this *measId* to 0;
 - 3> initiate the measurement reporting procedure, as specified in 5.5.5;

NOTE 2: The UE does not stop the periodical reporting with *triggerType* set to '*event*' or to '*periodical*' while the corresponding measurement is not performed due to the serving cell RSRP being equal to or better than *s-Measure* or due to the measurement gap not being setup.

NOTE 3: If the UE is configured with DRX, the UE may delay the measurement reporting for event triggered and periodical triggered measurements until the Active Time, which is defined in TS 36.321 [6].

[TS 36.331, clause 5.5.4.3]

The UE shall:

- 1> consider the entering condition for this event to be satisfied when condition A2-1, as specified below, is fulfilled;
- 1> consider the leaving condition for this event to be satisfied when condition A2-2, as specified below, is fulfilled;

Inequality A2-1 (Entering condition)

$$Ms + Hys < Thresh$$

Inequality A2-2 (Leaving condition)

$$Ms - Hys > Thresh$$

The variables in the formula are defined as follows:

Ms is the measurement result of the serving cell, not taking into account any offsets.

Hys is the hysteresis parameter for this event (i.e. *hysteresis* as defined within *reportConfigEUTRA* for this event).

Thresh is the threshold parameter for this event (i.e. *a2-Threshold* as defined within *reportConfigEUTRA* for this event).

Ms is expressed in dBm in case of RSRP, or in dB in case of RSRQ.

Hys is expressed in dB.

Thresh is expressed in the same unit as **Ms**.

[TS 36.331, clause 5.5.4.4]

The UE shall:

1> consider the entering condition for this event to be satisfied when condition A3-1, as specified below, is fulfilled;

1> consider the leaving condition for this event to be satisfied when condition A3-2, as specified below, is fulfilled;

Inequality A3-1 (Entering condition)

$$Mn + Ofn + Ocn - Hys > Ms + OfS + Ocs + Off$$

Inequality A3-2 (Leaving condition)

$$Mn + Ofn + Ocn + Hys < Ms + OfS + Ocs + Off$$

The variables in the formula are defined as follows:

Mn is the measurement result of the neighbouring cell, not taking into account any offsets.

Ofn is the frequency specific offset of the frequency of the neighbour cell (i.e. *offsetFreq* as defined within *measObjectEUTRA* corresponding to the frequency of the neighbour cell).

Ocn is the cell specific offset of the neighbour cell (i.e. *cellIndividualOffset* as defined within *measObjectEUTRA* corresponding to the frequency of the neighbour cell), and set to zero if not configured for the neighbour cell.

Ms is the measurement result of the serving cell, not taking into account any offsets.

Ofs is the frequency specific offset of the serving frequency (i.e. *offsetFreq* as defined within *measObjectEUTRA* corresponding to the serving frequency).

Ocs is the cell specific offset of the serving cell (i.e. *cellIndividualOffset* as defined within *measObjectEUTRA* corresponding to the serving frequency), and is set to zero if not configured for the serving cell.

Hys is the hysteresis parameter for this event (i.e. *hysteresis* as defined within *reportConfigEUTRA* for this event).

Off is the offset parameter for this event (i.e. *a3-Offset* as defined within *reportConfigEUTRA* for this event).

Mn, Ms are expressed in dBm in case of RSRP, or in dB in case of RSRQ.

Ofn, Ocn, OfS, Ocs, Hys, Off are expressed in dB.

[TS 36.331, clause 5.5.5]

For the *measId* for which the measurement reporting procedure was triggered, the UE shall set the *measResults* within the *MeasurementReport* message as follows:

1> set the *measId* to the measurement identity that triggered the measurement reporting;

1> set the *measResultServCell* to include the quantities of serving cell;

1> if there is at least one applicable neighbouring cell to report:

2> set the *measResultNeighCells* to include the best neighbouring cells up to *maxReportCells* in accordance with the following:

3> if the *triggerType* is set to 'event':

4> include the cells included in the *cellsTriggeredList* as defined within the *VarMeasReportList* for this *measId*;

3> else:

4> include the applicable cells for which the new measurement results became available since the last periodical reporting or since the measurement was initiated or reset;

NOTE: The reliability of the report (i.e. the certainty it contains the strongest cells on the concerned frequency) depends on the measurement configuration i.e. the *reportInterval*. The related performance requirements are specified in TS 36.133 [16].

3> for each cell that is included in the *measResultNeighCells*, include the *physCellId*;

3> if the *triggerType* is set to 'event'; or the *purpose* is set to 'reportStrongestCells' or to 'reportStrongestCellsForSON':

4> for each included cell, include the layer 3 filtered measured results in accordance with the *reportConfig* for this *measId*, ordered as follows:

5> if the *measObject* associated with this *measId* concerns E-UTRA:

6> set the *measResult* to include the quantity(ies) indicated in the *reportQuantity* within the concerned *reportConfig* in order of decreasing *triggerQuantity*, i.e. the best cell is included first;

5> else:

6> set the *measResult* to the quantity as configured for the concerned RAT within the *quantityConfig* in order of either decreasing quantity for UTRA and GERAN or increasing quantity for CDMA2000 *pilotStrength*, i.e. the best cell is included first;

...

...

1> increment the *numberOfReportsSent* as defined within the *VarMeasReportList* for this *measId* by 1;

1> stop the periodical reporting timer, if running;

1> if the *numberOfReportsSent* as defined within the *VarMeasReportList* for this *measId* is less than the *reportAmount* as defined within the corresponding *reportConfig* for this *measId*:

2> start the periodical reporting timer with the value of *reportInterval* as defined within the corresponding *reportConfig* for this *measId*;

...

1> submit the *MeasurementReport* message to lower layers for transmission, upon which the procedure ends;

8.3.1.6.3 Test description

8.3.1.6.3.1 Pre-test conditions

System Simulator:

- Cell 1 and Cell 3
- System information combination 3 as defined in TS 36.508 [18] clause 4.4.3.1 is used in E-UTRA cells.

UE:

None.

Preamble:

- The UE is in state Generic RB Established (state 3) on Cell 1 according to [18].

8.3.1.6.3.2 Test procedure sequence

Table 8.3.1.6.3.2-1 illustrates the downlink power levels to be applied for Cell 1 and Cell 3 at various time instants of the test execution. Row marked "T0" denotes the conditions after the preamble, while rows marked "T1" and "T2" are to be applied subsequently. The exact instants on which these values shall be applied are described in the texts in this clause.

Table 8.3.1.6.3.2-1 : Power levels

	Parameter	Unit	Cell 1	Cell 3 (DL only)	Remark
T0	Cell-specific RS EPRE	dBm/1 5kHz	-75	-91	Power levels are such that entry condition for event A2 and event A3 is not satisfied: $M_s - H_{ys} > Thresh$ AND $M_n + O_{fn} + O_{cn} + H_{ys} < M_s + O_{fs} + O_{cs} + O_{ff}$
T1	Cell-specific RS EPRE	dBm/1 5kHz	-93	-105	Power level of Cell 1 is such that entry condition for event A2 is satisfied: $M_s + H_{ys} < Thresh$ AND Power levels of Cell 1 and Cell 3 are such that entry condition for event A3 is not satisfied: $M_n + O_{fn} + O_{cn} + H_{ys} < M_s + O_{fs} + O_{cs} + O_{ff}$
T2	Cell-specific RS EPRE	dBm/1 5kHz	-85	-73	Power levels are such that entry condition for event A3 is satisfied: $M_n + O_{fn} + O_{cn} - H_{ys} > M_s + O_{fs} + O_{cs} + O_{ff}$

Table 8.3.1.6.3.2-2: Main behaviour

St	Procedure	Message Sequence		TP	Verdict
		U - S	Message		
1	SS transmits an <i>RRCCONNECTIONRECONFIGURATION</i> message including <i>measConfig</i> to setup intra LTE measurement and reporting for event A2 and event A3 (inter frequency measurement)	<--	<i>RRCCONNECTIONRECONFIGURATION</i>	-	-
2	The UE transmits an <i>RRCCONNECTIONRECONFIGURATIONCOMPLETE</i> message.	-->	<i>RRCCONNECTIONRECONFIGURATIONCOMPLETE</i>	-	-
3	Check: Does the UE transmit a <i>MEASUREMENTREPORT</i> message within the next 10s?	-->	<i>MEASUREMENTREPORT</i>	1	F
4	SS re-adjusts the cell-specific reference signal level according to row "T1" in table 8.3.1.6.3.2-1.	-	-	-	-
5	Check: Does the UE transmit a <i>MEASUREMENTREPORT</i> message to report event A2 with the measured RSRP value for Cell 1?	-->	<i>MEASUREMENTREPORT</i>	1	P
6	SS re-adjusts the cell-specific reference signal level according to row "T2" in table 8.3.1.6.3.2-1.	-	-	-	-
7	Check: Does the UE transmit a <i>MEASUREMENTREPORT</i> message to report event A3 with the measured RSRP value for Cell 3?	-->	<i>MEASUREMENTREPORT</i>	2	P

8.3.1.6.3.3 Specific message contents

Table 8.3.1.6.3.3-1: *RRCCONNECTIONRECONFIGURATION* (step 1, Table 8.3.1.6.3.2-2)

Derivation Path: 36.508 clause 4.6.1 table 4.6.1-8 with condition MEAS
--

Table 8.3.1.6.3.3-2: *MeasConfig* (step 1, Table 8.3.1.6.3.2-2)

Derivation path: 36.508 clause 4.6.6 table 4.6.6-1, condition INTER-FREQ			
Information Element	Value/Remark	Comment	Condition
MeasConfig ::= SEQUENCE {			
measObjectToAddModList SEQUENCE (SIZE (1..maxObjectId)) OF SEQUENCE {	2 entries		
measObjectId[1]	IdMeasObject-f1		
measObject[1]	MeasObjectEUTRA-GENERIC(f1)		
measObjectId[2]	IdMeasObject-f2		
measObject[2]	MeasObjectEUTRA-GENERIC(f2)		
}			
reportConfigToAddModList SEQUENCE (SIZE (1..maxReportConfigId)) OF SEQUENCE {	2 entries		
reportConfigId[1]	IdReportConfig-A2		
reportConfig[1]	ReportConfig-A2		
reportConfigId[2]	IdReportConfig-A3		
reportConfig[2]	ReportConfig-A3		
}			
measIdToAddModList SEQUENCE (SIZE (1..maxMeasId)) OF SEQUENCE {	2 entries		
measId[1]	1		
measObjectId[1]	IdMeasObject-f1		
reportConfigId[1]	IdReportConfig-A2		
measId[2]	2		
measObjectId[2]	IdMeasObject-f2		
reportConfigId[2]	IdReportConfig-A3		
}			
}			

Table 8.3.1.6.3.3-3: *ReportConfig-A2* (step 1, Table 8.3.1.6.3.2-2)

Derivation path: 36.508 clause 4.6.6 table 4.6.6-5 ReportConfigEUTRA-A2(-83)			
Information Element	Value/Remark	Comment	Condition
ReportConfigEUTRA ::= SEQUENCE {			
triggerType CHOICE {			
event SEQUENCE {			
hysteresis	6	3 dB	
}			
}			
}			

Table 8.3.1.6.3.3-4: *ReportConfig-A3* (step 1, Table 8.3.1.6.3.2-2)

Derivation path: 36.508 clause 4.6.6 table 4.6.6-6 ReportConfigEUTRA-A3			
Information Element	Value/remark	Comment	Condition
ReportConfigEUTRA-A3 ::= SEQUENCE {			
triggerType CHOICE {			
event SEQUENCE {			
eventId CHOICE {			
eventA3 SEQUENCE {			
a3-Offset	0	0 dB	
}			
}			
}			
}			
reportQuantity	sameAsTriggerQuantity		
}			

Table 8.3.1.6.3.3-5: MeasurementReport (step 5, Table 8.3.1.6.3.2-2)

Derivation path: 36.508 4.6.1 table 4.6.1-5			
Information Element	Value/Remark	Comment	Condition
MeasurementReport ::= SEQUENCE {			
criticalExtensions CHOICE {			
c1 CHOICE {			
measurementReport-r8 SEQUENCE {			
measResults ::= SEQUENCE {			
measId	1		
measResultServCell ::= SEQUENCE {		Report Cell 1	
rsrpResult	(0..97)		
rsrqResult	(0..34)		
}			
}			
}			
}			
}			
}			

Table 8.3.1.6.3.3-6: MeasurementReport (step 7, Table 8.3.1.6.3.2-2)

Derivation path: 36.508 4.6.1 table 4.6.1-5			
Information Element	Value/Remark	Comment	Condition
MeasurementReport ::= SEQUENCE {			
criticalExtensions CHOICE {			
c1 CHOICE {			
measurementReport-r8 SEQUENCE {			
measResults ::= SEQUENCE {			
measId	2		
measResultServCell ::= SEQUENCE {		Report Cell 1	
rsrpResult	(0..97)		
rsrqResult	(0..34)		
}			
measResultNeighCells CHOICE {			
measResultEUTRA ::= SEQUENCE (SIZE			
(1..maxCellReport)) OF SEQUENCE {		Report Cell 3	
physCellId	PhysCellId of the Cell 3.		
measResult SEQUENCE{			
rsrpResult	(0..97)		
rsrqResult	Not present		
}			
}			
}			
}			
}			
}			
}			

8.3.1.7 Measurement configuration control and reporting / Intra E-UTRAN measurements / Blacklisting

8.3.1.7.1 Test Purpose (TP)

(1)

```

with { UE in E-UTRA RRC_CONNECTED state and measurement configured for event A3 reporting }
ensure that {
  when { Blacklisted neighbour cell satisfies entry condition for event A3 }
  then { It is not considered in event evaluation and UE does not send MeasurementReport message }
}
    
```

(2)

```

with { UE in E-UTRA RRC_CONNECTED state and measurement reporting triggered by event A3 is ongoing}
ensure that {
  when { Blacklisted neighbour cell satisfies entry condition for event A3 }
  then { It is not considered in measurement reporting }
}

```

8.3.1.7.2 Conformance requirements

References: The conformance requirements covered in the current TC are specified in: TS 36.331, clauses 5.5.1, 5.5.4.1, and 5.5.5.

[TS 36.331, clause 5.5.1]

The UE reports measurement information in accordance with the measurement configuration as provided by E-UTRAN. E-UTRAN provides the measurement configuration applicable for a UE in RRC_CONNECTED state by means of dedicated signalling, i.e. using the *RRCConnectionReconfiguration* message.

...

- For intra-frequency and inter-frequency measurements a measurement object is a single E-UTRA carrier frequency. Associated with this carrier frequency, E-UTRAN can configure a list of cell specific offsets and a list of 'blacklisted' cells. Blacklisted cells are not considered in event evaluation or measurement reporting.

...

[TS 36.331, clause 5.5.4.1]

The UE shall:

1> for each *measId* included in the *measIdList* within *VarMeasConfig*:

...

2> else:

3> if the corresponding *measObject* concerns EUTRA:

4> consider any neighbouring cell detected on the associated frequency to be applicable when the concerned cell is not included in the *blackCellsToAddModList* defined within the *VarMeasConfig* for this *measId*;

...

2> if the *triggerType* is set to 'event' and if the entry condition applicable for this event, i.e. the event corresponding with the *eventId* of the corresponding *reportConfig* within *VarMeasConfig*, is fulfilled for one or more applicable cells for all measurements after layer 3 filtering taken during *timeToTrigger* defined for this event within the *VarMeasConfig* while the *VarMeasReportList* does not include a measurement reporting entry for this *measId* (a first cell triggers the event):

3> include a measurement reporting entry within the *VarMeasReportList* for this *measId*;

3> set the *numberOfReportsSent* defined within the *VarMeasReportList* for this *measId* to 0;

3> include the concerned cell(s) in the *cellsTriggeredList* defined within the *VarMeasReportList* for this *measId*;

3> initiate the measurement reporting procedure, as specified in 5.5.5;

2> if the *triggerType* is set to 'event' and if the entry condition applicable for this event, i.e. the event corresponding with the *eventId* of the corresponding *reportConfig* within *VarMeasConfig*, is fulfilled for one or more applicable cells not included in the *cellsTriggeredList* for all measurements after layer 3 filtering

taken during *timeToTrigger* defined for this event within the *VarMeasConfig* (a subsequent cell triggers the event):

3> set the *numberOfReportsSent* defined within the *VarMeasReportList* for this *measId* to 0;

3> include the concerned cell(s) in the *cellsTriggeredList* defined within the *VarMeasReportList* for this *measId*;

3> initiate the measurement reporting procedure, as specified in 5.5.5;

2> if the *triggerType* is set to 'event' and if the leaving condition applicable for this event is fulfilled for one or more of the cells included in the *cellsTriggeredList* defined within the *VarMeasReportList* for this *measId* for all measurements after layer 3 filtering taken during *timeToTrigger* defined within the *VarMeasConfig* for this event:

3> remove the concerned cell(s) in the *cellsTriggeredList* defined within the *VarMeasReportList* for this *measId*;

3> if *reportOnLeave* is set to *TRUE* for the corresponding reporting configuration:

4> initiate the measurement reporting procedure, as specified in 5.5.5;

3> if the *cellsTriggeredList* defined within the *VarMeasReportList* for this *measId* is empty:

4> remove the measurement reporting entry within the *VarMeasReportList* for this *measId*;

4> stop the periodical reporting timer for this *measId*, if running;

...

[TS 36.331, clause 5.5.5]

...

For the *measId* for which the measurement reporting procedure was triggered, the UE shall set the *measResults* within the *MeasurementReport* message as follows:

1> set the IE *measId* to the measurement identity that triggered the measurement reporting;

1> set the *measResultServCell* to include the quantities of serving cell;

1> if there is at least one applicable neighbouring cell to report:

2> set the *measResultsNeighCells* to include the best neighbouring cells up to *maxReportCells* in accordance with the following:

3> if the *triggerType* is set to 'event':

4> include the cells included in the *cellsTriggeredList* as defined within the *VarMeasReportList* for this *measId*;

...

3> for each cell that is included in the *measResultsNeighCells*, include the *physCellId*;

3> if the *triggerType* is set to 'event'; or the *purpose* is set to 'reportStrongestCells' or to 'reportStrongestCellsForSON':

4> for each included cell include the layer 3 filtered measured results in accordance with the *reportConfigList* for this *measId*, ordered as follows:

5> if the *measObject* associated with this *measId* concerns E-UTRA:

6> set the *measResult* to include the quantity(ies) indicated in the *reportQuantity* within the concerned *reportConfig* in order of decreasing *triggerQuantity*, i.e. the best cell is included first;

...

1> increment the *numberOfReportsSent* as defined within the *VarMeasReportList* for this *measId* by 1;

1> stop the periodical reporting timer, if running;

...

1> submit the *MeasurementReport* message to lower layers for transmission, upon which the procedure ends.

8.3.1.7.3 Test description

8.3.1.7.3.1 Pre-test conditions

System Simulator:

- Cell 1, Cell 2 and Cell 4:
 - Cell 1 is the serving cell
 - Cell 2 and Cell 4 are intra-frequency neighbour cells

UE:

None.

Preamble:

- The UE is in state Generic RB Established (state 3) according to [18].

8.3.1.7.3.2 Test procedure sequence

Table 8.3.1.7.3.2-1 illustrates the downlink power levels to be applied for Cell 1, Cell 2 and Cell 4 at various time instants of the test execution. Row marked "T0" denotes the conditions after the preamble, while rows marked "T1" and "T2" are to be applied subsequently. The exact instants on which these values shall be applied are described in the texts in this clause.

Table 8.3.1.7.3.2-1 : Power level

	Parameter	Unit	Cell 1	Cell 2 (DL only)	Cell 4 (DL only)	Remark
T0			-85	-97	-97	Power levels are such that that exit condition for event A3 is satisfied for all cells ($M2 + Hys < M1 + Off$ and $M4 + Hys < M1 + Off$) with all offset parameters set to 0 dB.
T1	Cell-specific RS EPRE	dBm/ 15kHz z	-85	-79	-97	Power level of Cell 2 is set such that measurement results for Cell 1 ($M1$) and Cell 2 ($M2$) satisfy entry condition for event A3 ($M2 - Hys > M1 + Off$).
T2			-85	-79	-79	Power level of Cell 4 is set such that measurement results for Cell 1 ($M1$) and Cell 4 ($M4$) satisfy entry condition for event A3 ($M4 - Hys > M1 + Off$).

Table 8.3.1.7.3.2-2 : Main behaviour

St	Procedure	Message Sequence		TP	Verdict
		U - S	Message		
1	SS transmits an <i>RRCCONNECTIONRECONFIGURATION</i> message including <i>measConfig</i> to setup intraLTE measurement and reporting for event A3.	<--	<i>RRCCONNECTIONRECONFIGURATION</i>	-	-
2	The UE transmits an <i>RRCCONNECTIONRECONFIGURATIONCOMPLETE</i> message.	-->	<i>RRCCONNECTIONRECONFIGURATIONCOMPLETE</i>	-	-
3	SS re-adjusts the cell-specific reference signal levels according to row "T1" in table 8.3.1.7.3.2.-1.	-	-	-	-
4	Check: does the UE transmit a <i>MEASUREMENTREPORT</i> messages within the next 10s?	-	<i>MEASUREMENTREPORT</i>	1	F
5	SS re-adjusts the cell-specific reference signal levels according to row "T2" in table 8.3.1.7.3.2.-1.	-	-	-	-
6	Check: does the UE transmit a <i>MEASUREMENTREPORT</i> message to report event A3 with the measured RSRP values for Cell 1 and Cell 4 without Cell 2 results?	-->	<i>MEASUREMENTREPORT</i>	2	P
7	SS transmits an <i>RRCCONNECTIONRECONFIGURATION</i> message including <i>measConfig</i> to remove Cell 2 from the blacklisted cell list.	<--	<i>RRCCONNECTIONRECONFIGURATION</i>	-	-
8	The UE transmits an <i>RRCCONNECTIONRECONFIGURATIONCOMPLETE</i> message	-->	<i>RRCCONNECTIONRECONFIGURATIONCOMPLETE</i>	-	-
-	EXCEPTION: Steps 8Aa1 to 8Ab1 describe a transaction that depends on the UE behaviour; the "lower case letter" identifies a step sequence that takes place if a specific behaviour happens.	-	-	-	-
8A a1	IF the UE detects event A3 for Cell 4 before event A3 for Cell 2 THEN the UE may transmit <i>MEASUREMENTREPORT</i> message to report event A3 with the measured RSRP values for Cell 1 and Cell 4.	-->	<i>MEASUREMENTREPORT</i>	-	-
8A b1	IF the UE detects event A3 for Cell 2 before event A3 for Cell 4 THEN the UE may transmit <i>MEASUREMENTREPORT</i> message to report event A3 with the measured RSRP values for Cell 1 and Cell 2.	-->	<i>MEASUREMENTREPORT</i>	-	-
9	Check: does the UE transmit a <i>MEASUREMENTREPORT</i> message to report event A3 with the measured RSRP values for Cell 1, Cell 2 and Cell 4?	-->	<i>MEASUREMENTREPORT</i>	1, 2	P

8.3.1.7.3.3 Specific message contents

Table 8.3.1.7.3.3-1: *RRCCONNECTIONRECONFIGURATION* (step 1, Table 8.3.1.7.3.2-2)

Derivation Path: 36.508 clause 4.6.1 table 4.6.1-8 with condition MEAS
--

Table 8.3.1.7.3.3-2: MeasConfig (Table 8.3.1.7.3.3-1)

Derivation path: 36.508 clause 4.6.6 table 4.6.6-1			
Information Element	Value/remark	Comment	Condition
measConfig ::= SEQUENCE {			
measObjectToAddModList SEQUENCE (SIZE (1..maxObjectId)) OF SEQUENCE {	1 entry		
measObjectId[1]	IdMeasObject-f1		
measObject[1]	MeasObjectEUTRA-GENERIC(f1)		
}			
reportConfigToAddModList SEQUENCE (SIZE (1..maxReportConfigId)) OF SEQUENCE {	1 entry		
reportConfigId[1]	IdReportConfig-A3		
reportConfig[1]	ReportConfig-A3		
}			
measIdToAddModList SEQUENCE (SIZE (1..maxMeasId)) OF SEQUENCE {	1 entry		
measId[1]	1		
measObjectId[1]	IdMeasObject-f1		
reportConfigId[1]	IdReportConfig-A3		
}			
}			

Table 8.3.1.7.3.3-3: MeasObjectEUTRA-GENERIC (Table 8.3.1.7.3.3-2)

Derivation path: 36.508 clause 4.6.6 table 4.6.6-3 MeasObjectEUTRA-GENERIC(f1)			
Information Element	Value/remark	Comment	Condition
MeasObjectEUTRA-GENERIC(f1) ::= SEQUENCE {			
blackCellsToAddModList ::= SEQUENCE (SIZE (1..maxCellMeas)) OF SEQUENCE {	1 entry	Add Cell 2	
cellIndex[1]	1		
physCellIdRange[1]	physicalCellIdentity-Cell2		
}			
}			

Table 8.3.1.7.3.3-4: ReportConfig-A3 (Table 8.3.1.7.3.3-2)

Derivation path: 36.508 clause 4.6.6 table 4.6.6-6 ReportConfigEUTRA-A3			
Information Element	Value/remark	Comment	Condition
ReportConfigEUTRA-A3 ::= SEQUENCE {			
maxReportCells	3	Report Cell 1, Cell 2 and Cell 4	
reportInterval	Not present		
}			

Table 8.3.1.7.3.3-5: RRCConnectionReconfiguration (step 7, Table 8.3.1.7.3.2-2)

Derivation Path: 36.508 clause 4.6.1 table 4.6.1-8 with condition MEAS
--

Table 8.3.1.7.3.3-6: MeasConfig (Table 8.3.1.7.3.3-5)

Derivation Path: 36.508 clause 4.6.6 table 4.6.6-1			
Information Element	Value/remark	Comment	Condition
measConfig ::= SEQUENCE {			
measObjectToAddModList SEQUENCE (SIZE (1..maxObjectId)) OF SEQUENCE {	1 entry		
measObjectId[1]	IdMeasObject-f1		
measObject[1]	MeasObjectEUTRA-GENERIC(f1)		
}			
}			

Table 8.3.1.7.3.3-7: MeasObjectEUTRA-GENERIC (Table 8.3.1.7.3.3-6)

Derivation path: 36.508 clause 4.6.6 table 4.6.6-3 MeasObjectEUTRA-GENERIC(f1)			
Information Element	Value/remark	Comment	Condition
MeasObjectEUTRA-GENERIC(f1) ::= SEQUENCE {			
blackCellsToRemoveList ::= SEQUENCE (SIZE (1..maxCellMeas)) OF SEQUENCE {	1 entry	Remove Cell 2	
CellIndex[1]	1		
}			
}			

Table 8.3.1.7.3.3-8: MeasurementReport (step 6, Table 8.3.1.7.3.2-2)

Derivation Path: 36.508 clause 4.6.1 table 4.6.1-5			
Information Element	Value/remark	Comment	Condition
MeasurementReport ::= SEQUENCE {			
criticalExtensions CHOICE {			
c1 CHOICE {			
measurementReport-r8 SEQUENCE {			
measResults ::= SEQUENCE {			
measId	1		
measResultServCell ::= SEQUENCE {		Report Cell 1	
rsrpResult	(0..97)		
rsrqResult	(0..34)		
}			
measResultNeighCells CHOICE {			
measResultListEUTRA ::= SEQUENCE (SIZE (1..maxCellReport)) OF SEQUENCE {		Report Cell 4	
physCellId [1]	physicalCellIdentity-Cell4		
measResult [1] SEQUENCE {			
rsrpResult	(0..97)		
rsrqResult	(0..34)		
}			
}			
}			
}			
}			
}			
}			

Table 8.3.1.7.3.3-9: MeasurementReport (step 9, Table 8.3.1.7.3.2-2)

Derivation Path: 36.508 clause 4.6.1 table 4.6.1-5			
Information Element	Value/remark	Comment	Condition
MeasurementReport ::= SEQUENCE {			
criticalExtensions CHOICE {			
c1 CHOICE {			
measurementReport-r8 SEQUENCE {			
measResults ::= SEQUENCE {			
measId	1		
measResultServCell ::= SEQUENCE {		Report Cell 1	
rsrpResult	(0..97)		
rsrqResult	(0..34)		
}			
measResultNeighCells CHOICE {			
measResultListEUTRA ::= SEQUENCE (SIZE (1..maxCellReport)) OF SEQUENCE {		Report Cell 2 and Cell 4	
physCellId [1]	physicalCellIdentity-Cell2		
measResult [1] SEQUENCE {			
rsrpResult	(0..97)		
rsrqResult	(0..34)		
}			
physCellId [2]	physicalCellIdentity-Cell4		
measResult [2] SEQUENCE {			
rsrpResult	(0..97)		
rsrqResult	(0..34)		
}			
}			
}			
}			
}			
}			
Note: IE "measresult" for cells 2 and 4 can appear in any order (i.e. cell 2 then cell 4 or cell 4 then cell 2)			

Table 8.3.1.7.3.3-10: MeasurementReport (step 8Aa1, Table 8.3.1.7.3.2-2)

Derivation Path: 36.508 clause 4.6.1 table 4.6.1-5			
Information Element	Value/remark	Comment	Condition
MeasurementReport ::= SEQUENCE {			
criticalExtensions CHOICE {			
c1 CHOICE {			
measurementReport-r8 SEQUENCE {			
measResults ::= SEQUENCE {			
measId	1		
measResultServCell ::= SEQUENCE {		Report Cell 1	
rsrpResult	(0..97)		
rsrqResult	(0..34)		
}			
measResultNeighCells CHOICE {			
measResultListEUTRA ::= SEQUENCE (SIZE (1..maxCellReport)) OF SEQUENCE {		Report Cell 4	
physCellId[2]	physicalCellIdentity-Cell4		
measResult [2] SEQUENCE {			
rsrpResult	(0..97)		
rsrqResult	(0..34)		
}			
}			
}			
}			
}			
}			

Table 8.3.1.7.3.3-11: MeasurementReport (step 8Ab1, Table 8.3.1.7.3.2-2)

Derivation Path: 36.508 clause 4.6.1 table 4.6.1-5			
Information Element	Value/remark	Comment	Condition
MeasurementReport ::= SEQUENCE {			
criticalExtensions CHOICE {			
c1 CHOICE {			
measurementReport-r8 SEQUENCE {			
measResults ::= SEQUENCE {			
measId	1		
measResultServCell ::= SEQUENCE {		Report Cell 1	
rsrpResult	(0..97)		
rsrqResult	(0..34)		
}			
measResultNeighCells CHOICE {			
measResultListEUTRA ::= SEQUENCE (SIZE (1..maxCellReport)) OF SEQUENCE {		Report Cell 2	
physCellId[2]	physicalCellIdentity-Cell2		
measResult [2] SEQUENCE {			
rsrpResult	(0..97)		
rsrqResult	(0..34)		
}			
}			
}			
}			
}			
}			

8.3.1.8 Measurement configuration control and reporting / Intra E-UTRAN measurements / Handover / IE measurement configuration present

8.3.1.8.1 Test Purpose (TP)

(1)

```
with { UE having completed the radio bearer establishment, initial security activation procedure and
performed the intra frequency measurement }
ensure that {
  when { UE receives an RRCConnectionReconfiguration message including a mobilityControlInfo and a
measConfig for removing intra frequency measurement }
    then { UE performs intra frequency handover and stops the intra frequency measurement }
}
```

8.3.1.8.2 Conformance requirements

References: The conformance requirements covered in the present TC are specified in: TS 36.331, clause 5.3.5.4, 5.5.2.2, 5.5.2.6 and 5.5.4.4.

[TS 36.331, clause 5.3.5.4]

If the *RRCConnectionReconfiguration* message includes the *mobilityControlInfo* and the UE is able to comply with the configuration included in this message, the UE shall:

- 1> stop timer T310, if running;
- 1> start timer T304 with the timer value set to *t304*, as included in the *mobilityControlInfo*;
- 1> if the *carrierFreq* is included:
 - 2> consider the target cell to be one on the frequency indicated by the *carrierFreq* with a physical cell identity indicated by the *targetPhysCellId*;
- 1> else:
 - 2> consider the target cell to be one on the current frequency with a physical cell identity indicated by the *targetPhysCellId*;
- 1> start synchronising to the DL of the target cell;

NOTE 1: The UE should perform the handover as soon as possible following the reception of the RRC message triggering the handover, which could be before confirming successful reception (HARQ and ARQ) of this message.

- 1> reset MAC;
- 1> re-establish PDCP for all RBs that are established;

NOTE 2: The handling of the radio bearers after the successful completion of the PDCP re-establishment, e.g. the re-transmission of unacknowledged PDCP SDUs (as well as the associated status reporting), the handling of the SN and the HFN, is specified in TS 36.323 [8].

- 1> re-establish RLC for all RBs that are established;
- 1> apply the value of the *newUE-Identity* as the C-RNTI;
- 1> configure lower layers in accordance with the received *radioResourceConfigCommon*;
- 1> configure lower layers in accordance with any additional fields, not covered in the previous, if included in the received *mobilityControlInfo*;
- 1> if the *RRCConnectionReconfiguration* message includes the *radioResourceConfigDedicated*:
 - 2> perform the radio resource configuration procedure as specified in 5.3.10;
- 1> if the *keyChangeIndicator* received in the *securityConfigHO* is set to *TRUE*:

- 2> update the K_{eNB} key based on the fresh K_{ASME} key taken into use with the previous successful NAS SMC procedure, as specified in TS 33.401 [32];
 - 1> else:
 - 2> update the K_{eNB} key based on the current K_{eNB} or the NH, using the *nextHopChainingCount* value indicated in the *securityConfigHO*, as specified in TS 33.401 [32];
 - 1> store the *nextHopChainingCount* value;
 - 1> if the *securityAlgorithmConfig* is included in the *securityConfigHO*:
 - 2> derive the K_{RRcint} key associated with the *integrityProtAlgorithm*, as specified in TS 33.401 [32];
 - 2> derive the K_{RRcenc} key and the K_{UPenc} key associated with the *cipheringAlgorithm*, as specified in TS 33.401 [32];
 - 1> else:
 - 2> derive the K_{RRcint} key associated with the current integrity algorithm, as specified in TS 33.401 [32];
 - 2> derive the K_{RRcenc} key and the K_{UPenc} key associated with the current ciphering algorithm, as specified in TS 33.401 [32];
 - 1> configure lower layers to apply the integrity protection algorithm and the K_{RRcint} key, i.e. the integrity protection configuration shall be applied to all subsequent messages received and sent by the UE, including the message used to indicate the successful completion of the procedure;
 - 1> configure lower layers to apply the ciphering algorithm, the K_{RRcenc} key and the K_{UPenc} key, i.e. the ciphering configuration shall be applied to all subsequent messages received and sent by the UE, including the message used to indicate the successful completion of the procedure;
 - 1> perform the measurement related actions as specified in 5.5.6.1;
 - 1> if the *RRCCConnectionReconfiguration* message includes the *measConfig*:
 - 2> perform the measurement configuration procedure as specified in 5.5.2;
 - 1> submit the *RRCCConnectionReconfigurationComplete* message to lower layers for transmission;
 - 1> if MAC successfully completes the random access procedure:
 - 2> stop timer T304;
 - 2> apply the parts of the CQI reporting configuration, the scheduling request configuration and the sounding RS configuration that do not require the UE to know the SFN of the target cell, if any;
 - 2> apply the parts of the measurement and the radio resource configuration that require the UE to know the SFN of the target cell (e.g. measurement gaps, periodic CQI reporting, scheduling request configuration, sounding RS configuration), if any, upon acquiring the SFN of the target cell;
- NOTE 3: Whenever the UE shall setup or reconfigure a configuration in accordance with a field that is received it applies the new configuration, except for the cases addressed by the above statements.
- 2> the procedure ends;

...

[TS 36.331, clause 5.5.2.2]

The UE shall:

- 1> for each *measId* included in the received *measIdToRemoveList* that is part of the current UE configuration in *varMeasConfig*:
 - 2> remove the entry with the matching *measId* from the *measIdList* within the *VarMeasConfig*;
 - 2> remove the measurement reporting entry for this *measId* from the *VarMeasReportList*, if included;

...

[TS 36.331, clause 5.5.2.6]

The UE shall:

- 1> for each *reportConfigId* included in the received *reportConfigToRemoveList* that is part of the current UE configuration in *varMeasConfig*:
 - 2> remove the entry with the matching *reportConfigId* from the *reportConfigList* within the *VarMeasConfig*;
 - 2> remove all *measId* associated with the *reportConfigId* from the *measIdList* within the *VarMeasConfig*, if any;
 - 2> if a *measId* is removed from the *measIdList*:
 - 3> remove the measurement reporting entry for this *measId* from the *VarMeasReportList*, if included;
 - 3> stop the periodical reporting timer or timer T321, whichever one is running, and reset the associated information (e.g. *timeToTrigger*) for this *measId*;

NOTE: The UE does not consider the message as erroneous if the *reportConfigToRemoveList* includes any *reportConfigId* value that is not part of the current UE configuration.

[TS 36.331, clause 5.5.4.4]

The UE shall:

- 1> consider the entering condition for this event to be satisfied when condition A3-1, as specified below, is fulfilled;
- 1> consider the leaving condition for this event to be satisfied when condition A3-2, as specified below, is fulfilled;

Inequality A3-1 (Entering condition)

$$Mn + Ofn + Ocn - Hys > Ms + Of_s + Ocs + Off$$

Inequality A3-2 (Leaving condition)

$$Mn + Ofn + Ocn + Hys < Ms + Of_s + Ocs + Off$$

The variables in the formula are defined as follows:

Mn is the measurement result of the neighbouring cell, not taking into account any offsets.

Ofn is the frequency specific offset of the frequency of the neighbour cell (i.e. *offsetFreq* as defined within *measObjectEUTRA* corresponding to the frequency of the neighbour cell).

Ocn is the cell specific offset of the neighbour cell (i.e. *cellIndividualOffset* as defined within *measObjectEUTRA* corresponding to the frequency of the neighbour cell), and set to zero if not configured for the neighbour cell.

Ms is the measurement result of the serving cell, not taking into account any offsets.

Ofs is the frequency specific offset of the serving frequency (i.e. *offsetFreq* as defined within *measObjectEUTRA* corresponding to the serving frequency).

Ocs is the cell specific offset of the serving cell (i.e. *cellIndividualOffset* as defined within *measObjectEUTRA* corresponding to the serving frequency), and is set to zero if not configured for the serving cell.

Hys is the hysteresis parameter for this event (i.e. *hysteresis* as defined within *reportConfigEUTRA* for this event).

Off is the offset parameter for this event (i.e. *a3-Offset* as defined within *reportConfigEUTRA* for this event).

Mn*, *Ms are expressed in dBm in case of RSRP, or in dB in case of RSRQ.

Ofn*, *Ocn*, *Ofs*, *Ocs*, *Hys*, *Off are expressed in dB.

8.3.1.8.3 Test description

8.3.1.8.3.1 Pre-test conditions

System Simulator:

- Cell 1 and Cell 2.

UE:

None.

Preamble:

- The UE is in state Generic RB Established (state 3) on Cell 1 according to [18].

8.3.1.8.3.2 Test procedure sequence

Table 8.3.1.8.3.2-1 illustrates the downlink power levels and other changing parameters to be applied for the cells at various time instants of the test execution. Row marked "T0" denotes the initial conditions after preamble, while columns marked "T1" is to be applied subsequently. The exact instants on which these values shall be applied are described in the texts in this clause.

Table 8.3.1.8.3.2-1: Time instances of cell power level and parameter changes

	Parameter	Unit	Cell 1	Cell 2	Remark
T0	Cell-specific RS EPRE	dBm/15k Hz	-85	-91	The power level values are such that measurement results for Cell 1 (M1) and Cell 2 (M2) satisfy exit condition for event A3 ($M2 < M1$).
T1	Cell-specific RS EPRE	dBm/15k Hz	-85	-79	The power level values are such that measurement results for Cell 1 (M1) and Cell 2 (M2) satisfy entry condition for event A3 ($M2 > M1$).

Table 8.3.1.8.3.2-2: Main behaviour

St	Procedure	Message Sequence		TP	Verdict
		U - S	Message		
1	The SS transmits an <i>RRConnectionReconfiguration</i> message on Cell 1 to setup intra frequency measurement.	<--	<i>RRConnectionReconfiguration</i>	-	-
2	The UE transmits an <i>RRConnectionReconfigurationComplete</i> message on Cell 1 to confirm the setup of intra frequency measurement.	-->	<i>RRConnectionReconfigurationComplete</i>	-	-
3	The SS changes Cell 1 and Cell 2 parameters according to the row "T1" in table 8.3.1.8.3.2-1.	-	-	-	-
4	The UE transmits a <i>MeasurementReport</i> message on Cell 1 to report event A3.	-->	<i>MeasurementReport</i>	-	-
5	The SS transmits an <i>RRConnectionReconfiguration</i> message with a <i>measConfig</i> on Cell 1 for removing event A3 reporting, to order the UE to perform intra frequency handover to Cell 2.	<--	<i>RRConnectionReconfiguration</i>	-	-
6	Check: Does the UE transmit an <i>RRConnectionReconfigurationComplete</i> message on Cell 2?	-->	<i>RRConnectionReconfigurationComplete</i>	1	P
7	The SS changes Cell 1 and Cell 2 parameters according to the row "T0" in table 8.3.1.8.3.2-1.	-	-	-	-
8	Check: Does the UE transmit a <i>MeasurementReport</i> message on Cell 2 to perform event A3 reporting during the next 30s?	-->	<i>MeasurementReport</i>	1	F
9	Check: Does the test result of generic test procedure in TS 36.508 subclause 6.4.2.3 indicate that the UE is in E-UTRA RRC_CONNECTED state on Cell 2?	-	-	1	-

8.3.1.8.3.3 Specific message contents

Table 8.3.1.8.3.3-1: *RRConnectionReconfiguration* (step 1, Table 8.3.1.8.3.2-2)

Derivation Path: 36.508, Table 4.6.1-8, condition MEAS

Table 8.3.1.8.3.3-2: *MeasConfig* (Table 8.3.1.8.3.3-1)

Derivation Path: 36.508, Table 4.6.6-1			
Information Element	Value/remark	Comment	Condition
<i>MeasConfig</i> ::= SEQUENCE {			
<i>measObjectToAddModList</i> SEQUENCE (SIZE (1..maxObjectId)) OF SEQUENCE {	1 entry		
<i>measObjectId</i> [1]	IdMeasObject-f1		
<i>measObject</i> [1]	MeasObjectEUTRA-GENERIC(f1)		
}			
<i>reportConfigToAddModList</i> SEQUENCE (SIZE (1..maxReportConfigId)) OF SEQUENCE {	1 entry		
<i>reportConfigId</i> [1]	IdReportConfig-A3		
<i>reportConfig</i> [1]	ReportConfigEUTRA-A3		
}			
<i>measIdToAddModList</i> SEQUENCE (SIZE (1..maxMeasId)) OF SEQUENCE {	1 entry		
<i>measId</i> [1]	1		
<i>measObjectId</i> [1]	IdMeasObject-f1		
<i>reportConfigId</i> [1]	IdReportConfig-A3		
}			
}			

Table 8.3.1.8.3.3-3: MeasurementReport (step 4, Table 8.3.1.8.3.2-2)

Derivation Path: 36.508, Table 4.6.1-5			
Information Element	Value/remark	Comment	Condition
MeasurementReport ::= SEQUENCE {			
criticalExtensions CHOICE {			
c1 CHOICE{			
measurementReport-r8 SEQUENCE {			
measResults SEQUENCE {			
measId	1		
measResultServCell SEQUENCE {			
rsrpResult	(0..97)		
rsrqResult	(0..34)		
}			
measResultNeighCells CHOICE {			
measResultListEUTRA SEQUENCE (SIZE (1..maxCellReport)) OF SEQUENCE {	1 entry		
physCellId[1]	PhysicalCellIdentity of Cell 2		
cgi-Info[1]	Not present		
measResult SEQUENCE {			
rsrpResult	(0..97)		
rsrqResult	(0..34)		
}			
}			
}			
}			
}			
}			
}			

Table 8.3.1.8.3.3-4: RRCConnectionReconfiguration (step 5, Table 8.3.1.8.3.2-2)

Derivation Path: 36.508, Table 4.6.1-8, condition HO and MEAS

Table 8.3.1.8.3.3-5: MeasConfig (Table 8.3.1.8.3.3-4)

Derivation Path: 36.508, Table 4.6.6-1			
Information Element	Value/remark	Comment	Condition
MeasConfig ::= SEQUENCE {			
measObjectToRemoveList SEQUENCE (SIZE (1..maxObjectId)) OF SEQUENCE {	1 entry		
measObjectId[1]	IdMeasObject-f1		
}			
reportConfigToRemoveList SEQUENCE (SIZE (1..maxReportConfigId)) OF SEQUENCE {	1 entry		
reportConfigId[1]	IdReportConfig-A3		
}			
measIdToRemoveList SEQUENCE (SIZE (1..maxMeasId)) OF SEQUENCE {	1 entry		
measId[1]	1		
}			
}			

Table 8.3.1.8.3.3-6: *MobilityControlInfo* (Table 8.3.1.8.3.3-4)

Derivation Path: 36.508, Table 4.6.5-1			
Information Element	Value/remark	Comment	Condition
MobilityControlInfo ::= SEQUENCE {			
targetPhysCellId	PhysicalCellId of Cell 2		
carrierFreq	Not present		
}			

8.3.1.9 Measurement configuration control and reporting / Intra E-UTRAN measurements / Intra-frequency handover / IE measurement configuration not present

8.3.1.9.1 Test Purpose (TP)

(1)

```
with { UE having completed the radio bearer establishment, initial security activation procedure and performed the intra frequency measurement }
ensure that {
  when { UE receives an RRCConnectionReconfiguration message including a mobilityControlInfo and not including a measConfig }
  then { UE performs intra frequency handover and continues the intra frequency measurement }
}
```

(2)

```
with { UE having completed the radio bearer establishment, initial security activation procedure and performed the inter frequency measurement }
ensure that {
  when { UE receives an RRCConnectionReconfiguration message including a mobilityControlInfo and not including a measConfig }
  then { UE performs intra frequency handover and continues the inter frequency measurement after the activation of the measurement gaps }
}
```

8.3.1.9.2 Conformance requirements

References: The conformance requirements covered in the present TC are specified in: TS 36.331, clause 5.5.4.4 and 5.5.6.1.

[TS 36.331, clause 5.5.4.4]

The UE shall:

1> consider the entering condition for this event to be satisfied when condition A3-1, as specified below, is fulfilled;

1> consider the leaving condition for this event to be satisfied when condition A3-2, as specified below, is fulfilled;

Inequality A3-1 (Entering condition)

$$Mn + Ofn + Ocn - Hys > Ms + Ofs + Ocs + Off$$

Inequality A3-2 (Leaving condition)

$$Mn + Ofn + Ocn + Hys < Ms + Ofs + Ocs + Off$$

The variables in the formula are defined as follows:

Mn is the measurement result of the neighbouring cell, not taking into account any offsets.

Ofn is the frequency specific offset of the frequency of the neighbour cell (i.e. *offsetFreq* as defined within *measObjectEUTRA* corresponding to the frequency of the neighbour cell).

Ocn is the cell specific offset of the neighbour cell (i.e. *cellIndividualOffset* as defined within *measObjectEUTRA* corresponding to the frequency of the neighbour cell), and set to zero if not configured for the neighbour cell.

Ms is the measurement result of the serving cell, not taking into account any offsets.

Ofs is the frequency specific offset of the serving frequency (i.e. *offsetFreq* as defined within *measObjectEUTRA* corresponding to the serving frequency).

Ocs is the cell specific offset of the serving cell (i.e. *cellIndividualOffset* as defined within *measObjectEUTRA* corresponding to the serving frequency), and is set to zero if not configured for the serving cell.

Hys is the hysteresis parameter for this event (i.e. *hysteresis* as defined within *reportConfigEUTRA* for this event).

Off is the offset parameter for this event (i.e. *a3-Offset* as defined within *reportConfigEUTRA* for this event).

Mn, *Ms* are expressed in dBm in case of RSRP, or in dB in case of RSRQ.

Ofn, *Ocn*, *Ofs*, *Ocs*, *Hys*, *Off* are expressed in dB.

[TS 36.331, clause 5.5.6.1]

E-UTRAN applies the handover procedure as follows:

- when performing the handover procedure, as specified in 5.3.5.4, ensure that a *measObjectId* corresponding to the handover target carrier frequency is configured as a result of the procedures described in this sub-clause and in 5.3.5.4;

...

The UE shall:

- 1> for each *measId* included in the *measIdList* within *VarMeasConfig*:
 - 2> if the *triggerType* is set to 'periodical':
 - 3> remove this *measId* from the *measIdList* within *VarMeasConfig*:
- 1> if the procedure was triggered due to inter-frequency handover or successful re-establishment to an inter-frequency cell, update the *measId* values in the *measIdList* within *VarMeasConfig* as follows:
 - 2> if a *measObjectId* value corresponding to the target carrier frequency exists in the *measObjectList* within *VarMeasConfig*:
 - 3> for each *measId* value in the *measIdList*:
 - 4> if the *measId* value is linked to the *measObjectId* value corresponding to the source carrier frequency:
 - 5> link this *measId* value to the *measObjectId* value corresponding to the target carrier frequency;
 - 4> else if the *measId* value is linked to the *measObjectId* value corresponding to the target carrier frequency:
 - 5> link this *measId* value to the *measObjectId* value corresponding to the source carrier frequency;
 - 2> else:
 - 3> remove all *measId* values that are linked to the *measObjectId* value corresponding to the source carrier frequency;
 - 1> remove all measurement reporting entries within *VarMeasReportList*;
 - 1> reset the periodical reporting timer or timer T321, whichever one is running, as well as associated information (e.g. *timeToTrigger*) for all *measId*;
 - 1> release the measurement gaps, if activated;

NOTE: If the UE requires measurement gaps to perform inter-frequency or inter-RAT measurements, the UE resumes the inter-frequency and inter-RAT measurements after the E-UTRAN has setup the measurement gaps.

8.3.1.9.3 Test description

8.3.1.9.3.1 Pre-test conditions

System Simulator:

- Cell 1, Cell 2 and Cell 3.
- System information combination 3 as defined in TS 36.508 [18] clause 4.4.3.1 is used in E-UTRA cells.

UE:

None.

Preamble:

- The UE is in state Generic RB Established (state 3) on Cell 1 according to [18].

8.3.1.9.3.2 Test procedure sequence

Table 8.3.1.9.3.2-1 illustrates the downlink power levels and other changing parameters to be applied for the cells at various time instants of the test execution. Row marked "T0" denotes the initial conditions after preamble, while columns marked "T1", "T2", "T3" and "T4" are to be applied subsequently. The exact instants on which these values shall be applied are described in the texts in this clause.

Table 8.3.1.9.3.2-1: Time instances of cell power level and parameter changes

	Parameter	Unit	Cell 1	Cell 2	Cell 3 (DL only)	Remark
T0	Cell-specific RS EPRE	dBm/15k Hz	-85	"Off"	-97	The power level values are such that measurement results for Cell 1 (M1) and Cell 3 (M3) do not satisfy entry condition for event A3 ($M3 < M1$). (NOTE 1)
T1	Cell-specific RS EPRE	dBm/15k Hz	-85	"Off"	-73	The power level values are such that measurement results for Cell 1 (M1) and Cell 3 (M3) satisfy entry condition for event A3 ($M3 > M1$). (NOTE 1)
T2	Cell-specific RS EPRE	dBm/15k Hz	-85	-79	"Off"	The power level values are such that measurement results for Cell 1 (M1) and Cell 2 (M2) satisfy entry condition for event A3 ($M2 > M1$). (NOTE 1)
T3	Cell-specific RS EPRE	dBm/15k Hz	"Off"	-85	-73	The power level values are such that measurement results for Cell 2 (M2) and Cell 3 (M3) satisfy entry condition for event A3 ($M3 > M2$). (NOTE 1)
T4	Cell-specific RS EPRE	dBm/15k Hz	-79	-85	"Off"	The power level values are such that measurement results for Cell 1 (M1) and Cell 2 (M2) satisfy entry condition for event A3 ($M1 > M2$). (NOTE 1)
NOTE 1: Power level "Off" is defined in TS36.508 Table 6.2.2.1-1.						

Table 8.3.1.9.3.2-2: Main behaviour

St	Procedure	Message Sequence		TP	Verdict
		U - S	Message		
1	The SS transmits an <i>RRCCONNECTIONRECONFIGURATION</i> message to setup intra and inter frequency measurements on Cell 1.	<--	<i>RRCCONNECTIONRECONFIGURATION</i>	-	-
2	The UE transmits an <i>RRCCONNECTIONRECONFIGURATIONCOMPLETE</i> message to confirm the setup of intra and inter frequency measurements on Cell 1.	-->	<i>RRCCONNECTIONRECONFIGURATIONCOMPLETE</i>	-	-
-	EXCEPTION: Steps 3a1 to 3a2 describe behaviour that depends on the UE capability; the "lower case letter" identifies a step sequence that takes place if a capability is supported.	-	-	-	-
3a1	IF <i>pc_FeatrGrp_25</i> THEN the SS changes Cell 1, Cell 2 and Cell 3 parameters according to the row "T1" in table 8.3.1.9.3.2-1.	-	-	-	-
3a2	The UE transmits a <i>MEASUREMENTREPORT</i> message on Cell 1 to report event A3 for Cell 3.	-->	<i>MEASUREMENTREPORT</i>	-	-
4	The SS changes Cell 1, Cell 2 and Cell 3 parameters according to the row "T2" in table 8.3.1.9.3.2-1.	-	-	-	-
5	The UE transmits a <i>MEASUREMENTREPORT</i> message on Cell 1 to report event A3 for Cell 2.	-->	<i>MEASUREMENTREPORT</i>	-	-
6	The SS transmits an <i>RRCCONNECTIONRECONFIGURATION</i> message without a <i>measConfig</i> message on Cell 1, to order the UE to perform intra frequency handover to Cell 2.	<--	<i>RRCCONNECTIONRECONFIGURATION</i>	-	-
7	Check: Does the UE transmit an <i>RRCCONNECTIONRECONFIGURATIONCOMPLETE</i> message on Cell 2?	-->	<i>RRCCONNECTIONRECONFIGURATIONCOMPLETE</i>	1	P
-	EXCEPTION: Steps 8a1 to 8a4 describe behaviour that depends on the UE capability; the "lower case letter" identifies a step sequence that takes place if a capability is supported.	-	-	-	-
8a1	IF <i>pc_FeatrGrp_25</i> THEN the SS transmits an <i>RRCCONNECTIONRECONFIGURATION</i> message to activate the measurement gaps on Cell 2.	<--	<i>RRCCONNECTIONRECONFIGURATION</i>	-	-
8a2	The UE transmits an <i>RRCCONNECTIONRECONFIGURATIONCOMPLETE</i> message to confirm the activation of the measurement gaps on Cell 2.	-->	<i>RRCCONNECTIONRECONFIGURATIONCOMPLETE</i>	-	-
8a3	The SS changes Cell 1, Cell 2 and Cell 3 parameters according to the row "T3" in table 8.3.1.9.3.2-1.	-	-	-	-
8a4	Check: Does the UE transmit a <i>MEASUREMENTREPORT</i> message on Cell 2 to report event A3 for Cell 3?	-->	<i>MEASUREMENTREPORT</i>	2	P
9	The SS changes Cell 1, Cell 2 and Cell 3 parameters according to the row "T4" in table 8.3.1.9.3.2-1.	-	-	-	-
10	Check: Does the UE transmit a <i>MEASUREMENTREPORT</i> message on Cell 2 to report event A3 for Cell 1?	-->	<i>MEASUREMENTREPORT</i>	1	P
11	Check: Does the test result of generic test procedure in TS 36.508 subclause 6.4.2.3 indicate that the UE is in E-UTRA <i>RRC_CONNECTED</i> state on Cell 2?	-	-	1,2	-

8.3.1.9.3.3 Specific message contents

Table 8.3.1.9.3.3-1: RRCConnectionReconfiguration (step 1, Table 8.3.1.9.3.2-2)

Derivation Path: 36.508, Table 4.6.1-8, condition MEAS

Table 8.3.1.9.3.3-2: MeasConfig (Table 8.3.1.9.3.3-1)

Derivation Path: 36.508, Table 4.6.6-1, condition INTER-FREQ			
Information Element	Value/remark	Comment	Condition
MeasConfig ::= SEQUENCE {			
measObjectToAddModList SEQUENCE (SIZE (1..maxObjectId)) OF SEQUENCE {	1 entry or 2 entries	number of entry depending on the UE capability	
measObjectId[1]	IdMeasObject-f1		
measObject[1]	MeasObjectEUTRA-GENERIC(f1)		
measObjectId[2]	IdMeasObject-f2		pc_FeatrGrp_25
measObject[2]	MeasObjectEUTRA-GENERIC(f2)		pc_FeatrGrp_25
}			
reportConfigToAddModList SEQUENCE (SIZE (1..maxReportConfigId)) OF SEQUENCE {	1 entry		
reportConfigId[1]	IdReportConfig-A3		
reportConfig[1]	ReportConfigEUTRA-A3		
}			
measIdToAddModList SEQUENCE (SIZE (1..maxMeasId)) OF SEQUENCE {	1 entry or 2 entries	number of entry depending on the UE capability	
measId[1]	1	Intra frequency	
measObjectId[1]	IdMeasObject-f1		
reportConfigId[1]	IdReportConfig-A3		
measId[2]	2	Inter frequency	pc_FeatrGrp_25
measObjectId[2]	IdMeasObject-f2		pc_FeatrGrp_25
reportConfigId[2]	IdReportConfig-A3		pc_FeatrGrp_25
}			
}			

Table 8.3.1.9.3.3-3: MeasurementReport (step 3a2 and 8a4, Table 8.3.1.9.3.2-2)

Derivation Path: 36.508, Table 4.6.1-5			
Information Element	Value/remark	Comment	Condition
MeasurementReport ::= SEQUENCE {			
criticalExtensions CHOICE {			
c1 CHOICE{			
measurementReport-r8 SEQUENCE {			
measResults SEQUENCE {			
measId	2		
measResultServCell SEQUENCE {			
rsrpResult	(0..97)		
rsrqResult	(0..34)		
}			
measResultNeighCells CHOICE {			
measResultListEUTRA SEQUENCE (SIZE (1..maxCellReport)) OF SEQUENCE {	1 entry		
physCellId[1]	PhysicalCellIdentity of Cell 3		
cgi-Info[1]	Not present		
measResult[1] SEQUENCE {			
rsrpResult	(0..97)		
rsrqResult	(0..34)		
}			
}			
}			
}			
}			
}			
}			

Table 8.3.1.9.3.3-4: MeasurementReport (step 5, Table 8.3.1.9.3.2-2)

Derivation Path: 36.508, Table 4.6.1-5			
Information Element	Value/remark	Comment	Condition
MeasurementReport ::= SEQUENCE {			
criticalExtensions CHOICE {			
c1 CHOICE{			
measurementReport-r8 SEQUENCE {			
measResults SEQUENCE {			
measId	1		
measResultServCell SEQUENCE {			
rsrpResult	(0..97)		
rsrqResult	(0..34)		
}			
measResultNeighCells CHOICE {			
measResultListEUTRA SEQUENCE (SIZE (1..maxCellReport)) OF SEQUENCE {	1 entry		
physCellId[1]	PhysicalCellIdentity of Cell 2		
cgi-Info[1]	Not present		
measResult[1] SEQUENCE {			
rsrpResult	(0..97)		
rsrqResult	(0..34)		
}			
}			
}			
}			
}			
}			
}			

Table 8.3.1.9.3.3-5: RRCConnectionReconfiguration (step 6, Table 8.3.1.9.3.2-2)

Derivation Path: 36.508, Table 4.6.1-8, condition HO

Table 8.3.1.9.3.3-6: MobilityControlInfo (Table 8.1.3.9.3.3-5)

Derivation Path: 36.508, Table 4.6.5-1			
Information Element	Value/remark	Comment	Condition
MobilityControlInfo ::= SEQUENCE {			
targetPhysCellId	PhysicalCellId of Cell 2		
carrierFreq	Not present		
}			

Table 8.3.1.9.3.3-7: RRCConnectionReconfiguration (step 8a1, Table 8.3.1.9.3.2-2)

Derivation Path: 36.508, Table 4.6.1-8, condition MEAS

Table 8.3.1.9.3.3-8: MeasConfig (Table 8.1.3.9.3.3-7)

Derivation Path: 36.508, Table 4.6.6-1, condition INTER-FREQ

Table 8.3.1.9.3.3-9: MeasurementReport (step 10, Table 8.3.1.9.3.2-2)

Derivation Path: 36.508, Table 4.6.1-5			
Information Element	Value/remark	Comment	Condition
MeasurementReport ::= SEQUENCE {			
criticalExtensions CHOICE {			
c1 CHOICE{			
measurementReport-r8 SEQUENCE {			
measResults SEQUENCE {			
measId	1		
measResultServCell SEQUENCE {			
rsrpResult	(0..97)		
rsrqResult	(0..34)		
}			
measResultNeighCells CHOICE {			
measResultListEUTRA SEQUENCE (SIZE (1..maxCellReport)) OF SEQUENCE {	1 entry		
physCellId[1]	PhysicalCellId of Cell 1		
cgi-Info[1]	Not present		
measResult[1] SEQUENCE {			
rsrpResult	(0..97)		
rsrqResult	(0..34)		
}			
}			
}			
}			
}			
}			
}			
}			
}			
}			

8.3.1.9a Measurement configuration control and reporting / Intra Frequency measurements / Intra-frequency handover / IE measurement configuration not present / Single Frequency operation

8.3.1.9a.1 Test Purpose (TP)

(1)

```
with { UE having completed the radio bearer establishment, initial security activation procedure and
performed the intra frequency measurement }
ensure that {
  when { UE receives an RRCConnectionReconfiguration message including a mobilityControlInfo and not
including a measConfig }
    then { UE performs intra frequency handover and continues the intra frequency measurement }
}
```

8.3.1.9a.2 Conformance requirements

References: The conformance requirements covered in the present TC are specified in: TS 36.331, clause 5.5.4.4 and 5.5.6.1.

[TS 36.331, clause 5.5.4.4]

The UE shall:

1> consider the entering condition for this event to be satisfied when condition A3-1, as specified below, is fulfilled;

1> consider the leaving condition for this event to be satisfied when condition A3-2, as specified below, is fulfilled;

Inequality A3-1 (Entering condition)

$$Mn + Ofn + Ocn - Hys > Ms + Ofs + Ocs + Off$$

Inequality A3-2 (Leaving condition)

$$Mn + Ofn + Ocn + Hys < Ms + Ofs + Ocs + Off$$

The variables in the formula are defined as follows:

Mn is the measurement result of the neighbouring cell, not taking into account any offsets.

Ofn is the frequency specific offset of the frequency of the neighbour cell (i.e. *offsetFreq* as defined within *measObjectEUTRA* corresponding to the frequency of the neighbour cell).

Ocn is the cell specific offset of the neighbour cell (i.e. *cellIndividualOffset* as defined within *measObjectEUTRA* corresponding to the frequency of the neighbour cell), and set to zero if not configured for the neighbour cell.

Ms is the measurement result of the serving cell, not taking into account any offsets.

Ofs is the frequency specific offset of the serving frequency (i.e. *offsetFreq* as defined within *measObjectEUTRA* corresponding to the serving frequency).

Ocs is the cell specific offset of the serving cell (i.e. *cellIndividualOffset* as defined within *measObjectEUTRA* corresponding to the serving frequency), and is set to zero if not configured for the serving cell.

Hys is the hysteresis parameter for this event (i.e. *hysteresis* as defined within *reportConfigEUTRA* for this event).

Off is the offset parameter for this event (i.e. *a3-Offset* as defined within *reportConfigEUTRA* for this event).

Mn, **Ms** are expressed in dBm in case of RSRP, or in dB in case of RSRQ.

Ofn, **Ocn**, **Ofs**, **Ocs**, **Hys**, **Off** are expressed in dB.

[TS 36.331, clause 5.5.6.1]

E-UTRAN applies the handover procedure as follows:

- when performing the handover procedure, as specified in 5.3.5.4, ensure that a *measObjectId* corresponding to the handover target carrier frequency is configured as a result of the procedures described in this sub-clause and in 5.3.5.4;

...

The UE shall:

- 1> for each *measId* included in the *measIdList* within *VarMeasConfig*:
 - 2> if the *triggerType* is set to 'periodical':
 - 3> remove this *measId* from the *measIdList* within *VarMeasConfig*;
- 1> if the procedure was triggered due to inter-frequency handover or successful re-establishment to an inter-frequency cell, update the *measId* values in the *measIdList* within *VarMeasConfig* as follows:
 - 2> if a *measObjectId* value corresponding to the target carrier frequency exists in the *measObjectList* within *VarMeasConfig*:
 - 3> for each *measId* value in the *measIdList*:
 - 4> if the *measId* value is linked to the *measObjectId* value corresponding to the source carrier frequency:
 - 5> link this *measId* value to the *measObjectId* value corresponding to the target carrier frequency;
 - 4> else if the *measId* value is linked to the *measObjectId* value corresponding to the target carrier frequency:
 - 5> link this *measId* value to the *measObjectId* value corresponding to the source carrier frequency;
 - 2> else:
 - 3> remove all *measId* values that are linked to the *measObjectId* value corresponding to the source carrier frequency;
 - 1> remove all measurement reporting entries within *VarMeasReportList*;
 - 1> reset the periodical reporting timer or timer T321, whichever one is running, as well as associated information (e.g. *timeToTrigger*) for all *measId*;
 - 1> release the measurement gaps, if activated;

NOTE: If the UE requires measurement gaps to perform inter-frequency or inter-RAT measurements, the UE resumes the inter-frequency and inter-RAT measurements after the E-UTRAN has setup the measurement gaps.

8.3.1.9a.3 Test description

8.3.1.9a.3.1 Pre-test conditions

System Simulator:

- Cell 1, Cell 2.
- System information combination 2 as defined in TS 36.508 [18] clause 4.4.3.1 is used in E-UTRA cells.

UE:

None.

Preamble:

- The UE is in state Generic RB Established (state 3) on Cell 1 according to [18].

8.3.1.9a.3.2 Test procedure sequence

Table 8.3.1.9a.3.2-1 illustrates the downlink power levels and other changing parameters to be applied for the cells at various time instants of the test execution. Row marked "T0" denotes the initial conditions after preamble, while column marked "T1" and "T2" are to be applied subsequently. The exact instants on which these values shall be applied are described in the texts in this clause.

Table 8.3.1.9a.3.2-1: Time instances of cell power level and parameter changes

	Parameter	Unit	Cell 1	Cell 2	Remark
T0	Cell-specific RS EPRE	dBm/15k Hz	-85	off	The power level values are such that measurement results for Cell 1 (M1) and Cell 2 (M2) satisfy entry condition for event A3 (M2 > M1). (NOTE 1)
T1	Cell-specific RS EPRE	dBm/15k Hz	-85	-79	The power level values are such that measurement results for Cell 1 (M1) and Cell 2 (M2) satisfy entry condition for event A3 (M2 > M1). (NOTE 1)
T2	Cell-specific RS EPRE	dBm/15k Hz	-79	-85	The power level values are such that measurement results for Cell 1 (M1) and Cell 2 (M2) satisfy entry condition for event A3 (M1 > M2). (NOTE 1)

NOTE 1: Power level "Off" is defined in TS36.508 Table 6.2.2.1-1.

Table 8.3.1.9a.3.2-2: Main behaviour

St	Procedure	Message Sequence		TP	Verdict
		U - S	Message		
1	The SS transmits an <i>RRConnectionReconfiguration</i> message to setup intra frequency measurements on Cell 1.	<--	<i>RRConnectionReconfiguration</i>	-	-
2	The UE transmits an <i>RRConnectionReconfigurationComplete</i> message to confirm the setup of intra frequency measurements on Cell 1.	-->	<i>RRConnectionReconfigurationComplete</i>	-	-
3	The SS changes Cell 1 and Cell 2 parameters according to the row "T1" in table 8.3.1.9a.3.2-1.	-	-	-	-
4	The UE transmits a <i>MeasurementReport</i> message on Cell 1 to report event A3 for Cell 2.	-->	<i>MeasurementReport</i>	-	-
5	The SS transmits an <i>RRConnectionReconfiguration</i> message without a measConfig message on Cell 1, to order the UE to perform intra frequency handover to Cell 2.	<--	<i>RRConnectionReconfiguration</i>	-	-
6	Check: Does the UE transmit an <i>RRConnectionReconfigurationComplete</i> message on Cell 2?	-->	<i>RRConnectionReconfigurationComplete</i>	1	P
7	The SS changes Cell 1 and Cell 2 parameters according to the row "T2" in table 8.3.1.9a.3.2-1.	-	-	-	-
8	Check: Does the UE transmit a <i>MeasurementReport</i> message on Cell 2 to report event A3 for Cell 1?	-->	<i>MeasurementReport</i>	1	P
9	Check: Does the test result of generic test procedure in TS 36.508 subclause 6.4.2.3 indicate that the UE is in E-UTRA RRC_CONNECTED state on Cell 2?	-	-	1,2	-

8.3.1.9a.3.3 Specific message contents

Table 8.3.1.9a.3.3-1: RRCConnectionReconfiguration (step 1, Table 8.3.1.9a.3.2-2)

Derivation Path: 36.508, Table 4.6.1-8, condition MEAS

Table 8.3.1.9a.3.3-2: MeasConfig (Table 8.3.1.9a.3.3-1)

Derivation Path: 36.508, Table 4.6.6-1			
Information Element	Value/remark	Comment	Condition
MeasConfig ::= SEQUENCE {			
measObjectToAddModList SEQUENCE (SIZE (1..maxObjectId)) OF SEQUENCE {	1 entry		
measObjectId[1]	IdMeasObject-f1		
measObject[1]	MeasObjectEUTRA-GENERIC(f1)		
}			
reportConfigToAddModList SEQUENCE (SIZE (1..maxReportConfigId)) OF SEQUENCE {	1 entry		
reportConfigId[1]	IdReportConfig-A3		
reportConfig[1]	ReportConfigEUTRA-A3		
}			
measIdToAddModList SEQUENCE (SIZE (1..maxMeasId)) OF SEQUENCE {	1 entry		
measId[1]	1	Intra frequency	
measObjectId[1]	IdMeasObject-f1		
reportConfigId[1]	IdReportConfig-A3		
}			
}			

Table 8.3.1.9a.3.3-3: MeasurementReport (step 4, Table 8.3.1.9a.3.2-2)

Derivation Path: 36.508, Table 4.6.1-5			
Information Element	Value/remark	Comment	Condition
MeasurementReport ::= SEQUENCE {			
criticalExtensions CHOICE {			
c1 CHOICE {			
measurementReport-r8 SEQUENCE {			
measResults SEQUENCE {			
measId	1		
measResultServCell SEQUENCE {			
rsrpResult	(0..97)		
rsrqResult	(0..34)		
}			
measResultNeighCells CHOICE {			
measResultListEUTRA SEQUENCE (SIZE (1..maxCellReport)) OF SEQUENCE {	1 entry		
physCellId[1]	PhysicalCellIdentity of Cell 2		
cgi-Info[1]	Not present		
measResult[1] SEQUENCE {			
rsrpResult	(0..97)		
rsrqResult	(0..34)		
}			
}			
}			
}			
}			
}			
}			
}			

Table 8.3.1.9a.3.3-4: RRCConnectionReconfiguration (step 6, Table 8.3.1.9a.3.2-2)

Derivation Path: 36.508, Table 4.6.1-8, condition HO

Table 8.3.1.9a.3.3-5: MobilityControlInfo (Table 8.1.3.9.3.3-4)

Derivation Path: 36.508, Table 4.6.5-1			
Information Element	Value/remark	Comment	Condition
MobilityControlInfo ::= SEQUENCE {			
targetPhysCellId	PhysicalCellId of Cell 2		
carrierFreq	Not present		
}			

Table 8.3.1.9a.3.3-6: MeasurementReport (step 8, Table 8.3.1.9a.3.2-2)

Derivation Path: 36.508, Table 4.6.1-5			
Information Element	Value/remark	Comment	Condition
MeasurementReport ::= SEQUENCE {			
criticalExtensions CHOICE {			
c1 CHOICE {			
measurementReport-r8 SEQUENCE {			
measResults SEQUENCE {			
measId	1		
measResultServCell SEQUENCE {			
rsrpResult	(0..97)		
rsrqResult	(0..34)		
}			
measResultNeighCells CHOICE {			
measResultListEUTRA SEQUENCE (SIZE (1..maxCellReport)) OF SEQUENCE {	1 entry		
physCellId[1]	PhysicalCellId of Cell 1		
cgi-Info[1]	Not present		
measResult[1] SEQUENCE {			
rsrpResult	(0..97)		
rsrqResult	(0..34)		
}			
}			
}			
}			
}			
}			
}			

8.3.1.10 Measurement configuration control and reporting / Intra E-UTRAN measurements / Inter-frequency handover / IE measurement configuration not present

8.3.1.10.1 Test Purpose (TP)

(1)

```

with { UE having completed the radio bearer establishment, initial security activation procedure and
performed the intra frequency and inter frequency measurements }
ensure that {
  when { UE receives an RRCConnectionReconfiguration message including a mobilityControlInfo
indicating a different E-UTRAN frequency and not including a measConfig }
  then { UE performs inter frequency handover, continues the intra frequency measurement and
continues inter frequency measurement after the activation of the measurement gaps }
}

```

8.3.1.10.2 Conformance requirements

References: The conformance requirements covered in the present TC are specified in: TS 36.331, clause 5.5.6.1.

[TS 36.331, clause 5.5.6.1]

E-UTRAN applies the handover procedure as follows:

- when performing the handover procedure, as specified in 5.3.5.4, ensure that a *measObjectId* corresponding to the handover target carrier frequency is configured as a result of the procedures described in this subclause and in 5.3.5.4;

...

The UE shall:

- 1> for each *measId* included in the *measIdList* within *VarMeasConfig*:
 - 2> if the *triggerType* is set to 'periodical':
 - 3> remove this *measId* from the *measIdList* within *VarMeasConfig*;
- 1> if the procedure was triggered due to inter-frequency handover or successful re-establishment to an inter-frequency cell, update the *measId* values in the *measIdList* within *VarMeasConfig* as follows:
 - 2> if a *measObjectId* value corresponding to the target carrier frequency exists in the *measObjectList* within *VarMeasConfig*
 - 3> for each *measId* value in the *measIdList*:
 - 4> if the *measId* value is linked to the *measObjectId* value corresponding to the source carrier frequency:
 - 5> link this *measId* value to the *measObjectId* value corresponding to the target carrier frequency;
 - 4> else if the *measId* value is linked to the *measObjectId* value corresponding to the target carrier frequency:
 - 5> link this *measId* value to the *measObjectId* value corresponding to the source carrier frequency;
 - 2> else:
 - 3> remove all *measId* values that are linked to the *measObjectId* value corresponding to the source carrier frequency;
 - 1> remove all measurement reporting entries within *VarMeasReportList*;
 - 1> reset the periodical reporting timer or timer T321, whichever one is running, as well as associated information (e.g. *timeToTrigger*) for all *measId*;
 - 1> release the measurement gaps, if activated;

NOTE: If the UE requires measurement gaps to perform inter-frequency or inter-RAT measurements, the UE resumes the inter-frequency and inter-RAT measurements after the E-UTRAN has setup the measurement gaps.

8.3.1.10.3 Test description

8.3.1.10.3.1 Pre-test conditions

System Simulator:

- Cell 1, Cell 2, Cell 3 and Cell 12.
- System information combination 3 as defined in TS 36.508 [18] clause 4.4.3.1 is used in E-UTRA cells.

UE:

None.

Preamble:

- The UE is in state Generic RB Established (state 3) on Cell 1 according to [18].

8.3.1.10.3.2 Test procedure sequence

Table 8.3.1.10.3.2-1 illustrates the downlink power levels and other changing parameters to be applied for the cells at various time instants of the test execution. Row marked "T0" denotes the initial conditions after preamble, while columns marked "T1", "T2", "T3", and "T4" are to be applied subsequently. The exact instants on which these values shall be applied are described in the texts in this clause.

Table 8.3.1.10.3.2-1: Time instances of cell power level and parameter changes

	Parameter	Unit	Cell 1	Cell 2 (DL only)	Cell 3	Cell 12 (DL only)	Remark
T0	Cell-specific RS EPRE	dBm/15 kHz	-85	-91	-97	"Off"	The power level values are such that measurement results for Cell 1 (M1) and Cell 2 (M2) do not satisfy entry condition for event A3 ($M2 < M1$). (NOTE 1).
T1	Cell-specific RS EPRE	dBm/15 kHz	-85	-79	-97	"Off"	The power level values are such that measurement results for Cell 1 (M1) and Cell 2 (M2) satisfy entry condition for event A3 ($M2 > M1$). (NOTE 1).
T2	Cell-specific RS EPRE	dBm/15 kHz	-85	"Off"	-73	"Off"	The power level values are such that measurement results for Cell 1 (M1) and Cell 3 (M3) satisfy entry condition for event A3 ($M3 > M1$). (NOTE 1).
T3	Cell-specific RS EPRE	dBm/15 kHz	-97	"Off"	-85	-79	The power level values are such that measurement results for Cell 3 (M3) and Cell 12 (M12) satisfy entry condition for event A3 ($M12 > M3$). (NOTE 1).
T4	Cell-specific RS EPRE	dBm/15 kHz	-73	"Off"	-85	"Off"	The power level values are such that measurement results for Cell 1 (M1) and Cell 3 (M3) satisfy entry condition for event A3 ($M1 > M3$). (NOTE 1).
NOTE 1: Power level "Off" is defined in TS36.508 Table 6.2.2.1-1.							

Table 8.3.1.10.3.2-2: Main behaviour

St	Procedure	Message Sequence		TP	Verdict
		U - S	Message		
1	The SS transmits an <i>RRCCONNECTIONRECONFIGURATION</i> message to setup intra and inter frequency measurements on Cell 1.	<--	<i>RRCCONNECTIONRECONFIGURATION</i>	-	-
2	The UE transmits an <i>RRCCONNECTIONRECONFIGURATIONCOMPLETE</i> message to confirm the setup of intra and inter frequency measurements on Cell 1.	-->	<i>RRCCONNECTIONRECONFIGURATIONCOMPLETE</i>	-	-
3	The SS changes the cell-specific reference signal levels of Cell 2 according to the row "T1" in table 8.3.1.10.3.2-1.	-	-	-	-
4	The UE transmits a <i>MEASUREMENTREPORT</i> message on Cell 1 to perform event A3 intra frequency reporting for Cell 2 during the next 30 s.	-	<i>MEASUREMENTREPORT</i>	-	-
5	The SS changes the cell-specific reference signal levels of Cell 3 and switches "Off" Cell 2 according to row "T2" in table 8.3.1.10.3.2-1.	-	-	-	-
6	The UE transmits a <i>MEASUREMENTREPORT</i> message on Cell 1 to perform event A3 inter frequency reporting for Cell 3 during the next 30 s.	-->	<i>MEASUREMENTREPORT</i>	-	-
7	The SS transmits an <i>RRCCONNECTIONRECONFIGURATION</i> message without a <i>measConfig</i> , to order the UE to perform inter frequency handover to Cell 3.	<--	<i>RRCCONNECTIONRECONFIGURATION</i>	-	-
8	Check: Does the UE transmit an <i>RRCCONNECTIONRECONFIGURATIONCOMPLETE</i> message to Cell 3?	-->	<i>RRCCONNECTIONRECONFIGURATIONCOMPLETE</i>	1	P
9	The SS transmits an <i>RRCCONNECTIONRECONFIGURATION</i> message to activate the measurement gaps on Cell 3.	<--	<i>RRCCONNECTIONRECONFIGURATION</i>	-	-
10	The UE transmits an <i>RRCCONNECTIONRECONFIGURATIONCOMPLETE</i> message to confirm the activation of the measurement gaps on Cell 3.	-->	<i>RRCCONNECTIONRECONFIGURATIONCOMPLETE</i>	-	-
11	The SS changes the cell-specific reference signal levels of Cell 1 and Cell 3 and switches "On" Cell 12 according to the row "T3" in table 8.3.1.10.3.2-1.	-	-	-	-
12	Check: Does the UE transmit a <i>MEASUREMENTREPORT</i> message on Cell 3 to perform event A3 intra frequency reporting for Cell 12 during the next 30 s?	-->	<i>MEASUREMENTREPORT</i>	1	P
13	The SS changes the cell-specific reference signal levels of Cell 1 and switches Cell 12 off according to row "T4" in table 8.3.1.10.3.2-1.	-	-	-	-
14	Check: Does the UE transmit a <i>MEASUREMENTREPORT</i> message on Cell 3 to perform event A3 inter frequency reporting for Cell 1 during the next 30 s?	-->	<i>MEASUREMENTREPORT</i>	1	P
15	Check: Does the test result of generic test procedure in TS 36.508 subclause 6.4.2.3 indicate that the UE is in E-UTRA RRC_CONNECTED state on Cell 3?	-	-	1	-

8.3.1.10.3.3 Specific message contents

Table 8.3.1.10.3.3-1: *RRCCONNECTIONRECONFIGURATION* (step 1, Table 8.3.1.10.3.2-1)

Derivation Path: 36.508, Table 4.6.1-8, condition MEAS

Table 8.3.1.10.3.3-2: MeasConfig (Table 8.3.1.10.3.3-1)

Derivation Path: 36.508, Table 4.6.6-1, condition INTER-FREQ			
Information Element	Value/remark	Comment	Condition
MeasConfig ::= SEQUENCE {			
measObjectToAddModList SEQUENCE (SIZE (1..maxObjectId)) OF SEQUENCE {	2 entries		
measObjectId[1]	IdMeasObject-f1		
measObject[1]	MeasObjectEUTRA-GENERIC(f1)		
measObjectId[2]	IdMeasObject-f2		
measObject[2]	MeasObjectEUTRA-GENERIC(f2)		
}			
reportConfigToAddModList SEQUENCE (SIZE (1..maxReportConfigId)) OF SEQUENCE {	1 entry		
reportConfigId[1]	IdReportConfig-A3		
reportConfig[1]	ReportConfigEUTRA-A3		
}			
measIdToAddModList SEQUENCE (SIZE (1..maxMeasId)) OF SEQUENCE {	2 entries		
measId[1]	1		
measObjectId[1]	IdMeasObject-f1		
reportConfigId[1]	IdReportConfig-A3		
measId[2]	2		
measObjectId[2]	IdMeasObject-f2		
reportConfigId[2]	IdReportConfig-A3		
}			
}			

Table 8.3.1.10.3.3-3: Void

Table 8.3.1.10.3.3-4: MeasurementReport (step 4, Table 8.3.1.10.3.2-2)

Derivation Path: 36.508, Table 4.6.1-5			
Information Element	Value/remark	Comment	Condition
MeasurementReport ::= SEQUENCE {			
criticalExtensions CHOICE {			
c1 CHOICE{			
measurementReport-r8 SEQUENCE {			
measResults SEQUENCE {			
measId	1		
measResultServCell SEQUENCE {			
rsrpResult	(0..97)		
rsrqResult	(0..34)		
}			
measResultNeighCells CHOICE {			
measResultListEUTRA SEQUENCE (SIZE (1..maxCellReport)) OF SEQUENCE {	1 entry		
physCellId[1]	PhysicalCellIdentity of Cell 2		
cgi-Info[1]	Not present		
measResult[1] SEQUENCE {			
rsrpResult	(0..97)		
rsrqResult	(0..34)		
}			
}			
}			
}			
}			
}			
}			
}			

Table 8.3.1.10.3.3-5: MeasurementReport (step 6, Table 8.3.1.10.3.2-2)

Derivation Path: 36.508, Table 4.6.1-5			
Information Element	Value/remark	Comment	Condition
MeasurementReport ::= SEQUENCE {			
criticalExtensions CHOICE {			
c1 CHOICE{			
measurementReport-r8 SEQUENCE {			
measResults SEQUENCE {			
measId	2		
measResultServCell SEQUENCE {			
rsrpResult	(0..97)		
rsrqResult	(0..34)		
}			
measResultNeighCells CHOICE {			
measResultListEUTRA SEQUENCE (SIZE (1..maxCellReport)) OF SEQUENCE {	1 entry		
physCellId[1]	PhysicalCellIdentity of Cell 3		
cgi-Info[1]	Not present		
measResult[1] SEQUENCE {			
rsrpResult	(0..97)		
rsrqResult	(0..34)		
}			
}			
}			
}			
}			
}			

Table 8.3.1.10.3.3-6: RRCConnectionReconfiguration (step 7, Table 8.3.1.10.3.2-2)

Derivation Path: 36.508, Table 4.6.1-8, condition HO
--

Table 8.3.1.10.3.3-7: MobilityControlInfo (Table 8.3.1.10.3.3-6)

Derivation Path: 36.508, Table 4.6.5-1			
Information Element	Value/remark	Comment	Condition
MobilityControlInfo ::= SEQUENCE {			
targetPhysCellId	PhysicalCellIdentity of Cell 3		
carrierFreq	Same DL EARFCN as used for Cell 3		
}			

Table 8.3.1.10.3.3-8: RRCConnectionReconfiguration (step 9, Table 8.3.1.10.3.2-2)

Derivation Path: 36.508, Table 4.6.1-8, condition MEAS
--

Table 8.3.1.10.3.3-9: MeasConfig (Table 8.3.1.10.3.3-8)

Derivation Path: 36.508, Table 4.6.6-1, condition INTER-FREQ
--

Table 8.3.1.10.3.3-10: MeasurementReport (step 12, Table 8.3.1.10.3.2-2)

Derivation Path: 36.508, Table 4.6.1-5			
Information Element	Value/remark	Comment	Condition
MeasurementReport ::= SEQUENCE {			
criticalExtensions CHOICE {			
c1 CHOICE{			
measurementReport-r8 SEQUENCE {			
measResults SEQUENCE {			
measId	1		
measResultServCell SEQUENCE {			
rsrpResult	(0..97)		
rsrqResult	(0..34)		
}			
measResultNeighCells CHOICE {			
measResultListEUTRA SEQUENCE (SIZE (1..maxCellReport)) OF SEQUENCE {	1 entry		
physCellId[1]	PhysicalCellIdentity of Cell 12		
cgi-Info[1]	Not present		
measResult[1] SEQUENCE {			
rsrpResult	(0..97)		
rsrqResult	(0..34)		
}			
}			
}			
}			
}			
}			
}			

Table 8.3.1.10.3.3-11: MeasurementReport (step 14, Table 8.3.1.10.3.2-2)

Derivation Path: 36.508, Table 4.6.1-5			
Information Element	Value/remark	Comment	Condition
MeasurementReport ::= SEQUENCE {			
criticalExtensions CHOICE {			
c1 CHOICE{			
measurementReport-r8 SEQUENCE {			
measResults SEQUENCE {			
measId	2		
measResultServCell SEQUENCE {			
rsrpResult	(0..97)		
rsrqResult	(0..34)		
}			
measResultNeighCells CHOICE {			
measResultListEUTRA SEQUENCE (SIZE (1..maxCellReport)) OF SEQUENCE {	1 entry		
physCellId[1]	PhysicalCellIdentity of Cell 1		
cgi-Info[1]	Not present		
measResult[1] SEQUENCE {			
rsrpResult	(0..97)		
rsrqResult	(0..34)		
}			
}			
}			
}			
}			
}			
}			

8.3.1.11 Measurement configuration control and reporting / Intra E-UTRAN measurements / Continuation of the measurements after RRC connection re-establishment

8.3.1.11.1 Test Purpose (TP)

(1)

```
with { UE having completed the radio bearer establishment, initial security activation procedure and
performed the intra frequency measurement and after receiving an RRCConnectionReconfiguration
message including a mobilityControlInfo indicating a different E-UTRA cell having attempted intra
frequency handover}
ensure that {
  when { UE detects handover failure and the intra frequency cell is selectable }
  then {UE performs RRC Connection Re-establishment, continues the intra frequency measurement }
}
```

(2)

```
with { UE having completed the radio bearer establishment, initial security activation procedure and
performed the inter frequency measurement and after receiving an RRCConnectionReconfiguration
message including a mobilityControlInfo indicating a different E-UTRA cell having attempted intra
frequency handover}
ensure that {
  when { UE detects handover failure and the intra frequency cell is selectable }
  then {UE performs RRC Connection Re-establishment, continues the inter frequency measurement
after the activation of the measurement gaps }
}
```

8.3.1.11.2 Conformance requirements

References: The conformance requirements covered in the present TC are specified in: TS 36.331, clause 5.3.5.4, 5.3.5.6, 5.3.7.2 and 5.5.6.1.

[TS 36.331,clause 5.3.5.4]

If the *RRCConnectionReconfiguration* message includes the *mobilityControlInfo* and the UE is able to comply with the configuration included in this message, the UE shall:

- 1> stop timer T310, if running;
- 1> start timer T304 with the timer value set to *t304*, as included in the *mobilityControlInfo*;
- 1> if the *carrierFreq* is included:
 - 2> consider the target cell to be one on the frequency indicated by the *carrierFreq* with a physical cell identity indicated by the *targetPhysCellId*;
- 1> else:
 - 2> consider the target cell to be one on the current frequency with a physical cell identity indicated by the *targetPhysCellId*;
- 1> start synchronising to the DL of the target cell;

NOTE 1: The UE should perform the handover as soon as possible following the reception of the RRC message triggering the handover, which could be before confirming successful reception (HARQ and ARQ) of this message.

- 1> reset MAC;
- 1> re-establish PDCP for all RBs that are established;

NOTE 2: The handling of the radio bearers after the successful completion of the PDCP re-establishment, e.g. the re-transmission of unacknowledged PDCP SDUs (as well as the associated status reporting), the handling of the SN and the HFN, is specified in TS 36.323 [8].

- 1> re-establish RLC for all RBs that are established;

- 1> apply the value of the *newUE-Identity* as the C-RNTI;
- 1> configure lower layers in accordance with the received *radioResourceConfigCommon*;
- 1> if the *RRCConnectionReconfiguration* message includes the *radioResourceConfigDedicated*:
 - 2> perform the radio resource configuration procedure as specified in 5.3.10;
 - ...
- 1> if the *RRCConnectionReconfiguration* message includes the *measConfig*:
 - 2> perform the measurement configuration procedure as specified in 5.5.2;
- 1> submit the *RRCConnectionReconfigurationComplete* message to lower layers for transmission;
- 1> if MAC successfully completes the random access procedure:
 - 2> stop timer T304;
 - 2> apply the parts of the configuration that do not require the UE to know the SFN of the target cell;
 - 2> apply the parts of the measurement and the radio resource configuration that require the UE to know the SFN of the target cell (e.g. measurement gaps, periodic CQI reporting, scheduling request configuration, sounding RS configuration), if any, upon acquiring the SFN of the target cell;
 - 2> the procedure ends;

NOTE 3: The UE is not required to determine the SFN of the target cell by acquiring system information from that cell before performing RACH access in the target cell.

[TS 36.331,clause 5.3.5.6]

The UE shall:

- 1> if T304 expires (handover failure):

NOTE: Following T304 expiry any dedicated preamble, if provided within the *rach-ConfigDedicated*, is not available for use by the UE anymore.

- 2> revert back to the configuration used in the source cell, excluding the configuration configured by the *physicalConfigDedicated*, the *mac-MainConfig* and the *sps-Config*;
- 2> initiate the connection re-establishment procedure as specified in 5.3.7, upon which the RRC connection reconfiguration procedure ends;

[TS 36.331,clause 5.3.7.2]

The UE shall only initiate the procedure when AS security has been activated. The UE initiates the procedure when one of the following conditions is met:

- 1> upon detecting radio link failure, in accordance with 5.3.11; or
- 1> upon handover failure, in accordance with 5.3.5.6; or
- 1> upon mobility from E-UTRA failure, in accordance with 5.4.3.5; or
- 1> upon integrity check failure indication from lower layers; or
- 1> upon an RRC connection reconfiguration failure, in accordance with 5.3.5.5;

Upon initiation of the procedure, the UE shall:

- 1> stop timer T310, if running;
- 1> start timer T311;
- 1> suspend all RBs except SRB0;

- 1> reset MAC;
- 1> apply the default physical channel configuration as specified in 9.2.4;
- 1> apply the default semi-persistent scheduling configuration as specified in 9.2.3;
- 1> apply the default MAC main configuration as specified in 9.2.2;
- 1> perform cell selection in accordance with the cell selection process as specified in TS 36.304 [4];

[TS 36.331, clause 5.5.6.1]

E-UTRAN applies the re-establishment procedure as follows:

- when performing the connection re-establishment procedure, as specified in 5.3.7, ensure that a *measObjectId* corresponding to the target carrier frequency is configured as a result of the procedure described in this sub-clause and the subsequent connection reconfiguration procedure immediately following the re-establishment procedure;

The UE shall:

- 1> for each *measId* included in the *measIdList* within *VarMeasConfig*:
 - 2> if the *triggerType* is set to 'periodical':
 - 3> remove this *measId* from the *measIdList* within *VarMeasConfig*;
 - 1> if the procedure was triggered due to inter-frequency handover or successful re-establishment to an inter-frequency cell, update the *measId* values in the *measIdList* within *VarMeasConfig* as follows:
 - 2> if a *measObjectId* value corresponding to the target carrier frequency exists in the *measObjectIdList* within *VarMeasConfig*:
 - 3> for each *measId* value in the *measIdList*:
 - 4> if the *measId* value is linked to the *measObjectId* value corresponding to the source carrier frequency:
 - 5> link this *measId* value to the *measObjectId* value corresponding to the target carrier frequency;
 - 4> else if the *measId* value is linked to the *measObjectId* value corresponding to the target carrier frequency:
 - 5> link this *measId* value to the *measObjectId* value corresponding to the source carrier frequency;
 - 2> else:
 - 3> remove all *measId* values that are linked to the *measObjectId* value corresponding to the source carrier frequency;
- 1> remove all measurement reporting entries within *VarMeasReportList*;
- 1> reset the periodical reporting timer or timer T321, whichever one is running, as well as associated information (e.g. *timeToTrigger*) for all *measId*;
- 1> release the measurement gaps, if activated;

NOTE: If the UE requires measurement gaps to perform inter-frequency or inter-RAT measurements, the UE resumes the inter-frequency and inter-RAT measurements after the E-UTRAN has setup the measurement gaps.

8.3.1.11.3 Test description

8.3.1.11.3.1 Pre-test conditions

System Simulator:

- Cell 1, Cell 2 and Cell 3.

- System information combination 3 as defined in TS 36.508 [18] clause 4.4.3.1 is used in E-UTRA cells.

UE:

None.

Preamble:

- The UE is in state Generic RB Established (state 3) on Cell 1 according to [18].

8.3.1.11.3.2 Test procedure sequence

Table 8.3.1.11.3.2-1 illustrates the downlink power levels and other changing parameters to be applied for the cells at various time instants of the test execution. Row marked "T0" denotes the initial conditions after preamble, while columns marked "T1", "T2", "T3", "T4", "T5" are to be applied subsequently. The exact instants on which these values shall be applied are described in the texts in this clause.

Table 8.3.1.11.3.2-1: Time instances of cell power levels

	Parameter	Unit	Cell 1	Cell 2	Cell 3 (DL only)	Remark
T0	Cell-specific RS EPRE	dBm/15 kHz	-85	"off"	"off"	
T1	Cell-specific RS EPRE	dBm/15 kHz	-85	"off"	-73	The power level values are such that measurement results for Cell 1 (M1) and Cell 3 (M3) satisfy entry condition for event A3 (M3 - Hys > M1).
T2	Cell-specific RS EPRE	dBm/15 kHz	-85	-79	"off"	The power level values are such that measurement results for Cell 1 (M1) and Cell 2 (M2) satisfy entry condition for event A3 (M2 - Hys > M1).
T3	Cell-specific RS EPRE	dBm/15 kHz	"off"	-79	"off"	The power level values are assigned values to satisfy $Srxlev_{Cell\ 1} < 0$ and $Srxlev_{Cell\ 3} < 0$ such that selecting Cell 2 is guaranteed
T4	Cell-specific RS EPRE	dBm/15 kHz	-79	-85	"off"	The power level values are such that measurement results for Cell 2 (M2) and Cell 1 (M1) satisfy entry condition for event A3 (M1 - Hys > M2).
T5	Cell-specific RS EPRE	dBm/15 kHz	"off"	-85	-73	The power level values are such that measurement results for Cell 2 (M2) and Cell 3 (M3) satisfy entry condition for event A3 (M3 - Hys > M2).

Table 8.3.1.11.3.2-2: Main behaviour

St	Procedure	Message Sequence		TP	Verdict
		U - S	Message		
1	The SS transmits an <i>RRCCConnectionReconfiguration</i> message to setup intra and inter frequency measurements on Cell 1.	<--	<i>RRCCConnectionReconfiguration</i>	-	-
2	The UE transmits an <i>RRCCConnectionReconfigurationComplete</i> message to confirm the setup of intra and inter frequency measurements on Cell 1.	-->	<i>RRCCConnectionReconfigurationComplete</i>	-	-
-	EXCEPTION: Steps 3a1 to 3a2 describe behaviour that depends on the UE capability; the "lower case letter" identifies a step sequence that takes place if a capability is supported.	-	-	-	-
3a1	IF <i>pc_FeatGrp_25</i> THEN the SS changes Cell 3 power levels according to the row "T1" in Table 8.3.1.11.3.2-1.	-	-	-	-
3a2	The UE transmits a <i>MeasurementReport</i> message on Cell 1 to report event A3 for Cell 3.	-->	<i>MeasurementReport</i>	-	-
4	The SS changes Cell 2 and Cell 3 power levels according to the row "T2" in Table 8.3.1.11.3.2-1.	-	-	-	-
5	The UE transmits a <i>MeasurementReport</i> message on Cell 1 to perform event A3 intra frequency reporting for Cell 2.	-->	<i>MeasurementReport</i>	-	-
6	The SS transmits an <i>RRCCConnectionReconfiguration</i> message including a <i>mobilityControlInfo</i> , to order the UE to perform intra frequency handover to Cell 2.	<--	<i>RRCCConnectionReconfiguration</i>	-	-
-	EXCEPTION: In parallel to the events described in step 7 the steps specified in Table 8.3.1.11.3.2-3 should take place.	-	-	-	-
7	The SS changes Cell 1 power levels according to the row "T3" in Table 8.3.1.11.3.2-1.	-	-	-	-
8	Check: Does the UE transmit an <i>RRCCConnectionReestablishmentRequest</i> message on Cell 2?	-->	<i>RRCCConnectionReestablishmentRequest</i>	1,2	P
9	The SS transmits an <i>RRCCConnectionReestablishment</i> message to resume SRB1 operation and re-activate security on Cell 2.	<--	<i>RRCCConnectionReestablishment</i>	-	-
10	The UE transmits an <i>RRCCConnectionReestablishmentComplete</i> message on Cell 2.	-->	<i>RRCCConnectionReestablishmentComplete</i>	-	-
11	The SS transmits an <i>RRCCConnectionReconfiguration</i> message to resume existing radio bearer on Cell 2.	<--	<i>RRCCConnectionReconfiguration</i>	-	-
12	The UE transmits an <i>RRCCConnectionReconfigurationComplete</i> message on Cell 2.	-->	<i>RRCCConnectionReconfigurationComplete</i>	-	-
13	The SS changes Cell 1 and Cell 2 power levels according to the row "T4" in Table 8.3.1.11.3.2-1.	-	-	-	-
14	Check: Does the UE transmit a <i>MeasurementReport</i> message on Cell 2 to perform event A3 intra frequency reporting for Cell 1?	-->	<i>MeasurementReport</i>	1	P
-	EXCEPTION: Steps 15a1 to 15a4 describe behaviour that depends on the UE capability; the "lower case letter" identifies a step sequence that takes place if a capability is supported.	-	-	-	-
15a1	IF <i>pc_FeatGrp_25</i> THEN the SS transmits an <i>RRCCConnectionReconfiguration</i> message to	<--	<i>RRCCConnectionReconfiguration</i>	-	-

	activate the measurement gaps on Cell 2.				
15a2	The UE transmits an <i>RRCConnectionReconfigurationComplete</i> message to confirm the activation of the measurement gaps on Cell 2.	-->	<i>RRCConnectionReconfigurationComplete</i>	-	-
15a3	The SS changes Cell 1 and Cell 3 power levels according to the row "T5" in Table 8.3.1.11.3.2-1.	-	-	-	-
15a4	Check: Does the UE transmit a <i>MeasurementReport</i> message on Cell 2 to report event A3 for Cell 3?	-->	<i>MeasurementReport</i>	2	P
16	Check: Does the test result of CALL generic test procedure in 36.508 subclause 6.2.4.3 indicate that the UE is in E-UTRA RRC_CONNECTED state on Cell 2?	-	-	1,2	-

Table 8.3.1.11.3.2-3: Parallel behaviour

St	Procedure	Message Sequence		TP	Verdict
		U - S	Message		
-	EXCEPTION: The steps 1 and 2 below are repeated for the duration of T304.	-	-	-	-
1	The UE attempts to perform the intra frequency handover using MAC Random Access Preamble on Cell 2.	-	-	-	-
2	The SS does not respond.	-	-	-	-

8.3.1.11.3.3 Specific message contents

Table 8.3.1.11.3.3-1: *RRCConnectionReconfiguration* (step 1, Table 8.3.1.11.3.2-2)

Derivation Path: 36.508, Table 4.6.1-8, condition MEAS
--

Table 8.3.1.11.3.3-2: *MeasConfig* (step 1, Table 8.3.1.11.3.2-2)

Derivation Path: 36.508, Table 4.6.6-1, condition INTER-FREQ			
Information Element	Value/remark	Comment	Condition
MeasConfig ::= SEQUENCE {			
measObjectToAddModList SEQUENCE (SIZE (1..maxObjectId)) OF SEQUENCE {	2 entries		
measObjectId[1]	IdMeasObject-f1		
measObject[1]	MeasObjectEUTRA-GENERIC(f1)		
measObjectId[2]	IdMeasObject-f2		pc_FeatrGrp_25
measObject[2]	MeasObjectEUTRA-GENERIC(f2)		pc_FeatrGrp_25
}			
reportConfigToAddModList SEQUENCE (SIZE (1..maxReportConfigId)) OF SEQUENCE {	1 entry		
reportConfigId[1]	IdReportConfig-A3		
reportConfig[1]	ReportConfigEUTRA-A3		
}			
measIdToAddModList SEQUENCE (SIZE (1..maxMeasId)) OF SEQUENCE {	2 entries		
measId[1]	1		
measObjectId[1]	IdMeasObject-f1		
reportConfigId[1]	IdReportConfig-A3		
measId[2]	2		pc_FeatrGrp_25
measObjectId[2]	IdMeasObject-f2		pc_FeatrGrp_25
reportConfigId[2]	IdReportConfig-A3		pc_FeatrGrp_25
}			
}			

Table 8.3.1.11.3.3-3: Void

Table 8.3.1.11.3.3-4: *MeasurementReport* (step 3a2, Table 8.3.1.11.3.2-2)

Derivation Path: 36.508, Table 4.6.1-5			
Information Element	Value/remark	Comment	Condition
MeasurementReport ::= SEQUENCE {			
criticalExtensions CHOICE {			
c1 CHOICE{			
measurementReport-r8 SEQUENCE {			
measResults SEQUENCE {			
measId	2		
measResultServCell SEQUENCE {			
rsrpResult	(0..97)		
rsrqResult	(0..34)		
}			
measResultNeighCells CHOICE {			
measResultListEUTRA SEQUENCE (SIZE (1..maxCellReport)) OF SEQUENCE {	1 entry		
physCellId[1]	PhysicalCellIdentity of Cell 3		
cgi-Info[1]	Not present		
measResult[1] SEQUENCE {			
rsrpResult	(0..97)		
rsrqResult	(0..34)		
}			
}			
}			
}			
}			
}			

Table 8.3.1.11.3.3-5: MeasurementReport (step 5, Table 8.3.1.11.3.2-2)

Derivation Path: 36.508, Table 4.6.1-5			
Information Element	Value/remark	Comment	Condition
MeasurementReport ::= SEQUENCE {			
criticalExtensions CHOICE {			
c1 CHOICE{			
measurementReport-r8 SEQUENCE {			
measResults SEQUENCE {			
measId	1		
measResultServCell SEQUENCE {			
rsrpResult	(0..97)		
rsrqResult	(0..34)		
}			
measResultNeighCells CHOICE {			
measResultListEUTRA SEQUENCE (SIZE (1..maxCellReport)) OF SEQUENCE {	1 entry		
physCellId[1]	PhysicalCellIdentity of Cell 2		
cgi-Info[1]	Not present		
measResult[1] SEQUENCE {			
rsrpResult	(0..97)		
rsrqResult	(0..34)		
}			
}			
}			
}			
}			
}			

Table 8.3.1.11.3.3-6: RRCConnectionReconfiguration (step 6, Table 8.3.1.11.3.2-2)

Derivation Path: 36.508, Table 4.6.1-8, condition HO
--

Table 8.3.1.11.3.3-7: MobilityControlInfo (step 6, Table 8.1.3.11.3.2-2)

Derivation Path: 36.508, Table 4.6.5-1			
Information Element	Value/remark	Comment	Condition
MobilityControlInfo ::= SEQUENCE {			
targetPhysCellId	PhysicalCellIdentity of Cell 2		
carrierFreq	Not present		
}			

Table 8.3.1.11.3.3-8: RRCConnectionReestablishmentRequest (step 8, Table 8.3.1.11.3.2-2)

Derivation Path: 36.508, Table 4.6.1-13			
Information Element	Value/remark	Comment	Condition
RRCConnectionReestablishmentRequest ::= SEQUENCE {			
criticalExtensions CHOICE {			
rrcConnectionReestablishmentRequest-r8			
SEQUENCE {			
ue-Identity SEQUENCE {			
c-RNTI	the value of the C-RNTI of the UE		
physCellId	PhysicalCellIdentity of Cell 1		
shortMAC-I	The same value as the 16 least significant bits of the XMAC-I value calculated by SS.		
}			
reestablishmentCause	handoverFailure		
}			
}			

Table 8.3.1.11.3.3-9: RRCConnectionReestablishment (step 9, Table 8.3.1.11.3.2-2)

Derivation Path: 36.508, Table 4.6.1-10			
Information Element	Value/remark	Comment	Condition
RRCConnectionReestablishment ::= SEQUENCE {			
criticalExtensions CHOICE {			
c1 CHOICE{			
rrcConnectionReestablishment-r8 SEQUENCE {			
nextHopChainingCount	0		
}			
}			
}			
}			

Table 8.3.1.11.3.3-10: RRCConnectionReconfiguration (step 11, Table 8.3.1.11.3.2-2)

Derivation Path: 36.508, Table 4.6.1-8			
Information Element	Value/remark	Comment	Condition
RRCConnectionReconfiguration ::= SEQUENCE {			
criticalExtensions CHOICE {			
c1 CHOICE{			
rrcConnectionReconfiguration-r8 SEQUENCE {			
radioResourceConfigDedicated	RadioResourceConfigDedicated-HO		
}			
}			
}			
}			

Table 8.3.1.11.3.3-11: MeasurementReport (step 14, Table 8.3.1.11.3.2-2)

Derivation Path: 36.508, Table 4.6.1-5			
Information Element	Value/remark	Comment	Condition
MeasurementReport ::= SEQUENCE {			
criticalExtensions CHOICE {			
c1 CHOICE{			
measurementReport-r8 SEQUENCE {			
measResults SEQUENCE {			
measId	1		
measResultServCell SEQUENCE {			
rsrpResult	(0..97)		
rsrqResult	(0..34)		
}			
measResultNeighCells CHOICE {			
measResultListEUTRA SEQUENCE (SIZE (1..maxCellReport)) OF SEQUENCE {	1 entry		
physCellId[1]	PhysicalCellIdentity of Cell 1		
cgi-Info[1]	Not present		
measResult[1] SEQUENCE {			
rsrpResult	(0..97)		
rsrqResult	(0..34)		
}			
}			
}			
}			
}			
}			

Table 8.3.1.11.3.3-12: RRCConnectionReconfiguration (step 15a1, Table 8.3.1.11.3.2-2)

Derivation Path: 36.508, Table 4.6.1-8 condition MEAS

Table 8.3.1.11.3.3-13: MeasConfig (step 15a1, Table 8.3.1.11.3.2-2)

Derivation Path: 36.508, Table 4.6.6-1, condition INTER-FREQ

Table 8.3.1.11.3.3-14: MeasurementReport (step 15a4, Table 8.3.1.11.3.2-2)

Derivation Path: 36.508, Table 4.6.1-5			
Information Element	Value/remark	Comment	Condition
MeasurementReport ::= SEQUENCE {			
criticalExtensions CHOICE {			
c1 CHOICE{			
measurementReport-r8 SEQUENCE {			
measResults SEQUENCE {			
measId	2		
measResultServCell SEQUENCE {			
rsrpResult	(0..97)		
rsrqResult	(0..34)		
}			
measResultNeighCells CHOICE {			
measResultListEUTRA SEQUENCE (SIZE (1..maxCellReport)) OF SEQUENCE {	1 entry		
physCellId[1]	PhysicalCellIdentity of Cell 3		
cgi-Info[1]	Not present		
measResult[1] SEQUENCE {			
rsrpResult	(0..97)		
rsrqResult	(0..34)		
}			
}			
}			
}			
}			
}			

Table 8.3.1.11.3.3-15: SystemInformationBlockType2 for Cell 1, cell 2 and Cell 3 (preamble and all the steps in Table 8.3.1.11.3.2-2)

Derivation Path: 36.508, Table 4.6.3-12			
Information Element	Value/remark	Comment	Condition
ra-SupervisionInfo SEQUENCE {			
preambleTransMax	n50		
}			

8.3.1.11a Measurement configuration control and reporting / Intra Frequency measurements / Continuation of the measurements after RRC connection re-establishment / Single Frequency operation

8.3.1.11a.1 Test Purpose (TP)

(1)

```
with { UE having completed the radio bearer establishment, initial security activation procedure and performed the intra frequency measurement and after receiving an RRCConnectionReconfiguration message including a mobilityControlInfo indicating a different E-UTRA cell having attempted intra frequency handover}
ensure that {
  when { UE detects handover failure and the intra frequency cell is selectable }
  then { UE performs RRC Connection Re-establishment, continues the intra frequency measurement }
}
```

8.3.1.11a.2 Conformance requirements

References: The conformance requirements covered in the present TC are specified in: TS 36.331, clause 5.3.5.4, 5.3.5.6, 5.3.7.2 and 5.5.6.1.

[TS 36.331, clause 5.3.5.4]

If the *RRCCConnectionReconfiguration* message includes the *mobilityControlInfo* and the UE is able to comply with the configuration included in this message, the UE shall:

- 1> stop timer T310, if running;
- 1> start timer T304 with the timer value set to *t304*, as included in the *mobilityControlInfo*;
- 1> if the *carrierFreq* is included:
 - 2> consider the target cell to be one on the frequency indicated by the *carrierFreq* with a physical cell identity indicated by the *targetPhysCellId*;
- 1> else:
 - 2> consider the target cell to be one on the current frequency with a physical cell identity indicated by the *targetPhysCellId*;

- 1> start synchronising to the DL of the target cell;

NOTE 1: The UE should perform the handover as soon as possible following the reception of the RRC message triggering the handover, which could be before confirming successful reception (HARQ and ARQ) of this message.

- 1> reset MAC;
- 1> re-establish PDCP for all RBs that are established;

NOTE 2: The handling of the radio bearers after the successful completion of the PDCP re-establishment, e.g. the re-transmission of unacknowledged PDCP SDUs (as well as the associated status reporting), the handling of the SN and the HFN, is specified in TS 36.323 [8].

- 1> re-establish RLC for all RBs that are established;
- 1> apply the value of the *newUE-Identity* as the C-RNTI;
- 1> configure lower layers in accordance with the received *radioResourceConfigCommon*;
- 1> if the *RRCCConnectionReconfiguration* message includes the *radioResourceConfigDedicated*:
 - 2> perform the radio resource configuration procedure as specified in 5.3.10;

...

- 1> if the *RRCCConnectionReconfiguration* message includes the *measConfig*:
 - 2> perform the measurement configuration procedure as specified in 5.5.2;
- 1> submit the *RRCCConnectionReconfigurationComplete* message to lower layers for transmission;
- 1> if MAC successfully completes the random access procedure:
 - 2> stop timer T304;
 - 2> apply the parts of the configuration that do not require the UE to know the SFN of the target cell;
 - 2> apply the parts of the measurement and the radio resource configuration that require the UE to know the SFN of the target cell (e.g. measurement gaps, periodic CQI reporting, scheduling request configuration, sounding RS configuration), if any, upon acquiring the SFN of the target cell;
 - 2> the procedure ends;

NOTE 3: The UE is not required to determine the SFN of the target cell by acquiring system information from that cell before performing RACH access in the target cell.

[TS 36.331, clause 5.3.5.6]

The UE shall:

1> if T304 expires (handover failure):

NOTE: Following T304 expiry any dedicated preamble, if provided within the *rach-ConfigDedicated*, is not available for use by the UE anymore.

2> revert back to the configuration used in the source cell, excluding the configuration configured by the *physicalConfigDedicated*, the *mac-MainConfig* and the *sps-Config*;

2> initiate the connection re-establishment procedure as specified in 5.3.7, upon which the RRC connection reconfiguration procedure ends;

[TS 36.331, clause 5.3.7.2]

The UE shall only initiate the procedure when AS security has been activated. The UE initiates the procedure when one of the following conditions is met:

1> upon detecting radio link failure, in accordance with 5.3.11; or

1> upon handover failure, in accordance with 5.3.5.6; or

1> upon mobility from E-UTRA failure, in accordance with 5.4.3.5; or

1> upon integrity check failure indication from lower layers; or

1> upon an RRC connection reconfiguration failure, in accordance with 5.3.5.5;

Upon initiation of the procedure, the UE shall:

1> stop timer T310, if running;

1> start timer T311;

1> suspend all RBs except SRB0;

1> reset MAC;

1> apply the default physical channel configuration as specified in 9.2.4;

1> apply the default semi-persistent scheduling configuration as specified in 9.2.3;

1> apply the default MAC main configuration as specified in 9.2.2;

1> perform cell selection in accordance with the cell selection process as specified in TS 36.304 [4];

[TS 36.331, clause 5.5.6.1]

E-UTRAN applies the re-establishment procedure as follows:

- when performing the connection re-establishment procedure, as specified in 5.3.7, ensure that a *measObjectId* corresponding to the target carrier frequency is configured as a result of the procedure described in this sub-clause and the subsequent connection reconfiguration procedure immediately following the re-establishment procedure;

The UE shall:

1> for each *measId* included in the *measIdList* within *VarMeasConfig*:

2> if the *triggerType* is set to 'periodical':

3> remove this *measId* from the *measIdList* within *VarMeasConfig*;

1> if the procedure was triggered due to inter-frequency handover or successful re-establishment to an inter-frequency cell, update the *measId* values in the *measIdList* within *VarMeasConfig* as follows:

2> if a *measObjectId* value corresponding to the target carrier frequency exists in the *measObjectList* within *VarMeasConfig*:

3> for each *measId* value in the *measIdList*:

- 4> if the *measId* value is linked to the *measObjectId* value corresponding to the source carrier frequency:
 - 5> link this *measId* value to the *measObjectId* value corresponding to the target carrier frequency;
- 4> else if the *measId* value is linked to the *measObjectId* value corresponding to the target carrier frequency:
 - 5> link this *measId* value to the *measObjectId* value corresponding to the source carrier frequency;

2> else:

- 3> remove all *measId* values that are linked to the *measObjectId* value corresponding to the source carrier frequency;

1> remove all measurement reporting entries within *VarMeasReportList*;

1> reset the periodical reporting timer or timer T321, whichever one is running, as well as associated information (e.g. *timeToTrigger*) for all *measId*;

1> release the measurement gaps, if activated;

NOTE: If the UE requires measurement gaps to perform inter-frequency or inter-RAT measurements, the UE resumes the inter-frequency and inter-RAT measurements after the E-UTRAN has setup the measurement gaps.

8.3.1.11a.3 Test description

8.3.1.11a.3.1 Pre-test conditions

System Simulator:

- Cell 1 and Cell 2.
- System information combination 2 as defined in TS 36.508 [18] clause 4.4.3.1 is used in E-UTRA cells.

UE:

None.

Preamble:

- The UE is in state Generic RB Established (state 3) on Cell 1 according to [18].

8.3.1.11a.3.2 Test procedure sequence

Table 8.3.1.11a.3.2-1 illustrates the downlink power levels and other changing parameters to be applied for the cells at various time instants of the test execution. Row marked "T0" denotes the initial conditions after preamble, while columns marked "T1", "T2", and "T3" are to be applied subsequently. The exact instants on which these values shall be applied are described in the texts in this clause.

Table 8.3.1.11a.3.2-1: Time instances of cell power levels

	Parameter	Unit	Cell 1	Cell 2	Remark
T0	Cell-specific RS EPRE	dBm/15 kHz	-85	"off"	
T1	Cell-specific RS EPRE	dBm/15 kHz	-85	-79	The power level values are such that measurement results for Cell 1 (M1) and Cell 2 (M2) satisfy entry condition for event A3 ($M2 - Hys > M1$).
T2	Cell-specific RS EPRE	dBm/15 kHz	"off"	-79	The power level values are assigned values to satisfy $SrxlevCell 1 < 0$ such that selecting Cell 2 is guaranteed
T3	Cell-specific RS EPRE	dBm/15 kHz	-79	-85	The power level values are such that measurement results for Cell 2 (M2) and Cell 1 (M1) satisfy entry condition for event A3 ($M1 - Hys > M2$).

Table 8.3.1.11a.3.2-2: Main behaviour

St	Procedure	Message Sequence		TP	Verdict
		U - S	Message		
1	The SS transmits an <i>RRConnectionReconfiguration</i> message to setup intra frequency measurements on Cell 1.	<--	<i>RRConnectionReconfiguration</i>	-	-
2	The UE transmits an <i>RRConnectionReconfigurationComplete</i> message to confirm the setup of intra frequency measurements on Cell 1.	-->	<i>RRConnectionReconfigurationComplete</i>	-	-
3	The SS changes Cell 2 power levels according to the row "T1" in Table 8.3.1.11a.3.2-1.	-	-	-	-
4	The UE transmits a <i>MeasurementReport</i> message on Cell 1 to perform event A3 intra frequency reporting for Cell 2.	-->	<i>MeasurementReport</i>	-	-
5	The SS transmits an <i>RRConnectionReconfiguration</i> message including a <i>mobilityControlInfo</i> , to order the UE to perform intra frequency handover to Cell 2.	<--	<i>RRConnectionReconfiguration</i>	-	-
-	EXCEPTION: In parallel to the events described in step 6 the steps specified in Table 8.3.1.11a.3.2-3 should take place.	-	-	-	-
6	The SS changes Cell 1 power levels according to the row "T2" in Table 8.3.1.11a.3.2-1.	-	-	-	-
7	Check: Does the UE transmit an <i>RRConnectionReestablishmentRequest</i> message on Cell 2?	-->	<i>RRConnectionReestablishmentRequest</i>	1	P
8	The SS transmits an <i>RRConnectionReestablishment</i> message to resume SRB1 operation and re-activate security on Cell 2.	<--	<i>RRConnectionReestablishment</i>	-	-
9	The UE transmits an <i>RRConnectionReestablishmentComplete</i> message on Cell 2.	-->	<i>RRConnectionReestablishmentComplete</i>	-	-
10	The SS transmits an <i>RRConnectionReconfiguration</i> message to resume existing radio bearer on Cell 2.	<--	<i>RRConnectionReconfiguration</i>	-	-
11	The UE transmits an <i>RRConnectionReconfigurationComplete</i> message on Cell 2.	-->	<i>RRConnectionReconfigurationComplete</i>	-	-
12	The SS changes Cell 1 and Cell 2 power levels according to the row "T3" in Table 8.3.1.11a.3.2-1.	-	-	-	-
13	Check: Does the UE transmit a <i>MeasurementReport</i> message on Cell 2 to perform event A3 intra frequency reporting for Cell 1?	-->	<i>MeasurementReport</i>	1	P
14	Check: Does the test result of CALL generic test procedure in 36.508 subclause 6.4.2.3 indicate that the UE is in E-UTRA RRC_CONNECTED state on Cell 2?	-	-	1	-

Table 8.3.1.11a.3.2-3: Parallel behaviour

St	Procedure	Message Sequence		TP	Verdict
		U - S	Message		
-	EXCEPTION: The steps 1 and 2 below are repeated for the duration of T304.	-	-	-	-
1	The UE attempts to perform the intra frequency handover using MAC Random Access Preamble on Cell 2.	-	-	-	-
2	The SS does not respond.	-	-	-	-

8.3.1.11a.3.3 Specific message contents

Table 8.3.1.11a.3.3-1: RRCConnectionReconfiguration (step 1, Table 8.3.1.11a.3.2-2)

Derivation Path: 36.508, Table 4.6.1-8, condition MEAS

Table 8.3.1.11a.3.3-2: MeasConfig (step 1, Table 8.3.1.11a.3.2-2)

Derivation Path: 36.508, Table 4.6.6-1,			
Information Element	Value/remark	Comment	Condition
MeasConfig ::= SEQUENCE {			
measObjectToAddModList SEQUENCE (SIZE (1..maxObjectId)) OF SEQUENCE {	1 entry		
measObjectId[1]	IdMeasObject-f1		
measObject[1]	MeasObjectEUTRA-GENERIC(f1)		
}			
reportConfigToAddModList SEQUENCE (SIZE (1..maxReportConfigId)) OF SEQUENCE {	1 entry		
reportConfigId[1]	IdReportConfig-A3		
reportConfig[1]	ReportConfigEUTRA-A3		
}			
measIdToAddModList SEQUENCE (SIZE (1..maxMeasId)) OF SEQUENCE {	1 entry		
measId[1]	1		
measObjectId[1]	IdMeasObject-f1		
reportConfigId[1]	IdReportConfig-A3		
}			
}			

Table 8.3.1.11a.3.3-3: MeasurementReport (step 4, Table 8.3.1.11a.3.2-2)

Derivation Path: 36.508, Table 4.6.1-5			
Information Element	Value/remark	Comment	Condition
MeasurementReport ::= SEQUENCE {			
criticalExtensions CHOICE {			
c1 CHOICE{			
measurementReport-r8 SEQUENCE {			
measResults SEQUENCE {			
measId	1		
measResultServCell SEQUENCE {			
rsrpResult	(0..97)		
rsrqResult	(0..34)		
}			
measResultNeighCells CHOICE {			
measResultListEUTRA SEQUENCE (SIZE (1..maxCellReport)) OF SEQUENCE {	1 entry		
physCellId[1]	PhysicalCellIdentity of Cell 2		
cgi-Info[1]	Not present		
measResult[1] SEQUENCE {			
rsrpResult	(0..97)		
rsrqResult	(0..34)		
}			
}			
}			
}			
}			
}			
}			
}			

Table 8.3.1.11a.3.3-4: RRCConnectionReconfiguration (step 6, Table 8.3.1.11a.3.2-2)

Derivation Path: 36.508, Table 4.6.1-8, condition HO

Table 8.3.1.11a.3.3-5: MobilityControlInfo (step 6, Table 8.1.3.11.3.2-2)

Derivation Path: 36.508, Table 4.6.5-1			
Information Element	Value/remark	Comment	Condition
MobilityControlInfo ::= SEQUENCE {			
targetPhysCellId	PhysicalCellId of Cell 2		
carrierFreq	Not present		
}			

Table 8.3.1.11a.3.3-6: RRCConnectionReestablishmentRequest (step 7, Table 8.3.1.11a.3.2-2)

Derivation Path: 36.508, Table 4.6.1-13			
Information Element	Value/remark	Comment	Condition
RRCConnectionReestablishmentRequest ::= SEQUENCE {			
criticalExtensions CHOICE {			
rrcConnectionReestablishmentRequest-r8			
SEQUENCE {			
ue-Identity SEQUENCE {			
c-RNTI	the value of the C-RNTI of the UE		
physCellId	PhysicalCellId of Cell 1		
shortMAC-I	The same value as the 16 least significant bits of the XMAC-I value calculated by SS.		
}			
reestablishmentCause	handoverFailure		
}			
}			

Table 8.3.1.11a.3.3-7: RRCConnectionReestablishment (step 8, Table 8.3.1.11a.3.2-2)

Derivation Path: 36.508, Table 4.6.1-10			
Information Element	Value/remark	Comment	Condition
RRCConnectionReestablishment ::= SEQUENCE {			
criticalExtensions CHOICE {			
c1 CHOICE {			
rrcConnectionReestablishment-r8 SEQUENCE {			
nextHopChainingCount	0		
}			
}			
}			
}			

Table 8.3.1.11a.3.3-8: RRCConnectionReconfiguration (step 10, Table 8.3.1.11a.3.2-2)

Derivation Path: 36.508, Table 4.6.1-8			
Information Element	Value/remark	Comment	Condition
RRCConnectionReconfiguration ::= SEQUENCE {			
criticalExtensions CHOICE {			
c1 CHOICE{			
rrcConnectionReconfiguration-r8 SEQUENCE {			
radioResourceConfigDedicated	RadioResourceConfigDe dicated-HO		
}			
}			
}			
}			

Table 8.3.1.11a.3.3-9: MeasurementReport (step 13, Table 8.3.1.11a.3.2-2)

Derivation Path: 36.508, Table 4.6.1-5			
Information Element	Value/remark	Comment	Condition
MeasurementReport ::= SEQUENCE {			
criticalExtensions CHOICE {			
c1 CHOICE{			
measurementReport-r8 SEQUENCE {			
measResults SEQUENCE {			
measId	1		
measResultServCell SEQUENCE {			
rsrpResult	(0..97)		
rsrqResult	(0..34)		
}			
measResultNeighCells CHOICE {			
measResultListEUTRA SEQUENCE (SIZE (1..maxCellReport)) OF SEQUENCE {	1 entry		
physCellId[1]	PhysicalCellId of Cell 1		
cgi-Info[1]	Not present		
measResult[1] SEQUENCE {			
rsrpResult	(0..97)		
rsrqResult	(0..34)		
}			
}			
}			
}			
}			
}			

8.3.1.12 Measurement configuration control and reporting / Intra E-UTRAN measurements / Two simultaneous events A3 (inter-band measurements)

8.3.1.12.1 Test Purpose (TP)

(1)

```

with { UE in E-UTRA RRC_CONNECTED state and measurements configured for two event A3 at the same
time}
ensure that {
  when { Neighbour becomes offset better than serving }
  then { UE sends MeasurementReport with correct measId for event A3 }
}

```

8.3.1.12.2 Conformance requirements

References: The conformance requirements covered in the current TC are specified in: TS 36.331, clauses 5.3.5.3, 5.5.4.1, 5.5.4.4 and 5.5.5.

[TS 36.331, clause 5.3.5.3]

If the *RRCConnectionReconfiguration* message does not include the *mobilityControlInfo* and the UE is able to comply with the configuration included in this message, the UE shall:

...

- 1> If the *RRCConnectionReconfiguration* message includes the *measConfig*:
 - 2> perform the Measurement configuration procedure as specified in 5.5.2;

...

[TS 36.331, clause 5.5.4.1]

The UE shall:

- 1> for each *measId* included in the *measIdList* within *VarMeasConfig*:
 - 2> if the corresponding *reportConfig* includes a purpose set to ‘*reportStrongestCellsForSON*’:
 - 3> consider any neighbouring cell detected on the associated frequency to be applicable;
 - 2> else if the corresponding *reportConfig* includes a purpose set to ‘*reportCGI*’:
 - 3> consider any neighbouring cell detected on the associated frequency/ set of frequencies (GERAN) which has a physical cell identity matching the value of the *cellForWhichToReportCGI* included in the corresponding *measObject* within the *VarMeasConfig* to be applicable;
 - 2> else:
 - 3> if the corresponding *measObject* concerns E-UTRA:
 - 4> consider any neighbouring cell detected on the associated frequency to be applicable when the concerned cell is not included in the *blackCellsToAddModList* defined within the *VarMeasConfig* for this *measId*;
 - 3> else if the corresponding *measObject* concerns UTRA or CDMA2000:
 - 4> consider a neighbouring cell on the associated frequency to be applicable when the concerned cell is included in the *cellsToAddModList* defined within the *VarMeasConfig* for this *measId* (i.e. the cell is included in the white-list);
 - 3> else if the corresponding *measObject* concerns GERAN:
 - 4> consider a neighbouring cell on the associated set of frequencies to be applicable when the concerned cell matches the *ncc-Permitted* defined within the *VarMeasConfig* for this *measId*;
 - 2> if the *triggerType* is set to ‘*event*’ and if the entry condition applicable for this event, i.e. the event corresponding with the *eventId* of the corresponding *reportConfig* within *VarMeasConfig*, is fulfilled for one or more applicable cells for all measurements after layer 3 filtering taken during *timeToTrigger* defined for this event within the *VarMeasConfig*, while the *VarMeasReportList* does not include an measurement reporting entry for this *measId* (a first cell triggers the event):
 - 3> include a measurement reporting entry within the *VarMeasReportList* for this *measId*;
 - 3> set the *numberOfReportsSent* defined within the *VarMeasReportList* for this *measId* to 0;
 - 3> include the concerned cell(s) in the *cellsTriggeredList* defined within the *VarMeasReportList* for this *measId*;
 - 3> initiate the measurement reporting procedure, as specified in 5.5.5;

- 2> if the *triggerType* is set to 'event' and if the entry condition applicable for this event, i.e. the event corresponding with the *eventId* of the corresponding *reportConfig* within *VarMeasConfig*, is fulfilled for one or more applicable cells not included in the *cellsTriggeredList* for all measurements after layer 3 filtering taken during *timeToTrigger* defined for this event within the *VarMeasConfig* (a subsequent cell triggers the event):
 - 3> set the *numberOfReportsSent* defined within the *VarMeasReportList* for this *measId* to 0;
 - 3> include the concerned cell(s) in the *cellsTriggeredList* defined within the *VarMeasReportList* for this *measId*;
 - 3> initiate the measurement reporting procedure, as specified in 5.5.5;
- 2> if the *triggerType* is set to 'event' and if the leaving condition applicable for this event is fulfilled for one or more of the cells included in the *cellsTriggeredList* defined within the *VarMeasReportList* for this *measId* for all measurements after layer 3 filtering taken during *timeToTrigger* defined within the *VarMeasConfig* for this event:
 - 3> remove the concerned cell(s) in the *cellsTriggeredList* defined within the *VarMeasReportList* for this *measId*;
 - 3> if *reportOnLeave* is set to *TRUE* for the corresponding reporting configuration:
 - 4> initiate the measurement reporting procedure, as specified in 5.5.5;
 - 3> if the *cellsTriggeredList* defined within the *VarMeasReportList* for this *measId* is empty:
 - 4> remove the measurement reporting entry within the *VarMeasReportList* for this *measId*;
 - 4> stop the periodical reporting timer for this *measId*, if running;
- 2> if the *purpose* is included and set to 'reportStrongestCells' or to 'reportStrongestCellsForSON' and if a (first) measurement result is available for one or more applicable cells:
 - 3> include a measurement reporting entry within the *VarMeasReportList* for this *measId*;
 - 3> set the *numberOfReportsSent* defined within the *VarMeasReportList* for this *measId* to 0;
 - 3> initiate the measurement reporting procedure, as specified in 5.5.5;

NOTE 1: If the *purpose* is set to 'reportStrongestCells', the UE initiates a first measurement report immediately after the quantity to be reported becomes available for at least either serving cell or one of the applicable cells. If the *purpose* is set to 'reportStrongestCellsForSON', the UE initiates a first measurement report when it has determined the strongest cells on the associated frequency.

- 2> upon expiry of the periodical reporting timer for this *measId*:
 - 3> initiate the measurement reporting procedure, as specified in 5.5.5;
- 2> if the *purpose* is included and set to 'reportCGI' and if the UE acquired the information needed to set all fields of *cellGlobalId* for the requested cell:
 - 3> include a measurement reporting entry within the *VarMeasReportList* for this *measId*;
 - 3> set the *numberOfReportsSent* defined within the *VarMeasReportList* for this *measId* to 0;
 - 3> stop timer T321;
 - 3> initiate the measurement reporting procedure, as specified in 5.5.5;
- 2> upon expiry of the T321 for this *measId*:
 - 3> include a measurement reporting entry within the *VarMeasReportList* for this *measId*;
 - 3> set the *numberOfReportsSent* defined within the *VarMeasReportList* for this *measId* to 0;
 - 3> initiate the measurement reporting procedure, as specified in 5.5.5;

NOTE 2: The UE does not stop the periodical reporting with *triggerType* set to 'event' or to 'periodical' while the corresponding measurement is not performed due to the serving cell RSRP being equal to or better than *s-Measure* or due to the measurement gap not being setup.

NOTE 3: If the UE is configured with DRX, the UE may delay the measurement reporting for event triggered and periodical triggered measurements until the Active Time, which is defined in TS 36.321 [6].

[TS 36.331, clause 5.5.4.4]

The UE shall:

1> consider the entering condition for this event to be satisfied when condition A3-1, as specified below, is fulfilled;

1> consider the leaving condition for this event to be satisfied when condition A3-2, as specified below, is fulfilled;

Inequality A3-1 (Entering condition)

$$Mn + Ofn + Ocn - Hys > Ms + OfS + Ocs + Off$$

Inequality A3-2 (Leaving condition)

$$Mn + Ofn + Ocn + Hys < Ms + OfS + Ocs + Off$$

The variables in the formula are defined as follows:

Mn is the measurement result of the neighbouring cell, not taking into account any offsets.

Ofn is the frequency specific offset of the frequency of the neighbour cell (i.e. *offsetFreq* as defined within *measObjectEUTRA* corresponding to the frequency of the neighbour cell).

Ocn is the cell specific offset of the neighbour cell (i.e. *cellIndividualOffset* as defined within *measObjectEUTRA* corresponding to the frequency of the neighbour cell), and set to zero if not configured for the neighbour cell.

Ms is the measurement result of the serving cell, not taking into account any offsets.

Ofs is the frequency specific offset of the serving frequency (i.e. *offsetFreq* as defined within *measObjectEUTRA* corresponding to the serving frequency).

Ocs is the cell specific offset of the serving cell (i.e. *cellIndividualOffset* as defined within *measObjectEUTRA* corresponding to the serving frequency), and is set to zero if not configured for the serving cell.

Hys is the hysteresis parameter for this event (i.e. *hysteresis* as defined within *reportConfigEUTRA* for this event).

Off is the offset parameter for this event (i.e. *a3-Offset* as defined within *reportConfigEUTRA* for this event).

Mn, ***Ms*** are expressed in dBm in case of RSRP, or in dB in case of RSRQ.

Ofn, ***Ocn***, ***Ofs***, ***Ocs***, ***Hys***, ***Off*** are expressed in dB.

[TS 36.331, clause 5.5.5]

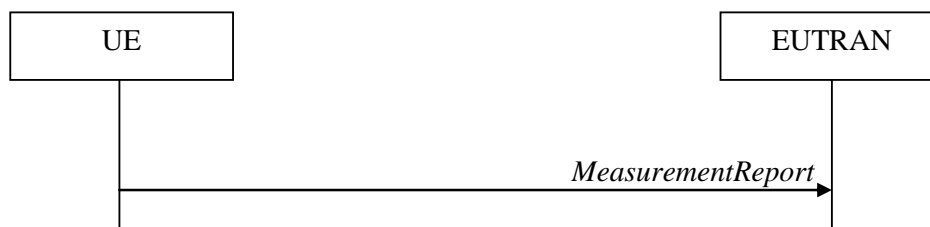

Figure 5.5.5-1: Measurement reporting

The purpose of this procedure is to transfer measurement results from the UE to E-UTRAN.

For the *measId* for which the measurement reporting procedure was triggered, the UE shall set the *measResults* within the *MeasurementReport* message as follows:

- 1> set the *measId* to the measurement identity that triggered the measurement reporting;
- 1> set the *measResultServCell* to include the quantities of serving cell;
- 1> if there is at least one applicable neighbouring cell to report:
 - 2> set the *measResultNeighCells* to include the best neighbouring cells up to *maxReportCells* in accordance with the following:
 - 3> if the *triggerType* is set to 'event':
 - 4> include the cells included in the *cellsTriggeredList* as defined within the *VarMeasReportList* for this *measId*;
 - 3> else:
 - 4> include the applicable cells for which the new measurement results became available since the last periodical reporting or since the measurement was initiated or reset;

NOTE 4: The reliability of the report (i.e. the certainty it contains the strongest cells on the concerned frequency) depends on the measurement configuration i.e. the *reportInterval*. The related performance requirements are specified in TS 36.133 [16].

- 3> for each cell that is included in the *measResultNeighCells*, include the *physCellId*;
- 3> if the *triggerType* is set to 'event'; or the *purpose* is set to 'reportStrongestCells' or to 'reportStrongestCellsForSON':
 - 4> for each included cell, include the layer 3 filtered measured results in accordance with the *reportConfig* for this *measId*, ordered as follows:
 - 5> if the *measObject* associated with this *measId* concerns E-UTRA:
 - 6> set the *measResult* to include the quantity(ies) indicated in the *reportQuantity* within the concerned *reportConfig* in order of decreasing *triggerQuantity*, i.e. the best cell is included first;
 - 5> else:
 - 6> set the *measResult* to the quantity as configured for the concerned RAT within the *quantityConfig* in order of decreasing quantity, i.e. the best cell is included first;
 - 3> else if the *purpose* is set to 'reportCGI':
 - 4> if the mandatory present fields of the *cellGlobalId* for the cell indicated by the *cellForWhichToReportCGI* in the associated *measObject* have been obtained:
 - 5> include the *cgi-Info* containing all the fields that have been successfully acquired;
- 1> increment the *numberOfReportsSent* as defined within the *VarMeasReportList* for this *measId* by 1;
- 1> stop the periodical reporting timer, if running;
- 1> if the *numberOfReportsSent* as defined within the *VarMeasReportList* for this *measId* is less than the *reportAmount* as defined within the corresponding *reportConfig* for this *measId*:
 - 2> start the periodical reporting timer with the value of *reportInterval* as defined within the corresponding *reportConfig* for this *measId*;
- 1> else:
 - 2> if the *triggerType* is set to 'periodical':
 - 3> remove the entry within the *VarMeasReportList* for this *measId*;

3> remove this *measId* from the *measIdList* within *VarMeasConfig*;

1> if the measured results are for CDMA2000 HRPD:

2> set the *preRegistrationStatusHRPD* to the UE's CDMA2000 upper layer's HRPD *preRegistrationStatus*;

1> if the measured results are for CDMA2000 1xRTT:

2> set the *preRegistrationStatusHRPD* to 'FALSE';

1> submit the *MeasurementReport* message to lower layers for transmission, upon which the procedure ends;

8.3.1.12.3 Test description

8.3.1.12.3.1 Pre-test conditions

System Simulator:

- Cell 1, Cell 2 and Cell 10
- System information combination 3 as defined in TS 36.508 [18] clause 4.4.3.1 is used in E-UTRA cells.

UE:

None.

Preamble:

- The UE is in state Generic RB Established (state 3) on Cell 1 according to [18].

8.3.1.12.3.2 Test procedure sequence

Table 8.3.1.12.3.2-1 illustrates the downlink power levels to be applied for Cell 1, Cell 2 and Cell 10 at various time instants of the test execution. Row marked "T0" denotes the conditions after the preamble, while rows marked "T1" and "T2" are to be applied subsequently. The exact instants on which these values shall be applied are described in the texts in this clause.

Table 8.3.1.12.3.2-1: Power levels

	Parameter	Unit	Cell 1	Cell 2 (DL only)	Cell 10 (DL only)	Remark
T0	Cell-specific RS EPRE	dBm/15kHz	-85	-91	Off	Power levels are such that entry condition for event A3 (measId 1 & 2) is not satisfied: $Mn + Ofn + Ocn + Hys < Ms + Ofs + Ocs + Off$
T1	Cell-specific RS EPRE	dBm/15kHz	-85	-79	Off	Power levels are such that entry condition for event A3 (measId 1) is satisfied: $Mn + Ofn + Ocn - Hys > Ms + Ofs + Ocs + Off$
T2	Cell-specific RS EPRE	dBm/15kHz	-85	Off	-73	Power levels are such that entry condition for event A3 (measId 2) is satisfied: $Mn + Ofn + Ocn - Hys > Ms + Ofs + Ocs + Off$

Table 8.3.1.12.3.2-2: Main behaviour

St	Procedure	Message Sequence		TP	Verdict
		U - S	Message		
1	SS transmits an <i>RRConnectionReconfiguration</i> message including <i>MeasConfig</i> to setup intra E-UTRAN measurement and reporting for two event A3 (<i>measId 1</i> and <i>measId 2</i>) (intra and inter frequency measurement).	<--	<i>RRConnectionReconfiguration</i>	-	-
2	The UE transmits an <i>RCConnectionReconfigurationComplete</i> message.	-->	<i>RRConnectionReconfigurationComplete</i>	-	-
3	SS re-adjusts the cell-specific reference signal level according to row "T1" in table 8.3.1.12.3.2-1.	-	-	-	-
4	Check: Does the UE transmit a <i>MeasurementReport</i> message to report event A3 (<i>measId 1</i>) with the measured RSRP value for Cell 2?	-->	<i>MeasurementReport</i>	1	P
5	SS re-adjusts the cell-specific reference signal level according to row "T2" in table 8.3.1.12.3.2-1.	-	-	-	-
6	Check: Does the UE transmit a <i>MeasurementReport</i> message to report event A3 (<i>measId 2</i>) with the measured RSRP value for Cell 10?	-->	<i>MeasurementReport</i>	1	P

8.3.1.12.3.3 Specific message contents

Table 8.3.1.12.3.3-1: *RRConnectionReconfiguration* (step 1, Table 8.3.1.12.3.2-2)

Derivation Path: 36.508 clause 4.6.1 table 4.6.1-8 with condition MEAS
--

Table 8.3.1.12.3.3-2: *MeasConfig* (step 1, Table 8.3.1.12.3.2-2)

Derivation path: 36.508 clause 4.6.6 table 4.6.6-1, condition INTER-FREQ			
Information Element	Value/Remark	Comment	Condition
<i>MeasConfig</i> ::= SEQUENCE {			
<i>measObjectToAddModList</i> SEQUENCE (SIZE (1.. <i>maxObjectId</i>)) OF SEQUENCE {	2 entries		
<i>measObjectId</i> [1]	IdMeasObject-f1		
<i>measObject</i> [1]	MeasObjectEUTRA-GENERIC(f1)		
<i>measObjectId</i> [2]	IdMeasObject-f5		
<i>measObject</i> [2]	MeasObjectEUTRA-GENERIC(f5)		
}			
<i>reportConfigToAddModList</i> SEQUENCE (SIZE (1.. <i>maxReportConfigId</i>)) OF SEQUENCE {	1 entry		
<i>reportConfigId</i> [1]	IdReportConfig-A3		
<i>reportConfig</i> [1]	ReportConfig-A3-H		
}			
<i>measIdToAddModList</i> SEQUENCE (SIZE (1.. <i>maxMeasId</i>)) OF SEQUENCE {	2 entries		
<i>measId</i> [1]	1		
<i>measObjectId</i> [1]	IdMeasObject-f1		
<i>reportConfigId</i> [1]	IdReportConfig-A3		
<i>measId</i> [2]	2		
<i>measObjectId</i> [2]	IdMeasObject-f5		
<i>reportConfigId</i> [2]	IdReportConfig-A3		
}			
}			

Table 8.3.1.12.3.3-3: ReportConfig-A3-H (step 1, Table 8.3.1.12.3.2-2)

Derivation path: 36.508 clause 4.6.6 table 4.6.6-6 ReportConfigEUTRA-A3			
Information Element	Value/remark	Comment	Condition
ReportConfigEUTRA-A3 ::= SEQUENCE {			
triggerType CHOICE {			
event SEQUENCE {			
timeToTrigger	ms0		
}			
}			
reportQuantity	sameAsTriggerQuantity		
}			

Table 8.3.1.12.3.3-4: MeasurementReport (step 4, Table 8.3.1.12.3.2-2)

Derivation path: 36.508 4.6.1 table 4.6.1-5			
Information Element	Value/Remark	Comment	Condition
MeasurementReport ::= SEQUENCE {			
criticalExtensions CHOICE {			
c1 CHOICE {			
measurementReport-r8 SEQUENCE {			
measResults ::= SEQUENCE {			
measId	1		
measResultServCell ::= SEQUENCE {		Report Cell 1	
rsrpResult	(0..97)		
rsrqResult	(0..34)		
}			
measResultNeighCells CHOICE {			
MeasResultEUTRA ::= SEQUENCE (SIZE (1..maxCellReport)) OF SEQUENCE {		Report Cell 2	
physCellId	physCellId of the Cell 2.		
measResult SEQUENCE{			
rsrpResult	(0..97)		
rsrqResult	Not present		
}			
}			
}			
measResultForECID-r9	Not present		
}			
}			
}			
}			

Table 8.3.1.12.3.3-5: MeasurementReport (step 6, Table 8.3.1.12.3.2-2)

Derivation path: 36.508 4.6.1 table 4.6.1-5			
Information Element	Value/Remark	Comment	Condition
MeasurementReport ::= SEQUENCE {			
criticalExtensions CHOICE {			
c1 CHOICE {			
measurementReport-r8 SEQUENCE {			
measResults ::= SEQUENCE {			
measId	2		
measResultServCell ::= SEQUENCE {		Report Cell 1	
rsrpResult	(0..97)		
rsrqResult	(0..34)		
}			
measResultNeighCells CHOICE {			
MeasResultEUTRA ::= SEQUENCE (SIZE (1..maxCellReport)) OF SEQUENCE {		Report Cell 10	
physCellId	physCellId of the Cell 10.		
measResult SEQUENCE {			
rsrpResult	(0..97)		
rsrqResult	Not present		
}			
}			
measResultForECID-r9	Not present		
}			
}			
}			
}			

8.3.1.12a Measurement configuration control and reporting / Intra E-UTRAN measurements / Two simultaneous events A3 (inter-band measurements) / Between FDD and TDD

8.3.1.12a.1 Test Purpose (TP)

(1)

```
with { UE in E-UTRA FDD RRC_CONNECTED state and measurements configured for two event A3 at the same time for E-UTRA TDD cell }
ensure that {
  when { Entry condition for event A3 is not met }
  then { UE does not send MeasurementReport }
}
```

(2)

```
with { UE in E-UTRA FDD RRC_CONNECTED state and measurements configured for two event A3 at the same time for E-UTRA TDD cell }
ensure that {
  when { Neighbour E-UTRA TDD cell becomes offset better than serving E-UTRA FDD cell }
  then { UE sends MeasurementReport with correct measId for event A3 }
}
```

(3)

```
with { UE in E-UTRA TDD RRC_CONNECTED state and measurements configured for two event A3 at the same time for E-UTRA FDD cell }
ensure that {
  when { Entry condition for event A3 is not met }
  then { UE does not send MeasurementReport }
}
```

(4)

```

with { UE in E-UTRA TDD RRC_CONNECTED state and measurements configured for two event A3 at the same
time for E-UTRA FDD cell }
ensure that {
  when { Neighbour E-UTRA FDD cell becomes offset better than serving E-UTRA TDD cell }
  then { UE sends MeasurementReport with correct measId for event A3 }
}

```

8.3.1.12a.2 Conformance requirements

References: The conformance requirements covered in the current TC are specified in: TS 36.331, clauses 5.3.5.3, 5.5.4.1, 5.5.4.4 and 5.5.5.

[TS 36.331, clause 5.3.5.3]

If the *RRCConnectionReconfiguration* message does not include the *mobilityControlInfo* and the UE is able to comply with the configuration included in this message, the UE shall:

...

- 1> If the *RRCConnectionReconfiguration* message includes the *measConfig*:
- 2> perform the Measurement configuration procedure as specified in 5.5.2;

...

[TS 36.331, clause 5.5.4.1]

The UE shall:

- 1> for each *measId* included in the *measIdList* within *VarMeasConfig*:
 - 2> if the corresponding *reportConfig* includes a purpose set to ‘*reportStrongestCellsForSON*’:
 - 3> consider any neighbouring cell detected on the associated frequency to be applicable;
 - 2> else if the corresponding *reportConfig* includes a purpose set to ‘*reportCGI*’:
 - 3> consider any neighbouring cell detected on the associated frequency/ set of frequencies (GERAN) which has a physical cell identity matching the value of the *cellForWhichToReportCGI* included in the corresponding *measObject* within the *VarMeasConfig* to be applicable;
 - 2> else:
 - 3> if the corresponding *measObject* concerns E-UTRA:
 - 4> consider any neighbouring cell detected on the associated frequency to be applicable when the concerned cell is not included in the *blackCellsToAddModList* defined within the *VarMeasConfig* for this *measId*;
 - 3> else if the corresponding *measObject* concerns UTRA or CDMA2000:
 - 4> consider a neighbouring cell on the associated frequency to be applicable when the concerned cell is included in the *cellsToAddModList* defined within the *VarMeasConfig* for this *measId* (i.e. the cell is included in the white-list);
 - 3> else if the corresponding *measObject* concerns GERAN:
 - 4> consider a neighbouring cell on the associated set of frequencies to be applicable when the concerned cell matches the *ncc-Permitted* defined within the *VarMeasConfig* for this *measId*;
 - 2> if the *triggerType* is set to ‘*event*’ and if the entry condition applicable for this event, i.e. the event corresponding with the *eventId* of the corresponding *reportConfig* within *VarMeasConfig*, is fulfilled for one or more applicable cells for all measurements after layer 3 filtering taken during *timeToTrigger* defined for this event within the *VarMeasConfig*, while the *VarMeasReportList* does not include an measurement reporting entry for this *measId* (a first cell triggers the event):

- 3> include a measurement reporting entry within the *VarMeasReportList* for this *measId*;
 - 3> set the *numberOfReportsSent* defined within the *VarMeasReportList* for this *measId* to 0;
 - 3> include the concerned cell(s) in the *cellsTriggeredList* defined within the *VarMeasReportList* for this *measId*;
 - 3> initiate the measurement reporting procedure, as specified in 5.5.5;
- 2> if the *triggerType* is set to 'event' and if the entry condition applicable for this event, i.e. the event corresponding with the *eventId* of the corresponding *reportConfig* within *VarMeasConfig*, is fulfilled for one or more applicable cells not included in the *cellsTriggeredList* for all measurements after layer 3 filtering taken during *timeToTrigger* defined for this event within the *VarMeasConfig* (a subsequent cell triggers the event):
- 3> set the *numberOfReportsSent* defined within the *VarMeasReportList* for this *measId* to 0;
 - 3> include the concerned cell(s) in the *cellsTriggeredList* defined within the *VarMeasReportList* for this *measId*;
 - 3> initiate the measurement reporting procedure, as specified in 5.5.5;
- 2> if the *triggerType* is set to 'event' and if the leaving condition applicable for this event is fulfilled for one or more of the cells included in the *cellsTriggeredList* defined within the *VarMeasReportList* for this *measId* for all measurements after layer 3 filtering taken during *timeToTrigger* defined within the *VarMeasConfig* for this event:
- 3> remove the concerned cell(s) in the *cellsTriggeredList* defined within the *VarMeasReportList* for this *measId*;
 - 3> if *reportOnLeave* is set to *TRUE* for the corresponding reporting configuration:
 - 4> initiate the measurement reporting procedure, as specified in 5.5.5;
 - 3> if the *cellsTriggeredList* defined within the *VarMeasReportList* for this *measId* is empty:
 - 4> remove the measurement reporting entry within the *VarMeasReportList* for this *measId*;
 - 4> stop the periodical reporting timer for this *measId*, if running;
- 2> if the *purpose* is included and set to 'reportStrongestCells' or to 'reportStrongestCellsForSON' and if a (first) measurement result is available for one or more applicable cells:
- 3> include a measurement reporting entry within the *VarMeasReportList* for this *measId*;
 - 3> set the *numberOfReportsSent* defined within the *VarMeasReportList* for this *measId* to 0;
 - 3> initiate the measurement reporting procedure, as specified in 5.5.5;
- NOTE 1: If the *purpose* is set to 'reportStrongestCells', the UE initiates a first measurement report immediately after the quantity to be reported becomes available for at least either serving cell or one of the applicable cells. If the *purpose* is set to 'reportStrongestCellsForSON', the UE initiates a first measurement report when it has determined the strongest cells on the associated frequency.
- 2> upon expiry of the periodical reporting timer for this *measId*:
- 3> initiate the measurement reporting procedure, as specified in 5.5.5;
- 2> if the *purpose* is included and set to 'reportCGI' and if the UE acquired the information needed to set all fields of *cellGlobalId* for the requested cell:
- 3> include a measurement reporting entry within the *VarMeasReportList* for this *measId*;
 - 3> set the *numberOfReportsSent* defined within the *VarMeasReportList* for this *measId* to 0;
 - 3> stop timer T321;

- 3> initiate the measurement reporting procedure, as specified in 5.5.5;
- 2> upon expiry of the T321 for this *measId*:
 - 3> include a measurement reporting entry within the *VarMeasReportList* for this *measId*;
 - 3> set the *numberOfReportsSent* defined within the *VarMeasReportList* for this *measId* to 0;
 - 3> initiate the measurement reporting procedure, as specified in 5.5.5;

NOTE 2: The UE does not stop the periodical reporting with *triggerType* set to 'event' or to 'periodical' while the corresponding measurement is not performed due to the serving cell RSRP being equal to or better than *s-Measure* or due to the measurement gap not being setup.

NOTE 3: If the UE is configured with DRX, the UE may delay the measurement reporting for event triggered and periodical triggered measurements until the Active Time, which is defined in TS 36.321 [6].

[TS 36.331, clause 5.5.4.4]

The UE shall:

- 1> consider the entering condition for this event to be satisfied when condition A3-1, as specified below, is fulfilled;
- 1> consider the leaving condition for this event to be satisfied when condition A3-2, as specified below, is fulfilled;

Inequality A3-1 (Entering condition):

$$Mn + Ofn + Ocn - Hys > Ms + OfS + Ocs + Off$$

Inequality A3-2 (Leaving condition):

$$Mn + Ofn + Ocn + Hys < Ms + OfS + Ocs + Off$$

The variables in the formula are defined as follows:

Mn is the measurement result of the neighbouring cell, not taking into account any offsets.

Ofn is the frequency specific offset of the frequency of the neighbour cell (i.e. *offsetFreq* as defined within *measObjectEUTRA* corresponding to the frequency of the neighbour cell).

Ocn is the cell specific offset of the neighbour cell (i.e. *cellIndividualOffset* as defined within *measObjectEUTRA* corresponding to the frequency of the neighbour cell), and set to zero if not configured for the neighbour cell.

Ms is the measurement result of the serving cell, not taking into account any offsets.

OfS is the frequency specific offset of the serving frequency (i.e. *offsetFreq* as defined within *measObjectEUTRA* corresponding to the serving frequency).

Ocs is the cell specific offset of the serving cell (i.e. *cellIndividualOffset* as defined within *measObjectEUTRA* corresponding to the serving frequency), and is set to zero if not configured for the serving cell.

Hys is the hysteresis parameter for this event (i.e. *hysteresis* as defined within *reportConfigEUTRA* for this event).

Off is the offset parameter for this event (i.e. *a3-Offset* as defined within *reportConfigEUTRA* for this event).

Mn*, *Ms are expressed in dBm in case of RSRP, or in dB in case of RSRQ.

Ofn*, *Ocn*, *OfS*, *Ocs*, *Hys*, *Off are expressed in dB.

[TS 36.331, clause 5.5.5]

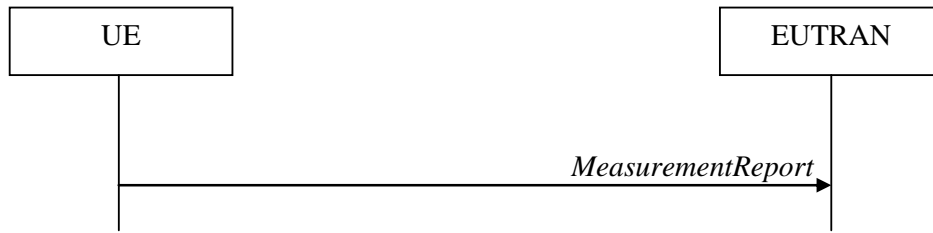

Figure 5.5.5-1: Measurement reporting

The purpose of this procedure is to transfer measurement results from the UE to E-UTRAN.

For the *measId* for which the measurement reporting procedure was triggered, the UE shall set the *measResults* within the *MeasurementReport* message as follows:

- 1> set the *measId* to the measurement identity that triggered the measurement reporting;
- 1> set the *measResultServCell* to include the quantities of serving cell;
- 1> if there is at least one applicable neighbouring cell to report:
 - 2> set the *measResultNeighCells* to include the best neighbouring cells up to *maxReportCells* in accordance with the following:
 - 3> if the *triggerType* is set to 'event':
 - 4> include the cells included in the *cellsTriggeredList* as defined within the *VarMeasReportList* for this *measId*;
 - 3> else:
 - 4> include the applicable cells for which the new measurement results became available since the last periodical reporting or since the measurement was initiated or reset;

NOTE: The reliability of the report (i.e. the certainty it contains the strongest cells on the concerned frequency) depends on the measurement configuration i.e. the *reportInterval*. The related performance requirements are specified in TS 36.133 [16].

- 3> for each cell that is included in the *measResultNeighCells*, include the *physCellId*;
- 3> if the *triggerType* is set to 'event'; or the *purpose* is set to 'reportStrongestCells' or to 'reportStrongestCellsForSON':
 - 4> for each included cell, include the layer 3 filtered measured results in accordance with the *reportConfig* for this *measId*, ordered as follows:
 - 5> if the *measObject* associated with this *measId* concerns E-UTRA:
 - 6> set the *measResult* to include the quantity(ies) indicated in the *reportQuantity* within the concerned *reportConfig* in order of decreasing *triggerQuantity*, i.e. the best cell is included first;
 - 5> else:
 - 6> set the *measResult* to the quantity as configured for the concerned RAT within the *quantityConfig* in order of decreasing quantity, i.e. the best cell is included first;
 - 3> else if the *purpose* is set to 'reportCGI':
 - 4> if the mandatory present fields of the *cellGlobalId* for the cell indicated by the *cellForWhichToReportCGI* in the associated *measObject* have been obtained:
 - 5> include the *cgi-Info* containing all the fields that have been successfully acquired;

- 1> increment the *numberOfReportsSent* as defined within the *VarMeasReportList* for this *measId* by 1;
- 1> stop the periodical reporting timer, if running;
- 1> if the *numberOfReportsSent* as defined within the *VarMeasReportList* for this *measId* is less than the *reportAmount* as defined within the corresponding *reportConfig* for this *measId*:
 - 2> start the periodical reporting timer with the value of *reportInterval* as defined within the corresponding *reportConfig* for this *measId*;
- 1> else:
 - 2> if the *triggerType* is set to 'periodical':
 - 3> remove the entry within the *VarMeasReportList* for this *measId*;
 - 3> remove this *measId* from the *measIdList* within *VarMeasConfig*;
- 1> if the measured results are for CDMA2000 HRPD:
 - 2> set the *preRegistrationStatusHRPD* to the UE's CDMA2000 upper layer's HRPD *preRegistrationStatus*;
- 1> if the measured results are for CDMA2000 1xRTT:
 - 2> set the *preRegistrationStatusHRPD* to 'FALSE';
- 1> submit the *MeasurementReport* message to lower layers for transmission, upon which the procedure ends;

8.3.1.12a.3 Test description

8.3.1.12a.3.1 Pre-test conditions

System Simulator:

- Cell 1 is LTE FDD cell, Cell 28 is LTE TDD cell.
- Each cell has only a single PLMN identity. The PLMNs are identified in the test by the identifiers in Table 8.3.1.12a.3.1-1.

Table 8.3.1.12a.3.1-1: PLMN identifiers

Cell	PLMN name
1	PLMN1
28	PLMN2

- System information combination 3 as defined in TS 36.508 [18] clause 4.4.3.1 and Table 6.3.1.2-2 is used in E-UTRA cells.

UE:

None.

Preamble:

- The UE is registered on PLMN1 (Cell 1) using the procedure described in TS 36.508[18] clause 4.5.2.3 except that the ATTACH ACCEPT message indicates PLMN2 in the Equivalent PLMN list as described in Table 8.3.1.12a.3.3-15.
- The UE is in state Generic RB Established (state 3) on Cell 1 according to [18]

8.3.1.12a.3.2 Test procedure sequence

Table 8.3.1.12a.3.2-1 illustrates the downlink power levels to be applied for Cell 1 and Cell 2 at various time instants of the test execution. Row marked "T0" denotes the conditions after the preamble, while rows marked "T1", "T2", "T3", "T4" and "T5" are to be applied subsequently. The exact instants on which these values shall be applied are described in the texts in this clause.

Table 8.3.1.12a.3.2-1: Power levels

	Parameter	Unit	Cell 1	Cell 28	Remark
T0	Cell-specific RS EPRE	dBm/15 kHz	-85	-110	The power levels are such that that measurement results for Cell 1 (M1) and Cell 28 (M28) satisfy exit condition for event A3 (<i>measId</i> 1 & 2) ($M28 < M1$): $Mn + Ofn + Ocn + Hys < Ms + Ofs + Ocs + Off$
T1	Cell-specific RS EPRE	dBm/15 kHz	-85	-91	The power levels are such that measurement results for Cell 1 (M1) and Cell 28 (M28) satisfy entry condition for event A3 (<i>measId</i> 1) ($M28 > M1$): $Mn + Ofn + Ocn - Hys > Ms + Ofs + Ocs + Off$
T2	Cell-specific RS EPRE	dBm/15 kHz	-85	-73	The power levels are such that measurement results for Cell 1 (M1) and Cell 28 (M28) satisfy entry condition for event A3 (<i>measId</i> 2) ($M28 > M1$): $Mn + Ofn + Ocn - Hys > Ms + Ofs + Ocs + Off$
T3	Cell-specific RS EPRE	dBm/15 kHz	-110	-85	The power levels are such that that measurement results for Cell 1 (M1) and Cell 28 (M28) satisfy exit condition for event A3 (<i>measId</i> 1 & 2) ($M1 < M28$): $Mn + Ofn + Ocn + Hys < Ms + Ofs + Ocs + Off$
T4	Cell-specific RS EPRE	dBm/15 kHz	-91	-85	The power levels are such that measurement results for Cell 1 (M1) and Cell 28 (M28) satisfy entry condition for event A3 (<i>measId</i> 1) ($M1 > M28$): $Mn + Ofn + Ocn - Hys > Ms + Ofs + Ocs + Off$
T5	Cell-specific RS EPRE	dBm/15 kHz	-73	-85	The power levels are such that measurement results for Cell 1 (M1) and Cell 28 (M28) satisfy entry condition for event A3 (<i>measId</i> 2) ($M1 > M28$): $Mn + Ofn + Ocn - Hys > Ms + Ofs + Ocs + Off$

Table 8.3.1.12a.3.2-2: Main behaviour

St	Procedure	Message Sequence		TP	Verdict
		U - S	Message		
1	SS transmits an <i>RRCCONNECTIONRECONFIGURATION</i> message including <i>MeasConfig</i> to setup inter-band measurement and reporting for two event A3 (<i>measId 1</i> and <i>measId 2</i>) with different parameters for E-UTRA TDD Cell 28.	<--	<i>RRCCONNECTIONRECONFIGURATION</i>	-	-
2	The UE transmits an <i>RRCCONNECTIONRECONFIGURATIONCOMPLETE</i> message.	-->	<i>RRCCONNECTIONRECONFIGURATIONCOMPLETE</i>	-	-
3	Check: Does the UE transmit a <i>MEASUREMENTREPORT</i> message within the next 10s?	-->	<i>MEASUREMENTREPORT</i>	1	F
4	SS re-adjusts the cell-specific reference signal level according to row "T1" in table 8.3.1.12a.3.2-1.	-	-	-	-
5	Check: Does the UE transmit a <i>MEASUREMENTREPORT</i> message to report event A3 (<i>measId 1</i>) with the measured RSRP value for Cell 28?	-->	<i>MEASUREMENTREPORT</i>	2	P
6	SS re-adjusts the cell-specific reference signal level according to row "T2" in table 8.3.1.12a.3.2-1.	-	-	-	-
7	Check: Does the UE transmit a <i>MEASUREMENTREPORT</i> message to report event A3 (<i>measId 2</i>) with the measured RSRP value for Cell 28?	-->	<i>MEASUREMENTREPORT</i>	2	P
-	EXCEPTION: Steps 8a1 to 8b5 describe behaviour that depends on the UE capability that if UE has set FGI bit 30 to 1; the "lower case letter" identifies a step sequence that takes place if a capability is supported.	-	-	-	-
8a1	IF <i>pc_FeatrGrp_30</i> THEN the SS transmits an <i>RRCCONNECTIONRECONFIGURATION</i> message on Cell 1 to order the UE to perform inter-band handover to Cell 28.	<--	<i>RRCCONNECTIONRECONFIGURATION</i>	-	-
8a2	The UE transmits an <i>RRCCONNECTIONRECONFIGURATIONCOMPLETE</i> message on Cell 28 to confirm the successful handover	-->	<i>RRCCONNECTIONRECONFIGURATIONCOMPLETE</i>	-	-
8a3	The UE transmits a TRACKING AREA UPDATE REQUEST message on Cell 28.	-	-	-	-
8a4	SS responds with a TRACKING AREA UPDATE ACCEPT message. NOTE: The TAU is accepted with PLMN1 listed as an Equivalent PLMN	-	-	-	-
8a5	The UE transmits a TRACKING AREA UPDATE COMPLETE message.	-	-	-	-
8a6	The SS transmits an <i>RRCCONNECTIONRECONFIGURATION</i> message to activate the measurement gaps on Cell 28.	<--	<i>RRCCONNECTIONRECONFIGURATION</i>	-	-
8a7	The UE transmits an <i>RRCCONNECTIONRECONFIGURATIONCOMPLETE</i> message to confirm the activation of the measurement gaps on Cell 28.	-->	<i>RRCCONNECTIONRECONFIGURATIONCOMPLETE</i>	-	-
8b1	ELSE IF NOT <i>pc_FeatrGrp_30</i> THEN the SS transmits an <i>RRCCONNECTIONRELEASE</i> message (IE <i>redirectedCarrierInfo</i> including <i>extraCarrierFreq</i> of Cell 28) on Cell 1	<--	<i>RRCCONNECTIONRELEASE</i>	-	-
8b2	Generic test procedure described in TS 36.508 subclause 6.4.2.7 is performed on Cell 28 NOTE: The TAU is accepted with PLMN1 listed as an Equivalent PLMN	-	-	-	-
8b3	Generic test procedure described in TS 36.508 subclause 4.5.3.3 is executed	-	-	-	-

8b4	The SS transmits an <i>RRCConnectionReconfiguration</i> message including <i>MeasConfig</i> to setup inter-band measurement and reporting for two event A3 (<i>measId 1</i> and <i>measId 2</i>) with different parameters for E-UTRA FDD Cell 1.	<--	<i>RRCConnectionReconfiguration</i>	-	-
8b5	The UE transmits an <i>RRCConnectionReconfigurationComplete</i> message.	-->	<i>RRCConnectionReconfigurationComplete</i>	-	-
9	SS re-adjusts the cell-specific reference signal level according to row "T3" in table 8.3.1.12a.3.2-1.	-	-	-	-
10	Check: Does the UE transmit a <i>MeasurementReport</i> message within the next 10s?	-->	<i>MeasurementReport</i>	3	F
11	SS re-adjusts the cell-specific reference signal level according to row "T4" in table 8.3.1.12a.3.2-1.	-	-	-	-
12	Check: Does the UE transmit a <i>MeasurementReport</i> message to report event A3 (<i>measId 1</i>) with the measured RSRP value for Cell 1?	-->	<i>MeasurementReport</i>	4	P
13	SS re-adjusts the cell-specific reference signal level according to row "T5" in table 8.3.1.12a.3.2-1.	-	-	-	-
14	Check: Does the UE transmit a <i>MeasurementReport</i> message to report event A3 (<i>measId 2</i>) with the measured RSRP value for Cell 1?	-->	<i>MeasurementReport</i>	4	P

8.3.1.12a.3.3 Specific message contents

Table 8.3.1.12a.3.3-1: *RRCConnectionReconfiguration* (step 1 and step 8b4, Table 8.3.1.12a.3.2-2)

Derivation Path: 36.508 clause 4.6.1 table 4.6.1-8 with condition MEAS
--

Table 8.3.1.12a.3.3-2: MeasConfig (step 1, Table 8.3.1.12a.3.2-2)

Derivation path: 36.508 clause 4.6.6 table 4.6.6-1, condition INTER-FREQ			
Information Element	Value/Remark	Comment	Condition
MeasConfig ::= SEQUENCE {			
measObjectToAddModList SEQUENCE (SIZE (1..maxObjectId)) OF SEQUENCE {	2 entries		
measObjectId[1]	IdMeasObject-f1		
measObject[1]	MeasObjectEUTRA-GENERIC(f1)		
measObjectId[2]	IdMeasObject-f6		
measObject[2]	MeasObjectEUTRA-GENERIC(f6)		
}			
reportConfigToAddModList SEQUENCE (SIZE (1..maxReportConfigId)) OF SEQUENCE {	2 entries		
reportConfigId[1]	1		
reportConfig[1]	ReportConfig-A3-Lowerthreshold		
reportConfigId[2]	2		
reportConfig[2]	ReportConfig-A3-Higherthreshold		
}			
measIdToAddModList SEQUENCE (SIZE (1..maxMeasId)) OF SEQUENCE {	2 entries		
measId[1]	1		
measObjectId[1]	IdMeasObject-f6		
reportConfigId[1]	IdReportConfig-A3-Lowerthreshold		
measId[2]	2		
measObjectId[2]	IdMeasObject-f6		
reportConfigId[2]	IdReportConfig-A3-Higherthreshold		
}			
}			

Table 8.3.1.12a.3.3-3: ReportConfig-A3-Lowerthreshold (step 1 and step 8b4, Table 8.3.1.12a.3.2-2)

Derivation path: 36.508 clause 4.6.6 table 4.6.6-6 ReportConfigEUTRA-A3			
Information Element	Value/remark	Comment	Condition
ReportConfigEUTRA-A3 ::= SEQUENCE {			
triggerType CHOICE {			
event SEQUENCE {			
eventId CHOICE {			
eventA3 SEQUENCE {			
a3-Offset	-24	-12 dB	
}			
}			
timeToTrigger	ms0		
}			
reportQuantity	sameAsTriggerQuantity		
}			

Table 8.3.1.12a.3.3-4: ReportConfig-A3-Higherthreshold (step 1 and step 8b4, Table 8.3.1.12a.3.2-2)

Derivation path: 36.508 clause 4.6.6 table 4.6.6-6 ReportConfigEUTRA-A3			
Information Element	Value/remark	Comment	Condition
ReportConfigEUTRA-A3 ::= SEQUENCE {			
triggerType CHOICE {			
event SEQUENCE {			
eventId CHOICE {			
eventA3 SEQUENCE {			
a3-Offset	0	0 dB	
}			
}			
timeToTrigger	ms0		
}			
reportQuantity	sameAsTriggerQuantity		
}			

Table 8.3.1.12a.3.3-5: MeasurementReport (step 5, Table 8.3.1.12a.3.2-2)

Derivation path: 36.508 4.6.1 table 4.6.1-5			
Information Element	Value/Remark	Comment	Condition
MeasurementReport ::= SEQUENCE {			
criticalExtensions CHOICE {			
c1 CHOICE {			
measurementReport-r8 SEQUENCE {			
MeasResults ::= SEQUENCE {			
measId	1		
measResultServCell ::= SEQUENCE {		Report Cell 1	
rsrpResult	(0..97)		
rsrqResult	(0..34)		
}			
measResultNeighCells CHOICE {			
MeasResultEUTRA ::= SEQUENCE (SIZE (1..maxCellReport)) OF SEQUENCE {		Report Cell 28	
physCellId	PhysCellId of the Cell 28		
measResult SEQUENCE{			
rsrpResult	(0..97)		
rsrqResult	Not present		
}			
}			
}			
}			
}			
}			
}			
}			

Table 8.3.1.12a.3.3-6: MeasurementReport (step 7, Table 8.3.1.12a.3.2-2)

Derivation path: 36.508 4.6.1 table 4.6.1-5			
Information Element	Value/Remark	Comment	Condition
MeasurementReport ::= SEQUENCE {			
criticalExtensions CHOICE {			
c1 CHOICE {			
measurementReport-r8 SEQUENCE {			
MeasResults ::= SEQUENCE {			
measId	2		
measResultServCell ::= SEQUENCE {		Report Cell 1	
rsrpResult	(0..97)		
rsrqResult	(0..34)		
}			
measResultNeighCells CHOICE {			
MeasResultEUTRA ::= SEQUENCE (SIZE (1..maxCellReport)) OF SEQUENCE {		Report Cell 28	
physCellId	PhysCellId of the Cell 28		
measResult SEQUENCE{			
rsrpResult	(0..97)		
rsrqResult	Not present		
}			
}			
}			
}			
}			
}			
}			
}			

Table 8.3.1.12a.3.3-7: RRCConnectionReconfiguration (step 8a1, Table 8.3.1.12a.3.2-2)

Derivation path: 36.508 Table 4.6.1-8, condition HO

Table 8.3.1.12a.3.3-8: MobilityControllInfo (step 8a1, Table 8.3.1.12a.3.3-7)

Derivation Path: 36.508 Table 4.6.5-1			
Information Element	Value/remark	Comment	Condition
MobilityControllInfo ::= SEQUENCE {			
targetPhysCellId	PhysicalCellId of Cell 28		
carrierFreq SEQUENCE {			
dl-CarrierFreq	Same downlink EARFCN as used for Cell 28		
ul-CarrierFreq	Not present		
}			
}			

Table 8.3.1.12a.3.3-9: RRCConnectionReconfiguration (step 8a6, Table 8.3.1.12a.3.2-2)

Derivation Path: 36.508, Table 4.6.1-8, condition MEAS
--

Table 8.3.1.12a.3.3-10: MeasConfig (step 8a6, Table 8.3.1.12a.3.3-9)

Derivation Path: 36.508, Table 4.6.6-1, condition INTER-FREQ
--

Table 8.3.1.12a.3.3-11: MeasurementReport (step 12, Table 8.3.1.12a.3.2-2)

Derivation path: 36.508 4.6.1 table 4.6.1-5			
Information Element	Value/Remark	Comment	Condition
MeasurementReport ::= SEQUENCE {			
criticalExtensions CHOICE {			
c1 CHOICE {			
measurementReport-r8 SEQUENCE {			
MeasResults ::= SEQUENCE {			
measId	1		
measResultServCell ::= SEQUENCE {		Report Cell 28	
rsrpResult	(0..97)		
rsrqResult	(0..34)		
}			
measResultNeighCells CHOICE {			
MeasResultEUTRA ::= SEQUENCE (SIZE (1..maxCellReport)) OF SEQUENCE {		Report Cell 1	
physCellId	PhysCellId of the Cell 1		
measResult SEQUENCE{			
rsrpResult	(0..97)		
rsrqResult	Not present		
}			
}			
}			
}			
}			
}			
}			
}			

Table 8.3.1.12a.3.3-12: MeasurementReport (step 14, Table 8.3.1.12a.3.2-2)

Derivation path: 36.508 4.6.1 table 4.6.1-5			
Information Element	Value/Remark	Comment	Condition
MeasurementReport ::= SEQUENCE {			
criticalExtensions CHOICE {			
c1 CHOICE {			
measurementReport-r8 SEQUENCE {			
MeasResults ::= SEQUENCE {			
measId	2		
measResultServCell ::= SEQUENCE {		Report Cell 28	
rsrpResult	(0..97)		
rsrqResult	(0..34)		
}			
measResultNeighCells CHOICE {			
MeasResultEUTRA ::= SEQUENCE (SIZE (1..maxCellReport)) OF SEQUENCE {		Report Cell 1	
physCellId	PhysCellId of the Cell 1		
measResult SEQUENCE{			
rsrpResult	(0..97)		
rsrqResult	Not present		
}			
}			
}			
}			
}			
}			
}			
}			

Table 8.3.1.12a.3.3-13: RRCConnectionRelease (step 8b1, Table 8.3.1.12a.3.2-2)

Derivation Path: 36.508 table 4.6.1-15			
Information Element	Value/remark	Comment	Condition
RRCConnectionRelease ::= SEQUENCE {			
criticalExtensions CHOICE {			
c1 CHOICE {			
rrcConnectionRelease-r8 SEQUENCE {			
redirectedCarrierInfo ::= CHOICE {			
eutra	Downlink EARFCN of cell Cell 28		
}			
}			
}			
}			
}			

Table 8.3.1.12a.3.3-14: MeasConfig (step 8b4, Table 8.3.1.12a.3.2-2)

Derivation path: 36.508 clause 4.6.6 table 4.6.6-1, condition INTER-FREQ			
Information Element	Value/Remark	Comment	Condition
MeasConfig ::= SEQUENCE {			
measObjectToAddModList SEQUENCE (SIZE (1..maxObjectId)) OF SEQUENCE {	2 entries		
measObjectId[1]	IdMeasObject-f6		
measObject[1]	MeasObjectEUTRA- GENERIC(f6)		
measObjectId[2]	IdMeasObject-f1		
measObject[2]	MeasObjectEUTRA- GENERIC(f1)		
}			
reportConfigToAddModList SEQUENCE (SIZE (1..maxReportConfigId)) OF SEQUENCE {	2 entries		
reportConfigId[1]	1		
reportConfig[1]	ReportConfig-A3- Lowerthreshold		
reportConfigId[2]	2		
reportConfig[2]	ReportConfig-A3- Higherthreshold		
}			
measIdToAddModList SEQUENCE (SIZE (1..maxMeasId)) OF SEQUENCE {	2 entries		
measId[1]	1		
measObjectId[1]	IdMeasObject-f1		
reportConfigId[1]	IdReportConfig-A3- Lowerthreshold		
measId[2]	2		
measObjectId[2]	IdMeasObject-f1		
reportConfigId[2]	IdReportConfig-A3- Higherthreshold		
}			
}			

Table 8.3.1.12a.3.3-15: ATTACH ACCEPT for Cell 1 (preamble)

Derivation path: 36.508 Table 4.7.2-1			
Information Element	Value/Remark	Comment	Condition
Equivalent PLMNs	PLMN2		Cell 1

Table 8.3.1.12a.3.3-16: TRACKING AREA UPDATE ACCEPT for Cell 28 (steps 8a4 and 8b5, Table 8.3.1.12a.3.2-2)

Derivation path: 36.508 Table 4.7.2-24			
Information Element	Value/Remark	Comment	Condition
Equivalent PLMNs	PLMN1		Cell 28

8.3.1.13 Measurement configuration control and reporting / Intra E-UTRAN measurements / Periodic reporting (intra-frequency and inter-band measurements)

8.3.1.13.1 Test Purpose (TP)

(1)

```
with { UE in E-UTRA RRC_CONNECTED state and measurement configured for periodic reporting of intra-
frequency cells and inter-band cells }
ensure that {
  when { The UE receives reference signal power for cells on the serving frequency and cells on the
frequency where measurements are configured }
  then { UE sends MeasurementReport message at regular intervals for these cells }
}
```

(2)

```
with { UE in E-UTRA RRC_CONNECTED state and a MeasurementReport message for a configured periodic
measurement reporting of intra-frequency and inter-band cells was sent }
ensure that {
  when { A previously reported cell become unavailable or the UE receives reference signal power on
a reported frequency for a cell which was previously not reported }
  then { UE sends MeasurementReport message at regular intervals for the available intra-frequency
and inter-band cells }
}
```

(3)

```
with { UE in E-UTRA RRC_CONNECTED state and periodic measurement reporting ongoing}
ensure that {
  when { The UE receives a RRCConnectionReconfiguration message removing measIds for periodic
reporting }
  then { UE stops sending MeasurementReport messages for these measIds }
}
```

8.3.1.13.2 Conformance requirements

References: The conformance requirements covered in the current TC are specified in: TS 36.331, clauses 5.3.5.3, 5.5.2.2, 5.5.4.1 and 5.5.5.

[TS 36.331, clause 5.3.5.3]

If the *RRCConnectionReconfiguration* message does not include the *mobilityControlInfo* and the UE is able to comply with the configuration included in this message, the UE shall:

...

- 1> If the *RRCConnectionReconfiguration* message includes the *measConfig*:
- 2> perform the Measurement configuration procedure as specified in 5.5.2;

...

[TS 36.331, clause 5.5.2.2]

The UE shall:

- 1> for each *measId* value included in the received *measIdToRemoveList* that is part of the current UE configuration in *varMeasConfig*:
- 2> remove the entry with the matching *measId* from the *measIdList* within the *VarMeasConfig*;

- 2> remove the measurement reporting entry for this *measId* from the *VarMeasReportList*, if included;
- 2> stop the periodical reporting timer or timer T321, whichever one is running, and reset the associated information (e.g. *timeToTrigger*) for this *measId*;

[TS 36.331, clause 5.5.4.1]

The UE shall:

- 1> for each *measId* included in the *measIdList* within *VarMeasConfig*:
 - ...
 - 2> else:
 - 3> if the corresponding *measObject* concerns E-UTRA:
 - 4> consider any neighbouring cell detected on the associated frequency to be applicable when the concerned cell is not included in the *blackCellsToAddModList* defined within the *VarMeasConfig* for this *measId*;
 - ...
 - 2> if the *purpose* is included and set to ‘*reportStrongestCells*’ or to ‘*reportStrongestCellsForSON*’ and if a (first) measurement result is available for one or more applicable cells:
 - 3> include a measurement reporting entry within the *VarMeasReportList* for this *measId*;
 - 3> set the *numberOfReportsSent* defined within the *VarMeasReportList* for this *measId* to 0;
 - 3> initiate the measurement reporting procedure, as specified in 5.5.5;

NOTE 1: If the *purpose* is set to ‘*reportStrongestCells*’, the UE initiates a first measurement report immediately after the quantity to be reported becomes available for at least either serving cell or one of the applicable cells. If the *purpose* is set to ‘*reportStrongestCellsForSON*’, the UE initiates a first measurement report when it has determined the strongest cells on the associated frequency.

- 2> upon expiry of the periodical reporting timer for this *measId*:
 - 3> initiate the measurement reporting procedure, as specified in 5.5.5;
 - ...

NOTE 2: The UE does not stop the periodical reporting with *triggerType* set to ‘*event*’ or to ‘*periodical*’ while the corresponding measurement is not performed due to the serving cell RSRP being equal to or better than *s-Measure* or due to the measurement gap not being setup.

...

[TS 36.331, clause 5.5.5]

...

For the *measId* for which the measurement reporting procedure was triggered, the UE shall set the *measuredResults* within the *MeasurementReport* message as follows:

- 1> set the *measId* to the measurement identity that triggered the measurement reporting;
- 1> set the *measResultServCell* to include the quantities of serving cell;
- 1> if there is at least one applicable neighbouring cell to report:
 - 2> set the *measResultsNeighCells* to include the best neighbouring cells up to *maxReportCells* in accordance with the following:
 - 3> if the *triggerType* is set to ‘*event*’:

4> include the cells included in the *cellsTriggeredList* as defined within the *VarMeasReportList* for this *measId*;

3> else:

4> include the applicable cells for which the new measurement results became available since the last periodical reporting or since the measurement was initiated or reset;

NOTE 3: The reliability of the report (i.e. the certainty it contains the strongest cells on the concerned frequency) depends on the measurement configuration i.e. the *reportInterval*. The related performance requirements are specified in TS 36.133 [16].

3> for each cell that is included in the *measResultsNeighCells*, include the *physCellId*;

3> if the *triggerType* is set to 'event'; or the *purpose* is set to 'reportStrongestCells' or to 'reportStrongestCellsForSON':

4> for each included cell, include the layer 3 filtered measured results in accordance with the *reportConfig* for this *measId*, ordered as follows:

5> if the *measObject* associated with this *measId* concerns E-UTRA:

6> set the *measResult* to include the quantity(ies) indicated in the *reportQuantity* within the concerned *reportConfig* in order of decreasing *triggerQuantity*, i.e. the best cell is included first;

...

1> increment the *numberOfReportsSent* as defined within the *VarMeasReportList* for this *measId* by 1;

1> stop the periodical reporting timer, if running;

1> if the *numberOfReportsSent* as defined within the *VarMeasReportList* for this *measId* is less than to *reportAmount* as defined corresponding *reportConfig* for this *measId*:

2> start the periodical reporting timer with the value of *reportInterval* as defined within the corresponding *reportConfig* for this *measId*;

...

1> submit the MEASUREMENT REPORT message to lower layers for transmission, upon which the procedure ends.

8.3.1.13.3 Test description

8.3.1.13.3.1 Pre-test conditions

System Simulator:

- Cell 1, Cell 2, and Cell 10
- System information combination 3 as defined in TS 36.508 [18] clause 4.4.3.1 is used in E-UTRA cells.

UE:

None.

Preamble:

- The UE is in state Generic RB Established (state 3) according to [18] on Cell 1.

8.3.1.13.3.2 Test procedure sequence

Table 8.3.1.13.3.2-1 illustrates the downlink power levels to be applied for the cells at various time instants of the test execution. Row marked "T0" denotes the conditions after the preamble, while rows marked "T1" and "T2" are to be applied subsequently. The exact instants on which these values shall be applied are described in the texts in this clause.

Table 8.3.1.13.3.2-1: Power levels

	Parameter	Unit	Cell 1	Cell 2 (DL only)	Cell 10 (DL only)	Remark
T0	Cell-specific RS EPRE	dBm/ 15kHz	-85	-91	Off	
T1	Cell-specific RS EPRE	dBm/ 15kHz	-85	-91	-85	
T2	Cell-specific RS EPRE	dBm/ 15kHz	-85	Off	-85	

Table 8.3.1.13.3.2-2: Main behaviour

St	Procedure	Message Sequence		TP	Verdict
		U - S	Message		
1	SS transmits an <i>RRCCONNECTIONRECONFIGURATION</i> message including <i>measConfig</i> to setup intra LTE measurements and periodical reporting for intra and inter-band cells.	<--	<i>RRCCONNECTIONRECONFIGURATION</i>	-	-
2	The UE transmits an <i>RRCCONNECTIONRECONFIGURATIONCOMPLETE</i> message.	-->	<i>RRCCONNECTIONRECONFIGURATIONCOMPLETE</i>	-	-
3	Void	-	-	-	-
-	EXCEPTION: In parallel to events described in step 4 the steps specified in table 8.3.1.13.3.2-3, and the table 8.3.1.13.3.2-4A shall take place				
4	Wait for 30 s to ensure that the UE performs a periodical intra-frequency reporting and a periodical inter-band reporting.	-	-	1	-
5	SS sets the cell-specific reference signal levels and switches Cell 10 "On" according to row "T1" in table 8.3.1.13.3.2-1.	-	-	-	-
6	Wait and ignore <i>MEASUREMENTREPORT</i> messages for 8s to allow for the switching of cells and the UE measurement.	-	-	-	-
-	EXCEPTION: In parallel to events described in step 7 the steps specified in table 8.3.1.13.3.2-3, and table 8.3.1.13.3.2-4 shall take place.				
7	Wait for 30 s to ensure that the UE performs a periodical intra-frequency reporting and a periodical inter-band reporting.	-	-	1, 2	-
8	SS sets the cell-specific reference signal levels and switches Cell 2 "Off" according to row "T2" in table 8.3.1.13.3.2-1.	-	-	-	-
9	Wait and ignore <i>MEASUREMENTREPORT</i> messages for 20 s to allow for the switching of cells and UE measurement.	-	-	-	-
-	EXCEPTION: In parallel to events described in steps 9 to 11 the steps specified in table 8.3.1.13.3.2-3A and the table 8.3.1.13.3.2-4 shall take place				
10	Wait for 30 s to ensure that the UE performs a periodical intra-frequency reporting and a periodical inter-band reporting.	-	-	1, 2	-
11	SS transmits an <i>RRCCONNECTIONRECONFIGURATION</i> message including <i>measConfig</i> to remove measIds for periodical reporting.	<--	<i>RRCCONNECTIONRECONFIGURATION</i>	-	-
12	The UE transmits an <i>RRCCONNECTIONRECONFIGURATIONCOMPLETE</i> message	-->	<i>RRCCONNECTIONRECONFIGURATIONCOMPLETE</i>	-	-
13	Check: Does the UE attempt to transmit an uplink message for the next 10s?	-	-	3	F

Table 8.3.1.13.3.2-3: Parallel behaviour

St	Procedure	Message Sequence		TP	Verdict
		U - S	Message		
-	EXCEPTION: After the 1st message is received, step 1 below shall be repeated every time the duration indicated in the IE <i>reportInterval</i> has elapsed	-	-	-	-
1	Check: Does the UE transmit a <i>MeasurementReport</i> message to perform periodical intra-frequency reporting for Cell 2(NOTE1)?	-->	<i>MeasurementReport</i>	1	P

NOTE 1: In the first report UE may not include measResultNeighCells for cell 2.

Table 8.3.1.13.3.2-3A: Parallel behaviour

St	Procedure	Message Sequence		TP	Verdict
		U - S	Message		
-	EXCEPTION: After the 1st message is received, step 1 below shall be repeated every time the duration indicated in the IE <i>reportInterval</i> has elapsed	-	-	-	-
1	Check: Does the UE transmit a <i>MeasurementReport</i> message to perform periodical intra-frequency reporting configured for cell 2 and without measResultNeighCells for the cell 2?	-->	<i>MeasurementReport</i>	1	P

Table 8.3.1.13.3.2-4: Parallel behaviour

St	Procedure	Message Sequence		TP	Verdict
		U - S	Message		
-	EXCEPTION: After the 1st message is received, step 1 below shall be repeated every time the duration indicated in the IE <i>reportInterval</i> has elapsed.	-	-	-	-
1	Check: Does the UE transmit a <i>MeasurementReport</i> message to perform periodical inter-band reporting for Cell 10(NOTE2)?	-->	<i>MeasurementReport</i>	1	P

NOTE 2: In the first report UE may not include measResultNeighCells for the cell 10.

Table 8.3.1.13.3.2-4A: Parallel behaviour

St	Procedure	Message Sequence		TP	Verdict
		U - S	Message		
-	EXCEPTION: After the 1st message is received, step 1 below shall be repeated every time the duration indicated in the IE <i>reportInterval</i> has elapsed.	-	-	-	-
1	Check: Does the UE transmit a <i>MeasurementReport</i> message to perform periodical inter-band reporting configured for cell 10 and without measResultNeighCells for the cell 10?	-->	<i>MeasurementReport</i>	1	P

8.3.1.13.3.3 Specific message contents

Table 8.3.1.13.3.3-1: RRCConnectionReconfiguration (step 1 and step 11, Table 8.3.1.13.3.2-2)

Derivation Path: 36.508 clause 4.6.1 table 4.6.1-8 with condition MEAS

Table 8.3.1.13.3.3-2: *MeasConfig* (step 1, Table 8.3.1.13.3.2-2)

Derivation Path: 36.508, Table 4.6.6-1, condition INTER-FREQ			
Information Element	Value/remark	Comment	Condition
MeasConfig ::= SEQUENCE {			
measObjectToAddModList SEQUENCE (SIZE (1..maxObjectId)) OF SEQUENCE {	2 entries		
measObjectId[1]	IdMeasObject-f1		
measObject[1]	MeasObjectEUTRA-GENERIC(f1)		
measObjectId[2]	IdMeasObject-f5		
measObject[2]	MeasObjectEUTRA-GENERIC(f5)		
}			
reportConfigToAddModList SEQUENCE (SIZE (1..maxReportConfigId)) OF SEQUENCE {	1 entry		
reportConfigId[1]	IdReportConfig-PERIODICAL		
reportConfig[1]	ReportConfigEUTRA-PERIODICAL		
}			
measIdToAddModList SEQUENCE (SIZE (1..maxMeasId)) OF SEQUENCE {	2 entries		
measId[1]	1		
measObjectId[1]	IdMeasObject-f1		
reportConfigId[1]	IdReportConfig-PERIODICAL		
measId[2]	2		
measObjectId[2]	IdMeasObject-f5		
reportConfigId[2]	IdReportConfig-PERIODICAL		
}			
}			

Table 8.3.1.13.3.3-4: *MeasConfig* (step 11, Table 8.3.1.13.3.2-2)

Derivation Path: 36.508, Table 4.6.6-1			
Information Element	Value/remark	Comment	Condition
MeasConfig ::= SEQUENCE {			
measIdToRemoveList SEQUENCE (SIZE (1..maxMeasId)) OF SEQUENCE {	2 entries		
MeasId[1]	1		
MeasId[2]	2		
}			
}			

Table 8.3.1.13.3.3-5: MeasurementReport (step 1, Table 8.3.1.13.3.2-3)

Derivation Path: 36.508 clause 4.6.1 table 4.6.1-5			
Information Element	Value/remark	Comment	Condition
MeasurementReport ::= SEQUENCE {			
criticalExtensions CHOICE {			
c1 CHOICE {			
measurementReport-r8 SEQUENCE {			
measResults ::= SEQUENCE {			
measId	1		
measResultServCell ::= SEQUENCE {		Report Cell 1	
rsrpResult	(0..97)		
rsrqResult	(0..34)		
}			
measResultNeighCells CHOICE {			
measResultListEUTRA ::= SEQUENCE (SIZE (1..maxCellReport)) OF SEQUENCE {		Report Cell 2	
physCellId [1]	physicalCellIdentity-Cell2		
measResult [1] SEQUENCE {			
rsrpResult	(0..97)		
rsrqResult	(0..34)		
}			
}			
measResultForECID-r9	Not present		
}			
}			
}			
}			

Table 8.3.1.13.3.3-5A: MeasurementReport (step 1, Table 8.3.1.13.3.2-3A)

Derivation Path: 36.508 clause 4.6.1 table 4.6.1-5			
Information Element	Value/remark	Comment	Condition
MeasurementReport ::= SEQUENCE {			
criticalExtensions CHOICE {			
c1 CHOICE {			
measurementReport-r8 SEQUENCE {			
measResults ::= SEQUENCE {			
measId	1		
measResultServCell ::= SEQUENCE {		Report Cell 1	
rsrpResult	(0..97)		
rsrqResult	(0..34)		
}			
measResultNeighCells CHOICE {}	Not present		
measResultForECID-r9	Not present		
}			
}			
}			
}			

Table 8.3.1.13.3.3-6: MeasurementReport (step 1, Table 8.3.1.13.3.2-4)

Derivation Path: 36.508 clause 4.6.1 table 4.6.1-5			
Information Element	Value/remark	Comment	Condition
MeasurementReport ::= SEQUENCE {			
criticalExtensions CHOICE {			
c1 CHOICE {			
measurementReport-r8 SEQUENCE {			
measResults ::= SEQUENCE {			
measId	2		
measResultServCell ::= SEQUENCE {		Report Cell 1	
rsrpResult	(0..97)		
rsrqResult	(0..34)		
}			
measResultNeighCells CHOICE {			
measResultListEUTRA ::= SEQUENCE (SIZE (1..maxCellReport)) OF SEQUENCE {		Report Cell 10	
physCellId [1]	physicalCellIdentity-Cell10		
measResult [1] SEQUENCE {			
rsrpResult	(0..97)		
rsrqResult	(0..34)		
}			
}			
measResultForECID-r9	Not present		
}			
}			
}			
}			

Table 8.3.1.13.3.3-6A: MeasurementReport (step 1, Table 8.3.1.13.3.2-4A)

Derivation Path: 36.508 clause 4.6.1 table 4.6.1-5			
Information Element	Value/remark	Comment	Condition
MeasurementReport ::= SEQUENCE {			
criticalExtensions CHOICE {			
c1 CHOICE {			
measurementReport-r8 SEQUENCE {			
measResults ::= SEQUENCE {			
measId	2		
measResultServCell ::= SEQUENCE {		Report Cell 1	
rsrpResult	(0..97)		
rsrqResult	(0..34)		
}			
measResultNeighCells CHOICE {	Not present		
measResultForECID-r9	Not present		
}			
}			
}			
}			

8.3.1.13a Measurement configuration control and reporting / Intra E-UTRAN measurements / Periodic reporting (intra-frequency and inter-band measurements) / Between FDD and TDD

8.3.1.13a.1 Test Purpose (TP)

(1)

with { UE in E-UTRA FDD RRC_CONNECTED state and measurement configured for periodic reporting of intra frequency cells and inter-band E-UTRA TDD cells on specified frequency }

```

ensure that {
  when { The UE receives reference signal power for cells on the serving frequency and cells on the
frequency where measurements are configured }
  then { UE sends MeasurementReport message at regular intervals for these cells }
}

```

(2)

```

with { UE in E-UTRA FDD RRC_CONNECTED state and a MeasurementReport message for a configured
periodic measurement reporting of intra frequency and inter-band E-UTRA TDD cells was sent }
ensure that {
  when { A previously reported cell becomes unavailable or the UE receives reference signal power on a
reported frequency for a cell which was previously not reported }
  then { UE sends MeasurementReport message at regular intervals for the available intra frequency
and inter-band E-UTRA TDD cells }
}

```

(3)

```

with { UE in E-UTRA FDD RRC_CONNECTED state and periodic measurement reporting ongoing }
ensure that {
  when { The UE receives a RRCConnectionReconfiguration message removing measIds for periodic
reporting }
  then { UE stops sending MeasurementReport messages for these measIds }
}

```

(4)

```

with { UE in E-UTRA TDD RRC_CONNECTED state and measurement configured for periodic reporting of
intra frequency cells and inter-band E-UTRA FDD cells on specified frequency }
ensure that {
  when { The UE receives reference signal power for cells on the serving frequency and cells on the
frequency where measurements are configured }
  then { UE sends MeasurementReport message at regular intervals for these cells }
}

```

(5)

```

with { UE in E-UTRA TDD RRC_CONNECTED state and a MeasurementReport message for a configured
periodic measurement reporting of intra frequency and inter-band E-UTRA FDD cells was sent }
ensure that {
  when { A previously reported cell becomes unavailable or the UE receives reference signal power on a
reported frequency for a cell which was previously not reported }
  then { UE sends MeasurementReport message at regular intervals for the available intra frequency
and inter-band E-UTRA FDD cells }
}

```

(6)

```

with { UE in E-UTRA TDD RRC_CONNECTED state and periodic measurement reporting ongoing }
ensure that {
  when { The UE receives a RRCConnectionReconfiguration message removing measIds for periodic
reporting }
  then { UE stops sending MeasurementReport messages for these measIds }
}

```

8.3.1.13a.2 Conformance requirements

References: The conformance requirements covered in the current TC are specified in: TS 36.331, clauses 5.3.5.3, 5.5.2.2, 5.5.4.1 and 5.5.5.

[TS 36.331, clause 5.3.5.3]

If the *RRCConnectionReconfiguration* message does not include the *mobilityControlInfo* and the UE is able to comply with the configuration included in this message, the UE shall:

...

- 1> If the *RRCConnectionReconfiguration* message includes the *measConfig*:
- 2> perform the Measurement configuration procedure as specified in 5.5.2;

...

[TS 36.331, clause 5.5.2.2]

The UE shall:

- 1> for each *measId* value included in the received *measIdToRemoveList* that is part of the current UE configuration in *varMeasConfig*:
 - 2> remove the entry with the matching *measId* from the *measIdList* within the *VarMeasConfig*;
 - 2> remove the measurement reporting entry for this *measId* from the *VarMeasReportList*, if included;
 - 2> stop the periodical reporting timer or timer T321, whichever one is running, and reset the associated information (e.g. *timeToTrigger*) for this *measId*;

[TS 36.331, clause 5.5.4.1]

The UE shall:

- 1> for each *measId* included in the *measIdList* within *VarMeasConfig*:

...

2> else:

- 3> if the corresponding *measObject* concerns E-UTRA:

- 4> consider any neighbouring cell detected on the associated frequency to be applicable when the concerned cell is not included in the *blackCellsToAddModList* defined within the *VarMeasConfig* for this *measId*;

...

- 2> if the *purpose* is included and set to '*reportStrongestCells*' or to '*reportStrongestCellsForSON*' and if a (first) measurement result is available for one or more applicable cells:

- 3> include a measurement reporting entry within the *VarMeasReportList* for this *measId*;
- 3> set the *numberOfReportsSent* defined within the *VarMeasReportList* for this *measId* to 0;
- 3> initiate the measurement reporting procedure, as specified in 5.5.5;

NOTE 1: If the *purpose* is set to '*reportStrongestCells*', the UE initiates a first measurement report immediately after the quantity to be reported becomes available for at least either serving cell or one of the applicable cells. If the *purpose* is set to '*reportStrongestCellsForSON*', the UE initiates a first measurement report when it has determined the strongest cells on the associated frequency.

- 2> upon expiry of the periodical reporting timer for this *measId*:

- 3> initiate the measurement reporting procedure, as specified in 5.5.5;

...

NOTE 2: The UE does not stop the periodical reporting with *triggerType* set to '*event*' or to '*periodical*' while the corresponding measurement is not performed due to the serving cell RSRP being equal to or better than *s-Measure* or due to the measurement gap not being setup.

...

[TS 36.331, clause 5.5.5]

...

For the *measId* for which the measurement reporting procedure was triggered, the UE shall set the *measuredResults* within the *MeasurementReport* message as follows:

- 1> set the *measId* to the measurement identity that triggered the measurement reporting;

- 1> set the *measResultServCell* to include the quantities of serving cell;
- 1> if there is at least one applicable neighbouring cell to report:
 - 2> set the *measResultsNeighCells* to include the best neighbouring cells up to *maxReportCells* in accordance with the following:
 - 3> if the *triggerType* is set to 'event':
 - 4> include the cells included in the *cellsTriggeredList* as defined within the *VarMeasReportList* for this *measId*;
 - 3> else:
 - 4> include the applicable cells for which the new measurement results became available since the last periodical reporting or since the measurement was initiated or reset;

NOTE 3: The reliability of the report (i.e. the certainty it contains the strongest cells on the concerned frequency) depends on the measurement configuration i.e. the *reportInterval*. The related performance requirements are specified in TS 36.133 [16].

- 3> for each cell that is included in the *measResultsNeighCells*, include the *physCellId*;
- 3> if the *triggerType* is set to 'event'; or the *purpose* is set to 'reportStrongestCells' or to 'reportStrongestCellsForSON':
 - 4> for each included cell, include the layer 3 filtered measured results in accordance with the *reportConfig* for this *measId*, ordered as follows:
 - 5> if the *measObject* associated with this *measId* concerns E-UTRA:
 - 6> set the *measResult* to include the quantity(ies) indicated in the *reportQuantity* within the concerned *reportConfig* in order of decreasing *triggerQuantity*, i.e. the best cell is included first;
 - ...
- 1> increment the *numberOfReportsSent* as defined within the *VarMeasReportList* for this *measId* by 1;
- 1> stop the periodical reporting timer, if running;
- 1> if the *numberOfReportsSent* as defined within the *VarMeasReportList* for this *measId* is less than to *reportAmount* as defined corresponding *reportConfig* for this *measId*:
 - 2> start the periodical reporting timer with the value of *reportInterval* as defined within the corresponding *reportConfig* for this *measId*;

...

- 1> submit the MEASUREMENT REPORT message to lower layers for transmission, upon which the procedure ends.

8.3.1.13a.3 Test description

8.3.1.13a.3.1 Pre-test conditions

System Simulator:

- Cell 1, Cell 2 and Cell 4 are E-UTRA FDD cells, Cell 10 and Cell 30 are E-UTRA TDD cells.
- Each cell has only a single PLMN identity. The PLMNs are identified in the test by the identifiers in Table 8.3.1.13 a.3.1-1.

Table 8.3.1.13a.3.1-1: PLMN identifiers

Cell	PLMN name
1	PLMN1
2	PLMN1
4	PLMN1
10	PLMN1
30	PLMN2

- System information combination 3 as defined in TS 36.508 [18] clause 4.4.3.1 and Table 6.3.1.2-2 is used in E-UTRA cells.

UE:

None.

Preamble:

- The UE is registered on PLMN1 (Cell 1) using the procedure described in TS 36.508[18] clause 4.5.2.3 except that the ATTACH ACCEPT message indicates PLMN2 in the Equivalent PLMN list as described in Table 8.3.1.13a.3.3-16.
- The UE is in state Generic RB Established (state 3) according to [18] on Cell 1.

8.3.1.13a.3.2 Test procedure sequence

Table 8.3.1.13a.3.2-1 illustrates the downlink power levels to be applied for the cells at various time instants of the test execution. Row marked "T0" denotes the conditions after the preamble, while rows marked "T1", "T2", "T3" and "T4", are to be applied subsequently. The exact instants on which these values shall be applied are described in the texts in this clause.

Table 8.3.1.13a.3.2-1: Power levels

	Parameter	Unit	Cell 1	Cell 2(DL only)	Cell 4(DL only)	Cell 10(DL only)	Cell 30	Remark
T0	Cell-specific RS EPRE	dBm/1 5kHz	-85	-91	Off	-85	Off	
T1	Cell-specific RS EPRE	dBm/1 5kHz	-85	Off	-91	-85	Off	
T2	Cell-specific RS EPRE	dBm/1 5kHz	-85	Off	-91	Off	-73	
T3	Cell-specific RS EPRE	dBm/1 5kHz	Off	-91	Off	-91	-85	
T4	Cell-specific RS EPRE	dBm/1 5kHz	Off	Off	-91	-91	-85	

Table 8.3.1.13a.3.2-2: Main behaviour

St	Procedure	Message Sequence		TP	Verdict
		U - S	Message		
1	SS transmits an <i>RRConnectionReconfiguration</i> message including <i>measConfig</i> to setup intra LTE measurements and periodical reporting for intra frequency and inter-band cells.	<--	<i>RRConnectionReconfiguration</i>	-	-
2	The UE transmits an <i>RRConnectionReconfigurationComplete</i> message.	-->	<i>RRConnectionReconfigurationComplete</i>	-	-
2A	Wait and ignore <i>MeasurementReport</i> messages for 8 s to allow for the switching of the cells and UE to measure the neighbouring cells.	-	-	-	-
-	EXCEPTION: In parallel to events described in step 3 the steps specified in table 8.3.1.13a.3.2-3 and table 8.3.1.13a.3.2-5 shall take place				
3	Wait for 30 s to ensure that the UE performs a periodical intra frequency reporting for Cell 2 and a periodical inter-band reporting for Cell 10.	-	-	1	-
4	SS re-adjusts the cell-specific reference signal levels according to row "T1" in table 8.3.1.13a.3.2-1.	-	-	-	-
5	Wait and ignore <i>MeasurementReport</i> messages for 8 s to allow for the switching of Cell 2 and UE to measure the neighbouring cells.	-	-	-	-
-	EXCEPTION: In parallel to events described in step 6 the steps specified in table 8.3.1.13a.3.2-4 and table 8.3.1.13a.3.2-5 shall take place.				
6	Wait for 30 s to ensure that the UE performs a periodical intra frequency reporting for Cell 4 and a periodical inter-band reporting for Cell 10.	-	-	1, 2	-
7	SS re-adjusts the cell-specific reference signal levels according to row "T2" in table 8.3.1.13a.3.2-1.	-	-	-	-
8	Wait and ignore <i>MeasurementReport</i> messages for 8 s to allow for the switching of Cell 10 and UE to measure the neighbouring cells.	-	-	-	-
-	EXCEPTION: In parallel to events described in steps 9 to 11 the steps specified in table 8.3.1.13a.3.2-4 and table 8.3.1.13a.3.2-9 shall take place	-	-	-	-
9	Wait for 30 s to ensure that the UE performs a periodical intra frequency reporting for Cell 4 and a periodical inter-band reporting for Cell 30.	-	-	1, 2	-
10	SS transmits an <i>RRConnectionReconfiguration</i> message including <i>measConfig</i> to remove measIds for periodical reporting.	<--	<i>RRConnectionReconfiguration</i>	-	-
11	The UE transmits an <i>RRConnectionReconfigurationComplete</i> message	-->	<i>RRConnectionReconfigurationComplete</i>	-	-
12	Check: Does the UE attempt to transmit an uplink message for the next 10s?	-	-	3	F
-	EXCEPTION: Steps 13a1 to 13b3 describe behaviour that depends on the UE capability that if UE has set FGI bit 30 to 1; the "lower case letter" identifies a step sequence that takes place if a capability is supported.	-	-	-	-

13a 1	IF pc_FeatrGrp_30 THEN the SS transmits an <i>RRCCONNECTIONRECONFIGURATION</i> message on Cell 1 to order the UE to perform inter band handover to Cell 30.	<--	<i>RRCCONNECTIONRECONFIGURATION</i>	-	-
13a 2	The UE transmits an <i>RRCCONNECTIONRECONFIGURATIONCOMPLETE</i> message on Cell 30 to confirm the handover	-->	<i>RRCCONNECTIONRECONFIGURATIONCOMPLETE</i>	-	-
13a 3	The UE transmits a TRACKING AREA UPDATE REQUEST message on Cell 30.	-	-	-	-
13a 4	SS responds with a TRACKING AREA UPDATE ACCEPT message. NOTE: The TAU is accepted with PLMN1 listed as an Equivalent PLMN	-	-	-	-
13a 5	The UE transmits a TRACKING AREA UPDATE COMPLETE message.	-	-	-	-
13b 1	ELSE IF NOT pc_FeatrGrp_30 THEN the SS transmits an <i>RRCCONNECTIONRELEASE</i> message (IE <i>redirectedCarrierInfo</i> including eutra CarrierFreq of Cell 30) on Cell 1	<--	<i>RRCCONNECTIONRELEASE</i>	-	-
13b 2	The generic test procedure described in TS 36.508 subclause 6.4.2.7 is performed on Cell 30 NOTE: The TAU is accepted with PLMN1 listed as an Equivalent PLMN	-	-	-	-
13b 3	Generic test procedure described in TS 36.508 subclause 4.5.3.3.is executed	-	-	-	-
14	SS re-adjusts the cell-specific reference signal levels according to row "T3" in table 8.3.1.13a.3.2-1.	-	-	-	-
15	SS transmits an <i>RRCCONNECTIONRECONFIGURATION</i> message including <i>measConfig</i> to setup intra LTE measurements and periodical reporting for intra frequency and inter-band cells.	<--	<i>RRCCONNECTIONRECONFIGURATION</i>	-	-
16	The UE transmits an <i>RRCCONNECTIONRECONFIGURATIONCOMPLETE</i> message.	-->	<i>RRCCONNECTIONRECONFIGURATIONCOMPLETE</i>	-	-
16 A	Wait and ignore <i>MeasurementReport</i> messages for 8 s to allow for the switching of Cell 4 and UE to measure the neighbouring cells.	-	-	-	-
-	EXCEPTION: In parallel to events described in step 17 the steps specified in table 8.3.1.13a.3.2-6 and table 8.3.1.13a.3.2-8 shall take place.				
17	Wait for 30 s to ensure that the UE performs a periodical intra frequency reporting for Cell 10 and a periodical inter-band reporting for Cell 2.	-	-	4,5	-
18	SS re-adjusts the cell-specific reference signal levels according to row "T4" in table 8.3.1.13a.3.2-1.	-	-	-	-
19	Wait and ignore <i>MeasurementReport</i> messages for 8 s to allow for the switching of Cell2 and UE to measure the neighbouring cells.	-	-	-	-
-	EXCEPTION: In parallel to events described in steps 21 to 22 the steps specified in table 8.3.1.13a.3.2-7 and table 8.3.1.13a.3.2-8 shall take place	-	-	-	-
20	Wait for 30 s to ensure that the UE performs a periodical intra frequency reporting for Cell 10 and a periodical inter-band reporting for Cell 4.	-	-	4,5	-
21	SS transmits an <i>RRCCONNECTIONRECONFIGURATION</i> message including <i>measConfig</i> to remove measIds for periodical reporting.	<--	<i>RRCCONNECTIONRECONFIGURATION</i>	-	-
22	The UE transmits an <i>RRCCONNECTIONRECONFIGURATIONCOMPLETE</i>	-->	<i>RRCCONNECTIONRECONFIGURATIONCOMPLETE</i>	-	-

	message				
23	Check: Does the UE attempt to transmit an uplink message for the next 10s?	-	-	6	F

Table 8.3.1.13a.3.2-3: Parallel behaviour

St	Procedure	Message Sequence		TP	Verdict
		U - S	Message		
-	EXCEPTION: After the 1st message is received, step 1 below shall be repeated every time the duration indicated in the IE <i>reportInterval</i> has elapsed	-	-	-	-
1	Check: Does the UE transmit a <i>MeasurementReport</i> message to perform periodical intra frequency reporting for Cell 2(NOTE1)?	-->	<i>MeasurementReport</i>	1	P

NOTE 1: In the first report UE may not include measResultNeighCells for cell 2.

Table 8.3.1.13a.3.2-4: Parallel behaviour

St	Procedure	Message Sequence		TP	Verdict
		U - S	Message		
-	EXCEPTION: Step 1 below shall be repeated every time the duration indicated in the IE <i>reportInterval</i> has elapsed.	-	-	-	-
1	Check: Does the UE transmit a <i>MeasurementReport</i> message to perform periodical intra frequency reporting for Cell 4(NOTE2)?	-->	<i>MeasurementReport</i>	1, 2	P

NOTE 2: In the first report UE may not include measResultNeighCells for the cell 4.

Table 8.3.1.13a.3.2-5: Parallel behaviour

St	Procedure	Message Sequence		TP	Verdict
		U - S	Message		
-	EXCEPTION: After the 1st message is received, step 1 below shall be repeated every time the duration indicated in the IE <i>reportInterval</i> has elapsed.	-	-	-	-
1	Check: Does the UE transmit a <i>MeasurementReport</i> message to perform periodical inter-band reporting for Cell 10(NOTE3)?	-->	<i>MeasurementReport</i>	1	P

NOTE 3: In the first report UE may not include measResultNeighCells for the cell 10.

Table 8.3.1.13a.3.2-6: Parallel behaviour

St	Procedure	Message Sequence		TP	Verdict
		U - S	Message		
-	EXCEPTION: After the 1st message is received, step 1 below shall be repeated every time the duration indicated in the IE <i>reportInterval</i> has elapsed	-	-	-	-
1	Check: Does the UE transmit a <i>MeasurementReport</i> message to perform periodical inter band reporting for Cell 2(NOTE4)?	-->	<i>MeasurementReport</i>	4	P

NOTE 4: In the first report UE may not include measResultNeighCells for cell 2.

Table 8.3.1.13a.3.2-7: Parallel behaviour

St	Procedure	Message Sequence		TP	Verdict
		U - S	Message		
-	EXCEPTION: Step 1 below shall be repeated every time the duration indicated in the IE <i>reportInterval</i> has elapsed.	-	-	-	-
1	Check: Does the UE transmit a <i>MeasurementReport</i> message to perform periodical inter band reporting for Cell 4 (NOTE5)?	-->	<i>MeasurementReport</i>	4,5	P

NOTE 5: In the first report UE may not include measResultNeighCells for the cell 4.

Table 8.3.1.13a.3.2-8: Parallel behaviour

St	Procedure	Message Sequence		TP	Verdict
		U - S	Message		
-	EXCEPTION: After the 1st message is received, step 1 below shall be repeated every time the duration indicated in the IE <i>reportInterval</i> has elapsed.	-	-	-	-
1	Check: Does the UE transmit a <i>MeasurementReport</i> message to perform periodical intra frequency reporting for Cell 10 (NOTE6)?	-->	<i>MeasurementReport</i>	4	P

NOTE 6: In the first report UE may not include measResultNeighCells for the cell 10.

Table 8.3.1.13a.3.2-9: Parallel behaviour

St	Procedure	Message Sequence		TP	Verdict
		U - S	Message		
-	EXCEPTION: After the 1st message is received, step 1 below shall be repeated every time the duration indicated in the IE <i>reportInterval</i> has elapsed.	-	-	-	-
1	Check: Does the UE transmit a <i>MeasurementReport</i> message to perform periodical inter band reporting for Cell 30 (NOTE7)?	-->	<i>MeasurementReport</i>	1, 2	P

NOTE 7: In the first report UE may not include measResultNeighCells for the cell 30.

8.3.1.13a.3.3 Specific message contents

Table 8.3.1.13a.3.3-1: *RRConnectionReconfiguration* (step 1, step10, step 15 and step 21, Table 8.3.1.13a.3.2-2)

Derivation Path: 36.508 clause 4.6.1 table 4.6.1-8 with condition MEAS
--

Table 8.3.1.13a.3.3-2: *MeasConfig* (step 1, Table 8.3.1.13a.3.2-2)

Derivation Path: 36.508, Table 4.6.6-1, condition INTER-FREQ			
Information Element	Value/remark	Comment	Condition
<i>MeasConfig</i> ::= SEQUENCE {			
<i>measObjectToAddModList</i> SEQUENCE (SIZE (1..maxObjectId)) OF SEQUENCE {	2 entries		
<i>measObjectId</i> [1]	IdMeasObject-f1		
<i>measObject</i> [1]	MeasObjectEUTRA-GENERIC(f1)		
<i>measObjectId</i> [2]	IdMeasObject-f5		
<i>measObject</i> [2]	MeasObjectEUTRA-GENERIC(f5)		
}			
<i>reportConfigToAddModList</i> SEQUENCE (SIZE (1..maxReportConfigId)) OF SEQUENCE {	1 entry		
<i>reportConfigId</i> [1]	IdReportConfig-PERIODICAL		
<i>reportConfig</i> [1]	ReportConfigEUTRA-PERIODICAL		
}			
<i>measIdToAddModList</i> SEQUENCE (SIZE (1..maxMeasId)) OF SEQUENCE {	2 entries		
<i>measId</i> [1]	1		
<i>measObjectId</i> [1]	IdMeasObject-f1		
<i>reportConfigId</i> [1]	IdReportConfig-PERIODICAL		
<i>measId</i> [2]	2		
<i>measObjectId</i> [2]	IdMeasObject-f5		
<i>reportConfigId</i> [2]	IdReportConfig-PERIODICAL		
}			
}			

Table 8.3.1.13a.3.3-3: *MeasConfig* (step 10, Table 8.3.1.13a.3.2-2)

Derivation Path: 36.508, Table 4.6.6-1			
Information Element	Value/remark	Comment	Condition
<i>MeasConfig</i> ::= SEQUENCE {			
<i>measIdToRemoveList</i> SEQUENCE (SIZE (1..maxMeasId)) OF SEQUENCE {	2 entries		
<i>MeasId</i> [1]	1		
<i>MeasId</i> [2]	2		
}			
}			

Table 8.3.1.13a.3.3-4: MeasurementReport (step 1, Table 8.3.1.13a.3.2-3)

Derivation Path: 36.508 clause 4.6.1 table 4.6.1-5			
Information Element	Value/remark	Comment	Condition
MeasurementReport ::= SEQUENCE {			
criticalExtensions CHOICE {			
c1 CHOICE {			
measurementReport-r8 SEQUENCE {			
measResults ::= SEQUENCE {			
measId	1		
measResultServCell ::= SEQUENCE {		Report Cell 1	
rsrpResult	(0..97)		
rsrqResult	(0..34)		
}			
measResultNeighCells CHOICE {			
measResultListEUTRA ::= SEQUENCE (SIZE (1..maxCellReport)) OF SEQUENCE {		Report Cell 2	
physCellId [1]	physicalCellIdentity-Cell2		
measResult [1] SEQUENCE {			
rsrpResult	(0..97)		
rsrqResult	(0..34)		
}			
}			
}			
}			
}			
}			
}			

Table 8.3.1.13a.3.3-5: MeasurementReport (step 1, Table 8.3.1.13a.3.2-4)

Derivation Path: 36.508 clause 4.6.1 table 4.6.1-5			
Information Element	Value/remark	Comment	Condition
MeasurementReport ::= SEQUENCE {			
criticalExtensions CHOICE {			
c1 CHOICE {			
measurementReport-r8 SEQUENCE {			
measResults ::= SEQUENCE {			
measId	1		
measResultServCell ::= SEQUENCE {		Report Cell 1	
rsrpResult	(0..97)		
rsrqResult	(0..34)		
}			
measResultNeighCells CHOICE {			
measResultListEUTRA ::= SEQUENCE (SIZE (1..maxCellReport)) OF SEQUENCE {		Report Cell 4	
physCellId [1]	physicalCellIdentity-Cell4		
measResult [1] SEQUENCE {			
rsrpResult	(0..97)		
rsrqResult	(0..34)		
}			
}			
}			
}			
}			
}			
}			

Table 8.3.1.13a.3.3-6: MeasurementReport (step 1, Table 8.3.1.13a.3.2-5)

Derivation Path: 36.508 clause 4.6.1 table 4.6.1-5			
Information Element	Value/remark	Comment	Condition
MeasurementReport ::= SEQUENCE {			
criticalExtensions CHOICE {			
c1 CHOICE {			
measurementReport-r8 SEQUENCE {			
measResults ::= SEQUENCE {			
measId	2		
measResultServCell ::= SEQUENCE {		Report Cell 1	
rsrpResult	(0..97)		
rsrqResult	(0..34)		
}			
measResultNeighCells CHOICE {			
measResultListEUTRA ::= SEQUENCE (SIZE (1..maxCellReport)) OF SEQUENCE {		Report Cell 10	
physCellId [1]	physicalCellIdentity-Cell10		
measResult [1] SEQUENCE {			
rsrpResult	(0..97)		
rsrqResult	(0..34)		
}			
}			
}			
}			
}			
}			
}			

Table 8.3.1.13a.3.3-7: RRCConnectionReconfiguration (step 13a1, Table 8.3.1.13a.3.2-2)

Derivation Path: 36.508, Table 4.6.1-8, condition HO
--

Table 8.3.1.13a.3.3-8: MobilityControlInfo (step 13a1, Table 8.3.1.13a.3.2-2)

Derivation Path: 36.508, Table 4.6.5-1			
Information Element	Value/remark	Comment	Condition
MobilityControlInfo ::= SEQUENCE {			
targetPhysCellId	PhysicalCellIdentity of Cell 30		
carrierFreq SEQUENCE {			
dl-CarrierFreq	Same downlink EARFCN as used for Cell 30		
ul-CarrierFreq	Not present		
}			
}			

Table 8.3.1.13a.3.3-9: *MeasConfig* (step 15, Table 8.3.1.13a.3.2-2)

Derivation Path: 36.508, Table 4.6.6-1, condition INTER-FREQ			
Information Element	Value/remark	Comment	Condition
<i>MeasConfig</i> ::= SEQUENCE {			
<i>measObjectToAddModList</i> SEQUENCE (SIZE (1..maxObjectId)) OF SEQUENCE {	2 entries		
<i>measObjectId</i> [1]	IdMeasObject-f5		
<i>measObject</i> [1]	MeasObjectEUTRA-GENERIC(f5)		
<i>measObjectId</i> [2]	IdMeasObject-f1		
<i>measObject</i> [2]	MeasObjectEUTRA-GENERIC(f1)		
}			
<i>reportConfigToAddModList</i> SEQUENCE (SIZE (1..maxReportConfigId)) OF SEQUENCE {	1 entry		
<i>reportConfigId</i> [1]	IdReportConfig-PERIODICAL		
<i>reportConfig</i> [1]	ReportConfigEUTRA-PERIODICAL		
}			
<i>measIdToAddModList</i> SEQUENCE (SIZE (1..maxMeasId)) OF SEQUENCE {	2 entries		
<i>measId</i> [1]	1		
<i>measObjectId</i> [1]	IdMeasObject-f5		
<i>reportConfigId</i> [1]	IdReportConfig-PERIODICAL		
<i>measId</i> [2]	2		
<i>measObjectId</i> [2]	IdMeasObject-f1		
<i>reportConfigId</i> [2]	IdReportConfig-PERIODICAL		
}			
}			

Table 8.3.1.13a.3.3-10: *MeasConfig* (step 21, Table 8.3.1.13a.3.2-2)

Derivation Path: 36.508, Table 4.6.6-1			
Information Element	Value/remark	Comment	Condition
<i>MeasConfig</i> ::= SEQUENCE {			
<i>measIdToRemoveList</i> SEQUENCE (SIZE (1..maxMeasId)) OF SEQUENCE {	2 entries		
<i>MeasId</i> [1]	1		
<i>MeasId</i> [2]	2		
}			
}			

Table 8.3.1.13a.3.3-11: MeasurementReport (step 1, Table 8.3.1.13a.3.2-6)

Derivation Path: 36.508 clause 4.6.1 table 4.6.1-5			
Information Element	Value/remark	Comment	Condition
MeasurementReport ::= SEQUENCE {			
criticalExtensions CHOICE {			
c1 CHOICE {			
measurementReport-r8 SEQUENCE {			
measResults ::= SEQUENCE {			
measId	2		
measResultServCell ::= SEQUENCE {		Report Cell 30	
rsrpResult	(0..97)		
rsrqResult	(0..34)		
}			
measResultNeighCells CHOICE {			
measResultListEUTRA ::= SEQUENCE (SIZE (1..maxCellReport)) OF SEQUENCE {		Report Cell 2	
physCellId [1]	physicalCellIdentity-Cell2		
measResult [1] SEQUENCE {			
rsrpResult	(0..97)		
rsrqResult	(0..34)		
}			
}			
}			
}			
}			
}			

Table 8.3.1.13a.3.3-12: MeasurementReport (step 1, Table 8.3.1.13a.3.2-7)

Derivation Path: 36.508 clause 4.6.1 table 4.6.1-5			
Information Element	Value/remark	Comment	Condition
MeasurementReport ::= SEQUENCE {			
criticalExtensions CHOICE {			
c1 CHOICE {			
measurementReport-r8 SEQUENCE {			
measResults ::= SEQUENCE {			
measId	2		
measResultServCell ::= SEQUENCE {		Report Cell 30	
rsrpResult	(0..97)		
rsrqResult	(0..34)		
}			
measResultNeighCells CHOICE {			
measResultListEUTRA ::= SEQUENCE (SIZE (1..maxCellReport)) OF SEQUENCE {		Report Cell 4	
physCellId [1]	physicalCellIdentity-Cell4		
measResult [1] SEQUENCE {			
rsrpResult	(0..97)		
rsrqResult	(0..34)		
}			
}			
}			
}			
}			
}			

Table 8.3.1.13a.3.3-13: MeasurementReport (step 1, Table 8.3.1.13a.3.2-8)

Derivation Path: 36.508 clause 4.6.1 table 4.6.1-5			
Information Element	Value/remark	Comment	Condition
MeasurementReport ::= SEQUENCE {			
criticalExtensions CHOICE {			
c1 CHOICE {			
measurementReport-r8 SEQUENCE {			
measResults ::= SEQUENCE {			
measId	1		
measResultServCell ::= SEQUENCE {		Report Cell 30	
rsrpResult	(0..97)		
rsrqResult	(0..34)		
}			
measResultNeighCells CHOICE {			
measResultListEUTRA ::= SEQUENCE (SIZE (1..maxCellReport)) OF SEQUENCE {		Report Cell 10	
physCellId [1]	physicalCellIdentity-Cell10		
measResult [1] SEQUENCE {			
rsrpResult	(0..97)		
rsrqResult	(0..34)		
}			
}			
}			
}			
}			
}			
}			

Table 8.3.1.13a.3.3-14: MeasurementReport (step 1, Table 8.3.1.13a.3.2-9)

Derivation Path: 36.508 clause 4.6.1 table 4.6.1-5			
Information Element	Value/remark	Comment	Condition
MeasurementReport ::= SEQUENCE {			
criticalExtensions CHOICE {			
c1 CHOICE {			
measurementReport-r8 SEQUENCE {			
measResults ::= SEQUENCE {			
measId	2		
measResultServCell ::= SEQUENCE {		Report Cell 1	
rsrpResult	(0..97)		
rsrqResult	(0..34)		
}			
measResultNeighCells CHOICE {			
measResultListEUTRA ::= SEQUENCE (SIZE (1..maxCellReport)) OF SEQUENCE {		Report Cell 30	
physCellId [1]	physicalCellIdentity-Cell30		
measResult [1] SEQUENCE {			
rsrpResult	(0..97)		
rsrqResult	(0..34)		
}			
}			
}			
}			
}			
}			
}			

Table 8.3.1.13a.3.3-15: TRACKING AREA UPDATE ACCEPT for Cell 30 (steps 13a4 and 13b2, Table 8.3.1.13a.3.2-2)

Derivation path: 36.508 Table 4.7.2-24			
Information Element	Value/Remark	Comment	Condition
Equivalent PLMNs	PLMN1		Cell 30

Table 8.3.1.13a.3.3-16: RRCConnectionRelease (step 13b1, Table 8.3.1.13a.3.2-2)

Derivation Path: 36.508 table 4.6.1-15			
Information Element	Value/remark	Comment	Condition
RRCConnectionRelease ::= SEQUENCE {			
criticalExtensions CHOICE {			
c1 CHOICE {			
rrcConnectionRelease-r8 SEQUENCE {			
redirectedCarrierInfo ::= CHOICE {			
Eutra	Downlink EARFCN of cell Cell 30		
}			
}			
}			
}			
}			

Table 8.3.1.13a.3.3-17: ATTACH ACCEPT for Cell 1 (preamble)

Derivation path: 36.508 Table 4.7.2-1			
Information Element	Value/Remark	Comment	Condition
Equivalent PLMNs	PLMN2		

8.3.1.14 Measurement configuration control and reporting / Intra E-UTRAN measurements / Two simultaneous events A2 and A3 (inter-band measurements)

8.3.1.14.1 Test Purpose (TP)

(1)

```
with { UE in E-UTRA RRC_CONNECTED state and measurements configured for event A2 and event A3 }
ensure that {
  when { Serving becomes worse than threshold }
  then { UE sends MeasurementReport for event A2 }
}
```

(2)

```
with { UE in E-UTRA RRC_CONNECTED state and measurements configured for event A2 and event A3 }
ensure that {
  when { Neighbour becomes offset better than serving }
  then { UE sends MeasurementReport for event A3 }
}
```

8.3.1.14.2 Conformance requirements

References: The conformance requirements covered in the current TC are specified in: TS 36.331, clauses 5.3.5.3, 5.5.4.1, 5.5.4.3, 5.5.4.4 and 5.5.5.

[TS 36.331, clause 5.3.5.3]

If the *RRCConnectionReconfiguration* message does not include the *mobilityControlInfo* and the UE is able to comply with the configuration included in this message, the UE shall:

...

1> if the *RRCConnectionReconfiguration* message includes the *measConfig*:

2> perform the measurement configuration procedure as specified in 5.5.2;

...

[TS 36.331, clause 5.5.4.1]

The UE shall:

1> for each *measId* included in the *measIdList* within *VarMeasConfig*:

2> else:

3> if the corresponding *measObject* concerns E-UTRA:

4> if the *ue-RxTxTimeDiffPeriodical*, *eventA1* or *eventA2* is configured in the corresponding *reportConfig*:

5> consider only the serving cell to be applicable;

4> else:

5> consider any neighbouring cell detected on the associated frequency to be applicable when the concerned cell is not included in the *blackCellsToAddModList* defined within the *VarMeasConfig* for this *measId*;

...

2> if the *triggerType* is set to 'event' and if the entry condition applicable for this event, i.e. the event corresponding with the *eventId* of the corresponding *reportConfig* within *VarMeasConfig*, is fulfilled for one or more applicable cells for all measurements after layer 3 filtering taken during *timeToTrigger* defined for this event within the *VarMeasConfig*, while the *VarMeasReportList* does not include an measurement reporting entry for this *measId* (a first cell triggers the event):

3> include a measurement reporting entry within the *VarMeasReportList* for this *measId*;

3> set the *numberOfReportsSent* defined within the *VarMeasReportList* for this *measId* to 0;

3> include the concerned cell(s) in the *cellsTriggeredList* defined within the *VarMeasReportList* for this *measId*;

3> initiate the measurement reporting procedure, as specified in 5.5.5;

2> if the *triggerType* is set to 'event' and if the entry condition applicable for this event, i.e. the event corresponding with the *eventId* of the corresponding *reportConfig* within *VarMeasConfig*, is fulfilled for one or more applicable cells not included in the *cellsTriggeredList* for all measurements after layer 3 filtering taken during *timeToTrigger* defined for this event within the *VarMeasConfig* (a subsequent cell triggers the event):

3> set the *numberOfReportsSent* defined within the *VarMeasReportList* for this *measId* to 0;

3> include the concerned cell(s) in the *cellsTriggeredList* defined within the *VarMeasReportList* for this *measId*;

3> initiate the measurement reporting procedure, as specified in 5.5.5;

2> if the *triggerType* is set to 'event' and if the leaving condition applicable for this event is fulfilled for one or more of the cells included in the *cellsTriggeredList* defined within the *VarMeasReportList* for this *measId* for all measurements after layer 3 filtering taken during *timeToTrigger* defined within the *VarMeasConfig* for this event:

3> remove the concerned cell(s) in the *cellsTriggeredList* defined within the *VarMeasReportList* for this *measId*;

3> if *reportOnLeave* is set to *TRUE* for the corresponding reporting configuration:

4> initiate the measurement reporting procedure, as specified in 5.5.5;

- 3> if the *cellsTriggeredList* defined within the *VarMeasReportList* for this *measId* is empty:
 - 4> remove the measurement reporting entry within the *VarMeasReportList* for this *measId*;
 - 4> stop the periodical reporting timer for this *measId*, if running;
- 2> if the *purpose* is included and set to '*reportStrongestCells*' or to '*reportStrongestCellsForSON*' and if a (first) measurement result is available for one or more applicable cells:
 - 3> include a measurement reporting entry within the *VarMeasReportList* for this *measId*;
 - 3> set the *numberOfReportsSent* defined within the *VarMeasReportList* for this *measId* to 0;
 - 3> initiate the measurement reporting procedure, as specified in 5.5.5;

NOTE 1: If the *purpose* is set to '*reportStrongestCells*', the UE initiates a first measurement report immediately after the quantity to be reported becomes available for at least either serving cell or one of the applicable cells. If the *purpose* is set to '*reportStrongestCellsForSON*', the UE initiates a first measurement report when it has determined the strongest cells on the associated frequency.

- 2> upon expiry of the periodical reporting timer for this *measId*:
 - 3> initiate the measurement reporting procedure, as specified in 5.5.5;
- 2> if the *purpose* is included and set to '*reportCGI*' and if the UE acquired the information needed to set all fields of *cgi-Info* for the requested cell:
 - 3> include a measurement reporting entry within the *VarMeasReportList* for this *measId*;
 - 3> set the *numberOfReportsSent* defined within the *VarMeasReportList* for this *measId* to 0;
 - 3> stop timer T321;
 - 3> initiate the measurement reporting procedure, as specified in 5.5.5;
- 2> upon expiry of the T321 for this *measId*:
 - 3> include a measurement reporting entry within the *VarMeasReportList* for this *measId*;
 - 3> set the *numberOfReportsSent* defined within the *VarMeasReportList* for this *measId* to 0;
 - 3> initiate the measurement reporting procedure, as specified in 5.5.5;

NOTE 2: The UE does not stop the periodical reporting with *triggerType* set to '*event*' or to '*periodical*' while the corresponding measurement is not performed due to the serving cell RSRP being equal to or better than *s-Measure* or due to the measurement gap not being setup.

NOTE 3: If the UE is configured with DRX, the UE may delay the measurement reporting for event triggered and periodical triggered measurements until the Active Time, which is defined in TS 36.321 [6].

[TS 36.331, clause 5.5.4.3]

The UE shall:

- 1> consider the entering condition for this event to be satisfied when condition A2-1, as specified below, is fulfilled;
- 1> consider the leaving condition for this event to be satisfied when condition A2-2, as specified below, is fulfilled;

Inequality A2-1 (Entering condition)

$$M_s + H_{ys} < Thresh$$

Inequality A2-2 (Leaving condition)

$$M_s - H_{ys} > Thresh$$

The variables in the formula are defined as follows:

Ms is the measurement result of the serving cell, not taking into account any offsets.

Hys is the hysteresis parameter for this event (i.e. *hysteresis* as defined within *reportConfigEUTRA* for this event).

Thresh is the threshold parameter for this event (i.e. *a2-Threshold* as defined within *reportConfigEUTRA* for this event).

Ms is expressed in dBm in case of RSRP, or in dB in case of RSRQ.

Hys is expressed in dB.

Thresh is expressed in the same unit as ***Ms***.

[TS 36.331, clause 5.5.4.4]

The UE shall:

1> consider the entering condition for this event to be satisfied when condition A3-1, as specified below, is fulfilled;

1> consider the leaving condition for this event to be satisfied when condition A3-2, as specified below, is fulfilled;

Inequality A3-1 (Entering condition)

$$Mn + Ofn + Ocn - Hys > Ms + Ofs + Ocs + Off$$

Inequality A3-2 (Leaving condition)

$$Mn + Ofn + Ocn + Hys < Ms + Ofs + Ocs + Off$$

The variables in the formula are defined as follows:

Mn is the measurement result of the neighbouring cell, not taking into account any offsets.

Ofn is the frequency specific offset of the frequency of the neighbour cell (i.e. *offsetFreq* as defined within *measObjectEUTRA* corresponding to the frequency of the neighbour cell).

Ocn is the cell specific offset of the neighbour cell (i.e. *cellIndividualOffset* as defined within *measObjectEUTRA* corresponding to the frequency of the neighbour cell), and set to zero if not configured for the neighbour cell.

Ms is the measurement result of the serving cell, not taking into account any offsets.

Ofs is the frequency specific offset of the serving frequency (i.e. *offsetFreq* as defined within *measObjectEUTRA* corresponding to the serving frequency).

Ocs is the cell specific offset of the serving cell (i.e. *cellIndividualOffset* as defined within *measObjectEUTRA* corresponding to the serving frequency), and is set to zero if not configured for the serving cell.

Hys is the hysteresis parameter for this event (i.e. *hysteresis* as defined within *reportConfigEUTRA* for this event).

Off is the offset parameter for this event (i.e. *a3-Offset* as defined within *reportConfigEUTRA* for this event).

Mn, ***Ms*** are expressed in dBm in case of RSRP, or in dB in case of RSRQ.

Ofn, ***Ocn***, ***Ofs***, ***Ocs***, ***Hys***, ***Off*** are expressed in dB.

[TS 36.331, clause 5.5.5]

For the *measId* for which the measurement reporting procedure was triggered, the UE shall set the *measResults* within the *MeasurementReport* message as follows:

1> set the *measId* to the measurement identity that triggered the measurement reporting;

1> set the *measResultServCell* to include the quantities of serving cell;

1> if there is at least one applicable neighbouring cell to report:

2> set the *measResultNeighCells* to include the best neighbouring cells up to *maxReportCells* in accordance with the following:

3> if the *triggerType* is set to 'event':

4> include the cells included in the *cellsTriggeredList* as defined within the *VarMeasReportList* for this *measId*;

3> else:

4> include the applicable cells for which the new measurement results became available since the last periodical reporting or since the measurement was initiated or reset;

NOTE 4: The reliability of the report (i.e. the certainty it contains the strongest cells on the concerned frequency) depends on the measurement configuration i.e. the *reportInterval*. The related performance requirements are specified in TS 36.133 [16].

3> for each cell that is included in the *measResultNeighCells*, include the *physCellId*;

3> if the *triggerType* is set to 'event'; or the *purpose* is set to 'reportStrongestCells' or to 'reportStrongestCellsForSON':

4> for each included cell, include the layer 3 filtered measured results in accordance with the *reportConfig* for this *measId*, ordered as follows:

5> if the *measObject* associated with this *measId* concerns E-UTRA:

6> set the *measResult* to include the quantity(ies) indicated in the *reportQuantity* within the concerned *reportConfig* in order of decreasing *triggerQuantity*, i.e. the best cell is included first;

5> else:

6> set the *measResult* to the quantity as configured for the concerned RAT within the *quantityConfig* in order of either decreasing quantity for UTRA and GERAN or increasing quantity for CDMA2000 *pilotStrength*, i.e. the best cell is included first;

...

...

1> increment the *numberOfReportsSent* as defined within the *VarMeasReportList* for this *measId* by 1;

1> stop the periodical reporting timer, if running;

1> if the *numberOfReportsSent* as defined within the *VarMeasReportList* for this *measId* is less than the *reportAmount* as defined within the corresponding *reportConfig* for this *measId*:

2> start the periodical reporting timer with the value of *reportInterval* as defined within the corresponding *reportConfig* for this *measId*;

...

1> submit the *MeasurementReport* message to lower layers for transmission, upon which the procedure ends;

8.3.1.14.3 Test description

8.3.1.14.3.1 Pre-test conditions

System Simulator:

- Cell 1 and Cell 10

- System information combination 3 as defined in TS 36.508 [18] clause 4.4.3.1 is used in E-UTRA cells.

UE:

None.

Preamble:

- The UE is in state Generic RB Established (state 3) on Cell 1 according to [18].

8.3.1.14.3.2 Test procedure sequence

Table 8.3.1.14.3.2-1 illustrates the downlink power levels to be applied for Cell 1 and Cell 10 at various time instants of the test execution. Row marked "T0" denotes the conditions after the preamble, while rows marked "T1" and "T2" are to be applied subsequently. The exact instants on which these values shall be applied are described in the texts in this clause.

Table 8.3.1.14.3.2-1: Power levels

	Parameter	Unit	Cell 1	Cell 10 (DL only)	Remark
T0	Cell-specific RS EPRE	dBm/1 5kHz	-75	-91	Power levels are such that entry condition for event A2 and event A3 is not satisfied: $M_s - H_{ys} > Thresh$ AND $M_n + O_{fn} + O_{cn} + H_{ys} < M_s + O_{fs} + O_{cs} + Off$
T1	Cell-specific RS EPRE	dBm/1 5kHz	-93	-105	Power level of Cell 1 is such that entry condition for event A2 is satisfied: $M_s + H_{ys} < Thresh$ AND Power levels of Cell 1 and Cell 10 are such that entry condition for event A3 is not satisfied: $M_n + O_{fn} + O_{cn} + H_{ys} < M_s + O_{fs} + O_{cs} + Off$
T2	Cell-specific RS EPRE	dBm/1 5kHz	-85	-73	Power levels are such that entry condition for event A3 is satisfied: $M_n + O_{fn} + O_{cn} - H_{ys} > M_s + O_{fs} + O_{cs} + Off$

Table 8.3.1.14.3.2-2: Main behaviour

St	Procedure	Message Sequence		TP	Verdict
		U - S	Message		
1	SS transmits an <i>RRConnectionReconfiguration</i> message including <i>measConfig</i> to setup intra LTE measurement and reporting for event A2 and event A3 (inter-band measurement)	<--	<i>RRConnectionReconfiguration</i>	-	-
2	The UE transmits an <i>RRConnectionReconfigurationComplete</i> message.	-->	<i>RRConnectionReconfigurationComplete</i>	-	-
3	Check: Does the UE transmit a <i>MeasurementReport</i> message within the next 10s?	-->	<i>MeasurementReport</i>	1	F
4	SS re-adjusts the cell-specific reference signal level according to row "T1" in table 8.3.1.14.3.2-1.	-	-	-	-
5	Check: Does the UE transmit a <i>MeasurementReport</i> message to report event A2 with the measured RSRP value for Cell 1?	-->	<i>MeasurementReport</i>	1	P
6	SS re-adjusts the cell-specific reference signal level according to row "T2" in table 8.3.1.14.3.2-1.	-	-	-	-
7	Check: Does the UE transmit a <i>MeasurementReport</i> message to report event A3 with the measured RSRP value for Cell 10?	-->	<i>MeasurementReport</i>	2	P

8.3.1.14.3.3 Specific message contents

Table 8.3.1.14.3.3-1: RRCConnectionReconfiguration (step 1, Table 8.3.1.14.3.2-2)

Derivation Path: 36.508 clause 4.6.1 table 4.6.1-8 with condition MEAS

Table 8.3.1.14.3.3-2: MeasConfig (step 1, Table 8.3.1.14.3.2-2)

Derivation path: 36.508 clause 4.6.6 table 4.6.6-1, condition INTER-FREQ			
Information Element	Value/Remark	Comment	Condition
MeasConfig ::= SEQUENCE {			
measObjectToAddModList SEQUENCE (SIZE (1..maxObjectId)) OF SEQUENCE {	2 entries		
measObjectId[1]	IdMeasObject-f1		
measObject[1]	MeasObjectEUTRA-GENERIC(f1)		
measObjectId[2]	IdMeasObject-f5		
measObject[2]	MeasObjectEUTRA-GENERIC(f5)		
}			
reportConfigToAddModList SEQUENCE (SIZE (1..maxReportConfigId)) OF SEQUENCE {	2 entries		
reportConfigId[1]	IdReportConfig-A2		
reportConfig[1]	ReportConfig-A2		
reportConfigId[2]	IdReportConfig-A3		
reportConfig[2]	ReportConfig-A3		
}			
measIdToAddModList SEQUENCE (SIZE (1..maxMeasId)) OF SEQUENCE {	2 entries		
measId[1]	1		
measObjectId[1]	IdMeasObject-f1		
reportConfigId[1]	IdReportConfig-A2		
measId[2]	2		
measObjectId[2]	IdMeasObject-f5		
reportConfigId[2]	IdReportConfig-A3		
}			
}			

Table 8.3.1.14.3.3-3: ReportConfig-A2 (step 1, Table 8.3.1.14.3.2-2)

Derivation path: 36.508 clause 4.6.6 table 4.6.6-5 ReportConfigEUTRA-A2(-83)			
Information Element	Value/Remark	Comment	Condition
ReportConfigEUTRA ::= SEQUENCE {			
triggerType CHOICE {			
event SEQUENCE {			
hysteresis	6	3 dB	
}			
}			
}			

Table 8.3.1.14.3.3-4: ReportConfig-A3 (step 1, Table 8.3.1.14.3.2-2)

Derivation path: 36.508 clause 4.6.6 table 4.6.6-6 ReportConfigEUTRA-A3			
Information Element	Value/remark	Comment	Condition
ReportConfigEUTRA-A3 ::= SEQUENCE {			
triggerType CHOICE {			
event SEQUENCE {			
eventId CHOICE {			
eventA3 SEQUENCE {			
a3-Offset	0	0 dB	
}			
}			
}			
}			
reportQuantity	sameAsTriggerQuantity		
}			

Table 8.3.1.14.3.3-5: MeasurementReport (step 5, Table 8.3.1.14.3.2-2)

Derivation path: 36.508 4.6.1 table 4.6.1-5			
Information Element	Value/Remark	Comment	Condition
MeasurementReport ::= SEQUENCE {			
criticalExtensions CHOICE {			
c1 CHOICE {			
measurementReport-r8 SEQUENCE {			
measResults ::= SEQUENCE {			
measId	1		
measResultServCell ::= SEQUENCE {		Report Cell 1	
rsrpResult	(0..97)		
rsrqResult	(0..34)		
}			
measResultForECID-r9	Not present		
}			
}			
}			
}			
}			

Table 8.3.1.14.3.3-6: *MeasurementReport* (step 7, Table 8.3.1.14.3.2-2)

Derivation path: 36.508 4.6.1 table 4.6.1-5			
Information Element	Value/Remark	Comment	Condition
MeasurementReport ::= SEQUENCE {			
criticalExtensions CHOICE {			
c1 CHOICE {			
measurementReport-r8 SEQUENCE {			
measResults ::= SEQUENCE {			
measId	2		
measResultServCell ::= SEQUENCE {		Report Cell 1	
rsrpResult	(0..97)		
rsrqResult	(0..34)		
}			
measResultNeighCells CHOICE {			
measResultEUTRA ::= SEQUENCE (SIZE (1..maxCellReport)) OF SEQUENCE {		Report Cell 10	
physCellId	PhysCellId of the Cell 10.		
measResult SEQUENCE{			
rsrpResult	(0..97)		
rsrqResult	Not present		
}			
}			
measResultForECID-r9	Not present		
}			
}			
}			
}			
}			

8.3.1.14a Measurement configuration control and reporting / Intra E-UTRAN measurements / Two simultaneous events A2 and A3 (inter-band measurements) / Between FDD and TDD

8.3.1.14a.1 Test Purpose (TP)

(1)

```
with { UE in E-UTRA FDD RRC_CONNECTED state and measurements configured for event A2 and event A3 }
ensure that {
  when { Serving E-UTRA FDD cell becomes worse than threshold }
  then { UE sends MeasurementReport for event A2 }
}
```

(2)

```
with { UE in E-UTRA FDD RRC_CONNECTED state and measurements configured for event A2 and event A3 }
ensure that {
  when { Neighbour E-UTRA TDD cell becomes offset better than serving E-UTRA FDD cell }
  then { UE sends MeasurementReport for event A3 }
}
```

(3)

```
with { UE in E-UTRA TDD RRC_CONNECTED state and measurements configured for event A2 and event A3 }
ensure that {
  when { Serving E-UTRA TDD cell becomes worse than threshold }
  then { UE sends MeasurementReport for event A2 }
}
```

(4)

```
with { UE in E-UTRA TDD RRC_CONNECTED state and measurements configured for event A2 and event A3 }
ensure that {
  when { Neighbour E-UTRA FDD cell becomes offset better than serving E-UTRA TDD cell }
}
```

```

    then { UE sends MeasurementReport for event A3 }
}

```

8.3.1.14a.2 Conformance requirements

References: The conformance requirements covered in the current TC are specified in: TS 36.331, clauses 5.3.5.3, 5.5.4.1, 5.5.4.3, 5.5.4.4 and 5.5.5.

[TS 36.331, clause 5.3.5.3]

If the *RRConnectionReconfiguration* message does not include the *mobilityControlInfo* and the UE is able to comply with the configuration included in this message, the UE shall:

...

- 1> if the *RRConnectionReconfiguration* message includes the *measConfig*:
- 2> perform the measurement configuration procedure as specified in 5.5.2;

...

[TS 36.331, clause 5.5.4.1]

The UE shall:

- 1> for each *measId* included in the *measIdList* within *VarMeasConfig*:
 - 2> else:
 - 3> if the corresponding *measObject* concerns E-UTRA:
 - 4> if the *ue-RxTxTimeDiffPeriodical*, *eventA1* or *eventA2* is configured in the corresponding *reportConfig*:
 - 5> consider only the serving cell to be applicable;
 - 4> else:
 - 5> consider any neighbouring cell detected on the associated frequency to be applicable when the concerned cell is not included in the *blackCellsToAddModList* defined within the *VarMeasConfig* for this *measId*;
- ...
- 2> if the *triggerType* is set to 'event' and if the entry condition applicable for this event, i.e. the event corresponding with the *eventId* of the corresponding *reportConfig* within *VarMeasConfig*, is fulfilled for one or more applicable cells for all measurements after layer 3 filtering taken during *timeToTrigger* defined for this event within the *VarMeasConfig*, while the *VarMeasReportList* does not include a measurement reporting entry for this *measId* (a first cell triggers the event):
 - 3> include a measurement reporting entry within the *VarMeasReportList* for this *measId*;
 - 3> set the *numberOfReportsSent* defined within the *VarMeasReportList* for this *measId* to 0;
 - 3> include the concerned cell(s) in the *cellsTriggeredList* defined within the *VarMeasReportList* for this *measId*;
 - 3> initiate the measurement reporting procedure, as specified in 5.5.5;
- 2> if the *triggerType* is set to 'event' and if the entry condition applicable for this event, i.e. the event corresponding with the *eventId* of the corresponding *reportConfig* within *VarMeasConfig*, is fulfilled for one or more applicable cells not included in the *cellsTriggeredList* for all measurements after layer 3 filtering taken during *timeToTrigger* defined for this event within the *VarMeasConfig* (a subsequent cell triggers the event):
 - 3> set the *numberOfReportsSent* defined within the *VarMeasReportList* for this *measId* to 0;

- 3> include the concerned cell(s) in the *cellsTriggeredList* defined within the *VarMeasReportList* for this *measId*;
- 3> initiate the measurement reporting procedure, as specified in 5.5.5;
- 2> if the *triggerType* is set to 'event' and if the leaving condition applicable for this event is fulfilled for one or more of the cells included in the *cellsTriggeredList* defined within the *VarMeasReportList* for this *measId* for all measurements after layer 3 filtering taken during *timeToTrigger* defined within the *VarMeasConfig* for this event:
 - 3> remove the concerned cell(s) in the *cellsTriggeredList* defined within the *VarMeasReportList* for this *measId*;
 - 3> if *reportOnLeave* is set to *TRUE* for the corresponding reporting configuration:
 - 4> initiate the measurement reporting procedure, as specified in 5.5.5;
 - 3> if the *cellsTriggeredList* defined within the *VarMeasReportList* for this *measId* is empty:
 - 4> remove the measurement reporting entry within the *VarMeasReportList* for this *measId*;
 - 4> stop the periodical reporting timer for this *measId*, if running;
- 2> if the *purpose* is included and set to 'reportStrongestCells' or to 'reportStrongestCellsForSON' and if a (first) measurement result is available for one or more applicable cells:
 - 3> include a measurement reporting entry within the *VarMeasReportList* for this *measId*;
 - 3> set the *numberOfReportsSent* defined within the *VarMeasReportList* for this *measId* to 0;
 - 3> initiate the measurement reporting procedure, as specified in 5.5.5;

NOTE 1: If the *purpose* is set to 'reportStrongestCells', the UE initiates a first measurement report immediately after the quantity to be reported becomes available for at least either serving cell or one of the applicable cells. If the *purpose* is set to 'reportStrongestCellsForSON', the UE initiates a first measurement report when it has determined the strongest cells on the associated frequency.

- 2> upon expiry of the periodical reporting timer for this *measId*:
 - 3> initiate the measurement reporting procedure, as specified in 5.5.5;
- 2> if the *purpose* is included and set to 'reportCGI' and if the UE acquired the information needed to set all fields of *cgi-Info* for the requested cell:
 - 3> include a measurement reporting entry within the *VarMeasReportList* for this *measId*;
 - 3> set the *numberOfReportsSent* defined within the *VarMeasReportList* for this *measId* to 0;
 - 3> stop timer T321;
 - 3> initiate the measurement reporting procedure, as specified in 5.5.5;
- 2> upon expiry of the T321 for this *measId*:
 - 3> include a measurement reporting entry within the *VarMeasReportList* for this *measId*;
 - 3> set the *numberOfReportsSent* defined within the *VarMeasReportList* for this *measId* to 0;
 - 3> initiate the measurement reporting procedure, as specified in 5.5.5;

NOTE 2: The UE does not stop the periodical reporting with *triggerType* set to 'event' or to 'periodical' while the corresponding measurement is not performed due to the serving cell RSRP being equal to or better than *s-Measure* or due to the measurement gap not being setup.

NOTE 3: If the UE is configured with DRX, the UE may delay the measurement reporting for event triggered and periodical triggered measurements until the Active Time, which is defined in TS 36.321 [6].

[TS 36.331, clause 5.5.4.3]

The UE shall:

1> consider the entering condition for this event to be satisfied when condition A2-1, as specified below, is fulfilled;

1> consider the leaving condition for this event to be satisfied when condition A2-2, as specified below, is fulfilled;

Inequality A2-1 (Entering condition):

$$Ms + Hys < Thresh$$

Inequality A2-2 (Leaving condition):

$$Ms - Hys > Thresh$$

The variables in the formula are defined as follows:

Ms is the measurement result of the serving cell, not taking into account any offsets.

Hys is the hysteresis parameter for this event (i.e. *hysteresis* as defined within *reportConfigEUTRA* for this event).

Thresh is the threshold parameter for this event (i.e. *a2-Threshold* as defined within *reportConfigEUTRA* for this event).

Ms is expressed in dBm in case of RSRP, or in dB in case of RSRQ.

Hys is expressed in dB.

Thresh is expressed in the same unit as ***Ms***.

[TS 36.331, clause 5.5.4.4]

The UE shall:

1> consider the entering condition for this event to be satisfied when condition A3-1, as specified below, is fulfilled;

1> consider the leaving condition for this event to be satisfied when condition A3-2, as specified below, is fulfilled;

Inequality A3-1 (Entering condition):

$$Mn + Ofn + Ocn - Hys > Ms + Ofs + Ocs + Off$$

Inequality A3-2 (Leaving condition):

$$Mn + Ofn + Ocn + Hys < Ms + Ofs + Ocs + Off$$

The variables in the formula are defined as follows:

Mn is the measurement result of the neighbouring cell, not taking into account any offsets.

Ofn is the frequency specific offset of the frequency of the neighbour cell (i.e. *offsetFreq* as defined within *measObjectEUTRA* corresponding to the frequency of the neighbour cell).

Ocn is the cell specific offset of the neighbour cell (i.e. *cellIndividualOffset* as defined within *measObjectEUTRA* corresponding to the frequency of the neighbour cell), and set to zero if not configured for the neighbour cell.

Ms is the measurement result of the serving cell, not taking into account any offsets.

Ofs is the frequency specific offset of the serving frequency (i.e. *offsetFreq* as defined within *measObjectEUTRA* corresponding to the serving frequency).

Ocs is the cell specific offset of the serving cell (i.e. *cellIndividualOffset* as defined within *measObjectEUTRA* corresponding to the serving frequency), and is set to zero if not configured for the serving cell.

Hys is the hysteresis parameter for this event (i.e. *hysteresis* as defined within *reportConfigEUTRA* for this event).

Off is the offset parameter for this event (i.e. *a3-Offset* as defined within *reportConfigEUTRA* for this event).

Mn, ***Ms*** are expressed in dBm in case of RSRP, or in dB in case of RSRQ.

Ofn, Ocn, Ofs, Ocs, Hys, Off are expressed in dB.

[TS 36.331, clause 5.5.5]

For the *measId* for which the measurement reporting procedure was triggered, the UE shall set the *measResults* within the *MeasurementReport* message as follows:

- 1> set the *measId* to the measurement identity that triggered the measurement reporting;
- 1> set the *measResultServCell* to include the quantities of serving cell;
- 1> if there is at least one applicable neighbouring cell to report:
 - 2> set the *measResultNeighCells* to include the best neighbouring cells up to *maxReportCells* in accordance with the following:
 - 3> if the *triggerType* is set to 'event':
 - 4> include the cells included in the *cellsTriggeredList* as defined within the *VarMeasReportList* for this *measId*;
 - 3> else:
 - 4> include the applicable cells for which the new measurement results became available since the last periodical reporting or since the measurement was initiated or reset;

NOTE: The reliability of the report (i.e. the certainty it contains the strongest cells on the concerned frequency) depends on the measurement configuration i.e. the *reportInterval*. The related performance requirements are specified in TS 36.133 [16].

- 3> for each cell that is included in the *measResultNeighCells*, include the *physCellId*;
- 3> if the *triggerType* is set to 'event'; or the *purpose* is set to 'reportStrongestCells' or to 'reportStrongestCellsForSON':
 - 4> for each included cell, include the layer 3 filtered measured results in accordance with the *reportConfig* for this *measId*, ordered as follows:
 - 5> if the *measObject* associated with this *measId* concerns E-UTRA:
 - 6> set the *measResult* to include the quantity(ies) indicated in the *reportQuantity* within the concerned *reportConfig* in order of decreasing *triggerQuantity*, i.e. the best cell is included first;
 - 5> else:
 - 6> set the *measResult* to the quantity as configured for the concerned RAT within the *quantityConfig* in order of either decreasing quantity for UTRA and GERAN or increasing quantity for CDMA2000 *pilotStrength*, i.e. the best cell is included first;

...

- 1> increment the *numberOfReportsSent* as defined within the *VarMeasReportList* for this *measId* by 1;
- 1> stop the periodical reporting timer, if running;
- 1> if the *numberOfReportsSent* as defined within the *VarMeasReportList* for this *measId* is less than the *reportAmount* as defined within the corresponding *reportConfig* for this *measId*:
 - 2> start the periodical reporting timer with the value of *reportInterval* as defined within the corresponding *reportConfig* for this *measId*;

...

- 1> submit the *MeasurementReport* message to lower layers for transmission, upon which the procedure ends;

8.3.1.14a.3 Test description

8.3.1.14a.3.1 Pre-test conditions

System Simulator:

- Cell 1 is E-UTRA FDD cell and Cell 28 is E-UTRA TDD cell.
- Each cell has only a single PLMN identity. The PLMNs are identified in the test by the identifiers in Table 8.3.1.14a.3.1-1.

Table 8.3.1.14a.3.1-1: PLMN identifiers

Cell	PLMN name
1	PLMN1
28	PLMN2

- System information combination 3 as defined in TS 36.508 [18] clause 4.4.3.1 and Table 6.3.1.2-2 is used in E-UTRA cells.

UE:

None.

Preamble:

- The UE is registered on PLMN1 (Cell 1) using the procedure described in TS 36.508[18] clause 4.5.2.3 except that the ATTACH ACCEPT message indicates PLMN2 in the Equivalent PLMN list as described in Table 8.3.1.14a.3.3-15.
- The UE is in state Generic RB Established (state 3) on Cell 1 according to [18].

8.3.1.14a.3.2 Test procedure sequence

Table 8.3.1.14a.3.2-1 illustrates the downlink power levels to be applied for Cell 1 and Cell 28 at various time instants of the test execution. Row marked "T0" denotes the conditions after the preamble, while rows marked "T1" and "T2" are to be applied subsequently. The exact instants on which these values shall be applied are described in the texts in this clause.

Table 8.3.1.14a.3.2-1: Power levels

	Parameter	Unit	Cell 1	Cell 28	Remark
T0	Cell-specific RS EPRE	dBm/1 5kHz	-75	-91	Power levels are such that entry condition for event A2 and event A3 is not satisfied: $M_s - H_{ys} > Thresh$ AND $M_n + O_{fn} + O_{cn} + H_{ys} < M_s + O_{fs} + O_{cs} + O_{ff}$
T1	Cell-specific RS EPRE	dBm/1 5kHz	-93	-105	Power level of Cell 1 is such that entry condition for event A2 is satisfied: $M_s + H_{ys} < Thresh$ AND Power levels of Cell 1 and Cell 28 are such that entry condition for event A3 is not satisfied: $M_n + O_{fn} + O_{cn} + H_{ys} < M_s + O_{fs} + O_{cs} + O_{ff}$
T2	Cell-specific RS EPRE	dBm/1 5kHz	-85	-73	Power levels are such that entry condition for event A3 is satisfied for Cell 1, and the entry condition for event A2 and event A3 are not satisfied for Cell 28 after the handover: $M_n + O_{fn} + O_{cn} - H_{ys} > M_s + O_{fs} + O_{cs} + O_{ff}$
T3	Cell-specific RS EPRE	dBm/1 5kHz	-105	-93	Power level of Cell 28 is such that entry condition for event A2 is satisfied: $M_s + H_{ys} < Thresh$ AND Power levels of Cell 1 and Cell 28 are such that entry condition for event A3 is not satisfied: $M_n + O_{fn} + O_{cn} + H_{ys} < M_s + O_{fs} + O_{cs} + O_{ff}$
T4	Cell-specific RS EPRE	dBm/1 5kHz	-73	-85	Power levels are such that entry condition for event A3 is satisfied for Cell 28: $M_n + O_{fn} + O_{cn} - H_{ys} > M_s + O_{fs} + O_{cs} + O_{ff}$

Table 8.3.1.14a.3.2-2: Main behaviour

St	Procedure	Message Sequence		TP	Verdict
		U - S	Message		
1	SS transmits an <i>RRCCONNECTIONRECONFIGURATION</i> message including <i>measConfig</i> to setup intra LTE measurement and reporting for event A2 and event A3 (inter-band measurement) on Cell 1	<--	<i>RRCCONNECTIONRECONFIGURATION</i>	-	-
2	The UE transmits an <i>RRCCONNECTIONRECONFIGURATIONCOMPLETE</i> message.	-->	<i>RRCCONNECTIONRECONFIGURATIONCOMPLETE</i>	-	-
3	Check: Does the UE transmit a <i>MEASUREMENTREPORT</i> message within the next 10s?	-->	<i>MEASUREMENTREPORT</i>	1	F
4	SS re-adjusts the cell-specific reference signal level according to row "T1" in table 8.3.1.14a.3.2.-1.	-	-	-	-
5	Check: Does the UE transmit a <i>MEASUREMENTREPORT</i> message to report event A2 with the measured RSRP value for Cell 1?	-->	<i>MEASUREMENTREPORT</i>	1	P
6	SS re-adjusts the cell-specific reference signal level according to row "T2" in table 8.3.1.14a.3.2.-1.	-	-	-	-
7	Check: Does the UE transmit a <i>MEASUREMENTREPORT</i> message to report event A3 with the measured RSRP value for Cell 28?	-->	<i>MEASUREMENTREPORT</i>	2	P
-	EXCEPTION: Steps 8a1 to 8b5 describe behaviour that depends on the UE capability that if UE has set FGI bit 30 to 1; the "lower case letter" identifies a step sequence that takes place if a capability is supported.	-	-	-	-
8a1	IF <i>pc_FeatrGrp_30</i> THEN the SS transmits an <i>RRCCONNECTIONRECONFIGURATION</i> message on Cell 1 to order the UE to perform inter-band handover to Cell 28 and to activate the measurement gaps.	<--	<i>RRCCONNECTIONRECONFIGURATION</i>	-	-
8a2	The UE transmits an <i>RRCCONNECTIONRECONFIGURATIONCOMPLETE</i> message on Cell 28 to confirm the successful handover	-->	<i>RRCCONNECTIONRECONFIGURATIONCOMPLETE</i>	-	-
8a3	The UE transmits a TRACKING AREA UPDATE REQUEST message on Cell 28.	-	-	-	-
8a4	SS responds with a TRACKING AREA UPDATE ACCEPT message. NOTE: The TAU is accepted with PLMN1 listed as an Equivalent PLMN	-	-	-	-
8a5	The UE transmits a TRACKING AREA UPDATE COMPLETE message.	-	-	-	-
8b1	ELSE IF NOT <i>pc_FeatrGrp_30</i> THEN the SS transmits an <i>RRCCONNECTIONRELEASE</i> message (IE <i>redirectedCarrierInfo</i> including <i>extraCarrierFreq</i> of Cell 28) on Cell 1	<--	<i>RRCCONNECTIONRELEASE</i>	-	-
8b2	The generic test procedure described in TS 36.508 subclause 6.4.2.7 is performed on Cell 28 NOTE: The TAU is accepted with PLMN1 listed as an Equivalent PLMN	-	-	-	-
8b3	Generic test procedure described in TS 36.508 subclause 4.5.3.3 is executed	-	-	-	-
8b4	The SS transmits an <i>RRCCONNECTIONRECONFIGURATION</i> message including <i>MeasConfig</i> to setup inter-band measurement and reporting for event A2 and event A3 on Cell 28.	<--	<i>RRCCONNECTIONRECONFIGURATION</i>	-	-
8b5	The UE transmits an <i>RRCCONNECTIONRECONFIGURATIONCOMPLETE</i> message.	-->	<i>RRCCONNECTIONRECONFIGURATIONCOMPLETE</i>	-	-

9	Check: Does the UE transmit a <i>MeasurementReport</i> message within the next 10s?	-->	<i>MeasurementReport</i>	3	F
10	SS re-adjusts the cell-specific reference signal level according to row "T3" in table 8.3.1.14a.3.2.-1.	-	-	-	-
11	Check: Does the UE transmit a <i>MeasurementReport</i> message to report event A2 with the measured RSRP value for Cell 28?	-->	<i>MeasurementReport</i>	3	P
12	SS re-adjusts the cell-specific reference signal level according to row "T4" in table 8.3.1.14a.3.2.-1.	-	-	-	-
13	Check: Does the UE transmit a <i>MeasurementReport</i> message to report event A3 with the measured RSRP value for Cell 1?	-->	<i>MeasurementReport</i>	4	P

8.3.1.14a.3.3 Specific message contents

Table 8.3.1.14a.3.3-1: *RRCConnectionReconfiguration* (step 1 and step 8b4, Table 8.3.1.14a.3.2-2)

Derivation Path: 36.508 clause 4.6.1 table 4.6.1-8 with condition MEAS
--

Table 8.3.1.14a.3.3-2: *MeasConfig* (step 1, Table 8.3.1.14a.3.3-1)

Derivation path: 36.508 clause 4.6.6 table 4.6.6-1, condition INTER-FREQ			
Information Element	Value/Remark	Comment	Condition
<i>MeasConfig</i> ::= SEQUENCE {			
<i>measObjectToAddModList</i> SEQUENCE (SIZE (1.. <i>maxObjectId</i>)) OF SEQUENCE {	2 entries		
<i>measObjectId</i> [1]	IdMeasObject-f1		
<i>measObject</i> [1]	MeasObjectEUTRA-GENERIC(f1)		
<i>measObjectId</i> [2]	IdMeasObject-f6		
<i>measObject</i> [2]	MeasObjectEUTRA-GENERIC(f6)		
}			
<i>reportConfigToAddModList</i> SEQUENCE (SIZE (1.. <i>maxReportConfigId</i>)) OF SEQUENCE {	2 entries		
<i>reportConfigId</i> [1]	IdReportConfig-A2		
<i>reportConfig</i> [1]	ReportConfig-A2		
<i>reportConfigId</i> [2]	IdReportConfig-A3		
<i>reportConfig</i> [2]	ReportConfig-A3		
}			
<i>measIdToAddModList</i> SEQUENCE (SIZE (1.. <i>maxMeasId</i>)) OF SEQUENCE {	2 entries		
<i>measId</i> [1]	1		
<i>measObjectId</i> [1]	IdMeasObject-f1		
<i>reportConfigId</i> [1]	IdReportConfig-A2		
<i>measId</i> [2]	2		
<i>measObjectId</i> [2]	IdMeasObject-f6		
<i>reportConfigId</i> [2]	IdReportConfig-A3		
}			
}			

Table 8.3.1.14a.3.3-3: ReportConfig-A2 (step 1 and step 8b4, Table 8.3.1.14a.3.3-2)

Derivation path: 36.508 clause 4.6.6 table 4.6.6-5 ReportConfigEUTRA-A2(-83)			
Information Element	Value/Remark	Comment	Condition
ReportConfigEUTRA ::= SEQUENCE {			
triggerType CHOICE {			
event SEQUENCE {			
hysteresis	6	3 dB	
}			
}			
}			

Table 8.3.1.14a.3.3-4: ReportConfig-A3 (step 1 and step 8b4, Table 8.3.1.14a.3.3-2)

Derivation path: 36.508 clause 4.6.6 table 4.6.6-6 ReportConfigEUTRA-A3			
Information Element	Value/remark	Comment	Condition
ReportConfigEUTRA-A3 ::= SEQUENCE {			
triggerType CHOICE {			
event SEQUENCE {			
eventId CHOICE {			
eventA3 SEQUENCE {			
a3-Offset	0	0 dB	
}			
}			
}			
reportQuantity	sameAsTriggerQuantity		
}			

Table 8.3.1.14a.3.3-5: MeasurementReport (step 5, Table 8.3.1.14a.3.2-2)

Derivation path: 36.508 4.6.1 table 4.6.1-5			
Information Element	Value/Remark	Comment	Condition
MeasurementReport ::= SEQUENCE {			
criticalExtensions CHOICE {			
c1 CHOICE {			
measurementReport-r8 SEQUENCE {			
measResults ::= SEQUENCE {			
measId	1		
measResultServCell ::= SEQUENCE {		Report Cell 1	
rsrpResult	(0..97)		
rsrqResult	(0..34)		
}			
}			
}			
}			
}			
}			

Table 8.3.1.14a.3.3-6: MeasurementReport (step 7, Table 8.3.1.14a.3.2-2)

Derivation path: 36.508 4.6.1 table 4.6.1-5			
Information Element	Value/Remark	Comment	Condition
MeasurementReport ::= SEQUENCE {			
criticalExtensions CHOICE {			
c1 CHOICE {			
measurementReport-r8 SEQUENCE {			
measResults ::= SEQUENCE {			
measId	2		
measResultServCell ::= SEQUENCE {		Report Cell 1	
rsrpResult	(0..97)		
rsrqResult	(0..34)		
}			
measResultNeighCells CHOICE {			
measResultEUTRA ::= SEQUENCE (SIZE (1..maxCellReport)) OF SEQUENCE {		Report Cell 28	
physCellId	PhysCellId of the Cell 28		
measResult SEQUENCE{			
rsrpResult	(0..97)		
rsrqResult	Not present		
}			
}			
}			
}			
}			
}			
}			

Table 8.3.1.14a.3.3-7: RRCConnectionReconfiguration (step 8a1, Table 8.3.1.14a.3.2-2)

Derivation Path: 36.508 clause 4.6.1 table 4.6.1-8 with conditions MEAS and HO
--

Table 8.3.1.14a.3.3-8: MeasConfig (step 8a1, Table 8.3.1.14a.3.3-7)

Derivation path: 36.508 clause 4.6.6 table 4.6.6-1, condition INTER-FREQ
--

Table 8.3.1.14a.3.3-9: MobilityControlInfo (step 8a1, Table 8.3.1.14a.3.3-7)

Derivation Path: 36.508, Table 4.6.5-1			
Information Element	Value/remark	Comment	Condition
MobilityControlInfo ::= SEQUENCE {			
targetPhysCellId	PhysicalCellIdentity of Cell 28		
carrierFreq SEQUENCE {			
dl-CarrierFreq	Same DL EARFCN as used for Cell 28		
ul-CarrierFreq	Not present		
}			
}			

Table 8.3.1.14a.3.3-10: MeasurementReport (step 11, Table 8.3.1.14a.3.2-2)

Derivation path: 36.508 4.6.1 table 4.6.1-5			
Information Element	Value/Remark	Comment	Condition
MeasurementReport ::= SEQUENCE {			
criticalExtensions CHOICE {			
c1 CHOICE {			
measurementReport-r8 SEQUENCE {			
measResults ::= SEQUENCE {			
measId	1		
measResultServCell ::= SEQUENCE {		Report Cell 28	
rsrpResult	(0..97)		
rsrqResult	(0..34)		
}			
}			
}			
}			
}			
}			

Table 8.3.1.14a.3.3-11: MeasurementReport (step 13, Table 8.3.1.14a.3.2-2)

Derivation path: 36.508 4.6.1 table 4.6.1-5			
Information Element	Value/Remark	Comment	Condition
MeasurementReport ::= SEQUENCE {			
criticalExtensions CHOICE {			
c1 CHOICE {			
measurementReport-r8 SEQUENCE {			
measResults ::= SEQUENCE {			
measId	2		
measResultServCell ::= SEQUENCE {		Report Cell 28	
rsrpResult	(0..97)		
rsrqResult	(0..34)		
}			
measResultNeighCells CHOICE {			
measResultEUTRA ::= SEQUENCE (SIZE (1..maxCellReport)) OF SEQUENCE {		Report Cell 1	
physCellId	PhysCellId of the Cell 1		
measResult SEQUENCE{			
rsrpResult	(0..97)		
rsrqResult	Not present		
}			
}			
}			
}			
}			
}			
}			
}			

Table 8.3.1.14a.3.3-12: TRACKING AREA UPDATE ACCEPT for Cell 28 (steps 8a4 and 8b2, Table 8.3.1.14a.3.2-2)

Derivation path: 36.508 Table 4.7.2-24			
Information Element	Value/Remark	Comment	Condition
Equivalent PLMNs	PLMN1		Cell 28

Table 8.3.1.14a.3.3-13: *RRConnectionRelease* (step 8b1, Table 8.3.1.14a.3.2-2)

Derivation Path: 36.508 table 4.6.1-15			
Information Element	Value/remark	Comment	Condition
RRConnectionRelease ::= SEQUENCE {			
criticalExtensions CHOICE {			
c1 CHOICE {			
rrcConnectionRelease-r8 SEQUENCE {			
redirectedCarrierInfo ::= CHOICE {			
eutra	Downlink EARFCN of cell Cell 28		
}			
}			
}			
}			
}			

Table 8.3.1.14a.3.3-14: *MeasConfig* (step 8b4, Table 8.3.1.14a.3.3-1)

Derivation path: 36.508 clause 4.6.6 table 4.6.6-1, condition INTER-FREQ			
Information Element	Value/Remark	Comment	Condition
MeasConfig ::= SEQUENCE {			
measObjectToAddModList SEQUENCE (SIZE (1..maxObjectId)) OF SEQUENCE {	2 entries		
measObjectId[1]	IdMeasObject-f1		
measObject[1]	MeasObjectEUTRA- GENERIC(f1)		
measObjectId[2]	IdMeasObject-f6		
measObject[2]	MeasObjectEUTRA- GENERIC(f6)		
}			
reportConfigToAddModList SEQUENCE (SIZE (1..maxReportConfigId)) OF SEQUENCE {	2 entries		
reportConfigId[1]	IdReportConfig-A2		
reportConfig[1]	ReportConfig-A2		
reportConfigId[2]	IdReportConfig-A3		
reportConfig[2]	ReportConfig-A3		
}			
measIdToAddModList SEQUENCE (SIZE (1..maxMeasId)) OF SEQUENCE {	2 entries		
measId[1]	1		
measObjectId[1]	IdMeasObject-f6		
reportConfigId[1]	IdReportConfig-A2		
measId[2]	2		
measObjectId[2]	IdMeasObject-f1		
reportConfigId[2]	IdReportConfig-A3		
}			
}			

8.3.1.15 Measurement configuration control and reporting / Intra E-UTRAN measurements / Inter-band handover / IE measurement configuration not present

8.3.1.15.1 Test Purpose (TP)

(1)

```

with { UE having completed the radio bearer establishment, initial security activation procedure and
performed the intra-frequency and inter-band measurements }
ensure that {
  when { UE receives an RRConnectionReconfiguration message including a mobilityControlInfo
indicating a different E-UTRA frequency band and not including a measConfig }
  then { UE performs inter-band handover, continues the intra-frequency measurement and continues
inter-band measurement after the activation of the measurement gaps }
}

```

8.3.1.15.2 Conformance requirements

References: The conformance requirements covered in the present TC are specified in: TS 36.331, clause 5.5.6.1.

[TS 36.331, clause 5.5.6.1]

E-UTRAN applies the handover procedure as follows:

- when performing the handover procedure, as specified in 5.3.5.4, ensure that a *measObjectId* corresponding to the handover target carrier frequency is configured as a result of the procedures described in this sub-clause and in 5.3.5.4;

...

The UE shall:

- 1> for each *measId* included in the *measIdList* within *VarMeasConfig*:
 - 2> if the *triggerType* is set to 'periodical':
 - 3> remove this *measId* from the *measIdList* within *VarMeasConfig*;
- 1> if the procedure was triggered due to inter-frequency handover or successful re-establishment to an inter-frequency cell, update the *measId* values in the *measIdList* within *VarMeasConfig* as follows:
 - 2> if a *measObjectId* value corresponding to the target carrier frequency exists in the *measObjectList* within *VarMeasConfig*:
 - 3> for each *measId* value in the *measIdList*:
 - 4> if the *measId* value is linked to the *measObjectId* value corresponding to the source carrier frequency:
 - 5> link this *measId* value to the *measObjectId* value corresponding to the target carrier frequency;
 - 4> else if the *measId* value is linked to the *measObjectId* value corresponding to the target carrier frequency:
 - 5> link this *measId* value to the *measObjectId* value corresponding to the source carrier frequency;
 - 2> else:
 - 3> remove all *measId* values that are linked to the *measObjectId* value corresponding to the source carrier frequency;
 - 1> remove all measurement reporting entries within *VarMeasReportList*;
 - 1> stop the periodical reporting timer or timer T321, whichever one is running, as well as associated information (e.g. *timeToTrigger*) for all *measId*;
 - 1> release the measurement gaps, if activated;

NOTE: If the UE requires measurement gaps to perform inter-frequency or inter-RAT measurements, the UE resumes the inter-frequency and inter-RAT measurements after the E-UTRAN has setup the measurement gaps.

8.3.1.15.3 Test description

8.3.1.15.3.1 Pre-test conditions

System Simulator:

- Cell 1, Cell 2, Cell 10 and Cell 30
- System information combination 3 as defined in TS 36.508 [18] clause 4.4.3.1 is used in E-UTRA cells.

UE:

None.

Preamble:

- The UE is in state Generic RB Established (state 3) on Cell 1 according to [18].

8.3.1.15.3.2 Test procedure sequence

Table 8.3.1.15.3.2-1 illustrates the downlink power levels and other changing parameters to be applied for the cells at various time instants of the test execution. Row marked "T0" denotes the initial conditions after preamble, while columns marked "T1", "T2", "T3", and "T4" are to be applied subsequently. The exact instants on which these values shall be applied are described in the texts in this clause.

Table 8.3.1.15.3.2-1: Time instances of cell power level and parameter changes

	Parameter	Unit	Cell 1	Cell 2 (DL only)	Cell 10	Cell 30 (DL only)	Remark
T0	Cell-specific RS EPRE	dBm/15 kHz	-85	-91	-97	"Off"	The power level values are such that measurement results for Cell 1 (M1) and Cell 2 (M2) do not satisfy entry condition for event A3 ($M2 < M1$). (NOTE 1).
T1	Cell-specific RS EPRE	dBm/15 kHz	-85	-79	-97	"Off"	The power level values are such that measurement results for Cell 1 (M1) and Cell 2 (M2) satisfy entry condition for event A3 ($M2 > M1$). (NOTE 1).
T2	Cell-specific RS EPRE	dBm/15 kHz	-85	"Off"	-73	"Off"	The power level values are such that measurement results for Cell 1 (M1) and Cell 10 (M10) satisfy entry condition for event A3 ($M10 > M1$). (NOTE 1).
T3	Cell-specific RS EPRE	dBm/15 kHz	-97	"Off"	-85	-79	The power level values are such that measurement results for Cell 10 (M10) and Cell 30 (M30) satisfy entry condition for event A3 ($M30 > M10$). (NOTE 1).
T4	Cell-specific RS EPRE	dBm/15 kHz	-73	"Off"	-85	"Off"	The power level values are such that measurement results for Cell 1 (M1) and Cell 10 (M10) satisfy entry condition for event A3 ($M1 > M10$). (NOTE 1).

NOTE 1: Power level "Off" is defined in TS36.508 Table 6.2.2.1-1.

Table 8.3.1.15.3.2-2: Main behaviour

St	Procedure	Message Sequence		TP	Verdict
		U - S	Message		
1	The SS transmits an <i>RRCCONNECTIONRECONFIGURATION</i> message to setup intra-frequency and inter-band measurements on Cell 1.	<--	<i>RRCCONNECTIONRECONFIGURATION</i>	-	-
2	The UE transmits an <i>RRCCONNECTIONRECONFIGURATIONCOMPLETE</i> message to confirm the setup of intra-frequency and inter-band measurements on Cell 1.	-->	<i>RRCCONNECTIONRECONFIGURATIONCOMPLETE</i>	-	-
3	The SS changes the cell-specific reference signal levels of Cell 2 according to the row "T1" in table 8.3.1.15.3.2-1.	-	-	-	-
4	The UE transmits a <i>MEASUREMENTREPORT</i> message on Cell 1 to perform event A3 intra-frequency reporting for Cell 2 during the next 30 s.	-->	<i>MEASUREMENTREPORT</i>	-	-
5	The SS changes the cell-specific reference signal levels of Cell 10 and switches "Off" Cell 2 according to row "T2" in table 8.3.1.15.3.2-1.	-	-	-	-
6	The UE transmits a <i>MEASUREMENTREPORT</i> message on Cell 1 to perform event A3 inter-band reporting for Cell 10 during the next 30 s.	-->	<i>MEASUREMENTREPORT</i>	-	-
7	The SS transmits an <i>RRCCONNECTIONRECONFIGURATION</i> message without a <i>measConfig</i> , to order the UE to perform inter-band handover to Cell 10.	<--	<i>RRCCONNECTIONRECONFIGURATION</i>	-	-
8	Check: Does the UE transmit an <i>RRCCONNECTIONRECONFIGURATIONCOMPLETE</i> message to Cell 10?	-->	<i>RRCCONNECTIONRECONFIGURATIONCOMPLETE</i>	1	P
9	The SS transmits an <i>RRCCONNECTIONRECONFIGURATION</i> message to activate the measurement gaps on Cell 10.	<--	<i>RRCCONNECTIONRECONFIGURATION</i>	-	-
10	The UE transmits an <i>RRCCONNECTIONRECONFIGURATIONCOMPLETE</i> message to confirm the activation of the measurement gaps on Cell 10.	-->	<i>RRCCONNECTIONRECONFIGURATIONCOMPLETE</i>	-	-
11	The SS changes the cell-specific reference signal levels of Cell 1 and Cell 10 and switches "On" Cell 30 according to the row "T3" in table 8.3.1.15.3.2-1.	-	-	-	-
12	Check: Does the UE transmit a <i>MEASUREMENTREPORT</i> message on Cell 10 to perform event A3 intra-frequency reporting for Cell 30 during the next 30 s?	-->	<i>MEASUREMENTREPORT</i>	1	P
13	The SS changes the cell-specific reference signal levels of Cell 1 and switches Cell 30 off according to row "T4" in table 8.3.1.15.3.2-1.	-	-	-	-
14	Check: Does the UE transmit a <i>MEASUREMENTREPORT</i> message on Cell 10 to perform event A3 inter-band reporting for Cell 1 during the next 30 s?	-->	<i>MEASUREMENTREPORT</i>	1	P
15	Check: Does the test result of generic test procedure in TS 36.508 subclause 6.4.2.3 indicate that the UE is in E-UTRA RRC_CONNECTED state on Cell 10?	-	-	1	-

8.3.1.15.3.3 Specific message contents

Table 8.3.1.15.3.3-1: *RRCCONNECTIONRECONFIGURATION* (step 1, Table 8.3.1.15.3.2-2)

Derivation Path: 36.508 Table 4.6.1-8, condition MEAS

Table 8.3.1.15.3.3-2: *MeasConfig* (Table 8.3.1.15.3.3-1)

Derivation Path: 36.508, Table 4.6.6-1, condition INTER-FREQ			
Information Element	Value/remark	Comment	Condition
MeasConfig ::= SEQUENCE {			
measObjectToAddModList SEQUENCE (SIZE (1..maxObjectId)) OF SEQUENCE {	2 entries		
measObjectId[1]	IdMeasObject-f1		
measObject[1]	MeasObjectEUTRA-GENERIC(f1)		
measObjectId[2]	IdMeasObject-f5		
measObject[2]	MeasObjectEUTRA-GENERIC(f5)		
}			
reportConfigToAddModList SEQUENCE (SIZE (1..maxReportConfigId)) OF SEQUENCE {	1 entry		
reportConfigId[1]	IdReportConfig-A3		
reportConfig[1]	ReportConfigEUTRA-A3		
}			
measIdToAddModList SEQUENCE (SIZE (1..maxMeasId)) OF SEQUENCE {	2 entries		
measId[1]	1		
measObjectId[1]	IdMeasObject-f1		
reportConfigId[1]	IdReportConfig-A3		
measId[2]	2		
measObjectId[2]	IdMeasObject-f5		
reportConfigId[2]	IdReportConfig-A3		
}			
}			

Table 8.3.1.15.3.3-3: *MeasurementReport* (step 4, Table 8.3.1.15.3.2-2)

Derivation Path: 36.508 Table 4.6.1-5			
Information Element	Value/remark	Comment	Condition
MeasurementReport ::= SEQUENCE {			
criticalExtensions CHOICE {			
c1 CHOICE{			
measurementReport-r8 SEQUENCE {			
measResults SEQUENCE {			
measId	1		
measResultServCell SEQUENCE {			
rsrpResult	(0..97)		
rsrqResult	(0..34)		
}			
measResultNeighCells CHOICE {			
measResultListEUTRA SEQUENCE (SIZE (1..maxCellReport)) OF SEQUENCE {	1 entry		
physCellId[1]	PhysicalCellIdentity of Cell 2		
cgi-Info[1]	Not present		
measResult[1] SEQUENCE {			
rsrpResult	(0..97)		
rsrqResult	(0..34)		
additionalSI-Info-r9	Not present		
}			
}			
}			
measResultForECID-r9	Not present		
}			
}			
}			

Table 8.3.1.15.3.3-4: MeasurementReport (step 6, Table 8.3.1.15.3.2-2)

Derivation Path: 36.508 Table 4.6.1-5			
Information Element	Value/remark	Comment	Condition
MeasurementReport ::= SEQUENCE {			
criticalExtensions CHOICE {			
c1 CHOICE{			
measurementReport-r8 SEQUENCE {			
measResults SEQUENCE {			
measId	2		
measResultServCell SEQUENCE {			
rsrpResult	(0..97)		
rsrqResult	(0..34)		
}			
measResultNeighCells CHOICE {			
measResultListEUTRA SEQUENCE (SIZE (1..maxCellReport)) OF SEQUENCE {	1 entry		
physCellId[1]	PhysicalCellIdentity of Cell 10		
cgi-Info[1]	Not present		
measResult[1] SEQUENCE {			
rsrpResult	(0..97)		
rsrqResult	(0..34)		
additionalSI-Info-r9	Not present		
}			
}			
}			
measResultForECID-r9	Not present		
}			
}			
}			

Table 8.3.1.15.3.3-5: RRCConnectionReconfiguration (step 7, Table 8.3.1.15.3.2-2)

Derivation Path: 36.508 Table 4.6.1-8, condition HO

Table 8.3.1.15.3.3-6: MobilityControlInfo (Table 8.3.1.15.3.3-5)

Derivation Path: 36.508 Table 4.6.5-1			
Information Element	Value/remark	Comment	Condition
MobilityControlInfo ::= SEQUENCE {			
targetPhysCellId	PhysicalCellIdentity of Cell 10		
carrierFreq SEQUENCE {			
dl-CarrierFreq	Same downlink EARFCN as used for Cell 10		
ul-CarrierFreq	Not present		
}			
}			

Table 8.3.1.15.3.3-7: RRCConnectionReconfiguration (step 9, Table 8.3.1.15.3.2-2)

Derivation Path: 36.508, Table 4.6.1-8, condition MEAS
--

Table 8.3.1.15.3.3-8: MeasConfig (Table 8.3.1.15.3.3-7)

Derivation Path: 36.508, Table 4.6.6-1, condition INTER-FREQ
--

Table 8.3.1.15.3.3-9: *MeasurementReport* (step 12, Table 8.3.1.15.3.2-2)

Derivation Path: 36.508 Table 4.6.1-5			
Information Element	Value/remark	Comment	Condition
MeasurementReport ::= SEQUENCE {			
criticalExtensions CHOICE {			
c1 CHOICE{			
measurementReport-r8 SEQUENCE {			
measResults SEQUENCE {			
measId	1		
measResultServCell SEQUENCE {			
rsrpResult	(0..97)		
rsrqResult	(0..34)		
}			
measResultNeighCells CHOICE {			
measResultListEUTRA SEQUENCE (SIZE (1..maxCellReport)) OF SEQUENCE {	1 entry		
physCellId[1]	PhysicalCellIdentity of Cell 30		
cgi-Info[1]	Not present		
measResult[1] SEQUENCE {			
rsrpResult	(0..97)		
rsrqResult	(0..34)		
additionalSI-Info-r9	Not present		
}			
}			
}			
measResultForECID-r9	Not present		
}			
}			
}			
}			

Table 8.3.1.15.3.3-10: *MeasurementReport* (step 14, Table 8.3.1.15.3.2-2)

Derivation Path: 36.508 Table 4.6.1-5			
Information Element	Value/remark	Comment	Condition
MeasurementReport ::= SEQUENCE {			
criticalExtensions CHOICE {			
c1 CHOICE{			
measurementReport-r8 SEQUENCE {			
measResults SEQUENCE {			
measId	2		
measResultServCell SEQUENCE {			
rsrpResult	(0..97)		
rsrqResult	(0..34)		
}			
measResultNeighCells CHOICE {			
measResultListEUTRA SEQUENCE (SIZE (1..maxCellReport)) OF SEQUENCE {	1 entry		
physCellId[1]	PhysicalCellIdentity of Cell 1		
cgi-Info[1]	Not present		
measResult[1] SEQUENCE {			
rsrpResult	(0..97)		
rsrqResult	(0..34)		
additionalSI-Info-r9	Not present		
}			
}			
}			
measResultForECID-r9	Not present		
}			
}			

8.3.1.15a Measurement configuration control and reporting / Intra E-UTRAN measurements / Inter-band handover / IE measurement configuration not present / Between FDD and TDD

8.3.1.15a.1 Test Purpose (TP)

(1)

```
with { UE in E-UTRA FDD RRC_CONNECTED state and having completed the radio bearer establishment,
initial security activation procedure and performed the intra frequency and inter-band E-UTRA TDD
frequency measurements }
ensure that {
  when { UE receives an RRCConnectionReconfiguration message including a mobilityControlInfo
indicating a different E-UTRA TDD frequency in different band and not including a measConfig }
  then { UE performs inter-band handover, continues the intra frequency measurement and continues
inter-band measurement after the activation of the measurement gaps }
}
```

(2)

```
with { UE in E-UTRA TDD RRC_CONNECTED state and having completed the radio bearer establishment,
initial security activation procedure and performed the intra frequency and inter-band E-UTRA FDD
frequency measurements }
ensure that {
  when { UE receives an RRCConnectionReconfiguration message including a mobilityControlInfo
indicating a different E-UTRA FDD frequency in different band and not including a measConfig }
  then { UE performs inter-band handover, continues the intra frequency measurement and continues
inter-band measurement after the activation of the measurement gaps }
}
```

8.3.1.15a.2 Conformance requirements

References: The conformance requirements covered in the present TC are specified in: TS 36.331, clause 5.5.6.1.

[TS 36.331, clause 5.5.6.1]

E-UTRAN applies the handover procedure as follows:

- when performing the handover procedure, as specified in 5.3.5.4, ensure that a *measObjectId* corresponding to the handover target carrier frequency is configured as a result of the procedures described in this subclause and in 5.3.5.4;

...

The UE shall:

- 1> for each *measId* included in the *measIdList* within *VarMeasConfig*:
 - 2> if the *triggerType* is set to 'periodical':
 - 3> remove this *measId* from the *measIdList* within *VarMeasConfig*:
- 1> if the procedure was triggered due to inter-frequency handover or successful re-establishment to an inter-frequency cell, update the *measId* values in the *measIdList* within *VarMeasConfig* as follows:
 - 2> if a *measObjectId* value corresponding to the target carrier frequency exists in the *measObjectList* within *VarMeasConfig*
 - 3> for each *measId* value in the *measIdList*:
 - 4> if the *measId* value is linked to the *measObjectId* value corresponding to the source carrier frequency:
 - 5> link this *measId* value to the *measObjectId* value corresponding to the target carrier frequency;
 - 4> else if the *measId* value is linked to the *measObjectId* value corresponding to the target carrier frequency:
 - 5> link this *measId* value to the *measObjectId* value corresponding to the source carrier frequency;
 - 2> else:
 - 3> remove all *measId* values that are linked to the *measObjectId* value corresponding to the source carrier frequency;
 - 1> remove all measurement reporting entries within *VarMeasReportList*;
 - 1> reset the periodical reporting timer or timer T321, whichever one is running, as well as associated information (e.g. *timeToTrigger*) for all *measId*;
 - 1> release the measurement gaps, if activated;

NOTE: If the UE requires measurement gaps to perform inter-frequency or inter-RAT measurements, the UE resumes the inter-frequency and inter-RAT measurements after the E-UTRAN has setup the measurement gaps.

8.3.1.15a.3 Test description

8.3.1.15a.3.1 Pre-test conditions

System Simulator:

- Cell 1 and Cell 2 are E-UTRA FDD cells, Cell 10 and Cell 30 are E-UTRA TDD cell
- Each cell has only a single PLMN identity. The PLMNs are identified in the test by the identifiers in Table 8.3.1.15a.3.1-1.

Table 8.3.1.15a.3.1-1: PLMN identifiers

Cell	PLMN name
1	PLMN1
2	PLMN1
10	PLMN1
30	PLMN2

s

- System information combination 3 as defined in TS 36.508 [18] clause 4.4.3.1 and Table 6.3.1.2-2 is used in E-UTRA cells.

UE:

None.

Preamble:

- The UE is registered on PLMN1 (Cell 1) using the procedure described in TS 36.508[18] clause 4.5.2.3 except that the ATTACH ACCEPT message indicates PLMN2 in the Equivalent PLMN list as described in Table 8.3.1.15a.3.3-12.
- The UE is in state Generic RB Established (state 3) on Cell 1 according to [18].

8.3.1.15a.3.2 Test procedure sequence

Table 8.3.1.15a.3.2-1 illustrates the downlink power levels and other changing parameters to be applied for the cells at various time instants of the test execution. Row marked "T0" denotes the initial conditions after preamble, while columns marked "T1", "T2", "T3", and "T4" are to be applied subsequently. The exact instants on which these values shall be applied are described in the texts in this clause.

Table 8.3.1.15a.3.2-1: Time instances of cell power level and parameter changes

	Parameter	Unit	Cell 1	Cell 2 (DL only)	Cell 10	Cell 30 (DL only)	Remark
T0	Cell-specific RS EPRE	dBm/15 kHz	-85	-91	-97	"Off"	The power level values are such that measurement results for Cell 1 (M1) and Cell 2 (M2) do not satisfy entry condition for event A3 ($M2 < M1$). (NOTE 1).
T1	Cell-specific RS EPRE	dBm/15 kHz	-85	-79	-97	"Off"	The power level values are such that measurement results for Cell 1 (M1) and Cell 2 (M2) satisfy entry condition for event A3 ($M2 > M1$). (NOTE 1).
T2	Cell-specific RS EPRE	dBm/15 kHz	-85	"Off"	-73	"Off"	The power level values are such that measurement results for Cell 1 (M1) and Cell 10 (M10) satisfy entry condition for event A3 ($M10 > M1$). (NOTE 1).
T3	Cell-specific RS EPRE	dBm/15 kHz	-97	"Off"	-85	-79	The power level values are such that measurement results for Cell 10 (M10) and Cell 30 (M30) satisfy entry condition for event A3 ($M30 > M10$). (NOTE 1).
T4	Cell-specific RS EPRE	dBm/15 kHz	-73	"Off"	-85	"Off"	The power level values are such that measurement results for Cell 1 (M1) and Cell 10 (M10) satisfy entry condition for event A3 ($M1 > M10$). (NOTE 1).
T5	Cell-specific RS EPRE	dBm/15 kHz	-85	-79	-97	"Off"	The power level values are such that measurement results for Cell 1 (M1) and Cell 2 (M2) satisfy entry condition for event A3 ($M2 > M1$). (NOTE 1).
T6	Cell-specific RS EPRE	dBm/15 kHz	-85	"Off"	-73	"Off"	The power level values are such that measurement results for Cell 1 (M1) and Cell 10 (M10) satisfy entry condition for event A3 ($M10 > M1$). (NOTE 1).
NOTE 1: Power level "Off" is defined in TS36.508 Table 6.2.2.1-1.							

Table 8.3.1.15a.3.2-2: Main behaviour

St	Procedure	Message Sequence		TP	Verdict
		U - S	Message		
1	The SS transmits an <i>RRConnectionReconfiguration</i> message to setup intra frequency and inter-band measurements on Cell 1.	<--	<i>RRConnectionReconfiguration</i>	-	-
2	The UE transmits an <i>RRConnectionReconfigurationComplete</i> message to confirm the setup of intra frequency and inter-band measurements on Cell 1.	-->	<i>RRConnectionReconfigurationComplete</i>	-	-
3	The SS changes the cell-specific reference signal levels of Cell 2 according to the row "T1" in table 8.3.1.15a.3.2-1.	-	-	-	-
4	The UE transmits a <i>MeasurementReport</i> message on Cell 1 to perform event A3 intra frequency reporting for Cell 2 during the next 30 s.	-	<i>MeasurementReport</i>	-	-
5	The SS changes the cell-specific reference signal levels of Cell 10 and switches "Off" Cell 2 according to row "T2" in table 8.3.1.15a.3.2-1.	-	-	-	-
6	The UE transmits a <i>MeasurementReport</i> message on Cell 1 to perform event A3 inter-band reporting for Cell 10 during the next 30 s.	-->	<i>MeasurementReport</i>	-	-
7	The SS transmits an <i>RRConnectionReconfiguration</i> message without a <i>measConfig</i> , to order the UE to perform inter-band handover to Cell 10.	<--	<i>RRConnectionReconfiguration</i>	-	-
8	Check: Does the UE transmit an <i>RRConnectionReconfigurationComplete</i> message to Cell 10?	-->	<i>RRConnectionReconfigurationComplete</i>	1	P
8A	The UE transmits a TRACKING AREA UPDATE REQUEST message on Cell 10.	-	-	-	-
8B	SS responds with a TRACKING AREA UPDATE ACCEPT message.	-	-	-	-
8C	The UE transmits a TRACKING AREA UPDATE COMPLETE message.	-	-	-	-
9	The SS transmits an <i>RRConnectionReconfiguration</i> message to activate the measurement gaps on Cell 10.	<--	<i>RRConnectionReconfiguration</i>	-	-
10	The UE transmits an <i>RRConnectionReconfigurationComplete</i> message to confirm the activation of the measurement gaps on Cell 10.	-->	<i>RRConnectionReconfigurationComplete</i>	-	-
10 A	Void	-	-	-	-
10 B	Void	-	-	-	-
10 C	Void	-	-	-	-
11	The SS changes the cell-specific reference signal levels of Cell 1 and Cell 10 and switches "On" Cell 30 according to the row "T3" in table 8.3.1.15a.3.2-1.	-	-	-	-
12	Check: Does the UE transmit a <i>MeasurementReport</i> message on Cell 10 to perform event A3 intra frequency reporting for Cell 30 during the next 30 s?	-->	<i>MeasurementReport</i>	1	P
13	The SS changes the cell-specific reference signal levels of Cell 1 and switches Cell 30 off according to row "T4" in table 8.3.1.15a.3.2-1.	-	-	-	-
14	Check: Does the UE transmit a <i>MeasurementReport</i> message on Cell 10 to perform event A3 inter-band reporting for Cell	-->	<i>MeasurementReport</i>	1	P

	1 during the next 30 s?				
15	The SS transmits an <i>RRCCONNECTIONRECONFIGURATION</i> message without a <i>measConfig</i> , to order the UE to perform inter-band handover to Cell 1.	<--	<i>RRCCONNECTIONRECONFIGURATION</i>	-	-
16	Check: Does the UE transmit an <i>RRCCONNECTIONRECONFIGURATIONCOMPLETE</i> message to Cell 1?	-->	<i>RRCCONNECTIONRECONFIGURATIONCOMPLETE</i>	2	P
16 A	The UE transmits a TRACKING AREA UPDATE REQUEST message on Cell 1.	-	-	-	-
16 B	SS responds with a TRACKING AREA UPDATE ACCEPT message.	-	-	-	-
16 C	The UE transmits a TRACKING AREA UPDATE COMPLETE message.	-	-	-	-
17	The SS transmits an <i>RRCCONNECTIONRECONFIGURATION</i> message to activate the measurement gaps on Cell 1.	<--	<i>RRCCONNECTIONRECONFIGURATION</i>	-	-
18	The UE transmits an <i>RRCCONNECTIONRECONFIGURATIONCOMPLETE</i> message to confirm the activation of the measurement gaps on Cell 1.	-->	<i>RRCCONNECTIONRECONFIGURATIONCOMPLETE</i>	-	-
18 A	Void	-	-	-	-
18 B	Void	-	-	-	-
18 C	Void	-	-	-	-
19	The SS changes the cell-specific reference signal levels of Cells according to the row "T5" in table 8.3.1.15a.3.2-1.	-	-	-	-
20	The UE transmits a <i>MEASUREMENTREPORT</i> message on Cell 1 to perform event A3 intra frequency reporting for Cell 2 during the next 30 s.	-	<i>MEASUREMENTREPORT</i>	2	P
21	The SS changes the cell-specific reference signal levels of Cells according to row "T6" in table 8.3.1.15a.3.2-1.	-	-	-	-
22	The UE transmits a <i>MEASUREMENTREPORT</i> message on Cell 1 to perform event A3 inter-band reporting for Cell 10 during the next 30 s.	-->	<i>MEASUREMENTREPORT</i>	2	P
23	Check: Does the test result of generic test procedure in TS 36.508 subclause 6.4.2.3 indicate that the UE is in E-UTRA RRC_CONNECTED state on Cell 1?	-	-	2	-

8.3.1.15a.3.3 Specific message contents

Table 8.3.1.15a.3.3-1: *RRCCONNECTIONRECONFIGURATION* (step 1, Table 8.3.1.15a.3.2-1)

Derivation Path: 36.508, Table 4.6.1-8, condition MEAS
--

Table 8.3.1.15a.3.3-2: MeasConfig (Table 8.3.1.15a.3.3-1)

Derivation Path: 36.508, Table 4.6.6-1, condition INTER-FREQ			
Information Element	Value/remark	Comment	Condition
MeasConfig ::= SEQUENCE {			
measObjectToAddModList SEQUENCE (SIZE (1..maxObjectId)) OF SEQUENCE {	2 entries		
measObjectId[1]	IdMeasObject-f1		
measObject[1]	MeasObjectEUTRA-GENERIC(f1)		
measObjectId[2]	IdMeasObject-f5		
measObject[2]	MeasObjectEUTRA-GENERIC(f5)		
}			
reportConfigToAddModList SEQUENCE (SIZE (1..maxReportConfigId)) OF SEQUENCE {	1 entry		
reportConfigId[1]	IdReportConfig-A3		
reportConfig[1]	ReportConfigEUTRA-A3		
}			
measIdToAddModList SEQUENCE (SIZE (1..maxMeasId)) OF SEQUENCE {	2 entries		
measId[1]	1		
measObjectId[1]	IdMeasObject-f1		
reportConfigId[1]	IdReportConfig-A3		
measId[2]	2		
measObjectId[2]	IdMeasObject-f5		
reportConfigId[2]	IdReportConfig-A3		
}			
}			

Table 8.3.1.15a.3.3-3: MeasurementReport (step 4 and step 20, Table 8.3.1.15a.3.2-2)

Derivation Path: 36.508, Table 4.6.1-5			
Information Element	Value/remark	Comment	Condition
MeasurementReport ::= SEQUENCE {			
criticalExtensions CHOICE {			
c1 CHOICE{			
measurementReport-r8 SEQUENCE {			
measResults SEQUENCE {			
measId	1		
measResultServCell SEQUENCE {		Cell 1	
rsrpResult	(0..97)		
rsrqResult	(0..34)		
}			
measResultNeighCells CHOICE {			
measResultListEUTRA SEQUENCE (SIZE (1..maxCellReport)) OF SEQUENCE {	1 entry		
physCellId[1]	PhysicalCellIdentity of Cell 2	Cell 2	
cgi-Info[1]	Not present		
measResult[1] SEQUENCE {			
rsrpResult	(0..97)		
rsrqResult	(0..34)		
}			
}			
}			
}			
}			

Table 8.3.1.15a.3.3-4: MeasurementReport (step 6 and step 22, Table 8.3.1.15a.3.2-2)

Derivation Path: 36.508, Table 4.6.1-5			
Information Element	Value/remark	Comment	Condition
MeasurementReport ::= SEQUENCE {			
criticalExtensions CHOICE {			
c1 CHOICE{			
measurementReport-r8 SEQUENCE {			
measResults SEQUENCE {			
measId	2		
measResultServCell SEQUENCE {		Cell 1	
rsrpResult	(0..97)		
rsrqResult	(0..34)		
}			
measResultNeighCells CHOICE {			
measResultListEUTRA SEQUENCE (SIZE (1..maxCellReport)) OF SEQUENCE {	1 entry		
physCellId[1]	PhysicalCellIdentity of Cell 10	Cell 10	
cgi-Info[1]	Not present		
measResult[1] SEQUENCE {			
rsrpResult	(0..97)		
rsrqResult	(0..34)		
}			
}			
}			
}			
}			
}			
}			
}			
}			
}			
}			
}			

Table 8.3.1.15a.3.3-5: RRCConnectionReconfiguration (step 7 and step 15, Table 8.3.1.15a.3.2-2)

Derivation Path: 36.508, Table 4.6.1-8, condition HO
--

Table 8.3.1.15a.3.3-6: MobilityControlInfo (step 7, Table 8.3.1.15a.3.3-5)

Derivation Path: 36.508, Table 4.6.5-1			
Information Element	Value/remark	Comment	Condition
MobilityControlInfo ::= SEQUENCE {			
targetPhysCellId	PhysicalCellIdentity of Cell 10		
carrierFreq SEQUENCE {			
dl-CarrierFreq	Same DL EARFCN as used for Cell 10		
ul-CarrierFreq	Not present		
}			
}			

Table 8.3.1.15a.3.3-7: *MobilityControllInfo* (step 15, Table 8.3.1.15a.3.3-5)

Derivation Path: 36.508, Table 4.6.5-1			
Information Element	Value/remark	Comment	Condition
MobilityControllInfo ::= SEQUENCE {			
targetPhysCellId	PhysicalCellIdentity of Cell 1		
carrierFreq SEQUENCE {			
dl-CarrierFreq	Same DL EARFCN as used for Cell 1		
ul-CarrierFreq	Same UL EARFCN as used for Cell 1		
}			
}			

Table 8.3.1.15a.3.3-8: *RRCConnectionReconfiguration* (step 9 and step 17, Table 8.3.1.15a.3.2-2)

Derivation Path: 36.508, Table 4.6.1-8, condition MEAS
--

Table 8.3.1.15a.3.3-9: *MeasConfig* (Table 8.3.1.15a.3.3-8)

Derivation Path: 36.508, Table 4.6.6-1, condition INTER-FREQ
--

Table 8.3.1.15a.3.3-10: *MeasurementReport* (step 12, Table 8.3.1.15a.3.2-2)

Derivation Path: 36.508, Table 4.6.1-5			
Information Element	Value/remark	Comment	Condition
MeasurementReport ::= SEQUENCE {			
criticalExtensions CHOICE {			
c1 CHOICE{			
measurementReport-r8 SEQUENCE {			
measResults SEQUENCE {			
measId	1		
measResultServCell SEQUENCE {		Cell 10	
rsrpResult	(0..97)		
rsrqResult	(0..34)		
}			
measResultNeighCells CHOICE {			
measResultListEUTRA SEQUENCE (SIZE (1..maxCellReport)) OF SEQUENCE {	1 entry		
physCellId[1]	PhysicalCellIdentity of Cell 30	Cell 30	
cgi-Info[1]	Not present		
measResult[1] SEQUENCE {			
rsrpResult	(0..97)		
rsrqResult	(0..34)		
}			
}			
}			
}			
}			

Table 8.3.1.15a.3.3-11: *MeasurementReport* (step 14, Table 8.3.1.15a.3.2-2)

Derivation Path: 36.508, Table 4.6.1-5			
Information Element	Value/remark	Comment	Condition
MeasurementReport ::= SEQUENCE {			
criticalExtensions CHOICE {			
c1 CHOICE{			
measurementReport-r8 SEQUENCE {			
measResults SEQUENCE {			
measId	2		
measResultServCell SEQUENCE {		Cell 10	
rsrpResult	(0..97)		
rsrqResult	(0..34)		
}			
measResultNeighCells CHOICE {			
measResultListEUTRA SEQUENCE (SIZE (1..maxCellReport)) OF SEQUENCE {	1 entry		
physCellId[1]	PhysicalCellIdentity of Cell 1	Cell 1	
cgi-Info[1]	Not present		
measResult[1] SEQUENCE {			
rsrpResult	(0..97)		
rsrqResult	(0..34)		
}			
}			
}			
}			
}			
}			

Table 8.3.1.15a.3.3-12: ATTACH ACCEPT for Cell 1 (preamble)

Derivation path: 36.508 Table 4.7.2-1			
Information Element	Value/Remark	Comment	Condition
Equivalent PLMNs	PLMN2		

8.3.1.16 Measurement configuration control and reporting / Intra E-UTRAN measurements / Continuation of the measurements after RRC connection re-establishment / Inter-band

8.3.1.16.1 Test Purpose (TP)

(1)

```

with { UE having completed the radio bearer establishment, initial security activation procedure and
performed the inter-band measurement and after receiving an RRCConnectionReconfiguration message
including a mobilityControlInfo indicating a different E-UTRA cell having attempted intra-frequency
handover }
ensure that {
  when { UE detects handover failure and the intra-frequency cell is selectable }
  then { UE performs RRC Connection Re-establishment and continues the inter-band measurement
after the activation of the measurement gaps }
}

```

8.3.1.16.2 Conformance requirements

References: The conformance requirements covered in the present TC are specified in: TS 36.331, clause 5.3.5.4, 5.3.5.6, 5.3.7.2 and 5.5.6.1.

[TS 36.331, clause 5.3.5.4]

If the *RRCConnectionReconfiguration* message includes the *mobilityControlInfo* and the UE is able to comply with the configuration included in this message, the UE shall:

- 1> stop timer T310, if running;
- 1> start timer T304 with the timer value set to *t304*, as included in the *mobilityControlInfo*;
- 1> if the *carrierFreq* is included:
 - 2> consider the target cell to be one on the frequency indicated by the *carrierFreq* with a physical cell identity indicated by the *targetPhysCellId*;
- 1> else:
 - 2> consider the target cell to be one on the current frequency with a physical cell identity indicated by the *targetPhysCellId*;
- 1> start synchronising to the DL of the target cell;

NOTE 1: The UE should perform the handover as soon as possible following the reception of the RRC message triggering the handover, which could be before confirming successful reception (HARQ and ARQ) of this message.

- 1> reset MAC;
- 1> re-establish PDCP for all RBs that are established;

NOTE 2: The handling of the radio bearers after the successful completion of the PDCP re-establishment, e.g. the re-transmission of unacknowledged PDCP SDUs (as well as the associated status reporting), the handling of the SN and the HFN, is specified in TS 36.323 [8].

- 1> re-establish RLC for all RBs that are established;
- 1> apply the value of the *newUE-Identity* as the C-RNTI;
- 1> if the *RRCConnectionReconfiguration* message includes the *fullConfig*:
 - 2> perform the radio configuration procedure as specified in section 5.3.5.8;
- 1> configure lower layers in accordance with the received *radioResourceConfigCommon*;
- 1> configure lower layers in accordance with any additional fields, not covered in the previous, if included in the received *mobilityControlInfo*;
- 1> if the *RRCConnectionReconfiguration* message includes the *radioResourceConfigDedicated*:
 - 2> perform the radio resource configuration procedure as specified in 5.3.10;

...

- 1> perform the measurement related actions as specified in 5.5.6.1;
- 1> if the *RRCConnectionReconfiguration* message includes the *measConfig*:
 - 2> perform the measurement configuration procedure as specified in 5.5.2;
- 1> release *reportProximityConfig* and clear any associated proximity status reporting timer;
- 1> if the *RRCConnectionReconfiguration* message includes the *reportProximityConfig*:
 - 2> perform the proximity indication in accordance with the received *reportProximityConfig*;
- 1> submit the *RRCConnectionReconfigurationComplete* message to lower layers for transmission;
- 1> if MAC successfully completes the random access procedure:
 - 2> stop timer T304;
 - 2> apply the parts of the CQI reporting configuration, the scheduling request configuration and the sounding RS configuration that do not require the UE to know the SFN of the target cell, if any;

- 2> apply the parts of the measurement and the radio resource configuration that require the UE to know the SFN of the target cell (e.g. measurement gaps, periodic CQI reporting, scheduling request configuration, sounding RS configuration), if any, upon acquiring the SFN of the target cell;

NOTE 3: Whenever the UE shall setup or reconfigure a configuration in accordance with a field that is received it applies the new configuration, except for the cases addressed by the above statements.

- 2> the procedure ends;

[TS 36.331, clause 5.3.5.6]

The UE shall:

- 1> if T304 expires (handover failure):

NOTE: Following T304 expiry any dedicated preamble, if provided within the *rach-ConfigDedicated*, is not available for use by the UE anymore.

- 2> revert back to the configuration used in the source cell, excluding the configuration configured by the *physicalConfigDedicated*, the *mac-MainConfig* and the *sps-Config*;
- 2> initiate the connection re-establishment procedure as specified in 5.3.7, upon which the RRC connection reconfiguration procedure ends;

[TS 36.331, clause 5.3.7.2]

The UE shall only initiate the procedure when AS security has been activated. The UE initiates the procedure when one of the following conditions is met:

- 1> upon detecting radio link failure, in accordance with 5.3.11; or
- 1> upon handover failure, in accordance with 5.3.5.6; or
- 1> upon mobility from E-UTRA failure, in accordance with 5.4.3.5; or
- 1> upon integrity check failure indication from lower layers; or
- 1> upon an RRC connection reconfiguration failure, in accordance with 5.3.5.5;

Upon initiation of the procedure, the UE shall:

- 1> stop timer T310, if running;
- 1> start timer T311;
- 1> suspend all RBs except SRB0;
- 1> reset MAC;
- 1> apply the default physical channel configuration as specified in 9.2.4;
- 1> apply the default semi-persistent scheduling configuration as specified in 9.2.3;
- 1> apply the default MAC main configuration as specified in 9.2.2;
- 1> release *reportProximityConfig* and clear any associated proximity status reporting timer;
- 1> perform cell selection in accordance with the cell selection process as specified in TS 36.304 [4];

[TS 36.331, clause 5.5.6.1]

E-UTRAN applies the re-establishment procedure as follows:

- when performing the connection re-establishment procedure, as specified in 5.3.7, ensure that a *measObjectId* corresponding to the target carrier frequency is configured as a result of the procedure described in this sub-clause and the subsequent connection reconfiguration procedure immediately following the re-establishment procedure;

The UE shall:

- 1> for each *measId* included in the *measIdList* within *VarMeasConfig*:
 - 2> if the *triggerType* is set to 'periodical':
 - 3> remove this *measId* from the *measIdList* within *VarMeasConfig*:
- 1> if the procedure was triggered due to inter-frequency handover or successful re-establishment to an inter-frequency cell, update the *measId* values in the *measIdList* within *VarMeasConfig* as follows:
 - 2> if a *measObjectId* value corresponding to the target carrier frequency exists in the *measObjectList* within *VarMeasConfig*:
 - 3> for each *measId* value in the *measIdList*:
 - 4> if the *measId* value is linked to the *measObjectId* value corresponding to the source carrier frequency:
 - 5> link this *measId* value to the *measObjectId* value corresponding to the target carrier frequency;
 - 4> else if the *measId* value is linked to the *measObjectId* value corresponding to the target carrier frequency:
 - 5> link this *measId* value to the *measObjectId* value corresponding to the source carrier frequency;
 - 2> else:
 - 3> remove all *measId* values that are linked to the *measObjectId* value corresponding to the source carrier frequency;
 - 1> remove all measurement reporting entries within *VarMeasReportList*;
 - 1> stop the periodical reporting timer or timer T321, whichever one is running, as well as associated information (e.g. *timeToTrigger*) for all *measId*;
 - 1> release the measurement gaps, if activated;

NOTE: If the UE requires measurement gaps to perform inter-frequency or inter-RAT measurements, the UE resumes the inter-frequency and inter-RAT measurements after the E-UTRAN has setup the measurement gaps.

8.3.1.16.3 Test description

8.3.1.16.3.1 Pre-test conditions

System Simulator:

- Cell 1, Cell 2 and Cell 10.
- System information combination 3 as defined in TS 36.508 [18] clause 4.4.3.1 is used in E-UTRA cells.

UE:

None.

Preamble:

- The UE is in state Generic RB Established (state 3) on Cell 1 according to [18].

8.3.1.16.3.2 Test procedure sequence

Table 8.3.1.16.3.2-1 illustrates the downlink power levels and other changing parameters to be applied for the cells at various time instants of the test execution. Row marked "T0" denotes the initial conditions after preamble, while columns marked "T1", "T2", "T3", and "T4" are to be applied subsequently. The exact instants on which these values shall be applied are described in the texts in this clause.

Table 8.3.1.16.3.2-1: Time instances of cell power levels

	Parameter	Unit	Cell 1	Cell 2	Cell 10 (DL only)	Remark
T0	Cell-specific RS EPRE	dBm/15 kHz	-85	"Off"	"Off"	(NOTE 1)
T1	Cell-specific RS EPRE	dBm/15 kHz	-85	"Off"	-73	The power level values are such that measurement results for Cell 1 (M1) and Cell 10 (M10) satisfy entry condition for event A3 ($M10 > M1$). (NOTE 1)
T2	Cell-specific RS EPRE	dBm/15 kHz	-85	-79	"Off"	The power level values are such that measurement results for Cell 1 (M1) and Cell 2 (M2) satisfy entry condition for event A3 ($M2 > M1$). (NOTE 1)
T3	Cell-specific RS EPRE	dBm/15 kHz	"Off"	-79	"Off"	The power level values are such that $SrxlevCell\ 1 < 0$ and $SrxlevCell\ 10 < 0$ are satisfied. (NOTE 1)
T4	Cell-specific RS EPRE	dBm/15 kHz	"Off"	-85	-73	The power level values are such that measurement results for Cell 2 (M2) and Cell 10 (M10) satisfy entry condition for event A3 ($M10 > M2$). (NOTE 1)
NOTE 1: Power level "Off" is defined in TS 36.508 Table 6.2.2.1-1.						

Table 8.3.1.16.3.2-2: Main behaviour

St	Procedure	Message Sequence		TP	Verdict
		U - S	Message		
1	The SS transmits an <i>RRConnectionReconfiguration</i> message to setup intra-frequency and inter-band measurements on Cell 1.	<--	<i>RRConnectionReconfiguration</i>	-	-
2	The UE transmits an <i>RRConnectionReconfigurationComplete</i> message to confirm the setup of intra-frequency and inter-band measurements on Cell 1.	-->	<i>RRConnectionReconfigurationComplete</i>	-	-
3	The SS changes Cell 10 power level according to the row "T1" in Table 8.3.1.16.3.2-1.	-	-	-	-
4	The UE transmits a <i>MeasurementReport</i> message on Cell 1 to report event A3 for Cell 10.	-->	<i>MeasurementReport</i>	-	-
5	The SS changes Cell 2 and Cell 10 power levels according to the row "T2" in Table 8.3.1.16.3.2-1.	-	-	-	-
6	The UE transmits a <i>MeasurementReport</i> message on Cell 1 to perform event A3 intra-frequency reporting for Cell 2.	-->	<i>MeasurementReport</i>	-	-
7	The SS transmits an <i>RRConnectionReconfiguration</i> message including a <i>mobilityControlInfo</i> , to order the UE to perform intra-frequency handover to Cell 2.	<--	<i>RRConnectionReconfiguration</i>	-	-
-	EXCEPTION: In parallel to the events described in step 8 the steps specified in Table 8.3.1.16.3.2-3 should take place.	-	-	-	-
8	The SS changes Cell 1 power level according to the row "T3" in Table 8.3.1.16.3.2-1.	-	-	-	-
9	Check: Does the UE transmit an <i>RRConnectionReestablishmentRequest</i> message on Cell 2?	-->	<i>RRConnectionReestablishmentRequest</i>	1	P
10	The SS transmits an <i>RRConnectionReestablishment</i> message to resume SRB1 operation and re-activate security on Cell 2.	<--	<i>RRConnectionReestablishment</i>	-	-
11	The UE transmits an <i>RRConnectionReestablishmentComplete</i> message on Cell 2.	-->	<i>RRConnectionReestablishmentComplete</i>	-	-
12	The SS transmits an <i>RRConnectionReconfiguration</i> message to resume existing radio bearer on Cell 2.	<--	<i>RRConnectionReconfiguration</i>	-	-
13	The UE transmits an <i>RRConnectionReconfigurationComplete</i> message on Cell 2.	-->	<i>RRConnectionReconfigurationComplete</i>	-	-
14	The SS transmits an <i>RRConnectionReconfiguration</i> message to activate the measurement gaps on Cell 2.	<--	<i>RRConnectionReconfiguration</i>	-	-
15	The UE transmits an <i>RRConnectionReconfigurationComplete</i> message to confirm the activation of the measurement gaps on Cell 2.	-->	<i>RRConnectionReconfigurationComplete</i>	-	-
16	The SS changes Cell 2 and Cell 10 power levels according to the row "T4" in Table 8.3.1.16.3.2-1.	-	-	-	-
17	Check: Does the UE transmit a <i>MeasurementReport</i> message on Cell 2 to report event A3 for Cell 10?	-->	<i>MeasurementReport</i>	1	P
18	Check: Does the test result of CALL generic test procedure in 36.508 subclause 6.2.4.3 indicate that the UE is in E-UTRA RRC_CONNECTED state on Cell 2?	-	-	1	-

Table 8.3.1.16.3.2-3: Parallel behaviour

St	Procedure	Message Sequence		TP	Verdict
		U - S	Message		
-	EXCEPTION: The steps 1 and 2 below are repeated for the duration of T304.	-	-	-	-
1	The UE attempts to perform the intra-frequency handover using MAC Random Access Preamble on Cell 2.	-	-	-	-
2	The SS does not respond.	-	-	-	-

8.3.1.16.3.3 Specific message contents

Table 8.3.1.16.3.3-1: SystemInformationBlockType2 for Cell 2 (preamble and all steps, Table 8.3.1.16.3.2-2)

Derivation Path: 36.508, Table 4.4.3.3-1			
Information Element	Value/remark	Comment	Condition
SystemInformationBlockType2 ::= SEQUENCE {			
radioResourceConfigCommon SEQUENCE {			
rach-ConfigCommon SEQUENCE {			
ra-SupervisionInfo SEQUENCE {			
preambleTransMax	n50		
}			
}			
}			
lateNonCriticalExtension	Not present		
ssac-BarringForMMTEL-Voice-r9	Not present		
ssac-BarringForMMTEL-Video-r9	Not present		
}			

Table 8.3.1.16.3.3-2: RRCConnectionReconfiguration (step 1, Table 8.3.1.16.3.2-2)

Derivation Path: 36.508, Table 4.6.1-8, condition MEAS

Table 8.3.1.16.3.3-3: *MeasConfig* (Table 8.3.1.16.3.3-2)

Derivation Path: 36.508, Table 4.6.6-1, condition INTER-FREQ			
Information Element	Value/remark	Comment	Condition
MeasConfig ::= SEQUENCE {			
measObjectToAddModList SEQUENCE (SIZE (1..maxObjectId)) OF SEQUENCE {	2 entries		
measObjectId[1]	IdMeasObject-f1		
measObject[1]	MeasObjectEUTRA-GENERIC(f1)		
measObjectId[2]	IdMeasObject-f5		
measObject[2]	MeasObjectEUTRA-GENERIC(f5)		
}			
reportConfigToAddModList SEQUENCE (SIZE (1..maxReportConfigId)) OF SEQUENCE {	1 entry		
reportConfigId[1]	IdReportConfig-A3		
reportConfig[1]	ReportConfigEUTRA-A3		
}			
measIdToAddModList SEQUENCE (SIZE (1..maxMeasId)) OF SEQUENCE {	2 entries		
measId[1]	1		
measObjectId[1]	IdMeasObject-f1		
reportConfigId[1]	IdReportConfig-A3		
measId[2]	2		
measObjectId[2]	IdMeasObject-f5		
reportConfigId[2]	IdReportConfig-A3		
}			
}			

Table 8.3.1.16.3.3-4: *MeasurementReport* (step 4 and 17, Table 8.3.1.16.3.2-2)

Derivation Path: 36.508, Table 4.6.1-5			
Information Element	Value/remark	Comment	Condition
MeasurementReport ::= SEQUENCE {			
criticalExtensions CHOICE {			
c1 CHOICE{			
measurementReport-r8 SEQUENCE {			
measResults SEQUENCE {			
measId	2		
measResultServCell SEQUENCE {			
rsrpResult	(0..97)		
rsrqResult	(0..34)		
}			
measResultNeighCells CHOICE {			
measResultListEUTRA SEQUENCE (SIZE (1..maxCellReport)) OF SEQUENCE {	1 entry		
physCellId	PhysicalCellIdentity of Cell 10		
cgi-Info	Not present		
measResult SEQUENCE {			
rsrpResult	(0..97)		
rsrqResult	(0..34)		
additionalSI-Info-r9	Not present		
}			
}			
}			
measResultForECID-r9	Not present		
}			
}			

Table 8.3.1.16.3.3-5: MeasurementReport (step 6, Table 8.3.1.16.3.2-2)

Derivation Path: 36.508, Table 4.6.1-5			
Information Element	Value/remark	Comment	Condition
MeasurementReport ::= SEQUENCE {			
criticalExtensions CHOICE {			
c1 CHOICE{			
measurementReport-r8 SEQUENCE {			
measResults SEQUENCE {			
measId	1		
measResultServCell SEQUENCE {			
rsrpResult	(0..97)		
rsrqResult	(0..34)		
}			
measResultNeighCells CHOICE {			
measResultListEUTRA SEQUENCE (SIZE (1..maxCellReport)) OF SEQUENCE {	1 entry		
physCellId	PhysicalCellIdentity of Cell 2		
cgi-Info	Not present		
measResult SEQUENCE {			
rsrpResult	(0..97)		
rsrqResult	(0..34)		
additionalSI-Info-r9	Not present		
}			
}			
}			
measResultForECID-r9	Not present		
}			
}			
}			

Table 8.3.1.16.3.3-6: RRCConnectionReconfiguration (step 7, Table 8.3.1.16.3.2-2)

Derivation Path: 36.508, Table 4.6.1-8, condition HO
--

Table 8.3.1.16.3.3-7: MobilityControlInfo (Table 8.3.1.16.3.3-6)

Derivation Path: 36.508, Table 4.6.5-1			
Information Element	Value/remark	Comment	Condition
MobilityControlInfo ::= SEQUENCE {			
targetPhysCellId	PhysicalCellIdentity of Cell 2		
carrierFreq	Not present		
}			

Table 8.3.1.16.3.3-8: RRCConnectionReestablishmentRequest (step 9, Table 8.3.1.16.3.2-2)

Derivation Path: 36.508, Table 4.6.1-13			
Information Element	Value/remark	Comment	Condition
RRCConnectionReestablishmentRequest ::= SEQUENCE {			
criticalExtensions CHOICE {			
rrcConnectionReestablishmentRequest-r8			
SEQUENCE {			
ue-Identity SEQUENCE {			
c-RNTI	the value of the C-RNTI of the UE		
physCellId	PhysicalCellIdentity of Cell 1		
shortMAC-I	The same value as the 16 least significant bits of the XMAC-I value calculated by SS		
}			
reestablishmentCause	handoverFailure		
}			
}			
}			

Table 8.3.1.16.3.3-9: RRCConnectionReestablishmentComplete (step 11, Table 8.3.1.16.3.2-2)

Derivation Path: 36.508, Table 4.6.1-11			
Information Element	Value/remark	Comment	Condition
RRCConnectionReestablishmentComplete ::= SEQUENCE {			
criticalExtensions CHOICE {			
rrcConnectionReestablishmentComplete-r8 =			
SEQUENCE {			
nonCriticalExtension SEQUENCE {}	Not present		
}			
}			
}			

Table 8.3.1.16.3.3-10: RRCConnectionReconfiguration (step 12, Table 8.3.1.16.3.2-2)

Derivation Path: 36.508, Table 4.6.1-8			
Information Element	Value/remark	Comment	Condition
RRCConnectionReconfiguration ::= SEQUENCE {			
criticalExtensions CHOICE {			
c1 CHOICE{			
rrcConnectionReconfiguration-r8 SEQUENCE {			
radioResourceConfigDedicated	RadioResourceConfigDedicated-HO		
}			
}			
}			
}			

Table 8.3.1.16.3.3-11: RRCConnectionReconfiguration (step 14, Table 8.3.1.16.3.2-2)

Derivation Path: 36.508, Table 4.6.1-8 condition MEAS

Table 8.3.1.16.3.3-12: MeasConfig (Table 8.3.1.16.3.3-11)

Derivation Path: 36.508, Table 4.6.6-1, condition INTER-FREQ
--

8.3.1.16a Measurement configuration control and reporting / Intra E-UTRAN measurements / Continuation of the measurements after RRC connection re-establishment / Inter-band / Between FDD and TDD

8.3.1.16a.1 Test Purpose (TP)

(1)

```
with { UE in E-UTRA FDD RRC_CONNECTED state and having completed the radio bearer establishment,
initial security activation procedure and performed the intra frequency measurement and after
receiving an RRCConnectionReconfiguration message including a mobilityControlInfo indicating a
different E-UTRA TDD cell having attempted inter- mode handover }
ensure that {
  when { UE detects handover failure and the inter-band E-UTRA TDD cell is selectable }
then { UE performs RRC Connection Re-establishment, continues the intra frequency measurement }
}
```

(2)

```
with { UE in E-UTRA FDD RRC_CONNECTED state and having completed the radio bearer establishment,
initial security activation procedure and performed the inter-band measurement and after receiving
an RRCConnectionReconfiguration message including a mobilityControlInfo indicating a different E-
UTRA TDD cell having attempted inter- mode handover}
ensure that {
  when { UE detects handover failure and the inter-band E-UTRA TDD cell is selectable }
then {UE performs RRC Connection Re-establishment, continues the inter-band measurement after the
activation of the measurement gaps }
}
```

(3)

```
with { UE in E-UTRA TDD RRC_CONNECTED state and having completed the radio bearer establishment,
initial security activation procedure and performed the intra frequency measurement and after
receiving an RRCConnectionReconfiguration message including a mobilityControlInfo indicating a
different E-UTRA FDD cell having attempted inter- mode handover }
ensure that {
  when { UE detects handover failure and the inter-band E-UTRA FDD cell is selectable }
then { UE performs RRC Connection Re-establishment, continues the intra frequency measurement }
}
```

(4)

```
with { UE in E-UTRA TDD RRC_CONNECTED state and having completed the radio bearer establishment,
initial security activation procedure and performed the inter-band measurement and after receiving
an RRCConnectionReconfiguration message including a mobilityControlInfo indicating a different E-
UTRA FDD cell having attempted inter- mode handover}
ensure that {
  when { UE detects handover failure and the inter-band E-UTRA FDD cell is selectable }
then {UE performs RRC Connection Re-establishment, continues the inter-band measurement after the
activation of the measurement gaps }
}
```

8.3.1.16a.2 Conformance requirements

References: The conformance requirements covered in the present TC are specified in: TS 36.331, clause 5.3.5.4, 5.3.5.6, 5.3.7.2 and 5.5.6.1.

[TS 36.331, clause 5.3.5.4]

If the *RRCConnectionReconfiguration* message includes the *mobilityControlInfo* and the UE is able to comply with the configuration included in this message, the UE shall:

- 1> stop timer T310, if running;
- 1> start timer T304 with the timer value set to *t304*, as included in the *mobilityControlInfo*;
- 1> if the *carrierFreq* is included:
 - 2> consider the target cell to be one on the frequency indicated by the *carrierFreq* with a physical cell identity indicated by the *targetPhysCellId*;

1> else:

2> consider the target cell to be one on the current frequency with a physical cell identity indicated by the *targetPhysCellId*;

1> start synchronising to the DL of the target cell;

NOTE 1: The UE should perform the handover as soon as possible following the reception of the RRC message triggering the handover, which could be before confirming successful reception (HARQ and ARQ) of this message.

1> reset MAC;

1> re-establish PDCP for all RBs that are established;

NOTE 2: The handling of the radio bearers after the successful completion of the PDCP re-establishment, e.g. the re-transmission of unacknowledged PDCP SDUs (as well as the associated status reporting), the handling of the SN and the HFN, is specified in TS 36.323 [8].

1> re-establish RLC for all RBs that are established;

1> apply the value of the *newUE-Identity* as the C-RNTI;

1> configure lower layers in accordance with the received *radioResourceConfigCommon*;

1> if the *RRCConnectionReconfiguration* message includes the *radioResourceConfigDedicated*:

2> perform the radio resource configuration procedure as specified in 5.3.10;

...

1> if the *RRCConnectionReconfiguration* message includes the *measConfig*:

2> perform the measurement configuration procedure as specified in 5.5.2;

1> submit the *RRCConnectionReconfigurationComplete* message to lower layers for transmission;

1> if MAC successfully completes the random access procedure:

2> stop timer T304;

2> apply the parts of the configuration that do not require the UE to know the SFN of the target cell;

2> apply the parts of the measurement and the radio resource configuration that require the UE to know the SFN of the target cell (e.g. measurement gaps, periodic CQI reporting, scheduling request configuration, sounding RS configuration), if any, upon acquiring the SFN of the target cell;

2> the procedure ends;

NOTE 3: The UE is not required to determine the SFN of the target cell by acquiring system information from that cell before performing RACH access in the target cell.

[TS 36.331, clause 5.3.5.6]

The UE shall:

1> if T304 expires (handover failure):

NOTE: Following T304 expiry any dedicated preamble, if provided within the *rach-ConfigDedicated*, is not available for use by the UE anymore.

2> revert back to the configuration used in the source cell, excluding the configuration configured by the *physicalConfigDedicated*, the *mac-MainConfig* and the *sps-Config*;

2> initiate the connection re-establishment procedure as specified in 5.3.7, upon which the RRC connection reconfiguration procedure ends;

[TS 36.331, clause 5.3.7.2]

The UE shall only initiate the procedure when AS security has been activated. The UE initiates the procedure when one of the following conditions is met:

- 1> upon detecting radio link failure, in accordance with 5.3.11; or
- 1> upon handover failure, in accordance with 5.3.5.6; or
- 1> upon mobility from E-UTRA failure, in accordance with 5.4.3.5; or
- 1> upon integrity check failure indication from lower layers; or
- 1> upon an RRC connection reconfiguration failure, in accordance with 5.3.5.5;

Upon initiation of the procedure, the UE shall:

- 1> stop timer T310, if running;
- 1> start timer T311;
- 1> suspend all RBs except SRB0;
- 1> reset MAC;
- 1> apply the default physical channel configuration as specified in 9.2.4;
- 1> apply the default semi-persistent scheduling configuration as specified in 9.2.3;
- 1> apply the default MAC main configuration as specified in 9.2.2;
- 1> perform cell selection in accordance with the cell selection process as specified in TS 36.304 [4];

[TS 36.331, clause 5.5.6.1]

E-UTRAN applies the re-establishment procedure as follows:

- when performing the connection re-establishment procedure, as specified in 5.3.7, ensure that a *measObjectId* corresponding to the target carrier frequency is configured as a result of the procedure described in this sub-clause and the subsequent connection reconfiguration procedure immediately following the re-establishment procedure;

The UE shall:

- 1> for each *measId* included in the *measIdList* within *VarMeasConfig*:
 - 2> if the *triggerType* is set to 'periodical':
 - 3> remove this *measId* from the *measIdList* within *VarMeasConfig*;
 - 1> if the procedure was triggered due to inter-frequency handover or successful re-establishment to an inter-frequency cell, update the *measId* values in the *measIdList* within *VarMeasConfig* as follows:
 - 2> if a *measObjectId* value corresponding to the target carrier frequency exists in the *measObjectList* within *VarMeasConfig*:
 - 3> for each *measId* value in the *measIdList*:
 - 4> if the *measId* value is linked to the *measObjectId* value corresponding to the source carrier frequency:
 - 5> link this *measId* value to the *measObjectId* value corresponding to the target carrier frequency;
 - 4> else if the *measId* value is linked to the *measObjectId* value corresponding to the target carrier frequency:
 - 5> link this *measId* value to the *measObjectId* value corresponding to the source carrier frequency;
 - 2> else:

3> remove all *measId* values that are linked to the *measObjectId* value corresponding to the source carrier frequency;

1> remove all measurement reporting entries within *VarMeasReportList*;

1> reset the periodical reporting timer or timer T321, whichever one is running, as well as associated information (e.g. *timeToTrigger*) for all *measId*;

1> release the measurement gaps, if activated;

NOTE: If the UE requires measurement gaps to perform inter-frequency or inter-RAT measurements, the UE resumes the inter-frequency and inter-RAT measurements after the E-UTRAN has setup the measurement gaps.

8.3.1.16a.3 Test description

8.3.1.16a.3.1 Pre-test conditions

System Simulator:

- Cell 1 and Cell 2 are E-UTRA FDD cells, Cell 10 and Cell 30 are E-UTRA TDD cells.
- Each cell has only a single PLMN identity. The PLMNs are identified in the test by the identifiers in Table 8.3.1.16 a.3.1-1.

Table 8.3.1.16 a.3.1-1: PLMN identifiers

Cell	PLMN name
1	PLMN1
2	PLMN1
10	PLMN1
30	PLMN2

- System information combination 3 as defined in TS 36.508 [18] clause 4.4.3.1 and Table 6.3.1.2-2 is used in E-UTRA cells.

UE:

None.

Preamble:

- The UE is registered on PLMN1 (Cell 1) using the procedure described in TS 36.508[18] clause 4.5.2.3 except that the ATTACH ACCEPT message indicates PLMN2 in the Equivalent PLMN list as described in Table 8.3.1.16a.3.3-19.
- The UE is in state Generic RB Established (state 3) on Cell 1 according to [18].

8.3.1.16a.3.2 Test procedure sequence

Table 8.3.1.16a.3.2-1 illustrates the downlink power levels and other changing parameters to be applied for the cells at various time instants of the test execution. Row marked "T0" denotes the initial conditions after preamble, while columns marked "T1", "T2", "T3", "T4", "T5" are to be applied subsequently. The exact instants on which these values shall be applied are described in the texts in this clause.

Table 8.3.1.16a.3.2-1: Time instances of cell power levels

	Parameter	Unit	Cell 1	Cell 2	Cell 10	Cell 30	Remark
T0	Cell-specific RS EPRE	dBm/15 kHz	-85	"off"	"off"	"off"	
T1	Cell-specific RS EPRE	dBm/15 kHz	-85	-79	"off"	"off"	The power level values are such that measurement results for Cell 1 (M1) and Cell 2 (M2) satisfy entry condition for event A3 (M2 - Hys > M1).
T2	Cell-specific RS EPRE	dBm/15 kHz	-85	"off"	-73	"off"	The power level values are such that measurement results for Cell 1 (M1) and Cell 10 (M10) satisfy entry condition for event A3 (M10 - Hys > M1).
T3	Cell-specific RS EPRE	dBm/15 kHz	"off"	"off"	-73	"off"	The power level values are assigned values to satisfy $SrxlevCell\ 1 < 0$ and $SrxlevCell\ 2 < 0$ such that selecting Cell 10 is guaranteed
T4	Cell-specific RS EPRE	dBm/15 kHz	"off"	"off"	-85	-79	The power level values are such that measurement results for Cell 10 (M10) and Cell 30 (M30) satisfy entry condition for event A3 (M30 - Hys > M10).
T5	Cell-specific RS EPRE	dBm/15 kHz	-73	"off"	-85	"off"	The power level values are such that measurement results for Cell 1 (M1) and Cell 10 (M10) satisfy entry condition for event A3 (M1 - Hys > M10).
T6	Cell-specific RS EPRE	dBm/15 kHz	-73	"off"	"off"	"off"	The power level values are assigned values to satisfy $SrxlevCell\ 10 < 0$ and $SrxlevCell\ 2 < 0$ such that selecting Cell 1 is guaranteed
T7	Cell-specific RS EPRE	dBm/15 kHz	-85	-79	"off"	"off"	The power level values are such that measurement results for Cell 1 (M1) and Cell 2 (M2) satisfy entry condition for event A3 (M2 - Hys > M1).
T8	Cell-specific RS EPRE	dBm/15 kHz	-85	"off"	-73	"off"	The power level values are such that measurement results for Cell 1 (M1) and Cell 10 (M10) satisfy entry condition for event A3 (M10 - Hys > M1).

Table 8.3.1.16a.3.2-2: Main behaviour

St	Procedure	Message Sequence		TP	Verdict
		U - S	Message		
1	The SS transmits an <i>RRConnectionReconfiguration</i> message to setup intra frequency and inter-band measurements on Cell 1.	<--	<i>RRConnectionReconfiguration</i>	-	-
2	The UE transmits an <i>RRConnectionReconfigurationComplete</i> message to confirm the setup of intra frequency and inter-band measurements on Cell 1.	-->	<i>RRConnectionReconfigurationComplete</i>	-	-
3	The SS changes Cell 2 power levels according to the row "T1" in Table 8.3.1.16a.3.2-1.	-	-	-	-
4	The UE transmits a <i>MeasurementReport</i> message on Cell 1 to perform event A3 intra frequency reporting for Cell 2.	-->	<i>MeasurementReport</i>	-	-
5	The SS changes Cell 2 and Cell 10 power levels according to the row "T2" in Table 8.3.1.16a.3.2-1.	-	-	-	-
6	The UE transmits a <i>MeasurementReport</i> message on Cell 1 to perform event A3 inter-band reporting for Cell 10.	-->	<i>MeasurementReport</i>	-	-
7	The SS transmits an <i>RRConnectionReconfiguration</i> message including a <i>mobilityControlInfo</i> , to order the UE to perform inter-band handover to Cell 10.	<--	<i>RRConnectionReconfiguration</i>	-	-
-	EXCEPTION: In parallel to the events described in step 8 the steps specified in Table 8.3.1.16a.3.2-3 should take place.	-	-	-	-
8	The SS changes Cell 1 power levels according to the row "T3" in Table 8.3.1.16a.3.2-1.	-	-	-	-
9	Check: Does the UE transmit an <i>RRConnectionReestablishmentRequest</i> message on Cell 10?	-->	<i>RRConnectionReestablishmentRequest</i>	1,2	P
10	The SS transmits an <i>RRConnectionReestablishment</i> message to resume SRB1 operation and re-activate security on Cell 10.	<--	<i>RRConnectionReestablishment</i>	-	-
11	The UE transmits an <i>RRConnectionReestablishmentComplete</i> message on Cell 10.	-->	<i>RRConnectionReestablishmentComplete</i>	-	-
12	The SS transmits an <i>RRConnectionReconfiguration</i> message to resume existing radio bearer on Cell 10.	<--	<i>RRConnectionReconfiguration</i>	-	-
13	The UE transmits an <i>RRConnectionReconfigurationComplete</i> message on Cell 10.	-->	<i>RRConnectionReconfigurationComplete</i>	-	-
13A	The UE transmits a TRACKING AREA UPDATE REQUEST message on Cell 10.	-	-	-	-
13B	SS responds with a TRACKING AREA UPDATE ACCEPT message.	-	-	-	-
13C	The UE transmits a TRACKING AREA UPDATE COMPLETE message.	-	-	-	-
14	The SS changes Cell 10 and Cell 30 power levels according to the row "T4" in Table 8.3.1.16a.3.2-1.	-	-	-	-
15	Check: Does the UE transmit a <i>MeasurementReport</i> message on Cell 10 to perform event A3 intra frequency reporting for Cell 30?	-->	<i>MeasurementReport</i>	1	P
16	The SS transmits an <i>RRConnectionReconfiguration</i> message to activate the measurement gaps on Cell 10.	<--	<i>RRConnectionReconfiguration</i>	-	-
17	The UE transmits an <i>RRConnectionReconfigurationComplete</i>	-->	<i>RRConnectionReconfigurationComplete</i>	-	-

	message to confirm the activation of the measurement gaps on Cell 10.				
18	The SS changes Cell 1 and Cell 30 power levels according to the row "T5" in Table 8.3.1.16a.3.2-1.	-	-	-	-
19	Check: Does the UE transmit a <i>MeasurementReport</i> message on Cell 10 to perform event A3 inter-band reporting for Cell 1?	-->	<i>MeasurementReport</i>	2	P
20	The SS transmits an <i>RRCCONNECTIONRECONFIGURATION</i> message including a <i>mobilityControlInfo</i> , to order the UE to perform inter-band handover to Cell 1.	<--	<i>RRCCONNECTIONRECONFIGURATION</i>	-	-
-	EXCEPTION: In parallel to the events described in step 21 the steps specified in Table 8.3.1.16a.3.2-4 should take place.	-	-	-	-
21	The SS changes Cell 1 power levels according to the row "T6" in Table 8.3.1.16a.3.2-1.	-	-	-	-
22	Check: Does the UE transmit an <i>RRCCONNECTIONREESTABLISHMENTREQUEST</i> message on Cell 1?	-->	<i>RRCCONNECTIONREESTABLISHMENTREQUEST</i>	3,4	P
23	The SS transmits an <i>RRCCONNECTIONREESTABLISHMENT</i> message to resume SRB1 operation and re-activate security on Cell 1.	<--	<i>RRCCONNECTIONREESTABLISHMENT</i>	-	-
24	The UE transmits an <i>RRCCONNECTIONREESTABLISHMENTCOMPLETE</i> message on Cell 1.	-->	<i>RRCCONNECTIONREESTABLISHMENTCOMPLETE</i>	-	-
25	The SS transmits an <i>RRCCONNECTIONRECONFIGURATION</i> message to resume existing radio bearer on Cell 1.	<--	<i>RRCCONNECTIONRECONFIGURATION</i>	-	-
26	The UE transmits an <i>RRCCONNECTIONRECONFIGURATIONCOMPLETE</i> message on Cell 1.	-->	<i>RRCCONNECTIONRECONFIGURATIONCOMPLETE</i>	-	-
26A	The UE transmits a TRACKING AREA UPDATE REQUEST message on Cell 1.	-	-	-	-
26B	SS responds with a TRACKING AREA UPDATE ACCEPT message.	-	-	-	-
26C	The UE transmits a TRACKING AREA UPDATE COMPLETE message.	-	-	-	-
27	The SS changes Cell 1 and Cell 2 power levels according to the row "T7" in Table 8.3.1.16a.3.2-1.	-	-	-	-
28	Check: Does the UE transmit a <i>MeasurementReport</i> message on Cell 1 to perform event A3 intra frequency reporting for Cell 2?	-->	<i>MeasurementReport</i>	3	P
29	The SS transmits an <i>RRCCONNECTIONRECONFIGURATION</i> message to activate the measurement gaps on Cell 1.	<--	<i>RRCCONNECTIONRECONFIGURATION</i>	-	-
30	The UE transmits an <i>RRCCONNECTIONRECONFIGURATIONCOMPLETE</i> message to confirm the activation of the measurement gaps on Cell 1.	-->	<i>RRCCONNECTIONRECONFIGURATIONCOMPLETE</i>	-	-
31	The SS changes Cell 2 and Cell 10 power levels according to the row "T8" in Table 8.3.1.16a.3.2-1.	-	-	-	-
32	Check: Does the UE transmit a <i>MeasurementReport</i> message on Cell 1 to perform event A3 inter-band reporting for Cell 10?	-->	<i>MeasurementReport</i>	4	P
33	Check: Does the test result of CALL generic test procedure in 36.508 subclause 6.2.4.3 indicate that the UE is in E-UTRA RRC_CONNECTED state on Cell 1?	-	-	3,4	-

Table 8.3.1.16a.3.2-3: Parallel behaviour

St	Procedure	Message Sequence		TP	Verdict
		U - S	Message		
-	EXCEPTION: The steps 1 and 2 below are repeated for the duration of T304.	-	-	-	-
1	The UE attempts to perform the inter-band handover using MAC Random Access Preamble on Cell 10.	-	-	-	-
2	The SS does not respond.	-	-	-	-

Table 8.3.1.16a.3.2-4: Parallel behaviour

St	Procedure	Message Sequence		TP	Verdict
		U - S	Message		
-	EXCEPTION: The steps 1 and 2 below are repeated for the duration of T304.	-	-	-	-
1	The UE attempts to perform the inter-band handover using MAC Random Access Preamble on Cell 1.	-	-	-	-
2	The SS does not respond.	-	-	-	-

8.3.1.16.3.3 Specific message contents

Table 8.3.1.16a.3.3-1: SystemInformationBlockType2 for Cell 1, Cell 2, Cell 10 and Cell 30 (preamble and all the steps in Table 8.3.1.16a.3.2-2)

Derivation Path: 36.508, Table 4.6.3-12			
Information Element	Value/remark	Comment	Condition
ra-SupervisionInfo SEQUENCE {			
preambleTransMax	n50		
}			

Table 8.3.1.16a.3.3-2: RRCConnectionReconfiguration (step 1, Table 8.3.1.16a.3.2-2)

Derivation Path: 36.508, Table 4.6.1-8, condition MEAS
--

Table 8.3.1.16a.3.3-3: MeasConfig (step 1, Table 8.3.1.16a.3.3-2)

Derivation Path: 36.508, Table 4.6.6-1, condition INTER-FREQ			
Information Element	Value/remark	Comment	Condition
MeasConfig ::= SEQUENCE {			
measObjectToAddModList SEQUENCE (SIZE (1..maxObjectId)) OF SEQUENCE {	2 entries		
measObjectId[1]	IdMeasObject-f1		
measObject[1]	MeasObjectEUTRA-GENERIC(f1)		
measObjectId[2]	IdMeasObject-f5		
measObject[2]	MeasObjectEUTRA-GENERIC(f5)		
}			
reportConfigToAddModList SEQUENCE (SIZE (1..maxReportConfigId)) OF SEQUENCE {	1 entry		
reportConfigId[1]	IdReportConfig-A3		
reportConfig[1]	ReportConfigEUTRA-A3		
}			
measIdToAddModList SEQUENCE (SIZE (1..maxMeasId)) OF SEQUENCE {	2 entries		
measId[1]	1		
measObjectId[1]	IdMeasObject-f1		
reportConfigId[1]	IdReportConfig-A3		
measId[2]	2		
measObjectId[2]	IdMeasObject-f5		
reportConfigId[2]	IdReportConfig-A3		
}			
}			

Table 8.3.1.16a.3.3-4: MeasurementReport (step 4, Table 8.3.1.16a.3.2-2)

Derivation Path: 36.508, Table 4.6.1-5			
Information Element	Value/remark	Comment	Condition
MeasurementReport ::= SEQUENCE {			
criticalExtensions CHOICE {			
c1 CHOICE{			
measurementReport-r8 SEQUENCE {			
measResults SEQUENCE {			
measId	1		
measResultServCell SEQUENCE {		Cell 1	
rsrpResult	(0..97)		
rsrqResult	(0..34)		
}			
measResultNeighCells CHOICE {			
measResultListEUTRA SEQUENCE (SIZE (1..maxCellReport)) OF SEQUENCE {	1 entry		
physCellId[1]	PhysicalCellId of Cell 2		
cgi-Info[1]	Not present		
measResult[1] SEQUENCE {			
rsrpResult	(0..97)		
rsrqResult	(0..34)		
}			
}			
}			
}			
}			

Table 8.3.1.16a.3.3-5: MeasurementReport (step 6, Table 8.3.1.16a.3.2-2)

Derivation Path: 36.508, Table 4.6.1-5			
Information Element	Value/remark	Comment	Condition
MeasurementReport ::= SEQUENCE {			
criticalExtensions CHOICE {			
c1 CHOICE{			
measurementReport-r8 SEQUENCE {			
measResults SEQUENCE {			
measId	2		
measResultServCell SEQUENCE {		Cell 1	
rsrpResult	(0..97)		
rsrqResult	(0..34)		
}			
measResultNeighCells CHOICE {			
measResultListEUTRA SEQUENCE (SIZE (1..maxCellReport)) OF SEQUENCE {	1 entry		
physCellId[1]	PhysicalCellIdentity of Cell 10		
cgi-Info[1]	Not present		
measResult[1] SEQUENCE {			
rsrpResult	(0..97)		
rsrqResult	(0..34)		
}			
}			
}			
}			
}			
}			
}			

Table 8.3.1.16a.3.3-6: RRCConnectionReconfiguration (step 7 and step 20, Table 8.3.1.16a.3.2-2)

Derivation Path: 36.508, Table 4.6.1-8, condition HO
--

Table 8.3.1.16a.3.3-7: MobilityControlInfo (step 7, Table 8.3.1.16a.3.3-6)

Derivation Path: 36.508, Table 4.6.5-1			
Information Element	Value/remark	Comment	Condition
MobilityControlInfo ::= SEQUENCE {			
targetPhysCellId	PhysicalCellIdentity of Cell 10		
carrierFreq SEQUENCE {			
dl-CarrierFreq	Same DL EARFCN as used for Cell 10		
ul-CarrierFreq	Not present		
}			
}			

Table 8.3.1.16a.3.3-8: RRCConnectionReestablishmentRequest (step 9, Table 8.3.1.16a.3.2-2)

Derivation Path: 36.508, Table 4.6.1-13			
Information Element	Value/remark	Comment	Condition
RRCConnectionReestablishmentRequest ::= SEQUENCE {			
criticalExtensions CHOICE {			
rrcConnectionReestablishmentRequest-r8			
SEQUENCE {			
ue-Identity SEQUENCE {			
c-RNTI	the value of the C-RNTI of the UE		
physCellId	PhysicalCellIdentity of Cell 1		
shortMAC-I	The same value as the 16 least significant bits of the XMAC-I value calculated by SS.		
}			
reestablishmentCause	handoverFailure		
}			
}			
}			

Table 8.3.1.16a.3.3-9: RRCConnectionReestablishment (step 10 and step 23, Table 8.3.1.16a.3.2-2)

Derivation Path: 36.508, Table 4.6.1-10			
Information Element	Value/remark	Comment	Condition
RRCConnectionReestablishment ::= SEQUENCE {			
criticalExtensions CHOICE {			
c1 CHOICE{			
rrcConnectionReestablishment-r8 SEQUENCE {			
nextHopChainingCount	0		
}			
}			
}			
}			

Table 8.3.1.16a.3.3-9A: RRCConnectionReestablishmentComplete (step 11 and step 24, Table 8.3.1.16a.3.2-2)

Derivation Path: 36.508, Table 4.6.1-11			
Information Element	Value/remark	Comment	Condition
RRCConnectionReestablishmentComplete ::= SEQUENCE {			
criticalExtensions CHOICE {			
rrcConnectionReestablishmentComplete-r8 = SEQUENCE {			
nonCriticalExtension SEQUENCE {	Not present		
}			
}			
}			
}			

Table 8.3.1.16a.3.3-10: RRCConnectionReconfiguration (step 12 and step 25, Table 8.3.1.16a.3.2-2)

Derivation Path: 36.508, Table 4.6.1-8			
Information Element	Value/remark	Comment	Condition
RRCConnectionReconfiguration ::= SEQUENCE {			
criticalExtensions CHOICE {			
c1 CHOICE{			
rrcConnectionReconfiguration-r8 SEQUENCE {			
radioResourceConfigDedicated	RadioResourceConfigDe dicated-HO		
}			
}			
}			
}			

Table 8.3.1.16a.3.3-11: MeasurementReport (step 15, Table 8.3.1.16a.3.2-2)

Derivation Path: 36.508, Table 4.6.1-5			
Information Element	Value/remark	Comment	Condition
MeasurementReport ::= SEQUENCE {			
criticalExtensions CHOICE {			
c1 CHOICE{			
measurementReport-r8 SEQUENCE {			
measResults SEQUENCE {			
measId	1		
measResultServCell SEQUENCE {		Cell 10	
rsrpResult	(0..97)		
rsrqResult	(0..34)		
}			
measResultNeighCells CHOICE {			
measResultListEUTRA SEQUENCE (SIZE (1..maxCellReport)) OF SEQUENCE {	1 entry		
physCellId[1]	PhysicalCellIdentity of Cell 30		
cgi-Info[1]	Not present		
measResult[1] SEQUENCE {			
rsrpResult	(0..97)		
rsrqResult	(0..34)		
}			
}			
}			
}			
}			
}			
}			

Table 8.3.1.16a.3.3-12: RRCConnectionReconfiguration (step 16 and step 29, Table 8.3.1.16a.3.2-2)

Derivation Path: 36.508, Table 4.6.1-8 condition MEAS

Table 8.3.1.16a.3.3-13: MeasConfig (step 16 and step 29, Table 8.3.1.16a.3.2-12)

Derivation Path: 36.508, Table 4.6.6-1, condition INTER-FREQ
--

Table 8.3.1.16a.3.3-14: MeasurementReport (step 18, Table 8.3.1.16a.3.2-2)

Derivation Path: 36.508, Table 4.6.1-5			
Information Element	Value/remark	Comment	Condition
MeasurementReport ::= SEQUENCE {			
criticalExtensions CHOICE {			
c1 CHOICE{			
measurementReport-r8 SEQUENCE {			
measResults SEQUENCE {			
measId	2		
measResultServCell SEQUENCE {		Cell 10	
rsrpResult	(0..97)		
rsrqResult	(0..34)		
}			
measResultNeighCells CHOICE {			
measResultListEUTRA SEQUENCE (SIZE (1..maxCellReport)) OF SEQUENCE {	1 entry		
physCellId[1]	PhysicalCellIdentity of Cell 1		
cgi-Info[1]	Not present		
measResult[1] SEQUENCE {			
rsrpResult	(0..97)		
rsrqResult	(0..34)		
}			
}			
}			
}			
}			
}			
}			

Table 8.3.1.16a.3.3-15: MobilityControlInfo (step 20, Table 8.3.1.16a.3.3-6)

Derivation Path: 36.508, Table 4.6.5-1			
Information Element	Value/remark	Comment	Condition
MobilityControlInfo ::= SEQUENCE {			
targetPhysCellId	PhysicalCellIdentity of Cell 1		
carrierFreq SEQUENCE {			
dl-CarrierFreq	Same DL EARFCN as used for Cell 1		
ul-CarrierFreq	Same UL EARFCN as used for Cell 1		
}			
}			

Table 8.3.1.16a.3.3-16: RRCConnectionReestablishmentRequest (step 22, Table 8.3.1.16a.3.2-2)

Derivation Path: 36.508, Table 4.6.1-13			
Information Element	Value/remark	Comment	Condition
RRCConnectionReestablishmentRequest ::= SEQUENCE {			
criticalExtensions CHOICE {			
rrcConnectionReestablishmentRequest-r8 SEQUENCE {			
ue-Identity SEQUENCE {			
c-RNTI	the value of the C-RNTI of the UE		
physCellId	PhysicalCellIdentity of Cell 10		
shortMAC-I	The same value as the 16 least significant bits of the XMAC-I value calculated by SS.		
}			
reestablishmentCause	handoverFailure		
}			
}			
}			

Table 8.3.1.16a.3.3-17: MeasurementReport (step 28, Table 8.3.1.16a.3.2-2)

Derivation Path: 36.508, Table 4.6.1-5			
Information Element	Value/remark	Comment	Condition
MeasurementReport ::= SEQUENCE {			
criticalExtensions CHOICE {			
c1 CHOICE{			
measurementReport-r8 SEQUENCE {			
measResults SEQUENCE {			
measId	1		
measResultServCell SEQUENCE {		Cell 1	
rsrpResult	(0..97)		
rsrqResult	(0..34)		
}			
measResultNeighCells CHOICE {			
measResultListEUTRA SEQUENCE (SIZE (1..maxCellReport)) OF SEQUENCE {	1 entry		
physCellId[1]	PhysicalCellIdentity of Cell 2		
cgi-Info[1]	Not present		
measResult[1] SEQUENCE {			
rsrpResult	(0..97)		
rsrqResult	(0..34)		
}			
}			
}			
}			
}			
}			
}			
}			

Table 8.3.1.16a.3.3-18: *MeasurementReport* (step 32, Table 8.3.1.16a.3.2-2)

Derivation Path: 36.508, Table 4.6.1-5			
Information Element	Value/remark	Comment	Condition
MeasurementReport ::= SEQUENCE {			
criticalExtensions CHOICE {			
c1 CHOICE{			
measurementReport-r8 SEQUENCE {			
measResults SEQUENCE {			
measId	2		
measResultServCell SEQUENCE {		Cell 1	
rsrpResult	(0..97)		
rsrqResult	(0..34)		
}			
measResultNeighCells CHOICE {			
measResultListEUTRA SEQUENCE (SIZE (1..maxCellReport)) OF SEQUENCE {	1 entry		
physCellId[1]	PhysicalCellIdentity of Cell 10		
cgi-Info[1]	Not present		
measResult[1] SEQUENCE {			
rsrpResult	(0..97)		
rsrqResult	(0..34)		
}			
}			
}			
}			
}			
}			

Table 8.3.1.16a.3.3-19: ATTACH ACCEPT for Cell 1 (preamble)

Derivation path: 36.508 Table 4.7.2-1			
Information Element	Value/Remark	Comment	Condition
Equivalent PLMNs	PLMN2		

8.3.1.17 CA / Measurement configuration control and reporting / Intra E-UTRAN measurements / Event A6

8.3.1.17.1 CA / Measurement configuration control and reporting / Intra E-UTRAN measurements / Event A6 / Intra-band Contiguous CA

8.3.1.17.1.1 Test Purpose (TP)

(1)

```
with { UE in E-UTRA RRC_CONNECTED state and measurements configured for event A6 }
ensure that {
  when { Entry condition for event A6 is not met }
  then { UE does not send MeasurementReport }
}
```

(2)

```
with { UE in E-UTRA RRC_CONNECTED state and measurements configured for event A6 }
ensure that {
  when { Intra-frequency neighbour becomes offset better than SCell }
  then { UE sends MeasurementReport with correct measId for event A6 }
}
```

(3)

```
with { UE in E-UTRA RRC_CONNECTED state and measurements configured for event A6 }
ensure that {
```

```

when { UE receives a RRCConnectionReconfiguration message containing sCellToReleaseList with a
sCellIndex equal to one of the current UE SCell configuration }
  then { UE remove measId associated with event A6 and stops sending MeasurementReport message }

```

8.3.1.17.1.2 Conformance requirements

References: The conformance requirements covered in the current TC are specified in: TS 36.331, clauses 5.3.5.3 5.5.2.2a, 5.5.4.1, 5.5.4.6a and 5.5.5.

[TS 36.331, clause 5.3.5.3]

If the *RRCConnectionReconfiguration* message does not include the *mobilityControllInfo* and the UE is able to comply with the configuration included in this message, the UE shall:

...

1> if the received *RRCConnectionReconfiguration* includes the *sCellToReleaseList*:

2> perform SCell release as specified in 5.3.10.3a;

1> if the received *RRCConnectionReconfiguration* includes the *sCellToAddModList*:

2> perform SCell addition or modification as specified in 5.3.10.3b;

...

1> If the *RRCConnectionReconfiguration* message includes the *measConfig*:

2> perform the Measurement configuration procedure as specified in 5.5.2;

1> perform the measurement identity autonomous removal as specified in 5.5.2.2a;

...

[TS 36.331, clause 5.5.2.2a]

The UE shall:

1> for each *measId* included in the *measIdList* within *VarMeasConfig*:

2> if the associated *reportConfig* concerns an event involving a serving cell while the concerned serving cell is not configured:

3> remove the *measId* from the *measIdList* within the *VarMeasConfig*;

3> remove the measurement reporting entry for this *measId* from the *VarMeasReportList*, if included;

3> stop the periodical reporting timer if running, and reset the associated information (e.g. *timeToTrigger*) for this *measId*;

NOTE 1: The above UE autonomous removal of *measId*'s applies only for measurement events A1, A2 and A6.

NOTE 2: When performed during re-establishment, the UE is only configured with a primary frequency (i.e. the SCell(s) are released, if configured).

[TS 36.331, clause 5.5.4.1]

The UE shall:

1> for each *measId* included in the *measIdList* within *VarMeasConfig*:

2> if the corresponding *reportConfig* includes a purpose set to '*reportStrongestCellsForSON*':

3> consider any neighbouring cell detected on the associated frequency to be applicable;

2> else if the corresponding *reportConfig* includes a purpose set to '*reportCGI*':

3> consider any neighbouring cell detected on the associated frequency/ set of frequencies (GERAN) which has a physical cell identity matching the value of the *cellForWhichToReportCGI* included in the corresponding *measObject* within the *VarMeasConfig* to be applicable;

2> else:

3> if the corresponding *measObject* concerns E-UTRA:

4> if the *ue-RxTxTimeDiffPeriodical* is configured in the corresponding *reportConfig*:

5> consider only the PCell to be applicable;

4> else if the *eventA1* or *eventA2* is configured in the corresponding *reportConfig*:

5> consider only the serving cell to be applicable;

4> else:

5> consider any neighbouring cell detected on the associated frequency to be applicable when the concerned cell is not included in the *blackCellsToAddModList* defined within the *VarMeasConfig* for this *measId*;

5> for events involving a serving cell on one frequency and neighbours on another frequency, consider the serving cell on the other frequency as a neighbouring cell;

3> else if the corresponding *measObject* concerns UTRA or CDMA2000:

4> consider a neighbouring cell on the associated frequency to be applicable when the concerned cell is included in the *cellsToAddModList* defined within the *VarMeasConfig* for this *measId* (i.e. the cell is included in the white-list);

NOTE 0: The UE may also consider a neighbouring cell on the associated UTRA frequency to be applicable when the concerned cell is included in the *csg-allowedReportingCells* within the *VarMeasConfig* for this *measId*, if configured in the corresponding *measObjectUTRA* (i.e. the cell is included in the range of physical cell identities for which reporting is allowed).

3> else if the corresponding *measObject* concerns GERAN:

4> consider a neighbouring cell on the associated set of frequencies to be applicable when the concerned cell matches the *ncc-Permitted* defined within the *VarMeasConfig* for this *measId*;

2> if the *triggerType* is set to 'event' and if the entry condition applicable for this event, i.e. the event corresponding with the *eventId* of the corresponding *reportConfig* within *VarMeasConfig*, is fulfilled for one or more applicable cells for all measurements after layer 3 filtering taken during *timeToTrigger* defined for this event within the *VarMeasConfig*, while the *VarMeasReportList* does not include an measurement reporting entry for this *measId* (a first cell triggers the event):

3> include a measurement reporting entry within the *VarMeasReportList* for this *measId*;

3> set the *numberOfReportsSent* defined within the *VarMeasReportList* for this *measId* to 0;

3> include the concerned cell(s) in the *cellsTriggeredList* defined within the *VarMeasReportList* for this *measId*;

3> initiate the measurement reporting procedure, as specified in 5.5.5;

2> if the *triggerType* is set to 'event' and if the entry condition applicable for this event, i.e. the event corresponding with the *eventId* of the corresponding *reportConfig* within *VarMeasConfig*, is fulfilled for one or more applicable cells not included in the *cellsTriggeredList* for all measurements after layer 3 filtering taken during *timeToTrigger* defined for this event within the *VarMeasConfig* (a subsequent cell triggers the event):

3> set the *numberOfReportsSent* defined within the *VarMeasReportList* for this *measId* to 0;

3> include the concerned cell(s) in the *cellsTriggeredList* defined within the *VarMeasReportList* for this *measId*;

- 3> initiate the measurement reporting procedure, as specified in 5.5.5;
- 2> if the *triggerType* is set to 'event' and if the leaving condition applicable for this event is fulfilled for one or more of the cells included in the *cellsTriggeredList* defined within the *VarMeasReportList* for this *measId* for all measurements after layer 3 filtering taken during *timeToTrigger* defined within the *VarMeasConfig* for this event:
 - 3> remove the concerned cell(s) in the *cellsTriggeredList* defined within the *VarMeasReportList* for this *measId*;
 - 3> if *reportOnLeave* is set to *TRUE* for the corresponding reporting configuration:
 - 4> initiate the measurement reporting procedure, as specified in 5.5.5;
 - 3> if the *cellsTriggeredList* defined within the *VarMeasReportList* for this *measId* is empty:
 - 4> remove the measurement reporting entry within the *VarMeasReportList* for this *measId*;
 - 4> stop the periodical reporting timer for this *measId*, if running;
- 2> if the *purpose* is included and set to 'reportStrongestCells' or to 'reportStrongestCellsForSON' and if a (first) measurement result is available for one or more applicable cells:
 - 3> include a measurement reporting entry within the *VarMeasReportList* for this *measId*;
 - 3> set the *numberOfReportsSent* defined within the *VarMeasReportList* for this *measId* to 0;
 - 3> initiate the measurement reporting procedure, as specified in 5.5.5;

NOTE 1: If the *purpose* is set to 'reportStrongestCells', the UE initiates a first measurement report immediately after the quantity to be reported becomes available for at least either serving cell or one of the applicable cells. If the *purpose* is set to 'reportStrongestCellsForSON', the UE initiates a first measurement report when it has determined the strongest cells on the associated frequency.

- 2> upon expiry of the periodical reporting timer for this *measId*:
 - 3> initiate the measurement reporting procedure, as specified in 5.5.5;
- 2> if the *purpose* is included and set to 'reportCGI' and if the UE acquired the information needed to set all fields of *cellGlobalId* for the requested cell:
 - 3> include a measurement reporting entry within the *VarMeasReportList* for this *measId*;
 - 3> set the *numberOfReportsSent* defined within the *VarMeasReportList* for this *measId* to 0;
 - 3> stop timer T321;
 - 3> initiate the measurement reporting procedure, as specified in 5.5.5;
- 2> upon expiry of the T321 for this *measId*:
 - 3> include a measurement reporting entry within the *VarMeasReportList* for this *measId*;
 - 3> set the *numberOfReportsSent* defined within the *VarMeasReportList* for this *measId* to 0;
 - 3> initiate the measurement reporting procedure, as specified in 5.5.5;

NOTE 2: The UE does not stop the periodical reporting with *triggerType* set to 'event' or to 'periodical' while the corresponding measurement is not performed due to the serving cell RSRP being equal to or better than *s-Measure* or due to the measurement gap not being setup.

NOTE 3: If the UE is configured with DRX, the UE may delay the measurement reporting for event triggered and periodical triggered measurements until the Active Time, which is defined in TS 36.321 [6].

[TS 36.331, clause 5.5.4.6a]

The UE shall:

- 1> consider the entering condition for this event to be satisfied when condition A6-1, as specified below, is fulfilled;
- 1> consider the leaving condition for this event to be satisfied when condition A6-2, as specified below, is fulfilled;
- 1> for this measurement, consider the (secondary) cell that is configured on the frequency indicated in the associated *measObjectEUTRA* to be the serving cell;

NOTE: The neighbour(s) is on the same frequency as the SCell i.e. both are on the frequency indicated in the associated *measObject*.

Inequality A6-1 (Entering condition):

$$Mn + Ocn - Hys > Ms + Ocs + Off$$

Inequality A6-2 (Leaving condition):

$$Mn + Ocn + Hys < Ms + Ocs + Off$$

The variables in the formula are defined as follows:

Mn is the measurement result of the neighbouring cell, not taking into account any offsets.

Ocn is the cell specific offset of the neighbour cell (i.e. *cellIndividualOffset* as defined within *measObjectEUTRA* corresponding to the frequency of the neighbour cell), and set to zero if not configured for the neighbour cell.

Ms is the measurement result of the serving cell, not taking into account any offsets.

Ocs is the cell specific offset of the serving cell (i.e. *cellIndividualOffset* as defined within *measObjectEUTRA* corresponding to the serving frequency), and is set to zero if not configured for the serving cell.

Hys is the hysteresis parameter for this event (i.e. *hysteresis* as defined within *reportConfigEUTRA* for this event).

Off is the offset parameter for this event (i.e. *a6-Offset* as defined within *reportConfigEUTRA* for this event).

Mn, ***Ms*** are expressed in dBm in case of RSRP, or in dB in case of RSRQ.

Ocn, ***Ocs***, ***Hys***, ***Off*** are expressed in dB.

[TS 36.331, clause 5.5.5]

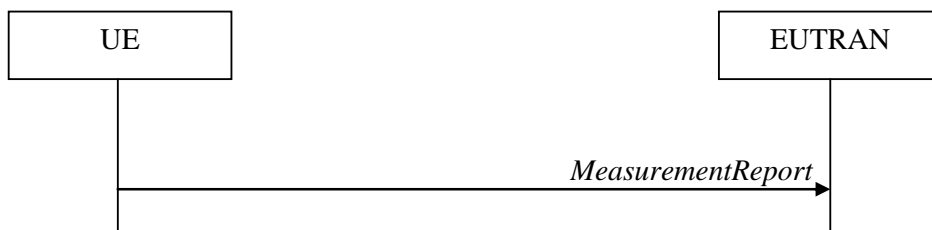

Figure 5.5.5-1: Measurement reporting

The purpose of this procedure is to transfer measurement results from the UE to E-UTRAN.

For the *measId* for which the measurement reporting procedure was triggered, the UE shall set the *measResults* within the *MeasurementReport* message as follows:

- 1> set the *measId* to the measurement identity that triggered the measurement reporting;
- 1> set the *measResultPCell* to include the quantities of the PCell;
- 1> set the *measResultServFreqList* to include for each SCell that is configured, if any, within *measResultSCell* the quantities of the concerned SCell;
- 1> if the *reportConfig* associated with the *measId* that triggered the measurement reporting includes *reportAddNeighMeas*:

- 2> for each serving frequency for which *measObjectId* is referenced in the *measIdList*, other than the frequency corresponding with the *measId* that triggered the measurement reporting:
 - 3> set the *measResultServFreqList* to include within *measResultBestNeighCell* the *physCellId* and the quantities of the best non-serving cell, based on RSRP, on the concerned serving frequency;
- 1> if there is at least one applicable neighbouring cell to report:
 - 2> set the *measResultNeighCells* to include the best neighbouring cells up to *maxReportCells* in accordance with the following:
 - 3> if the *triggerType* is set to 'event':
 - 4> include the cells included in the *cellsTriggeredList* as defined within the *VarMeasReportList* for this *measId*;
 - 3> else:
 - 4> include the applicable cells for which the new measurement results became available since the last periodical reporting or since the measurement was initiated or reset;

NOTE: The reliability of the report (i.e. the certainty it contains the strongest cells on the concerned frequency) depends on the measurement configuration i.e. the *reportInterval*. The related performance requirements are specified in TS 36.133 [16].

- 3> for each cell that is included in the *measResultNeighCells*, include the *physCellId*;
- 3> if the *triggerType* is set to 'event'; or the *purpose* is set to 'reportStrongestCells' or to 'reportStrongestCellsForSON':
 - 4> for each included cell, include the layer 3 filtered measured results in accordance with the *reportConfig* for this *measId*, ordered as follows:
 - 5> if the *measObject* associated with this *measId* concerns E-UTRA:
 - 6> set the *measResult* to include the quantity(ies) indicated in the *reportQuantity* within the concerned *reportConfig* in order of decreasing *triggerQuantity*, i.e. the best cell is included first;
 - 5> if the *measObject* associated with this *measId* concerns UTRA FDD and if *ReportConfigInterRAT* includes the *reportQuantityUTRA-FDD*:
 - 6> set the *measResult* to include the quantities indicated by the *reportQuantityUTRA-FDD* in order of decreasing *measQuantityUTRA-FDD* within the *quantityConfig*, i.e. the best cell is included first;
 - 5> if the *measObject* associated with this *measId* concerns UTRA FDD and if *ReportConfigInterRAT* does not include the *reportQuantityUTRA-FDD*; or
 - 5> if the *measObject* associated with this *measId* concerns UTRA TDD, GERAN or CDMA2000:
 - 6> set the *measResult* to the quantity as configured for the concerned RAT within the *quantityConfig* in order of either decreasing quantity for UTRA and GERAN or increasing quantity for CDMA2000 *pilotStrength*, i.e. the best cell is included first;
 - 3> else if the *purpose* is set to 'reportCGI':
 - 4> if the mandatory present fields of the *cgi-info* for the cell indicated by the *cellForWhichToReportCGI* in the associated *measObject* have been obtained:
 - 5> if the cell broadcasts a CSG identity:
 - 6> include the *csg-Identity*;
 - 6> include the *csg-MemberStatus* and set it to *member* if the cell is a CSG member cell;
 - 5> if the *si-RequestForHO* is configured within the *reportConfig* associated with this *measId*:

6> include the *cgi-Info* containing all the fields that have been successfully acquired, except for the *plmn-IdentityList*;

5> else:

6> include the *cgi-Info* containing all the fields that have been successfully acquired;

1> if the *ue-RxTxTimeDiffPeriodical* is configured within the corresponding *reportConfig* for this *measId*;

2> set the *ue-RxTxTimeDiffResult* to the measurement result provided by lower layers;

2> set the *currentSFN*;

1> if the *includeLocationInfo* is configured in the corresponding *reportConfig* for this *measId* and detailed location information that has not been reported is available, set the content of the *locationInfo* as follows:

2> include the *locationCoordinates*;

2> if available, include the *gnss-TOD-msec*;

1> increment the *numberOfReportsSent* as defined within the *VarMeasReportList* for this *measId* by 1;

1> stop the periodical reporting timer, if running;

1> if the *numberOfReportsSent* as defined within the *VarMeasReportList* for this *measId* is less than the *reportAmount* as defined within the corresponding *reportConfig* for this *measId*:

2> start the periodical reporting timer with the value of *reportInterval* as defined within the corresponding *reportConfig* for this *measId*;

1> else:

2> if the *triggerType* is set to 'periodical':

3> remove the entry within the *VarMeasReportList* for this *measId*;

3> remove this *measId* from the *measIdList* within *VarMeasConfig*;

1> if the measured results are for CDMA2000 HRPD:

2> set the *preRegistrationStatusHRPD* to the UE's CDMA2000 upper layer's HRPD *preRegistrationStatus*;

1> if the measured results are for CDMA2000 1xRTT:

2> set the *preRegistrationStatusHRPD* to 'FALSE';

1> submit the *MeasurementReport* message to lower layers for transmission, upon which the procedure ends;

8.3.1.17.1.3 Test description

8.3.1.17.1.3.1 Pre-test conditions

System Simulator:

- Cell 1 is the PCell, Cell 3 is the SCell to be added, and Cell 12 is the intra-frequency neighbour cell of Cell 3
- Cell 3 is an Inactive SCell according to [18] cl. 6.3.4
- System information combination3 as defined in TS 36.508 [18] clause 4.4.3.1 is used in E-UTRA cells.

UE:

None.

Preamble:

- The UE is in state Generic RB Established (state 3) on Cell 1 according to [18].

8.3.1.17.1.3.2 Test procedure sequence

Table 8.3.1.17.1.3.2-1 illustrates the downlink power levels to be applied for Cell 1, Cell 3 and Cell 12 at various time instants of the test execution. Row marked "T0" denotes the conditions after the preamble, while the configuration marked "T1" is applied at the point indicated in the Main behaviour description in Table 8.3.1.17.1.3.2-2.

Table 8.3.1.17.1.3.2-1: Power levels

	Parameter	Unit	Cell 1	Cell 3	Cell 12	Remark
T0	Cell-specific RS EPRE	dBm/15k Hz	-79	-85	-91	Power levels are such that entry condition for event A6 (measId 1) is not satisfied: $Mn + Ocn + Hys < Ms + Ocs + Off$
T1	Cell-specific RS EPRE	dBm/15k Hz	-79	-85	-73	Power levels are such that entry condition for event A6 (measId 1) is satisfied: $Mn + Ocn - Hys > Ms + Ocs + Off$

Table 8.3.1.17.1.3.2-2: Main behaviour

St	Procedure	Message Sequence		TP	Verdict
		U - S	Message		
1	The SS transmits an <i>RRCCONNECTIONRECONFIGURATION</i> message including <i>sCellToAddModList</i> with Cell 3 as SCell addition.	<--	<i>RRCCONNECTIONRECONFIGURATION</i>	-	-
2	The UE transmits an <i>RRCCONNECTIONRECONFIGURATIONCOMPLETE</i> message.	-->	<i>RRCCONNECTIONRECONFIGURATIONCOMPLETE</i>	-	-
3	The SS transmits an <i>RRCCONNECTIONRECONFIGURATION</i> message including <i>measConfig</i> to setup intra E-UTRAN measurement and reporting for event A6.	<--	<i>RRCCONNECTIONRECONFIGURATION</i>	-	-
4	The UE transmits an <i>RRCCONNECTIONRECONFIGURATIONCOMPLETE</i> message.	-->	<i>RRCCONNECTIONRECONFIGURATIONCOMPLETE</i>	-	-
5	Check: Does the UE transmit a <i>MEASUREMENTREPORT</i> message within the next 10s?	-->	<i>MEASUREMENTREPORT</i>	1	F
6	The SS re-adjusts the cell-specific reference signal level according to row "T1" in table 8.3.1.17.1.3.2-1.	-	-	-	-
7	Check: Does the UE transmit a <i>MEASUREMENTREPORT</i> message to report event A6 with the measured RSRP and RSRQ value for Cell 12?	-->	<i>MEASUREMENTREPORT</i>	2	P
8	The SS transmits an <i>RRCCONNECTIONRECONFIGURATION</i> message including <i>sCellToReleaseList</i> with Cell 3 as SCell release.	<--	<i>RRCCONNECTIONRECONFIGURATION</i>	-	-
9	The UE transmits an <i>RRCCONNECTIONRECONFIGURATIONCOMPLETE</i> message.	-->	<i>RRCCONNECTIONRECONFIGURATIONCOMPLETE</i>	-	-
10	Check: Does the UE attempt to transmit an uplink message for the next 10s?	-	-	3	F

8.3.1.17.1.3.3 Specific message contents

Table 8.3.1.17.1.3.3-1: RRCConnectionReconfiguration (step 1, Table 8.3.1.17.1.3.2-2)

Derivation Path: 36.508 clause 4.6.1 table 4.6.1-8			
Information Element	Value/remark	Comment	Condition
RRCConnectionReconfiguration ::= SEQUENCE {			
criticalExtensions CHOICE {			
c1 CHOICE {			
rrcConnectionReconfiguration-r8 SEQUENCE {			
nonCriticalExtension SEQUENCE {			
nonCriticalExtension SEQUENCE {			
nonCriticalExtension SEQUENCE {			
sCellToReleaseList-r10	Not present		
sCellToAddModList-r10	SCellToAddMod-r10-f2	SCell addition for Cell 3	
nonCriticalExtension SEQUENCE {}	Not present		
}			
}			
}			
}			
}			
}			
}			

Table 8.3.1.17.1.3.3-2: SCellToAddMod-r10-f2 (Table 8.3.1.17.1.3.3-1)

Derivation Path: 36.508 clause 4.6.1 table 4.6.3-19D SCellToAddMod-r10-DEFAULT			
Information Element	Value/remark	Comment	Condition
SCellToAddMod-r10 ::= SEQUENCE (SIZE (1..maxSCell-r10)) OF SEQUENCE {	1 entry		
sCellIndex-r10	1		
cellIdentification-r10 SEQUENCE {			
physCellId-r10	Physical Cell Identity of Cell 3		
dl-CarrierFreq-r10	Same downlink EARFCN as used for Cell 3		
}			
radioResourceConfigCommonSCell-r10	RadioResourceConfigCommonSCell-r10-f2		
}			

Table 8.3.1.17.1.3.3-3: RadioResourceConfigCommonSCell-r10-f2 (Table 8.3.1.17.1.3.3-2)

Derivation Path: 36.508 clause 4.6.3 table 4.6.3-13A			
Information Element	Value/remark	Comment	Condition
RadioResourceConfigCommonSCell-r10 ::= SEQUENCE {			
nonUL-Configuration-r10 SEQUENCE {			
dl-Bandwidth-r10	Same downlink system bandwidth as used for Cell 3		
}			
}			

Table 8.3.1.17.1.3.3-4: Void

Table 8.3.1.17.1.3.3-5: RRCConnectionReconfiguration (step 3, Table 8.3.1.17.1.3.2-2)

Derivation Path: 36.508 clause 4.6.1 table 4.6.1-8 with condition MEAS			
--	--	--	--

Table 8.3.1.17.1.3.3-6: *MeasConfig* (Table 8.3.1.17.1.3.3-5)

Derivation path: 36.508 clause 4.6.6 table 4.6.6-1			
Information Element	Value/Remark	Comment	Condition
MeasConfig ::= SEQUENCE {			
measObjectToAddModList SEQUENCE (SIZE (1..maxObjectId)) OF SEQUENCE {	2 entries		
measObjectId[1]	IdMeasObject-f1		
measObject[1]	MeasObjectEUTRA-GENERIC(f1)	Cell 1	
measObjectId[2]	IdMeasObject-f2		
measObject[2]	MeasObjectEUTRA-GENERIC(f2)	Cell 3, 12	
}			
reportConfigToAddModList SEQUENCE (SIZE (1..maxReportConfigId)) OF SEQUENCE {	1 entry		
reportConfigId[1]	IdReportConfig-A6		
reportConfig[1]	ReportConfig-A6		
}			
measIdToAddModList SEQUENCE (SIZE (1..maxMeasId)) OF SEQUENCE {	1 entry		
measId[1]	1		
measObjectId[1]	IdMeasObject-f2		
reportConfigId[1]	IdReportConfig-A6		
}			
}			

Table 8.3.1.17.1.3.3-7: *ReportConfig-A6* (Table 8.3.1.17.1.3.3-6)

Derivation Path: 36.508 clause 4.6.6 table 4.6.6-6A			
Information Element	Value/remark	Comment	Condition
ReportConfigEUTRA-A6 ::= SEQUENCE {			
triggerType CHOICE {			
event SEQUENCE {			
eventId CHOICE {			
eventA6-r10 SEQUENCE {			
a6-Offset-r10	0 (0 dB)		
a6-ReportOnLeave-r10	FALSE		
}			
}			
hysteresis	0 (0 dB)		
timeToTrigger	ms640		
}			
triggerQuantity	rsrp		
reportQuantity	both		
maxReportCells	1		
reportInterval	ms5120		
reportAmount	r2		
si-RequestForHO-r9	Not present		
ue-RxTxTimeDiffPeriodical-r9	Not present		
includeLocationInfo-r10	Not present		
reportAddNeighMeas-r10	Not present		
}			

Table 8.3.1.17.1.3.3-8: MeasurementReport (step 7, Table 8.3.1.17.1.3.2-2)

Derivation path: 36.508 4.6.1 table 4.6.1-5			
Information Element	Value/Remark	Comment	Condition
MeasurementReport ::= SEQUENCE {			
criticalExtensions CHOICE {			
c1 CHOICE {			
measurementReport-r8 SEQUENCE {			
measResults ::= SEQUENCE {			
measId	1		
measResultPCell ::= SEQUENCE {		Report Cell 1	
rsrpResult	(0..97)		
rsrqResult	(0..34)		
}			
measResultNeighCells CHOICE {			
MeasResultEUTRA ::= SEQUENCE (SIZE (1..maxCellReport)) OF SEQUENCE {		Report Cell 12	
physCellId	physCellId of Cell 12.		
cgi-Info	Not present		
measResult SEQUENCE {			
rsrpResult	(0..97)		
rsrqResult	(0..34)		
}			
}			
measResultForECID-r9	Not present		
locationInfo-r10	Not present		
measResultServFreqList-r10 SEQUENCE (SIZE (1..maxServCell-r10)) OF SEQUENCE {			
servFreqId-r10	1		
measResultSCell-r10 SEQUENCE {		Cell 3	
rsrpResultSCell-r10	(0..97)		
rsrqResultSCell-r10	(0..34)		
}			
}			
}			
}			
}			
}			
}			

Table 8.3.1.17.1.3.3-9: RRCConnectionReconfiguration (step 8, Table 8.3.1.17.1.3.2-2)

Derivation Path: 36.508 clause 4.6.1 table 4.6.1-8			
Information Element	Value/remark	Comment	Condition
RRCConnectionReconfiguration ::= SEQUENCE {			
criticalExtensions CHOICE {			
c1 CHOICE {			
rrcConnectionReconfiguration-r8 SEQUENCE {			
nonCriticalExtension SEQUENCE {			
nonCriticalExtension SEQUENCE {			
nonCriticalExtension SEQUENCE {			
sCellToReleaseList-r10 SEQUENCE (SIZE (1..maxSCell-r10) OF SEQUENCE {	1 entry		
sCellIndex-r10[1]	1	SCell release for Cell 3	
}			
sCellToAddModList-r10	Not present		
nonCriticalExtension SEQUENCE {}	Not present		
}			
}			
}			
}			
}			

8.3.1.17.2 CA / Measurement configuration control and reporting / Intra E-UTRAN measurements / Event A6 / Inter-band CA

8.3.1.17.2.1 Test Purpose (TP)

Same as TC 8.3.1.17.1 but applied to Inter-band CA case.

8.3.1.17.2.2 Conformance requirements

Same as TC 8.3.1.17.1 but applied to Inter-band CA case.

8.3.1.17.2.3 Test description

8.3.1.17.2.3.1 Pre-test conditions

Same as test case 8.3.1.17.1 with the following differences:

- CA configuration: Inter-band CA replaces Intra-band Contiguous CA
- Cells configuration: Cell 10 replaces Cell 3, Cell 30 replaces Cell 12
- Cell 10 is an Inactive SCell according to [18] cl. 6.3.4

8.3.1.17.2.3.2 Test procedure sequence

Same as test case 8.3.1.17.1 with the following differences:

- CA configuration: Inter-band CA replaces Inter-band Contiguous CA
- Cells configuration: Cell 10 replaces Cell 3, Cell 30 replaces Cell 12.

8.3.1.17.2.3.3 Specific message contents

Table 8.3.1.17.2.3.3-1: MeasConfig (Table 8.3.1.17.1.3.3-5)

Derivation path: 36.508 clause 4.6.6 table 4.6.6-1			
Information Element	Value/Remark	Comment	Condition
MeasConfig ::= SEQUENCE {			
measObjectToAddModList SEQUENCE (SIZE (1..maxObjectId)) OF SEQUENCE {	2 entries		
measObjectId[1]	IdMeasObject-f1		
measObject[1]	MeasObjectEUTRA-GENERIC(f1)	Cell 1	
measObjectId[2]	IdMeasObject-f5		
measObject[2]	MeasObjectEUTRA-GENERIC(f5)	Cell 10, Cell 30	
}			
reportConfigToAddModList SEQUENCE (SIZE (1..maxReportConfigId)) OF SEQUENCE {	1 entry		
reportConfigId[1]	IdReportConfig-A6		
reportConfig[1]	ReportConfig-A6		
}			
measIdToAddModList SEQUENCE (SIZE (1..maxMeasId)) OF SEQUENCE {	1 entry		
measId[1]	1		
measObjectId[1]	IdMeasObject-f5		
reportConfigId[1]	IdReportConfig-A6		
}			
}			

8.3.1.18 CA / Measurement configuration control and reporting / Intra E-UTRAN measurements / Additional measurement reporting

8.3.1.18.1 CA / Measurement configuration control and reporting / Intra E-UTRAN measurements / Additional measurement reporting / Intra-band Contiguous CA

8.3.1.18.1.1 Test Purpose (TP)

(1)

```

with { UE in E-UTRA RRC_CONNECTED state and measurements configured for event A2 reporting include
reportAddNeighMeas }
ensure that {
  when { Entry condition for event A2 of the concerned frequency that triggered measurement
reporting is met }
  then { UE sends MeasurementReport that does not include the best non-serving cell of the
concerned frequency in the measResultBestNeighCell }
}

```

(2)

```

with { UE in E-UTRA RRC_CONNECTED state and measurements configured for event A2 reporting include
reportAddNeighMeas }
ensure that {
  when { Entry condition for event A2 of other than the concerned frequency that triggered
measurement reporting is met }
  then { UE sends MeasurementReport that includes the best non-serving cell of the concerned
frequency in the measResultBestNeighCell }
}

```

8.3.1.18.1.2 Conformance requirements

References: The conformance requirements covered in the current TC are specified in: TS 36.331, clauses 5.3.5.3, 5.5.4.1 and 5.5.5. Unless otherwise stated these are Rel-10 requirements.

[TS 36.331, clause 5.3.5.3]

If the *RRConnectionReconfiguration* message does not include the *mobilityControlInfo* and the UE is able to comply with the configuration included in this message, the UE shall:

...

- 1> if the received *RRConnectionReconfiguration* includes the *sCellToAddModList*:
 - 2> perform SCell addition or modification as specified in 5.3.10.3b;

...

- 1> If the *RRConnectionReconfiguration* message includes the *measConfig*:
 - 2> perform the Measurement configuration procedure as specified in 5.5.2;

...

[TS 36.331, clause 5.5.4.1]

The UE shall:

- 1> for each *measId* included in the *measIdList* within *VarMeasConfig*:
 - 2> if the corresponding *reportConfig* includes a purpose set to 'reportStrongestCellsForSON':
 - 3> consider any neighbouring cell detected on the associated frequency to be applicable;
 - 2> else if the corresponding *reportConfig* includes a purpose set to 'reportCGI':
 - 3> consider any neighbouring cell detected on the associated frequency/ set of frequencies (GERAN) which has a physical cell identity matching the value of the *cellForWhichToReportCGI* included in the corresponding *measObject* within the *VarMeasConfig* to be applicable;
 - 2> else:
 - 3> if the corresponding *measObject* concerns E-UTRA:
 - 4> if the *ue-RxTxTimeDiffPeriodical* is configured in the corresponding *reportConfig*:
 - 5> consider only the PCell to be applicable;
 - 4> else if the *eventA1* or *eventA2* is configured in the corresponding *reportConfig*:
 - 5> consider only the serving cell to be applicable;
 - 4> else:
 - 5> consider any neighbouring cell detected on the associated frequency to be applicable when the concerned cell is not included in the *blackCellsToAddModList* defined within the *VarMeasConfig* for this *measId*;
 - 5> for events involving a serving cell on one frequency and neighbours on another frequency, consider the serving cell on the other frequency as a neighbouring cell;
 - 3> else if the corresponding *measObject* concerns UTRA or CDMA2000:
 - 4> consider a neighbouring cell on the associated frequency to be applicable when the concerned cell is included in the *cellsToAddModList* defined within the *VarMeasConfig* for this *measId* (i.e. the cell is included in the white-list);

NOTE 0: The UE may also consider a neighbouring cell on the associated UTRA frequency to be applicable when the concerned cell is included in the *csg-allowedReportingCells* within the *VarMeasConfig* for this *measId*, if configured in the corresponding *measObjectUTRA* (i.e. the cell is included in the range of physical cell identities for which reporting is allowed).

- 3> else if the corresponding *measObject* concerns GERAN:

- 4> consider a neighbouring cell on the associated set of frequencies to be applicable when the concerned cell matches the *ncc-Permitted* defined within the *VarMeasConfig* for this *measId*;
- 2> if the *triggerType* is set to 'event' and if the entry condition applicable for this event, i.e. the event corresponding with the *eventId* of the corresponding *reportConfig* within *VarMeasConfig*, is fulfilled for one or more applicable cells for all measurements after layer 3 filtering taken during *timeToTrigger* defined for this event within the *VarMeasConfig*, while the *VarMeasReportList* does not include an measurement reporting entry for this *measId* (a first cell triggers the event):
 - 3> include a measurement reporting entry within the *VarMeasReportList* for this *measId*;
 - 3> set the *numberOfReportsSent* defined within the *VarMeasReportList* for this *measId* to 0;
 - 3> include the concerned cell(s) in the *cellsTriggeredList* defined within the *VarMeasReportList* for this *measId*;
 - 3> initiate the measurement reporting procedure, as specified in 5.5.5;
- 2> if the *triggerType* is set to 'event' and if the entry condition applicable for this event, i.e. the event corresponding with the *eventId* of the corresponding *reportConfig* within *VarMeasConfig*, is fulfilled for one or more applicable cells not included in the *cellsTriggeredList* for all measurements after layer 3 filtering taken during *timeToTrigger* defined for this event within the *VarMeasConfig* (a subsequent cell triggers the event):
 - 3> set the *numberOfReportsSent* defined within the *VarMeasReportList* for this *measId* to 0;
 - 3> include the concerned cell(s) in the *cellsTriggeredList* defined within the *VarMeasReportList* for this *measId*;
 - 3> initiate the measurement reporting procedure, as specified in 5.5.5;
- 2> if the *triggerType* is set to 'event' and if the leaving condition applicable for this event is fulfilled for one or more of the cells included in the *cellsTriggeredList* defined within the *VarMeasReportList* for this *measId* for all measurements after layer 3 filtering taken during *timeToTrigger* defined within the *VarMeasConfig* for this event:
 - 3> remove the concerned cell(s) in the *cellsTriggeredList* defined within the *VarMeasReportList* for this *measId*;
 - 3> if *reportOnLeave* is set to *TRUE* for the corresponding reporting configuration:
 - 4> initiate the measurement reporting procedure, as specified in 5.5.5;
 - 3> if the *cellsTriggeredList* defined within the *VarMeasReportList* for this *measId* is empty:
 - 4> remove the measurement reporting entry within the *VarMeasReportList* for this *measId*;
 - 4> stop the periodical reporting timer for this *measId*, if running;
- 2> if the *purpose* is included and set to 'reportStrongestCells' or to 'reportStrongestCellsForSON' and if a (first) measurement result is available for one or more applicable cells:
 - 3> include a measurement reporting entry within the *VarMeasReportList* for this *measId*;
 - 3> set the *numberOfReportsSent* defined within the *VarMeasReportList* for this *measId* to 0;
 - 3> initiate the measurement reporting procedure, as specified in 5.5.5;

NOTE 1: If the *purpose* is set to 'reportStrongestCells', the UE initiates a first measurement report immediately after the quantity to be reported becomes available for at least either serving cell or one of the applicable cells. If the *purpose* is set to 'reportStrongestCellsForSON', the UE initiates a first measurement report when it has determined the strongest cells on the associated frequency.

- 2> upon expiry of the periodical reporting timer for this *measId*:
 - 3> initiate the measurement reporting procedure, as specified in 5.5.5;

2> if the *purpose* is included and set to 'reportCGI' and if the UE acquired the information needed to set all fields of *cellGlobalId* for the requested cell:

3> include a measurement reporting entry within the *VarMeasReportList* for this *measId*;

3> set the *numberOfReportsSent* defined within the *VarMeasReportList* for this *measId* to 0;

3> stop timer T321;

3> initiate the measurement reporting procedure, as specified in 5.5.5;

2> upon expiry of the T321 for this *measId*:

3> include a measurement reporting entry within the *VarMeasReportList* for this *measId*;

3> set the *numberOfReportsSent* defined within the *VarMeasReportList* for this *measId* to 0;

3> initiate the measurement reporting procedure, as specified in 5.5.5;

NOTE 2: The UE does not stop the periodical reporting with *triggerType* set to 'event' or to 'periodical' while the corresponding measurement is not performed due to the serving cell RSRP being equal to or better than *s-Measure* or due to the measurement gap not being setup.

NOTE 3: If the UE is configured with DRX, the UE may delay the measurement reporting for event triggered and periodical triggered measurements until the Active Time, which is defined in TS 36.321 [6].

[TS 36.331, clause 5.5.5]

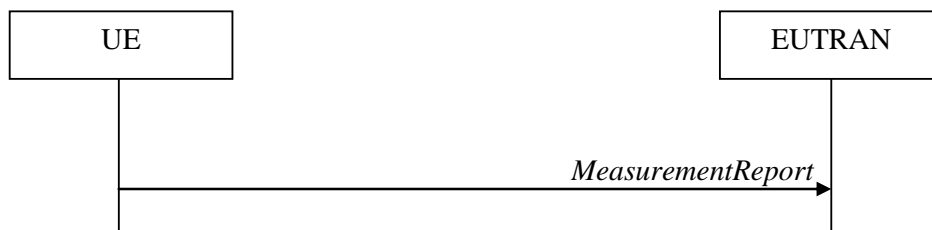

Figure 5.5.5-1: Measurement reporting

The purpose of this procedure is to transfer measurement results from the UE to E-UTRAN.

For the *measId* for which the measurement reporting procedure was triggered, the UE shall set the *measResults* within the *MeasurementReport* message as follows:

1> set the *measId* to the measurement identity that triggered the measurement reporting;

1> set the *measResultPCell* to include the quantities of the PCell;

1> set the *measResultServFreqList* to include for each SCell that is configured, if any, within *measResultSCell* the quantities of the concerned SCell;

1> if the *reportConfig* associated with the *measId* that triggered the measurement reporting includes *reportAddNeighMeas*:

2> for each serving frequency for which *measObjectId* is referenced in the *measIdList*, other than the frequency corresponding with the *measId* that triggered the measurement reporting:

3> set the *measResultServFreqList* to include within *measResultBestNeighCell* the *physCellId* and the quantities of the best non-serving cell, based on RSRP, on the concerned serving frequency;

1> if there is at least one applicable neighbouring cell to report:

2> set the *measResultNeighCells* to include the best neighbouring cells up to *maxReportCells* in accordance with the following:

3> if the *triggerType* is set to 'event':

4> include the cells included in the *cellsTriggeredList* as defined within the *VarMeasReportList* for this *measId*;

3> else:

4> include the applicable cells for which the new measurement results became available since the last periodical reporting or since the measurement was initiated or reset;

NOTE: The reliability of the report (i.e. the certainty it contains the strongest cells on the concerned frequency) depends on the measurement configuration i.e. the *reportInterval*. The related performance requirements are specified in TS 36.133 [16].

3> for each cell that is included in the *measResultNeighCells*, include the *physCellId*;

3> if the *triggerType* is set to 'event'; or the *purpose* is set to 'reportStrongestCells' or to 'reportStrongestCellsForSON':

4> for each included cell, include the layer 3 filtered measured results in accordance with the *reportConfig* for this *measId*, ordered as follows:

5> if the *measObject* associated with this *measId* concerns E-UTRA:

6> set the *measResult* to include the quantity(ies) indicated in the *reportQuantity* within the concerned *reportConfig* in order of decreasing *triggerQuantity*, i.e. the best cell is included first;

5> if the *measObject* associated with this *measId* concerns UTRA FDD and if *ReportConfigInterRAT* includes the *reportQuantityUTRA-FDD*:

6> set the *measResult* to include the quantities indicated by the *reportQuantityUTRA-FDD* in order of decreasing *measQuantityUTRA-FDD* within the *quantityConfig*, i.e. the best cell is included first;

5> if the *measObject* associated with this *measId* concerns UTRA FDD and if *ReportConfigInterRAT* does not include the *reportQuantityUTRA-FDD*; or

5> if the *measObject* associated with this *measId* concerns UTRA TDD, GERAN or CDMA2000:

6> set the *measResult* to the quantity as configured for the concerned RAT within the *quantityConfig* in order of either decreasing quantity for UTRA and GERAN or increasing quantity for CDMA2000 *pilotStrength*, i.e. the best cell is included first;

3> else if the *purpose* is set to 'reportCGI':

4> if the mandatory present fields of the *cgi-info* for the cell indicated by the *cellForWhichToReportCGI* in the associated *measObject* have been obtained:

5> if the cell broadcasts a CSG identity:

6> include the *csg-Identity*;

6> include the *csg-MemberStatus* and set it to *member* if the cell is a CSG member cell;

5> if the *si-RequestForHO* is configured within the *reportConfig* associated with this *measId*:

6> include the *cgi-Info* containing all the fields that have been successfully acquired, except for the *plmn-IdentityList*;

5> else:

6> include the *cgi-Info* containing all the fields that have been successfully acquired;

1> if the *ue-RxTxTimeDiffPeriodical* is configured within the corresponding *reportConfig* for this *measId*;

2> set the *ue-RxTxTimeDiffResult* to the measurement result provided by lower layers;

2> set the *currentSFN*;

1> if the *includeLocationInfo* is configured in the corresponding *reportConfig* for this *measId* and detailed location information that has not been reported is available, set the content of the *locationInfo* as follows:

2> include the *locationCoordinates*;

2> if available, include the *gnss-TOD-msec*;

1> increment the *numberOfReportsSent* as defined within the *VarMeasReportList* for this *measId* by 1;

1> stop the periodical reporting timer, if running;

1> if the *numberOfReportsSent* as defined within the *VarMeasReportList* for this *measId* is less than the *reportAmount* as defined within the corresponding *reportConfig* for this *measId*:

2> start the periodical reporting timer with the value of *reportInterval* as defined within the corresponding *reportConfig* for this *measId*;

1> else:

2> if the *triggerType* is set to 'periodical':

3> remove the entry within the *VarMeasReportList* for this *measId*;

3> remove this *measId* from the *measIdList* within *VarMeasConfig*;

1> if the measured results are for CDMA2000 HRPD:

2> set the *preRegistrationStatusHRPD* to the UE's CDMA2000 upper layer's HRPD *preRegistrationStatus*;

1> if the measured results are for CDMA2000 1xRTT:

2> set the *preRegistrationStatusHRPD* to 'FALSE';

1> submit the *MeasurementReport* message to lower layers for transmission, upon which the procedure ends;

8.3.1.18.1.3 Test description

8.3.1.18.1.3.1 Pre-test conditions

System Simulator:

- Cell 1 is the PCell. Cell 3 is the SCell to be added, Cell 12 (broadcast only cell) and Cell 23 (broadcast only cell) is the intra-frequency neighbour cells of Cell 3.
- Cell 3 is an Inactive SCell according to [18] cl. 6.3.4.
- System information combination 3 as defined in TS 36.508 [18] clause 4.4.3.1 is used in E-UTRA cells.

UE:

None.

Preamble:

- The UE is in state Generic RB Established (state 3) on Cell 1 according to [18].

8.3.1.18.1.3.2 Test procedure sequence

Table 8.3.1.18.1.3.2-1 illustrates the downlink power levels to be applied for Cell 1, Cell 3, Cell 12 and Cell 23 at various time instants of the test execution. Row marked "T0" denotes the conditions after the preamble, while the configuration marked "T1" and "T2" are applied at the point indicated in the Main behaviour description in Table 8.3.1.18.1.3.2-2.

Table 8.3.1.18.1.3.2-1: Power levels

	Parameter	Unit	Cell 1	Cell 3	Cell 12	Cell 23	Remark
T0	Cellspecific RS EPRE	dBm/15 kHz	-70	-70	-91	Off	Power levels are such that entry condition for event A2 is not satisfied $Ms + Hys > Thresh$ for Cell 1 and Cell 3
T1	Cell-specific RS EPRE	dBm/15 kHz	-70	-96	-91	Off	Power levels are such that entry condition for event A2 in Cell 3 is satisfied: $Ms + Hys < Thresh$
T2	Cell-specific RS EPRE	dBm/15 kHz	-96	-70	-91	-97	Power levels are such that entry condition for event A2 in Cell 1 is satisfied: $Ms + Hys < Thresh$

Table 8.3.1.18.1.3.2-2: Main behaviour

St	Procedure	Message Sequence		TP	Verdict
		U - S	Message		
1	The SS transmits an <i>RRConnectionReconfiguration</i> message including <i>sCellToAddModList</i> with Cell 3 as SCell addition.	<--	<i>RRConnectionReconfiguration</i>	-	-
2	The UE transmits an <i>RRConnectionReconfigurationComplete</i> message to confirm the SCell addition	-->	<i>RRConnectionReconfigurationComplete</i>	-	-
3	The SS transmits an <i>RRConnectionReconfiguration</i> message including <i>measConfig</i> to setup intra E-UTRAN measurement and for event A2 reporting configuration and include <i>reportAddNeighMeas</i>	<--	<i>RRConnectionReconfiguration</i>	-	-
4	The UE transmits an <i>RRConnectionReconfigurationComplete</i> message.	-->	<i>RRConnectionReconfigurationComplete</i>	-	-
5	The SS re-adjusts the cell-specific reference signal level according to row "T1" in table 8.3.1.18.1.3.2-1.				
6	Check: Does the UE transmit a <i>MeasurementReport</i> message that does not include the RSRP and RSRQ value of the best non-serving cell on the concerned serving frequency in <i>measResultBestNeighCell</i> ?	-->	<i>MeasurementReport</i>	1	P
7	The SS re-adjusts the cell-specific reference signal level according to row "T2" in table 8.3.1.18.1.3.2-1.	-	-	-	-
8	Check: Does the UE transmit a <i>MeasurementReport</i> message included the RSRP and RSRQ value of the best non-serving cell (Cell 12) on the concerned serving frequency in <i>measResultBestNeighCell</i> ?	-->	<i>MeasurementReport</i>	2	P

8.3.1.18.1.3.3 Specific message contents

Table 8.3.1.18.1.3.3-1: RRCConnectionReconfiguration (step 1, Table 8.3.1.18.1.3.2-2)

Derivation Path: 36.508 clause 4.6.1 table 4.6.1-8			
Information Element	Value/remark	Comment	Condition
RRCConnectionReconfiguration ::= SEQUENCE {			
criticalExtensions CHOICE {			
c1 CHOICE {			
rrcConnectionReconfiguration-r8 SEQUENCE {			
nonCriticalExtension SEQUENCE {			
nonCriticalExtension SEQUENCE {			
nonCriticalExtension SEQUENCE {			
sCellToReleaseList-r10	Not present		
sCellToAddModList-r10	SCellToAddMod-r10-f2	SCell addition for Cell 3	
nonCriticalExtension SEQUENCE {}	Not present		
}			
}			
}			
}			
}			
}			
}			

Table 8.3.1.18.1.3.3-2: SCellToAddMod-r10-f2 (Table 8.3.1.18.1.3.3-1)

Derivation Path: 36.508 clause 4.6.1 table 4.6.3-19D SCellToAddMod-r10-DEFAULT			
Information Element	Value/remark	Comment	Condition
SCellToAddMod-r10 ::= SEQUENCE (SIZE (1..maxSCell-r10)) OF SEQUENCE {	1 entry		
sCellIndex-r10[1]	1		
cellIdentification-r10[1] SEQUENCE {			
physCellId-r10[1]	Physical Cell Identity of Cell 3		
dl-CarrierFreq-r10[1]	Same downlink EARFCN as used for Cell 3		
}			
radioResourceConfigCommonSCell-r10[1]	RadioResourceConfigCommonSCell-r10-f2		
radioResourceConfigDedicatedSCell-r10[1]	RadioResourceConfigDedicatedSCell-r10-DEFAULT		
...			
}			

Table 8.3.1.18.1.3.3-3: RadioResourceConfigCommonSCell-r10-f2 (Table 8.3.1.18.1.3.3-2)

Derivation Path: 36.508 clause 4.6.3 table 4.6.3-13A			
Information Element	Value/remark	Comment	Condition
RadioResourceConfigCommonSCell-r10 ::= SEQUENCE {			
nonUL-Configuration-r10 SEQUENCE {			
dl-Bandwidth-r10	Same downlink system bandwidth as used for Cell 3		
}			
}			

Table 8.3.1.18.1.3.3-4: Void

Table 8.3.1.18.1.3.3-5: RRCConnectionReconfiguration (step 3, Table 8.3.1.18.1.3.2-2)

Derivation Path: 36.508 clause 4.6.1 table 4.6.1-8 with condition MEAS
--

Table 8.3.1.18.1.3.3-6: *MeasConfig* (Table 8.3.1.18.1.3.3-5)

Derivation path: 36.508 clause 4.6.6 table 4.6.6-1			
Information Element	Value/Remark	Comment	Condition
MeasConfig ::= SEQUENCE {			
measObjectToAddModList SEQUENCE (SIZE (1..maxObjectId)) OF SEQUENCE {	2 entries		
measObjectId[1]	IdMeasObject-f1		
measObject[1]	MeasObjectEUTRA-GENERIC(f1)	Cell 1,	
measObjectId[2]	IdMeasObject-f2		
measObject[2]	MeasObjectEUTRA-GENERIC(f2)	Cell 3, Cell 12, Cell 23	
}			
reportConfigToAddModList SEQUENCE (SIZE (1..maxReportConfigId)) OF SEQUENCE {	1 entry		
reportConfigId[1]	IdReportConfig-A2		
reportConfig[1]	ReportConfig-A2-CA		
}			
measIdToAddModList SEQUENCE (SIZE (1..maxMeasId)) OF SEQUENCE {	2 entries		
measId[1]	1		
measObjectId[1]	IdMeasObject-f1		
reportConfigId[1]	IdReportConfig-A2		
measId[2]	2		
measObjectId[2]	IdMeasObject-f2		
reportConfigId[2]	IdReportConfig-A2		
}			
}			

Table 8.3.1.18.1.3.3-7: *ReportConfig-A2-CA* (Table 8.3.1.18.1.3.3-6)

Derivation path: 36.508 clause 4.6.6 table 4.6.6-5 ReportConfigEUTRA-A2(-83)			
Information Element	Value/Remark	Comment	Condition
ReportConfigEUTRA ::= SEQUENCE {			
triggerType CHOICE {			
event SEQUENCE {			
hysteresis	6	3 dB	
}			
}			
reportAddNeighMeas-r10	setup		
}			

Table 8.3.1.18.1.3.3-8: MeasurementReport (step 6, Table 8.3.1.18.1.3.2-2)

Derivation path: 36.508 4.6.1 table 4.6.1-5			
Information Element	Value/Remark	Comment	Condition
MeasurementReport ::= SEQUENCE {			
criticalExtensions CHOICE {			
c1 CHOICE {			
measurementReport-r8 SEQUENCE {			
measResults ::= SEQUENCE {			
measId	2		
measResultPCell ::= SEQUENCE {		Report Cell 1	
rsrpResult	(0..97)		
rsrqResult	(0..34)		
}			
measResultForECID-r9	Not present		
locationInfo-r10	Not present		
measResultServFreqList-r10 SEQUENCE (SIZE (1..maxServCell-r10)) OF SEQUENCE {			
servFreqId-r10	1		
measResultSCell-r10 SEQUENCE {		Cell 3	
rsrpResultSCell-r10	(0..97)		
rsrqResultSCell-r10	(0..34)		
}			
}			
}			
}			
}			
}			

Table 8.3.1.18.1.3.3-9: MeasurementReport (step 8, Table 8.3.1.18.1.3.2-2)

Derivation path: 36.508 4.6.1 table 4.6.1-5			
Information Element	Value/Remark	Comment	Condition
MeasurementReport ::= SEQUENCE {			
criticalExtensions CHOICE {			
c1 CHOICE {			
measurementReport-r8 SEQUENCE {			
measResults ::= SEQUENCE {			
measId	1		
measResultPCell ::= SEQUENCE {		Report Cell 1	
rsrpResult	(0..97)		
rsrqResult	(0..34)		
}			
measResultForECID-r9	Not present		
locationInfo-r10	Not present		
measResultServFreqList-r10 SEQUENCE (SIZE (1..maxServCell-r10)) OF SEQUENCE {	1 entry		
servFreqId-r10[1]	1		
measResultSCell-r10[1] SEQUENCE {		Cell 3	
rsrpResultSCell-r10	(0..97)		
rsrqResultSCell-r10	(0..34)		
}			
measResultBestNeighCell-r10[1] SEQUENCE {		Cell 12	
physCellId-r10	physCellId of Cell 12		
rsrpResultNCell-r10	(0..97)		
rsrqResultNCell-r10	(0..34)		
}			
}			
}			
}			
}			

8.3.1.18.2 CA / Measurement configuration control and reporting / Intra E-UTRAN measurements / Additional measurement reporting / Inter-band CA

8.3.1.18.2.1 Test Purpose (TP)

Same as TC 8.3.1.18.1 but applied to Inter-band CA case.

8.3.1.18.2.2 Conformance requirements

Same as TC 8.3.1.18.1 but applied to Inter-band CA case.

8.3.1.18.2.3 Test description

8.3.1.18.2.3.1 Pre-test conditions

Same as test case 8.3.1.18.1 with the following differences:

- CA configuration: Inter-band CA replaces Intra-band Contiguous CA.
- Cells configuration: Cell 10 replaces Cell 3, Cell 30 replaces Cell 12 and Cell 31 replaces Cell 23.
- Cell 10 is an Inactive SCell according to [18] cl. 6.3.4.

8.3.1.18.2.3.2 Test procedure sequence

Same as test case 8.3.1.18.1 with the following differences:

- CA configuration: Inter-band CA replaces Inter-band Contiguous CA
- Cells configuration: Cell 10 replaces Cell 3, Cell 30 replaces Cell 12 and Cell 31 replaces Cell 23.

8.3.1.18.2.3.3 Specific message contents

Same as test case 8.3.1.18.1 with the following differences.

NOTE: For simplicity the steps referred below are steps in test case 8.3.1.18.1.

Table 8.3.1.18.2.3.3-1: MeasConfig (Table 8.3.1.18.1.3.3-5)

Derivation path: 36.508 clause 4.6.6 table 4.6.6-1			
Information Element	Value/Remark	Comment	Condition
MeasConfig ::= SEQUENCE {			
measObjectToAddModList SEQUENCE (SIZE (1..maxObjectId)) OF SEQUENCE {	2 entries		
measObjectId[1]	IdMeasObject-f1		
measObject[1]	MeasObjectEUTRA-GENERIC(f1)	Cell 1,	
measObjectId[2]	IdMeasObject-f5		
measObject[2]	MeasObjectEUTRA-GENERIC(f5)	Cell 10, Cell 30, Cell 31	
}			
reportConfigToAddModList SEQUENCE (SIZE (1..maxReportConfigId)) OF SEQUENCE {	1 entry		
reportConfigId[1]	IdReportConfig-A2		
reportConfig[1]	ReportConfig-A2-CA		
}			
measIdToAddModList SEQUENCE (SIZE (1..maxMeasId)) OF SEQUENCE {	2 entries		
measId[1]	1		
measObjectId[1]	IdMeasObject-f1		
reportConfigId[1]	IdReportConfig-A2		
measId[2]	2		
measObjectId[2]	IdMeasObject-f5		
reportConfigId[2]	IdReportConfig-A2		
}			
}			

8.3.1.19 eCIC/ Measurement configuration control and reporting / CSI change

8.3.1.19.1 Test Purpose (TP)

(1)

```
with { UE in E-UTRA RRC_CONNECTED state and two csi-MeasSubframeSets configured }
ensure that {
  when { The periodic CQI/PMI reporting criteria is met }
  then { UE reports CQI as configured in cqi-pmi-ConfigIndexes }
}
```

8.3.1.19.2 Conformance requirements

References: The conformance requirements covered in the current TC are specified in: TS 36.331, clauses 5.3.5.3 and 6.3.2; TS 36.213, clause 7.2.2.

[TS 36.331, clause 5.3.5.3]

If the *RRCConnectionReconfiguration* message does not include the *mobilityControlInfo* and the UE is able to comply with the configuration included in this message, the UE shall:

...

1> If the *RRCConnectionReconfiguration* message includes the *measConfig*:

2> perform the Measurement configuration procedure as specified in 5.5.2;

...

[TS 36.213, clause 7.2.2]

...

For each serving cell, the periodicity N_{pd} (in subframes) and offset $N_{OFFSET,CQI}$ (in subframes) for CQI/PMI reporting are determined based on the parameter *cqi-pmi-ConfigIndex* ($I_{CQI/PMI}$) given in Table 7.2.2-1A for FDD and Table 7.2.2-1C for TDD. The periodicity M_{RI} and relative offset $N_{OFFSET,RI}$ for RI reporting are determined based on the parameter *ri-ConfigIndex* (I_{RI}) given in Table 7.2.2-1B. Both *cqi-pmi-ConfigIndex* and *ri-ConfigIndex* are configured by higher layer signalling. The relative reporting offset for RI $N_{OFFSET,RI}$ takes values from the set $\{0, -1, \dots, -(N_{pd} - 1)\}$. If a UE is configured to report for more than one CSI subframe set then parameter *cqi-pmi-ConfigIndex* and *ri-ConfigIndex* respectively correspond to the CQI/PMI and RI periodicity and relative reporting offset for subframe set 1 and *cqi-pmi-ConfigIndex2* and *ri-ConfigIndex2* respectively correspond to the CQI/PMI and RI periodicity and relative reporting offset for subframe set 2.

In the case where wideband CQI/PMI reporting is configured:

- The reporting instances for wideband CQI/PMI are subframes satisfying $(10 \times n_f + \lfloor n_s / 2 \rfloor - N_{OFFSET,CQI}) \bmod (N_{pd}) = 0$.
- In case RI reporting is configured, the reporting interval of the RI reporting is an integer multiple M_{RI} of period N_{pd} (in subframes).
 - The reporting instances for RI are subframes satisfying $(10 \times n_f + \lfloor n_s / 2 \rfloor - N_{OFFSET,CQI} - N_{OFFSET,RI}) \bmod (N_{pd} \cdot M_{RI}) = 0$.

...

[TS 36.331, clause 6.3.2]

– CQI-ReportConfig

The IE *CQI-ReportConfig* is used to specify the CQI reporting configuration.

CQI-ReportConfig information elements

```

-- ASN1START
...
CQI-ReportConfig-r10 ::= SEQUENCE {
  cqi-ReportAperiodic-r10          CQI-ReportAperiodic-r10          OPTIONAL, -- Need ON
  nomPDSCH-RS-EPRE-Offset        INTEGER (-1..6),
  cqi-ReportPeriodic-r10         CQI-ReportPeriodic-r10          OPTIONAL, -- Need ON
  pmi-RI-Report-r9               ENUMERATED {setup}              OPTIONAL, -- Cond
  PMIRIPCell
    csi-SubframePatternConfig-r10 CHOICE {
      release                       NULL,
      setup                         SEQUENCE {
        csi-MeasSubframeSet1-r10    MeasSubframePattern-r10,
        csi-MeasSubframeSet2-r10    MeasSubframePattern-r10
      }
    }
  }
  OPTIONAL -- Need ON
}
...
CQI-ReportPeriodic-r10 ::= CHOICE {
  release                       NULL,
  setup                         SEQUENCE {
    cqi-PUCCH-ResourceIndex-r10    INTEGER (0..1184),
    cqi-PUCCH-ResourceIndexP1-r10  INTEGER (0..1184)          OPTIONAL, -- Need OR
    cqi-pmi-ConfigIndex            INTEGER (0..1023),
    cqi-FormatIndicatorPeriodic-r10 CHOICE {
      widebandCQI-r10              SEQUENCE {
        csi-ReportMode-r10        ENUMERATED {submode1, submode2}  OPTIONAL -- Need OR
      },
      subbandCQI-r10              SEQUENCE {
        k                          INTEGER (1..4),
        periodicityFactor-r10     ENUMERATED {n2, n4}
      }
    },
    ri-ConfigIndex                INTEGER (0..1023)          OPTIONAL, -- Need OR
    simultaneousAckNackAndCQI     BOOLEAN,
    cqi-Mask-r9                   ENUMERATED {setup}          OPTIONAL, -- Need OR
    csi-ConfigIndex-r10           CHOICE {
      release                       NULL,
      setup                         SEQUENCE {
        cqi-pmi-ConfigIndex2-r10    INTEGER (0..1023),
        ri-ConfigIndex2-r10        INTEGER (0..1023)          OPTIONAL -- Need OR
      }
    }
  }
  OPTIONAL -- Need ON
}
}
CQI-ReportAperiodic-r10 ::= CHOICE {
  release                       NULL,
  setup                         SEQUENCE {
    cqi-ReportModeAperiodic-r10    CQI-ReportModeAperiodic,
    aperiodicCSI-Trigger-r10       SEQUENCE {
      trigger1-r10                 BIT STRING (SIZE (8)),
      trigger2-r10                 BIT STRING (SIZE (8))
    }
  }
  OPTIONAL -- Need OR
}
}
CQI-ReportModeAperiodic ::= ENUMERATED {
  rm12, rm20, rm22, rm30, rm31,
  spare3, spare2, spare1
}
-- ASN1STOP

```

CQI-ReportConfig field descriptions	
aperiodicCSI-Trigger	indicates for which serving cell(s) the aperiodic CSI report is triggered when one or more SCells are configured. <i>trigger1</i> corresponds to the CSI request field 10 and <i>trigger2</i> corresponds to the CSI request field 11, see TS 36.213 [23, table 7.2.1-1A]. The leftmost bit, bit 0 in the bit string corresponds to the cell with <i>ServCellIndex</i> =0 and bit 1 in the bit string corresponds to the cell with <i>ServCellIndex</i> =1 etc. Each bit has either value 0 (means no aperiodic CSI report is triggered) or value 1 (means the aperiodic CSI report is triggered). At most 5 bits can be set to value 1 in the bit string. One value applies for all serving cells (the associated functionality is common i.e. not performed independently for each cell).
cqi-Mask	Limits CQI/PMI/PTI/RI reports to the on-duration period of the DRX cycle, see TS 36.321 [6]. One value applies for all serving cells (the associated functionality is common i.e. not performed independently for each cell).
cqi-FormatIndicatorPeriodic	Parameter: <i>PUCCH CQI Feedback Type</i> , see TS 36.213 [23, table 7.2.2-1]. Depending on <i>transmissionMode</i> , reporting mode is implicitly given from the table.
cqi-pmi-ConfigIndex	Parameter: <i>CQI/PMI Periodicity and Offset Configuration Index $I_{CQI/PMI}$</i> , see TS 36.213 [23, tables 7.2.2-1A and 7.2.2-1C]. If subframe patterns for CSI (CQI/PMI/PTI/RI) reporting are configured (i.e. <i>csi-SubframePatternConfig</i> is configured), the parameter applies to the subframe pattern corresponding to <i>csi-MeasSubframeSet1</i> .
cqi-pmi-ConfigIndex2	Parameter: <i>CQI/PMI Periodicity and Offset Configuration Index $I_{CQI/PMI}$</i> , see TS 36.213 [23, tables 7.2.2-1A and 7.2.2-1C]. The parameter applies to the subframe pattern corresponding to <i>csi-MeasSubframeSet2</i> .
cqi-PUCCH-ResourceIndex, cqi-PUCCH-ResourceIndexP1	Parameter $n_{PUCCH}^{(2,p)}$ for antenna port P0 and for antenna port P1 respectively, see TS 36.213 [23, 7.2]. E-UTRAN does not apply value 1185.
cqi-ReportModeAperiodic	Parameter: <i>reporting mode</i> . Value <i>rm12</i> corresponds to Mode 1-2, <i>rm20</i> corresponds to Mode 2-0, <i>rm22</i> corresponds to Mode 2-2 etc. PUSCH reporting modes are described in TS 36.213 [23, 7.2.1].
csi-ConfigIndex	E-UTRAN configures <i>csi-ConfigIndex</i> only for PCell and only if <i>csi-SubframePatternConfig</i> is configured. The UE shall release <i>csi-ConfigIndex</i> if <i>csi-SubframePatternConfig</i> is released.
csi-ReportMode	Parameter: <i>PUCCH_format1-1_CSI_reporting_mode</i> , see TS 36.213 [23, 7.2.2].
K	Parameter: <i>K</i> , see TS 36.213 [23, 7.2.2].
nomPDSCH-RS-EPRE-Offset	Parameter: Δ_{offset} see TS 36.213 [23, 7.2.3]. Actual value = IE value * 2 [dB].
periodicityFactor	Parameter: <i>H'</i> , see TS 36.213 [23, 7.2.2].
pmi-RI-Report	See TS 36.213 [23, 7.2]. The presence of this field means PMI/RI reporting is configured; otherwise the PMI/RI reporting is not configured. EUTRAN configures this field only when <i>transmissionMode</i> is set to <i>tm8</i> or <i>tm9</i> .
ri-ConfigIndex	Parameter: <i>RI Config Index I_{RI}</i> , see TS 36.213 [23, 7.2.2-1B]. If subframe patterns for CSI (CQI/PMI/PTI/RI) reporting are configured (i.e. <i>csi-SubframePatternConfig</i> is configured), the parameter applies to the subframe pattern corresponding to <i>csi-MeasSubframeSet1</i> .
ri-ConfigIndex2	Parameter: <i>RI Config Index I_{RI}</i> , see TS 36.213 [23, 7.2.2-1B]. The parameter applies to the subframe pattern corresponding to <i>csi-MeasSubframeSet2</i> . E-UTRAN configures <i>ri-ConfigIndex2</i> only if <i>ri-ConfigIndex</i> is configured.
simultaneousAckNackAndCQI	Parameter: <i>Simultaneous-AN-and-CQI</i> . see TS 36.213 [23, 10.1] TRUE indicates that simultaneous transmission of ACK/NACK and CQI is allowed. For SCells this field is not applicable and the UE shall ignore the value.

8.3.1.19.3 Test description

8.3.1.19.3.1 Pre-test conditions

System Simulator:

- Cell 1
- Cell 2 is the intra-frequency neighbour cell of Cell 1
- System information combination 1 as defined in TS 36.508 [18] clause 4.4.3.1 is used in E-UTRA cells.

UE:

None.

Preamble:

- The UE is in state Generic RB Established (state 3) on Cell 1 according to [18].

8.3.1.19.3.2 Test procedure sequence

Table 8.3.1.19.3.2-1 illustrates the downlink power levels to be applied for Cell 1 and Cell 2 at various time instants of the test execution. Row marked "T0" denotes the conditions after the preamble, while row marked "T1" is to be applied subsequently. The exact instants on which these values shall be applied are described in the texts in this clause.

Table 8.3.1.19.3.2-1: Power levels

	Parameter	Unit	Cell 1	Cell 2	Remark
T0	Cell-specific RS EPRE	dBm/15 kHz	-85	Off	
T1	Cell-specific RS EPRE	dBm/15 kHz	-85	-79	

Table 8.3.1.19.3.2-2: Main behaviour

St	Procedure	Message Sequence		TP	Verdict
		U - S	Message		
1	The SS transmits an <i>RRConnectionReconfiguration</i> message to setup CSI measurement patterns on Cell1.	<--	<i>RRConnectionReconfiguration</i>	-	-
2	The UE transmits an <i>RRConnectionReconfigurationComplete</i> message.	-->	<i>RRConnectionReconfigurationComplete</i>	-	-
3	The SS re-adjusts the cell-specific reference signal level according to row "T1" in table 8.3.1.19.3.2-1.	-	-	-	-
4	Wait for 1s to allow measurement restriction patterns to be configured and cell power levels to settle on correct level.				
5	CHECK: Does the UE perform periodical CQI reporting on subframes configured in CQI-ReportPeriodic-r10 (csi-MeasSubframeSet1 and csi-MeasSubframeSet2) during the next 5 s? (NOTE)	-->	(CQI)	1	P
6	Check: Does the test result of CALL generic procedure in TS 36.508 subclause 6.4.2.3 indicate that UE is in E-UTRA RRC_CONNECTED state?	-	-	1	-

Note: In this test case, wideband CQI/PMI reporting is configured for transmission mode tm3 and tm4, For the csi-MeasSubframeSet1 the reporting instances for wideband CQI/PMI are subframes satisfying $(10 \times n_f + \lfloor n_s / 2 \rfloor - N_{OFFSET,CQI}) \bmod(N_{pd}) = 0$ The $cqi-pmi-ConfigIndex(I_{CQI/PMI}) = 25(\text{FDD})/24(\text{TDD})$, as per the Table 7.2.2-1A and 7.2.2-1C in TS 36.213, the periodicity N_p (in subframes) = 20ms(FDD) / 20ms(TDD), $N_{OFFSET,CQI}$ (in subframes) = 8ms(FDD) / 8ms(TDD),

For the csi-MeasSubframeSet2 the reporting instances for wideband CQI/PMI are subframes satisfying $(10 \times n_f + \lfloor n_s / 2 \rfloor - N_{OFFSET,CQI}) \bmod(N_{pd}) = 0$ The $cqi-pmi-ConfigIndex(I_{CQI/PMI}) = 40(\text{FDD})/39(\text{TDD})$, as per the Table 7.2.2-1A and 7.2.2-1C in TS 36.213, the periodicity N_p (in subframes) = 40ms(FDD) / 40ms(TDD), $N_{OFFSET,CQI}$ (in subframes) = 3ms (FDD) / 3ms(TDD),

8.3.1.19.3.3 Specific message contents

Table 8.3.1.19.3.3-1: RRCConnectionReconfiguration (step 1, Table 8.3.1.19.3.2-2)

Derivation Path: 36.331 clause 6.2.2			
Information Element	Value/remark	Comment	Condition
RRCConnectionReconfiguration ::= SEQUENCE {			
criticalExtensions CHOICE {			
c1 CHOICE{			
rrcConnectionReconfiguration-r8 SEQUENCE {			
radioResourceConfigDedicated	RadioResourceConfigDe dicated-CSIConfig		
}			
}			
}			
}			

Table 8.3.1.19.3.3-2: RadioResourceConfigDedicated-CSIConfig (Table 8.3.1.19.3.3-1)

Derivation Path: 36.331 clause 6.3.2			
Information Element	Value/remark	Comment	Condition
RadioResourceConfigDedicated ::= SEQUENCE {			
srb-ToAddModList	Not present		
drb-ToAddModList	Not present		
drb-ToReleaseList	Not present		
mac-MainConfig	Not present		
sps-Config	Not present		
physicalConfigDedicated	PhysicalConfigDedicated -CSIConfig		
rlf-TimersAndConstants-r9	Not present		
measSubframePatternPCell-r10	Not present		
}			

Table 8.3.1.19.3.3-3: PhysicalConfigDedicated-CSIConfig (Table 8.3.1.19.3.3-2)

Derivation Path: 36.508, Table 4.8.2.1.6-1			
Information Element	Value/remark	Comment	Condition
PhysicalConfigDedicated ::= SEQUENCE {			
cqi-ReportConfig-r10	CQI-ReportConfig-r10- CSIConfig		SRB1
}			

Table 8.3.1.19.3.3-4: CQI-ReportConfig-r10-CSISConfig (Table 8.3.1.19.3.3-3)

Derivation Path: 36.508 clause 4.6.3			
Information Element	Value/remark	Comment	Condition
CQI-ReportConfig-r10 ::= SEQUENCE {			
cqi-ReportAperiodic-r10	Not present		
nomPDSCH-RS-EPRE-Offset	FFS		
cqi-ReportPeriodic-r10	CQI-ReportPeriodic-r10-RECONFIG		
pmi-RI-Report-r9	Not present		
csi-SubframePatternConfig-r10 CHOICE {			
setup SEQUENCE {			
csi-MeasSubframeSet1-r10			
subframePatternFDD-r10	'01000100010001000100 01000100010001000100' B		FDD
subframePatternTDD-r10 CHOICE {			TDD
subframeConfig1-5-r10	'01000100010000010001' 'B		
}			
csi-MeasSubframeSet2-r10			
subframePatternFDD-r10	'10111011101110111011 10111011101110111011' B		FDD
subframePatternTDD-r10 CHOICE {			TDD
subframeConfig1-5-r10	'10001010001100101000' 'B		
}			
}			
}			

Table 8.3.1.19.3.3-5: CQI-ReportPeriodic-r10-RECONFIG Table (8.3.1.19.3.3-4)

Derivation Path: 36.331 clause 6.3.2			
Information Element	Value/remark	Comment	Condition
CQI-ReportPeriodic-r10 ::= CHOICE {			
setup SEQUENCE {			
cqi-PUCCH-ResourceIndex-r10	0		
cqi-PUCCH-ResourceIndexP1-r10	Not present		
cqi-pmi-ConfigIndex	25	(see Table 7.2.2-1A in TS 36.213)	FDD
	24	(see Table 7.2.2-1C in TS 36.213)	TDD
cqi-FormatIndicatorPeriodic-r10 CHOICE {			
widebandCQI-r10 SEQUENCE {			
csi-ReportMode-r10	submode1		
}			
}			
ri-ConfigIndex	Not present		
simultaneousAckNackAndCQI	FALSE		
cqi-Mask-r9	Not present		
csi-ConfigIndex-r10 CHOICE {			
setup SEQUENCE {			
cqi-pmi-ConfigIndex2-r10	40	(see Table 7.2.2-1A in TS 36.213)	FDD
	39	(see Table 7.2.2-1C in TS 36.213)	TDD
ri-ConfigIndex2-r10	Not present		
}			
}			

8.3.1.20 eICIC / Measurement configuration control and reporting / Event A3 / RSRP and RSRQ measurement / Neighbour ABS

8.3.1.20.1 Test Purpose (TP)

(1)

```
with { UE having completed the radio bearer establishment and initial security activation procedure}
ensure that {
  when { UE receives an RRCConnectionReconfiguration message including a MeasObject provided with
all parameters including the neighbour cell measurement restriction pattern
measSubframePatternConfigNeigh}
  then { UE transmits an RRCConnectionReconfigurationComplete message }
}
```

(2)

```
with { UE having transmitted an RRCConnectionReconfigurationComplete message in response to
RRCConnectionReconfiguration message including a MeasObject provided with all parameters including
the neighbour cell measurement restriction pattern measSubframePatternConfigNeigh}
ensure that {
  when { UE transmits MeasurementReport after A3 event}
  then { UE transmits RSRP and RSRQ measurements done in measSubframePatternNeigh }
}
```

8.3.1.20.2 Conformance requirements

References: The conformance requirements covered in the present TC are specified in: TS 36.331, clauses 5.3.10.0, 5.3.10.8, 5.5.3.1 and 5.5.2.5.

[TS 36.331, clause 5.3.10.0]

The UE shall:

- 1> if the received *radioResourceConfigDedicated* includes the *srb-ToAddModList*:
 - 2> perform the SRB addition or reconfiguration as specified in 5.3.10.1;
- 1> if the received *radioResourceConfigDedicated* includes the *drb-ToReleaseList*:
 - 2> perform DRB release as specified in 5.3.10.2;
- 1> if the received *radioResourceConfigDedicated* includes the *drb-ToAddModList*:
 - 2> perform DRB addition or reconfiguration as specified in 5.3.10.3;
- 1> if the received *radioResourceConfigDedicated* includes the *mac-MainConfig*:
 - 2> perform MAC main reconfiguration as specified in 5.3.10.4;
- 1> if the received *radioResourceConfigDedicated* includes *sps-Config*:
 - 2> perform SPS reconfiguration according to 5.3.10.5;
- 1> if the received *radioResourceConfigDedicated* includes the *physicalConfigDedicated*:
 - 2> reconfigure the physical channel configuration as specified in 5.3.10.6.
- 1> if the received *radioResourceConfigDedicated* includes the *rlf-TimersAndConstants*:
 - 2> reconfigure the values of timers and constants as specified in 5.3.10.7;
- 1> if the received *radioResourceConfigDedicated* includes the *measSubframePatternPCell*:
 - 2> reconfigure the time domain measurement resource restriction for the serving cell as specified in 5.3.10.8;

[TS 36.331, clause 5.3.10.8]

The UE shall:

- 1> if the received *measSubframePatternPCell* is set to *release*:
 - 2> release the time domain measurement resource restriction for the PCell, if previously configured
- 1> else:
 - 2> apply the time domain measurement resource restriction for the PCell in accordance with the received *measSubframePatternPCell*;

[TS 36.331, clause 5.5.3.1]

For all measurements the UE applies the layer 3 filtering as specified in 5.5.3.2, before using the measured results for evaluation of reporting criteria or for measurement reporting.

The UE shall:

- 1> whenever the UE has a *measConfig*, perform RSRP and RSRQ measurements for each serving cell, applying for the PCell the time domain measurement resource restriction in accordance with *measSubframePatternPCell*, if configured;
- 1> for each *measId* included in the *measIdList* within *VarMeasConfig*:
 - 2> if the *purpose* for the associated *reportConfig* is set to *reportCGI*:
 - 3> if *si-RequestForHO* is configured for the associated *reportConfig*:
 - 4> perform the corresponding measurements on the frequency and RAT indicated in the associated *measObject* using autonomous gaps as necessary;
 - 3> else:
 - 4> perform the corresponding measurements on the frequency and RAT indicated in the associated *measObject* using available idle periods or using autonomous gaps as necessary;

NOTE 1: If autonomous gaps are used to perform measurements, the UE is allowed to temporarily abort communication with all serving cell(s), i.e. create autonomous gaps to perform the corresponding measurements within the limits specified in TS 36.133 [16]. Otherwise, the UE only supports the measurements with the purpose set to *reportCGI* only if E-UTRAN has provided sufficient idle periods.

- 3> try to acquire the global cell identity of the cell indicated by the *cellForWhichToReportCGI* in the associated *measObject* by acquiring the relevant system information from the concerned cell;
- 3> if the cell indicated by the *cellForWhichToReportCGI* included in the associated *measObject* is an E-UTRAN cell:
 - 4> try to acquire the CSG identity, if the CSG identity is broadcast in the concerned cell;
 - 4> try to acquire the *trackingAreaCode* in the concerned cell;
 - 4> try to acquire the list of additional PLMN Identities, as included in the *plmn-IdentityList*, if multiple PLMN identities are broadcast in the concerned cell;

NOTE 2: The 'primary' PLMN is part of the global cell identity.

- 3> if the cell indicated by the *cellForWhichToReportCGI* included in the associated *measObject* is a UTRAN cell:
 - 4> try to acquire the LAC, the RAC and the list of additional PLMN Identities, if multiple PLMN identities are broadcast in the concerned cell;
 - 4> try to acquire the CSG identity, if the CSG identity is broadcast in the concerned cell;
- 3> if the cell indicated by the *cellForWhichToReportCGI* included in the associated *measObject* is a GERAN cell:
 - 4> try to acquire the RAC in the concerned cell;

- 3> if the cell indicated by the *cellForWhichToReportCGI* included in the associated *measObject* is a CDMA2000 cell and the *cdma2000-Type* included in the *measObject* is *typeHRPD*:
 - 4> try to acquire the Sector ID in the concerned cell;
- 3> if the cell indicated by the *cellForWhichToReportCGI* included in the associated *measObject* is a CDMA2000 cell and the *cdma2000-Type* included in the *measObject* is *type1XRTT*:
 - 4> try to acquire the BASE ID, SID and NID in the concerned cell;
- 2> else:
 - 3> if a measurement gap configuration is setup; or
 - 3> if the UE does not require measurement gaps to perform the concerned measurements:
 - 4> if *s-Measure* is not configured; or
 - 4> if *s-Measure* is configured and the PCell RSRP, after layer 3 filtering, is lower than this value:
 - 5> perform the corresponding measurements of neighbouring cells on the frequencies and RATs indicated in the concerned *measObject*, applying for neighbouring cells on the primary frequency the time domain measurement resource restriction in accordance with *measSubframePatternConfigNeigh*, if configured in the concerned *measObject*;
 - 4> if the *ue-RxTxTimeDiffPeriodical* is configured in the associated *reportConfig*:
 - 5> perform the UE Rx–Tx time difference measurements on the PCell;
 - 2> perform the evaluation of reporting criteria as specified in 5.5.4;

NOTE 3: The *s-Measure* defines when the UE is required to perform measurements. The UE is however allowed to perform measurements also when the PCell RSRP exceeds *s-Measure*, e.g., to measure cells broadcasting a CSG identity following use of the autonomous search function as defined in TS 36.304 [4].

[TS 36.331, clause 5.5.2.5]

The UE shall:

- 1> for each *measObjectId* included in the received *measObjectToAddModList*:
 - 2> if an entry with the matching *measObjectId* exists in the *measObjectList* within the *VarMeasConfig*, for this entry:
 - 3> replace the entry with the value received for this *measObject*, except for the fields *cellsToAddModList*, *blackCellsToAddModList*, *cellsToRemoveList*, *blackCellsToRemoveList* and *measSubframePatternConfigNeigh*;
 - 3> if the received *measObject* includes the *cellsToRemoveList*:
 - 4> for each *cellIndex* included in the *cellsToRemoveList*:
 - 5> remove the entry with the matching *cellIndex* from the *cellsToAddModList*;
 - 3> if the received *measObject* includes the *cellsToAddModList*:
 - 4> for each *cellIndex* value included in the *cellsToAddModList*:
 - 5> if an entry with the matching *cellIndex* exists in the *cellsToAddModList*:
 - 6> replace the entry with the value received for this *cellIndex*;
 - 5> else:
 - 6> add a new entry for the received *cellIndex* to the *cellsToAddModList*;
 - 3> if the received *measObject* includes the *blackCellsToRemoveList*:

- 4> for each *cellIndex* included in the *blackCellsToRemoveList*:
 - 5> remove the entry with the matching *cellIndex* from the *blackCellsToAddModList*;
- 3> if the received *measObject* includes the *blackCellsToAddModList*:
 - 4> for each *cellIndex* included in the *blackCellsToAddModList*:
 - 5> if an entry with the matching *cellIndex* is included in the *blackCellsToAddModList*:
 - 6> replace the entry with the value received for this *cellIndex*;
 - 5> else:
 - 6> add a new entry for the received *cellIndex* to the *blackCellsToAddModList*;
- 3> if the received *measObject* includes *measSubframePatternConfigNeigh*:
 - 4> set *measSubframePatternConfigNeigh* within the *VarMeasConfig* to the value of the received field
- 3> for each *measId* associated with this *measObjectId* in the *measIdList* within the *VarMeasConfig*, if any:
 - 4> remove the measurement reporting entry for this *measId* from the *VarMeasReportList*, if included;
 - 4> stop the periodical reporting timer or timer T321, whichever one is running, and reset the associated information (e.g. *timeToTrigger*) for this *measId*;
- 2> else:
 - 3> add a new entry for the received *measObject* to the *measObjectList* within *VarMeasConfig*;

8.3.1.20.3 Test description

8.3.1.20.3.1 Pre-test conditions

System Simulator:

- Cell 1 and Cell 2.

UE:

None.

Preamble:

- The UE is in state Generic RB Established (state 3) on Cell 1 according to [18].

8.3.1.20.3.2 Test procedure sequence

Table 8.3.1.20.3.2-1 illustrates the downlink power levels and other changing parameters to be applied for the cells at various time instants of the test execution. Row marked "T0" denotes the initial conditions after preamble, while columns marked "T1" is to be applied subsequently. The exact instants on which these values shall be applied are described in the texts in this clause.

Table 8.3.1.20.3.2-1: Time instances of cell power level and parameter changes

	Parameter	Unit	Cell 1	Cell 2	Remark
T0	Cell-specific RS EPRE	dBm/15k Hz	-85	-91	The power level values are such that measurement results for Cell 1 (M1) and Cell 2 (M2) satisfy exit condition for event A3 ($M2 < M1$). Serving Cell has no ABS pattern.
T1	Cell-specific RS EPRE	dBm/15k Hz	-85	-79	The power level values are such that measurement results for Cell 1 (M1) and Cell 2 (M2) satisfy entry condition for event A3 ($M2 > M1$). Neighbour Cell has ABS Pattern (<i>measSubframePatternConfigNeigh</i>).

Table 8.3.1.20.3.2-2: Main behaviour

St	Procedure	Message Sequence		TP	Verdict
		U - S	Message		
1	The SS transmits an <i>RRCCONNECTIONRECONFIGURATION</i> message on Cell 1 to setup intra frequency measurement.	<--	<i>RRCCONNECTIONRECONFIGURATION</i>	-	-
2	The UE transmits an <i>RRCCONNECTIONRECONFIGURATIONCOMPLETE</i> message on Cell 1 to confirm the setup of intra frequency measurement.	-->	<i>RRCCONNECTIONRECONFIGURATIONCOMPLETE</i>	1	P
3	The SS changes Cell 1 and Cell 2 parameters according to the row "T1" in table 8.3.1.20.3.2-1.	-	-	-	-
4	Check: Does the UE transmit a <i>MEASUREMENTREPORT</i> message on Cell 1 to report event A3 with the measured RSRP and RSRQ values for Cell 2?	-->	<i>MEASUREMENTREPORT</i>	2	P
5	Check: Does the UE transmit RSRP and RSRQ measurements in neighbour cell measurement restriction pattern?	-	FFS	-	-

8.3.1.20.3.3 Specific message contents

Table 8.3.1.20.3.3-1: *RRCCONNECTIONRECONFIGURATION* (step 1, Table 8.3.1.20.3.2-2)

Derivation Path: 36.508 clause 4.6.1 table 4.6.1-8 with condition MEAS
--

Table 8.3.1.20.3.3-2: Void

Table 8.3.1.20.3.3-3: *MeasConfig* (step 1, Table 8.3.1.20.3.3-2)

Derivation Path: 36.508 clause 4.6.6 table 4.6.6-1 with condition eICIC			
Information Element	Value/remark	Comment	Condition
measConfig ::= SEQUENCE {			
measObjectToAddModList SEQUENCE (SIZE (1..maxObjectId)) OF SEQUENCE {	1 entry		
measObjectId[1]	IdMeasObject-f1		
measObject[1]	MeasObjectEUTRA-GENERIC		
}			
reportConfigToAddModList ::= SEQUENCE {	ReportConfigToAddModList_DEFAULT		
}			
measIdToAddModList ::= SEQUENCE {	MeasIdToAddModList_DEFAULT		
}			
}			

Table 8.3.1.20.3.3-4: *MeasObjectEUTRA-GENERIC* (step 1, Table 8.3.1.20.3.3-2)

Derivation Path: 36.508, Table 4.6.6-2			
Information Element	Value/remark	Comment	Condition
MeasObjectEUTRA SEQUENCE {			
MeasSubframePatternConfigNeigh-r10 {			
measSubframePatternNeigh-r10			
subframePatternFDD-r10	'10110101101011010110 10110101101011010110' B		FDD
subframePatternTDD-r10 CHOICE {			TDD
subframeConfig1-5-r10	'11001110011100111001 'B		
}			
measSubframeCellList-r10 {}	1 entry	Cell 2	
}			
}			

8.3.1.21 eICIC / Measurement configuration control and reporting / Event A3 Handover / Neighbour RSRP measurement configuration change

8.3.1.21.1 Test Purpose (TP)

(1)

```
with { UE having completed the radio bearer establishment and initial security activation procedure }
ensure that {
  when { UE receives an RRCConnectionReconfiguration message including a MeasObject provided with
all parameters including the neighbour cell measurement restriction pattern
measSubframePatternConfigNeigh }
  then { UE transmits an RRCConnectionReconfigurationComplete message }
}
```

(2)

```
with { UE having transmitted an RRCConnectionReconfigurationComplete message in response to
RRCConnectionReconfiguration message including a MeasObject provided with all parameters including
the neighbour cell measurement restriction pattern measSubframePatternConfigNeigh }
ensure that {
  when { event A3 criteria is met }
  then { UE sends measurement report with event A3 }
}
```

(3)

```
with { UE having sent measurement report with event A3 }
```



```

ensure that {
  when { UE receives an RRCConnectionReconfiguration message including a mobilityControlInfo }
  then { UE transmits an RRCConnectionReconfigurationComplete message }
}

```

8.3.1.21.2 Conformance requirements

References: The conformance requirements covered in the present TC are specified in: TS 36.331, clauses 5.3.10.0, 5.3.10.8, 5.5.3.1 and 5.5.2.5. Unless otherwise stated these are Rel-10 requirements.

[TS 36.331, clause 5.3.10.0]

The UE shall:

- 1> if the received radioResourceConfigDedicated includes the srb-ToAddModList:
 - 2> perform the SRB addition or reconfiguration as specified in 5.3.10.1;
- 1> if the received radioResourceConfigDedicated includes the drb-ToReleaseList:
 - 2> perform DRB release as specified in 5.3.10.2;
- 1> if the received radioResourceConfigDedicated includes the drb-ToAddModList:
 - 2> perform DRB addition or reconfiguration as specified in 5.3.10.3;
- 1> if the received radioResourceConfigDedicated includes the mac-MainConfig:
 - 2> perform MAC main reconfiguration as specified in 5.3.10.4;
- 1> if the received radioResourceConfigDedicated includes sps-Config:
 - 2> perform SPS reconfiguration according to 5.3.10.5;
- 1> if the received radioResourceConfigDedicated includes the physicalConfigDedicated:
 - 2> reconfigure the physical channel configuration as specified in 5.3.10.6.
- 1> if the received radioResourceConfigDedicated includes the rlf-TimersAndConstants:
 - 2> reconfigure the values of timers and constants as specified in 5.3.10.7;
- 1> if the received radioResourceConfigDedicated includes the measSubframePatternPCell:
 - 2> reconfigure the time domain measurement resource restriction for the serving cell as specified in 5.3.10.8;

[TS 36.331, clause 5.3.10.8]

The UE shall:

- 1> if the received *measSubframePatternPCell* is set to *release*:
 - 2> release the time domain measurement resource restriction for the PCell, if previously configured
- 1> else:
 - 2> apply the time domain measurement resource restriction for the PCell in accordance with the received *measSubframePatternPCell*;

[TS 36.331, clause 5.5.2.5]

The UE shall:

- 1> for each *measObjectId* included in the received *measObjectToAddModList*:
 - 2> if an entry with the matching *measObjectId* exists in the *measObjectList* within the *VarMeasConfig*, for this entry:

- 3> replace the entry with the value received for this *measObject*, except for the fields *cellsToAddModList*, *blackCellsToAddModList*, *cellsToRemoveList*, *blackCellsToRemoveList* and *measSubframePatternConfigNeigh*;
- 3> if the received *measObject* includes the *cellsToRemoveList*:
 - 4> for each *cellIndex* included in the *cellsToRemoveList*:
 - 5> remove the entry with the matching *cellIndex* from the *cellsToAddModList*;
- 3> if the received *measObject* includes the *cellsToAddModList*:
 - 4> for each *cellIndex* value included in the *cellsToAddModList*:
 - 5> if an entry with the matching *cellIndex* exists in the *cellsToAddModList*:
 - 6> replace the entry with the value received for this *cellIndex*;
 - 5> else:
 - 6> add a new entry for the received *cellIndex* to the *cellsToAddModList*;
- 3> if the received *measObject* includes the *blackCellsToRemoveList*:
 - 4> for each *cellIndex* included in the *blackCellsToRemoveList*:
 - 5> remove the entry with the matching *cellIndex* from the *blackCellsToAddModList*;
- 3> if the received *measObject* includes the *blackCellsToAddModList*:
 - 4> for each *cellIndex* included in the *blackCellsToAddModList*:
 - 5> if an entry with the matching *cellIndex* is included in the *blackCellsToAddModList*:
 - 6> replace the entry with the value received for this *cellIndex*;
 - 5> else:
 - 6> add a new entry for the received *cellIndex* to the *blackCellsToAddModList*;
- 3> if the received *measObject* includes *measSubframePatternConfigNeigh*:
 - 4> set *measSubframePatternConfigNeigh* within the *VarMeasConfig* to the value of the received field
- 3> for each *measId* associated with this *measObjectId* in the *measIdList* within the *VarMeasConfig*, if any:
 - 4> remove the measurement reporting entry for this *measId* from the *VarMeasReportList*, if included;
 - 4> stop the periodical reporting timer or timer T321, whichever one is running, and reset the associated information (e.g. *timeToTrigger*) for this *measId*;
- 2> else:
 - 3> add a new entry for the received *measObject* to the *measObjectList* within *VarMeasConfig*;

[TS 36.331, clause 5.5.3.1]

For all measurements the UE applies the layer 3 filtering as specified in 5.5.3.2, before using the measured results for evaluation of reporting criteria or for measurement reporting.

The UE shall:

- 1> whenever the UE has a *measConfig*, perform RSRP and RSRQ measurements for each serving cell, applying for the PCell the time domain measurement resource restriction in accordance with *measSubframePatternPCell*, if configured;
- 1> for each *measId* included in the *measIdList* within *VarMeasConfig*:

- 2> if the *purpose* for the associated *reportConfig* is set to *reportCGI*:
 - 3> if *si-RequestForHO* is configured for the associated *reportConfig*:
 - 4> perform the corresponding measurements on the frequency and RAT indicated in the associated *measObject* using autonomous gaps as necessary;
 - 3> else:
 - 4> perform the corresponding measurements on the frequency and RAT indicated in the associated *measObject* using available idle periods or using autonomous gaps as necessary;

NOTE 1: If autonomous gaps are used to perform measurements, the UE is allowed to temporarily abort communication with all serving cell(s), i.e. create autonomous gaps to perform the corresponding measurements within the limits specified in TS 36.133 [16]. Otherwise, the UE only supports the measurements with the purpose set to *reportCGI* only if E-UTRAN has provided sufficient idle periods.

- 3> try to acquire the global cell identity of the cell indicated by the *cellForWhichToReportCGI* in the associated *measObject* by acquiring the relevant system information from the concerned cell;
- 3> if the cell indicated by the *cellForWhichToReportCGI* included in the associated *measObject* is an E-UTRAN cell:
 - 4> try to acquire the CSG identity, if the CSG identity is broadcast in the concerned cell;
 - 4> try to acquire the *trackingAreaCode* in the concerned cell;
 - 4> try to acquire the list of additional PLMN Identities, as included in the *plmn-IdentityList*, if multiple PLMN identities are broadcast in the concerned cell;

NOTE 2: The 'primary' PLMN is part of the global cell identity.

- 3> if the cell indicated by the *cellForWhichToReportCGI* included in the associated *measObject* is a UTRAN cell:
 - 4> try to acquire the LAC, the RAC and the list of additional PLMN Identities, if multiple PLMN identities are broadcast in the concerned cell;
 - 4> try to acquire the CSG identity, if the CSG identity is broadcast in the concerned cell;
- 3> if the cell indicated by the *cellForWhichToReportCGI* included in the associated *measObject* is a GERAN cell:
 - 4> try to acquire the RAC in the concerned cell;
- 3> if the cell indicated by the *cellForWhichToReportCGI* included in the associated *measObject* is a CDMA2000 cell and the *cdma2000-Type* included in the *measObject* is *typeHRPD*:
 - 4> try to acquire the Sector ID in the concerned cell;
- 3> if the cell indicated by the *cellForWhichToReportCGI* included in the associated *measObject* is a CDMA2000 cell and the *cdma2000-Type* included in the *measObject* is *type1XRTT*:
 - 4> try to acquire the BASE ID, SID and NID in the concerned cell;
- 2> else:
 - 3> if a measurement gap configuration is setup; or
 - 3> if the UE does not require measurement gaps to perform the concerned measurements:
 - 4> if *s-Measure* is not configured; or
 - 4> if *s-Measure* is configured and the PCell RSRP, after layer 3 filtering, is lower than this value:
 - 5> perform the corresponding measurements of neighbouring cells on the frequencies and RATs indicated in the concerned *measObject*, applying for neighbouring cells on the primary frequency

the time domain measurement resource restriction in accordance with *measSubframePatternConfigNeigh*, if configured in the concerned *measObject*;

4> if the *ue-RxTxTimeDiffPeriodical* is configured in the associated *reportConfig*:

5> perform the UE Rx–Tx time difference measurements on the PCell;

2> perform the evaluation of reporting criteria as specified in 5.5.4;

NOTE 3: The *s-Measure* defines when the UE is required to perform measurements. The UE is however allowed to perform measurements also when the PCell RSRP exceeds *s-Measure*, e.g., to measure cells broadcasting a CSG identity following use of the autonomous search function as defined in TS 36.304 [4].

8.3.1.21.3 Test description

8.3.1.21.3.1 Pre-test conditions

System Simulator:

- Cell 1 and Cell 2, with Cell 2 being the intra-frequency neighbour cell of Cell 1.

UE:

None.

Preamble:

- The UE is in state Generic RB Established (state 3) on Cell 1 according to [18].

8.3.1.21.3.2 Test procedure sequence

Table 8.3.1.21.3.2-1 illustrates the downlink power levels and other changing parameters to be applied for the cells at various time instants of the test execution. Row marked "T0" denotes the initial conditions after preamble, while columns marked "T1" is to be applied subsequently. The exact instants on which these values shall be applied are described in the texts in this clause.

Table 8.3.1.21.3.2-1: Time instances of cell power level and parameter changes

	Parameter	Unit	Cell 1	Cell 2	Remark
T0	Cell-specific RS EPRE	dBm/15k Hz	-85	-91	The power level values are such that measurement results for Cell 1 (M1) and Cell 2 (M2) satisfy exit condition for event A3 (M2 < M1). Serving Cell has no ABS pattern.
T1	Cell-specific RS EPRE	dBm/15k Hz	-85	-79	The power level values are such that measurement results for Cell 1 (M1) and Cell 2 (M2) satisfy entry condition for event A3 (M2 > M1). Neighbour Cell has ABS Pattern <i>measSubframePatternConfigNeigh</i> .

Table 8.3.1.21.3.2-2: Main behaviour

St	Procedure	Message Sequence		TP	Verdict
		U - S	Message		
1	The SS transmits an <i>RRConnectionReconfiguration</i> message on Cell 1 to setup intra frequency measurement.	<--	<i>RRConnectionReconfiguration</i>	-	-
2	The UE transmits an <i>RRConnectionReconfigurationComplete</i> message on Cell 1 to confirm the setup of intra frequency measurement.	-->	<i>RRConnectionReconfigurationComplete</i>	1	P
3	The SS changes Cell 1 and Cell 2 parameters according to the row "T1" in Table 8.3.1.21.3.2-1.	-	-	-	-
4	The UE transmits a <i>MeasurementReport</i> message on Cell 1 to report event A3 with the measured RSRP values for Cell 2.	-->	<i>MeasurementReport</i>	2	P
5	The SS transmits an <i>RRConnectionReconfiguration</i> message to order the UE to perform intra frequency handover to Cell 2.	<--	<i>RRConnectionReconfiguration</i>	-	-
6	Check: Does the UE transmit an <i>RRConnectionReconfigurationComplete</i> message on Cell 2 using common preamble to confirm the successful completion of the intra frequency handover?	-->	<i>RRConnectionReconfigurationComplete</i>	3	P

8.3.1.21.3.3 Specific message contents

Table 8.3.1.21.3.3-1: *RRConnectionReconfiguration* (step 1, Table 8.3.1.21.3.2-2)

Derivation Path: 36.508 clause 4.6.1 table 4.6.1-8 with condition MEAS

Table 8.3.1.21.3.3-2: *MeasConfig* (step 1, Table 8.3.1.21.3.2-2)

Derivation Path: 36.508 clause 4.6.6 table 4.6.6-1			
Information Element	Value/remark	Comment	Condition
<i>measConfig</i> ::= SEQUENCE {			
<i>measObjectToAddModList</i> SEQUENCE (SIZE (1.. <i>maxObjectId</i>)) OF SEQUENCE {	1 entry		
<i>measObjectId</i> [1]	IdMeasObject-f1		
<i>measObject</i> [1]	MeasObjectEUTRA-GENERIC		
}			
<i>reportConfigToAddModList</i> SEQUENCE (SIZE (1.. <i>maxReportConfigId</i>)) OF SEQUENCE {	1 entry		
<i>reportConfigId</i> [1]	IdReportConfig-A3		
<i>reportConfig</i> [1]	ReportConfig-A3-H		
}			
<i>measIdToAddModList</i> SEQUENCE (SIZE (1.. <i>maxMeasId</i>)) OF SEQUENCE {	1 entry		
<i>measId</i> [1]	1		
<i>measObjectId</i> [1]	IdMeasObject-f1		
<i>reportConfigId</i> [1]	IdReportConfig-A3		
}			
}			

Table 8.3.1.21.3.3-3: MeasObjectEUTRA-GENERIC (step 1, Table 8.3.1.21.3.2-2)

Derivation Path: 36.508, Table 4.6.6-2			
Information Element	Value/remark	Comment	Condition
MeasObjectEUTRA SEQUENCE {			
MeasSubframePatternConfigNeigh-r10 {			
measSubframePatternNeigh-r10	'00110011001100110011 00110011001100110011' B		
subframePatternFDD-r10	'10110101101011010110 10110101101011010110' B		FDD
subframePatternTDD-r10 CHOICE {			TDD
subframeConfig1-5-r10	'11001110011100111001 'B		
}			
measSubframeCellList-r10 {	1 entry	Cell 2	
}			
}			

Table 8.3.1.21.3.3-4: ReportConfig-A3-H (step 1, Table 8.3.1.21.3.2-2)

Derivation path: 36.508 clause 4.6.6 table 4.6.6-6 ReportConfigEUTRA-A3			
Information Element	Value/remark	Comment	Condition
ReportConfigEUTRA-A3 ::= SEQUENCE {			
triggerType CHOICE {			
event SEQUENCE {			
timeToTrigger	ms0		
}			
}			
reportQuantity	sameAsTriggerQuantity		
}			

Table 8.3.1.21.3.3-5: MeasurementReport (step 4, Table 8.3.1.21.3.2-2)

Derivation Path: 36.508, Table 4.6.1-5			
Information Element	Value/remark	Comment	Condition
MeasurementReport ::= SEQUENCE {			
criticalExtensions CHOICE {			
c1 CHOICE{			
measurementReport-r8 SEQUENCE {			
measResults SEQUENCE {			
measId	1		
measResultServCell SEQUENCE {			
rsrpResult	(0..97)		
}			
measResultNeighCells CHOICE {			
measResultListEUTRA SEQUENCE (SIZE (1..maxCellReport)) OF SEQUENCE {	1 entry		
physCellId	PhysicalCellIdentity of Cell 2		
cgi-Info	Not present		
measResult SEQUENCE {			
rsrpResult	(0..97)		
additionalSI-Info-r9	Not present		
}			
}			
measResultForECID-r9	Not present		
}			
}			
}			
}			
}			
}			

Table 8.3.1.21.3.3-6: RRCConnectionReconfiguration (step 5, Table 8.3.1.21.3.2-2)

Derivation Path: 36.508, Table 4.6.1-8, condition HO
--

Table 8.3.1.21.3.3-7: MobilityControlInfo (Table 8.3.1.21.3.2-2)

Derivation Path: 36.508 clause 4.6.5-1			
Information Element	Value/remark	Comment	Condition
MobilityControlInfo ::= SEQUENCE {			
targetPhysCellId	PhysicalCellIdentity of Cell 2		
carrierFreq	Not present		
}			

8.3.1.22 CA / Measurement configuration control and reporting / Intra E-UTRAN measurements / Event A1 / Event A2

8.3.1.22.1 CA / Measurement configuration control and reporting / Intra E-UTRAN measurements / Event A1 / Event A2 / Intra-band Contiguous CA

8.3.1.22.1.1 Test Purpose (TP)

(1)

```

with { UE in E-UTRA RRC_CONNECTED state and measurement configured for event A1 with event based
periodical reporting }
ensure that {
  when { Serving cell becomes better than absolute threshold plus hysteresis }
  then { UE sends MeasurementReport message at regular intervals while entering conditions for
event A1 are satisfied }
}

```

(2)

```

with { UE in E-UTRA RRC_CONNECTED state and periodical measurement reporting triggered by event A1
ongoing}
ensure that {
  when { Serving cell becomes worse than absolute threshold minus hysteresis }
  then { UE stops sending MeasurementReport message }
}

```

(3)

```

with { UE in E-UTRA RRC_CONNECTED state and measurement configured for event A2 with event based
periodical reporting }
ensure that {
  when { Serving cell becomes worse than absolute threshold minus hysteresis }
  then { UE sends MeasurementReport message at regular intervals while entering conditions for
event A2 are satisfied }
}

```

(4)

```

with { UE in E-UTRA RRC_CONNECTED state and periodical measurement reporting triggered by event A2
ongoing}
ensure that {
  when { Serving cell becomes better than absolute threshold plus hysteresis }
  then { UE stops sending MeasurementReport message }
}

```

8.3.1.22.1.2 Conformance requirements

References: The conformance requirements covered in the present TC are specified in: TS 36.331, clauses 5.5.4.2 and 5.5.5. Unless otherwise stated these are Rel-10 requirements.

[TS 36.331, clause 5.5.4.2]

The UE shall:

- 1> consider the entering condition for this event to be satisfied when condition A1-1, as specified below, is fulfilled;
- 1> consider the leaving condition for this event to be satisfied when condition A1-2, as specified below, is fulfilled;
- 1> for this measurement, consider the primary or secondary cell that is configured on the frequency indicated in the associated *measObjectEUTRA* to be the serving cell;

Inequality A1-1 (Entering condition)

$$Ms - Hys > Thresh$$

Inequality A1-2 (Leaving condition)

$$Ms + Hys < Thresh$$

The variables in the formula are defined as follows:

Ms is the measurement result of the serving cell, not taking into account any offsets.

Hys is the hysteresis parameter for this event (i.e. *hysteresis* as defined within *reportConfigEUTRA* for this event).

Thresh is the threshold parameter for this event (i.e. *a1-Threshold* as defined within *reportConfigEUTRA* for this event).

Ms is expressed in dBm in case of RSRP, or in dB in case of RSRQ.

Hys is expressed in dB.

Thresh is expressed in the same unit as ***Ms***.

[TS 36.331, clause 5.5.4.3]

The UE shall:

- 1> consider the entering condition for this event to be satisfied when condition A2-1, as specified below, is fulfilled;
- 1> consider the leaving condition for this event to be satisfied when condition A2-2, as specified below, is fulfilled;
- 1> for this measurement, consider the primary or secondary cell that is configured on the frequency indicated in the associated *measObjectEUTRA* to be the serving cell;

Inequality A2-1 (Entering condition)

$$Ms + Hys < Thresh$$

Inequality A2-2 (Leaving condition)

$$Ms - Hys > Thresh$$

The variables in the formula are defined as follows:

Ms is the measurement result of the serving cell, not taking into account any offsets.

Hys is the hysteresis parameter for this event (i.e. *hysteresis* as defined within *reportConfigEUTRA* for this event).

Thresh is the threshold parameter for this event (i.e. *a2-Threshold* as defined within *reportConfigEUTRA* for this event).

Ms is expressed in dBm in case of RSRP, or in dB in case of RSRQ.

Hys is expressed in dB.

Thresh is expressed in the same unit as *Ms*.

[TS 36.331, clause 5.5.5]

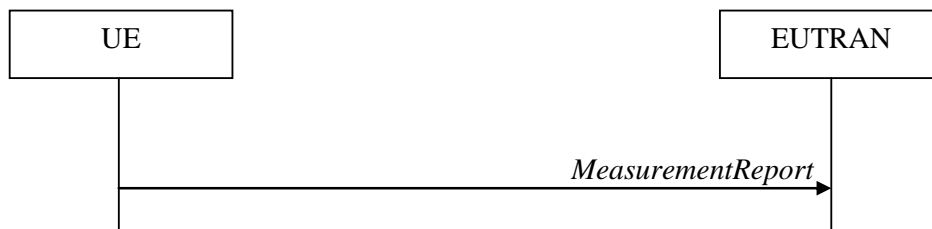

Figure 5.5.5-1: Measurement reporting

The purpose of this procedure is to transfer measurement results from the UE to E-UTRAN.

For the *measId* for which the measurement reporting procedure was triggered, the UE shall set the *measResults* within the *MeasurementReport* message as follows:

- 1> set the *measId* to the measurement identity that triggered the measurement reporting;
- 1> set the *measResultPCell* to include the quantities of the PCell;
- 1> set the *measResultServFreqList* to include for each SCell that is configured, if any, within *measResultSCell* the quantities of the concerned SCell;

8.3.1.22.1.3 Test description

8.3.1.22.1.3.1 Pre-test conditions

System Simulator:

- Cell 1 is the PCell and Cell 3 is the SCell to be added.
- Cell 3 is an Inactive SCell according to [18] cl. 6.3.4

- System information combination 3 as defined in TS 36.508 [18] clause 4.4.3.1 is used in E-UTRA cells.

UE:

None.

Preamble:

- The UE is in state Generic RB Established (state 3) on Cell 1 according to [18].

8.3.1.22.1.3.2 Test procedure sequence

Table 8.3.1.22.3.2-1 illustrates the downlink power levels and other changing parameters to be applied for the cells at various time instants of the test execution. Row marked "T0" denotes the initial conditions after preamble, while columns marked "T1" - "T5" is to be applied subsequently. The exact instants on which these values shall be applied are described in the texts in this clause.

Table 8.3.1.22.1.3.2-1: Time instances of cell power level and parameter changes

	Parameter	Unit	Cell 1	Cell 3	Remark
T0	Cell-specific RS EPRE	dBm/15k Hz	-85	-91	Power level of Scell (Cell 3) is such that $M_s + H_{ys} < Thresh$
T1	Cell-specific RS EPRE	dBm/15k Hz	-85	-65	Power level of Scell (Cell 3) is such that entry condition for event A1 is satisfied $M_s - H_{ys} > Thresh$
T2	Void				
T3	Cell-specific RS EPRE	dBm/15k Hz	-85	-91	Power level of Scell (Cell 3) is such that exit condition for event A1 is satisfied $M_s + H_{ys} < Thresh$
T4	Cell-specific RS EPRE	dBm/15k Hz	-85	-70	Power level of Scell (Cell 3) is such that $M_s - H_{ys} > Thresh$
T5	Cell-specific RS EPRE	dBm/15k Hz	-85	-96	Power level of Scell (Cell 3) is such that entry condition for event A2 is satisfied $M_s + H_{ys} < Thresh$
T6	Cell-specific RS EPRE	dBm/15k Hz	-85	-70	Power level of Scell (Cell 3) is such that exit condition for event A2 is satisfied $M_s - H_{ys} > Thresh$

Table 8.3.1.22.1.3.2-2: Main behaviour

St	Procedure	Message Sequence		TP	Verdict
		U - S	Message		
1	SS transmits an <i>RRCCONNECTIONRECONFIGURATION</i> message to configure SCell (Cell 3).	<--	<i>RRCCONNECTIONRECONFIGURATION</i>	-	-
2	The UE transmits an <i>RRCCONNECTIONRECONFIGURATIONCOMPLETE</i> message.	-->	<i>RRCCONNECTIONRECONFIGURATIONCOMPLETE</i>	-	-
3	SS transmits an <i>RRCCONNECTIONRECONFIGURATION</i> message including <i>MeasConfig</i> to setup intra LTE measurement and reporting for event A1 (measurements considered for the SCell (Cell 3)).	<--	<i>RRCCONNECTIONRECONFIGURATION</i>	-	-
4	The UE transmits an <i>RRCCONNECTIONRECONFIGURATIONCOMPLETE</i> message.	-->	<i>RRCCONNECTIONRECONFIGURATIONCOMPLETE</i>	-	-
5	SS re-adjusts the cell-specific reference signal level according to row "T1" in table 8.3.1.22.1.3.2-1.	-	-	-	-
6	Check: Does the UE transmit a <i>MeasurementReport</i> message to report event A1 with the measured RSRP and RSRQ value (measurements considered for the SCell (Cell 3))?	-->	<i>MeasurementReport</i>	1	P
-	EXCEPTION: Step 7 below is repeated until 3 <i>MeasurementReport</i> messages are received from the UE	-	-	-	-
7	Check: Does the UE transmit a <i>MeasurementReport</i> message to report event A1 with the measured RSRP and RSRQ value (measurements considered for the Pcell (Cell 1))?	-->	<i>MeasurementReport</i>	1	P
8	SS re-adjusts the cell-specific reference signal level according to row " T3" in table 8.3.1.22.1.3.2-1.	-	-	-	-
9	Wait and ignore <i>MeasurementReport</i> messages for 15 s to allow change of power levels for Cell 3 and UE measurement.	-	-	-	-
10	Check: Does the UE attempt to transmit an uplink message within the next 10s?	-	-	2	F
10A	SS transmits an <i>RRCCONNECTIONRECONFIGURATION</i> message including <i>measConfig</i> to remove intra LTE measurement and reporting for event A1 (measurements considered for the SCell (Cell 3)).	<--	<i>RRCCONNECTIONRECONFIGURATION</i>	-	-
10B	The UE transmits an <i>RRCCONNECTIONRECONFIGURATIONCOMPLETE</i> message.	-->	<i>RRCCONNECTIONRECONFIGURATIONCOMPLETE</i>	-	-
11	The SS changes power level according to row "T4" in Table 8.3.1.22.1.3.2-1.	-	-	-	-
12	SS transmits an <i>RRCCONNECTIONRECONFIGURATION</i> message including <i>measConfig</i> to setup intra LTE measurement and reporting for event A2 (measurements considered for the SCell (Cell 3)).	<--	<i>RRCCONNECTIONRECONFIGURATION</i>	-	-
13	The UE transmits an <i>RRCCONNECTIONRECONFIGURATIONCOMPLETE</i> message.	-->	<i>RRCCONNECTIONRECONFIGURATIONCOMPLETE</i>	-	-
14	SS re-adjusts the cell-specific reference signal level according to row "T5" in table 8.3.1.22.1.3.2-1.	-	-	-	-
15	Check: Does the UE transmit a <i>MeasurementReport</i> message to report event	-->	<i>MeasurementReport</i>	3	P

	A2 with the measured RSRP and RSRQ value (measurements considered for the Scell (Cell 3))?				
-	EXCEPTION: Step 5 below is repeated until 3 <i>MeasurementReport</i> messages are received from the UE	-	-	-	-
16	Check: Does the UE transmit a <i>MeasurementReport</i> message to report event A2 with the measured RSRP and RSRQ value (measurements considered for the Scell (Cell 3))?	-->	<i>MeasurementReport</i>	3	P
17	SS re-adjusts the cell-specific reference signal level according to row "T6" in table 8.3.1.22.1.3.2-1.	-	-	-	-
18	Wait and ignore <i>MeasurementReport</i> messages for 15 s to allow change of power levels for Cell 3 and UE measurement.	-	-	-	-
19	Check: Does the UE attempt to transmit an uplink message within the next 10s?	-		4	F

8.3.1.22.1.3.3 Specific message contents

Table 8.3.1.22.1.3.3-1: *RRCConnectionReconfiguration* (step 1, Table 8.3.1.22.1.3.2-2)

Derivation Path: 36.508 Table 4.6.1-8, condition SCell_AddMod

Table 8.3.1.22.1.3.3-2: *SCellToAddMod-r10* (Table 8.3.1.22.1.3.3-1)

Derivation Path: 36.508, Table 4.6.3-19D			
Information Element	Value/remark	Comment	Condition
SCellToAddMod-r10 ::= SEQUENCE {			
sCellIndex-r10	1		
cellIdentification-r10 SEQUENCE {			
physCellId-r10	PhysicalCellIdentity of Cell 3		
dl-CarrierFreq-r10	Same downlink EARFCN as used for Cell 3		
}			
}			

Table 8.3.1.22.1.3.3-3: *RadioResourceConfigCommonSCell-r10* (Table 8.3.1.22.1.3.3-2)

Derivation Path: 36.508, Table 4.6.3-13A			
Information Element	Value/remark	Comment	Condition
RadioResourceConfigCommonSCell-r10 ::= SEQUENCE {			
nonUL-Configuration-r10 SEQUENCE {			
dl-Bandwidth-r10	Same downlink system bandwidth as used for Cell 3		
}			
}			

Table 8.3.1.22.1.3.3-3A: *RRCConnectionReconfiguration* (step 3 and step 12, Table 8.3.1.22.1.3.2-2)

Derivation Path: 36.508 clause 4.6.1 table 4.6.1-8 with condition MEAS

Table 8.3.1.22.1.3.3-4: *MeasConfig* (step 3, Table 8.3.1.22.1.3.2-2)

Derivation path: 36.508 clause 4.6.6 table 4.6.6-1			
Information Element	Value/Remark	Comment	Condition
measConfig ::= SEQUENCE {			
measObjectToAddModList SEQUENCE (SIZE (1..maxObjectId)) OF SEQUENCE {	2 entries		
measObjectId[1]	IdMeasObject-f1		
measObject[1]	MeasObjectEUTRA-GENERIC(f1)	Cell 1	
measObjectId[2]	IdMeasObject-f2		
measObject[2]	MeasObjectEUTRA-GENERIC(f2)	Cell 3	
}			
reportConfigToAddModList SEQUENCE (SIZE (1..maxReportConfigId)) OF SEQUENCE {	1 entry		
reportConfigId[1]	IdReportConfig-A1		
reportConfig[1]	ReportConfig-A1-(-72)		
}			
measIdToAddModList SEQUENCE (SIZE (1..maxMeasId)) OF SEQUENCE {	1 entry		
measId[1]	1		
measObjectId[1]	IdMeasObject-f2		
reportConfigId[1]	IdReportConfig-A1		
}			
}			

Table 8.3.1.22.1.3.3-5: *ReportConfig-A1-(-72)* (Table 8.3.1.22.1.3.3-4)

Derivation path: 36.508 clause 4.6.6 table 4.6.6-4			
Information Element	Value/Remark	Comment	Condition
ReportConfigEUTRA ::= SEQUENCE {			
triggerType CHOICE {			
event SEQUENCE {			
hysteresis	6	3dB	
}			
}			
reportAmount	infinity		
}			

Table 8.3.1.22.1.3.3-6: MeasurementReport (steps 6 and 7, Table 8.3.1.22.1.3.2-2)

Derivation path: 36.508 4.6.1 table 4.6.1-5			
Information Element	Value/Remark	Comment	Condition
MeasurementReport ::= SEQUENCE {			
criticalExtensions CHOICE {			
c1 CHOICE {			
measurementReport-r8 SEQUENCE {			
measResults ::= SEQUENCE {			
measId	1		
measResultPCell ::= SEQUENCE {		Report Cell 1	
rsrpResult	(0..97)		
rsrqResult	(0..34)		
}			
measResultForECID-r9	Not present		
locationInfo-r10	Not present		
measResultServFreqList-r10 SEQUENCE (SIZE (1..maxServCell-r10)) OF SEQUENCE {			
servFreqId-r10	1		
measResultSCell-r10 SEQUENCE {		Cell 3	
rsrpResultSCell-r10	(0..97)		
rsrqResultSCell-r10	(0..34)		
}			
}			
}			
}			
}			
}			

Table 8.3.1.22.1.3.3-7: MeasConfig (step 10A, Table 8.3.1.22.1.3.2-2)

Derivation path: 36.508 clause 4.6.6 table 4.6.6-1			
Information Element	Value/Remark	Comment	Condition
measConfig ::= SEQUENCE {			
reportConfigToRemoveList ::= SEQUENCE (SIZE (1..maxReportConfigId)) OF SEQUENCE {	1 entry		
reportConfigId	IdReportConfig-A1		
}			
}			

Table 8.3.1.22.1.3.3-8: MeasConfig (step 12, Table 8.3.1.22.1.3.2-2)

Derivation path: 36.508 clause 4.6.6 table 4.6.6-1			
Information Element	Value/Remark	Comment	Condition
measConfig ::= SEQUENCE {			
reportConfigToAddModList SEQUENCE (SIZE (1..maxReportConfigId)) OF SEQUENCE {	1 entry		
reportConfigId[1]	IdReportConfig-A2		
reportConfig[1]	ReportConfig-A2-(-83)		
}			
measIdToAddModList SEQUENCE (SIZE (1..maxMeasId)) OF SEQUENCE {	1 entry		
measId[1]	1		
measObjectId[1]	IdMeasObject-f2		
reportConfigId[1]	IdReportConfig-A2		
}			
}			

Table 8.3.1.22.1.3.3-9: ReportConfig-A2(-83) (Table 8.3.1.22.1.3.3-8)

Derivation path: 36.508 clause 4.6.6 table 4.6.6-5			
Information Element	Value/Remark	Comment	Condition
ReportConfigEUTRA ::= SEQUENCE {			
triggerType CHOICE {			
event SEQUENCE {			
hysteresis	6	3 dB	
}			
}			
reportAmount	infinity		
}			

Table 8.3.1.22.1.3.3-10: MeasurementReport (steps 15 and 16, Table 8.3.1.22.1.3.2-2)

Derivation path: 36.508 4.6.1 table 4.6.1-5			
Information Element	Value/Remark	Comment	Condition
MeasurementReport ::= SEQUENCE {			
criticalExtensions CHOICE {			
c1 CHOICE {			
measurementReport-r8 SEQUENCE {			
measResults ::= SEQUENCE {			
measId	1		
measResultPCell ::= SEQUENCE {		Report Cell 1	
rsrpResult	(0..97)		
rsrqResult	(0..34)		
}			
measResultForECID-r9	Not present		
locationInfo-r10	Not present		
measResultServFreqList-r10 SEQUENCE (SIZE (1..maxServCell-r10)) OF SEQUENCE {			
servFreqId-r10	1		
measResultSCell-r10 SEQUENCE {		Cell 3	
rsrpResultSCell-r10	(0..97)		
rsrqResultSCell-r10	(0..34)		
}			
}			
}			
}			
}			

8.3.1.22.2 CA / Measurement configuration control and reporting / Intra E-UTRAN measurements / Event A1 / Event A2 / Inter-band CA

8.3.1.22.2.1 Test Purpose (TP)

Same as TC 8.3.1.22.1 but applied to Inter-band CA case.

8.3.1.22.2.2 Conformance requirements

Same as TC 8.3.1.22.1 but applied to Inter-band CA case.

8.3.1.22.2.3 Test description

8.3.1.22.2.3.1 Pre-test conditions

Same as test case 8.3.1.22.1 with the following differences:

- CA configuration: Inter-band CA replaces Inter-band Contiguous CA
- Cells configuration: Cell 10 replaces Cell 3
- Cell 10 is an Inactive SCell according to [18] cl. 6.3.4

8.3.1.22.2.3.2 Test procedure sequence

Same as test case 8.3.1.22.1 with the following differences:

- CA configuration: Inter-band CA replaces Inter-band Contiguous CA
- Cells configuration: Cell 10 replaces Cell 3

8.3.1.22.2.3.3 Specific message contents

Same as test case 8.3.1.22.1 with the following differences.

NOTE: For simplicity the steps referred below are steps in test case 8.3.1.22.1.

Table 8.3.1.12.2.3.3-2: MeasConfig (step 3, Table 8.3.1.22.1.3.2-2)

Derivation path: 36.508 clause 4.6.6 table 4.6.6-1			
Information Element	Value/Remark	Comment	Condition
measConfig ::= SEQUENCE {			
measObjectToAddModList SEQUENCE (SIZE (1..maxObjectId)) OF SEQUENCE {	2 Entries		
measObjectId[1]	IdMeasObject-f1		
measObject[1]	MeasObjectEUTRA-GENERIC(f1)	Cell1	
measObjectId[2]	IdMeasObject-f5		
measObject[2]	MeasObjectEUTRA-GENERIC(f5)	Cell 10	
}			
reportConfigToAddModList SEQUENCE (SIZE (1..maxReportConfigId)) OF SEQUENCE {	1 entry		
reportConfigId[1]	IdReportConfig-A1		
reportConfig[1]	ReportConfig-A1-H		
}			
measIdToAddModList SEQUENCE (SIZE (1..maxMeasId)) OF SEQUENCE {	1 entry		
measId[1]	1		
measObjectId[1]	IdMeasObject-f5		
reportConfigId[1]	IdReportConfig-A1		
}			
}			

Table 8.3.1.22.2.3.3-2: MeasConfig (step 12, Table 8.3.1.22.1.3.2-2)

Derivation path: 36.508 clause 4.6.6 table 4.6.6-1			
Information Element	Value/Remark	Comment	Condition
measConfig ::= SEQUENCE {			
reportConfigToAddModList SEQUENCE (SIZE (1..maxReportConfigId)) OF SEQUENCE {	1 entry		
reportConfigId[1]	IdReportConfig-A2		
reportConfig[1]	ReportConfig-A2-H		
}			
measIdToAddModList SEQUENCE (SIZE (1..maxMeasId)) OF SEQUENCE {	1 entry		
measId[1]	1		
measObjectId[1]	IdMeasObject-f5		
reportConfigId[1]	IdReportConfig-A2		
}			
}			

8.3.1.23 Measurement configuration control and reporting / Intra E-UTRAN measurements / Event A4

8.3.1.23.1 Test Purpose (TP)

(1)

```
with { UE in E-UTRA RRC_CONNECTED state and measurement configured for event A4 with event based
periodical reporting }
ensure that {
  when { Neighbour cell becomes better than absolute threshold }
  then { UE sends MeasurementReport message at regular intervals while entering condition for
event A4 is satisfied }
}
```

(2)

```
with { UE in E-UTRA RRC_CONNECTED state and periodical measurement reporting triggered by event A4
ongoing }
ensure that {
  when { Neighbour cell becomes worse than absolute threshold }
  then { UE stops sending MeasurementReport message }
}
```

8.3.1.23.2 Conformance requirements

References: The conformance requirements covered in the current TC are specified in: TS 36.331, clauses 5.3.5.3, 5.5.4.1, 5.5.4.5 and 5.5.5.

[TS 36.331, clause 5.3.5.3]

If the *RRConnectionReconfiguration* message does not include the *mobilityControlInfo* and the UE is able to comply with the configuration included in this message, the UE shall:

...

- 1> if the *RRConnectionReconfiguration* message includes the *measConfig*:
- 2> perform the measurement configuration procedure as specified in 5.5.2;

[TS 36.331, clause 5.5.4.1]

The UE shall:

- 1> for each *measId* included in the *measIdList* within *VarMeasConfig*:

...

- 2> else:
 - 3> if the corresponding *measObject* concerns E-UTRA:
 - 4> if the *ue-RxTxTimeDiffPeriodical*, *eventA1* or *eventA2* is configured in the corresponding *reportConfig*:
 - 5> consider only the serving cell to be applicable;
 - 4> else:
 - 5> consider any neighbouring cell detected on the associated frequency to be applicable when the concerned cell is not included in the *blackCellsToAddModList* defined within the *VarMeasConfig* for this *measId*;

...

- 2> if the *triggerType* is set to 'event' and if the entry condition applicable for this event, i.e. the event corresponding with the *eventId* of the corresponding *reportConfig* within *VarMeasConfig*, is fulfilled for one or more applicable cells for all measurements after layer 3 filtering taken during *timeToTrigger* defined for

this event within the *VarMeasConfig*, while the *VarMeasReportList* does not include an measurement reporting entry for this *measId* (a first cell triggers the event):

- 3> include a measurement reporting entry within the *VarMeasReportList* for this *measId*;
 - 3> set the *numberOfReportsSent* defined within the *VarMeasReportList* for this *measId* to 0;
 - 3> include the concerned cell(s) in the *cellsTriggeredList* defined within the *VarMeasReportList* for this *measId*;
 - 3> initiate the measurement reporting procedure, as specified in 5.5.5;
- 2> if the *triggerType* is set to 'event' and if the entry condition applicable for this event, i.e. the event corresponding with the *eventId* of the corresponding *reportConfig* within *VarMeasConfig*, is fulfilled for one or more applicable cells not included in the *cellsTriggeredList* for all measurements after layer 3 filtering taken during *timeToTrigger* defined for this event within the *VarMeasConfig* (a subsequent cell triggers the event):
- 3> set the *numberOfReportsSent* defined within the *VarMeasReportList* for this *measId* to 0;
 - 3> include the concerned cell(s) in the *cellsTriggeredList* defined within the *VarMeasReportList* for this *measId*;
 - 3> initiate the measurement reporting procedure, as specified in 5.5.5;
- 2> if the *triggerType* is set to 'event' and if the leaving condition applicable for this event is fulfilled for one or more of the cells included in the *cellsTriggeredList* defined within the *VarMeasReportList* for this *measId* for all measurements after layer 3 filtering taken during *timeToTrigger* defined within the *VarMeasConfig* for this event:
- 3> remove the concerned cell(s) in the *cellsTriggeredList* defined within the *VarMeasReportList* for this *measId*;
 - 3> if *reportOnLeave* is set to *TRUE* for the corresponding reporting configuration:
 - 4> initiate the measurement reporting procedure, as specified in 5.5.5;
 - 3> if the *cellsTriggeredList* defined within the *VarMeasReportList* for this *measId* is empty:
 - 4> remove the measurement reporting entry within the *VarMeasReportList* for this *measId*;
 - 4> stop the periodical reporting timer for this *measId*, if running;
- ...
- 2> upon expiry of the periodical reporting timer for this *measId*:
- 3> initiate the measurement reporting procedure, as specified in 5.5.5;
- ...

NOTE 2: The UE does not stop the periodical reporting with *triggerType* set to 'event' or to 'periodical' while the corresponding measurement is not performed due to the serving cell RSRP being equal to or better than *s-Measure* or due to the measurement gap not being setup.

[TS 36.331, clause 5.5.4.5]

The UE shall:

- 1> consider the entering condition for this event to be satisfied when condition A4-1, as specified below, is fulfilled;
- 1> consider the leaving condition for this event to be satisfied when condition A4-2, as specified below, is fulfilled;

Inequality A4-1 (Entering condition)

$$Mn + Ofn + Ocn - Hys > Thresh$$

Inequality A4-2 (Leaving condition)

$$Mn + Ofn + Ocn + Hys < Thresh$$

The variables in the formula are defined as follows:

Mn is the measurement result of the neighbouring cell, not taking into account any offsets.

Ofn is the frequency specific offset of the frequency of the neighbour cell (i.e. *offsetFreq* as defined within *measObjectEUTRA* corresponding to the frequency of the neighbour cell).

Ocn is the cell specific offset of the neighbour cell (i.e. *cellIndividualOffset* as defined within *measObjectEUTRA* corresponding to the frequency of the neighbour cell), and set to zero if not configured for the neighbour cell.

Hys is the hysteresis parameter for this event (i.e. *hysteresis* as defined within *reportConfigEUTRA* for this event).

Thresh is the threshold parameter for this event (i.e. *a4-Threshold* as defined within *reportConfigEUTRA* for this event).

Mn is expressed in dBm in case of RSRP, or in dB in case of RSRQ.

Ofn, Ocn, Hys are expressed in dB.

Thresh is expressed in the same unit as **Ms**.

[TS 36.331, clause 5.5.5]

For the *measId* for which the measurement reporting procedure was triggered, the UE shall set the *measResults* within the *MeasurementReport* message as follows:

- 1> set the *measId* to the measurement identity that triggered the measurement reporting;
 - 1> set the *measResultServCell* to include the quantities of serving cell;
 - 1> if there is at least one applicable neighbouring cell to report:
 - 2> set the *measResultNeighCells* to include the best neighbouring cells up to *maxReportCells* in accordance with the following:
 - 3> if the *triggerType* is set to 'event':
 - 4> include the cells included in the *cellsTriggeredList* as defined within the *VarMeasReportList* for this *measId*;
 - 3> else:
 - 4> include the applicable cells for which the new measurement results became available since the last periodical reporting or since the measurement was initiated or reset;
- NOTE: The reliability of the report (i.e. the certainty it contains the strongest cells on the concerned frequency) depends on the measurement configuration i.e. the *reportInterval*. The related performance requirements are specified in TS 36.133 [16].
- 3> for each cell that is included in the *measResultNeighCells*, include the *physCellId*;
 - 3> if the *triggerType* is set to 'event'; or the *purpose* is set to 'reportStrongestCells' or to 'reportStrongestCellsForSON':
 - 4> for each included cell, include the layer 3 filtered measured results in accordance with the *reportConfig* for this *measId*, ordered as follows:
 - 5> if the *measObject* associated with this *measId* concerns E-UTRA:
 - 6> set the *measResult* to include the quantity(ies) indicated in the *reportQuantity* within the concerned *reportConfig* in order of decreasing *triggerQuantity*, i.e. the best cell is included first;

...

- 1> increment the *numberOfReportsSent* as defined within the *VarMeasReportList* for this *measId* by 1;
- 1> stop the periodical reporting timer, if running;
- 1> if the *numberOfReportsSent* as defined within the *VarMeasReportList* for this *measId* is less than the *reportAmount* as defined within the corresponding *reportConfig* for this *measId*:
 - 2> start the periodical reporting timer with the value of *reportInterval* as defined within the corresponding *reportConfig* for this *measId*;

...

- 1> submit the *MeasurementReport* message to lower layers for transmission, upon which the procedure ends;

8.3.1.23.3 Test description

8.3.1.23.3.1 Pre-test conditions

System Simulator:

- Cell 1 and Cell 2.

UE:

None.

Preamble:

- The UE is in state Generic RB Established (state 3) on Cell 1 according to [18].

8.3.1.23.3.2 Test procedure sequence

Table 8.3.1.23.3.2-1 illustrates the downlink power levels to be applied for Cell 1 and Cell 2 at various time instants of the test execution. Row marked "T0" denotes the initial conditions after preamble, while rows marked "T1" and "T2" are to be applied subsequently. The exact instants on which these values shall be applied are described in the texts in this clause.

Table 8.3.1.23.3.2-1: Power levels

	Parameter	Unit	Cell 1	Cell 2	Remark
T0	Cell-specific RS EPRE	dBm/15 kHz	-85	-97	Power levels are such that entry condition for event A4 is not satisfied: $Mn + Ofn + Ocn - Hys < Thresh$
T1	Cell-specific RS EPRE	dBm/15 kHz	-85	-79	Power levels are such that entry condition for event A4 is satisfied: $Mn + Ofn + Ocn - Hys > Thresh$
T2	Cell-specific RS EPRE	dBm/15 kHz	-85	-97	Power levels are such that entry condition for event A4 is not satisfied: $Mn + Ofn + Ocn - Hys < Thresh$

Table 8.3.1.23.3.2-2: Main behaviour

St	Procedure	Message Sequence		TP	Verdict
		U - S	Message		
1	SS transmits an <i>RRConnectionReconfiguration</i> message including measConfig to setup intra LTE measurement and reporting for event A4 on Cell 1.	<--	<i>RRConnectionReconfiguration</i>	-	-
2	The UE transmits an <i>RRConnectionReconfigurationComplete</i> message on Cell 1.	-->	<i>RRConnectionReconfigurationComplete</i>	-	-
3	Check: Does the UE attempt to transmit an uplink message within the next 30s?	-	-	2	F
4	SS re-adjusts the cell-specific reference signal level according to row "T1" in table 8.3.1.23.3.2-1.	-	-	-	-
5	Check: Does the UE transmit a <i>MeasurementReport</i> message on Cell 1 to report event A4 with the measured RSRP and RSRQ value for Cell 2?	-->	<i>MeasurementReport</i>	1	P
-	EXCEPTION: Step 6 below is repeated until 3 <i>MeasurementReport</i> messages are received from the UE	-	-	-	-
6	Check: Does the UE transmit a <i>MeasurementReport</i> message on Cell 1, with the measured RSRP and RSRQ value for Cell 2?	-->	<i>MeasurementReport</i>	1	P
7	SS re-adjusts the cell-specific reference signal level according to row "T2" in table 8.3.1.23.3.2-1.	-	-	-	-
8	Wait and ignore <i>MeasurementReport</i> messages for 15 s to allow change of power levels for Cell 2 and UE measurement.	-	-	-	-
9	Check: Does the UE attempt to transmit an uplink message within the next 10s?	-	-	2	F

8.3.1.23.3.3 Specific message contents

Table 8.3.1.23.3.3-1: *RRConnectionReconfiguration* (step 1, Table 8.3.1.23.3.2-2)

Derivation Path: 36.508 Table 4.6.1-8 with condition MEAS

Table 8.3.1.23.3.3-2: MeasConfig (step 1, Table 8.3.1.23.3.2-2)

Derivation Path: 36.508, Table 4.6.6-1			
Information Element	Value/remark	Comment	Condition
MeasConfig ::= SEQUENCE {			
measObjectToAddModList SEQUENCE (SIZE (1..maxObjectId)) OF SEQUENCE{	1 entry		
measObjectId[1]	IdMeasObject-f1		
measObject[1]	MeasObjectEUTRA-GENERIC(f1)		
}			
reportConfigToAddModList SEQUENCE (SIZE (1..maxReportConfigId)) OF SEQUENCE {	1 entry		
reportConfigId[1]	IdReportConfig-A4		
reportConfig[1]	ReportConfigEUTRA-A4-RECONF		
}			
measIdToAddModList SEQUENCE (SIZE (1..maxMeasId)) OF SEQUENCE {	1 entry		
measId[1]	1		
measObjectId[1]	IdMeasObject-f1		
reportConfigId[1]	IdReportConfig-A4		
}			
}			

Table 8.3.1.23.3.3-3: ReportConfigEUTRA-A4-RECONF (step 1, Table 8.3.1.23.3.2-2)

Derivation Path: 36.508, Table 4.6.6-6AA ReportConfigEUTRA-A4(-88)			
Information Element	Value/remark	Comment	Condition
ReportConfigEUTRA ::= SEQUENCE {			
reportAmount	infinity		
}			

Table 8.3.1.23.3.3-4: *MeasurementReport* (step 5 and 6, Table 8.3.1.23.3.2-2)

Derivation Path: 36.508, Table 4.6.1-5			
Information Element	Value/remark	Comment	Condition
MeasurementReport ::= SEQUENCE {			
criticalExtensions CHOICE {			
c1 CHOICE{			
measurementReport-r8 SEQUENCE {			
measResults SEQUENCE {			
measId	1		
measResultServCell SEQUENCE {		Report Cell 1	
rsrpResult	(0..97)		
rsrqResult	(0..34)		
}			
measResultNeighCells CHOICE {			
measResultListEUTRA SEQUENCE (SIZE (1..maxCellReport)) OF SEQUENCE {	1 entry	Report Cell 2	
physCellId[1]	PhysicalCellIdentity of Cell 2		
cgi-Info[1]	Not present		
measResult[1] SEQUENCE {			
rsrpResult	(0..97)		
rsrqResult	(0..34)		
additionalSI-Info-r9	Not present		
}			
}			
}			
measResultForECID-r9	Not present		
}			
}			
}			

8.3.1.24 Measurement configuration control and reporting / Intra E-UTRAN measurements / Event A5

8.3.1.24.1 Test Purpose (TP)

(1)

```
with { UE in E-UTRA RRC_CONNECTED state and measurement configured for event A5 with event based
periodical reporting }
ensure that {
  when { Serving cell becomes worse than absolute threshold1 and neighbour cell becomes better than
absolute threshold2 }
  then { UE sends MeasurementReport message at regular intervals while entering conditions for
event A5 are satisfied }
}
```

(2)

```
with { UE in E-UTRA RRC_CONNECTED state and periodical measurement reporting triggered by event A5
ongoing }
ensure that {
  when { Serving cell becomes better than absolute threshold1 or neighbour cell becomes worse than
absolute threshold2 }
  then { UE stops sending MeasurementReport message }
}
```

8.3.1.24.2 Conformance requirements

References: The conformance requirements covered in the current TC are specified in: TS 36.331, clauses 5.3.5.3, 5.5.4.1, 5.5.4.6 and 5.5.5.

[TS 36.331, clause 5.3.5.3]

If the *RRConnectionReconfiguration* message does not include the *mobilityControlInfo* and the UE is able to comply with the configuration included in this message, the UE shall:

...

- 1> if the *RRConnectionReconfiguration* message includes the *measConfig*:
 - 2> perform the measurement configuration procedure as specified in 5.5.2;

[TS 36.331, clause 5.5.4.1]

The UE shall:

- 1> for each *measId* included in the *measIdList* within *VarMeasConfig*:

...

- 2> else:
 - 3> if the corresponding *measObject* concerns E-UTRA:
 - 4> if the *ue-RxTxTimeDiffPeriodical*, *eventA1* or *eventA2* is configured in the corresponding *reportConfig*:
 - 5> consider only the serving cell to be applicable;
 - 4> else:
 - 5> consider any neighbouring cell detected on the associated frequency to be applicable when the concerned cell is not included in the *blackCellsToAddModList* defined within the *VarMeasConfig* for this *measId*;

...

- 2> if the *triggerType* is set to 'event' and if the entry condition applicable for this event, i.e. the event corresponding with the *eventId* of the corresponding *reportConfig* within *VarMeasConfig*, is fulfilled for one or more applicable cells for all measurements after layer 3 filtering taken during *timeToTrigger* defined for this event within the *VarMeasConfig*, while the *VarMeasReportList* does not include a measurement reporting entry for this *measId* (a first cell triggers the event):
 - 3> include a measurement reporting entry within the *VarMeasReportList* for this *measId*;
 - 3> set the *numberOfReportsSent* defined within the *VarMeasReportList* for this *measId* to 0;
 - 3> include the concerned cell(s) in the *cellsTriggeredList* defined within the *VarMeasReportList* for this *measId*;
 - 3> initiate the measurement reporting procedure, as specified in 5.5.5;
- 2> if the *triggerType* is set to 'event' and if the entry condition applicable for this event, i.e. the event corresponding with the *eventId* of the corresponding *reportConfig* within *VarMeasConfig*, is fulfilled for one or more applicable cells not included in the *cellsTriggeredList* for all measurements after layer 3 filtering taken during *timeToTrigger* defined for this event within the *VarMeasConfig* (a subsequent cell triggers the event):
 - 3> set the *numberOfReportsSent* defined within the *VarMeasReportList* for this *measId* to 0;
 - 3> include the concerned cell(s) in the *cellsTriggeredList* defined within the *VarMeasReportList* for this *measId*;
 - 3> initiate the measurement reporting procedure, as specified in 5.5.5;
- 2> if the *triggerType* is set to 'event' and if the leaving condition applicable for this event is fulfilled for one or more of the cells included in the *cellsTriggeredList* defined within the *VarMeasReportList* for this *measId* for all measurements after layer 3 filtering taken during *timeToTrigger* defined within the *VarMeasConfig* for this event:

3> remove the concerned cell(s) in the *cellsTriggeredList* defined within the *VarMeasReportList* for this *measId*;

3> if *reportOnLeave* is set to *TRUE* for the corresponding reporting configuration:

4> initiate the measurement reporting procedure, as specified in 5.5.5;

3> if the *cellsTriggeredList* defined within the *VarMeasReportList* for this *measId* is empty:

4> remove the measurement reporting entry within the *VarMeasReportList* for this *measId*;

4> stop the periodical reporting timer for this *measId*, if running;

...

2> upon expiry of the periodical reporting timer for this *measId*:

3> initiate the measurement reporting procedure, as specified in 5.5.5;

...

NOTE 2: The UE does not stop the periodical reporting with *triggerType* set to 'event' or to 'periodical' while the corresponding measurement is not performed due to the serving cell RSRP being equal to or better than *s-Measure* or due to the measurement gap not being setup.

[TS 36.331, clause 5.5.4.6]

The UE shall:

1> consider the entering condition for this event to be satisfied when both conditions A5-1 and condition A5-2, as specified below, are fulfilled;

1> consider the leaving condition for this event to be satisfied when condition A5-3 or condition A5-4, i.e. at least one of the two, as specified below, is fulfilled;

Inequality A5-1 (Entering condition 1)

$$Ms + Hys < Thresh1$$

Inequality A5-2 (Entering condition 2)

$$Mn + Ofn + Ocn - Hys > Thresh2$$

Inequality A5-3 (Leaving condition 1)

$$Ms - Hys > Thresh1$$

Inequality A5-4 (Leaving condition 2)

$$Mn + Ofn + Ocn + Hys < Thresh2$$

The variables in the formula are defined as follows:

Ms is the measurement result of the serving cell, not taking into account any offsets.

Mn is the measurement result of the neighbouring cell, not taking into account any offsets.

Ofn is the frequency specific offset of the frequency of the neighbour cell (i.e. *offsetFreq* as defined within *measObjectEUTRA* corresponding to the frequency of the neighbour cell).

Ocn is the cell specific offset of the neighbour cell (i.e. *cellIndividualOffset* as defined within *measObjectEUTRA* corresponding to the frequency of the neighbour cell), and set to zero if not configured for the neighbour cell.

Hys is the hysteresis parameter for this event (i.e. *hysteresis* as defined within *reportConfigEUTRA* for this event).

Thresh1 is the threshold parameter for this event (i.e. *a5-Threshold1* as defined within *reportConfigEUTRA* for this event).

Thresh2 is the threshold parameter for this event (i.e. *a5-Threshold2* as defined within *reportConfigEUTRA* for this event).

Mn, Ms are expressed in dBm in case of RSRP, or in dB in case of RSRQ.

Ofn, Ocn, Hys are expressed in dB.

Thresh1 is expressed in the same unit as **Ms**.

Thresh2 is expressed in the same unit as **Mn**.

[TS 36.331, clause 5.5.5]

For the *measId* for which the measurement reporting procedure was triggered, the UE shall set the *measResults* within the *MeasurementReport* message as follows:

- 1> set the *measId* to the measurement identity that triggered the measurement reporting;
- 1> set the *measResultServCell* to include the quantities of serving cell;
- 1> if there is at least one applicable neighbouring cell to report:
 - 2> set the *measResultNeighCells* to include the best neighbouring cells up to *maxReportCells* in accordance with the following:
 - 3> if the *triggerType* is set to 'event':
 - 4> include the cells included in the *cellsTriggeredList* as defined within the *VarMeasReportList* for this *measId*;
 - 3> else:
 - 4> include the applicable cells for which the new measurement results became available since the last periodical reporting or since the measurement was initiated or reset;

NOTE: The reliability of the report (i.e. the certainty it contains the strongest cells on the concerned frequency) depends on the measurement configuration i.e. the *reportInterval*. The related performance requirements are specified in TS 36.133 [16].

- 3> for each cell that is included in the *measResultNeighCells*, include the *physCellId*;
- 3> if the *triggerType* is set to 'event'; or the *purpose* is set to 'reportStrongestCells' or to 'reportStrongestCellsForSON':
 - 4> for each included cell, include the layer 3 filtered measured results in accordance with the *reportConfig* for this *measId*, ordered as follows:
 - 5> if the *measObject* associated with this *measId* concerns E-UTRA:
 - 6> set the *measResult* to include the quantity(ies) indicated in the *reportQuantity* within the concerned *reportConfig* in order of decreasing *triggerQuantity*, i.e. the best cell is included first;

...

- 1> increment the *numberOfReportsSent* as defined within the *VarMeasReportList* for this *measId* by 1;
- 1> stop the periodical reporting timer, if running;
- 1> if the *numberOfReportsSent* as defined within the *VarMeasReportList* for this *measId* is less than the *reportAmount* as defined within the corresponding *reportConfig* for this *measId*:
 - 2> start the periodical reporting timer with the value of *reportInterval* as defined within the corresponding *reportConfig* for this *measId*;

...

- 1> submit the *MeasurementReport* message to lower layers for transmission, upon which the procedure ends;

8.3.1.24.3 Test description

8.3.1.24.3.1 Pre-test conditions

System Simulator:

- Cell 1 and Cell 2.

UE:

None.

Preamble:

- The UE is in state Generic RB Established (state 3) on Cell 1 according to [18].

8.3.1.24.3.2 Test procedure sequence

Table 8.3.1.24.3.2-1 illustrates the downlink power levels to be applied for Cell 1 and Cell 2 at various time instants of the test execution. Row marked "T0" denotes the initial conditions after preamble, while rows marked "T1" and "T2" are to be applied subsequently. The exact instants on which these values shall be applied are described in the texts in this clause.

Table 8.3.1.24.3.2-1: Power levels

	Parameter	Unit	Cell 1	Cell 2	Remark
T0	Cell-specific RS EPRE	dBm/15 kHz	-85	-97	Power levels are such that entry condition for event A5 is not satisfied: $Ms - Hys > Thresh1$ or $Mn + Ofn + Ocn + Hys < Thresh2$
T1	Cell-specific RS EPRE	dBm/15 kHz	-85	-79	Power levels are such that entry condition for event A5 is satisfied: $Ms + Hys < Thresh1$ and $Mn + Ofn + Ocn - Hys > Thresh2$
T2	Cell-specific RS EPRE	dBm/15 kHz	-65	-79	Power levels are such that entry condition for event A5 is not satisfied: $Ms - Hys > Thresh1$ or $Mn + Ofn + Ocn + Hys < Thresh2$

Table 8.3.1.24.3.2-2: Main behaviour

St	Procedure	Message Sequence		TP	Verdict
		U - S	Message		
1	SS transmits an <i>RRConnectionReconfiguration</i> message including measConfig to setup intra LTE measurement and reporting for event A5 on Cell 1.	<--	<i>RRConnectionReconfiguration</i>	-	-
2	The UE transmits an <i>RRConnectionReconfigurationComplete</i> message on Cell 1.	-->	<i>RRConnectionReconfigurationComplete</i>	-	-
3	Check: Does the UE attempt to transmit an uplink message within the next 30s?	-	-	2	F
4	SS re-adjusts the cell-specific reference signal level according to row "T1" in table 8.3.1.24.3.2-1.	-	-	-	-
5	Check: Does the UE transmit a <i>MeasurementReport</i> message on Cell 1 to report event A5 with the measured RSRP and RSRQ value for Cell 2?	-->	<i>MeasurementReport</i>	1	P
-	EXCEPTION: Step 6 below is repeated until 3 <i>MeasurementReport</i> messages are received from the UE	-	-	-	-
6	Check: Does the UE transmit a <i>MeasurementReport</i> message on Cell 1, with the measured RSRP and RSRQ value for Cell 2?	-->	<i>MeasurementReport</i>	1	P
7	SS re-adjusts the cell-specific reference signal level according to row "T2" in table 8.3.1.24.3.2-1.	-	-	-	-
8	Wait and ignore <i>MeasurementReport</i> messages for 15 s to allow change of power levels for Cell 2 and UE measurement.	-	-	-	-
9	Check: Does the UE attempt to transmit an uplink message within the next 10s?	-	-	2	F

8.3.1.24.3.3 Specific message contents

Table 8.3.1.24.3.3-1: *RRConnectionReconfiguration* (step 1, Table 8.3.1.24.3.2-2)

Derivation Path: 36.508 Table 4.6.1-8 with condition MEAS

Table 8.3.1.24.3.3-2: MeasConfig (step 1, Table 8.3.1.24.3.2-2)

Derivation Path: 36.508, Table 4.6.1-1			
Information Element	Value/remark	Comment	Condition
MeasConfig ::= SEQUENCE {			
measObjectToAddModList SEQUENCE (SIZE (1..maxObjectId)) OF SEQUENCE{	1 entry		
measObjectId[1]	IdMeasObject-f1		
measObject[1]	MeasObjectEUTRA-GENERIC(f1)		
}			
reportConfigToAddModList SEQUENCE (SIZE (1..maxReportConfigId)) OF SEQUENCE {	1 entry		
reportConfigId[1]	IdReportConfig-A5		
reportConfig[1]	ReportConfigEUTRA-A5-RECONF		
}			
measIdToAddModList SEQUENCE (SIZE (1..maxMeasId)) OF SEQUENCE {	1 entry		
measId[1]	1		
measObjectId[1]	IdMeasObject-f1		
reportConfigId[1]	IdReportConfig-A5		
}			
}			

Table 8.3.1.24.3.3-3: ReportConfigEUTRA-A5-RECONF (step 1, Table 8.3.1.24.3.2-2)

Derivation Path: 36.508, Table 4.6.6-6AB ReportConfigEUTRA-A5(-76, -88)			
Information Element	Value/remark	Comment	Condition
ReportConfigEUTRA ::= SEQUENCE {			
reportAmount	infinity		
}			

Table 8.3.1.24.3.3-4: *MeasurementReport* (step 5 and 6, Table 8.3.1.24.3.2-2)

Derivation Path: 36.508, Table 4.6.1-5			
Information Element	Value/remark	Comment	Condition
MeasurementReport ::= SEQUENCE {			
criticalExtensions CHOICE {			
c1 CHOICE{			
measurementReport-r8 SEQUENCE {			
measResults SEQUENCE {			
measId	1		
measResultServCell SEQUENCE {		Report Cell 1	
rsrpResult	(0..97)		
rsrqResult	(0..34)		
}			
measResultNeighCells CHOICE {			
measResultListEUTRA SEQUENCE (SIZE (1..maxCellReport)) OF SEQUENCE {	1 entry	Report Cell 2	
physCellId[1]	PhysicalCellIdentity of Cell 2		
cgi-Info[1]	Not present		
measResult[1] SEQUENCE {			
rsrpResult	(0..97)		
rsrqResult	(0..34)		
additionalSI-Info-r9	Not present		
}			
}			
}			
measResultForECID-r9	Not present		
}			
}			

8.3.1.25 Measurement configuration control and reporting / Intra E-UTRAN measurements / Event A5 / RSRQ based measurements

8.3.1.25.1 Test Purpose (TP)

(1)

```
with { UE in E-UTRA RRC_CONNECTED state and measurement configured for event A5 with event based
periodical reporting and triggerQuantity set to rsrq }
ensure that {
  when { Serving cell becomes worse than absolute threshold1 and neighbour cell becomes better than
absolute threshold2 }
  then { UE sends MeasurementReport message at regular intervals while entering conditions for
event A5 are satisfied }
}
```

(2)

```
with { UE in E-UTRA RRC_CONNECTED state and periodical measurement reporting triggered by event A5
ongoing and triggerQuantity set to rsrq }
ensure that {
  when { Serving cell becomes better than absolute threshold1 or neighbour cell becomes worse than
absolute threshold2 }
  then { UE stops sending MeasurementReport message }
}
```

8.3.1.25.2 Conformance requirements

References: The conformance requirements covered in the current TC are specified in: TS 36.331, clauses 5.3.5.3, 5.5.4.1, 5.5.4.6 and 5.5.5.

[TS 36.331, clause 5.3.5.3]

If the *RRCCConnectionReconfiguration* message does not include the *mobilityControlInfo* and the UE is able to comply with the configuration included in this message, the UE shall:

...

- 1> if the *RRCCConnectionReconfiguration* message includes the *measConfig*:
 - 2> perform the measurement configuration procedure as specified in 5.5.2;

[TS 36.331, clause 5.5.4.1]

The UE shall:

- 1> for each *measId* included in the *measIdList* within *VarMeasConfig*:

...

- 2> else:
 - 3> if the corresponding *measObject* concerns E-UTRA:
 - 4> if the *ue-RxTxTimeDiffPeriodical*, *eventA1* or *eventA2* is configured in the corresponding *reportConfig*:
 - 5> consider only the serving cell to be applicable;
 - 4> else:
 - 5> consider any neighbouring cell detected on the associated frequency to be applicable when the concerned cell is not included in the *blackCellsToAddModList* defined within the *VarMeasConfig* for this *measId*;

...

- 2> if the *triggerType* is set to 'event' and if the entry condition applicable for this event, i.e. the event corresponding with the *eventId* of the corresponding *reportConfig* within *VarMeasConfig*, is fulfilled for one or more applicable cells for all measurements after layer 3 filtering taken during *timeToTrigger* defined for this event within the *VarMeasConfig*, while the *VarMeasReportList* does not include a measurement reporting entry for this *measId* (a first cell triggers the event):
 - 3> include a measurement reporting entry within the *VarMeasReportList* for this *measId*;
 - 3> set the *numberOfReportsSent* defined within the *VarMeasReportList* for this *measId* to 0;
 - 3> include the concerned cell(s) in the *cellsTriggeredList* defined within the *VarMeasReportList* for this *measId*;
 - 3> initiate the measurement reporting procedure, as specified in 5.5.5;
- 2> if the *triggerType* is set to 'event' and if the entry condition applicable for this event, i.e. the event corresponding with the *eventId* of the corresponding *reportConfig* within *VarMeasConfig*, is fulfilled for one or more applicable cells not included in the *cellsTriggeredList* for all measurements after layer 3 filtering taken during *timeToTrigger* defined for this event within the *VarMeasConfig* (a subsequent cell triggers the event):
 - 3> set the *numberOfReportsSent* defined within the *VarMeasReportList* for this *measId* to 0;
 - 3> include the concerned cell(s) in the *cellsTriggeredList* defined within the *VarMeasReportList* for this *measId*;
 - 3> initiate the measurement reporting procedure, as specified in 5.5.5;
- 2> if the *triggerType* is set to 'event' and if the leaving condition applicable for this event is fulfilled for one or more of the cells included in the *cellsTriggeredList* defined within the *VarMeasReportList* for this *measId* for all measurements after layer 3 filtering taken during *timeToTrigger* defined within the *VarMeasConfig* for this event:

3> remove the concerned cell(s) in the *cellsTriggeredList* defined within the *VarMeasReportList* for this *measId*;

3> if *reportOnLeave* is set to *TRUE* for the corresponding reporting configuration:

4> initiate the measurement reporting procedure, as specified in 5.5.5;

3> if the *cellsTriggeredList* defined within the *VarMeasReportList* for this *measId* is empty:

4> remove the measurement reporting entry within the *VarMeasReportList* for this *measId*;

4> stop the periodical reporting timer for this *measId*, if running;

...

2> upon expiry of the periodical reporting timer for this *measId*:

3> initiate the measurement reporting procedure, as specified in 5.5.5;

...

NOTE 2: The UE does not stop the periodical reporting with *triggerType* set to 'event' or to 'periodical' while the corresponding measurement is not performed due to the serving cell RSRP being equal to or better than *s-Measure* or due to the measurement gap not being setup.

[TS 36.331, clause 5.5.4.6]

The UE shall:

1> consider the entering condition for this event to be satisfied when both conditions A5-1 and condition A5-2, as specified below, are fulfilled;

1> consider the leaving condition for this event to be satisfied when condition A5-3 or condition A5-4, i.e. at least one of the two, as specified below, is fulfilled;

Inequality A5-1 (Entering condition 1)

$$Ms + Hys < Thresh1$$

Inequality A5-2 (Entering condition 2)

$$Mn + Ofn + Ocn - Hys > Thresh2$$

Inequality A5-3 (Leaving condition 1)

$$Ms - Hys > Thresh1$$

Inequality A5-4 (Leaving condition 2)

$$Mn + Ofn + Ocn + Hys < Thresh2$$

The variables in the formula are defined as follows:

Ms is the measurement result of the serving cell, not taking into account any offsets.

Mn is the measurement result of the neighbouring cell, not taking into account any offsets.

Ofn is the frequency specific offset of the frequency of the neighbour cell (i.e. *offsetFreq* as defined within *measObjectEUTRA* corresponding to the frequency of the neighbour cell).

Ocn is the cell specific offset of the neighbour cell (i.e. *cellIndividualOffset* as defined within *measObjectEUTRA* corresponding to the frequency of the neighbour cell), and set to zero if not configured for the neighbour cell.

Hys is the hysteresis parameter for this event (i.e. *hysteresis* as defined within *reportConfigEUTRA* for this event).

Thresh1 is the threshold parameter for this event (i.e. *a5-Threshold1* as defined within *reportConfigEUTRA* for this event).

Thresh2 is the threshold parameter for this event (i.e. *a5-Threshold2* as defined within *reportConfigEUTRA* for this event).

Mn, Ms are expressed in dBm in case of RSRP, or in dB in case of RSRQ.

Ofn, Ocn, Hys are expressed in dB.

Thresh1 is expressed in the same unit as **Ms**.

Thresh2 is expressed in the same unit as **Mn**.

[TS 36.331, clause 5.5.5]

For the *measId* for which the measurement reporting procedure was triggered, the UE shall set the *measResults* within the *MeasurementReport* message as follows:

- 1> set the *measId* to the measurement identity that triggered the measurement reporting;
- 1> set the *measResultServCell* to include the quantities of serving cell;
- 1> if there is at least one applicable neighbouring cell to report:
 - 2> set the *measResultNeighCells* to include the best neighbouring cells up to *maxReportCells* in accordance with the following:
 - 3> if the *triggerType* is set to 'event':
 - 4> include the cells included in the *cellsTriggeredList* as defined within the *VarMeasReportList* for this *measId*;
 - 3> else:
 - 4> include the applicable cells for which the new measurement results became available since the last periodical reporting or since the measurement was initiated or reset;

NOTE: The reliability of the report (i.e. the certainty it contains the strongest cells on the concerned frequency) depends on the measurement configuration i.e. the *reportInterval*. The related performance requirements are specified in TS 36.133 [16].

- 3> for each cell that is included in the *measResultNeighCells*, include the *physCellId*;
- 3> if the *triggerType* is set to 'event'; or the *purpose* is set to 'reportStrongestCells' or to 'reportStrongestCellsForSON':
 - 4> for each included cell, include the layer 3 filtered measured results in accordance with the *reportConfig* for this *measId*, ordered as follows:
 - 5> if the *measObject* associated with this *measId* concerns E-UTRA:
 - 6> set the *measResult* to include the quantity(ies) indicated in the *reportQuantity* within the concerned *reportConfig* in order of decreasing *triggerQuantity*, i.e. the best cell is included first;

...

- 1> increment the *numberOfReportsSent* as defined within the *VarMeasReportList* for this *measId* by 1;
- 1> stop the periodical reporting timer, if running;
- 1> if the *numberOfReportsSent* as defined within the *VarMeasReportList* for this *measId* is less than the *reportAmount* as defined within the corresponding *reportConfig* for this *measId*:
 - 2> start the periodical reporting timer with the value of *reportInterval* as defined within the corresponding *reportConfig* for this *measId*;

...

- 1> submit the *MeasurementReport* message to lower layers for transmission, upon which the procedure ends;

8.3.1.25.3 Test description

8.3.1.25.3.1 Pre-test conditions

System Simulator:

- Cell 1 and Cell 2.

UE:

None.

Preamble:

- The UE is in state Generic RB Established (state 3) on Cell 1 according to [18].

8.3.1.25.3.2 Test procedure sequence

Table 8.3.1.25.3.2-1 illustrates the downlink power levels to be applied for Cell 1 and Cell 2 at various time instants of the test execution. Row marked "T0" denotes the initial conditions after preamble, while rows marked "T1" and "T2" are to be applied subsequently. The exact instants on which these values shall be applied are described in the texts in this clause.

Table 8.3.1.25.3.2-1: Power levels

	Parameter	Unit	Cell 1	Cell 2	Remark
T0	Cell-specific RS EPRE	dBm/15 kHz	-85	-98	Power levels are such that entry condition for event A5 is not satisfied: $Ms - Hys > Thresh1$ or $Mn + Ofn + Ocn + Hys < Thresh2$
	RSRQ	dB	-7.7	-20.7	
	Noc	dBm/15 kHz	-90	-90	
T1	Cell-specific RS EPRE	dBm/15 kHz	-91	-85	Power levels are such that entry condition for event A5 is satisfied: $Ms + Hys < Thresh1$ and $Mn + Ofn + Ocn - Hys > Thresh2$
	RSRQ	dB	-14	-8	
T2	Cell-specific RS EPRE	dBm/15 kHz	-65	-85	Power levels are such that entry condition for event A5 is not satisfied: $Ms - Hys > Thresh1$ or $Mn + Ofn + Ocn + Hys < Thresh2$
	RSRQ	dB	-3.13	-23.13	

Table 8.3.1.25.3.2-2: Main behaviour

St	Procedure	Message Sequence		TP	Verdict
		U - S	Message		
1	SS transmits an <i>RRConnectionReconfiguration</i> message including measConfig to setup intra LTE measurement and reporting for event A5 on Cell 1.	<--	<i>RRConnectionReconfiguration</i>	-	-
2	The UE transmits an <i>RRConnectionReconfigurationComplete</i> message on Cell 1.	-->	<i>RRConnectionReconfigurationComplete</i>	-	-
3	Check: Does the UE attempt to transmit an uplink message within the next 30s?	-	-	2	F
4	SS re-adjusts the cell-specific reference signal level according to row "T1" in table 8.3.1.25.3.2-1.	-	-	-	-
5	Check: Does the UE transmit a <i>MeasurementReport</i> message on Cell 1 to report event A5 with the measured RSRP and RSRQ value for Cell 2?	-->	<i>MeasurementReport</i>	1	P
-	EXCEPTION: Step 6 below is repeated until 3 <i>MeasurementReport</i> messages are received from the UE	-	-	-	-
6	Check: Does the UE transmit a <i>MeasurementReport</i> message on Cell 1, with the measured RSRP and RSRQ value for Cell 2?	-->	<i>MeasurementReport</i>	1	P
7	SS re-adjusts the cell-specific reference signal level according to row "T2" in table 8.3.1.25.3.2-1.	-	-	-	-
8	Wait and ignore <i>MeasurementReport</i> messages for 15 s to allow change of power levels for Cell 2 and UE measurement.	-	-	-	-
9	Check: Does the UE attempt to transmit an uplink message within the next 10s?	-	-	2	F

8.3.1.25.3.3 Specific message contents

Table 8.3.1.25.3.3-1: *RRConnectionReconfiguration* (step 1, Table 8.3.1.25.3.2-2)

Derivation Path: 36.508 Table 4.6.1-8 with condition MEAS

Table 8.3.1.25.3.3-2: MeasConfig (step 1, Table 8.3.1.25.3.2-2)

Derivation Path: 36.508, Table 4.6.1-1			
Information Element	Value/remark	Comment	Condition
MeasConfig ::= SEQUENCE {			
measObjectToAddModList SEQUENCE (SIZE (1..maxObjectId)) OF SEQUENCE{	1 entry		
measObjectId[1]	IdMeasObject-f1		
measObject[1]	MeasObjectEUTRA-GENERIC(f1)		
}			
reportConfigToAddModList SEQUENCE (SIZE (1..maxReportConfigId)) OF SEQUENCE {	1 entry		
reportConfigId[1]	IdReportConfig-A5		
reportConfig[1]	ReportConfigEUTRA-A5-RECONF		
}			
measIdToAddModList SEQUENCE (SIZE (1..maxMeasId)) OF SEQUENCE {	1 entry		
measId[1]	1		
measObjectId[1]	IdMeasObject-f1		
reportConfigId[1]	IdReportConfig-A5		
}			
}			

Table 8.3.1.25.3.3-3: ReportConfigEUTRA-A5-RECONF (step 1, Table 8.3.1.25.3.2-2)

Derivation Path: 36.508, Table 4.6.6-6AB ReportConfigEUTRA-A5(-4, -14) with condition RSRQ			
Information Element	Value/remark	Comment	Condition
ReportConfigEUTRA ::= SEQUENCE {			
reportAmount	infinity		
}			

Table 8.3.1.25.3.3-4: *MeasurementReport* (step 5 and 6, Table 8.3.1.25.3.2-2)

Derivation Path: 36.508, Table 4.6.1-5			
Information Element	Value/remark	Comment	Condition
MeasurementReport ::= SEQUENCE {			
criticalExtensions CHOICE {			
c1 CHOICE{			
measurementReport-r8 SEQUENCE {			
measResults SEQUENCE {			
measId	1		
measResultServCell SEQUENCE {		Report Cell 1	
rsrpResult	(0..97)		
rsrqResult	(0..34)		
}			
measResultNeighCells CHOICE {			
measResultListEUTRA SEQUENCE (SIZE (1..maxCellReport)) OF SEQUENCE {	1 entry	Report Cell 2	
physCellId[1]	PhysicalCellIdentity of Cell 2		
cgi-Info[1]	Not present		
measResult[1] SEQUENCE {			
rsrpResult	(0..97)		
rsrqResult	(0..34)		
additionalSI-Info-r9	Not present		
}			
}			
}			
measResultForECID-r9	Not present		
}			
}			
}			

8.3.1.26 Measurement configuration control and reporting / Intra E-UTRAN measurements / Event A5 (Inter-frequency measurements)

8.3.1.26.1 Test Purpose (TP)

(1)

```
with { UE in E-UTRA RRC_CONNECTED state and measurement configured for event A5 with event based
periodical reporting }
ensure that {
  when { Serving cell becomes worse than absolute threshold1 and inter-frequency neighbour cell
becomes better than absolute threshold2 }
  then { UE sends MeasurementReport message at regular intervals while entering conditions for
event A5 are satisfied }
}
```

(2)

```
with { UE in E-UTRA RRC_CONNECTED state and periodical measurement reporting triggered by event A5
ongoing }
ensure that {
  when { Serving cell becomes better than absolute threshold1 or inter-frequency neighbour cell
becomes worse than absolute threshold2 }
  then { UE stops sending MeasurementReport message }
}
```

8.3.1.26.2 Conformance requirements

References: The conformance requirements covered in the current TC are specified in: TS 36.331, clauses 5.3.5.3, 5.5.4.1, 5.5.4.6 and 5.5.5.

[TS 36.331, clause 5.3.5.3]

If the *RRCCONNECTIONRECONFIGURATION* message does not include the *mobilityControlInfo* and the UE is able to comply with the configuration included in this message, the UE shall:

...

- 1> if the *RRCCONNECTIONRECONFIGURATION* message includes the *measConfig*:
- 2> perform the measurement configuration procedure as specified in 5.5.2;

[TS 36.331, clause 5.5.4.1]

The UE shall:

- 1> for each *measId* included in the *measIdList* within *VarMeasConfig*:

...

- 2> else:
 - 3> if the corresponding *measObject* concerns E-UTRA:
 - 4> if the *ue-RxTxTimeDiffPeriodical*, *eventA1* or *eventA2* is configured in the corresponding *reportConfig*:
 - 5> consider only the serving cell to be applicable;
 - 4> else:
 - 5> consider any neighbouring cell detected on the associated frequency to be applicable when the concerned cell is not included in the *blackCellsToAddModList* defined within the *VarMeasConfig* for this *measId*;

...

- 2> if the *triggerType* is set to 'event' and if the entry condition applicable for this event, i.e. the event corresponding with the *eventId* of the corresponding *reportConfig* within *VarMeasConfig*, is fulfilled for one or more applicable cells for all measurements after layer 3 filtering taken during *timeToTrigger* defined for this event within the *VarMeasConfig*, while the *VarMeasReportList* does not include a measurement reporting entry for this *measId* (a first cell triggers the event):
 - 3> include a measurement reporting entry within the *VarMeasReportList* for this *measId*;
 - 3> set the *numberOfReportsSent* defined within the *VarMeasReportList* for this *measId* to 0;
 - 3> include the concerned cell(s) in the *cellsTriggeredList* defined within the *VarMeasReportList* for this *measId*;
 - 3> initiate the measurement reporting procedure, as specified in 5.5.5;
- 2> if the *triggerType* is set to 'event' and if the entry condition applicable for this event, i.e. the event corresponding with the *eventId* of the corresponding *reportConfig* within *VarMeasConfig*, is fulfilled for one or more applicable cells not included in the *cellsTriggeredList* for all measurements after layer 3 filtering taken during *timeToTrigger* defined for this event within the *VarMeasConfig* (a subsequent cell triggers the event):
 - 3> set the *numberOfReportsSent* defined within the *VarMeasReportList* for this *measId* to 0;
 - 3> include the concerned cell(s) in the *cellsTriggeredList* defined within the *VarMeasReportList* for this *measId*;
 - 3> initiate the measurement reporting procedure, as specified in 5.5.5;
- 2> if the *triggerType* is set to 'event' and if the leaving condition applicable for this event is fulfilled for one or more of the cells included in the *cellsTriggeredList* defined within the *VarMeasReportList* for this *measId* for all measurements after layer 3 filtering taken during *timeToTrigger* defined within the *VarMeasConfig* for this event:

3> remove the concerned cell(s) in the *cellsTriggeredList* defined within the *VarMeasReportList* for this *measId*;

3> if *reportOnLeave* is set to *TRUE* for the corresponding reporting configuration:

4> initiate the measurement reporting procedure, as specified in 5.5.5;

3> if the *cellsTriggeredList* defined within the *VarMeasReportList* for this *measId* is empty:

4> remove the measurement reporting entry within the *VarMeasReportList* for this *measId*;

4> stop the periodical reporting timer for this *measId*, if running;

...

2> upon expiry of the periodical reporting timer for this *measId*:

3> initiate the measurement reporting procedure, as specified in 5.5.5;

...

NOTE 2: The UE does not stop the periodical reporting with *triggerType* set to 'event' or to 'periodical' while the corresponding measurement is not performed due to the serving cell RSRP being equal to or better than *s-Measure* or due to the measurement gap not being setup.

[TS 36.331, clause 5.5.4.6]

The UE shall:

1> consider the entering condition for this event to be satisfied when both conditions A5-1 and condition A5-2, as specified below, are fulfilled;

1> consider the leaving condition for this event to be satisfied when condition A5-3 or condition A5-4, i.e. at least one of the two, as specified below, is fulfilled;

Inequality A5-1 (Entering condition 1)

$$Ms + Hys < Thresh1$$

Inequality A5-2 (Entering condition 2)

$$Mn + Ofn + Ocn - Hys > Thresh2$$

Inequality A5-3 (Leaving condition 1)

$$Ms - Hys > Thresh1$$

Inequality A5-4 (Leaving condition 2)

$$Mn + Ofn + Ocn + Hys < Thresh2$$

The variables in the formula are defined as follows:

Ms is the measurement result of the serving cell, not taking into account any offsets.

Mn is the measurement result of the neighbouring cell, not taking into account any offsets.

Ofn is the frequency specific offset of the frequency of the neighbour cell (i.e. *offsetFreq* as defined within *measObjectEUTRA* corresponding to the frequency of the neighbour cell).

Ocn is the cell specific offset of the neighbour cell (i.e. *cellIndividualOffset* as defined within *measObjectEUTRA* corresponding to the frequency of the neighbour cell), and set to zero if not configured for the neighbour cell.

Hys is the hysteresis parameter for this event (i.e. *hysteresis* as defined within *reportConfigEUTRA* for this event).

Thresh1 is the threshold parameter for this event (i.e. *a5-Threshold1* as defined within *reportConfigEUTRA* for this event).

Thresh2 is the threshold parameter for this event (i.e. *a5-Threshold2* as defined within *reportConfigEUTRA* for this event).

Mn, Ms are expressed in dBm in case of RSRP, or in dB in case of RSRQ.

Ofn, Ocn, Hys are expressed in dB.

Thresh1 is expressed in the same unit as **Ms**.

Thresh2 is expressed in the same unit as **Mn**.

[TS 36.331, clause 5.5.5]

For the *measId* for which the measurement reporting procedure was triggered, the UE shall set the *measResults* within the *MeasurementReport* message as follows:

- 1> set the *measId* to the measurement identity that triggered the measurement reporting;
- 1> set the *measResultServCell* to include the quantities of serving cell;
- 1> if there is at least one applicable neighbouring cell to report:
 - 2> set the *measResultNeighCells* to include the best neighbouring cells up to *maxReportCells* in accordance with the following:
 - 3> if the *triggerType* is set to 'event':
 - 4> include the cells included in the *cellsTriggeredList* as defined within the *VarMeasReportList* for this *measId*;
 - 3> else:
 - 4> include the applicable cells for which the new measurement results became available since the last periodical reporting or since the measurement was initiated or reset;

NOTE: The reliability of the report (i.e. the certainty it contains the strongest cells on the concerned frequency) depends on the measurement configuration i.e. the *reportInterval*. The related performance requirements are specified in TS 36.133 [16].

- 3> for each cell that is included in the *measResultNeighCells*, include the *physCellId*;
- 3> if the *triggerType* is set to 'event'; or the *purpose* is set to 'reportStrongestCells' or to 'reportStrongestCellsForSON':
 - 4> for each included cell, include the layer 3 filtered measured results in accordance with the *reportConfig* for this *measId*, ordered as follows:
 - 5> if the *measObject* associated with this *measId* concerns E-UTRA:
 - 6> set the *measResult* to include the quantity(ies) indicated in the *reportQuantity* within the concerned *reportConfig* in order of decreasing *triggerQuantity*, i.e. the best cell is included first;

...

- 1> increment the *numberOfReportsSent* as defined within the *VarMeasReportList* for this *measId* by 1;
- 1> stop the periodical reporting timer, if running;
- 1> if the *numberOfReportsSent* as defined within the *VarMeasReportList* for this *measId* is less than the *reportAmount* as defined within the corresponding *reportConfig* for this *measId*:
 - 2> start the periodical reporting timer with the value of *reportInterval* as defined within the corresponding *reportConfig* for this *measId*;

...

- 1> submit the *MeasurementReport* message to lower layers for transmission, upon which the procedure ends;

8.3.1.26.3 Test description

8.3.1.26.3.1 Pre-test conditions

System Simulator:

- Cell 1 and Cell 3.

UE:

None.

Preamble:

- The UE is in state Generic RB Established (state 3) on Cell 1 according to [18].

8.3.1.26.3.2 Test procedure sequence

Table 8.3.1.26.3.2-1 illustrates the downlink power levels to be applied for Cell 1 and Cell 3 at various time instants of the test execution. Row marked "T0" denotes the initial conditions after preamble, while rows marked "T1" and "T2" are to be applied subsequently. The exact instants on which these values shall be applied are described in the texts in this clause.

Table 8.3.1.26.3.2-1: Power levels

	Parameter	Unit	Cell 1	Cell 3	Remark
T0	Cell-specific RS EPRE	dBm/15 kHz	-85	-97	Power levels are such that entry condition for event A5 is not satisfied: $Ms - Hys > Thresh1$ or $Mn + Ofn + Ocn + Hys < Thresh2$
T1	Cell-specific RS EPRE	dBm/15 kHz	-85	-73	Power levels are such that entry condition for event A5 is satisfied: $Ms + Hys < Thresh1$ and $Mn + Ofn + Ocn - Hys > Thresh2$
T2	Cell-specific RS EPRE	dBm/15 kHz	-65	-73	Power levels are such that entry condition for event A5 is not satisfied: $Ms - Hys > Thresh1$ or $Mn + Ofn + Ocn + Hys < Thresh2$

Table 8.3.1.26.3.2-2: Main behaviour

St	Procedure	Message Sequence		TP	Verdict
		U - S	Message		
1	SS transmits an <i>RRConnectionReconfiguration</i> message including measConfig to setup intra LTE measurement and reporting for event A5 on Cell 1.	<--	<i>RRConnectionReconfiguration</i>	-	-
2	The UE transmits an <i>RRConnectionReconfigurationComplete</i> message on Cell 1.	-->	<i>RRConnectionReconfigurationComplete</i>	-	-
3	Check: Does the UE attempt to transmit an uplink message within the next 30s?	-	-	2	F
4	SS re-adjusts the cell-specific reference signal level according to row "T1" in table 8.3.1.26.3.2-1.	-	-	-	-
5	Check: Does the UE transmit a <i>MeasurementReport</i> message on Cell 1 to report event A5 with the measured RSRP and RSRQ value for Cell 3?	-->	<i>MeasurementReport</i>	1	P
-	EXCEPTION: Step 6 below is repeated until 3 <i>MeasurementReport</i> messages are received from the UE	-	-	-	-
6	Check: Does the UE transmit a <i>MeasurementReport</i> message on Cell 1, with the measured RSRP and RSRQ value for Cell 3?	-->	<i>MeasurementReport</i>	1	P
7	SS re-adjusts the cell-specific reference signal level according to row "T2" in table 8.3.1.26.3.2-1.	-	-	-	-
8	Wait and ignore <i>MeasurementReport</i> messages for 15 s to allow change of power levels for Cell 3 and UE measurement.	-	-	-	-
9	Check: Does the UE attempt to transmit an uplink message within the next 10s?	-	-	2	F

8.3.1.26.3.3 Specific message contents

Table 8.3.1.26.3.3-1: *RRConnectionReconfiguration* (step 1, Table 8.3.1.26.3.2-2)

Derivation Path: 36.508 Table 4.6.1-8 with condition MEAS

Table 8.3.1.26.3.3-2: MeasConfig (step 1, Table 8.3.1.26.3.2-2)

Derivation Path: 36.508, Table 4.6.1-1 with condition INTER-FREQ			
Information Element	Value/remark	Comment	Condition
MeasConfig ::= SEQUENCE {			
measObjectToAddModList SEQUENCE (SIZE (1..maxObjectId)) OF SEQUENCE{	2 entry		
measObjectId[1]	IdMeasObject-f1		
measObject[1]	MeasObjectEUTRA-GENERIC(f1)		
measObjectId[2]	IdMeasObject-f2		
measObject[2]	MeasObjectEUTRA-GENERIC(f2)		
}			
reportConfigToAddModList SEQUENCE (SIZE (1..maxReportConfigId)) OF SEQUENCE {	1 entry		
reportConfigId[1]	IdReportConfig-A5		
reportConfig[1]	ReportConfigEUTRA-A5-RECONF		
}			
measIdToAddModList SEQUENCE (SIZE (1..maxMeasId)) OF SEQUENCE {	2 entry		
measId[1]	1		
measObjectId[1]	IdMeasObject-f1		
reportConfigId[1]	IdReportConfig-A5		
measId[2]	2		
measObjectId[2]	IdMeasObject-f2		
reportConfigId[2]	IdReportConfig-A5		
}			
}			

Table 8.3.1.26.3.3-3: ReportConfigEUTRA-A5-RECONF (step 1, Table 8.3.1.26.3.2-2)

Derivation Path: 36.508, Table 4.6.6-6AB ReportConfigEUTRA-A5(-76, -85)			
Information Element	Value/remark	Comment	Condition
ReportConfigEUTRA ::= SEQUENCE {			
reportAmount	infinity		
}			

Table 8.3.1.26.3.3-4: *MeasurementReport* (step 5 and 6, Table 8.3.1.26.3.2-2)

Derivation Path: 36.508, Table 4.6.1-5			
Information Element	Value/remark	Comment	Condition
MeasurementReport ::= SEQUENCE {			
criticalExtensions CHOICE {			
c1 CHOICE{			
measurementReport-r8 SEQUENCE {			
measResults SEQUENCE {			
measId	1		
measResultServCell SEQUENCE {		Report Cell 1	
rsrpResult	(0..97)		
rsrqResult	(0..34)		
}			
measResultNeighCells CHOICE {			
measResultListEUTRA SEQUENCE (SIZE (1..maxCellReport)) OF SEQUENCE {	1 entry	Report Cell 3	
physCellId[1]	PhysicalCellIdentity of Cell 3		
cgi-Info[1]	Not present		
measResult[1] SEQUENCE {			
rsrpResult	(0..97)		
rsrqResult	(0..34)		
additionalSI-Info-r9	Not present		
}			
}			
measResultForECID-r9	Not present		
}			
}			
}			
}			

8.3.1.27 Measurement configuration control and reporting / Intra E-UTRAN measurements / Event A5 (Inter-frequency measurements) / RSRQ based measurements

8.3.1.27.1 Test Purpose (TP)

(1)

```
with { UE in E-UTRA RRC_CONNECTED state and measurement configured for event A5 with event based
periodical reporting and triggerQuantity set to rsrq }
ensure that {
  when { Serving cell becomes worse than absolute threshold1 and inter-frequency neighbour cell
becomes better than absolute threshold2 }
  then { UE sends MeasurementReport message at regular intervals while entering conditions for
event A5 are satisfied }
}
```

(2)

```
with { UE in E-UTRA RRC_CONNECTED state and periodical measurement reporting triggered by event A5
ongoing and triggerQuantity set to rsrq }
ensure that {
  when { Serving cell becomes better than absolute threshold1 or inter-frequency neighbour cell
becomes worse than absolute threshold2 }
  then { UE stops sending MeasurementReport message }
}
```

8.3.1.27.2 Conformance requirements

References: The conformance requirements covered in the current TC are specified in: TS 36.331, clauses 5.3.5.3, 5.5.4.1, 5.5.4.6 and 5.5.5.

[TS 36.331, clause 5.3.5.3]

If the *RRConnectionReconfiguration* message does not include the *mobilityControlInfo* and the UE is able to comply with the configuration included in this message, the UE shall:

...

1> if the *RRConnectionReconfiguration* message includes the *measConfig*:

2> perform the measurement configuration procedure as specified in 5.5.2;

[TS 36.331, clause 5.5.4.1]

The UE shall:

1> for each *measId* included in the *measIdList* within *VarMeasConfig*:

...

2> else:

3> if the corresponding *measObject* concerns E-UTRA:

4> if the *ue-RxTxTimeDiffPeriodical*, *eventA1* or *eventA2* is configured in the corresponding *reportConfig*:

5> consider only the serving cell to be applicable;

4> else:

5> consider any neighbouring cell detected on the associated frequency to be applicable when the concerned cell is not included in the *blackCellsToAddModList* defined within the *VarMeasConfig* for this *measId*;

...

2> if the *triggerType* is set to 'event' and if the entry condition applicable for this event, i.e. the event corresponding with the *eventId* of the corresponding *reportConfig* within *VarMeasConfig*, is fulfilled for one or more applicable cells for all measurements after layer 3 filtering taken during *timeToTrigger* defined for this event within the *VarMeasConfig*, while the *VarMeasReportList* does not include an measurement reporting entry for this *measId* (a first cell triggers the event):

3> include a measurement reporting entry within the *VarMeasReportList* for this *measId*;

3> set the *numberOfReportsSent* defined within the *VarMeasReportList* for this *measId* to 0;

3> include the concerned cell(s) in the *cellsTriggeredList* defined within the *VarMeasReportList* for this *measId*;

3> initiate the measurement reporting procedure, as specified in 5.5.5;

2> if the *triggerType* is set to 'event' and if the entry condition applicable for this event, i.e. the event corresponding with the *eventId* of the corresponding *reportConfig* within *VarMeasConfig*, is fulfilled for one or more applicable cells not included in the *cellsTriggeredList* for all measurements after layer 3 filtering taken during *timeToTrigger* defined for this event within the *VarMeasConfig* (a subsequent cell triggers the event):

3> set the *numberOfReportsSent* defined within the *VarMeasReportList* for this *measId* to 0;

3> include the concerned cell(s) in the *cellsTriggeredList* defined within the *VarMeasReportList* for this *measId*;

3> initiate the measurement reporting procedure, as specified in 5.5.5;

2> if the *triggerType* is set to 'event' and if the leaving condition applicable for this event is fulfilled for one or more of the cells included in the *cellsTriggeredList* defined within the *VarMeasReportList* for this *measId* for

all measurements after layer 3 filtering taken during *timeToTrigger* defined within the *VarMeasConfig* for this event:

3> remove the concerned cell(s) in the *cellsTriggeredList* defined within the *VarMeasReportList* for this *measId*;

3> if *reportOnLeave* is set to *TRUE* for the corresponding reporting configuration:

4> initiate the measurement reporting procedure, as specified in 5.5.5;

3> if the *cellsTriggeredList* defined within the *VarMeasReportList* for this *measId* is empty:

4> remove the measurement reporting entry within the *VarMeasReportList* for this *measId*;

4> stop the periodical reporting timer for this *measId*, if running;

...

2> upon expiry of the periodical reporting timer for this *measId*:

3> initiate the measurement reporting procedure, as specified in 5.5.5;

...

NOTE 2: The UE does not stop the periodical reporting with *triggerType* set to 'event' or to 'periodical' while the corresponding measurement is not performed due to the serving cell RSRP being equal to or better than *s-Measure* or due to the measurement gap not being setup.

[TS 36.331, clause 5.5.4.6]

The UE shall:

1> consider the entering condition for this event to be satisfied when both conditions A5-1 and condition A5-2, as specified below, are fulfilled;

1> consider the leaving condition for this event to be satisfied when condition A5-3 or condition A5-4, i.e. at least one of the two, as specified below, is fulfilled;

Inequality A5-1 (Entering condition 1)

$$Ms + Hys < Thresh1$$

Inequality A5-2 (Entering condition 2)

$$Mn + Ofn + Ocn - Hys > Thresh2$$

Inequality A5-3 (Leaving condition 1)

$$Ms - Hys > Thresh1$$

Inequality A5-4 (Leaving condition 2)

$$Mn + Ofn + Ocn + Hys < Thresh2$$

The variables in the formula are defined as follows:

Ms is the measurement result of the serving cell, not taking into account any offsets.

Mn is the measurement result of the neighbouring cell, not taking into account any offsets.

Ofn is the frequency specific offset of the frequency of the neighbour cell (i.e. *offsetFreq* as defined within *measObjectEUTRA* corresponding to the frequency of the neighbour cell).

Ocn is the cell specific offset of the neighbour cell (i.e. *cellIndividualOffset* as defined within *measObjectEUTRA* corresponding to the frequency of the neighbour cell), and set to zero if not configured for the neighbour cell.

Hys is the hysteresis parameter for this event (i.e. *hysteresis* as defined within *reportConfigEUTRA* for this event).

Thresh1 is the threshold parameter for this event (i.e. *a5-Threshold1* as defined within *reportConfigEUTRA* for this event).

Thresh2 is the threshold parameter for this event (i.e. *a5-Threshold2* as defined within *reportConfigEUTRA* for this event).

Mn, Ms are expressed in dBm in case of RSRP, or in dB in case of RSRQ.

Ofn, Ocn, Hys are expressed in dB.

Thresh1 is expressed in the same unit as **Ms**.

Thresh2 is expressed in the same unit as **Mn**.

[TS 36.331, clause 5.5.5]

For the *measId* for which the measurement reporting procedure was triggered, the UE shall set the *measResults* within the *MeasurementReport* message as follows:

- 1> set the *measId* to the measurement identity that triggered the measurement reporting;
- 1> set the *measResultServCell* to include the quantities of serving cell;
- 1> if there is at least one applicable neighbouring cell to report:
 - 2> set the *measResultNeighCells* to include the best neighbouring cells up to *maxReportCells* in accordance with the following:
 - 3> if the *triggerType* is set to 'event':
 - 4> include the cells included in the *cellsTriggeredList* as defined within the *VarMeasReportList* for this *measId*;
 - 3> else:
 - 4> include the applicable cells for which the new measurement results became available since the last periodical reporting or since the measurement was initiated or reset;

NOTE: The reliability of the report (i.e. the certainty it contains the strongest cells on the concerned frequency) depends on the measurement configuration i.e. the *reportInterval*. The related performance requirements are specified in TS 36.133 [16].

- 3> for each cell that is included in the *measResultNeighCells*, include the *physCellId*;
- 3> if the *triggerType* is set to 'event'; or the *purpose* is set to 'reportStrongestCells' or to 'reportStrongestCellsForSON':
 - 4> for each included cell, include the layer 3 filtered measured results in accordance with the *reportConfig* for this *measId*, ordered as follows:
 - 5> if the *measObject* associated with this *measId* concerns E-UTRA:
 - 6> set the *measResult* to include the quantity(ies) indicated in the *reportQuantity* within the concerned *reportConfig* in order of decreasing *triggerQuantity*, i.e. the best cell is included first;

...

- 1> increment the *numberOfReportsSent* as defined within the *VarMeasReportList* for this *measId* by 1;
- 1> stop the periodical reporting timer, if running;
- 1> if the *numberOfReportsSent* as defined within the *VarMeasReportList* for this *measId* is less than the *reportAmount* as defined within the corresponding *reportConfig* for this *measId*:
 - 2> start the periodical reporting timer with the value of *reportInterval* as defined within the corresponding *reportConfig* for this *measId*;

...

1> submit the *MeasurementReport* message to lower layers for transmission, upon which the procedure ends;

8.3.1.27.3 Test description

8.3.1.27.3.1 Pre-test conditions

System Simulator:

- Cell 1 and Cell 3.

UE:

None.

Preamble:

- The UE is in state Generic RB Established (state 3) on Cell 1 according to [18].

8.3.1.27.3.2 Test procedure sequence

Table 8.3.1.27.3.2-1 illustrates the downlink power levels to be applied for Cell 1 and Cell 3 at various time instants of the test execution. Row marked "T0" denotes the initial conditions after preamble, while rows marked "T1" and "T2" are to be applied subsequently. The exact instants on which these values shall be applied are described in the texts in this clause.

Table 8.3.1.27.3.2-1: Power levels

	Parameter	Unit	Cell 1	Cell 3	Remark
T0	Cell-specific RS EPRE	dBm/15 kHz	-80	-100	Power levels are such that entry condition for event A5 is not satisfied: $Ms - Hys > Thresh1$ or $Mn + Ofn + Ocn + Hys < Thresh2$
	RSRQ	dB	-5.05	-11.46	
	Noc	dBm/15 kHz	-90	-100	
T1	Cell-specific RS EPRE	dBm/15 kHz	-91	-85	Power levels are such that entry condition for event A5 is satisfied: $Ms + Hys < Thresh1$ and $Mn + Ofn + Ocn - Hys > Thresh2$
	RSRQ	dB	-12.33	-3.76	
T2	Cell-specific RS EPRE	dBm/15 kHz	-65	-85	Power levels are such that entry condition for event A5 is not satisfied: $Ms - Hys > Thresh1$ or $Mn + Ofn + Ocn + Hys < Thresh2$
	RSRQ	dB	-3.09	-3.76	

Table 8.3.1.27.3.2-2: Main behaviour

St	Procedure	Message Sequence		TP	Verdict
		U - S	Message		
1	SS transmits an <i>RRConnectionReconfiguration</i> message including measConfig to setup intra LTE measurement and reporting for event A5 on Cell 1.	<--	<i>RRConnectionReconfiguration</i>	-	-
2	The UE transmits an <i>RRConnectionReconfigurationComplete</i> message on Cell 1.	-->	<i>RRConnectionReconfigurationComplete</i>	-	-
3	Check: Does the UE attempt to transmit an uplink message within the next 30s?	-	-	2	F
4	SS re-adjusts the cell-specific reference signal level according to row "T1" in table 8.3.1.27.3.2-1.	-	-	-	-
5	Check: Does the UE transmit a <i>MeasurementReport</i> message on Cell 1 to report event A5 with the measured RSRP and RSRQ value for Cell 3?	-->	<i>MeasurementReport</i>	1	P
-	EXCEPTION: Step 6 below is repeated until 3 <i>MeasurementReport</i> messages are received from the UE	-	-	-	-
6	Check: Does the UE transmit a <i>MeasurementReport</i> message on Cell 1, with the measured RSRP and RSRQ value for Cell 3?	-->	<i>MeasurementReport</i>	1	P
7	SS re-adjusts the cell-specific reference signal level according to row "T2" in table 8.3.1.27.3.2-1.	-	-	-	-
8	Wait and ignore <i>MeasurementReport</i> messages for 15 s to allow change of power levels for Cell 3 and UE measurement.	-	-	-	-
9	Check: Does the UE attempt to transmit an uplink message within the next 10s?	-	-	2	F

8.3.1.27.3.3 Specific message contents

Table 8.3.1.27.3.3-1: *RRConnectionReconfiguration* (step 1, Table 8.3.1.27.3.2-2)

Derivation Path: 36.508 Table 4.6.1-8 with condition MEAS

Table 8.3.1.27.3.3-2: MeasConfig (step 1, Table 8.3.1.27.3.2-2)

Derivation Path: 36.508, Table 4.6.6-1 with condition INTER-FREQ			
Information Element	Value/remark	Comment	Condition
MeasConfig ::= SEQUENCE {			
measObjectToAddModList SEQUENCE (SIZE (1..maxObjectId)) OF SEQUENCE{	2 entry		
measObjectId[1]	IdMeasObject-f1		
measObject[1]	MeasObjectEUTRA-GENERIC(f1)		
measObjectId[2]	IdMeasObject-f2		
measObject[2]	MeasObjectEUTRA-GENERIC(f2)		
}			
reportConfigToAddModList SEQUENCE (SIZE (1..maxReportConfigId)) OF SEQUENCE {	1 entry		
reportConfigId[1]	IdReportConfig-A5		
reportConfig[1]	ReportConfigEUTRA-A5-RECONF		
}			
measIdToAddModList SEQUENCE (SIZE (1..maxMeasId)) OF SEQUENCE {	2 entry		
measId[1]	1		
measObjectId[1]	IdMeasObject-f1		
reportConfigId[1]	IdReportConfig-A5		
measId[2]	2		
measObjectId[2]	IdMeasObject-f2		
reportConfigId[2]	IdReportConfig-A5		
}			
}			

Table 8.3.1.27.3.3-3: ReportConfigEUTRA-A5-RECONF (step 1, Table 8.3.1.27.3.2-2)

Derivation Path: 36.508, Table 4.6.6-6AB ReportConfigEUTRA-A5(-4, -8) with condition RSRQ			
Information Element	Value/remark	Comment	Condition
ReportConfigEUTRA ::= SEQUENCE {			
reportAmount	infinity		
}			

Table 8.3.1.27.3.3-4: *MeasurementReport* (step 5 and 6, Table 8.3.1.27.3.2-2)

Derivation Path: 36.508, Table 4.6.1-5			
Information Element	Value/remark	Comment	Condition
MeasurementReport ::= SEQUENCE {			
criticalExtensions CHOICE {			
c1 CHOICE{			
measurementReport-r8 SEQUENCE {			
measResults SEQUENCE {			
measId	1		
measResultServCell SEQUENCE {		Report Cell 1	
rsrpResult	(0..97)		
rsrqResult	(0..34)		
}			
measResultNeighCells CHOICE {			
measResultListEUTRA SEQUENCE (SIZE (1..maxCellReport)) OF SEQUENCE {	1 entry	Report Cell 3	
physCellId[1]	PhysicalCellIdentity of Cell 3		
cgi-Info[1]	Not present		
measResult[1] SEQUENCE {			
rsrpResult	(0..97)		
rsrqResult	(0..34)		
additionalSI-Info-r9	Not present		
}			
}			
}			
measResultForECID-r9	Not present		
}			
}			
}			

8.3.1.28 eICIC / Measurement configuration control and reporting / Event A3 / RSRP and RSRQ measurement / Serving ABS

8.3.1.28.1 Test Purpose (TP)

(1)

```
with { UE having completed the radio bearer establishment and initial security activation procedure }
ensure that {
  when { UE receives an RRCCONNECTIONRECONFIGURATION message including a MeasObject provided with all parameters including the neighbour cell measurement restriction pattern measSubframePatternPCell corresponding to Serving cell ABS pattern }
  then { UE transmits an RRCCONNECTIONRECONFIGURATIONCOMPLETE message }
}
```

(2)

```
with { UE having transmitted an RRCCONNECTIONRECONFIGURATIONCOMPLETE message and applied serving cell measurement restriction pattern measSubframePatternPCell, corresponding to serving cell ABS pattern }
ensure that {
  when { UE transmits MeasurementReport after A3 event }
  then { UE transmits RSRP and RSRQ measurements done in measSubframePatternPCell }
}
```

8.3.1.28.2 Conformance requirements

References: The conformance requirements covered in the present TC are specified in: TS 36.331, clauses 5.3.10.0, 5.3.10.8 and 5.5.3.1.

[TS 36.331, clause 5.3.10.0]

The UE shall:

...

- 1> if the received *radioResourceConfigDedicated* includes the *measSubframePatternPCell*:
 - 2> reconfigure the time domain measurement resource restriction for the serving cell as specified in 5.3.10.8;

[TS 36.331, clause 5.3.10.8]

The UE shall:

- 1> if the received *measSubframePatternPCell* is set to *release*:
 - 2> release the time domain measurement resource restriction for the PCell, if previously configured
- 1> else:
 - 2> apply the time domain measurement resource restriction for the PCell in accordance with the received *measSubframePatternPCell*;

[TS 36.331, clause 5.5.3.1]

For all measurements the UE applies the layer 3 filtering as specified in 5.5.3.2, before using the measured results for evaluation of reporting criteria or for measurement reporting.

The UE shall:

- 1> whenever the UE has a *measConfig*, perform RSRP and RSRQ measurements for each serving cell, applying for the PCell the time domain measurement resource restriction in accordance with *measSubframePatternPCell*, if configured;
- 1> for each *measId* included in the *measIdList* within *VarMeasConfig*:
 - 2> if the *purpose* for the associated *reportConfig* is set to *reportCGI*:
 - 3> if *si-RequestForHO* is configured for the associated *reportConfig*:
 - 4> perform the corresponding measurements on the frequency and RAT indicated in the associated *measObject* using autonomous gaps as necessary;
 - 3> else:
 - 4> perform the corresponding measurements on the frequency and RAT indicated in the associated *measObject* using available idle periods or using autonomous gaps as necessary;

NOTE 1: If autonomous gaps are used to perform measurements, the UE is allowed to temporarily abort communication with all serving cell(s), i.e. create autonomous gaps to perform the corresponding measurements within the limits specified in TS 36.133 [16]. Otherwise, the UE only supports the measurements with the purpose set to *reportCGI* only if E-UTRAN has provided sufficient idle periods.

- 3> try to acquire the global cell identity of the cell indicated by the *cellForWhichToReportCGI* in the associated *measObject* by acquiring the relevant system information from the concerned cell;
- 3> if the cell indicated by the *cellForWhichToReportCGI* included in the associated *measObject* is an E-UTRAN cell:
 - 4> try to acquire the CSG identity, if the CSG identity is broadcast in the concerned cell;
 - 4> try to acquire the *trackingAreaCode* in the concerned cell;
 - 4> try to acquire the list of additional PLMN Identities, as included in the *plmn-IdentityList*, if multiple PLMN identities are broadcast in the concerned cell;

NOTE 2: The 'primary' PLMN is part of the global cell identity.

- 3> if the cell indicated by the *cellForWhichToReportCGI* included in the associated *measObject* is a UTRAN cell:

- 4> try to acquire the LAC, the RAC and the list of additional PLMN Identities, if multiple PLMN identities are broadcast in the concerned cell;
- 4> try to acquire the CSG identity, if the CSG identity is broadcast in the concerned cell;
- 3> if the cell indicated by the *cellForWhichToReportCGI* included in the associated *measObject* is a GERAN cell:
 - 4> try to acquire the RAC in the concerned cell;
- 3> if the cell indicated by the *cellForWhichToReportCGI* included in the associated *measObject* is a CDMA2000 cell and the *cdma2000-Type* included in the *measObject* is *typeHRPD*:
 - 4> try to acquire the Sector ID in the concerned cell;
- 3> if the cell indicated by the *cellForWhichToReportCGI* included in the associated *measObject* is a CDMA2000 cell and the *cdma2000-Type* included in the *measObject* is *type1XRTT*:
 - 4> try to acquire the BASE ID, SID and NID in the concerned cell;
- 2> else:
 - 3> if a measurement gap configuration is setup; or
 - 3> if the UE does not require measurement gaps to perform the concerned measurements:
 - 4> if *s-Measure* is not configured; or
 - 4> if *s-Measure* is configured and the PCell RSRP, after layer 3 filtering, is lower than this value:
 - 5> perform the corresponding measurements of neighbouring cells on the frequencies and RATs indicated in the concerned *measObject*, applying for neighbouring cells on the primary frequency the time domain measurement resource restriction in accordance with *measSubframePatternConfigNeigh*, if configured in the concerned *measObject*;
 - 4> if the *ue-RxTxTimeDiffPeriodical* is configured in the associated *reportConfig*:
 - 5> perform the UE Rx–Tx time difference measurements on the PCell;
 - 2> perform the evaluation of reporting criteria as specified in 5.5.4;

NOTE 3: The *s-Measure* defines when the UE is required to perform measurements. The UE is however allowed to perform measurements also when the PCell RSRP exceeds *s-Measure*, e.g., to measure cells broadcasting a CSG identity following use of the autonomous search function as defined in TS 36.304 [4].

8.3.1.28.3 Test description

8.3.1.28.3.1 Pre-test conditions

System Simulator:

- Cell 1 and Cell 2.

UE:

None.

Preamble:

- The UE is in state Generic RB Established (state 3) on Cell 1 according to [18].

8.3.1.28.3.2 Test procedure sequence

Table 8.3.1.28.3.2-1 illustrates the downlink power levels and other changing parameters to be applied for the cells at various time instants of the test execution. Row marked "T0" denotes the initial conditions after preamble, while columns marked "T1" is to be applied subsequently. The exact instants on which these values shall be applied are described in the texts in this clause.

Table 8.3.1.28.3.2-1: Time instances of cell power level and parameter changes

	Parameter	Unit	Cell 1	Cell 2	Remark
T0	Cell-specific RS EPRE	dBm/15k Hz	-85	-91	The power level values are such that measurement results for Cell 1 (M1) and Cell 2 (M2) satisfy exit condition for event A3 ($M2 < M1$).
T1	Cell-specific RS EPRE	dBm/15k Hz	-85	-79	The power level values are such that measurement results for Cell 1 (M1) and Cell 2 (M2) satisfy entry condition for event A3 ($M2 > M1$). Serving Pattern (<i>measSubframePatternPCell</i>) is the serving cell's ABS.

Table 8.3.1.28.3.2-2: Main behaviour

St	Procedure	Message Sequence		TP	Verdict
		U - S	Message		
1	The SS transmits an <i>RRCCONNECTIONRECONFIGURATION</i> message on Cell 1 to setup intra frequency measurement.	<--	<i>RRCCONNECTIONRECONFIGURATION</i>	-	-
2	The UE transmits an <i>RRCCONNECTIONRECONFIGURATIONCOMPLETE</i> message on Cell 1 to confirm the setup of intra frequency measurement.	-->	<i>RRCCONNECTIONRECONFIGURATIONCOMPLETE</i>	1	P
3	The SS changes Cell 1 and Cell 2 parameters according to the row "T1" in table 8.3.1.28.3.2-1.	-	-	-	-
4	Check: Does the UE transmit a <i>MEASUREMENTREPORT</i> message on Cell 1 to report event A3 with the measured expected RSRP and RSRQ values for Cell 2?	-->	<i>MEASUREMENTREPORT</i>	2	P
5	Check: Does the UE transmit RSRP and RSRQ measurements in serving cell measurement restriction pattern?	-	-	-	-

8.3.1.28.3.3 Specific message contents

Table 8.3.1.28.3.3-1: *RRCCONNECTIONRECONFIGURATION* (step 1, Table 8.3.1.28.3.2-2)

Derivation Path: 36.508 clause 4.6.1 table 4.6.1-8 with condition PCell-PATTERN

Table 8.3.1.28.3.3-2: *MeasConfig* (step 1, Table 8.3.1.28.3.2-2)

Derivation Path: 36.508 clause 4.6.6 table 4.6.6-1 with condition eICIC			
Information Element	Value/remark	Comment	Condition
<i>measConfig</i> ::= SEQUENCE {			
<i>measObjectToAddModList</i> SEQUENCE (SIZE (1.. <i>maxObjectId</i>)) OF SEQUENCE {	1 entry		
<i>measObjectId</i> [1]	IdMeasObject-f1		
<i>measObject</i> [1]	MeasObjectEUTRA-GENERIC		
}			
<i>reportConfigToAddModList</i> ::= SEQUENCE {	ReportConfigToAddModList_DEFAULT		
}			
<i>measIdToAddModList</i> ::= SEQUENCE {	MeasIdToAddModList_DEFAULT		
}			
}			

8.3.2 Inter-RAT measurements

8.3.2.1 Measurement configuration control and reporting / Inter-RAT measurements / Event B2 / Measurement of GERAN cells

8.3.2.1.1 Test Purpose (TP)

(1)

```
with { UE having completed the radio bearer establishment, initial security activation procedure and
performed the inter RAT measurement for GERAN cell and not detected entering condition for the event
B2 is met }
ensure that {
  when { UE detects entering condition for the event B2 is not met }
  then { UE does not transmit any MeasurementReport }
}
```

(2)

```
with { UE having completed the radio bearer establishment, initial security activation procedure and
performed the inter RAT measurement for GERAN cell and not detected entering condition for the event
B2 is met }
ensure that {
  when { UE detects entering condition for the event B2 is met }
  then { UE transmits a MeasurementReport }
}
```

(3)

```
with { UE having completed the radio bearer establishment, initial security activation procedure and
performed the inter RAT measurement for GERAN cell and detected entering condition for the event B2
is met }
ensure that {
  when { UE detects leaving condition for the event B2 is met }
  then { UE does not transmit any MeasurementReport }
}
```

8.3.2.1.2 Conformance requirements

References: The conformance requirements covered in the present TC are specified in: TS 36.331, clause 5.5.4.1, 5.5.4.8 and 5.5.5.

[TS 36.331, clause 5.5.4.1]

The UE shall:

1> for each *measId* included in the *measIdList* within *VarMeasConfig*:

...

2> else:

...

3> else if the corresponding *measObject* concerns GERAN:

4> consider a neighbouring cell on the associated set of frequencies to be applicable when the concerned cell matches the *ncc-Permitted* defined within the *VarMeasConfig* for this *measId*;

2> if the *triggerType* is set to 'event' and if the entry condition applicable for this event, i.e. the event corresponding with the *eventId* of the corresponding *reportConfig* within *VarMeasConfig*, is fulfilled for one or more applicable cells for all measurements after layer 3 filtering taken during *timeToTrigger* defined for this event within the *VarMeasConfig*, while the *VarMeasReportList* does not include an measurement reporting entry for this *measId* (a first cell triggers the event):

3> include a measurement reporting entry within the *VarMeasReportList* for this *measId*;

3> set the *numberOfReportsSent* defined within the *VarMeasReportList* for this *measId* to 0;

3> include the concerned cell(s) in the *cellsTriggeredList* defined within the *VarMeasReportList* for this *measId*;

- 3> initiate the measurement reporting procedure, as specified in 5.5.5;
- 2> if the *triggerType* is set to 'event' and if the entry condition applicable for this event, i.e. the event corresponding with the *eventId* of the corresponding *reportConfig* within *VarMeasConfig*, is fulfilled for one or more applicable cells not included in the *cellsTriggeredList* for all measurements after layer 3 filtering taken during *timeToTrigger* defined for this event within the *VarMeasConfig* (a subsequent cell triggers the event):
 - 3> set the *numberOfReportsSent* defined within the *VarMeasReportList* for this *measId* to 0;
 - 3> include the concerned cell(s) in the *cellsTriggeredList* defined within the *VarMeasReportList* for this *measId*;
 - 3> initiate the measurement reporting procedure, as specified in 5.5.5;
- 2> if the *triggerType* is set to 'event' and if the leaving condition applicable for this event is fulfilled for one or more of the cells included in the *cellsTriggeredList* defined within the *VarMeasReportList* for this *measId* for all measurements after layer 3 filtering taken during *timeToTrigger* defined within the *VarMeasConfig* for this event:
 - 3> remove the concerned cell(s) in the *cellsTriggeredList* defined within the *VarMeasReportList* for this *measId*;
 - 3> if *reportOnLeave* is set to *TRUE* for the corresponding reporting configuration:
 - 4> initiate the measurement reporting procedure, as specified in 5.5.5;
 - 3> if the *cellsTriggeredList* defined within the *VarMeasReportList* for this *measId* is empty:
 - 4> remove the measurement reporting entry within the *VarMeasReportList* for this *measId*;
 - 4> stop the periodical reporting timer for this *measId*, if running;
- 2> if the *purpose* is included and set to 'reportStrongestCells' or to 'reportStrongestCellsForSON' and if a (first) measurement result is available for one or more applicable cells:
 - 3> include a measurement reporting entry within the *VarMeasReportList* for this *measId*;
 - 3> set the *numberOfReportsSent* defined within the *VarMeasReportList* for this *measId* to 0;
 - 3> initiate the measurement reporting procedure, as specified in 5.5.5;

NOTE 1: If the *purpose* is set to 'reportStrongestCells', the UE initiates a first measurement report immediately after the quantity to be reported becomes available for at least either serving cell or one of the applicable cells. If the *purpose* is set to 'reportStrongestCellsForSON', the UE initiates a first measurement report when it has determined the strongest cells on the associated frequency.

- 2> upon expiry of the periodical reporting timer for this *measId*:
 - 3> initiate the measurement reporting procedure, as specified in 5.5.5;

...

NOTE 2: The UE does not stop the periodical reporting with *triggerType* set to 'event' or to 'periodical' while the corresponding measurement is not performed due to the serving cell RSRP being equal to or better than *s-Measure* or due to the measurement gap not being setup.

NOTE 3: If the UE is configured with DRX, the UE may delay the measurement reporting for event triggered and periodical triggered measurements until the Active Time, which is defined in TS 36.321 [6].

[TS 36.331, clause 5.5.4.8]

The UE shall:

- 1> for UTRA and CDMA2000, only trigger the event for cells included in the corresponding measurement object;

1> consider the entering condition for this event to be satisfied when both condition B2-1 and condition B2-2, as specified below, are fulfilled;

1> consider the leaving condition for this event to be satisfied when condition B2-3 or condition B2-4, i.e. at least one of the two, as specified below, is fulfilled;

Inequality B2-1 (Entering condition 1)

$$Ms + Hys < Thresh1$$

Inequality B2-2 (Entering condition 2)

$$Mn + Ofn - Hys > Thresh2$$

Inequality B2-3 (Leaving condition 1)

$$Ms - Hys > Thresh1$$

Inequality B2-4 (Leaving condition 2)

$$Mn + Ofn + Hys < Thresh2$$

The variables in the formula are defined as follows:

Ms is the measurement result of the serving cell, not taking into account any offsets.

Mn is the measurement result of the inter-RAT neighbour cell, not taking into account any offsets.

Ofn is the frequency specific offset of the frequency of the inter-RAT neighbour cell (i.e. *offsetFreq* as defined within the *measObject* corresponding to the frequency of the inter-RAT neighbour cell).

Hys is the hysteresis parameter for this event (i.e. *hysteresis* as defined within *reportConfigInterRAT* for this event).

Thresh1 is the threshold parameter for this event (i.e. *b2-Threshold1* as defined within *reportConfigInterRAT* for this event).

Thresh2 is the threshold parameter for this event (i.e. *b2-Threshold2* as defined within *reportConfigInterRAT* for this event).

Ms is expressed in dBm in case of RSRP, or in dB in case of RSRQ.

Mn is expressed in dBm or dB, depending on the measurement quantity of the inter-RAT neighbour cell.

Ofn, Hys are expressed in dB.

Thresh1 is expressed in the same unit as **Ms**.

Thresh2 is expressed in the same unit as **Mn**.

[TS 36.331, clause 5.5.5]

For the *measId* for which the measurement reporting procedure was triggered, the UE shall set the *measResults* within the *MeasurementReport* message as follows:

1> set the *measId* to the measurement identity that triggered the measurement reporting;

1> set the *measResultServCell* to include the quantities of serving cell;

1> if there is at least one applicable neighbouring cell to report:

2> set the *measResultsNeighCells* to include the best neighbouring cells up to *maxReportCells* in accordance with the following:

3> if the *triggerType* is set to 'event':

4> include the cells included in the *cellsTriggeredList* as defined within the *VarMeasReportList* for this *measId*;

3> else:

4> include the applicable cells for which the new measurement results became available since the last periodical reporting or since the measurement was initiated or reset;

NOTE: The reliability of the report (i.e. the certainty it contains the strongest cells on the concerned frequency) depends on the measurement configuration i.e. the *reportInterval*. The related performance requirements are specified in TS 36.133 [16].

3> for each cell that is included in the *measResultsNeighCells*, include the *physCellId*;

3> if the *triggerType* is set to 'event'; or the *purpose* is set to 'reportStrongestCells' or to 'reportStrongestCellsForSON':

4> for each included cell, include the layer 3 filtered measured results in accordance with the *reportConfig* for this *measId*, ordered as follows:

5> if the *measObject* associated with this *measId* concerns E-UTRA:

6> set the *measResult* to include the quantity(ies) indicated in the *reportQuantity* within the concerned *reportConfig* in order of decreasing *triggerQuantity*, i.e. the best cell is included first;

5> else:

6> set the *measResult* to the quantity as configured for the concerned RAT within the *quantityConfig* in order of decreasing quantity, i.e. the best cell is included first;

...

1> increment the *numberOfReportsSent* as defined within the *VarMeasReportList* for this *measId* by 1;

1> stop the periodical reporting timer, if running;

1> if the *numberOfReportsSent* as defined within the *VarMeasReportList* for this *measId* is less than the *reportAmount* as defined within the corresponding *reportConfig* for this *measId*:

2> start the periodical reporting timer with the value of *reportInterval* as defined within the corresponding *reportConfig* for this *measId*;

...

1> submit the *MeasurementReport* message to lower layers for transmission, upon which the procedure ends;

8.3.2.1.3 Test description

8.3.2.1.3.1 Pre-test conditions

System Simulator:

- Cell 1 and Cell 24.
- System information combination 5 as defined in TS 36.508 [18] clause 4.4.3.1 is used in E-UTRA cells.

UE:

None.

Preamble:

- The UE is in state Generic RB Established (state 3) on Cell 1 according to [18].

8.3.2.1.3.2 Test procedure sequence

Table 8.3.2.1.3.2-1 illustrates the downlink power levels and other changing parameters to be applied for the cells at various time instants of the test execution. Row marked "T0" denotes the initial conditions after preamble, while columns marked "T1" and "T2" are to be applied subsequently. The exact instants on which these values shall be applied are described in the texts in this clause.

Table 8.3.2.1.3.2-1: Time instances of cell power level and parameter changes

	Parameter	Unit	Cell 1	Cell 24	Remark
T0	Cell-specific RS EPRE	dBm/15k Hz	-60	-	The power level values are such that entering conditions for event B2 are not satisfied.
	RSSI	dBm	-	-85	
T1	Cell-specific RS EPRE	dBm/15k Hz	-80	-	The power level values are such that entering conditions for event B2 are satisfied.
	RSSI	dBm	-	-65	
T2	Cell-specific RS EPRE	dBm/15k Hz	-60	-	The power level values are such that leaving conditions for event B2 are satisfied.
	RSSI	dBm	-	-85	

Table 8.3.2.1.3.2-2: Main behaviour

St	Procedure	Message Sequence		TP	Verdict
		U - S	Message		
1	The SS transmits an <i>RRCCONNECTIONRECONFIGURATION</i> message to setup inter RAT measurement on Cell 1.	<--	<i>RRCCONNECTIONRECONFIGURATION</i>	-	-
2	The UE transmits an <i>RRCCONNECTIONRECONFIGURATIONCOMPLETE</i> message to confirm the setup of inter RAT measurement on Cell 1.	-->	<i>RRCCONNECTIONRECONFIGURATIONCOMPLETE</i>	-	-
3	Check: Does the UE transmit a <i>MEASUREMENTREPORT</i> message to report the event B2 during the next 10s?	-->	<i>MEASUREMENTREPORT</i>	1	F
4	The SS changes Cell 1 and Cell 24 parameters according to the row "T1" in table 8.3.2.1.3.2-1.	-	-	-	-
5	Check: Does the UE transmit a <i>MEASUREMENTREPORT</i> message to report the event B2 for Cell 24?	-->	<i>MEASUREMENTREPORT</i>	2	P
6	The SS changes Cell 1 and Cell 24 parameters according to the row "T2" in table 8.3.2.1.3.2-1.	-	-	-	-
7	Wait and ignore <i>MEASUREMENTREPORT</i> messages for 15 s to allow change of power levels for Cells 1 and Cell 24.	-	-	-	-
8	Check: Does the UE transmit a <i>MEASUREMENTREPORT</i> message to report the event B2 during the next 10s?	-->	<i>MEASUREMENTREPORT</i>	3	F
9	Check: Does the test result of generic test procedure in TS 36.508 subclause 6.4.2.3 indicate that the UE is in E-UTRA RRC_CONNECTED state on Cell 1?	-	-	1, 2, 3	-

8.3.2.1.3.3 Specific message contents

Table 8.3.2.1.3.3-1: *RRCCONNECTIONRECONFIGURATION* (step 1, Table 8.3.2.1.3.2-2)

Derivation Path: 36.508, Table 4.6.1-8, condition MEAS
--

Table 8.3.2.1.3.3-2: MeasConfig (Table 8.3.2.1.3.3-1)

Derivation Path: 36.508, Table 4.6.6-1, condition GERAN			
Information Element	Value/remark	Comment	Condition
MeasConfig ::= SEQUENCE {			
measObjectToAddModList SEQUENCE (SIZE (1..maxObjectId)) OF SEQUENCE {	2 entries		
measObjectId[1]	IdMeasObject-f1		
measObject[1]	MeasObjectEUTRA- GENERIC(f1)		
measObjectId[2]	IdMeasObject-f11		
measObject[2]	MeasObjectGERAN- GENERIC(f11)		
}			
reportConfigToAddModList SEQUENCE (SIZE (1..maxReportConfigId)) OF SEQUENCE {	1 entry		
reportConfigId[1]	IdReportConfig-B2- GERAN		
reportConfig[1]	ReportConfigInterRAT- B2-GERAN(-69, -79)		
}			
measIdToAddModList SEQUENCE (SIZE (1..maxMeasId)) OF SEQUENCE {	1 entry		
measId[1]	1		
measObjectId[1]	IdMeasObject-f11		
reportConfigId[1]	IdReportConfig-B2- GERAN		
}			
quantityConfig SEQUENCE {			
quantityConfigGERAN SEQUENCE {			
measQuantityGERAN	rssi		
filterCoefficient	fc0		
}			
}			
}			

Table 8.3.2.1.3.3-2A: ReportConfigInterRAT-B2-GERAN (Table 8.3.2.1.3.3-2)

Derivation path: 36.508, Table 4.6.6-7E ReportConfigInterRAT-B2-GERAN(-69, -79)			
Information Element	Value/remark	Comment	Condition
ReportConfigInterRAT-B2-GERAN ::= SEQUENCE {			
reportAmount	infinity		
}			

Table 8.3.2.1.3.3-3: *MeasurementReport* (step 5, Table 8.3.2.1.3.2-2)

Derivation Path: 36.508, Table 4.6.1-5			
Information Element	Value/remark	Comment	Condition
MeasurementReport ::= SEQUENCE {			
criticalExtensions CHOICE {			
c1 CHOICE{			
measurementReport-r8 SEQUENCE {			
measResults SEQUENCE {			
measId	1		
measResultServCell SEQUENCE {			
rsrpResult	(0..97)		
rsrqResult	(0..34)		
}			
measResultsNeighCells CHOICE {			
measResultListGERAN SEQUENCE (SIZE (1..maxCellReport)) OF SEQUENCE {	1 entry		
carrierFreq[1] SEQUENCE {			
arfcn	Not checked		
bandIndicator	Not checked		
}			
physCellId[1]	PhysicalCellIdentity of Cell 24		
cgi-info[1]	Not present		
measResult[1] SEQUENCE {			
rssi	(0..63)		
}			
}			
}			
}			
}			
}			
}			

8.3.2.2 Measurement configuration control and reporting / Inter-RAT measurements / Periodic reporting / Measurement of GERAN cells

8.3.2.2.1 Test Purpose (TP)

(1)

```
with { UE having completed the radio bearer establishment, initial security activation procedure and
performed the inter RAT measurement for GERAN cell }
ensure that {
  when { The UE receives reference signal power for cells on the GERAN frequencies where
measurements are configured }
    then { UE sends MeasurementReport message at regular intervals for these GERAN cells }
}
```

(2)

```
with { UE in E-UTRA RRC_CONNECTED state and a MeasurementReport message for a configured periodic
measurement reporting of GERAN cells on a configured frequency were sent }
ensure that {
  when { A previously reported cell become unavailable and the UE receives reference signal power on
a reported GERAN frequency for a cell which was previously not reported }
    then { UE sends MeasurementReport message at regular intervals for the available GERAN cells }
}
```

(3)

```
with { UE in E-UTRA RRC_CONNECTED state and periodic measurement reporting of GERAN cells ongoing }
ensure that {
  when { The UE receives a RRCConnectionReconfiguration message removing the measId of periodic
reporting of GERAN cells }
    then { UE stops sending MeasurementReport message for GERAN cells }
}
```

}

8.3.2.2.2 Conformance requirements

References: The conformance requirements covered in the present TC are specified in: TS 36.331, clause 5.3.5.3, 5.5.2.2, 5.5.4.1 and 5.5.5.

[TS 36.331, clause 5.3.5.3]

If the *RRConnectionReconfiguration* message does not include the *mobilityControlInfo* and the UE is able to comply with the configuration included in this message, the UE shall:

...

- 1> if the *RRConnectionReconfiguration* message includes the *measConfig*:
 - 2> perform the measurement configuration procedure as specified in 5.5.2;

[TS 36.331, clause 5.5.2.2]

The UE shall:

- 1> for each *measId* included in the received *measIdToRemoveList* that is part of the current UE configuration in *varMeasConfig*:
 - 2> remove the entry with the matching *measId* from the *measIdList* within the *VarMeasConfig*;
 - 2> remove the measurement reporting entry for this *measId* from the *VarMeasReportList*, if included;
 - 2> stop the periodical reporting timer or timer T321, whichever one is running, and reset the associated information (e.g. *timeToTrigger*) for this *measId*;

NOTE: The UE does not consider the message as erroneous if the *measIdToRemoveList* includes any *measId* value that is not part of the current UE configuration.

[TS 36.331, clause 5.5.4.1]

The UE shall:

- 1> for each *measId* included in the *measIdList* within *VarMeasConfig*:
 - ...
 - 2> else:
 - ...
 - 3> else if the corresponding *measObject* concerns GERAN:
 - 4> consider a neighbouring cell on the associated set of frequencies to be applicable when the concerned cell matches the *ncc-Permitted* defined within the *VarMeasConfig* for this *measId*;
 - ...
 - 2> if the *purpose* is included and set to ‘*reportStrongestCells*’ or to ‘*reportStrongestCellsForSON*’ and if a (first) measurement result is available for one or more applicable cells:
 - 3> include a measurement reporting entry within the *VarMeasReportList* for this *measId*;
 - 3> set the *numberOfReportsSent* defined within the *VarMeasReportList* for this *measId* to 0;
 - 3> initiate the measurement reporting procedure, as specified in 5.5.5;

NOTE 1: If the *purpose* is set to ‘*reportStrongestCells*’, the UE initiates a first measurement report immediately after the quantity to be reported becomes available for at least either serving cell or one of the applicable cells. If the *purpose* is set to ‘*reportStrongestCellsForSON*’, the UE initiates a first measurement report when it has determined the strongest cells on the associated frequency.

- 2> upon expiry of the periodical reporting timer for this *measId*:
- 3> initiate the measurement reporting procedure, as specified in 5.5.5;

...

NOTE 2: The UE does not stop the periodical reporting with *triggerType* set to 'event' or to 'periodical' while the corresponding measurement is not performed due to the serving cell RSRP being equal to or better than *s-Measure* or due to the measurement gap not being setup.

NOTE 3: If the UE is configured with DRX, the UE may delay the measurement reporting for event triggered and periodical triggered measurements until the Active Time, which is defined in TS 36.321 [6].

[TS 36.331, clause 5.5.5]

The purpose of this procedure is to transfer measurement results from the UE to E-UTRAN.

For the *measId* for which the measurement reporting procedure was triggered, the UE shall set the *measResults* within the *MeasurementReport* message as follows:

- 1> set the *measId* to the measurement identity that triggered the measurement reporting;
- 1> set the *measResultServCell* to include the quantities of serving cell;
- 1> if there is at least one applicable neighbouring cell to report:
 - 2> set the *measResultNeighCells* to include the best neighbouring cells up to *maxReportCells* in accordance with the following:

...

3> else:

- 4> include the applicable cells for which the new measurement results became available since the last periodical reporting or since the measurement was initiated or reset;

NOTE: The reliability of the report (i.e. the certainty it contains the strongest cells on the concerned frequency) depends on the measurement configuration i.e. the *reportInterval*. The related performance requirements are specified in TS 36.133 [16].

- 3> for each cell that is included in the *measResultNeighCells*, include the *physCellId*;
- 3> if the *triggerType* is set to 'event'; or the *purpose* is set to 'reportStrongestCells' or to 'reportStrongestCellsForSON':
 - 4> for each included cell, include the layer 3 filtered measured results in accordance with the *reportConfig* for this *measId*, ordered as follows:
 - 5> if the *measObject* associated with this *measId* concerns E-UTRA:
 - 6> set the *measResult* to include the quantity(ies) indicated in the *reportQuantity* within the concerned *reportConfig* in order of decreasing *triggerQuantity*, i.e. the best cell is included first;
 - 5> else:
 - 6> set the *measResult* to the quantity as configured for the concerned RAT within the *quantityConfig* in order of decreasing quantity, i.e. the best cell is included first;

...

- 1> increment the *numberOfReportsSent* as defined within the *VarMeasReportList* for this *measId* by 1;
- 1> stop the periodical reporting timer, if running;
- 1> if the *numberOfReportsSent* as defined within the *VarMeasReportList* for this *measId* is less than the *reportAmount* as defined within the corresponding *reportConfig* for this *measId*:

2> start the periodical reporting timer with the value of *reportInterval* as defined within the corresponding *reportConfig* for this *measId*;

1> else:

2> if the *triggerType* is set to 'periodical':

3> remove the entry within the *VarMeasReportList* for this *measId*;

3> remove this *measId* from the *measIdList* within *VarMeasConfig*;

...

1> submit the *MeasurementReport* message to lower layers for transmission, upon which the procedure ends;

8.3.2.2.3 Test description

8.3.2.2.3.1 Pre-test conditions

System Simulator:

- Cell 3, Cell 25 and Cell 26.
- System information combination 5 as defined in TS 36.508 [18] clause 4.4.3.1 is used in E-UTRA cells.

UE:

None.

Preamble:

- The UE is in state Generic RB Established (state 3) on Cell 3 according to [18].

8.3.2.2.3.2 Test procedure sequence

Table 8.3.2.2.3.2-1 illustrates the downlink power levels and other changing parameters to be applied for the cells at various time instants of the test execution. Row marked "T0" denotes the initial conditions after preamble, while columns marked "T1" and "T2" are to be applied subsequently. The exact instants on which these values shall be applied are described in the texts in this clause.

Table 8.3.2.2.3.2-1: Time instances of cell power level and parameter changes

	Parameter	Unit	Cell 3	Cell 25	Cell 26	Remark
T0	Cell-specific RS EPRE	dBm/15k Hz	-60	-	-	The power level values are such that camping on Cell 3 is guarantee.
	RSSI	dBm	-	Off	Off	
T1	Cell-specific RS EPRE	dBm/15k Hz	-60	-	-	The power level values are such that Cell 25 is satisfied for periodic reporting.
	RSSI	dBm	-	-70	Off	
T2	Cell-specific RS EPRE	dBm/15k Hz	-60	-	-	The power level values are such that Cell 26 is satisfied for periodic reporting and Cell 25 become unavailable.
	RSSI	dBm	-	Off	-70	

Table 8.3.2.2.3.2-2: Main behaviour

St	Procedure	Message Sequence		TP	Verdict
		U - S	Message		
1	The SS transmits an <i>RRCCONNECTIONRECONFIGURATION</i> message to setup inter-RAT measurement.	<--	<i>RRCCONNECTIONRECONFIGURATION</i>	-	-
2	The UE transmits an <i>RRCCONNECTIONRECONFIGURATIONCOMPLETE</i> message to confirm the setup of inter-RAT measurement.	-->	<i>RRCCONNECTIONRECONFIGURATIONCOMPLETE</i>	-	-
3	The SS power "On" Cell 25 according to the row "T1" in table 8.3.2.2.3.2-1.	-	-	-	-
4	Wait and ignore <i>MEASUREMENTREPORT</i> messages for 8s to allow power "On" for Cell 25.	-	-	-	-
-	EXCEPTION: In parallel to events described in steps 5 to 6 the steps specified in table 8.3.2.2.3.2-3 shall take place	-	-	-	-
5	Wait for 30 s to ensure that the UE performs a inter-RAT periodical reporting.	-	-	-	-
6	The SS power "Off" Cell 25 and power "On" Cell 26 according to the row "T2" in table 8.3.2.2.3.2-1.	-	-	-	-
7	Wait and ignore <i>MEASUREMENTREPORT</i> messages for 8s to allow power "Off" and power "On" for Cell 25 and Cell 26 respectively.	-	-	-	-
-	EXCEPTION: In parallel to events described in steps 8 to 9 the steps specified in table 8.3.2.2.3.2-4 shall take place	-	-	-	-
8	Wait for 30 s to ensure that the UE performs a inter-RAT periodical reporting.	-	-	-	-
9	The SS transmits an <i>RRCCONNECTIONRECONFIGURATION</i> message to remove inter-RAT measurement.	<--	<i>RRCCONNECTIONRECONFIGURATION</i>	-	-
10	The UE transmits an <i>RRCCONNECTIONRECONFIGURATIONCOMPLETE</i> message to confirm the remove of inter-RAT measurement.	-->	<i>RRCCONNECTIONRECONFIGURATIONCOMPLETE</i>	-	-
11	Check: Does the UE attempt to transmit an uplink message for the next 10s?	-	-	3	F

Table 8.3.2.2.3.2-3: Parallel behaviour

St	Procedure	Message Sequence		TP	Verdict
		U - S	Message		
-	EXCEPTION: After the 1st message is received, step 1 below shall be repeated every time the duration indicated in the IE <i>reportInterval</i> has elapsed	-	-	-	-
1	Check: Does the UE transmit a <i>MEASUREMENTREPORT</i> message to perform periodical reporting for Cell 25?	-->	<i>MEASUREMENTREPORT</i>	1	P

Table 8.3.2.2.3.2-4: Parallel behaviour

St	Procedure	Message Sequence		TP	Verdict
		U - S	Message		
-	EXCEPTION: After the 1st message is received, step 1 below shall be repeated every time the duration indicated in the IE <i>reportInterval</i> has elapsed.	-	-	-	-
1	Check: Does the UE transmit a <i>MeasurementReport</i> message to perform periodical reporting for Cell 26(NOTE1)?	-->	<i>MeasurementReport</i>	1, 2	P

NOTE1: Cell 25 may be included in the *MeasurementReport* due to UE averages power levels over a period of time.

8.3.2.2.3.3 Specific message contents

Table 8.3.2.2.3.3-1: RRCConnectionReconfiguration (step 1, Table 8.3.2.2.3.2-2)

Derivation Path: 36.508, Table 4.6.1-8, condition MEAS

Table 8.3.2.2.3.3-2: MeasConfig (Table 8.3.2.2.3.3-1)

Derivation Path: 36.508, Table 4.6.6-1, condition GERAN			
Information Element	Value/remark	Comment	Condition
MeasConfig ::= SEQUENCE {			
measObjectToAddModList SEQUENCE (SIZE (1..maxObjectId)) OF SEQUENCE {	2 entries		
measObjectId[1]	IdMeasObject-f2		
measObject[1]	MeasObjectEUTRA-GENERIC(f2)		
measObjectId[2]	IdMeasObject-f12		
measObject[2]	MeasObjectGERAN-GENERIC(f12)		
}			
reportConfigToAddModList SEQUENCE (SIZE (1..maxReportConfigId)) OF SEQUENCE {	1 entry		
reportConfigId[1]	IdReportConfigInterRAT - PERIODICAL		
reportConfig[1]	ReportConfigInterRAT - PERIODICAL		
}			
measIdToAddModList SEQUENCE (SIZE (1..maxMeasId)) OF SEQUENCE {	1 entry		
measId[1]	1		
measObjectId[1]	IdMeasObject-f12		
reportConfigId[1]	IdReportConfigInterRAT - PERIODICAL		
}			
}			

Table 8.3.2.3.3-3: MeasurementReport (step 1, Table 8.3.2.3.2-3)

Derivation Path: 36.508, Table 4.6.1-5			
Information Element	Value/remark	Comment	Condition
MeasurementReport ::= SEQUENCE {			
criticalExtensions CHOICE {			
c1 CHOICE{			
measurementReport-r8 SEQUENCE {			
measResults SEQUENCE {			
measId	1		
measResultServCell SEQUENCE {			
rsrpResult	(0..97)		
rsrqResult	(0..34)		
}			
measResultsNeighCells CHOICE {			
measResultListGERAN SEQUENCE (SIZE (1..maxCellReport)) OF SEQUENCE {	1 entry		
carrierFreq[1] SEQUENCE {			
arfcn	Not checked		
bandIndicator	Not checked		
}			
physCellId[1]	PhysicalCellIdentity of Cell 25		
cgi-info[1]	Not present		
measResult[1] SEQUENCE {			
rssi	(0..63)		
}			
}			
}			
}			
}			
}			
}			

Table 8.3.2.2.3.3-4: MeasurementReport (step 1, Table 8.3.2.2.3.2-4)

Derivation Path: 36.508, Table 4.6.1-5			
Information Element	Value/remark	Comment	Condition
MeasurementReport ::= SEQUENCE {			
criticalExtensions CHOICE {			
c1 CHOICE{			
measurementReport-r8 SEQUENCE {			
measResults SEQUENCE {			
measId	1		
measResultServCell SEQUENCE {			
rsrpResult	(0..97)		
rsrqResult	(0..34)		
}			
measResultsNeighCells CHOICE {			
measResultListGERAN SEQUENCE (SIZE (1..maxCellReport)) OF SEQUENCE {	1 entry		
carrierFreq[1] SEQUENCE {			
arfcn	Not checked		
bandIndicator	Not checked		
}			
physCellId[1]	PhysicalCellIdentity of Cell 26		
cgi-info[1]	Not present		
measResult[1] SEQUENCE {			
rssi	(0..63)		
}			
}			
}			
}			
}			
}			

Table 8.3.2.2.3.3-5: RRCConnectionReconfiguration (step 9, Table 8.3.2.2.3.2-2)

Derivation Path: 36.508, Table 4.6.1-8, condition MEAS
--

Table 8.3.2.2.3.3-6: MeasConfig (Table 8.3.2.2.3.3-5)

Derivation Path: 36.508, Table 4.6.6-1			
Information Element	Value/remark	Comment	Condition
MeasConfig ::= SEQUENCE {			
measIdToRemoveList SEQUENCE (SIZE (1..maxMeasId)) OF SEQUENCE {	1 entry		
measId[1]	1		
}			
}			

8.3.2.3 Measurement configuration control and reporting / Inter-RAT measurements / Event B2 / Measurement of UTRAN cells

8.3.2.3.1 Test Purpose (TP)

(1)

```

with { UE having completed the radio bearer establishment, initial security activation procedure and
performed the inter RAT measurement for UTRA cell and not detected entering condition for the event
B2 is met }
ensure that {
  when { UE detects entering condition for the event B2 is not met }
    then { UE does not transmit any MeasurementReport }
}
    
```

(2)

```

with { UE having completed the radio bearer establishment, initial security activation procedure and
performed the inter RAT measurement for UTRA cell and not detected entering condition for the event
B2 is met }
ensure that {
  when { UE detects entering condition for the event B2 is met }
  then { UE transmits a MeasurementReport }
}

```

(3)

```

with { UE having completed the radio bearer establishment, initial security activation procedure and
performed the inter RAT measurement for UTRA cell and detected entering condition for the event B2
is met }
ensure that {
  when { UE detects leaving condition for the event B2 is met }
  then { UE does not transmit any MeasurementReport }
}

```

8.3.2.3.2 Conformance requirements

References: The conformance requirements covered in the present TC are specified in: TS 36.331, clause 5.5.4.1, 5.5.4.8 and 5.5.5.

[TS 36.331, clause 5.5.4.1]

The UE shall:

- 1> for each *measId* included in the *measIdList* within *VarMeasConfig*:
 - 2> if the corresponding *reportConfig* includes a purpose set to '*reportStrongestCellsForSON*':

...
 - 2> else:
 - 3> if the corresponding *measObject* concerns E-UTRA:

...
 - 3> else if the corresponding *measObject* concerns UTRA or CDMA2000:
 - 4> consider a neighbouring cell on the associated frequency to be applicable when the concerned cell is included in the *cellsToAddModList* defined within the *VarMeasConfig* for this *measId* (i.e. the cell is included in the white-list);
 - 3> else if the corresponding *measObject* concerns GERAN:
 - 4> consider a neighbouring cell on the associated set of frequencies to be applicable when the concerned cell matches the *ncc-Permitted* defined within the *VarMeasConfig* for this *measId*;
 - 2> if the *triggerType* is set to '*event*' and if the entry condition applicable for this event, i.e. the event corresponding with the *eventId* of the corresponding *reportConfig* within *VarMeasConfig*, is fulfilled for one or more applicable cells for all measurements after layer 3 filtering taken during *timeToTrigger* defined for this event within the *VarMeasConfig*, while the *VarMeasReportList* does not include an measurement reporting entry for this *measId*: (a first cell triggers the event)
 - 3> include a measurement reporting entry within the *VarMeasReportList* for this *measId*;
 - 3> set the *numberOfReportsSent* defined within the *VarMeasReportList* for this *measId* to 0;
 - 3> include the concerned cell(s) in the *cellsTriggeredList* defined within the *VarMeasReportList* for this *measId*;
 - 3> initiate the measurement reporting procedure, as specified in 5.5.5;
 - 2> if the *triggerType* is set to '*event*' and if the entry condition applicable for this event, i.e. the event corresponding with the *eventId* of the corresponding *reportConfig* within *VarMeasConfig*, is fulfilled for one or more applicable cells not included in the *cellsTriggeredList* for all measurements after layer 3 filtering

taken during *timeToTrigger* defined for this event within the *VarMeasConfig* (a subsequent cell triggers the event):

...

- 2> if the *triggerType* is set to 'event' and if the leaving condition applicable for this event is fulfilled for one or more of the cells included in the *cellsTriggeredList* defined within the *VarMeasReportList* for this *measId* for all measurements after layer 3 filtering taken during *timeToTrigger* defined within the *VarMeasConfig* for this event:
 - 3> remove the concerned cell(s) in the *cellsTriggeredList* defined within the *VarMeasReportList* for this *measId*;
 - 3> if *reportOnLeave* is set to *TRUE* for the corresponding reporting configuration:
 - 4> initiate the measurement reporting procedure, as specified in 5.5.5;
 - 3> if the *cellsTriggeredList* defined within the *VarMeasReportList* for this *measId* is empty:
 - 4> remove the measurement reporting entry within the *VarMeasReportList* for this *measId*;
 - 4> stop the periodical reporting timer for this *measId*, if running;
- 2> if the *purpose* is included and set to 'reportStrongestCells' or to 'reportStrongestCellsForSON' and if a (first) measurement result is available for one or more applicable cells:
 - 3> include a measurement reporting entry within the *VarMeasReportList* for this *measId*;
 - 3> set the *numberOfReportsSent* defined within the *VarMeasReportList* for this *measId* to 0;
 - 3> initiate the measurement reporting procedure, as specified in 5.5.5;

NOTE 1: If the *purpose* is set to 'reportStrongestCells', the UE initiates a first measurement report immediately after the quantity to be reported becomes available for at least either serving cell or one of the applicable cells. If the *purpose* is set to 'reportStrongestCellsForSON', the UE initiates a first measurement report when it has determined the strongest cells on the associated frequency.

- 2> upon expiry of the periodical reporting timer for this *measId*:
 - 3> initiate the measurement reporting procedure, as specified in 5.5.5;
- 2> if the *purpose* is included and set to 'reportCGI' and if the UE acquired the information needed to set all fields of *cellGlobalId* for the requested cell:
 - 3> include a measurement reporting entry within the *VarMeasReportList* for this *measId*;
 - 3> set the *numberOfReportsSent* defined within the *VarMeasReportList* for this *measId* to 0;
 - 3> stop timer T321;
 - 3> initiate the measurement reporting procedure, as specified in 5.5.5;
- 2> upon expiry of the T321 for this *measId*:
 - 3> include a measurement reporting entry within the *VarMeasReportList* for this *measId*;
 - 3> set the *numberOfReportsSent* defined within the *VarMeasReportList* for this *measId* to 0;
 - 3> initiate the measurement reporting procedure, as specified in 5.5.5;

NOTE 2: The UE does not stop the periodical reporting with *triggerType* set to 'event' or to 'periodical' while the corresponding measurement is not performed due to the serving cell RSRP being equal to or better than *s-Measure* or due to the measurement gap not being setup.

...

[TS 36.331, clause 5.5.4.8]

The UE shall:

- 1> for UTRA and CDMA2000, only trigger the event for cells included in the corresponding measurement object;
- 1> consider the entering condition for this event to be satisfied when both condition B2-1 and condition B2-2, as specified below, are fulfilled;
- 1> consider the leaving condition for this event to be satisfied when condition B2-3 or condition B2-4, i.e. at least one of the two, as specified below, is fulfilled;

Inequality B2-1 (Entering condition 1)

$M_s + H_{ys} < Thresh1$ Inequality B2-2 (Entering condition 2)

$$M_n + Ofn - H_{ys} > Thresh2$$

Inequality B2-3 (Leaving condition 1)

$$M_s - H_{ys} > Thresh1$$

Inequality B2-4 (Leaving condition 2)

$$M_n + Ofn + H_{ys} < Thresh2$$

The variables in the formula are defined as follows:

M_s is the measurement result of the serving cell, not taking into account any offsets.

M_n is the measurement result of the inter-RAT neighbour cell, not taking into account any offsets.

Ofn is the frequency specific offset of the frequency of the inter-RAT neighbour cell (i.e. *offsetFreq* as defined within the *measObject* corresponding to the frequency of the inter-RAT neighbour cell)

H_{ys} is the hysteresis parameter for this event (i.e. hysteresis as defined within *reportConfigInterRAT* for this event)

Thresh1 is the threshold parameter for this event (i.e. b2-Threshold1 as defined within *reportConfigInterRAT* for this event)

Thresh2 is the threshold parameter for this event (i.e. b2-Threshold2 as defined within *reportConfigInterRAT* for this event)

M_s is expressed in dBm in case of RSRP, or in dB in case of RSRQ

M_n is expressed in dBm or dB, depending on the measurement quantity of the inter-RAT neighbour cell

Ofn, ***H_{ys}*** are expressed in dB

Thresh1 is expressed in the same unit as ***M_s***

Thresh2 is expressed in the same unit as ***M_n***

[TS 36.331, clause 5.5.5]

The purpose of this procedure is to transfer measurement results from the UE to E-UTRAN.

For the *measId* for which the measurement reporting procedure was triggered, the UE shall set the *measResults* within the *MeasurementReport* message as follows:

- 1> set the *measId* to the measurement identity that triggered the measurement reporting;
- 1> set the *measResultServCell* to include the quantities of serving cell;
- 1> if there is at least one applicable neighbouring cell to report:
 - 2> set the *measResultNeighCells* to include the best neighbouring cells up to *maxReportCells* in accordance with the following:

3> if the *triggerType* is set to 'event':

4> include the cells included in the *cellsTriggeredList* as defined within the *VarMeasReportList* for this *measId*

3> else:

4> include the applicable calls for which the new measurement results became available since the last periodical reporting or since the measurement was initiated or reset;

NOTE: The reliability of the report (i.e. the certainty it contains the strongest cells on the concerned frequency) depends on the measurement configuration i.e. the *reportInterval*. The related performance requirements are specified in TS 36.133 [16].

3> for each cell that is included in the *measResultNeighCells* include the *physCellId*;

3> if the *triggerType* is set to 'event'; or the *purpose* is set to 'reportStrongestCells' or to 'reportStrongestCellsForSON':

4> for each included cell include the layer 3 filtered measured results in accordance with the *reportConfig* for this *measId*, ordered as follows:

5> if the *measObject* associated with this *measId* concerns E-UTRA:

...

5> else:

6> set the *measResult* to the quantity as configured for the concerned RAT within the *quantityConfig* in order of decreasing quantity, i.e. the best cell is included first;

...

1> increment the *numberOfReportsSent* as defined within the *VarMeasReportList* for this *measId* by 1;

1> stop the periodical reporting timer, if running;

1> if the *numberOfReportsSent* as defined within the *VarMeasReportList* for this *measId* is less than the *reportAmount* as defined within the corresponding *reportConfig* for this *measId*

2> start the periodical reporting timer with the value of *reportInterval* as defined within the corresponding *reportConfig* for this *measId*;

1> else:

2> if the *triggerType* is set to 'periodical':

3> remove the entry within the *VarMeasReportList* for this *measId*;

3> remove this *measId* from the *measIdList* within *VarMeasConfig*;

1> if the measured results are for CDMA2000 HRPD:

2> set the *preRegistrationStatusHRPD* to the UE's CDMA2000 upper layer's HRPD *preRegistrationStatus*;

1> if the measured results are for CDMA2000 1xRTT:

2> set the *preRegistrationStatusHRPD* to 'FALSE';

1> submit the *MeasurementReport* message to lower layers for transmission, upon which the procedure ends;

8.3.2.3.3 Test description

8.3.2.3.3.1 Pre-test conditions

System Simulator:

- Cell 1 and Cell 7.

- System information combination 4 as defined in TS 36.508 [18] clause 4.4.3.1 is used in E-UTRA cells.

UE:

None.

Preamble:

- The UE is in state Generic RB Established (state 3) on Cell 1 according to [18].

8.3.2.3.3.2 Test procedure sequence

Table 8.3.2.3.3.2-1 illustrates the downlink power levels and other changing parameters to be applied for the cells at various time instants of the test execution. Row marked "T0" denotes the initial conditions after preamble, while columns marked "T1" and "T2" are to be applied subsequently. The exact instants on which these values shall be applied are described in the texts in this clause.

Table 8.3.2.3.3.2-1: Time instances of cell power level and parameter changes

	Parameter	Unit	Cell 1	Cell 7	Remark
T0	Cell-specific RS EPRE	dBm/15k Hz	-60	-	The power level values are such that entering conditions for event B2 are not satisfied.
	CPICH E_c (UTRA FDD)	dBm/3.8 4MHz	-	-88	
	PCCPCH E_c (UTRA LCR TDD)	dBm/1.2 8 MHz	-	-88	
T1	Cell-specific RS EPRE	dBm/15k Hz	-84	-	The power level values are such that entering conditions for event B2 are satisfied.
	CPICH E_c (UTRA FDD)	dBm/3.8 4MHz	-	-64	
	PCCPCH E_c (UTRA LCR TDD)	dBm/1.2 8 MHz	-	-64	
T2	Cell-specific RS EPRE	dBm/15k Hz	-60	-	The power level values are such that leaving conditions for event B2 are satisfied.
	CPICH E_c (UTRA FDD)	dBm/3.8 4MHz	-	-88	
	PCCPCH E_c (UTRA LCR TDD)	dBm/1.2 8 MHz	-	-88	

Table 8.3.2.3.3.2-2: Main behaviour

St	Procedure	Message Sequence		TP	Verdict
		U - S	Message		
1	The SS transmits an <i>RRCConnectionReconfiguration</i> message to setup inter RAT measurement on Cell 1.	<--	<i>RRCConnectionReconfiguration</i>	-	-
2	The UE transmits an <i>RRCConnectionReconfigurationComplete</i> message to confirm the setup of inter RAT measurement on Cell 1.	-->	<i>RRCConnectionReconfigurationComplete</i>	-	-
3	Check: Does the UE transmit a <i>MeasurementReport</i> message on Cell 1 to report the event B2 during the next 10s?	-->	<i>MeasurementReport</i>	1	F
4	The SS changes Cell 1 and Cell 7 parameters according to the row "T1" in table 8.3.2.3.3.2-1.	-	-	-	-
5	Check: Does the UE transmit a <i>MeasurementReport</i> message to report the event B2 for Cell 7?	-->	<i>MeasurementReport</i>	2	P
6	The SS changes Cell 1 and Cell 7 parameters according to the row "T2" in table 8.3.2.3.3.2-1.	-	-	-	-
6A	Wait and ignore <i>MeasurementReport</i> messages for 15 s to allow change of power levels and UE measurement for Cells 1 and Cell 7.	-	-	-	-
7	Check: Does the UE transmit a <i>MeasurementReport</i> message on Cell 1 to report the event B2 during the next 10s?	-->	<i>MeasurementReport</i>	3	F
8	Check: Does the test result of generic test procedure in TS 36.508 subclause 6.4.2.3 indicate that the UE is in E-UTRA RRC_CONNECTED state on Cell 1?	-	-	1,2,3	-

8.3.2.3.3.3 Specific message contents

Table 8.3.2.3.3.3-1: *RRCConnectionReconfiguration* (step 1, Table 8.3.2.3.3.2-2)

Derivation Path: 36.508, Table 4.6.1-8, condition MEAS
--

Table 8.3.2.3.3.3-2: MeasConfig (Table 8.3.2.3.3.3-1)

Derivation Path: 36.508, Table 4.6.6-1, condition UTRAN			
Information Element	Value/remark	Comment	Condition
MeasConfig ::= SEQUENCE {			
measObjectToAddModList SEQUENCE (SIZE (1..maxObjectId)) OF SEQUENCE {	2 entries		
measObjectId[1]	IdMeasObject-f1		
measObject[1]	MeasObjectEUTRA-GENERIC(f1)		
measObjectId[2]	IdMeasObject-f8		
measObject[2]	MeasObjectUTRA-f8		
}			
reportConfigToAddModList SEQUENCE (SIZE (1..maxReportConfigId)) OF SEQUENCE {	1 entry		
reportConfigId[1]	IdReportConfig-B2-UTRA		
reportConfig[1]	ReportConfigInterRAT-B2-UTRA(-72, -76)		
}			
measIdToAddModList SEQUENCE (SIZE (1..maxMeasId)) OF SEQUENCE {	1 entry		
measId[1]	1		
measObjectId[1]	IdMeasObject-f8		
reportConfigId[1]	IdReportConfig-B2-UTRA		
}			
}			

Table 8.3.2.3.3.3-2A: QuantityConfig (Table 8.3.2.3.3.3-1)

Derivation Path: 36.508, Table 4.6.6-3A, condition UTRAN			
Information Element	Value/remark	Comment	Condition
QuantityConfig SEQUENCE {			
quantityConfigUTRA SEQUENCE {			
measQuantityUTRA-FDD	cpich-RSCP		UTRA-FDD
measQuantityUTRA-TDD	pccpich-RSCP		UTRA-TDD
filterCoefficient	fc0		
}			
}			

Condition	Explanation
UTRA-FDD	UTRA FDD cell environment
UTRA-TDD	UTRA TDD cell environment

Table 8.3.2.3.3.3-2B MeasObjectUTRA-f8 (Table 8.3.2.3.3.3-2)

Derivation path: 36.508 table 4.6.6-3 MeasObjectUTRA-GENERIC(f8)			
Information Element	Value/Remark	Comment	Condition
MeasObjectUTRA-GENERIC(f8) ::= SEQUENCE {			
carrierFreq	UTRA DL carrier frequency of the cell 7		
cellsToAddModList CHOICE {			
cellsToAddModListUTRA-FDD ::= SEQUENCE (SIZE (1.. maxCellMeas)) OF SEQUENCE {			UTRA-FDD
cellIndex [1]	1		
physCellId [1]	physicalCellIdentity – Cell 7		
}			
cellsToAddModListUTRA-TDD ::= SEQUENCE (SIZE (1..maxMeasId)) OF SEQUENCE {			UTRA-TDD
cellIndex [1]	1		
physCellId [1]	physicalCellIdentity – Cell 7		
}			
}			
}			

Condition	Explanation
UTRA-FDD	UTRA-FDD cell environment
UTRA-TDD	UTRA-TDD cell environment

Table 8.3.2.3.3.3-3: ReportConfigInterRAT-B2-UTRA (Table 8.3.2.3.3.3-2)

Derivation path: 36.508, Table 4.6.6-8 ReportConfigInterRAT-B2-UTRA(-72, -76)			
Information Element	Value/remark	Comment	Condition
ReportConfigInterRAT-B2-UTRA ::= SEQUENCE {			
triggerType CHOICE {			
event SEQUENCE {			
timeToTrigger	ms1024		
}			
}			
reportAmount	infinity		
}			

Table 8.3.2.3.3.3-4: *MeasurementReport* (step 5, Table 8.3.2.3.3.2-2)

Derivation Path: 36.508, Table 4.6.1-5			
Information Element	Value/remark	Comment	Condition
MeasurementReport ::= SEQUENCE {			
criticalExtensions CHOICE {			
c1 CHOICE{			
measurementReport-r8 SEQUENCE {			
measResults SEQUENCE {			
measId	1		
measResultServCell SEQUENCE {			
rsrpResult	(0..97)		
rsrqResult	(0..34)		
}			
measResultNeighCells CHOICE {			
measResultListUTRA SEQUENCE (SIZE (1..maxCellReport)) OF SEQUENCE {	1 entry		
physCellId[1]	PhysicalCellIdentity of Cell 7		
cgi-Info[1]	Not present		
measResult[1] SEQUENCE {			
utra-RSCP	(-5..91)		
}			
}			
}			
}			
}			
}			
}			

Condition	Explanation
UTRA-FDD	UTRA FDD cell environment
UTRA-TDD	UTRA TDD cell environment

8.3.2.3a Measurement configuration control and reporting / Inter-RAT measurements / Event B2 / Measurement of UTRAN cells / RSRQ based measurements

8.3.2.3a.1 Test Purpose (TP)

(1)

```
with { UE having completed the radio bearer establishment, initial security activation procedure and
performed the inter RAT measurement for UTRA cell, configured b2-Threshold1 set to threshold-RSRQ
and not detected entering condition for the event B2 is met }
ensure that {
  when { UE detects entering condition for the event B2 is not met }
    then { UE does not transmit any MeasurementReport }
}
```

(2)

```
with { UE having completed the radio bearer establishment, initial security activation procedure and
performed the inter RAT measurement for UTRA cell, configured b2-Threshold1 set to threshold-RSRQ
and not detected entering condition for the event B2 is met }
ensure that {
  when { UE detects entering condition for the event B2 is met }
    then { UE transmits a MeasurementReport }
}
```

(3)

```
with { UE having completed the radio bearer establishment, initial security activation procedure and
performed the inter RAT measurement for UTRA cell, configured b2-Threshold1 set to threshold-RSRQ
and detected entering condition for the event B2 is met }
ensure that {
```

```

when { UE detects leaving condition for the event B2 is met }
  then { UE does not transmit any MeasurementReport }
}

```

8.3.2.3a.2 Conformance requirements

References: The conformance requirements covered in the present TC are specified in: TS 36.331, clause 5.5.4.1, 5.5.4.8 and 5.5.5.

[TS 36.331, clause 5.5.4.1]

The UE shall:

1> for each *measId* included in the *measIdList* within *VarMeasConfig*:

2> if the corresponding *reportConfig* includes a purpose set to '*reportStrongestCellsForSON*':

...

2> else:

3> if the corresponding *measObject* concerns E-UTRA:

4> if the *ue-RxTxTimeDiffPeriodical*, *eventA1* or *eventA2* is configured in the corresponding *reportConfig*:

5> consider only the serving cell to be applicable;

4> else:

5> consider any neighbouring cell detected on the associated frequency to be applicable when the concerned cell is not included in the *blackCellsToAddModList* defined within the *VarMeasConfig* for this *measId*;

3> else if the corresponding *measObject* concerns UTRA or CDMA2000:

4> consider a neighbouring cell on the associated frequency to be applicable when the concerned cell is included in the *cellsToAddModList* defined within the *VarMeasConfig* for this *measId* (i.e. the cell is included in the white-list);

NOTE 0: The UE may also consider a neighbouring cell on the associated UTRA frequency to be applicable when the concerned cell is included in the *csg-allowedReportingCells* within the *VarMeasConfig* for this *measId*, if configured in the corresponding *measObjectUTRA* (i.e. the cell is included in the range of physical cell identities for which reporting is allowed).

3> else if the corresponding *measObject* concerns GERAN:

4> consider a neighbouring cell on the associated set of frequencies to be applicable when the concerned cell matches the *ncc-Permitted* defined within the *VarMeasConfig* for this *measId*;

2> if the *triggerType* is set to '*event*' and if the entry condition applicable for this event, i.e. the event corresponding with the *eventId* of the corresponding *reportConfig* within *VarMeasConfig*, is fulfilled for one or more applicable cells for all measurements after layer 3 filtering taken during *timeToTrigger* defined for this event within the *VarMeasConfig*, while the *VarMeasReportList* does not include an measurement reporting entry for this *measId* (a first cell triggers the event):

...

2> if the *triggerType* is set to '*event*' and if the entry condition applicable for this event, i.e. the event corresponding with the *eventId* of the corresponding *reportConfig* within *VarMeasConfig*, is fulfilled for one or more applicable cells not included in the *cellsTriggeredList* for all measurements after layer 3 filtering taken during *timeToTrigger* defined for this event within the *VarMeasConfig* (a subsequent cell triggers the event):

3> set the *numberOfReportsSent* defined within the *VarMeasReportList* for this *measId* to 0;

- 3> include the concerned cell(s) in the *cellsTriggeredList* defined within the *VarMeasReportList* for this *measId*;
- 3> initiate the measurement reporting procedure, as specified in 5.5.5;
- 2> if the *triggerType* is set to 'event' and if the leaving condition applicable for this event is fulfilled for one or more of the cells included in the *cellsTriggeredList* defined within the *VarMeasReportList* for this *measId* for all measurements after layer 3 filtering taken during *timeToTrigger* defined within the *VarMeasConfig* for this event:
 - 3> remove the concerned cell(s) in the *cellsTriggeredList* defined within the *VarMeasReportList* for this *measId*;
 - 3> if *reportOnLeave* is set to *TRUE* for the corresponding reporting configuration:
 - 4> initiate the measurement reporting procedure, as specified in 5.5.5;
 - 3> if the *cellsTriggeredList* defined within the *VarMeasReportList* for this *measId* is empty:
 - 4> remove the measurement reporting entry within the *VarMeasReportList* for this *measId*;
 - 4> stop the periodical reporting timer for this *measId*, if running;
- 2> if the *purpose* is included and set to 'reportStrongestCells' or to 'reportStrongestCellsForSON' and if a (first) measurement result is available for one or more applicable cells:
 - 3> include a measurement reporting entry within the *VarMeasReportList* for this *measId*;
 - 3> set the *numberOfReportsSent* defined within the *VarMeasReportList* for this *measId* to 0;
 - 3> initiate the measurement reporting procedure, as specified in 5.5.5;

NOTE 1: If the *purpose* is set to 'reportStrongestCells', the UE initiates a first measurement report immediately after the quantity to be reported becomes available for at least either serving cell or one of the applicable cells. If the *purpose* is set to 'reportStrongestCellsForSON', the UE initiates a first measurement report when it has determined the strongest cells on the associated frequency.

- 2> upon expiry of the periodical reporting timer for this *measId*:
 - 3> initiate the measurement reporting procedure, as specified in 5.5.5;
- 2> if the *purpose* is included and set to 'reportCGI' and if the UE acquired the information needed to set all fields of *cgi-Info* for the requested cell:
 - 3> include a measurement reporting entry within the *VarMeasReportList* for this *measId*;
 - 3> set the *numberOfReportsSent* defined within the *VarMeasReportList* for this *measId* to 0;
 - 3> stop timer T321;
 - 3> initiate the measurement reporting procedure, as specified in 5.5.5;
- 2> upon expiry of the T321 for this *measId*:
 - 3> include a measurement reporting entry within the *VarMeasReportList* for this *measId*;
 - 3> set the *numberOfReportsSent* defined within the *VarMeasReportList* for this *measId* to 0;
 - 3> initiate the measurement reporting procedure, as specified in 5.5.5;

NOTE 2: The UE does not stop the periodical reporting with *triggerType* set to 'event' or to 'periodical' while the corresponding measurement is not performed due to the serving cell RSRP being equal to or better than *s-Measure* or due to the measurement gap not being setup.

[TS 36.331, clause 5.5.4.8]

The UE shall:

- 1> for UTRA and CDMA2000, only trigger the event for cells included in the corresponding measurement object;
- 1> consider the entering condition for this event to be satisfied when both condition B2-1 and condition B2-2, as specified below, are fulfilled;
- 1> consider the leaving condition for this event to be satisfied when condition B2-3 or condition B2-4, i.e. at least one of the two, as specified below, is fulfilled;

Inequality B2-1 (Entering condition 1):

$$M_s + H_{ys} < Thresh1$$

Inequality B2-2 (Entering condition 2):

$$M_n + Ofn - H_{ys} > Thresh2$$

Inequality B2-3 (Leaving condition 1):

$$M_s - H_{ys} > Thresh1$$

Inequality B2-4 (Leaving condition 2):

$$M_n + Ofn + H_{ys} < Thresh2$$

The variables in the formula are defined as follows:

M_s is the measurement result of the serving cell, not taking into account any offsets.

M_n is the measurement result of the inter-RAT neighbour cell, not taking into account any offsets. For CDMA2000 measurement result, *pilotStrength* is divided by -2.

Ofn is the frequency specific offset of the frequency of the inter-RAT neighbour cell (i.e. *offsetFreq* as defined within the *measObject* corresponding to the frequency of the inter-RAT neighbour cell).

H_{ys} is the hysteresis parameter for this event (i.e. *hysteresis* as defined within *reportConfigInterRAT* for this event).

Thresh1 is the threshold parameter for this event (i.e. *b2-Threshold1* as defined within *reportConfigInterRAT* for this event).

Thresh2 is the threshold parameter for this event (i.e. *b2-Threshold2* as defined within *reportConfigInterRAT* for this event). For CDMA2000, *b2-Threshold2* is divided by -2.

M_s is expressed in dBm in case of RSRP, or in dB in case of RSRQ.

M_n is expressed in dBm or dB, depending on the measurement quantity of the inter-RAT neighbour cell.

Ofn, ***H_{ys}*** are expressed in dB.

Thresh1 is expressed in the same unit as ***M_s***.

Thresh2 is expressed in the same unit as ***M_n***.

[TS 36.331, clause 5.5.5]

The purpose of this procedure is to transfer measurement results from the UE to E-UTRAN.

For the *measId* for which the measurement reporting procedure was triggered, the UE shall set the *measResults* within the *MeasurementReport* message as follows:

- 1> set the *measId* to the measurement identity that triggered the measurement reporting;
- 1> set the *measResultServCell* to include the quantities of serving cell;
- 1> if there is at least one applicable neighbouring cell to report:
 - 2> set the *measResultNeighCells* to include the best neighbouring cells up to *maxReportCells* in accordance with the following:

3> if the *triggerType* is set to 'event':

4> include the cells included in the *cellsTriggeredList* as defined within the *VarMeasReportList* for this *measId*;

3> else:

4> include the applicable cells for which the new measurement results became available since the last periodical reporting or since the measurement was initiated or reset;

NOTE: The reliability of the report (i.e. the certainty it contains the strongest cells on the concerned frequency) depends on the measurement configuration i.e. the *reportInterval*. The related performance requirements are specified in TS 36.133 [16].

3> for each cell that is included in the *measResultNeighCells*, include the *physCellId*;

3> if the *triggerType* is set to 'event'; or the *purpose* is set to 'reportStrongestCells' or to 'reportStrongestCellsForSON':

4> for each included cell, include the layer 3 filtered measured results in accordance with the *reportConfig* for this *measId*, ordered as follows:

5> if the *measObject* associated with this *measId* concerns E-UTRA:

...

5> else:

6> set the *measResult* to the quantity as configured for the concerned RAT within the *quantityConfig* in order of either decreasing quantity for UTRA and GERAN or increasing quantity for CDMA2000 *pilotStrength*, i.e. the best cell is included first;

...

1> increment the *numberOfReportsSent* as defined within the *VarMeasReportList* for this *measId* by 1;

1> stop the periodical reporting timer, if running;

1> if the *numberOfReportsSent* as defined within the *VarMeasReportList* for this *measId* is less than the *reportAmount* as defined within the corresponding *reportConfig* for this *measId*:

2> start the periodical reporting timer with the value of *reportInterval* as defined within the corresponding *reportConfig* for this *measId*;

1> else:

2> if the *triggerType* is set to 'periodical':

3> remove the entry within the *VarMeasReportList* for this *measId*;

3> remove this *measId* from the *measIdList* within *VarMeasConfig*;

1> if the measured results are for CDMA2000 HRPD:

2> set the *preRegistrationStatusHRPD* to the UE's CDMA2000 upper layer's HRPD *preRegistrationStatus*;

1> if the measured results are for CDMA2000 1xRTT:

2> set the *preRegistrationStatusHRPD* to 'FALSE';

1> submit the *MeasurementReport* message to lower layers for transmission, upon which the procedure ends;

8.3.2.3a.3 Test description

8.3.2.3a.3.1 Pre-test conditions

System Simulator:

- Cell 1 and Cell 7
- System information combination 4 as defined in TS 36.508 [18] clause 4.4.3.1 is used in E-UTRA cell.

UE:

None.

Preamble:

- The UE is in state Generic RB Established (state 3) on Cell 1 according to [18].

8.3.2.3a.3.2 Test procedure sequence

Table 8.3.2.3a.3.2-1 illustrates the downlink power levels to be applied for Cell 1 and Cell 7 at various time instants of the test execution. Row marked "T0" denotes the conditions after the preamble, while rows marked "T1" and "T2" are to be applied subsequently. The exact instants on which these values shall be applied are described in the texts in this clause.

Table 8.3.2.3a.3.2-1: Time instances of cell power level and parameter changes

	Parameter	Unit	Cell 1	Cell 7	Remark
T0	Cell-specific RS EPRE	dBm/15kHz	-60	-	The power level values are assigned such that entering conditions for event B2 are not satisfied.
	RSRQ	dB	-4.15	-	
	CPICH Ec	dBm/3.84MHz	-	-93	
	CPICH_Ec/lo (Note 1)	dB	-	-18.13	
	Noc	dBm/15kHz	-73	-	
	loc	dBm/3.84MHz	-	-75	
T1	Cell-specific RS EPRE	dBm/15kHz	-75	-	The power level values are assigned such that entering conditions for event B2 are satisfied.
	RSRQ	dB	-13.23	-	
	CPICH Ec	dBm/3.84MHz	-	-65	
	CPICH_Ec/lo (Note 1)	dB	-	-3.11	
T2	Cell-specific RS EPRE	dBm/15kHz	-60	-	The power level values are assigned such that leaving conditions for event B2 are satisfied.
	RSRQ	dB	4.15-	-	
	CPICH Ec	dBm/3.84MHz	-	-65	
	CPICH_Ec/lo (Note 1)	dB	-	-3.11	

NOTE 1: This parameter is not directly settable, but are derived by calculation from the other parameters set by the SS.

Table 8.3.2.3a.3.2-2: Main behaviour

St	Procedure	Message Sequence		TP	Verdict
		U - S	Message		
1	The SS transmits an <i>RRConnectionReconfiguration</i> message to setup inter RAT measurement on Cell 1.	<--	<i>RRConnectionReconfiguration</i>	-	-
2	The UE transmits an <i>RRConnectionReconfigurationComplete</i> message to confirm the setup of inter RAT measurement on Cell 1.	-->	<i>RRConnectionReconfigurationComplete</i>	-	-
3	Check: Does the UE transmit a <i>MeasurementReport</i> message on Cell 1 to report the event B2 during the next 10s?	-->	<i>MeasurementReport</i>	1	F
4	The SS changes Cell 1 and Cell 7 parameters according to the row "T1" in table 8.3.2.3a.3.2-1.	-	-	-	-
5	Check: Does the UE transmit a <i>MeasurementReport</i> message on Cell 1 to report the event B2 for Cell 7?	-->	<i>MeasurementReport</i>	2	P
6	The SS changes Cell 1 and Cell 7 parameters according to the row "T2" in table 8.3.2.3a.3.2-1.	-	-	-	-
7	Wait and ignore <i>MeasurementReport</i> messages on Cell 1 for 5 s to allow change of power levels for Cell 1 and Cell 7.	-	-	-	-
8	Check: Does the UE transmit a <i>MeasurementReport</i> message on Cell 1 to report the event B2 during the next 10s?	-->	<i>MeasurementReport</i>	3	F
9	Check: Does the test result of generic test procedure in TS 36.508 subclause 6.4.2.3 indicate that the UE is in E-UTRA RRC_CONNECTED state on Cell 1?	-	-	3	-

8.3.2.3a.3.3 Specific message contents

Table 8.3.2.3a.3.3-0: SystemInformationBlockType3 for Cell 1 (preamble and all steps, Table 8.3.2.3a.3.2-1)

Derivation path: 36.508 table 4.4.3.3-2			
Information Element	Value/Remark	Comment	Condition
SystemInformationBlockType3 ::= SEQUENCE {			
lateNonCriticalExtension {			
s-IntraSearch-v920 SEQUENCE {}	Not present		
s-NonIntraSearch-v920 SEQUENCE {}	Not present		
q-QualMin-r9	-30 dB		
threshServingLowQ-r9	26 dB		
}			
}			

Table 8.3.2.3a.3.3-1: RRConnectionReconfiguration (step 1, Table 8.3.2.3a.3.2-2)

Derivation Path: 36.508, Table 4.6.1-8, condition MEAS
--

Table 8.3.2.3a.3.3-2: *MeasConfig* (Table 8.3.2.3a.3.3-1)

Derivation Path: 36.508, Table 4.6.6-1, condition UTRAN			
Information Element	Value/remark	Comment	Condition
MeasConfig ::= SEQUENCE {			
measObjectToAddModList SEQUENCE (SIZE (1..maxObjectId)) OF SEQUENCE {	2 entries		
measObjectId[1]	IdMeasObject-f1		
measObject[1]	MeasObjectEUTRA-GENERIC(f1)		
measObjectId[2]	IdMeasObject-f8		
measObject[2]	MeasObjectUTRA-f8		
}			
reportConfigToAddModList SEQUENCE (SIZE (1..maxReportConfigId)) OF SEQUENCE {	1 entry		
reportConfigId[1]	IdReportConfig-B2-UTRA		
reportConfig[1]	ReportConfigInterRAT-B2-UTRA-RSRQ(-12)		
}			
measIdToAddModList SEQUENCE (SIZE (1..maxMeasId)) OF SEQUENCE {	1 entry		
measId[1]	1		
measObjectId[1]	IdMeasObject-f8		
reportConfigId[1]	IdReportConfig-B2-UTRA		
}			
}			

Table 8.3.2.3a.3.3-3: *QuantityConfig* (Table 8.3.2.3a.3.3-2)

Derivation Path: 36.508, Table 4.6.6-3A, condition UTRAN			
Information Element	Value/remark	Comment	Condition
QuantityConfig SEQUENCE {			
quantityConfigUTRA SEQUENCE {			
measQuantityUTRA-FDD	cpich-EcN0		
filterCoefficient	fc0		
}			
}			

Table 8.3.2.3a.3.3-4: *MeasObjectUTRA-f8* (Table 8.3.2.3a.3.3-2)

Derivation Path: 36.508, Table 4.6.6-3			
Information Element	Value/remark	Comment	Condition
MeasObjectUTRA ::= SEQUENCE {			
carrierFreq	UTRA DL carrier frequency of the cell 7		
cellsToAddModList CHOICE {			
cellsToAddModListUTRA-FDD SEQUENCE (SIZE (1..maxCellMeas)) OF SEQUENCE {	1 entry		UTRA-FDD
cellIndex[1]	1		
physCellId[1]	physicalCellIdentity - Cell 7		
}			
cellsToAddModListUTRA-TDD SEQUENCE (SIZE (1..maxCellMeas)) OF SEQUENCE {	1 entry		UTRA-TDD
cellIndex[1]	1		
physCellId[1]	physicalCellIdentity - Cell 7		
}			
}			
csg-allowedReportingCells-v930	Not present		
}			

Condition	Explanation
UTRA-FDD	UTRA FDD cell environment
UTRA-TDD	UTRA TDD cell environment

Table 8.3.2.3a.3.3-5: ReportConfigInterRAT-B2-UTRA-RSRQ(UTRA-Thres) (Table 8.3.2.3a.3.3-2)

Derivation Path: 36.508, Table 4.6.6-8			
Information Element	Value/remark	Comment	Condition
ReportConfigInterRAT ::= SEQUENCE {			
triggerType CHOICE {			
event SEQUENCE {			
eventId CHOICE {			
eventB2 SEQUENCE {			
b2-Threshold1 CHOICE{			
threshold-RSRQ	16	-12dB	
}			
}			
}			
hysteresis	0 (0 dB)		
timeToTrigger	ms1024		
}			
reportAmount	infinity		
si-RequestForHO-r9	Not present		
}			
NOTE: UTRA-Thres is used in TS 36.508[18] Table 4.6.6-8.			

Table 8.3.2.3a.3.3-6: MeasurementReport (step 5, Table 8.3.2.3a.3.2-2)

Derivation Path: 36.508, Table 4.6.1-5			
Information Element	Value/remark	Comment	Condition
MeasurementReport ::= SEQUENCE {			
criticalExtensions CHOICE {			
c1 CHOICE{			
measurementReport-r8 SEQUENCE {			
measResults SEQUENCE {			
measId	1		
measResultServCell SEQUENCE {			
rsrpResult	(0..97)		
rsrqResult	(0..34)		
}			
measResultNeighCells CHOICE {			
measResultListUTRA SEQUENCE (SIZE (1..maxCellReport)) OF SEQUENCE {	1 entry		
physCellId[1]	PhysicalCellIdentity of Cell 7		
cgi-Info[1]	Not present		
measResult[1] SEQUENCE {			
utra-RSCP	(-5..91)		UTRA-TDD
utra-EcN0	(0..49)		UTRA-FDD
additionalSI-Info-r9	Not present		
}			
}			
measResultForECID-r9	Not present		
}			
}			
}			

Condition	Explanation
-----------	-------------

UTRA-FDD	UTRA FDD cell environment
UTRA-TDD	UTRA TDD cell environment

8.3.2.4 Measurement configuration control and reporting / Inter-RAT measurements / Periodic reporting / Measurement of UTRAN cells

8.3.2.4.1 Test Purpose (TP)

(1)

```
with { UE in E-UTRA RRC_CONNECTED state and measurement configured for periodic reporting of UTRA cells }
ensure that {
  when { The UE receives reference signal power for cells on the UTRA frequency where measurements are configured }
  then { UE sends MeasurementReport message at regular intervals for these UTRA cells }
}
```

(2)

```
with { UE in E-UTRA RRC_CONNECTED state and a Measurement Report message for a configured periodic measurement reporting of UTRA cells on a configured frequency were sent }
ensure that {
  when { A previously reported cell become unavailable or the UE receives reference signal power on a reported UTRA frequency for a cell which was previously not reported }
  then { UE sends MeasurementReport message at regular intervals for the available UTRA cells }
}
```

(3)

```
with { UE in E-UTRA RRC_CONNECTED state and periodic measurement reporting of UTRA cells ongoing }
ensure that {
  when { The UE receives a RRCCONNECTIONRECONFIGURATION message removing the measId of periodic reporting of UTRA cells }
  then { UE stops sending MeasurementReport message for UTRA cells }
}
```

8.3.2.4.2 Conformance requirements

References: The conformance requirements covered in the current TC are specified in: TS 36.331, clauses 5.3.5.3, 5.5.2.2, 5.5.4.1 and 5.5.5.

[TS 36.331, clause 5.3.5.3]

If the *RRCCONNECTIONRECONFIGURATION* message does not include the *mobilityControlInfo* and the UE is able to comply with the configuration included in this message, the UE shall:

...

- 1> If the *RRCCONNECTIONRECONFIGURATION* message includes the *measConfig*:
- 2> perform the Measurement configuration procedure as specified in 5.5.2;

[TS 36.331, clause 5.5.2.2]

The UE shall:

- 1> for each *measId* value included in the received *measIdToRemoveList* that is part of the current UE configuration in *varMeasConfig*:
- 2> remove the entry with the matching *measId* from the *measIdList* within the *VarMeasConfig*;
- 2> remove the measurement reporting entry for this *measId* from the *VarMeasReportList*, if included;
- 2> stop the periodical reporting timer or timer T321, whichever one is running, and reset the associated information (e.g. *timeToTrigger*) for this *measId*;

[TS 36.331, clause 5.5.4.1]

The UE shall:

1> for each *measId* included in the *measIdList* within *VarMeasConfig*:

...

2> else:

3> if the corresponding *measObject* concerns E-UTRA:

4> consider any neighbouring cell detected on the associated frequency to be applicable when the concerned cell is not included in the *blackCellsToAddModList* defined within the *VarMeasConfig* for this *measId*;

3> else if the corresponding *measObject* concerns UTRA or CDMA2000:

4> consider a neighbouring cell on the associated frequency to be applicable when the concerned cell is included in the *cellsToAddModList* defined within the *VarMeasConfig* for this *measId* (i.e. the cell is included in the white-list);

2> if the *purpose* is included and set to ‘*reportStrongestCells*’ or to ‘*reportStrongestCellsForSON*’ and if a (first) measurement result is available for one or more applicable cells:

3> include a measurement reporting entry within the *VarMeasReportList* for this *measId*;

3> set the *numberOfReportsSent* defined within the *VarMeasReportList* for this *measId* to 0;

3> initiate the measurement reporting procedure, as specified in 5.5.5;

NOTE 1: If the *purpose* is set to ‘*reportStrongestCells*’, the UE initiates a first measurement report immediately after the quantity to be reported becomes available for at least either serving cell or one of the applicable cells. If the *purpose* is set to ‘*reportStrongestCellsForSON*’, the UE initiates a first measurement report when it has determined the strongest cells on the associated frequency.

2> upon expiry of the periodical reporting timer for this *measId*:

3> initiate the measurement reporting procedure, as specified in 5.5.5;

...

NOTE 2: The UE does not stop the periodical reporting with *triggerType* set to ‘*event*’ or to ‘*periodical*’ while the corresponding measurement is not performed due to the serving cell RSRP being equal to or better than *s-Measure* or due to the measurement gap not being setup.

[TS 36.331, clause 5.5.5]

For the *measId* for which the measurement reporting procedure was triggered, the UE shall set the *measuredResults* within the *MeasurementReport* message as follows:

1> set the *measId* to the measurement identity that triggered the measurement reporting;

1> set the *measResultServCell* to include the quantities of serving cell;

1> if there is at least one applicable neighbouring cell to report:

2> set the *measResultsNeighCells* to include the best neighbouring cells up to *maxReportCells* in accordance with the following:

3> if the *triggerType* is set to ‘*event*’:

4> include the cells included in the *cellsTriggeredList* as defined within the *VarMeasReportList* for this *measId*;

3> else:

4> include the applicable cells for which the new measurement results became available since the last periodical reporting or since the measurement was initiated or reset;

NOTE: The reliability of the report (i.e. the certainty it contains the strongest cells on the concerned frequency) depends on the measurement configuration i.e. the *reportInterval*. The related performance requirements are specified in TS 36.133 [16].

- 3> for each cell that is included in the *measResultsNeighCells*, include the *physCellId*;
- 3> if the *triggerType* is set to 'event'; or the *purpose* is set to 'reportStrongestCells' or to 'reportStrongestCellsForSON':
 - 4> for each included cell, include the layer 3 filtered measured results in accordance with the *reportConfig* for this *measId*, ordered as follows:
 - 5> if the *measObject* associated with this *measId* concerns E-UTRA:
 - 6> set the *measResult* to include the quantity(ies) indicated in the *reportQuantity* within the concerned *reportConfig* in order of decreasing *triggerQuantity*, i.e. the best cell is included first;
 - 5> else:
 - 6> set the *measResult* to the quantity as configured for the concerned RAT within the *quantityConfig* in order of decreasing quantity, i.e. the best cell is included first;
 - 1> increment the *numberOfReportsSent* as defined within the *VarMeasReportList* for this *measId* by 1;
 - 1> stop the periodical reporting timer, if running;
 - 1> if the *numberOfReportsSent* as defined within the *VarMeasReportList* for this *measId* is less than to *reportAmount* as defined corresponding *reportConfig* for this *measId*:
 - 2> start the periodical reporting timer with the value of *reportInterval* as defined within the corresponding *reportConfig* for this *measId*;
 - ...
 - 1> submit the MEASUREMENT REPORT message to lower layers for transmission, upon which the procedure ends.

8.3.2.4.3 Test description

8.3.2.4.3.1 Pre-test conditions

System Simulator:

- Cell 1, Cell 5 and Cell 7
- System information combination 4 as defined in TS 36.508 [18] clause 4.4.3.1 is used in E-UTRA cells.

UE:

None.

Preamble:

- The UE is in state Generic RB Established (state 3) according to [18] on Cell 1.

8.3.2.4.3.2 Test procedure sequence

Table 8.3.2.4.3.2-1 illustrates the downlink power levels to be applied for the cells at various time instants of the test execution. Row marked "T0" denotes the initial conditions after preamble, while rows marked "T1" and "T2" are to be applied subsequently. The exact instants on which these values shall be applied are described in the texts in this clause.

Table 8.3.2.4.3.2-1: Power levels

	Parameter	Unit	Cell 1	Parameter	Unit	Cell 5	Cell 7	Remark
	E-UTRA Cell			UTRA Cells				
T0	Cell-specific RS EPRE	dBm/15kHz	-75	CPICH_Ec (UTRA FDD)	dBm/3.84 MHz	-85	Off	Power levels shall be such that camping on Cell 1 is guaranteed
				PCCPCH_Ec (UTRA LCR TDD)	dBm/1.28 MHz	-85	Off	
T1			-75	CPICH_Ec (UTRA FDD)	dBm/3.84 MHz	-85	-85	
				PCCPCH_Ec (UTRA LCR TDD)	dBm/1.28 MHz	-85	-85	
T2			-75	CPICH_Ec (UTRA FDD)	dBm/3.84 MHz	Off	-85	
				PCCPCH_Ec (UTRA LCR TDD)	dBm/1.28 MHz	Off	-85	

Table 8.3.2.4.3.2-2: Main behaviour

St	Procedure	Message Sequence		TP	Verdict
		U - S	Message		
1	The SS transmits an <i>RRCCONNECTIONRECONFIGURATION</i> message including <i>measConfig</i> to setup measurements and periodical reporting for UTRA cells.	<--	<i>RRCCONNECTIONRECONFIGURATION</i>	-	-
2	The UE transmits an <i>RRCCONNECTIONRECONFIGURATIONCOMPLETE</i> message.	-->	<i>RRCCONNECTIONRECONFIGURATIONCOMPLETE</i>	-	-
-	EXCEPTION: In parallel to events described in steps 3 to 4 the steps specified in table 8.3.2.4.3.2-3 shall take place				
3	Wait for 30 s to ensure that the UE performs a periodical reporting of UTRA cells.	-	-	1	-
4	The SS sets the cell-specific reference signal levels and switches Cell 7 on according to row "T1" in table 8.3.2.4.3.2-1.	-	-	-	-
5	Wait and ignore <i>MEASUREMENTREPORT</i> messages for 8 s to allow for the switching of cells and UE measurement.	-	-	-	-
-	EXCEPTION: In parallel to events described in steps 6 to 7 the steps specified in table 8.3.2.4.3.2-4 shall take place				
6	Wait for 30 s to ensure that the UE performs a periodical reporting of UTRA cells.	-	-	1, 2	-
7	The SS sets the cell-specific reference signal levels and switches Cell 5 "Off" according to row "T2" in table 8.3.2.4.3.2-1.	-	-	-	-
8	Wait and ignore <i>MEASUREMENTREPORT</i> messages for 8 s to allow for the switching of cells and UE measurement	-	-	-	-
-	EXCEPTION: In parallel to events described in steps 9 to 10 the steps specified in table 8.3.2.4.3.2-5 shall take place				
9	Wait for 30 s to ensure that the UE performs a periodical reporting of UTRA cells.	-	-	1, 2	-
10	The SS transmits an <i>RRCCONNECTIONRECONFIGURATION</i> message including <i>measConfig</i> to remove <i>measId</i> for periodic reporting.	<--	<i>RRCCONNECTIONRECONFIGURATION</i>	-	-
11	The UE transmits an <i>RRCCONNECTIONRECONFIGURATIONCOMPLETE</i> message.	-->	<i>RRCCONNECTIONRECONFIGURATIONCOMPLETE</i>	-	-
12	Check: Does the UE attempt to transmit an uplink message for the next 10s?	-	-	3	F

Table 8.3.2.4.3.2-3: Parallel behaviour

St	Procedure	Message Sequence		TP	Verdict
		U - S	Message		
-	EXCEPTION: After the 1st message is received, step 1 below shall be repeated every time the duration indicated in the IE <i>reportInterval</i> has elapsed.				
1	Check: Does the UE transmit a <i>MEASUREMENTREPORT</i> message to perform periodical reporting for Cell 5?	-->	<i>MEASUREMENTREPORT</i>	1	P

Table 8.3.2.4.3.2-4: Parallel behaviour

St	Procedure	Message Sequence		TP	Verdict
		U - S	Message		
-	EXCEPTION: Step 1 below shall be repeated every time the duration indicated in the IE <i>reportInterval</i> has elapsed.				
1	Check: Does the UE transmit a <i>MeasurementReport</i> message to perform periodical reporting for Cell 5 and Cell 7?	-->	<i>MeasurementReport</i>	1, 2	P

Table 8.3.2.4.3.2-5: Parallel behaviour

St	Procedure	Message Sequence		TP	Verdict
		U - S	Message		
-	EXCEPTION: Step 1 shall be repeated every time the duration indicated in the IE <i>reportInterval</i> has elapsed.				
1	Check: Does the UE transmit a <i>MeasurementReport</i> message to perform periodical reporting for Cell 7(NOTE1)?	-->	<i>MeasurementReport</i>	1, 2	P

NOTE1: Cell 5 may be included in the *MeasurementReport* due to UE averages power levels over a period of time.

8.3.2.4.3.3 Specific message contents

Table 8.3.2.4.3.3-1 *RRCConnectionReconfiguration* (step 1 and step 10, Table 8.3.2.4.3.2-2)

Derivation path: 36.508 table 4.6.1-8 with condition MEAS

Table 8.3.2.4.3.3-2 *MeasConfig* (step 1, Table 8.3.2.4.3.2-2)

Derivation Path: 36.508, Table 4.6.6-1 with condition UTRAN			
Information Element	Value/remark	Comment	Condition
MeasConfig ::= SEQUENCE {			
measObjectToAddModList SEQUENCE (SIZE (1..maxObjectId)) OF SEQUENCE {	2 entries		
measObjectId[1]	IdMeasObject-f1		
measObject[1]	MeasObjectEUTRA-GENERIC(f1)		
measObjectId[2]	IdMeasObject-f8		
measObject[2]	MeasObjectUTRA-f8	UTRA frequency	
}			
reportConfigToAddModList SEQUENCE (SIZE (1..maxReportConfigId)) OF SEQUENCE {	1 entry		
reportConfigId[1]	IdReportConfig-PERIODICAL		
reportConfig[1]	ReportConfigInterRAT-PERIODICAL-UTRA		
}			
measIdToAddModList SEQUENCE (SIZE (1..maxMeasId)) OF SEQUENCE {	1 entry		
measId[1]	1		
measObjectId[1]	IdMeasObject-f8		
reportConfigId[1]	IdReportConfig-PERIODICAL		
}			
quantityConfig SEQUENCE {			
quantityConfigUTRA SEQUENCE {			
measQuantityUTRA-FDD	cpich-RSCP		UTRA-FDD
measQuantityUTRA-TDD	pccpch-RSCP		UTRA-TDD
}			
}			
}			

Condition	Explanation
UTRA-FDD	UTRA FDD cell environment
UTRA-TDD	UTRA TDD cell environment

Table 8.3.2.4.3.3-3 MeasObjectUTRA-f8 (step 1, Table 8.3.2.4.3.2-2)

Derivation path: 36.508 table 4.6.6-3 MeasObjectUTRA-GENERIC(f8)			
Information Element	Value/Remark	Comment	Condition
MeasObjectUTRA-GENERIC(f8) ::= SEQUENCE {			
carrierFreq		UTRA DL carrier frequency of Cell 5 and Cell 7	
cellsToAddModList CHOICE {			
cellsToAddModListUTRA-FDD ::= SEQUENCE (SIZE (1..maxCellMeas)) OF SEQUENCE {			UTRA-FDD
cellIndex [1]	1		
physCellId [1]	physicalCellIdentity – Cell 5		
cellIndex [2]	2		
physCellId [2]	physicalCellIdentity – Cell 7		
}			
cellsToAddModListUTRA-TDD ::= SEQUENCE (SIZE (1..maxMeasId)) OF SEQUENCE {			UTRA-TDD
cellIndex [1]	1		
physCellId [1]	physicalCellIdentity – Cell 5		
cellIndex [2]	2		
physCellId [2]	physicalCellIdentity – Cell 7		
}			
}			
}			

Condition	Explanation
UTRA-FDD	UTRA FDD cell environment
UTRA-TDD	UTRA TDD cell environment

Table 8.3.2.4.3.3-4 ReportConfigInterRAT-PERIODICAL-UTRA (step 1, Table 8.3.2.4.3.2-2)

Derivation path: 36.508 table 4.6.6-9 ReportConfigInterRAT-PERIODICAL			
Information Element	Value/Remark	Comment	Condition
ReportConfigInterRAT-PERIODICAL-UTRA ::= SEQUENCE {			
maxReportCells	2	Report Cell 5 and Cell 7	
}			

Table 8.3.2.4.3.3-5: MeasConfig (step 10, Table 8.3.2.4.3.2-2)

Derivation Path: 36.508, Table 4.6.6-1			
Information Element	Value/remark	Comment	Condition
MeasConfig ::= SEQUENCE {			
measIdToRemoveList SEQUENCE (SIZE (1..maxMeasId)) OF SEQUENCE {	1 entry		
measId[1]	1		
}			
}			

Table 8.3.2.4.3.3-6: MeasurementReport (step 1, Table 8.3.2.4.3.2-3)

Derivation Path: 36.508 clause 4.6.1 table 4.6.1-5			
Information Element	Value/remark	Comment	Condition
MeasurementReport ::= SEQUENCE {			
criticalExtensions CHOICE {			
c1 CHOICE {			
measurementReport-r8 SEQUENCE {			
measResults ::= SEQUENCE {			
measId	1		
measResultServCell ::= SEQUENCE {		Report Cell 1	
rsrpResult	(0..97)		
rsrqResult	(0..34)		
}			
measResultNeighCells CHOICE {			
measResultListUTRA ::= SEQUENCE (SIZE (1..maxCellReport)) OF SEQUENCE {			
physCellId[1] CHOICE {			
fdd	physicalCellIdentity – Cell 5	Report Cell 5	UTRA-FDD
tdd	physicalCellIdentity – Cell 5	Report Cell 5	UTRA-TDD
}			
measResult [1] ::= SEQUENCE {			
utra-RSCP	(-5..91)		
}			
}			
}			
}			
}			
}			
}			

Condition	Explanation
UTRA-FDD	UTRA FDD cell environment
UTRA-TDD	UTRA TDD cell environment

Table 8.3.2.4.3.3-7: MeasurementReport (step 1, Table 8.3.2.4.3.2-4)

Derivation Path: 36.508 clause 4.6.1 table 4.6.1-5			
Information Element	Value/remark	Comment	Condition
MeasurementReport ::= SEQUENCE {			
criticalExtensions CHOICE {			
c1 CHOICE {			
measurementReport-r8 SEQUENCE {			
measResults ::= SEQUENCE {			
measId	1		
measResultServCell ::= SEQUENCE {		Report Cell 1	
rsrpResult	(0..97)		
rsrqResult	(0..34)		
}			
measResultNeighCells CHOICE {			
measResultListUTRA ::= SEQUENCE (SIZE (1..maxCellReport)) OF SEQUENCE {			
physCellId[1] CHOICE {			
fdd	physicalCellIdentity – Cell 5	Report Cell 5	UTRA-FDD
tdd	physicalCellIdentity – Cell 5	Report Cell 5	UTRA-TDD
}			
measResult [1] ::= SEQUENCE {			
utra-RSCP	(-5..91)		
}			
physCellId[2] CHOICE {			
fdd	physicalCellIdentity – Cell 7	Report Cell 7	UTRA-FDD
tdd	physicalCellIdentity – Cell 7	Report Cell 7	UTRA-TDD
}			
measResult [2] ::= SEQUENCE {			
utra-RSCP	(-5..91)		
}			
}			
}			
}			
}			
}			
}			

Condition	Explanation
UTRA-FDD	UTRA FDD cell environment
UTRA-TDD	UTRA TDD cell environment

Table 8.3.2.4.3.3-8: *MeasurementReport* (step 1, Table 8.3.2.4.3.2-5)

Derivation Path: 36.508 clause 4.6.1 table 4.6.1-5			
Information Element	Value/remark	Comment	Condition
MeasurementReport ::= SEQUENCE {			
criticalExtensions CHOICE {			
c1 CHOICE {			
measurementReport-r8 SEQUENCE {			
measResults ::= SEQUENCE {			
measId	1		
measResultServCell ::= SEQUENCE {		Report Cell 1	
rsrpResult	(0..97)		
rsrqResult	(0..34)		
}			
measResultNeighCells CHOICE {			
measResultListUTRA ::= SEQUENCE (SIZE (1..maxCellReport)) OF SEQUENCE {			
physCellId[1] CHOICE {			
fdd	physicalCellIdentity – Cell 7	Report Cell 7	UTRA-FDD
tdd	physicalCellIdentity – Cell 7	Report Cell 7	UTRA-TDD
}			
measResult [1] ::= SEQUENCE {			
utra-RSCP	(-5..91)		
}			
}			
}			
}			
}			
}			
}			

Condition	Explanation
UTRA-FDD	UTRA FDD cell environment
UTRA-TDD	UTRA TDD cell environment

8.3.2.5 Measurement configuration control and reporting / Inter-RAT measurements / Periodic reporting / Measurements of E-UTRAN, UTRAN and GERAN cells

8.3.2.5.1 Test Purpose (TP)

(1)

```
with { UE having completed the radio bearer establishment, initial security activation procedure and performed the inter RAT measurement for UTRAN and GERAN cells }
ensure that {
  when { The UE receives reference signal power for cells on either UTRAN or GERAN frequency where measurements are configured }
  then { UE sends MeasurementReport message at regular intervals for UTRAN or GERAN cell }
}
```

(2)

```
with { UE in E-UTRA RRC_CONNECTED state and a MeasurementReport message for a configured periodic measurement reporting of UTRAN or GERAN cell on a configured frequency was sent }
ensure that {
  when { A previously reported cell become unavailable and the UE receives reference signal power on a reported UTRAN or GERAN frequency for a cell which was previously not reported }
  then { UE sends MeasurementReport message at regular intervals for the available UTRAN or GERAN cell }
}
```

(3)

```

with { UE in E-UTRA RRC_CONNECTED state and periodic measurement reporting of UTRAN or GERAN cells
ongoing }
ensure that {
when { The UE receives reference signal power on a reported UTRAN or GERAN frequency for a cell
which was previously not reported }
then { UE sends MeasurementReport messages at regular intervals for the available UTRAN and
GERAN cells }
}

```

(4)

```

with { UE in E-UTRA RRC_CONNECTED state and periodic measurement reporting of UTRAN and GERAN cells
ongoing }
ensure that {
when { The UE receives a RRCCONNECTIONRECONFIGURATION message removing the measId of periodic
reporting of UTRAN and GERAN cells }
then { UE stops sending MeasurementReport message for UTRAN and GERAN cells }
}

```

8.3.2.5.2 Conformance requirements

References: The conformance requirements covered in the present TC are specified in: TS 36.331, clause 5.3.5.3, 5.5.2.2, 5.5.4.1 and 5.5.5.

[TS 36.331, clause 5.3.5.3]

If the *RRCCONNECTIONRECONFIGURATION* message does not include the *mobilityControlInfo* and the UE is able to comply with the configuration included in this message, the UE shall:

...

1> if the *RRCCONNECTIONRECONFIGURATION* message includes the *measConfig*:

3> perform the measurement configuration procedure as specified in 5.5.2;

[TS 36.331, clause 5.5.2.2]

The UE shall:

1> for each *measId* included in the received *measIdToRemoveList* that is part of the current UE configuration in *varMeasConfig*:

2> remove the entry with the matching *measId* from the *measIdList* within the *VarMeasConfig*;

2> remove the measurement reporting entry for this *measId* from the *VarMeasReportList*, if included;

2> stop the periodical reporting timer or timer T321, whichever one is running, and reset the associated information (e.g. *timeToTrigger*) for this *measId*;

NOTE: The UE does not consider the message as erroneous if the *measIdToRemoveList* includes any *measId* value that is not part of the current UE configuration.

[TS 36.331, clause 5.5.4.1]

The UE shall:

1> for each *measId* included in the *measIdList* within *VarMeasConfig*:

...

2> else:

...

3> else if the corresponding *measObject* concerns UTRA or CDMA2000:

4> consider a neighbouring cell on the associated frequency to be applicable when the concerned cell is included in the *cellsToAddModList* defined within the *VarMeasConfig* for this *measId* (i.e. the cell is included in the white-list);

3> else if the corresponding *measObject* concerns GERAN:

4> consider a neighbouring cell on the associated set of frequencies to be applicable when the concerned cell matches the *ncc-Permitted* defined within the *VarMeasConfig* for this *measId*;

...

2> if the *purpose* is included and set to '*reportStrongestCells*' or to '*reportStrongestCellsForSON*' and if a (first) measurement result is available for one or more applicable cells:

3> include a measurement reporting entry within the *VarMeasReportList* for this *measId*;

3> set the *numberOfReportsSent* defined within the *VarMeasReportList* for this *measId* to 0;

3> initiate the measurement reporting procedure, as specified in 5.5.5;

NOTE 1: If the *purpose* is set to '*reportStrongestCells*', the UE initiates a first measurement report immediately after the quantity to be reported becomes available for at least either serving cell or one of the applicable cells. If the purpose is set to '*reportStrongestCellsForSON*', the UE initiates a first measurement report when it has determined the strongest cells on the associated frequency.

2> upon expiry of the periodical reporting timer for this *measId*:

3> initiate the measurement reporting procedure, as specified in 5.5.5;

...

NOTE 2: The UE does not stop the periodical reporting with *triggerType* set to '*event*' or to '*periodical*' while the corresponding measurement is not performed due to the serving cell RSRP being equal to or better than *s-Measure* or due to the measurement gap not being setup.

NOTE 3: If the UE is configured with DRX, the UE may delay the measurement reporting for event triggered and periodical triggered measurements until the Active Time, which is defined in TS 36.321 [6].

[TS 36.331, clause 5.5.5]

The purpose of this procedure is to transfer measurement results from the UE to E-UTRAN.

For the *measId* for which the measurement reporting procedure was triggered, the UE shall set the *measResults* within the *MeasurementReport* message as follows:

1> set the *measId* to the measurement identity that triggered the measurement reporting;

1> set the *measResultServCell* to include the quantities of serving cell;

1> if there is at least one applicable neighbouring cell to report:

2> set the *measResultNeighCells* to include the best neighbouring cells up to *maxReportCells* in accordance with the following:

...

3> else:

4> include the applicable cells for which the new measurement results became available since the last periodical reporting or since the measurement was initiated or reset;

NOTE: The reliability of the report (i.e. the certainty it contains the strongest cells on the concerned frequency) depends on the measurement configuration i.e. the *reportInterval*. The related performance requirements are specified in TS 36.133 [16].

3> for each cell that is included in the *measResultNeighCells*, include the *physCellId*;

- 3> if the *triggerType* is set to 'event'; or the *purpose* is set to 'reportStrongestCells' or to 'reportStrongestCellsForSON':
 - 4> for each included cell, include the layer 3 filtered measured results in accordance with the *reportConfig* for this *measId*, ordered as follows:
 - 5> if the *measObject* associated with this *measId* concerns E-UTRA:
 - 6> set the *measResult* to include the quantity(ies) indicated in the *reportQuantity* within the concerned *reportConfig* in order of decreasing *triggerQuantity*, i.e. the best cell is included first;
 - 5> else:
 - 6> set the *measResult* to the quantity as configured for the concerned RAT within the *quantityConfig* in order of decreasing quantity, i.e. the best cell is included first;
 - ...
 - 1> increment the *numberOfReportsSent* as defined within the *VarMeasReportList* for this *measId* by 1;
 - 1> stop the periodical reporting timer, if running;
 - 1> if the *numberOfReportsSent* as defined within the *VarMeasReportList* for this *measId* is less than the *reportAmount* as defined within the corresponding *reportConfig* for this *measId*:
 - 2> start the periodical reporting timer with the value of *reportInterval* as defined within the corresponding *reportConfig* for this *measId*;
 - 1> else:
 - 2> if the *triggerType* is set to 'periodical':
 - 3> remove the entry within the *VarMeasReportList* for this *measId*;
 - 3> remove this *measId* from the *measIdList* within *VarMeasConfig*;
 - ...
 - 1> submit the *MeasurementReport* message to lower layers for transmission, upon which the procedure ends;

8.3.2.5.3 Test description

8.3.2.5.3.1 Pre-test conditions

System Simulator:

- Cell 1, Cell 5 and Cell 24.
- System information combination 10 as defined in TS 36.508 [18] clause 4.4.3.1 is used in E-UTRA cells.

UE:

None.

Preamble:

- The UE is in state Generic RB Established (state 3) on Cell 1 according to [18].

8.3.2.5.3.2 Test procedure sequence

Table 8.3.2.5.3.2-1 illustrates the downlink power levels and other changing parameters to be applied for the cells at various time instants of the test execution. Row marked "T0" denotes the initial conditions after preamble, while columns marked "T1" and "T2" are to be applied subsequently. The exact instants on which these values shall be applied are described in the texts in this clause.

Table 8.3.2.5.3.2-1: Time instances of cell power level and parameter changes

	Parameter	Unit	Cell 1	Cell 5	Cell 24	Remark
T0	Cell-specific RS EPRE	dBm/15k Hz	-60	-	-	The power level values are such that camping on Cell 1 is guarantee.
	CPICH_Ec (UTRA FDD)	dB	-	Off	-	
	PCCPCH_Ec (UTRA LCR TDD)	dBm/1.28 MHz	-	Off	-	
	RSSI	dBm	-	-	Off	
T1	Cell-specific RS EPRE	dBm/15k Hz	-60	-	-	The power level values are such that Cell 5 is satisfied for periodic reporting.
	CPICH_Ec (UTRA FDD)	dB	-	-85	-	
	PCCPCH_Ec (UTRA LCR TDD)	dBm/1.28 MHz	-	-85	-	
	RSSI	dBm	-	-	Off	
T2	Cell-specific RS EPRE	dBm/15k Hz	-60	-	-	The power level values are such that Cell 24 is satisfied for periodic reporting and Cell 5 become unavailable.
	CPICH_Ec (UTRA FDD)	dB	-	Off	-	
	PCCPCH_Ec (UTRA LCR TDD)	dBm/1.28 MHz	-	Off	-	
	RSSI	dBm	-	-	-70	
T3	Cell-specific RS EPRE	dBm/15k Hz	-60	-	-	The power level values are such that Cell 5 and Cell 24 are satisfied for periodic reporting.
	CPICH_Ec (UTRA FDD)	dB	-	-85	-	
	PCCPCH_Ec (UTRA LCR TDD)	dBm/1.28 MHz	-	-85	-	
	RSSI	dBm	-	-	-70	

Table 8.3.2.5.3.2-2: Main behaviour

St	Procedure	Message Sequence		TP	Verdict
		U - S	Message		
1	The SS transmits an <i>RRConnectionReconfiguration</i> message to setup inter-RAT measurement.	<--	<i>RRConnectionReconfiguration</i>	-	-
2	The UE transmits an <i>RRConnectionReconfigurationComplete</i> message to confirm the setup of inter-RAT measurement.	-->	<i>RRConnectionReconfigurationComplete</i>	-	-
3	The SS power "On" Cell 5 according to the row "T1" in table 8.3.2.5.3.2-1.	-	-	-	-
4	Wait and ignore <i>MeasurementReport</i> messages for 15s to allow power "On" for Cell 5 and to allow UE to measure the neighbouring cells.	-	-	-	-
-	EXCEPTION: In parallel to events described in step 5 the steps specified in table 8.3.2.5.3.2-3 shall take place	-	-	-	-
5	Wait for 30 s to ensure that the UE performs a inter-RAT periodical reporting.	-	-	-	-
6	The SS power "Off" Cell 5 and power "On" Cell 24 according to the row "T2" in table 8.3.2.5.3.2-1.	-	-	-	-
7	Wait and ignore <i>MeasurementReport</i> messages for 15s to allow power "Off" and power "On" for Cell 5 and Cell 24 respectively and to allow UE to measure the neighbouring cells.	-	-	-	-
-	EXCEPTION: In parallel to events described in step 8 the steps specified in table 8.3.2.5.3.2-4 shall take place	-	-	-	-
8	Wait for 30 s to ensure that the UE performs a inter-RAT periodical reporting.	-	-	-	-
9	The SS power "On" for Cell 5 according to the row "T3" in table 8.3.2.5.3.2-1.	-	-	-	-
10	Wait and ignore <i>MeasurementReport</i> messages for 15s to allow power "On" for Cell 5 and to allow UE to measure the neighbouring cells.	-	-	-	-
-	EXCEPTION: In parallel to events described in steps 11 to 12 the steps specified in table 8.3.2.5.3.2-3 and 8.3.2.5.3.2-4 shall take place	-	-	-	-
11	Wait for 30 s to ensure that the UE performs a inter-RAT periodical reporting.	-	-	-	-
12	The SS transmits an <i>RRConnectionReconfiguration</i> message to remove inter-RAT measurement.	<--	<i>RRConnectionReconfiguration</i>	-	-
13	The UE transmits an <i>RRConnectionReconfigurationComplete</i> message to confirm the remove of inter-RAT measurement.	-->	<i>RRConnectionReconfigurationComplete</i>	-	-
14	Check: Does the UE attempt to transmit an uplink message for the next 10s?	-	-	4	F

Table 8.3.2.5.3.2-3: Parallel behaviour

St	Procedure	Message Sequence		TP	Verdict
		U - S	Message		
-	EXCEPTION: After the 1st message is received, step 1 below shall be repeated every time the duration indicated in the IE <i>reportInterval</i> has elapsed	-	-	-	-
1	Check: Does the UE transmit a <i>MeasurementReport</i> message to perform periodical reporting for Cell 5?	-->	<i>MeasurementReport</i>	1, 3	P

Table 8.3.2.5.3.2-4: Parallel behaviour

St	Procedure	Message Sequence		TP	Verdict
		U - S	Message		
-	EXCEPTION: After the 1st message is received, step 1 below shall be repeated every time the duration indicated in the IE <i>reportInterval</i> has elapsed.	-	-	-	-
1	Check: Does the UE transmit a <i>MeasurementReport</i> message to perform periodical reporting for Cell 24?	-->	<i>MeasurementReport</i>	1, 2, 3	P

8.3.2.5.3.3 Specific message contents

Table 8.3.2.5.3.3-1: *RRCConnectionReconfiguration* (step 1, Table 8.3.2.5.3.2-2)

Derivation Path: 36.508, Table 4.6.1-8, condition MEAS
--

Table 8.3.2.5.3.3-2: MeasConfig (Table 8.3.2.5.3.3-1)

Derivation Path: 36.508, Table 4.6.6-1			
Information Element	Value/remark	Comment	Condition
MeasConfig ::= SEQUENCE {			
measObjectToAddModList SEQUENCE (SIZE (1..maxObjectId)) OF SEQUENCE {	3 entries		
measObjectId[1]	IdMeasObject-f1		
measObject[1]	MeasObjectEUTRA-GENERIC(f1)		
measObjectId[2]	IdMeasObject-f8		
measObject[2]	MeasObjectUTRA-f8		
measObjectId[3]	IdMeasObject-f11		
measObject[3]	MeasObjectGERAN- f11		
}			
reportConfigToAddModList SEQUENCE (SIZE (1..maxReportConfigId)) OF SEQUENCE {	1 entry		
reportConfigId[1]	IdReportConfigInterRAT - PERIODICAL		
reportConfig[1]	ReportConfigInterRAT-PERIODICAL		
}			
measIdToAddModList SEQUENCE (SIZE (1..maxMeasId)) OF SEQUENCE {	2 entry		
measId[1]	1		
measObjectId[1]	IdMeasObject-f8		
reportConfigId[1]	IdReportConfigInterRAT - PERIODICAL		
measId[2]	2		
measObjectId[2]	IdMeasObject-f11		
reportConfigId[2]	IdReportConfigInterRAT - PERIODICAL		
}			
quantityConfig SEQUENCE {			
quantityConfigUTRA SEQUENCE {			
measQuantityUTRA-FDD	cpich-RSCP		UTRA-FDD
measQuantityUTRA-TDD	pccpch-RSCP		UTRA-TDD
}			
quantityConfigGERAN SEQUENCE {			
measQuantityGERAN	rsi		
}			
}			
measGapConfig CHOICE {			
setup SEQUENCE {			
gapOffset CHOICE {			
gp1	30		
}			
}			
}			
}			

Condition	Explanation
UTRA-FDD	UTRA FDD cell environment
UTRA-TDD	UTRA TDD cell environment

Table 8.3.2.5.3.3-2A: MeasObjectUTRA-f8 (Table 8.3.2.5.3.3-2)

Derivation path: 36.508 table 4.6.6-3 MeasObjectUTRA-GENERIC(f8)			
Information Element	Value/Remark	Comment	Condition
MeasObjectUTRA-GENERIC(f8) ::= SEQUENCE {			
carrierFreq	UTRA DL carrier frequency of the cell 5		
cellsToAddModList CHOICE {			
cellsToAddModListUTRA-FDD ::= SEQUENCE (SIZE (1.. maxCellMeas)) OF SEQUENCE {			UTRA-FDD
cellIndex [1]	1		
physCellId [1]	physicalCellIdentity – Cell 5		
}			
cellsToAddModListUTRA-TDD ::= SEQUENCE (SIZE (1..maxMeasId)) OF SEQUENCE {			UTRA-TDD
cellIndex [1]	1		
physCellId [1]	physicalCellIdentity – Cell 5		
}			
}			
}			

Condition	Explanation
UTRA-FDD	UTRA-FDD cell environment
UTRA-TDD	UTRA-TDD cell environment

Table 8.3.2.5.3.3-3: MeasurementReport (step 1, Table 8.3.2.5.3.2-3)

Derivation Path: 36.508, Table 4.6.1-5			
Information Element	Value/remark	Comment	Condition
MeasurementReport ::= SEQUENCE {			
criticalExtensions CHOICE {			
c1 CHOICE{			
measurementReport-r8 SEQUENCE {			
measResults SEQUENCE {			
measId	1		
measResultServCell SEQUENCE {			
rsrpResult	(0..97)		
rsrqResult	(0..34)		
}			
measResultsNeighCells CHOICE {			
measResultListUTRA SEQUENCE (SIZE (1..maxCellReport)) OF SEQUENCE {	1 entry		
physCellId[1] CHOICE {			
fdd	PhysicalCellIdentity of Cell 5		UTRA-FDD
tdd	PhysicalCellIdentity of Cell 5		UTRA-TDD
}			
}			
cgi-info[1]	Not present		
measResult[1] SEQUENCE {			
utra-RSCP	(-5..91)		
}			
}			
}			
}			
}			
}			

Condition	Explanation
-----------	-------------

UTRA-FDD	UTRA FDD cell environment
UTRA-TDD	UTRA TDD cell environment

Table 8.3.2.5.3.3-4: MeasurementReport (step 1, Table 8.3.2.5.3.2-4)

Derivation Path: 36.508, Table 4.6.1-5			
Information Element	Value/remark	Comment	Condition
MeasurementReport ::= SEQUENCE {			
criticalExtensions CHOICE {			
c1 CHOICE{			
measurementReport-r8 SEQUENCE {			
measResults SEQUENCE {			
measId	2		
measResultServCell SEQUENCE {			
rsrpResult	(0..97)		
rsrqResult	(0..34)		
}			
measResultsNeighCells CHOICE {			
measResultListGERAN SEQUENCE (SIZE (1..maxCellReport)) OF SEQUENCE {	1 entry		
carrierFreq[1] SEQUENCE {			
arfcn	Not checked		
bandIndicator	Not checked		
}			
physCellId[1]	PhysicalCellIdentity of Cell 24		
cgi-info[1]	Not present		
measResult[1] SEQUENCE {			
rsi	(0..63)		
}			
}			
}			
}			
}			
}			

Table 8.3.2.5.3.3-5: RRCConnectionReconfiguration (step 12, Table 8.3.2.5.3.2-2)

Derivation Path: 36.508, Table 4.6.1-8, condition MEAS
--

Table 8.3.2.5.3.3-6: MeasConfig (Table 8.3.2.5.3.3-5)

Derivation Path: 36.508, Table 4.6.6-1			
Information Element	Value/remark	Comment	Condition
MeasConfig ::= SEQUENCE {			
measIdToRemoveList SEQUENCE (SIZE (1..maxMeasId)) OF SEQUENCE {	2 entries		
measId[1]	1		
measId[2]	2		
}			
}			

Table 8.3.2.5.3.3-7: MeasObjectGERAN-f11 (Table 8.3.2.5.3.3-5)

Derivation Path: 36.508 clause 4.6.6			
Information Element	Value/remark	Comment	Condition
MeasObjectGERAN-GENERIC(Freq) ::= SEQUENCE {			
carrierFreqs SEQUENCE {			
startingARFCN	Downlink GERAN ARFCN of Cell 24		
bandIndicator	Set according to the band used for GERAN Cell 24		
followingARFCNs CHOICE {			
explicitListOfARFCNs	Empty list		
}			
}			
offsetFreq	0 (dB 0)		
ncc-Permitted	'01000000'B		
cellForWhichToReportCGI	Not present		
}			

8.3.2.6 Measurement configuration control and reporting / Inter-RAT measurements / Simultaneous A2 and two B2 / Measurements of E-UTRAN, UTRAN and GERAN cells

8.3.2.6.1 Test Purpose (TP)

(1)

```
with { UE in E-UTRA RRC_CONNECTED state and measurements configured for A2 on E-UTRAN, B2 on UTRAN
and B2 on GERAN at the same time }
ensure that {
  when { UE detects entering condition for the events A2 and B2 are not met }
  then { UE does not transmit any MeasurementReport messages }
}
```

(2)

```
with { UE in E-UTRA RRC_CONNECTED state and measurements configured for A2 on E-UTRAN, B2 on UTRAN
and B2 on GERAN at the same time }
ensure that {
  when { UE detects entering condition for the event A2 is met }
  then { UE transmits a MeasurementReport message }
}
```

(3)

```
with { UE in E-UTRA RRC_CONNECTED state and measurements configured for A2 on E-UTRAN, B2 on UTRAN
and B2 on GERAN at the same time }
ensure that {
  when { UE detects entering condition for the event B2 for UTRAN is met }
  then { UE transmits a MeasurementReport message }
}
```

(4)

```
with { UE in E-UTRA RRC_CONNECTED state and measurements configured for A2 on E-UTRAN, B2 on UTRAN
and B2 on GERAN at the same time }
ensure that {
  when { UE detects entering condition for the event B2 for GERAN is met }
  then { UE transmits a MeasurementReport message }
}
```

8.3.2.6.2 Conformance requirements

References: The conformance requirements covered in the present TC are specified in: TS 36.331, clause 5.5.4.1, 5.5.4.3, 5.5.4.8 and 5.5.5.

[TS 36.331, clause 5.5.4.1]

The UE shall:

- 1> for each *measId* included in the *measIdList* within *VarMeasConfig*:
 - 2> if the corresponding *reportConfig* includes a purpose set to ‘*reportStrongestCellsForSON*’:
 - ...
 - 2> else:
 - 3> if the corresponding *measObject* concerns E-UTRA:
 - 4> consider any neighbouring cell detected on the associated frequency to be applicable when the concerned cell is not included in the *blackCellsToAddModList* defined within the *VarMeasConfig* for this *measId*;
 - 3> else if the corresponding *measObject* concerns UTRA or CDMA2000:
 - 4> consider a neighbouring cell on the associated frequency to be applicable when the concerned cell is included in the *cellsToAddModList* defined within the *VarMeasConfig* for this *measId* (i.e. the cell is included in the white-list);
 - 3> else if the corresponding *measObject* concerns GERAN:
 - 4> consider a neighbouring cell on the associated set of frequencies to be applicable when the concerned cell matches the *ncc-Permitted* defined within the *VarMeasConfig* for this *measId*;
 - 2> if the *triggerType* is set to ‘*event*’ and if the entry condition applicable for this event, i.e. the event corresponding with the *eventId* of the corresponding *reportConfig* within *VarMeasConfig*, is fulfilled for one or more applicable cells for all measurements after layer 3 filtering taken during *timeToTrigger* defined for this event within the *VarMeasConfig*, while the *VarMeasReportList* does not include an measurement reporting entry for this *measId* (a first cell triggers the event):
 - 3> include a measurement reporting entry within the *VarMeasReportList* for this *measId*;
 - 3> set the *numberOfReportsSent* defined within the *VarMeasReportList* for this *measId* to 0;
 - 3> include the concerned cell(s) in the *cellsTriggeredList* defined within the *VarMeasReportList* for this *measId*;
 - 3> initiate the measurement reporting procedure, as specified in 5.5.5;

[TS 36.331, clause 5.5.4.3]

The UE shall:

- 1> consider the entering condition for this event to be satisfied when condition A2-1, as specified below, is fulfilled;
- 1> consider the leaving condition for this event to be satisfied when condition A2-2, as specified below, is fulfilled;

Inequality A2-1 (Entering condition)

$$Ms + Hys < Thresh$$

Inequality A2-2 (Leaving condition)

$$Ms - Hys > Thresh$$

The variables in the formula are defined as follows:

Ms is the measurement result of the serving cell, not taking into account any offsets.

Hys is the hysteresis parameter for this event (i.e. *hysteresis* as defined within *reportConfigEUTRA* for this event).

Thresh is the threshold parameter for this event (i.e. *a2-Threshold* as defined within *reportConfigEUTRA* for this event).

Ms is expressed in dBm in case of RSRP, or in dB in case of RSRQ.

Hys is expressed in dB.

Thresh is expressed in the same unit as *Ms*.

[TS 36.331, clause 5.5.4.8]

The UE shall:

- 1> for UTRA and CDMA2000, only trigger the event for cells included in the corresponding measurement object;
- 1> consider the entering condition for this event to be satisfied when both condition B2-1 and condition B2-2, as specified below, are fulfilled;
- 1> consider the leaving condition for this event to be satisfied when condition B2-3 or condition B2-4, i.e. at least one of the two, as specified below, is fulfilled;

Inequality B2-1 (Entering condition 1)

$$Ms + Hys < Thresh1$$

Inequality B2-2 (Entering condition 2)

$$Mn + Ofn - Hys > Thresh2$$

Inequality B2-3 (Leaving condition 1)

$$Ms - Hys > Thresh1$$

Inequality B2-4 (Leaving condition 2)

$$Mn + Ofn + Hys < Thresh2$$

The variables in the formula are defined as follows:

Ms is the measurement result of the serving cell, not taking into account any offsets.

Mn is the measurement result of the inter-RAT neighbour cell, not taking into account any offsets.

Ofn is the frequency specific offset of the frequency of the inter-RAT neighbour cell (i.e. *offsetFreq* as defined within the *measObject* corresponding to the frequency of the inter-RAT neighbour cell).

Hys is the hysteresis parameter for this event (i.e. *hysteresis* as defined within *reportConfigInterRAT* for this event).

Thresh1 is the threshold parameter for this event (i.e. *b2-Threshold1* as defined within *reportConfigInterRAT* for this event).

Thresh2 is the threshold parameter for this event (i.e. *b2-Threshold2* as defined within *reportConfigInterRAT* for this event).

Ms is expressed in dBm in case of RSRP, or in dB in case of RSRQ.

Mn is expressed in dBm or dB, depending on the measurement quantity of the inter-RAT neighbour cell.

Ofn, *Hys* are expressed in dB.

Thresh1 is expressed in the same unit as *Ms*.

Thresh2 is expressed in the same unit as *Mn*.

[TS 36.331, clause 5.5.5]

For the *measId* for which the measurement reporting procedure was triggered, the UE shall set the *measResults* within the *MeasurementReport* message as follows:

- 1> set the *measId* to the measurement identity that triggered the measurement reporting;
- 1> set the *measResultServCell* to include the quantities of serving cell;

1> if there is at least one applicable neighbouring cell to report:

2> set the *measResultsNeighCells* to include the best neighbouring cells up to *maxReportCells* in accordance with the following:

3> if the *triggerType* is set to 'event':

4> include the cells included in the *cellsTriggeredList* as defined within the *VarMeasReportList* for this *measId*;

3> else:

...

3> for each cell that is included in the *measResultsNeighCells*, include the *physCellId*;

3> if the *triggerType* is set to 'event'; or the *purpose* is set to 'reportStrongestCells' or to 'reportStrongestCellsForSON':

4> for each included cell, include the layer 3 filtered measured results in accordance with the *reportConfig* for this *measId*, ordered as follows:

5> if the *measObject* associated with this *measId* concerns E-UTRA:

6> set the *measResult* to include the quantity(ies) indicated in the *reportQuantity* within the concerned *reportConfig* in order of decreasing *triggerQuantity*, i.e. the best cell is included first;

5> else:

6> set the *measResult* to the quantity as configured for the concerned RAT within the *quantityConfig* in order of decreasing quantity, i.e. the best cell is included first;

...

1> submit the *MeasurementReport* message to lower layers for transmission, upon which the procedure ends;

8.3.2.6.3 Test description

8.3.2.6.3.1 Pre-test conditions

System Simulator:

- Cell 1, Cell 5 and Cell 24.
- System information combination 10 as defined in TS 36.508 [18] clause 4.4.3.1 is used in E-UTRA cells.

UE:

None.

Preamble:

- The UE is in state Generic RB Established (state 3) on Cell 1 according to [18].

8.3.2.6.3.2 Test procedure sequence

Table 8.3.2.6.3.2-1 illustrates the downlink power levels to be applied for the cells at various time instants of the test execution. Row marked "T0" denotes the initial conditions after preamble, while columns marked "T1" is to be applied subsequently. The exact instants on which these values shall be applied are described in the texts in this clause.

Table 8.3.2.6.3.2-1: Power levels

	Parameter	Unit	Cell 1	Cell 5	Cell 24	Remark
T0	RS EPRE	dBm/15kHz	-85	-	-	Entry conditions for A2 and B2 events are not fulfilled.
	CPICH_Ec (UTRA FDD)	dBm/3.84 MHz	-	-80	-	
	PCCPCH_Ec (UTRA LCR TDD)	dBm/1.28 MHz	-	-80	-	
	GERAN Cell Power	dBm	-	-	-85	
T1	RS EPRE	dBm/15kHz	-105	-	-	Entry conditions for A2 and B2 events are fulfilled.
	CPICH_Ec (UTRA FDD)	dBm/3.84 MHz	-	-60	-	
	PCCPCH_Ec (UTRA LCR TDD)	dBm/1.28 MHz	-	-60	-	
	GERAN Cell Power	dBm	-	-	-65	

Table 8.3.2.6.3.2-2: Main behaviour

St	Procedure	Message Sequence		TP	Verdict
		U - S	Message		
1	The SS transmits an <i>RRConnectionReconfiguration</i> message to setup intra and inter RAT measurements on Cell 1.	<--	<i>RRConnectionReconfiguration</i>	-	-
2	The UE transmits an <i>RRConnectionReconfigurationComplete</i> message.	-->	<i>RRConnectionReconfigurationComplete</i>	-	-
3	Check: Does the UE transmit any <i>MeasurementReport</i> messages during the next 10s?	-->	<i>MeasurementReport</i>	1	F
4	The SS changes Cell 1, Cell 5 and Cell 24 parameters according to row "T1" in table 8.3.2.6.3.2-1.	-	-	-	-
-	EXCEPTION: In parallel to step 5 the steps specified in Table 8.3.2.6.3.2-3 shall take place.	-	-	-	-
5	The SS waits for 15s to allow for the switching of cells and UE measurement.	-	-	-	-
6	Check: Does the test result of generic test procedure in TS 36.508 subclause 6.4.2.3 indicate that the UE is in E-UTRA RRC_CONNECTED state on Cell 1?	-	-	1, 2, 3, 4	-

Table 8.3.2.6.3.2-3: Parallel behaviour

St	Procedure	Message Sequence		TP	Verdict
		U - S	Message		
-	EXCEPTION: The steps 1-3 may occur in any order.	-	-	-	-
1	Check: Does the UE transmit a <i>MeasurementReport</i> message to report event A2 for Cell 1 ?	-->	<i>MeasurementReport</i>	2	P
2	Check: Does the UE transmit a <i>MeasurementReport</i> message to report event B2 for Cell 5 ?	-->	<i>MeasurementReport</i>	3	P
3	Check: Does the UE transmit a <i>MeasurementReport</i> message to report event B2 for Cell 24 ?	-->	<i>MeasurementReport</i>	4	P

8.3.2.6.3.3 Specific message contents

Table 8.3.2.6.3.3-1: RRCConnectionReconfiguration (step 1, Table 8.3.2.6.3.2-2)

Derivation Path: 36.508 table 4.6.1-8 with condition MEAS

Table 8.3.2.6.3.3-2: MeasConfig (Table 8.3.2.6.3.3-1)

Derivation path: 36.508 table 4.6.6-1 with condition INTER-RAT			
Information Element	Value/Remark	Comment	Condition
measConfig ::= SEQUENCE {			
measObjectToAddModList SEQUENCE (SIZE (1..maxObjectId)) OF SEQUENCE {	3 entries		
measObjectId[1]	IdMeasObject-EUTRA		
measObject[1]	MeasObjectEUTRA-GENERIC(f1)		
measObjectId[2]	IdMeasObject-UTRA		
measObject[2]	MeasObjectUTRA-f8		
measObjectId[3]	IdMeasObject-GERAN		
measObject[3]	MeasObjectGERAN-GENERIC(f11)		
}			
reportConfigToAddModList SEQUENCE (SIZE (1..maxReportConfigId)) OF SEQUENCE {	3 entries		
reportConfigId[1]	IdReportConfig-A2		
reportConfig[1]	ReportConfigEUTRA-A2(-95)		
reportConfigId[2]	IdReportConfig-B2-UTRA		
reportConfig[2]	ReportConfigInterRAT-B2-UTRA(-95, -70)		
reportConfigId[3]	IdReportConfig-B2-GERAN		
reportConfig[3]	ReportConfigInterRAT-B2-GERAN(-95,-75)		
}			
measIdToAddModList SEQUENCE (SIZE (1..maxMeasId)) OF SEQUENCE {	3 entries		
measId[1]	1		
measObjectId[1]	IdMeasObject-EUTRA		
reportConfigId[1]	IdReportConfig-A2		
measId[2]	2		
measObjectId[2]	IdMeasObject-UTRA		
reportConfigId[2]	IdReportConfig-B2-UTRA		
measId[3]	3		
measObjectId[3]	IdMeasObject-GERAN		
reportConfigId[3]	IdReportConfig-B2-GERAN		
}			
quantityConfig SEQUENCE {			
quantityConfigUTRA SEQUENCE {			
measQuantityUTRA-FDD	cpich-RSCP		UTRA-FDD
measQuantityUTRA-TDD	pccpch-RSCP		UTRA-TDD
filterCoefficient	fc4		
}			
quantityConfigGERAN SEQUENCE {			
measQuantityGERAN	rssi		
filterCoefficient	fc2		
}			
}			
}			

Condition	Explanation
-----------	-------------

UTRA-FDD	UTRA FDD cell environment
UTRA-TDD	UTRA TDD cell environment

Table 8.3.2.6.3.3-3: MeasObjectUTRA-f8 (Table 8.3.2.6.3.3-2)

Derivation path: 36.508 table 4.6.6-3 MeasObjectUTRA-GENERIC(f8)			
Information Element	Value/Remark	Comment	Condition
MeasObjectUTRA-GENERIC(f8) ::= SEQUENCE {			
carrierFreq	UTRA DL carrier frequency of the cell 5		
cellsToAddModList CHOICE {			
cellsToAddModListUTRA-FDD ::= SEQUENCE (SIZE (1.. maxCellMeas)) OF SEQUENCE {			UTRA-FDD
cellIndex [1]	1		
physCellId [1]	physicalCellIdentity – Cell 5		
}			
cellsToAddModListUTRA-TDD ::= SEQUENCE (SIZE (1..maxMeasId)) OF SEQUENCE {			UTRA-TDD
cellIndex [1]	1		
physCellId [1]	physicalCellIdentity – Cell 5		
}			
}			
}			

Condition	Explanation
UTRA-FDD	UTRA-FDD cell environment
UTRA-TDD	UTRA-TDD cell environment

Table 8.3.2.6.3.3-4: Void

Table 8.3.2.6.3.3-5: Void

Table 8.3.2.6.3.3-6: MeasurementReport (step 1 Table 8.3.2.6.3.2-3)

Derivation path: 36.508 table 4.6.1-5			
Information Element	Value/Remark	Comment	Condition
MeasurementReport ::= SEQUENCE {			
criticalExtensions CHOICE {			
c1 CHOICE {			
measurementReport-r8 SEQUENCE {			
measResults ::= SEQUENCE {			
measId	1		
measResultServCell ::= SEQUENCE {		Report Cell 1	
rsrpResult	(0..97)		
rsrqResult	(0..34)		
}			
measResultNeighCells CHOICE {}	Not present		
}			
}			
}			
}			

Table 8.3.2.6.3.3-7: MeasurementReport (step 2 Table 8.3.2.6.3.2-3)

Derivation path: 36.508 table 4.6.1-5			
Information Element	Value/Remark	Comment	Condition
MeasurementReport ::= SEQUENCE {			
criticalExtensions CHOICE {			
c1 CHOICE {			
measurementReport-r8 SEQUENCE {			
measResults ::= SEQUENCE {			
measId	2		
measResultServCell ::= SEQUENCE {			
rsrpResult	(0..97)		
rsrqResult	(0..34)		
}			
measResultNeighCells CHOICE {		Report Cell 5	
measResultListUTRA SEQUENCE (SIZE (1..maxCellReport)) OF MeasResultUTRA SEQUENCE {	1 entry		
physCellId [1]	physCellId of cell 5		
cgi-Info [1]	Not present		
measResult [1] SEQUENCE {			
utra-RSCP	(-5..91)		
}			
}			
}			
}			
}			
}			
}			
}			
}			
}			

Table 8.3.2.6.3.3-8: MeasurementReport (step 3 Table 8.3.2.6.3.2-3)

Derivation path: 36.508 table 4.6.1-5			
Information Element	Value/Remark	Comment	Condition
MeasurementReport ::= SEQUENCE {			
criticalExtensions CHOICE {			
c1 CHOICE {			
measurementReport-r8 SEQUENCE {			
measResults ::= SEQUENCE {			
measId	3		
measResultServCell ::= SEQUENCE {			
rsrpResult	(0..97)		
rsrqResult	(0..34)		
}			
measResultNeighCells CHOICE {		Report Cell 24	
measResultListGERAN SEQUENCE (SIZE (1..maxCellReport)) OF MeasResultGERAN SEQUENCE {	1 entry		
carrierFreq [1]	Not checked		
physCellId [1]	physCellId of cell 24		
cgi-Info [1]	Not present		
measResult [1] SEQUENCE {			
rssi	(0..63)		
}			
}			
}			
}			
}			
}			
}			
}			
}			
}			

8.3.2.7 Measurement configuration control and reporting / Inter-RAT measurements / Event B2 (measurement HRPD cells)

8.3.2.7.1 Test Purpose (TP)

(1)

```
with { UE having completed the radio bearer establishment, initial security activation procedure and
performed the inter RAT measurement for HRPD cell and not detected entering condition for the event
B2 is met }
ensure that {
  when { UE detects entering condition for the event B2 is not met }
  then { UE does not transmit any MeasurementReport }
}
```

(2)

```
with { UE having completed the radio bearer establishment, initial security activation procedure and
performed the inter RAT measurement for HRPD cell and not detected entering condition for the event
B2 is met }
ensure that {
  when { UE detects entering condition for the event B2 is met }
  then { UE transmits a MeasurementReport }
}
```

(3)

```
with { UE having completed the radio bearer establishment, initial security activation procedure and
performed the inter RAT measurement for HRPD cell and detected entering condition for the event B2
is met }
ensure that {
  when { UE detects leaving condition for the event B2 is met }
  then { UE does not transmit any MeasurementReport }
}
```

8.3.2.7.2 Conformance Requirements

References: The conformance requirements covered in the present TC are specified in: 3GPP TS 36.331 clauses 5.5.4.1, 5.5.4.8, and 5.5.5.

[TS 36.331, clause 5.5.4.1]

The UE shall:

- 1> for each *measId* included in the *measIdList* within *VarMeasConfig*:...
- 2>else:
 - ...
 - 3> if the corresponding *measObject* concerns UTRA or CDMA2000:
 - 4> consider a neighbouring cell on the associated frequency to be applicable when the concerned cell is included in the *cellsToAddModifyList* defined within the *VarMeasurementConfiguration* for this *measId* (i.e. the cell is included in the white-list);
 - ...
 - 2> if the *triggerType* is set to 'event' and if the entry condition applicable for this event, i.e. the event corresponding with the *eventId* of the corresponding *reportConfig* within *VarMeasurementConfiguration*, is fulfilled for one or more applicable cells for a duration exceeding the value of *timeToTrigger* defined for this event within the *VarMeasurementConfiguration* while the *VarMeasurementReports* does not include an entry for this *measId* (a first cell triggers the event):
 - 3> include a measurement reporting entry within the *VarMeasReportList* for this *measId*;
 - 3> set the *numberOfReportsSent* defined within the *VarMeasReportList* for this *measId* to 0;

- 3> include the concerned cell(s) in the *cellsTriggeredList* defined within the *VarMeasReportList* for this *measId*;
- 3> initiate the measurement reporting procedure, as specified in 5.5.5;
- 2> if the *triggerType* is set to 'event' and if the entry condition applicable for this event, i.e. the event corresponding with the *eventId* of the corresponding *reportConfig* within *VarMeasConfig*, is fulfilled for one or more applicable cells not included in the *cellsTriggeredList* for all measurements after layer 3 filtering taken during *timeToTrigger* defined for this event within the *VarMeasConfig* (a subsequent cell triggers the event):
 - 3> set the *numberOfReportsSent* defined within the *VarMeasReportList* for this *measId* to 0;
 - 3> include the concerned cell(s) in the *cellsTriggeredList* defined within the *VarMeasReportList* for this *measId*;
 - 3> initiate the measurement reporting procedure, as specified in 5.5.5;
- 2> if the *triggerType* is set to 'event' and if the leaving condition applicable for this event is fulfilled for one or more of the cells included in the *cellsTriggeredList* defined within the *VarMeasReportList* for this *measId* for all measurements after layer 3 filtering taken during *timeToTrigger* defined within the *VarMeasConfig* for this event:
 - 3> remove the concerned cell(s) in the *cellsTriggeredList* defined within the *VarMeasReportList* for this *measId*;
 - 3> if *reportOnLeave* is set to *TRUE* for the corresponding reporting configuration:
 - 4> initiate the measurement reporting procedure, as specified in 5.5.5;
 - 3> if the *cellsTriggeredList* defined within the *VarMeasReportList* for this *measId* is empty:
 - 4> remove the entry within the *VarMeasReportList* for this *measId*;
 - 4> stop the periodical reporting timer for this *measId*, if running;
 - ...

NOTE 2: The UE does not stop the periodical reporting with *triggerType* set to 'event' or to 'periodical' while the corresponding measurement is not performed due to the serving cell RSRP being equal to or better than *s-Measure* or due to the measurement gap not being setup .

[TS 36.331, clause 5.5.4.8]

The UE shall:

- 1> for UTRA and CDMA2000, only trigger the event for cells included in the corresponding measurement object;
- 1> apply inequality B2-1 and inequality B2-2 i.e. both have to be fulfilled, as specified below, as the entry condition for this event;
- 1> apply inequality B2-3 and inequality B2-4 i.e. at least one of the two has to be fulfilled, as specified below, as the leaving condition for this event;

Inequality B2-1 (Entering condition 1)

$$M_s + H_{ys} < Thresh1$$

Inequality B2-2 (Entering condition 2)

$$M_n + O_{fn} - H_{ys} > Thresh2$$

Inequality B2-3 (Leaving condition 1)

$$M_s - H_{ys} > Thresh1$$

Inequality B2-4 (Leaving condition 2)

$$Mn + Ofn + Hys < Thresh2$$

The variables in the formula are defined as follows:

Ms is the measurement result of the serving cell, not taking into account any offset.

Mn is the measurement result of the inter-RAT neighbour cell, not taking into account any offsets.

Ofn is the frequency specific offset of the frequency of the inter-RAT neighbour cell (i.e. *offsetFreq* as defined within the *measObject* corresponding to the frequency of the inter-RAT neighbour cell).

Hys is the hysteresis parameter for this event (i.e. *hysteresis* as defined within *reportConfigInterRAT* for this event).

Thresh1 is the threshold parameter for this event (i.e. *b2-Threshold1* as defined within *reportConfigInterRAT* for this event).

Thresh2 is the threshold parameter for this event (i.e. *b2-Threshold2* as defined within *reportConfigInterRAT* for this event).

Ms is expressed in dBm in case of RSRP, or in dB in case of RSRQ.

Mn is expressed in dBm or dB, depending on the measurement quantity of the inter RAT neighbour cell.

Ofn*, *Hys are expressed in dB.

Thresh1 is expressed in the same unit as ***Ms***.

Thresh2 is expressed in the same unit as ***Mn***.

[TS 36.331, clause 5.5.5]

For the *measId* for which the measurement reporting procedure was triggered, the UE shall set the *measResults* within the *MeasurementReport* message as follows:

- 1> set the *measId* to the measurement identity that triggered the measurement reporting;
- 1> set the *measResultServCell* to include the quantities of serving cell;
- 1> if there is at least one applicable neighbouring cell to report:
- 2> set the *measResultNeighCells* to include the best neighbouring cells up to *maxReportCells* in accordance with the following:
 - 3> if the *triggerType* is set to 'event':
 - 4> include the cells included in the *cellsTriggeredList* as defined within the *VarMeasurementReports* for this *measId*;
 - ...
 - > for each cell that is included in the *measResultNeighCells*, include the *physCellId*;
 - 3> if the *triggerType* is set to 'event'; or the *purpose* is set to 'reportStrongestCells' or to 'reportStrongestCellsForSON':
 - 4> for each included cell include the layer 3 filtered measured results in accordance with the *reportConfig* for this *measId*, ordered as follows:
 - 5> if the *measObject* associated with this *measId* concerns E-UTRA:
 - 6> set the *measResult* to include the quantity(ies) indicated in the *reportQuantity* within the concerned *reportConfig* in order of decreasing *triggerQuantity*, i.e. the best cell is included first;
 - 5> else:
 - 6> set the *measResult* to the quantity as configured for the concerned RAT within the *quantityConfig* in order of decreasing *triggerQuantity*, i.e. the best cell is included first;

- ...
- 1> increment the *numberOfReportsSent* as defined within the *VarMeasReportList* for this *measId* by 1;
 - 1> stop the periodical reporting timer, if running;
 - 1> if the *numberOfReportsSent* as defined within the *VarMeasReportList* for this *measId* is less than the *reportAmount* as defined within the corresponding *reportConfig* for this *measId* :
 - 2> start the periodical reporting timer with the value of *reportInterval* as defined within the corresponding *reportConfig* for this *measId*;
 - ...
 - 1> if the measured results are for CDMA2000 1xRTT:
 - 2> set the *preRegistrationStatusHRPD* to `FALSE`;
 - 1> submit the *MeasurementReport* message to lower layers for transmission, upon which the procedure ends.

8.3.2.7.3 Test description

8.3.2.7.3.1 Pre-test conditions

System Simulator:

- Cell 1 is high quality cell on E-UTRA
- Cell 15 and Cell 16 are high quality cell on HRPD.
- System information combination 6 as defined in TS 36.508 [18] clause 4.4.3.1 is used in E-UTRA cells.

UE:

None.

Preamble:

- The UE is in state Generic RB Established (state 3) on Cell 1 according to [18].

8.3.2.7.3.2 Test procedure sequence

Table 8.3.2.7.3.2-1 illustrates the downlink power levels and other changing parameters to be applied for the cells at various time instants of the test execution. Row marked "T0" denotes the initial conditions, while columns marked "T1" and "T2" are to be applied subsequently. The exact instants on which these values shall be applied are described in the texts in this clause.

Table 8.3.2.7.3.2-1: Time instances of cell power level and parameter changes

	Parameter	Unit	Cell 1	Cell 15	Cell 16	Remark
T0	Cell-specific RS EPRE	dBm/15 kHz	-60	-	-	The power level values are such that entering conditions for event B2 are not satisfied.
	$\hat{I}_{or/loc}$	dB	-	-20	-20	
	I_{oc}	dBm/1.23 MHz	-	-55	-55	
	Pilot_Ec/Io (Note 1)	dB	-	-20	-20	
T1	Cell-specific RS EPRE	dBm/15 kHz	-80	-	-	The power level values are such that entering conditions for event B2 are satisfied.
	$\hat{I}_{or/loc}$	dB	-	-5	-20	
	I_{oc}	dBm/1.23 MHz	-	-55	-55	
	Pilot_Ec/Io (Note 1)	dB	-	-6	-20	
T2	Cell-specific RS EPRE	dBm/15 kHz	-60	-	-	The power level values are such that leaving conditions for event B2 are satisfied.
	$\hat{I}_{or/loc}$	dB	-	-20	-20	
	I_{oc}	dBm/1.23 MHz	-	-55	-55	
	Pilot_Ec/Io (Note 1)	dB	-	-20	-20	

Note 1: This parameter is not directly settable, but is derived by calculation from the other parameters set by the SS.

Table 8.3.2.7.3.2-2: Main behaviour

St	Procedure	Message Sequence		TP	Verdict
		U - S	Message		
1	The SS transmits an <i>RRCCONNECTIONRECONFIGURATION</i> message to setup inter RAT measurement on Cell 1.	<--	<i>RRCCONNECTIONRECONFIGURATION</i>	-	-
2	The UE transmits an <i>RRCCONNECTIONRECONFIGURATIONCOMPLETE</i> message to confirm the setup of inter RAT measurement on Cell 1.	-->	<i>RRCCONNECTIONRECONFIGURATIONCOMPLETE</i>	-	-
3	Check: Does the UE transmit a <i>MEASUREMENTREPORT</i> message to report the event B2 during the next 10s?	-->	<i>MEASUREMENTREPORT</i>	1	F
4	The SS changes Cell 1, Cell 15 and Cell 16 parameters according to row "T1" in table 8.3.2.7.3.2-1.	-	-	-	-
5	Check: Does the UE transmit a <i>MEASUREMENTREPORT</i> message to report the event B2 for Cell 15, not including Cell 16?	-->	<i>MEASUREMENTREPORT</i>	2	P
6	Void	-	-	-	-
7	The SS changes Cell 1, Cell 15 and Cell 16 parameters according to row "T2" in table 8.3.2.7.3.2-1.	-	-	-	-
8	Check: Does the UE transmit a <i>MEASUREMENTREPORT</i> message to report the event B2 during the next 10s?	-->	<i>MEASUREMENTREPORT</i>	3	F
9-13	Void	-	-	-	-
14	Check: Does the test result of generic test procedure in TS 36.508 subclause 6.4.2.3 indicate that the UE is in E-UTRA RRC_CONNECTED state on Cell 1?	-	-	1,2,3	-

8.3.2.7.3.3 Specific Message Contents

Table 8.3.2.7.3.3-1: *RRCCONNECTIONRECONFIGURATION* (step 1, Table 8.3.2.7.3.2-2)

Derivation Path: 36.508, Table 4.6.1-8, condition MEAS			
Information Element	Value/remark	Comment	Condition
<i>RRCCONNECTIONRECONFIGURATION</i> ::= SEQUENCE {			
criticalExtensions CHOICE {			
c1 CHOICE{			
rrcConnectionReconfiguration-r8 SEQUENCE {			
radioResourceConfiguration	Not present		
}			
}			
}			
}			

Table 8.3.2.7.3.3-2: MeasConfig (Table 8.3.2.7.3.3-1)

Derivation Path: 36.508, Table 4.6.6-1			
Information Element	Value/remark	Comment	Condition
MeasConfig ::= SEQUENCE {			
measObjectToAddModList SEQUENCE (SIZE (1..maxObjectId)) OF SEQUENCE {	2ies entr		
measObjectId[1]	IdMeasObject-f1		
measObject[1]	MeasObjectEUTRA-GENERIC(f1)		
measObjectId[2]	IdMeasObject-f14		
measObject[2]	MeasObjectCDMA2000-GENERIC		
}			
reportConfigToAddModList SEQUENCE (SIZE (1..maxReportConfigId)) OF SEQUENCE {	1 entry		
reportConfigId[1]	IdReportConfig-B2-CDMA2000		
reportConfig[1]	ReportConfigInterRAT-B2-CDMA2000(-69, -18)		
}			
measIdToAddModList SEQUENCE (SIZE (1..maxMeasId)) OF SEQUENCE {	1 entry		
measId[1]	1		
measObjectId[1]	IdMeasObject-f14		
reportConfigId[1]	IdReportConfig-B2-CDMA2000		
}			
quantityConfig SEQUENCE {			
quantityConfigCDMA2000 SEQUENCE {			
measQuantityCDMA2000	pilotStrength		
}			
}			
measGapConfig CHOICE {			
setup SEQUENCE {			
gapOffset CHOICE {			
gp1	30		
}			
}			
}			
}			
}			
}			

Table 8.3.2.7.3.3-3: MeasObjectCDMA2000-GENERIC (Table 8.3.2.7.3.3-2)

Derivation Path: 36.508, Table 4.6.6-1C			
Information Element	Value/remark	Comment	Condition
MeasObjectCDMA2000-GENERIC ::= SEQUENCE {			
cdma2000-Type	TypeHRPD		
carrierFreq SEQUENCE {			
bandClass	Band Class of frequency under test		
arfcn	f14		
}			
searchWindowSize	15		
offsetFreq	db0		
cellsToRemoveList	Not present		
cellsToAddModList CHOICE {			
cellsToAddModListCDMA2000 ::= SEQUENCE (SIZE (1.. maxCellMeas)) OF SEQUENCE {			
cellIndex [1]	1		
physCellId [1]	physicalCellIdentity – Cell 15		
}			
}			
cellForWhichToReportCGI	Not present		
}			

Table 8.3.2.7.3.3-4: MeasurementReport (steps 5, Table 8.3.2.7.3.2-2)

Derivation Path: 36.508, Table 4.6.1-5			
Information Element	Value/remark	Comment	Condition
MeasurementReport ::= SEQUENCE {			
criticalExtensions CHOICE {			
c1 CHOICE{			
measurementReport-r8 SEQUENCE {			
measResults SEQUENCE {			
measId	1		
measResultServCell SEQUENCE {			
rsrpResult	(0..97)		
rsrqResult	(0..34)		
}			
measResultNeighCells CHOICE {			
measResultsCDMA2000 ::=SEQUENCE {			
preRegistrationStatusHRPD	FALSE		
measResultListCDMA2000 ::=SEQUENCE (SIZE (1..maxCellReport)) OF SEQUENCE {	1 entry		
physCellId [1]	PhysicalCellIdentity of Cell 15		
cgi-Info[1]	Not present		
measResult[1] SEQUENCE {			
pilotPnPhase	Not present		
pilotStrength	(0..63)		
}			
}			
}			
}			
}			
}			
}			
}			

8.3.2.8 Measurement configuration control and reporting / Inter-RAT measurements / Periodic reporting / Measurement of HRPD cells)

8.3.2.8.1 Test Purpose (TP)

(1)

```
with { UE in E-UTRA RRC_CONNECTED state and measurement configured for periodic reporting of HRPD cells }
ensure that {
  when { The UE receives reference signal power for cells on the HRPD frequency where measurements are configured }
  then { UE sends MeasurementReport message at regular intervals for these HRPD cells }
}
```

(2)

```
with { UE in E-UTRA RRC_CONNECTED state and a Measurement Report message for a configured periodic measurement reporting of HRPD cells on a configured frequency were sent }
ensure that {
  when { A previously reported cell become unavailable or the UE receives reference signal power on a reported HRPD frequency for a cell which was previously not reported }
  then { UE sends MeasurementReport message at regular intervals for the available HRPD cells }
}
```

(3)

```
with { UE in E-UTRA RRC_CONNECTED state and periodic measurement reporting of HRPD cells ongoing }
ensure that {
  when { The UE receives a RRCCConnectionReconfiguration message removing the measID of periodic reporting of HRPD cells }
  then { UE stops sending MeasurementReport message for HRPD cells }
}
```

8.3.2.8.2 Conformance Requirements

References: The conformance requirements covered in the present TC are specified in: 3GPP TS 36.331 clauses 5.3.5.3, 5.5.2.2, 5.5.4.1 and 5.5.5.

[TS 36.331, clause 5.3.5.3]

If the *RRCCConnectionReconfiguration* message does not include the *mobilityControlInformation* and the UE is able to comply with the configuration included in this message, the UE shall:

.....

1> if the *RRCCConnectionReconfiguration* message includes the *measurementConfiguration*:

2> perform the measurement configuration procedure as specified in 5.5.2;

[TS 36.331, clause 5.5.2.2]

The UE shall:

1> for each *measId* value included in the *measIdToRemoveList*:

2> remove the entry, from the parameter *measIdList* within *VarMeasurementConfiguration*, with the corresponding *measId* value;

2> remove the entry within the *VarMeasurementReports* for this *measId*, if included;

2> reset the periodical reporting timer or timer T321, whichever one is running, as well as associated information (e.g. *timeToTrigger*) for this *measId*.

[TS 36.331, clause 5.5.4.1]

[Rel-8]

The UE shall:

- 1> for each *measId* included in the *measIdList* within *VarMeasurementConfiguration*:
 - 2> if the *triggerType* is set to 'event':
 - 3> if the corresponding *measObject* concerns UTRA or CDMA2000:
 - 4> consider a neighbouring cell on the associated frequency to be applicable when the concerned cell is included in the *cellsToAddModifyList* defined within the *VarMeasurementConfiguration* for this *measId* (i.e. the cell is included in the white-list);
 - 3> else if the corresponding *measObject* concerns GERAN:
 - 4> consider a neighbouring cell on the associated set of frequencies to be applicable when the concerned cell matches the *ncc-Permitted* defined within the *VarMeasurementConfiguration* for this *measId*;
 - 3> else if the corresponding *measObject* concerns EUTRA:
 - 4> consider any neighbouring cell detected on the associated frequency to be applicable when the concerned cell is not included in the *blackListedCellsToAddModifyList* defined within the *VarMeasurementConfiguration* for this *measId*;
 - 2> else consider a neighbouring cell on the associated frequency/ set of frequencies (GERAN) to be applicable as follows:
 - 3> if the corresponding *reportingConfig* includes a purpose set to 'reportStrongestCellsForSON':
 - 4> consider any neighbouring cell detected on the associated frequency to be applicable
 - 3> if the corresponding *reportingConfig* includes a purpose set to 'reportCGI':
 - 4> consider any neighbouring cell detected on the associated frequency/ set of frequencies (GERAN) which has a *physicalCellIdentity* matching the value of the *cellForWhichToReportCGI* included in the corresponding *measObject* within the *VarMeasurementConfiguration* to be applicable
 - 3> else:
 - 4> if the corresponding *measObject* concerns UTRA or CDMA2000:
 - 5> consider a neighbouring cell on the associated frequency to be applicable when the concerned cell is included in the *cellsToAddModifyList* defined within the *VarMeasurementConfiguration* for this *measId* (i.e. the cell is included in the white-list);
-
- 2> if the *triggerType* is set to 'periodical' and a (first) measurement result is available for one or more applicable cells:
 - 3> include an entry within the *VarMeasurementReports* for this *measId*;
 - 3> set the *numberOfReportsSent* defined within the *VarMeasurementReports* for this *measId* to 0;
 - 3> initiate the measurement reporting procedure, as specified in 5.5.5;
- NOTE 1: If the *purpose* is set to 'reportStrongestCells' or 'reportStrongestCellsForSON', the UE initiates a first measurement report immediately after the requested *reportQuantity* becomes available for at least either serving cell or one of the applicable cells
- 2> Upon expiry of the periodical reporting timer for this *measId*:
 - 3> initiate the measurement reporting procedure, as specified in 5.5.5;
 - 2> upon expiry of the T321 for this *measId*:
 - 3> initiate the measurement reporting procedure, as specified in 5.5.5;

[Rel-11]

The UE shall:

- 1> for each *measId* included in the *measIdList* within *VarMeasConfig*:
 - 2> if the corresponding *reportConfig* includes a purpose set to *reportStrongestCellsForSON*:
 - 3> consider any neighbouring cell detected on the associated frequency to be applicable;
 - 2> else if the corresponding *reportConfig* includes a purpose set to *reportCGI*:
 - 3> consider any neighbouring cell detected on the associated frequency/ set of frequencies (GERAN) which has a physical cell identity matching the value of the *cellForWhichToReportCGI* included in the corresponding *measObject* within the *VarMeasConfig* to be applicable;
 - 2> else:
 - 3> if the corresponding *measObject* concerns E-UTRA:
 - 4> if the *ue-RxTxTimeDiffPeriodical* is configured in the corresponding *reportConfig*:
 - 5> consider only the PCell to be applicable;
 - 4> else if the *eventA1* or *eventA2* is configured in the corresponding *reportConfig*:
 - 5> consider only the serving cell to be applicable;
 - 4> else:
 - 5> consider any neighbouring cell detected on the associated frequency to be applicable when the concerned cell is not included in the *blackCellsToAddModList* defined within the *VarMeasConfig* for this *measId*;
 - 5> for events involving a serving cell on one frequency and neighbours on another frequency, consider the serving cell on the other frequency as a neighbouring cell;
 - 3> else if the corresponding *measObject* concerns UTRA or CDMA2000:
 - 4> consider a neighbouring cell on the associated frequency to be applicable when the concerned cell is included in the *cellsToAddModList* defined within the *VarMeasConfig* for this *measId* (i.e. the cell is included in the white-list);
- NOTE 0: The UE may also consider a neighbouring cell on the associated UTRA frequency to be applicable when the concerned cell is included in the *csg-allowedReportingCells* within the *VarMeasConfig* for this *measId*, if configured in the corresponding *measObjectUTRA* (i.e. the cell is included in the range of physical cell identities for which reporting is allowed).
- 3> else if the corresponding *measObject* concerns GERAN:
 - 4> consider a neighbouring cell on the associated set of frequencies to be applicable when the concerned cell matches the *ncc-Permitted* defined within the *VarMeasConfig* for this *measId*;
 - 2> if the *triggerType* is set to *event* and if the entry condition applicable for this event, i.e. the event corresponding with the *eventId* of the corresponding *reportConfig* within *VarMeasConfig*, is fulfilled for one or more applicable cells for all measurements after layer 3 filtering taken during *timeToTrigger* defined for this event within the *VarMeasConfig*, while the *VarMeasReportList* does not include a measurement reporting entry for this *measId* (a first cell triggers the event):
 - 3> include a measurement reporting entry within the *VarMeasReportList* for this *measId*;
 - 3> set the *numberOfReportsSent* defined within the *VarMeasReportList* for this *measId* to 0;
 - 3> include the concerned cell(s) in the *cellsTriggeredList* defined within the *VarMeasReportList* for this *measId*;

- 3> initiate the measurement reporting procedure, as specified in 5.5.5;
- 2> if the *triggerType* is set to *event* and if the entry condition applicable for this event, i.e. the event corresponding with the *eventId* of the corresponding *reportConfig* within *VarMeasConfig*, is fulfilled for one or more applicable cells not included in the *cellsTriggeredList* for all measurements after layer 3 filtering taken during *timeToTrigger* defined for this event within the *VarMeasConfig* (a subsequent cell triggers the event):
 - 3> set the *numberOfReportsSent* defined within the *VarMeasReportList* for this *measId* to 0;
 - 3> include the concerned cell(s) in the *cellsTriggeredList* defined within the *VarMeasReportList* for this *measId*;
 - 3> initiate the measurement reporting procedure, as specified in 5.5.5;
- 2> if the *triggerType* is set to *event* and if the leaving condition applicable for this event is fulfilled for one or more of the cells included in the *cellsTriggeredList* defined within the *VarMeasReportList* for this *measId* for all measurements after layer 3 filtering taken during *timeToTrigger* defined within the *VarMeasConfig* for this event:
 - 3> remove the concerned cell(s) in the *cellsTriggeredList* defined within the *VarMeasReportList* for this *measId*;
 - 3> if *reportOnLeave* is set to *TRUE* for the corresponding reporting configuration or if *a6-ReportOnLeave* is set to *TRUE* for the corresponding reporting configuration:
 - 4> initiate the measurement reporting procedure, as specified in 5.5.5;
 - 3> if the *cellsTriggeredList* defined within the *VarMeasReportList* for this *measId* is empty:
 - 4> remove the measurement reporting entry within the *VarMeasReportList* for this *measId*;
 - 4> stop the periodical reporting timer for this *measId*, if running;
- 2> if the *purpose* is included and set to *reportStrongestCells* or to *reportStrongestCellsForSON* and if a (first) measurement result is available:
 - 3> include a measurement reporting entry within the *VarMeasReportList* for this *measId*;
 - 3> set the *numberOfReportsSent* defined within the *VarMeasReportList* for this *measId* to 0;
 - 3> initiate the measurement reporting procedure, as specified in 5.5.5;

NOTE 1: If the *purpose* is set to *reportStrongestCells* and *reportAmount* > 1, the UE initiates a first measurement report immediately after the quantity to be reported becomes available for the PCell. If the *purpose* is set to *reportStrongestCells* and *reportAmount* = 1, the UE initiates a first measurement report immediately after the quantity to be reported becomes available for the PCell and for the strongest cell among the applicable cells. If the *purpose* is set to *reportStrongestCellsForSON*, the UE initiates a first measurement report when it has determined the strongest cells on the associated frequency.

- 2> upon expiry of the periodical reporting timer for this *measId*:
 - 3> initiate the measurement reporting procedure, as specified in 5.5.5;

[TS 36.331, clause 5.5.5]

For the *measId* for which the measurement reporting procedure was triggered, the UE shall set the *measuredResults* within the *MeasurementReport* message as follows:

- 1> set the *measId* to the measurement identity that triggered the measurement reporting;
- 1> set the *neighbouringMeasResults* to include the best neighbouring cells up to *maxReportCells* in accordance with the following:
 - 2> if the *triggerType* is set to 'event':

- 3> include the cells included in the *cellsTriggeredList* as defined within the *VarMeasurementReports* for this *measId*;
- 2> else:
 - 3> set the *neighbouringMeasResults* to include the applicable cells for which the requested *reportQuantity* has been available since the last periodical reporting or since the measurement was initiated or reset;
 - 2> for each cell that is included in the *neighbouringMeasResults*, include the *physicalCellIdentity*;
- 1> increment the *numberOfReportsSent* as defined within the *VarMeasurementReports* for this *measId* by 1;
- 1> stop the periodical reporting timer, if running;
- 1> if the *numberOfReportsSent* as defined within the *VarMeasurementReports* for this *measId* is less than the *reportAmount* as defined within the corresponding *reportingConfiguration* as defined in the *VarMeasurementConfiguration*:
 - 2> stop the periodical reporting timer, if running;
 - 2> start the periodical reporting timer with the value of *reportInterval* as defined within the *VarMeasurementConfiguration* for this *measId*;
- 1> else if the *numberOfReportsSent* as defined within the *VarMeasurementReports* for this *measId* is equal to the *reportAmount* as defined within the corresponding *reportingConfiguration* as defined in the *VarMeasurementConfiguration*:
 - 2> if the *triggerType* is set to 'periodical':
 - 3> remove the entry within the *VarMeasurementReports* for this *measId*;
- 1> if the measured results are for CDMA HRPD:
 - 2> set the *hrpdPreRegistrationStatus* to the UE's CDMA upper layer's HRPD *preRegistrationStatus*;
- 1> if the measured results are for CDMA 1xRTT:
 - 2> set the *hrpdPreRegistrationStatus* to '0';
- 1> submit the *MeasurementReport* message to lower layers for transmission, upon which the procedure ends.

8.3.2.8.3 Test description

8.3.2.8.3.1 Pre-test conditions

System Simulator:

- Cell 1 is high quality cell on E-UTRA
- Cell 15 and Cell 16 are high quality cell on HRPD
- System information combination 6 as defined in TS 36.508 [18] clause 4.4.3.1 is used in E-UTRA cells.

UE:

None.

Preamble:

- The UE is brought to state Generic RB Established (state 3) according to [18] on Cell 1

8.3.2.8.3.2 Test procedure sequence

Table 8.3.2.8.3.2-1 illustrates the downlink power levels to be applied for the cells at various time instants of the test execution. Row marked "T0" denotes the initial conditions, while rows marked "T1" and "T2" are to be applied subsequently. The exact instants on which these values shall be applied are described in the texts in this clause.

Table 8.3.2.8.3.2-1: Time instances of cell power level and parameter changes

	Parameter	Unit	Cell 1	Cell 15	Cell 16	Remark
T0	Cell-specific RS EPRE	dBm/15 kHz	-60	-	-	Power levels shall be such that camping on Cell 1 is guaranteed.
	\bar{I}_{or}/I_{oc}	dB	-	-5	-20	
	I_{oc}	dBm/1.23 MHz	-	-55	-55	
	CPICH_Ec/I _o (Note 1)	dB	-	-6	-20	
T1	Cell-specific RS EPRE	dBm/15 kHz	-60	-	-	
	\bar{I}_{or}/I_{oc}	dB	-	-5	-5	
	I_{oc}	dBm/1.23 MHz	-	-55	-55	
	CPICH_Ec/I _o (Note 1)	dB	-	-6	-6	
T2	Cell-specific RS EPRE	dBm/15 kHz	-60	-	-	
	\bar{I}_{or}/I_{oc}	dB	-	-20	-5	
	I_{oc}	dBm/1.23 MHz	-	-55	-55	
	CPICH_Ec/I _o (Note 1)	dB	-	-20	-6	
Note 1: This parameter is not directly settable, but is derived by calculation from the other parameters set by the SS.						

Table 8.3.2.8.3.2-2: Main behaviour

St	Procedure	Message Sequence		TP	Verdict
		U - S	Message		
1	The SS transmits an <i>RRCCONNECTIONRECONFIGURATION</i> message including measConfig to setup measurements and periodical reporting for HRPD cells.	<--	<i>RRCCONNECTIONRECONFIGURATION</i>	-	-
2	The UE transmits an <i>RRCCONNECTIONRECONFIGURATIONCOMPLETE</i> message.	-->	<i>RRCCONNECTIONRECONFIGURATIONCOMPLETE</i>	-	-
2A	Wait and ignore <i>MeasurementReport</i> messages for 5 s to allow for detection and measurement of HRPD cells.	-	-	-	-
-	EXCEPTION: In parallel to events described in steps 3 and 4, the steps specified in table 8.3.2.8.3.2-3 shall take place	-	-	-	-
3	Wait for 30 s to ensure that the UE performs periodical reporting of HRPD cells.	-	-	-	-
4	SS sets the cell-specific reference signal levels for Cell 1, Cell 15 and Cell 16 according to row "T1" in table 8.3.2.8.3.2-1.	-	-	-	-
5	Wait and ignore <i>MeasurementReport</i> messages for 5 s to allow for the switching of cells.	-	-	-	-
-	EXCEPTION: In parallel to events described in steps 6 to 7, the steps specified in table 8.3.2.8.3.2-4 shall take place	-	-	-	-
6	Wait for 30 s to ensure that the UE performs a periodical reporting of HRPD cells.	-	-	-	-
7	SS sets the cell-specific reference signal levels for Cell 1, Cell 15 and Cell 16 according to row "T2" in table 8.3.2.8.3.2-1.	-	-	-	-
8	Wait and ignore <i>MeasurementReport</i> messages for 5 s to allow for the switching of cells.	-	-	-	-
-	EXCEPTION: In parallel to events described in steps 9 to 10, the steps specified in table 8.3.2.8.3.2-5 shall take place	-	-	-	-
9	Wait for 30 s to ensure that the UE performs periodical reporting of HRPD cells.	-	-	-	-
10	SS transmits an <i>RRCCONNECTIONRECONFIGURATION</i> message including measurementConfiguration to remove measId for periodic reporting.	<--	<i>RRCCONNECTIONRECONFIGURATION</i>	-	-
11	The UE transmits an <i>RRCCONNECTIONRECONFIGURATIONCOMPLETE</i> message	-->	<i>RRCCONNECTIONRECONFIGURATIONCOMPLETE</i>	-	-
12	Wait for 30s for the UE so send a <i>MeasurementReport</i> .	-->	<i>MeasurementReport</i>	3	F

Table 8.3.2.8.3.2-3: Parallel behaviour

St	Procedure	Message Sequence		TP	Verdict
		U - S	Message		
-	EXCEPTION: Step 1 below shall be repeated every time the duration indicated in the IE <i>reportInterval</i> has elapsed.	-	-	-	-
1	Check: Does the UE transmit a <i>MeasurementReport</i> message to perform periodical intra frequency reporting for Cell 15?	-->	<i>MeasurementReport</i>	1	P

Table 8.3.2.8.3.2-4: Parallel behaviour

St	Procedure	Message Sequence		TP	Verdict
		U - S	Message		
-	EXCEPTION: Step 1 below shall be repeated every time the duration indicated in the IE <i>reportInterval</i> has elapsed.	-	-	-	-
1	Check: Does the UE transmit a <i>MeasurementReport</i> message to perform periodical intra frequency reporting for Cell 15 and Cell 16?	-->	<i>MeasurementReport</i>	1, 2	P

Table 8.3.2.8.3.2-5: Parallel behaviour

St	Procedure	Message Sequence		TP	Verdict
		U - S	Message		
-	EXCEPTION: Step 1 shall be repeated every time the duration indicated in the IE <i>reportInterval</i> has elapsed.				
1	Check: Does the UE transmit a <i>MeasurementReport</i> message to perform periodical intra frequency reporting for Cell 16?	-->	<i>MeasurementReport</i>	1, 2	P

8.3.2.8.3.3 Specific message contents

Table 8.3.2.8.3.3-1: *RRCConnectionReconfiguration* (step 1, Table 8.3.2.8.3.2-2)

Derivation Path: 36.508, Table 4.6.1-8, condition MEAS			
Information Element	Value/remark	Comment	Condition
<i>RRCConnectionReconfiguration</i> ::= SEQUENCE {			
criticalExtensions CHOICE {			
c1 CHOICE{			
rrcConnectionReconfiguration-r8 SEQUENCE {			
radioResourceConfiguration	Not present		
}			
}			
}			
}			

Table 8.3.2.8.3.3-2: MeasConfig (Table 8.3.2.8.3.3-1)

Derivation Path: 36.508, Table 4.6.6-1			
Information Element	Value/remark	Comment	Condition
measConfig ::= SEQUENCE {			
measObjectToAddModifyList SEQUENCE (SIZE (1..maxObjectId)) OF SEQUENCE {	2 entries		
measObjectId[1]	IdMeasObject-f1		
measObject[1]	MeasObjectEUTRA-GENERIC(f1)		
measObjectId[2]	IdMeasObject-f14		
measObject[2]	MeasObjectCDMA2000-GENERIC		
}			
reportConfigToAddModList SEQUENCE (SIZE (1..maxReportConfigId)) OF SEQUENCE {	1 entry		
reportConfigId[1]	IdReportConfig- f14		
reportConfig[1]	ReportConfigInterRAT-PERIODICAL		
}			
measIdToAddModList SEQUENCE (SIZE (1..maxMeasId)) OF SEQUENCE {	1 entry		
measId[1]	1		
measObjectId[1]	IdMeasObject-f14		
reportConfigId[1]	IdReportConfig- f14		
}			
quantityConfig SEQUENCE {			
quantityConfigCDMA2000 SEQUENCE {			
measQuantityCDMA2000	pilotStrength		
}			
}			
measGapConfig CHOICE {			
setup SEQUENCE {			
gapOffset CHOICE {			
gp1	30		
}			
}			
}			
}			
}			
}			

Table 8.3.2.8.3.3-3: MeasObjectCDMA2000-GENERIC (Table 8.3.2.8.3.3-2)

Derivation Path: 36.508, Table 4.6.6-1C			
Information Element	Value/remark	Comment	Condition
MeasObjectCDMA2000-GENERIC ::= SEQUENCE {			
cdma2000-Type	TypeHRPD		
carrier Freq SEQUENCE {			
bandClass	Band Class of frequency under test		
bandClassfrequency	f14		
}			
searchWindowSize	15		
cellsToAddModifyList SEQUENCE (SIZE (1..maxCellMeas)) OF SEQUENCE {	Not present		
cellIndex [1]	1		
physCellId [1]	PhysicalCellIdentity of Cell 15		
cellIndex [2]	2		
physCellId [2]	PhysicalCellIdentity of Cell 16		
}			
}			
}			

Table 8.3.2.8.3.3-3A: ReportConfigInterRAT-PERIODICAL-CDMA2000 (step 1, Table 8.3.2.8.3.2-2)

Derivation Path: 36.508 table 4.6.6-9 ReportConfigInterRAT-PERIODICAL			
Information Element	Value/remark	Comment	Condition
ReportConfigInterRAT-PERIODICAL ::= SEQUENCE {			
maxReportCells	2	Report Cell 15 and Cell 16	
}			

Table 8.3.2.8.3.3-4: MeasurementReport (step 1 Table 8.3.2.8.3.2-3, Table 8.3.2.8.3.2-4, Table 8.3.2.8.3.2-5)

Derivation Path: 36.508, Table 4.6.1-5			
Information Element	Value/remark	Comment	Condition
MeasurementReport ::= SEQUENCE {			
criticalExtensions CHOICE {			
c1 CHOICE {			
measurementReport-r8 SEQUENCE {			
measResults SEQUENCE {			
measId	1		
measResultServCell SEQUENCE {			
rsrpResult	(0..97)		
rsrqResult	(0..34)		
}			
measResultNeighCells CHOICE {			
measResultsCDMA2000 ::=SEQUENCE {			
preRegistrationStatusHRPD	FALSE		
measResultListCDMA2000 ::=SEQUENCE (SIZE (1..maxCellReport)) OF SEQUENCE {	1 or 2 entries		Table 8.3.2.8.3.2-3
{			1 entry
physCellId[1]	PhysicalCellIdentity of Cell 15		
cgi-Info[1]	Not present		
measResult[1] SEQUENCE {			
pilotStrength	(0..63)		
}			
}			2 entries
physCellId[1]	PhysicalCellIdentity of Cell 15		
cgi-Info[1]	Not present		
measResult[1] SEQUENCE {			
pilotStrength	(0..62)		
}			
physCellId[2]	PhysicalCellIdentity of Cell 16		
cgi-Info[2]	Not present		
measResult[2] SEQUENCE {			
pilotStrength	(35..63)		
}			
}			
measResultListCDMA2000 ::=SEQUENCE (SIZE (1..maxCellReport)) OF SEQUENCE {	2 entries	Cells can be reported in any order.	Table 8.3.2.8.3.2-4
physCellId[1]	PhysicalCellIdentity of Cell 15		
cgi-Info[1]	Not present		
measResult[1] SEQUENCE {			
pilotStrength	(0..63)		
}			
physCellId[2]	PhysicalCellIdentity of Cell 16		
cgi-Info[2]	Not present		
measResult[1] SEQUENCE {			
pilotStrength	(0..63)		
}			

}			
}			
measResultListCDMA2000 ::=SEQUENCE (SIZE (1..maxCellReport)) OF SEQUENCE	1 or 2 entries		Table 8.3.2.8.3.2-5
{			1 entry
physCellId[1]	PhysicalCellIdentity of Cell 16		
cgi-Info[1]	Not present		
measResult[1] SEQUENCE {			
pilotStrength	(0..63)		
}			
}			
{			2 entries
physCellId[1]	PhysicalCellIdentity of Cell 16		
cgi-Info[1]	Not present		
measResult[1] SEQUENCE {			
pilotStrength	(0..62)		
}			
physCellId[2]	PhysicalCellIdentity of Cell 15		
cgi-Info[2]	Not present		
measResult[2] SEQUENCE {			
pilotStrength	(35..63)		
}			
}			
}			
}			
}			
}			
}			
}			
}			
}			
}			
}			
}			
}			

Table 8.3.2.8.3.3-5: RRCConnectionReconfiguration (step 10, Table 8.3.2.8.3.2-2)

Derivation Path: 36.508 clause 4.6.1 table 4.6.1-8 with condition MEAS

Table 8.3.2.8.3.3-6: MeasConfig (Table 8.3.2.8.3.3-5)

Derivation Path: 36.508, Table 4.6.6-1			
Information Element	Value/remark	Comment	Condition
MeasConfig ::= SEQUENCE {			
measIdToRemoveList SEQUENCE (SIZE (1..maxMeasId)) OF SEQUENCE {	1 entry		
measId[1]	1		
}			
}			

8.3.2.9 Measurement configuration control and reporting / Inter-RAT measurements / Event B2 / Measurement of 1xRTT cells)

8.3.2.9.1 Test Purpose (TP)

(1)

```

with { UE having completed the radio bearer establishment, initial security activation procedure and performed the inter RAT measurement for 1xRTT cell and not detected entering condition for the event B2 is met }
ensure that {
  when { UE detects entering condition for the event B2 is not met }
  then { UE does not transmit any MeasurementReport }
}
    
```

(2)

```

with { UE having completed the radio bearer establishment, initial security activation procedure and
performed the inter RAT measurement for 1xRTT cell and not detected entering condition for the event
B2 is met }
ensure that {
  when { UE detects entering condition for the event B2 is met }
  then { UE transmits a MeasurementReport }
}

```

(3)

```

with { UE having completed the radio bearer establishment, initial security activation procedure and
performed the inter RAT measurement for 1xRTT cell and detected entering condition for the event B2
is met }
ensure that {
  when { UE detects leaving condition for the event B2 is met }
  then { UE does not transmit any MeasurementReport }
}

```

8.3.2.9.2 Conformance requirements

References: The conformance requirements covered in the present TC are specified in: TS 36.331, clause 5.5.4.1, 5.5.4.8 and 5.5.5.

[TS 36.331, clause 5.5.4.1]

The UE shall:

- 1> for each *measId* included in the *measIdList* within *VarMeasConfig*
- ...
- 2>else :
- ...
- 3> if the corresponding *measObject* concerns UTRA or CDMA2000:
 - 4> consider a neighbouring cell on the associated frequency to be applicable when the concerned cell is included in the *cellsToAddModList* defined within the *VarMeasConfig* for this *measId* (i.e. the cell is included in the white-list);
 - ...
 - 2> if the *triggerType* is set to 'event' and if the entry condition applicable for this event, i.e. the event corresponding with the *eventId* of the corresponding *reportConfig* within *VarMeasConfig*, is fulfilled for one or more applicable cells for all measurements after layer 3 filtering taken during *timeToTrigger* defined for this event within the *VarMeasConfig*, while the *VarMeasReportList* does not include an measurement reporting entry for this *measId* (a first cell triggers the event):
 - 3> include a measurement reporting entry within the *VarMeasReportList* for this *measId*;
 - 3> set the *numberOfReportsSent* defined within the *VarMeasReportList* for this *measId* to 0;
 - 3> include the concerned cell(s) in the *cellsTriggeredList* defined within the *VarMeasReportList* for this *measId*;
 - 3> initiate the measurement reporting procedure, as specified in 5.5.5;
 - 2> if the *triggerType* is set to 'event' and if the entry condition applicable for this event, i.e. the event corresponding with the *eventId* of the corresponding *reportConfig* within *VarMeasConfig*, is fulfilled for one or more applicable cells not included in the *cellsTriggeredList* for all measurements after layer 3 filtering taken during *timeToTrigger* defined for this event within the *VarMeasConfig* (a subsequent cell triggers the event):
 - 3> set the *numberOfReportsSent* defined within the *VarMeasReportList* for this *measId* to 0;

- 3> include the concerned cell(s) in the *cellsTriggeredList* defined within the *VarMeasReportList* for this *measId*;
- 3> initiate the measurement reporting procedure, as specified in 5.5.5;
- 2> if the *triggerType* is set to 'event' and if the leaving condition applicable for this event is fulfilled for one or more of the cells included in the *cellsTriggeredList* defined within the *VarMeasReportList* for this *measId* for all measurements after layer 3 filtering taken during *timeToTrigger* defined within the *VarMeasConfig* for this event:
 - 3> remove the concerned cell(s) in the *cellsTriggeredList* defined within the *VarMeasReportList* for this *measId*;
 - 3> if *reportOnLeave* is set to *TRUE* for the corresponding reporting configuration:
 - 4> initiate the measurement reporting procedure, as specified in 5.5.5;
 - 3> if the *cellsTriggeredList* defined within the *VarMeasReportList* for this *measId* is empty:
 - 4> remove the measurement reporting entry within the *VarMeasReportList* for this *measId*;
 - 4> stop the periodical reporting timer for this *measId*, if running;
- 2> if the *purpose* is included and set to 'reportStrongestCells' or to 'reportStrongestCellsForSON' and if a (first) measurement result is available for one or more applicable cells:
 - 3> include a measurement reporting entry within the *VarMeasReportList* for this *measId*;
 - 3> set the *numberOfReportsSent* defined within the *VarMeasReportList* for this *measId* to 0;
 - 3> initiate the measurement reporting procedure, as specified in 5.5.5;

NOTE 1: If the *purpose* is set to 'reportStrongestCells', the UE initiates a first measurement report immediately after the quantity to be reported becomes available for at least either serving cell or one of the applicable cells. If the *purpose* is set to 'reportStrongestCellsForSON', the UE initiates a first measurement report when it has determined the strongest cells on the associated frequency.

[TS 36.331, clause 5.5.4.8]

The UE shall:

- 1> for UTRA and CDMA2000, only trigger the event for cells included in the corresponding measurement object;
- 1> consider the entering condition for this event to be satisfied when both condition B2-1 and condition B2-2, as specified below, are fulfilled;
- 1> consider the leaving condition for this event to be satisfied when condition B2-3 or condition B2-4, i.e. at least one of the two, as specified below, is fulfilled;

Inequality B2-1 (Entering condition 1)

$$M_s + H_{ys} < Thresh1$$

Inequality B2-2 (Entering condition 2)

$$M_n + O_{fn} - H_{ys} > Thresh2$$

Inequality B2-3 (Leaving condition 1)

$$M_s - H_{ys} > Thresh1$$

Inequality B2-4 (Leaving condition 2)

$$M_n + O_{fn} + H_{ys} < Thresh2$$

The variables in the formula are defined as follows:

Ms is the measurement result of the serving cell, not taking into account any offsets.

Mn is the measurement result of the inter-RAT neighbour cell, not taking into account any offsets.

Ofn is the frequency specific offset of the frequency of the inter-RAT neighbour cell (i.e. *offsetFreq* as defined within the *measObject* corresponding to the frequency of the inter-RAT neighbour cell).

Hys is the hysteresis parameter for this event (i.e. *hysteresis* as defined within *reportConfigInterRAT* for this event).

Thresh1 is the threshold parameter for this event (i.e. *b2-Threshold1* as defined within *reportConfigInterRAT* for this event).

Thresh2 is the threshold parameter for this event (i.e. *b2-Threshold2* as defined within *reportConfigInterRAT* for this event).

Ms is expressed in dBm in case of RSRP, or in dB in case of RSRQ.

Mn is expressed in dBm or dB, depending on the measurement quantity of the inter-RAT neighbour cell.

Ofn, *Hys* are expressed in dB.

Thresh1 is expressed in the same unit as *Mn*.

Thresh2 is expressed in the same unit as *Mn*.

[TS 36.331, clause 5.5.5]

For the *measId* for which the measurement reporting procedure was triggered, the UE shall set the *measuredResults* within the *MeasurementReport* message as follows:

1> set the *measId* to the measurement identity that triggered the measurement reporting;

1> set the *measResultServCell* to include the quantities of serving cell;

1> if there is at least one applicable neighbouring cell to report:

2> set the *measResultsNeighCells* to include the best neighbouring cells up to *maxReportCells* in accordance with the following:

3> if the *triggerType* is set to 'event':

4> include the cells included in the *cellsTriggeredList* as defined within the *VarMeasReportList* for this *measId*;

3> else:

4> include the applicable cells for which the new measurement results became available since the last periodical reporting or since the measurement was initiated or reset;

NOTE: The reliability of the report (i.e. the certainty it contains the strongest cells on the concerned frequency) depends on the measurement configuration i.e. the *reportInterval*. The related performance requirements are specified in TS 36.133 [16].

3> for each cell that is included in the *measResultsNeighCells*, include the *physCellId*;

3> if the *triggerType* is set to 'event'; or the *purpose* is set to 'reportStrongestCells' or to 'reportStrongestCellsForSON':

4> for each included cell, include the layer 3 filtered measured results in accordance with the *reportConfig* for this *measId*, ordered as follows:

5> if the *measObject* associated with this *measId* concerns E-UTRA:

6> set the *measResult* to include the quantity(ies) indicated in the *reportQuantity* within the concerned *reportConfig* in order of decreasing *triggerQuantity*, i.e. the best cell is included first;

5> else:

- 6> set the *measResult* to the quantity as configured for the concerned RAT within the *quantityConfig* in order of decreasing quantity, i.e. the best cell is included first;
- 3> else if the *purpose* is set to 'reportCGI':
 - 4> if the mandatory present fields of the *globalCellIdentity* for the cell indicated by the *cellForWhichToReportCGI* in the associated *measObject* have been obtained:
 - 5> include the *cgi-Info* containing all the fields that have been successfully acquired;
- 1> increment the *numberOfReportsSent* as defined within the *VarMeasReportList* for this *measId* by 1;
- 1> stop the periodical reporting timer, if running;
- 1> if the *numberOfReportsSent* as defined within the *VarMeasReportList* for this *measId* is less than the *reportAmount* as defined within the corresponding *reportConfig* for this *measId*:
 - 2> start the periodical reporting timer with the value of *reportInterval* as defined within the corresponding *reportConfig* for this *measId*;
- 1> else:
 - 2> if the *triggerType* is set to 'periodical':
 - 3> remove the entry within the *VarMeasReportList* for this *measId*;
 - 3> remove this *measId* from the *measIdList* within *VarMeasConfig*;
- 1> if the measured results are for CDMA2000 HRPD:
 - 2> set the *preRegistrationStatusHRPD* to the UE's CDMA2000 upper layer's HRPD *preRegistrationStatus*;
- 1> if the measured results are for CDMA2000 1xRTT:
 - 2> set the *preRegistrationStatusHRPD* to 'FALSE';
- 1> submit the *MeasurementReport* message to lower layers for transmission, upon which the procedure ends;

8.3.2.9.3 Test description

8.3.2.9.3.1 Pre-test conditions

System Simulator:

- Cell 1, Cell 19 and Cell 20.
- System information combination 6 as defined in TS 36.508 [18] clause 4.4.3.1 is used in E-UTRA cells.

UE:

None.

Preamble:

- The UE is in state Generic RB Established (state 3) on Cell 1 according to [18].

8.3.2.9.3.2 Test procedure sequence

Table 8.3.2.9.3.2-1 illustrates the downlink power levels and other changing parameters to be applied for the cells at various time instants of the test execution. Row marked "T0" denotes the initial conditions, while rows marked "T1", "T2", "T3" and "T4" are to be applied subsequently. The exact instants on which these values shall be applied are described in the texts in this clause.

Table 8.3.2.9.3.2-1: Time instances of cell power level and parameter changes

	Parameter	Unit	Cell 1	Cell 19	Cell 20	Remark
T0	Cell-specific RS EPRE	dBm/15 kHz	-60	-	-	The power level values are such that entering conditions for event B2 are not satisfied.
	\bar{I}_{or}/I_{oc}	dB	-	-15	-15	
	Pilot E_c/I_{or}	dB	-	-7	-7	
	I_{oc}	dBm/1.23 MHz	-	-75	-75	
	Pilot E_c/I_o (Note 1)	dB	-	-22	-22	
T1	Cell-specific RS EPRE	dBm/15 kHz	-80	-	-	The power level values are such that entering conditions for event B2 are satisfied.
	\bar{I}_{or}/I_{oc}	dB	-	0	-15	
	Pilot E_c/I_{or}	dB	-	-7	-7	
	I_{oc}	dBm/1.23 MHz	-	-75	-75	
	Pilot E_c/I_o (Note 1)	dB	-	-10	-22	
T2	Cell-specific RS EPRE	dBm/15 kHz	-60	-	-	The power level values are such that leaving conditions for event B2 are satisfied.
	\bar{I}_{or}/I_{oc}	dB	-	-15	-15	
	Pilot E_c/I_{or}	dB	-	-7	-7	
	I_{oc}	dBm/1.23 MHz	-	-75	-75	
	Pilot E_c/I_o (Note 1)	dB	-	-22	-22	
T3	Cell-specific RS EPRE	dBm/15 kHz	-80	-	-	The power level values are such that entering conditions for event B2 are satisfied.
	\bar{I}_{or}/I_{oc}	dB	-	0	-15	
	Pilot E_c/I_{or}	dB	-	-7	-7	
	I_{oc}	dBm/1.23 MHz	-	-75	-75	
	Pilot E_c/I_o (Note 1)	dB	-	-10	-22	
T4	Cell-specific RS EPRE	dBm/15 kHz	-60	-	-	The power level values are such that leaving conditions for event B2 are satisfied.
	\bar{I}_{or}/I_{oc}	dB	-	-15	-15	
	Pilot E_c/I_{or}	dB	-	-7	-7	
	I_{oc}	dBm/1.23 MHz	-	-75	-75	
	Pilot E_c/I_o (Note 1)	dB	-	-22	-22	
Note 1: This parameter is not directly settable, but is derived by calculation from the other parameters set by the SS.						

Table 8.3.2.9.3.2-2: Main behaviour

St	Procedure	Message Sequence		TP	Verdict
		U - S	Message		
1	The SS transmits an <i>RRCCONNECTIONRECONFIGURATION</i> message to setup inter RAT measurement on Cell 1.	<--	<i>RRCCONNECTIONRECONFIGURATION</i>	-	-
2	The UE transmits an <i>RRCCONNECTIONRECONFIGURATIONCOMPLETE</i> message to confirm the setup of inter RAT measurement on Cell 1.	-->	<i>RRCCONNECTIONRECONFIGURATIONCOMPLETE</i>	-	-
3	Check: Does the UE transmit a <i>MEASUREMENTREPORT</i> message to report the event B2 during the next 10s?	-->	<i>MEASUREMENTREPORT</i>	1	F
4	The SS changes Cell 1, Cell 19 and Cell 20 parameters according to row "T1" in table 8.3.2.9.3.2-1.	-	-	-	-
5	Check: Does the UE transmit a <i>MEASUREMENTREPORT</i> message to report the event B2 for Cell 19, not including Cell 20?	-->	<i>MEASUREMENTREPORT</i>	2	P
6	Void	-	-	-	-
7	The SS changes Cell 1, Cell 19 and Cell 20 parameters according to row "T2" in table 8.3.2.9.3.2-1.	-	-	-	-
8	Check: Does the UE transmit a <i>MEASUREMENTREPORT</i> message to report the event B2 during the next 10s?	-->	<i>MEASUREMENTREPORT</i>	3	F
9	The SS changes Cell 1, Cell 19 and Cell 20 parameters according to row "T3" in table 8.3.2.9.3.2-1.	-	-	-	-
10	Check: Does the UE transmit a <i>MEASUREMENTREPORT</i> message to report the event B2 for Cell 19, not including Cell 20?	-->	<i>MEASUREMENTREPORT</i>	2	P
11	Void	-	-	-	-
12	The SS changes Cell 1, Cell 19 and Cell 20 parameters according to row "T4" in table 8.3.2.9.3.2-1.	-	-	-	-
13	Check: Does the UE transmit a <i>MEASUREMENTREPORT</i> message to report the event B2 during the next 10s?	-->	<i>MEASUREMENTREPORT</i>	3	F
14	Check: Does the test result of generic test procedure in TS 36.508 subclause 6.4.2.3 indicate that the UE is in E-UTRA RRC_CONNECTED state on Cell 1?	-	-	-	-

8.3.2.9.3.3 Specific message contents

Table 8.3.2.9.3.3-1: *RRCCONNECTIONRECONFIGURATION* (step 1, Table 8.3.2.9.3.2-2)

Derivation Path: 36.508, Table 4.6.1-8, condition MEAS
--

Table 8.3.2.9.3.3-2: MeasConfig (Table 8.3.2.9.3.3-1)

Derivation Path: 36.508, Table 4.6.6-1			
Information Element	Value/remark	Comment	Condition
MeasConfig ::= SEQUENCE {			
measObjectToAddModList SEQUENCE (SIZE (1..maxObjectId)) OF SEQUENCE {	2 entries		
measObjectId[1]	IdMeasObject-f1		
measObject[1]	MeasObjectEUTRA-GENERIC(f1)		
measObjectId[2]	IdMeasObject-f17		
measObject[2]	MeasObjectCDMA2000-GENERIC		
}			
reportConfigToAddModList SEQUENCE (SIZE (1..maxReportConfigId)) OF SEQUENCE {	1 entry		
reportConfigId[1]	IdReportConfig-B2-CDMA2000		
reportConfig[1]	ReportConfigInterRAT-B2-CDMA2000(-69, -18)		
}			
measIdToAddModList SEQUENCE (SIZE (1..maxMeasId)) OF SEQUENCE {	1 entry		
measId[1]	1		
measObjectId[1]	IdMeasObject-f17		
reportConfigId[1]	IdReportConfig-B2-CDMA2000		
}			
quantityConfig SEQUENCE {			
quantityConfigCDMA2000 SEQUENCE {			
measQuantityCDMA2000	pilotStrength		
}			
}			
measGapConfig CHOICE {			
setup SEQUENCE {			
gapOffset CHOICE {			
gp1	30		
}			
}			
}			
}			
}			

Table 8.3.2.9.3.3-3: MeasObjectCDMA2000-GENERIC (Table 8.3.2.9.3.3-2)

Derivation Path: 36.508, Table 4.6.6-1C			
Information Element	Value/remark	Comment	Condition
MeasObjectCDMA2000-GENERIC ::= SEQUENCE {			
cdma2000-Type	Type1XR TT		
CarrierFreqCDMA2000 SEQUENCE {			
bandClass	Band Class of frequency under test		
arfcn	f17		
}			
searchWindowSize	15		
offsetFreq	db0		
cellsToRemoveList	Not present		
cellsToAddModList CHOICE {}	[Not present]		
cellForWhichToReportCGI	Not present		
}			

Table 8.3.2.9.3.3-3: *MeasurementReport* (steps 5 and 10, Table 8.3.2.9.3.2-2)

Derivation Path: 36.508, Table 4.6.1-5			
Information Element	Value/remark	Comment	Condition
MeasurementReport ::= SEQUENCE {			
criticalExtensions CHOICE {			
c1 CHOICE{			
measurementReport-r8 SEQUENCE {			
measResults SEQUENCE {			
measId	1		
measResultServCell SEQUENCE {			
rsrpResult	(0..97)		
rsrqResult	(0..34)		
}			
measResults NeighCells CHOICE {			
measResultsCDMA2000 ::=SEQUENCE {			
preRegistrationStatusHRPD	FALSE		
measResultListCDMA2000 ::=SEQUENCE	1 entry		
(SIZE (1..maxCellReport)) OF SEQUENCE {			
physCellId[1]	PhysicalCellIdentity of Cell 19		
cgi-Info[1]	Not present		
measResult[1] SEQUENCE {			
pilotStrength	(0..63)		
}			
}			
}			
}			
}			
}			
}			
}			

8.3.2.10 Measurement configuration control and reporting / Inter-RAT measurements / Periodic reporting / Measurement of 1xRTT cells

8.3.2.10.1 Test Purpose (TP)

(1)

```
with { UE in E-UTRA RRC_CONNECTED state and measurement configured for periodic reporting of 1xRTT cells }
ensure that {
  when { The UE receives reference signal power for cells on the 1xRTT frequency where measurements are configured }
  then { UE sends MeasurementReport message at regular intervals for these 1xRTT cells }
}
```

(2)

```
with { UE in E-UTRA RRC_CONNECTED state and a Measurement Report message for a configured periodic measurement reporting of 1xRTT cells on a configured frequency was sent }
ensure that {
  when { A previously reported cell become unavailable or the UE receives reference signal power on a reported 1xRTT frequency for a cell which was previously not reported }
  then { UE sends MeasurementReport message at regular intervals for the available 1xRTT cells }
}
```

(3)

```
with { UE in E-UTRA RRC_CONNECTED state and periodic measurement reporting of 1xRTT cells ongoing }
ensure that {
  when { The UE receives an RRCConnectionReconfiguration message removing the measID of periodic reporting of 1xRTT cells }
  then { UE stops sending MeasurementReport message for 1xRTT cells }
}
```

8.3.2.10.2 Conformance requirements

References: The conformance requirements covered in the current TC are specified in: TS 36.331, clauses 5.3.5.3, 5.5.2.2, 5.5.4.1 and 5.5.5.

[TS 36.331, clause 5.3.5.3]

If the *RRConnectionReconfiguration* message does not include the *mobilityControlInfo* and the UE is able to comply with the configuration included in this message, the UE shall:

...

1> If the *RRConnectionReconfiguration* message includes the *measConfig*:

2> perform the Measurement configuration procedure as specified in 5.5.2;

[TS 36.331, clause 5.5.2.2]

The UE shall:

1> for each *measId* included in the received *measIdToRemoveList* that is part of the current UE configuration in *varMeasConfig*:

2> remove the entry with the matching *measId* from the *measIdList* within the *VarMeasConfig*;

2> remove the measurement reporting entry for this *measId* from the *VarMeasReportList*, if included;

2> stop the periodical reporting timer or timer T321, whichever one is running, and reset the associated information (e.g. *timeToTrigger*) for this *measId*;

NOTE: The UE does not consider the message as erroneous if the *measIdToRemoveList* includes any *measId* value that is not part of the current UE configuration.

[TS 36.331, clause 5.5.4.1]

[Rel-8]

The UE shall:

1> for each *measId* included in the *measIdList* within *VarMeasConfig*:

2> if the corresponding *reportConfig* includes a purpose set to 'reportStrongestCellsForSON':

...

2> else if the corresponding *reportConfig* includes a purpose set to 'reportCGI':

...

2> else:

3> if the corresponding *measObject* concerns E-UTRA:

...

3> else if the corresponding *measObject* concerns UTRA or CDMA2000:

4> consider a neighbouring cell on the associated frequency to be applicable when the concerned cell is included in the *cellsToAddModList* defined within the *VarMeasConfig* for this *measId* (i.e. the cell is included in the white-list);

...

2> if the *purpose* is included and set to 'reportStrongestCells' or to 'reportStrongestCellsForSON' and if a (first) measurement result is available for one or more applicable cells:

3> include a measurement reporting entry within the *VarMeasReportList* for this *measId*;

- 3> set the *numberOfReportsSent* defined within the *VarMeasReportList* for this *measId* to 0;
- 3> initiate the measurement reporting procedure, as specified in 5.5.5;

NOTE 1: If the *purpose* is set to '*reportStrongestCells*', the UE initiates a first measurement report immediately after the quantity to be reported becomes available for at least either serving cell or one of the applicable cells. If the purpose is set to '*reportStrongestCellsForSON*', the UE initiates a first measurement report when it has determined the strongest cells on the associated frequency.

- 2> upon expiry of the periodical reporting timer for this *measId*:
 - 3> initiate the measurement reporting procedure, as specified in 5.5.5;
- ...
- 2> upon expiry of the T321 for this *measId*:
 - 3> include a measurement reporting entry within the *VarMeasReportList* for this *measId*;
 - 3> set the *numberOfReportsSent* defined within the *VarMeasReportList* for this *measId* to 0;
 - 3> initiate the measurement reporting procedure, as specified in 5.5.5;

NOTE 2: The UE does not stop the periodical reporting with *triggerType* set to '*event*' or to '*periodical*' while the corresponding measurement is not performed due to the serving cell RSRP being equal to or better than *s-Measure* or due to the measurement gap not being setup.

NOTE 3: If the UE is configured with DRX, the UE may delay the measurement reporting for event triggered and periodical triggered measurements until the Active Time, which is defined in TS 36.321 [6].

[Rel-11]

The UE shall:

- 1> for each *measId* included in the *measIdList* within *VarMeasConfig*:
 - 2> if the corresponding *reportConfig* includes a purpose set to *reportStrongestCellsForSON*:
 - 3> consider any neighbouring cell detected on the associated frequency to be applicable;
 - 2> else if the corresponding *reportConfig* includes a purpose set to *reportCGI*:
 - 3> consider any neighbouring cell detected on the associated frequency/ set of frequencies (GERAN) which has a physical cell identity matching the value of the *cellForWhichToReportCGI* included in the corresponding *measObject* within the *VarMeasConfig* to be applicable;
 - 2> else:
 - 3> if the corresponding *measObject* concerns E-UTRA:
 - 4> if the *ue-RxTxTimeDiffPeriodical* is configured in the corresponding *reportConfig*:
 - 5> consider only the PCell to be applicable;
 - 4> else if the *eventA1* or *eventA2* is configured in the corresponding *reportConfig*:
 - 5> consider only the serving cell to be applicable;
 - 4> else:

- 5> consider any neighbouring cell detected on the associated frequency to be applicable when the concerned cell is not included in the *blackCellsToAddModList* defined within the *VarMeasConfig* for this *measId*;
- 5> for events involving a serving cell on one frequency and neighbours on another frequency, consider the serving cell on the other frequency as a neighbouring cell;
- 3> else if the corresponding *measObject* concerns UTRA or CDMA2000:
 - 4> consider a neighbouring cell on the associated frequency to be applicable when the concerned cell is included in the *cellsToAddModList* defined within the *VarMeasConfig* for this *measId* (i.e. the cell is included in the white-list);

NOTE 0: The UE may also consider a neighbouring cell on the associated UTRA frequency to be applicable when the concerned cell is included in the *csg-allowedReportingCells* within the *VarMeasConfig* for this *measId*, if configured in the corresponding *measObjectUTRA* (i.e. the cell is included in the range of physical cell identities for which reporting is allowed).

- 3> else if the corresponding *measObject* concerns GERAN:
 - 4> consider a neighbouring cell on the associated set of frequencies to be applicable when the concerned cell matches the *ncc-Permitted* defined within the *VarMeasConfig* for this *measId*;
- 2> if the *triggerType* is set to *event* and if the entry condition applicable for this event, i.e. the event corresponding with the *eventId* of the corresponding *reportConfig* within *VarMeasConfig*, is fulfilled for one or more applicable cells for all measurements after layer 3 filtering taken during *timeToTrigger* defined for this event within the *VarMeasConfig*, while the *VarMeasReportList* does not include an measurement reporting entry for this *measId* (a first cell triggers the event):
 - 3> include a measurement reporting entry within the *VarMeasReportList* for this *measId*;
 - 3> set the *numberOfReportsSent* defined within the *VarMeasReportList* for this *measId* to 0;
 - 3> include the concerned cell(s) in the *cellsTriggeredList* defined within the *VarMeasReportList* for this *measId*;
 - 3> initiate the measurement reporting procedure, as specified in 5.5.5;
- 2> if the *triggerType* is set to *event* and if the entry condition applicable for this event, i.e. the event corresponding with the *eventId* of the corresponding *reportConfig* within *VarMeasConfig*, is fulfilled for one or more applicable cells not included in the *cellsTriggeredList* for all measurements after layer 3 filtering taken during *timeToTrigger* defined for this event within the *VarMeasConfig* (a subsequent cell triggers the event):
 - 3> set the *numberOfReportsSent* defined within the *VarMeasReportList* for this *measId* to 0;
 - 3> include the concerned cell(s) in the *cellsTriggeredList* defined within the *VarMeasReportList* for this *measId*;
 - 3> initiate the measurement reporting procedure, as specified in 5.5.5;
- 2> if the *triggerType* is set to *event* and if the leaving condition applicable for this event is fulfilled for one or more of the cells included in the *cellsTriggeredList* defined within the *VarMeasReportList* for this *measId* for all measurements after layer 3 filtering taken during *timeToTrigger* defined within the *VarMeasConfig* for this event:
 - 3> remove the concerned cell(s) in the *cellsTriggeredList* defined within the *VarMeasReportList* for this *measId*;
 - 3> if *reportOnLeave* is set to *TRUE* for the corresponding reporting configuration or if *a6-ReportOnLeave* is set to *TRUE* for the corresponding reporting configuration:
 - 4> initiate the measurement reporting procedure, as specified in 5.5.5;
 - 3> if the *cellsTriggeredList* defined within the *VarMeasReportList* for this *measId* is empty:

- 4> remove the measurement reporting entry within the *VarMeasReportList* for this *measId*;
- 4> stop the periodical reporting timer for this *measId*, if running;
- 2> if the *purpose* is included and set to *reportStrongestCells* or to *reportStrongestCellsForSON* and if a (first) measurement result is available:
 - 3> include a measurement reporting entry within the *VarMeasReportList* for this *measId*;
 - 3> set the *numberOfReportsSent* defined within the *VarMeasReportList* for this *measId* to 0;
 - 3> initiate the measurement reporting procedure, as specified in 5.5.5;

NOTE 1: If the *purpose* is set to *reportStrongestCells* and *reportAmount* > 1, the UE initiates a first measurement report immediately after the quantity to be reported becomes available for the PCell. If the *purpose* is set to *reportStrongestCells* and *reportAmount* = 1, the UE initiates a first measurement report immediately after the quantity to be reported becomes available for the PCell and for the strongest cell among the applicable cells. If the *purpose* is set to *reportStrongestCellsForSON*, the UE initiates a first measurement report when it has determined the strongest cells on the associated frequency.

- 2> upon expiry of the periodical reporting timer for this *measId*;
- 3> initiate the measurement reporting procedure, as specified in 5.5.5;

[TS 36.331, clause 5.5.5]

For the *measId* for which the measurement reporting procedure was triggered, the UE shall set the *measResults* within the *MeasurementReport* message as follows:

- 1> set the *measId* to the measurement identity that triggered the measurement reporting;
- 1> set the *measResultServCell* to include the quantities of serving cell;
- 1> if there is at least one applicable neighbouring cell to report:
 - 2> set the *measResultsNeighCells* to include the best neighbouring cells up to *maxReportCells* in accordance with the following:
 - 3> if the *triggerType* is set to 'event':
 - ...
 - 3> else:
 - 4> include the applicable cells for which the new measurement results became available since the last periodical reporting or since the measurement was initiated or reset;

NOTE: The reliability of the report (i.e. the certainty it contains the strongest cells on the concerned frequency) depends on the measurement configuration i.e. the *reportInterval*. The related performance requirements are specified in TS 36.133 [16].

- 3> for each cell that is included in the *measResultsNeighCells*, include the *physCellId*;
- 3> if the *triggerType* is set to 'event'; or the *purpose* is set to 'reportStrongestCells' or to 'reportStrongestCellsForSON':
 - 4> for each included cell, include the layer 3 filtered measured results in accordance with the *reportConfig* for this *measId*, ordered as follows:
 - 5> if the *measObject* associated with this *measId* concerns E-UTRA:
 - ...
 - 5> else:
 - 6> set the *measResult* to the quantity as configured for the concerned RAT within the *quantityConfig* in order of decreasing quantity, i.e. the best cell is included first;

3> else if the *purpose* is set to 'reportCGF':

...

1> increment the *numberOfReportsSent* as defined within the *VarMeasReportList* for this *measId* by 1;

1> stop the periodical reporting timer, if running;

1> if the *numberOfReportsSent* as defined within the *VarMeasReportList* for this *measId* is less than the *reportAmount* as defined within the corresponding *reportConfig* for this *measId*:

2> start the periodical reporting timer with the value of *reportInterval* as defined within the corresponding *reportConfig* for this *measId*;

1> else:

2> if the *triggerType* is set to 'periodical':

3> remove the entry within the *VarMeasReportList* for this *measId*;

3> remove this *measId* from the *measIdList* within *VarMeasConfig*;

1> if the measured results are for CDMA2000 HRPD:

...

1> if the measured results are for CDMA2000 1xRTT:

2> set the *preRegistrationStatusHRPD* to 'FALSE';

1> submit the *MeasurementReport* message to lower layers for transmission, upon which the procedure ends;

8.3.2.10.3 Test description

8.3.2.10.3.1 Pre-test conditions

System Simulator:

- Cell 1, Cell 19 and Cell 20.
- System information combination 6 as defined in TS 36.508 [18] clause 4.4.3.1 is used in E-UTRA cells.

UE:

None.

Preamble:

- The UE is in state Generic RB Established (state 3) according to [18] on Cell 1.

8.3.2.10.3.2 Test procedure sequence

Table 8.3.2.10.3.2-1 illustrates the downlink power levels to be applied for the cells at various time instants of the test execution. Row marked "T0" denotes the initial conditions, while rows marked "T1" and "T2" are to be applied subsequently. The exact instants on which these values shall be applied are described in the texts in this clause.

Table 8.3.2.10.3.2-1: Time instances of cell power level and parameter changes

	Parameter	Unit	Cell 1	Cell 19	Cell 20	Remark
T0	Cell-specific RS EPRE	dBm/15k Hz	-60	-	-	Power levels shall be such that camping on Cell 1 is guaranteed.
	\bar{I}_{or}/I_{oc}	dB	-	0	-15	
	Pilot Ec/ Ior	dB	-	-7	-7	
	Ioc	dBm/1.2 3 MHz	-	-75	-75	
	Pilot Ec/Io (Note 1)	dB	-	-10	-22	
T1	Cell-specific RS EPRE	dBm/15k Hz	-60	-	-	
	\bar{I}_{or}/I_{oc}	dB	-	0	0	
	Pilot Ec/ Ior	dB	-	-7	-7	
	Ioc	dBm/1.2 3 MHz	-	-75	-75	
	Pilot Ec/Io (Note 1)	dB	-	-10	-10	
T2	Cell-specific RS EPRE	dBm/15k Hz	-60	-	-	
	\bar{I}_{or}/I_{oc}	dB	-	-15	-0	
	Pilot Ec/ Ior	dB	-	-7	-7	
	Ioc	dBm/1.2 3 MHz	-	-75	-75	
	Pilot Ec/Io (Note 1)	dB	-	-22	-10	
Note 1: This parameter is not directly settable, but is derived by calculation from the other parameters set by the SS.						

Table 8.3.2.10.3.2-2: Main behaviour

St	Procedure	Message Sequence		TP	Verdict
		U - S	Message		
1	SS transmits an <i>RRCCONNECTIONRECONFIGURATION</i> message including <i>MEASUREMENTCONFIGURATION</i> to setup measurements and periodical reporting for 1xRTT cells.	<--	<i>RRCCONNECTIONRECONFIGURATION</i>	-	-
2	The UE transmits an <i>RRC CONNECTION RECONFIGURATION COMPLETE</i> message.	-->	<i>RRCCONNECTIONRECONFIGURATIONCOMPLETE</i>	-	-
2A	Wait and ignore <i>MEASUREMENTREPORT</i> messages for 5 s to allow for detection and measurement of 1xRTT cells.	-	-	-	-
-	EXCEPTION: In parallel to the events described in steps 3 to 4, the steps specified in table 8.3.2.10.3.2-3 shall take place.	-	-	-	-
3	Wait for 30 s to ensure that the UE performs a periodical reporting of 1xRTT cells.	-	-	-	-
4	SS sets the cell-specific reference signal levels for Cell 1, Cell 19 and Cell 20 according to row "T1" in table 8.3.2.10.3.2-1.	-	-	-	-
5	Wait and ignore <i>MEASUREMENTREPORT</i> messages for 5 s to allow for the switching of cells.	-	-	-	-
-	EXCEPTION: In parallel to the events described in steps 6 to 7, the steps specified in table 8.3.2.10.3.2-4 shall take place.	-	-	-	-
6	Wait for 30 s to ensure that the UE performs a periodical reporting of 1xRTT cells.	-	-	-	-
7	SS sets the cell-specific reference signal levels for Cell 1, Cell 19 and Cell 20 according to row "T2" in table 8.3.2.10.3.2-1.	-	-	-	-
8	Wait and ignore <i>MEASUREMENTREPORT</i> messages for 5 s to allow for the switching of cells.	-	-	-	-
-	EXCEPTION: In parallel to the events described in steps 9 to 10, the steps specified in table 8.3.2.10.3.2-5 shall take place.	-	-	-	-
9	Wait for 30 s to ensure that the UE performs a periodical reporting of 1xRTT cells.	-	-	-	-
10	SS transmits an <i>RRCCONNECTIONRECONFIGURATION</i> message including <i>MEASUREMENTCONFIGURATION</i> to remove <i>measId</i> for periodic reporting.	<--	<i>RRCCONNECTIONRECONFIGURATION</i>	-	-
11	The UE transmits an <i>RRC CONNECTION RECONFIGURATION COMPLETE</i> message.	-->	<i>RRCCONNECTIONRECONFIGURATIONCOMPLETE</i>	-	-
12	Wait for 30s for the UE so send a <i>MEASUREMENTREPORT</i> .	-->	<i>MEASUREMENTREPORT</i>	3	F

Table 8.3.2.10.3.2-3: Parallel behaviour

St	Procedure	Message Sequence		TP	Verdict
		U - S	Message		
-	EXCEPTION: Step 1 below shall be repeated every time the duration indicated in the <i>IE reportInterval</i> has elapsed.	-	-	-	-
1	Check: Does the UE transmit a <i>MEASUREMENTREPORT</i> message to perform periodical intra frequency reporting for Cell 19?	-->	<i>MEASUREMENTREPORT</i>	1	P

Table 8.3.2.10.3.2-4: Parallel behaviour

St	Procedure	Message Sequence		TP	Verdict
		U - S	Message		
-	EXCEPTION: Step 1 below shall be repeated every time the duration indicated in the IE <i>reportInterval</i> has elapsed.	-	-	-	-
1	Check: Does the UE transmit a <i>MeasurementReport</i> message to perform periodical intra frequency reporting for Cell 19 and Cell 20?	-->	<i>MeasurementReport</i>	1, 2	P

Table 8.3.2.10.3.2-5: Parallel behaviour

St	Procedure	Message Sequence		TP	Verdict
		U - S	Message		
-	EXCEPTION: Step 1 shall be repeated every time the duration indicated in the IE <i>reportInterval</i> has elapsed.	-	-	-	-
1	Check: Does the UE transmit a <i>MeasurementReport</i> message to perform periodical intra frequency reporting for Cell 20?	-->	<i>MeasurementReport</i>	1, 2	P

8.3.2.10.3.3 Specific message contents

Table 8.3.2.10.3.3-1: RRCConnectionReconfiguration (step 1, Table 8.3.2.10.3.2-2)

Derivation Path: 36.508, Table 4.6.1-8, condition MEAS
--

Table 8.3.2.10.3.3-2: *MeasConfig* (step 1, Table 8.3.2.10.3.2-2)

Derivation Path: 36.508, Table 4.6.6-1			
Information Element	Value/remark	Comment	Condition
<i>MeasConfig</i> ::= SEQUENCE {			
<i>measObjectToAddModList</i> SEQUENCE (SIZE (1.. <i>maxObjectId</i>)) OF SEQUENCE {	2 entries		
<i>measObjectId</i> [1]	<i>IdMeasObject</i> -f1		
<i>measObject</i> [1]	<i>MeasObject</i> EUTRA- <i>GENERIC</i> (f1)		
<i>measObjectId</i> [2]	<i>IdMeasObject</i> -f17		
<i>measObject</i> [2]	<i>MeasObject</i> CDMA2000		
}			
<i>reportConfigToAddModList</i> SEQUENCE (SIZE (1.. <i>maxReportConfigId</i>)) OF SEQUENCE {	1 entry		
<i>reportConfigId</i> [1]	<i>IdReportConfig</i> -f17		
<i>reportConfig</i> [1]	<i>ReportConfig</i> InterRAT- <i>PERIODICAL</i>		
}			
<i>measIdToAddModList</i> SEQUENCE (SIZE (1.. <i>maxMeasId</i>)) OF SEQUENCE {	1 entry		
<i>measId</i> [1]	1		
<i>measObjectId</i> [1]	<i>IdMeasObject</i> -f17		
<i>reportConfigId</i> [1]	<i>IdReportConfig</i> -f17		
}			
<i>quantityConfig</i> SEQUENCE {			
<i>quantityConfig</i> EUTRA	Not present		
<i>quantityConfig</i> UTRA	Not present		
<i>quantityConfig</i> GERAN	Not present		
<i>quantityConfig</i> CDMA2000 SEQUENCE {	Not present		
<i>measQuantity</i> CDMA2000	<i>pilotStrength</i>		
}			
}			
<i>measGapConfig</i> CHOICE {			
<i>setup</i> SEQUENCE {			
<i>gapOffset</i> CHOICE {			
<i>gp</i> 1	30		
}			
}			
}			
}			
}			
}			
}			
}			
}			

Table 8.3.2.10.3.3-3: MeasObjectCDMA2000 (step 1, Table 8.3.2.10.3.2-2)

Derivation Path: 36.508, Table 4.6.6-1C			
Information Element	Value/remark	Comment	Condition
MeasObjectCDMA2000-GENERIC ::= SEQUENCE {			
cdma2000-Type	Type1XRTT		
CarrierFreqCDMA2000 SEQUENCE {			
bandClass	Band Class of frequency under test		
arfcn	f17		
}			
SearchWindowSize	15		
cellsToAddModList SEQUENCE (SIZE (1..maxCellMeas)) OF SEQUENCE {	Not present		
cellIndex [1]	1		
physCellId [1]	PhysicalCellIdentity of Cell 19		
cellIndex [2]	2		
physCellId [2]	PhysicalCellIdentity of Cell 20		
}			
}			

Table 8.3.2.10.3.3-3A: ReportConfigInterRAT-PERIODICAL-CDMA2000 (step 1, Table 8.3.2.10.3.2-2)

Derivation Path: 36.508 table 4.6.6-9 ReportConfigInterRAT-PERIODICAL			
Information Element	Value/remark	Comment	Condition
ReportConfigInterRAT-PERIODICAL ::= SEQUENCE {			
maxReportCells	2	Report Cell 19 and Cell 20	
}			

Table 8.3.2.10.3.3-4: RRCConnectionReconfiguration (step 10, Table 8.3.2.10.3.2-2)

Derivation path: 36.508 table 4.6.1-6			
Information Element	Value/Remark	Comment	Condition
RRCConnectionReconfiguration ::= SEQUENCE {			
criticalExtensions CHOICE {			
c1 CHOICE{			
rrcConnectionReconfiguration-r8 SEQUENCE {			
measurementConfiguration ::= SEQUENCE {			
measIdToRemoveList ::= SEQUENCE (SIZE (1..maxMeasId)) OF SEQUENCE {	1 entry		
measId[1]	1		
}			
}			
}			
}			
}			

Table 8.3.2.10.3.3-5: MeasurementReport (step 1, Table 8.3.2.10.3.2-3, Table 8.3.2.10.3.2-4, Table 8.3.2.10.3.2-5)

Derivation Path: 36.508, Table 4.6.1-5			
Information Element	Value/remark	Comment	Condition
MeasurementReport ::= SEQUENCE {			
criticalExtensions CHOICE {			
c1 CHOICE{			
measurementReport-r8 SEQUENCE {			
measResults SEQUENCE {			
measId	1		
measResultServCell SEQUENCE {			
rsrpResult	(0..97)		
rsrqResult	(0..34)		
}			
measResultNeighCells CHOICE {			
measResultsCDMA2000 ::=SEQUENCE {			
preRegistrationStatusHRPD	FALSE		
measResultListCDMA2000 ::=SEQUENCE	1 or 2 entries		Table 8.3.2.10.3.2-3
(SIZE (1..maxCellReport)) OF SEQUENCE			
{			1 entry
physCellId[1]	PhysicalCellIdentity of Cell 19		
cfg-Info[1]	Not present		
measResult[1] SEQUENCE {			
pilotStrength	(0..63)		
}			
}			
}			2 entries
physCellId[1]	PhysicalCellIdentity of Cell 19		
cgi-Info[1]	Not present		
measResult[1] SEQUENCE {			
pilotStrength	(0..62)		
}			
physCellId[2]	PhysicalCellIdentity of Cell 20		
cgi-Info[2]	Not present		
measResult[2] SEQUENCE {			
pilotStrength	(35..63)		
}			
}			
measResultListCDMA2000 ::=SEQUENCE	2 entries	Cells can be reported in any order.	Table 8.3.2.10.3.2-4
(SIZE (1..maxCellReport)) OF SEQUENCE {			
physCellId[1]	PhysicalCellIdentity of Cell 19		
cgi-Info[1]	Not present		
measResult[1] SEQUENCE {			
pilotStrength	(0..63)		
}			
physCellId[2]	PhysicalCellIdentity of Cell 20		
cgi-Info[2]	Not present		
measResult[1] SEQUENCE {			
pilotStrength	(0..63)		
}			
}			
measResultListCDMA2000 ::=SEQUENCE	1 entry		Table 8.3.2.10.3.2-5
(SIZE (1..maxCellReport)) OF SEQUENCE			
{			1 entry
physCellId[1]	PhysicalCellIdentity of Cell 20		
cgi-Info[1]	Not present		

measResult[1] SEQUENCE {			
pilotStrength	(0..63)		
}			
}			
{			2 entries
physCellId[1]	PhysicalCellIdentity of Cell 20		
cgi-Info[1]	Not present		
measResult[1] SEQUENCE {			
pilotStrength	(0..62)		
}			
physCellId[2]	PhysicalCellIdentity of Cell 19		
cgi-Info[2]	Not present		
measResult[2] SEQUENCE {			
pilotStrength	(35..63)		
}			
}			
}			
}			
}			
}			
}			
}			
}			
}			
}			
}			
}			

8.3.2.11 Measurement configuration control and reporting / Inter-RAT Measurements / Event B1 / Measurement of UTRAN cells

8.3.2.11.1 Test Purpose (TP)

(1)

```
with { UE having completed the radio bearer establishment, initial security activation procedure and performed the inter RAT measurement for UTRA cell and not detected entering condition for the event B1 is met }
ensure that {
  when { UE detects entering condition for the event B1 is not met }
  then { UE does not transmit any MeasurementReport }
}
```

(2)

```
with { UE having completed the radio bearer establishment, initial security activation procedure and performed the inter RAT measurement for UTRA cell and not detected entering condition for the event B1 is met }
ensure that {
  when { UE detects entering condition for the event B1 is met }
  then { UE transmits a MeasurementReport }
}
```

(3)

```
with { UE having completed the radio bearer establishment, initial security activation procedure and performed the inter RAT measurement for UTRA cell and detected entering condition for the event B1 is met }
ensure that {
  when { UE detects leaving condition for the event B1 is met }
  then { UE does not transmit any MeasurementReport }
}
```

8.3.2.11.2 Conformance requirements

References: The conformance requirements covered in the present TC are specified in: TS 36.331, clause 5.5.4.1, 5.5.4.8 and 5.5.5.

[TS 36.331, clause 5.5.4.1]

The UE shall:

- 1> for each *measId* included in the *measIdList* within *VarMeasConfig*:
 - 2> if the corresponding *reportConfig* includes a purpose set to '*reportStrongestCellsForSON*':
 - ...
 - 2> else:
 - 3> if the corresponding *measObject* concerns E-UTRA:
 - ...
 - 3> else if the corresponding *measObject* concerns UTRA or CDMA2000:
 - 4> consider a neighbouring cell on the associated frequency to be applicable when the concerned cell is included in the *cellsToAddModList* defined within the *VarMeasConfig* for this *measId* (i.e. the cell is included in the white-list);
 - 3> else if the corresponding *measObject* concerns GERAN:
 - 4> consider a neighbouring cell on the associated set of frequencies to be applicable when the concerned cell matches the *ncc-Permitted* defined within the *VarMeasConfig* for this *measId*;
 - 2> if the *triggerType* is set to '*event*' and if the entry condition applicable for this event, i.e. the event corresponding with the *eventId* of the corresponding *reportConfig* within *VarMeasConfig*, is fulfilled for one or more applicable cells for all measurements after layer 3 filtering taken during *timeToTrigger* defined for this event within the *VarMeasConfig*, while the *VarMeasReportList* does not include an measurement reporting entry for this *measId*:(a first cell triggers the event)
 - 3> include a measurement reporting entry within the *VarMeasReportList* for this *measId*;
 - 3> set the *numberOfReportsSent* defined within the *VarMeasReportList* for this *measId* to 0;
 - 3> include the concerned cell(s) in the *cellsTriggeredList* defined within the *VarMeasReportList* for this *measId*;
 - 3> initiate the measurement reporting procedure, as specified in 5.5.5;
 - 2> if the *triggerType* is set to '*event*' and if the entry condition applicable for this event, i.e. the event corresponding with the *eventId* of the corresponding *reportConfig* within *VarMeasConfig*, is fulfilled for one or more applicable cells not included in the *cellsTriggeredList* for all measurements after layer 3 filtering taken during *timeToTrigger* defined for this event within the *VarMeasConfig* (a subsequent cell triggers the event):
 - ...
 - 2> if the *triggerType* is set to '*event*' and if the leaving condition applicable for this event is fulfilled for one or more of the cells included in the *cellsTriggeredList* defined within the *VarMeasReportList* for this *measId* for all measurements after layer 3 filtering taken during *timeToTrigger* defined within the *VarMeasConfig* for this event:
 - 3> remove the concerned cell(s) in the *cellsTriggeredList* defined within the *VarMeasReportList* for this *measId*;
 - 3> if *reportOnLeave* is set to *TRUE* for the corresponding reporting configuration:
 - 4> initiate the measurement reporting procedure, as specified in 5.5.5;
 - 3> if the *cellsTriggeredList* defined within the *VarMeasReportList* for this *measId* is empty:
 - 4> remove the measurement reporting entry within the *VarMeasReportList* for this *measId*;
 - 4> stop the periodical reporting timer for this *measId*, if running;

- 2> if the *purpose* is included and set to '*reportStrongestCells*' or '*reportStrongestCellsForSON*' and if a (first) measurement result is available for one or more applicable cells:
 - 3> include a measurement reporting entry within the *VarMeasReportList* for this *measId*;
 - 3> set the *numberOfReportsSent* defined within the *VarMeasReportList* for this *measId* to 0;
 - 3> initiate the measurement reporting procedure, as specified in 5.5.5;

NOTE 1: If the *purpose* is set to '*reportStrongestCells*', the UE initiates a first measurement report immediately after the quantity to be reported becomes available for at least either serving cell or one of the applicable cells. If the *purpose* is set to '*reportStrongestCellsForSON*', the UE initiates a first measurement report when it has determined the strongest cells on the associated frequency.

- 2> upon expiry of the periodical reporting timer for this *measId*:
 - 3> initiate the measurement reporting procedure, as specified in 5.5.5;
- 2> if the *purpose* is included and set to '*reportCGI*' and if the UE acquired the information needed to set all fields of *cellGlobalId* for the requested cell:
 - 3> include a measurement reporting entry within the *VarMeasReportList* for this *measId*;
 - 3> set the *numberOfReportsSent* defined within the *VarMeasReportList* for this *measId* to 0;
 - 3> stop timer T321;
 - 3> initiate the measurement reporting procedure, as specified in 5.5.5;
- 2> upon expiry of the T321 for this *measId*:
 - 3> include a measurement reporting entry within the *VarMeasReportList* for this *measId*;
 - 3> set the *numberOfReportsSent* defined within the *VarMeasReportList* for this *measId* to 0;
 - 3> initiate the measurement reporting procedure, as specified in 5.5.5;

NOTE 2: The UE does not stop the periodical reporting with *triggerType* set to '*event*' or to '*periodical*' while the corresponding measurement is not performed due to the serving cell RSRP being equal to or better than *s-Measure* or due to the measurement gap not being setup.

[TS 36.331, clause 5.5.4.7]

The UE shall:

- 1> for UTRA and CDMA2000, only trigger the event for cells included in the corresponding measurement object;
- 1> consider the entering condition for this event to be satisfied when condition B1-1, as specified below, is fulfilled;
- 1> consider the leaving condition for this event to be satisfied when condition B1-2, as specified below, is fulfilled;

Inequality B1-1 (Entering condition)

$$Mn + Ofn - Hys > Thresh$$

Inequality B1-2 (Leaving condition)

$$Mn + Ofn + Hys < Thresh$$

The variables in the formula are defined as follows:

Mn is the measurement result of the inter-RAT neighbour cell, not taking into account any offsets.

Ofn is the frequency specific offset of the frequency of the inter-RAT neighbour cell (i.e. *offsetFreq* as defined within the *measObject* corresponding to the frequency of the inter-RAT neighbour cell)

Hys is the hysteresis parameter for this event (i.e. hysteresis as defined within *reportConfigInterRAT* for this event)

Thresh is the threshold parameter for this event (i.e. b1-Threshold as defined within *reportConfigInterRAT* for this event)

Mn is expressed in dBm or dB, depending on the measurement quantity of the inter-RAT neighbour cell

Ofn, Hys are expressed in dB

Thresh is expressed in the same unit as **Mn**

[TS 36.331, clause 5.5.5]

The purpose of this procedure is to transfer measurement results from the UE to E-UTRAN.

For the *measId* for which the measurement reporting procedure was triggered, the UE shall set the *measResults* within the *MeasurementReport* message as follows:

- 1> set the *measId* to the measurement identity that triggered the measurement reporting;
- 1> set the *measResultServCell* to include the quantities of serving cell;
- 1> if there is at least one applicable neighbouring cell to report:
 - 2> set the *measResultNeighCells* to include the best neighbouring cells up to *maxReportCells* in accordance with the following:
 - 3> if the *triggerType* is set to 'event':
 - 4> include the cells included in the *cellsTriggeredList* as defined within the *VarMeasReportList* for this *measId*
 - 3> else:
 - 4> include the applicable calls for which the new measurement results became available since the last periodical reporting or since the measurement was initiated or reset;

NOTE: The reliability of the report (i.e. the certainty it contains the strongest cells on the concerned frequency) depends on the measurement configuration i.e. the *reportInterval*. The related performance requirements are specified in TS 36.133 [16].

- 3> for each cell that is included in the *measResultNeighCells* include the *physCellId*;
- 3> if the *triggerType* is set to 'event'; or the *purpose* is set to 'reportStrongestCells' or to 'reportStrongestCellsForSON':
 - 4> for each included cell include the layer 3 filtered measured results in accordance with the *reportConfig* for this *measId*, ordered as follows:
 - 5> if the *measObject* associated with this *measId* concerns E-UTRA:

...

5> else:

6> set the *measResult* to the quantity as configured for the concerned RAT within the *quantityConfig* in order of decreasing quantity, i.e. the best cell is included first;

...

- 1> increment the *numberOfReportsSent* as defined within the *VarMeasReportList* for this *measId* by 1;
- 1> stop the periodical reporting timer, if running;
- 1> if the *numberOfReportsSent* as defined within the *VarMeasReportList* for this *measId* is less than the *reportAmount* as defined within the corresponding *reportConfig* for this *measId*
 - 2> start the periodical reporting timer with the value of *reportInterval* as defined within the corresponding *reportConfig* for this *measId*;
- 1> else:

2> if the *triggerType* is set to 'periodical':

3> remove the entry within the *VarMeasReportList* for this *measId*;

3> remove this *measId* from the *measIdList* within *VarMeasConfig*;

1> if the measured results are for CDMA2000 HRPD:

2> set the *preRegistrationStatusHRPD* to the UE's CDMA2000 upper layer's HRPD *preRegistrationStatus*;

1> if the measured results are for CDMA2000 1xRTT:

2> set the *preRegistrationStatusHRPD* to 'FALSE';

1> submit the *MeasurementReport* message to lower layers for transmission, upon which the procedure ends;

8.3.2.11.3 Test description

8.3.2.11.3.1 Pre-test conditions

System Simulator:

- Cell 1 and Cell 7.
- System information combination 4 as defined in TS 36.508 [18] clause 4.4.3.1 is used in E-UTRA cells.

UE:

None.

Preamble:

- The UE is in state Generic RB Established (state 3) on Cell 1 according to [18].

8.3.2.11.3.2 Test procedure sequence

Table 8.3.2.3.3.2-1 illustrates the downlink power levels and other changing parameters to be applied for the cells at various time instants of the test execution. Row marked "T0" denotes the initial conditions after preamble, while columns marked "T1" and "T2" are to be applied subsequently. The exact instants on which these values shall be applied are described in the texts in this clause.

Table 8.3.2.11.3.2-1: Time instances of cell power level and parameter changes

	Parameter	Unit	Cell 1	Cell 7	Remark
T0	Cell-specific RS EPRE	dBm/15k Hz	-60	-	The power level values are such that entering conditions for event B1 are not satisfied.
	CPICH E_c (UTRA FDD)	dBm/3.8 4MHz	-	-88	
	PCCPCH E_c (UTRA LCR TDD)	dBm/1.2 8 MHz	-	-88	
T1	Cell-specific RS EPRE	dBm/15k Hz	-84	-	The power level values are such that entering conditions for event B1 are satisfied.
	CPICH E_c (UTRA FDD)	dBm/3.8 4MHz	-	-64	
	PCCPCH E_c (UTRA LCR TDD)	dBm/1.2 8 MHz	-	-64	
T2	Cell-specific RS EPRE	dBm/15k Hz	-60	-	The power level values are such that leaving conditions for event B1 are satisfied.
	CPICH E_c (UTRA FDD)	dBm/3.8 4MHz	-	-88	
	PCCPCH E_c (UTRA LCR TDD)	dBm/1.2 8 MHz	-	-88	

Table 8.3.2.11.3.2-2: Main behaviour

St	Procedure	Message Sequence		TP	Verdict
		U - S	Message		
1	The SS transmits an <i>RRCCONNECTIONRECONFIGURATION</i> message to setup inter RAT measurement on Cell 1.	<--	<i>RRCCONNECTIONRECONFIGURATION</i>	-	-
2	The UE transmits an <i>RRCCONNECTIONRECONFIGURATIONCOMPLETE</i> message to confirm the setup of inter RAT measurement on Cell 1.	-->	<i>RRCCONNECTIONRECONFIGURATIONCOMPLETE</i>	-	-
3	Check: Does the UE transmit a <i>MEASUREMENTREPORT</i> message on Cell 1 to report the event B1 during the next 10s?	-->	<i>MEASUREMENTREPORT</i>	1	F
4	The SS changes Cell 7 parameters according to the row "T1" in table 8.3.2.11.3.2-1.	-	-	-	-
5	Check: Does the UE transmit a <i>MEASUREMENTREPORT</i> message to report the event B1 for Cell 7?	-->	<i>MEASUREMENTREPORT</i>	2	P
6	The SS changes Cell 7 parameters according to the row "T2" in table 8.3.2.11.3.2-1.	-	-	-	-
7	Wait and ignore <i>MEASUREMENTREPORT</i> messages for 15 s to allow change of power levels and UE measurement for Cell 7.	-	-	-	-
8	Check: Does the UE transmit a <i>MEASUREMENTREPORT</i> message on Cell 1 to report the event B1 during the next 10s?	-->	<i>MEASUREMENTREPORT</i>	3	F
9	Check: Does the test result of generic test procedure in TS 36.508 subclause 6.4.2.3 indicate that the UE is in E-UTRA RRC_CONNECTED state on Cell 1?	-	-	1,2,3	-

8.3.2.11.3.3 Specific message contents

Table 8.3.2.11.3.3-1: *RRCCONNECTIONRECONFIGURATION* (step 1, Table 8.3.2.11.3.2-2)

Derivation Path: 36.508, Table 4.6.1-8, condition MEAS
--

Table 8.3.2.11.3.3-2: *MeasConfig* (Table 8.3.2.11.3.3-1)

Derivation Path: 36.508, Table 4.6.6-1, condition UTRAN			
Information Element	Value/remark	Comment	Condition
<i>MeasConfig</i> ::= SEQUENCE {			
<i>measObjectToAddModList</i> SEQUENCE (SIZE (1.. <i>maxObjectId</i>)) OF SEQUENCE {	2 entries		
<i>measObjectId</i> [1]	IdMeasObject-f1		
<i>measObject</i> [1]	MeasObjectEUTRA-GENERIC(f1)		
<i>measObjectId</i> [2]	IdMeasObject-f8		
<i>measObject</i> [2]	MeasObjectUTRA-f8		
}			
<i>reportConfigToAddModList</i> SEQUENCE (SIZE (1.. <i>maxReportConfigId</i>)) OF SEQUENCE {	1 entry		
<i>reportConfigId</i> [1]	IdReportConfig-B1-UTRA		
<i>reportConfig</i> [1]	ReportConfigInterRAT-B1-UTRA(-76)		
}			
<i>measIdToAddModList</i> SEQUENCE (SIZE (1.. <i>maxMeasId</i>)) OF SEQUENCE {	1 entry		
<i>measId</i> [1]	1		
<i>measObjectId</i> [1]	IdMeasObject-f8		
<i>reportConfigId</i> [1]	IdReportConfig-B1-UTRA		
}			
}			

Table 8.3.2.11.3.3-3: *QuantityConfig* (Table 8.3.2.11.3.3-1)

Derivation Path: 36.508, Table 4.6.6-3A, condition UTRAN			
Information Element	Value/remark	Comment	Condition
QuantityConfig SEQUENCE {			
quantityConfigUTRA SEQUENCE {			
measQuantityUTRA-FDD	cpich-RSCP		UTRA-FDD
measQuantityUTRA-TDD	pccpch-RSCP		UTRA-TDD
filterCoefficient	fc0		
}			
}			

Condition	Explanation
UTRA-FDD	UTRA FDD cell environment
UTRA-TDD	UTRA TDD cell environment

Table 8.3.2.11.3.3-4: *MeasObjectUTRA-f8* (Table 8.3.2.11.3.3-2)

Derivation path: 36.508 table 4.6.6-3 MeasObjectUTRA-GENERIC(f8)			
Information Element	Value/Remark	Comment	Condition
MeasObjectUTRA-GENERIC(f8) ::= SEQUENCE {			
carrierFreq	UTRA DL carrier frequency of the cell 7		
cellsToAddModList CHOICE {			
cellsToAddModListUTRA-FDD ::= SEQUENCE (SIZE (1.. maxCellMeas)) OF SEQUENCE {			UTRA-FDD
cellIndex [1]	1		
physCellId [1]	physicalCellIdentity – Cell 7		
}			
cellsToAddModListUTRA-TDD ::= SEQUENCE (SIZE (1..maxMeasId)) OF SEQUENCE {			UTRA-TDD
cellIndex [1]	1		
physCellId [1]	physicalCellIdentity – Cell 7		
}			
}			
}			

Condition	Explanation
UTRA-FDD	UTRA-FDD cell environment
UTRA-TDD	UTRA-TDD cell environment

Table 8.3.2.11.3.3-5: *ReportConfigInterRAT-B1-UTRA* (Table 8.3.2.11.3.3-2)

Derivation path: 36.508, Table 4.6.6-7B ReportConfigInterRAT-B1-UTRA(-18)			
Information Element	Value/remark	Comment	Condition
ReportConfigInterRAT-B1-UTRA(UTRA-Thres) ::= SEQUENCE {			
triggerType CHOICE {			
event SEQUENCE {			
timeToTrigger	ms0		
}			
}			
reportAmount	infinity		
}			

Condition	Explanation
UTRA-FDD	UTRA FDD cell environment
UTRA-TDD	UTRA TDD cell environment

Table 8.3.2.11.3.3-6: *MeasurementReport* (step 5, Table 8.3.2.11.3.2-2)

Derivation Path: 36.508, Table 4.6.1-5			
Information Element	Value/remark	Comment	Condition
MeasurementReport ::= SEQUENCE {			
criticalExtensions CHOICE {			
c1 CHOICE{			
measurementReport-r8 SEQUENCE {			
measResults SEQUENCE {			
measId	1		
measResultServCell SEQUENCE {			
rsrpResult	(0..97)		
rsrqResult	(0..34)		
}			
measResultNeighCells CHOICE {			
measResultListUTRA SEQUENCE (SIZE (1..maxCellReport)) OF SEQUENCE {	1 entry		
physCellId[1]	PhysicalCellIdentity of Cell 7		
cgi-Info[1]	Not present		
measResult[1] SEQUENCE {			
utra-RSCP	(-5..91)		
}			
}			
}			
}			
}			
}			

Condition	Explanation
UTRA-FDD	UTRA FDD cell environment
UTRA-TDD	UTRA TDD cell environment

8.3.3 Measurements for self optimized networks

8.3.3.1 Measurement configuration control and reporting / SON / ANR / CGI reporting of E-UTRAN cell

8.3.3.1.1 Test Purpose (TP)

(1)

```
with { UE in E-UTRA RRC_CONNECTED state }
ensure that {
  when { Neighbour becomes offset better than serving }
  then { UE sends MeasurementReport for event A3 }
}
```

(2)

```
with { UE in E-UTRA RRC_CONNECTED state }
ensure that {
  when { UE is commanded to report the global cell identity of the neighbour cell }
  then { UE determines the global cell identity of the cell included in the associated measurement object by acquiring the relevant system information from the concerned cell and reports the global cell identity in the MeasurementReport }
}
```

8.3.3.1.2 Conformance requirements

References: The conformance requirements covered in the current TC are specified in: TS 36.331, clauses 5.3.5.3, 5.5.2.3, 5.5.3.1, 5.5.4.1 and 5.5.5.

[TS 36.331, clause 5.3.5.3]

If the *RRConnectionReconfiguration* message does not include the *mobilityControlInfo* and the UE is able to comply with the configuration included in this message, the UE shall:

...

- 1> If the *RRConnectionReconfiguration* message includes the *measConfig*:
- 2> perform the Measurement configuration procedure as specified in 5.5.2;

...

[TS 36.331, clause 5.5.2.3]

The UE shall:

...

The UE shall:

- 1> for each *measId* included in the received *measIdToAddModList*:
 - 2> if an entry with the matching *measId* exists in the *measIdList* within the *VarMeasConfig*:
 - 3> replace the entry with the value received for this *measId*;
 - 2> else:
 - 3> add a new entry for this *measId* within the *VarMeasConfig* ;
 - 2> remove the measurement reporting entry for this *measId* from the *VarMeasReportList*, if included;
 - 2> stop the periodical reporting timer or timer T321, whichever one is running, and reset the associated information (e.g. *timeToTrigger*) for this *measId*;
 - 2> if the *triggerType* is set to '*periodical*' and the *purpose* is set to '*reportCGI*' in the *reportConfig* associated with this *measId*:
 - 3> if the *measObject* associated with this *measId* concerns E-UTRA:
 - 4> start timer T321 with the timer value set to 1 second for this *measId*;
 - 3> else:
 - 4> start timer T321 with the timer value set to 8 seconds for this *measId*;

[TS 36.331, clause 5.5.3.1]

The UE supports measurements using a reporting configuration with the *purpose* set to '*reportCGI*', if the network provides sufficient idle periods.

The UE applies the layer 3 filtering as specified in 5.5.3.2, before using the measured results for evaluation of reporting criteria or for measurement reporting.

The UE shall:

- 1> for each *measId* included in the *measIdList* within *VarMeasConfig*:
 - 2> if a measurement gap configuration is setup; or
 - 2> the UE does not require measurement gaps to perform the concerned measurement:
 - 3> if *s-Measure* is not configured; or
 - 3> if *s-Measure* is configured and the serving cell RSRP, after layer 3 filtering, is lower than this value; or
 - 3> if the *purpose* for the associated *reportConfig* is set to '*reportCGI*':

- 4> perform the corresponding measurements of neighbouring cells on the frequencies and RATs indicated in the concerned *measObject*;
- 2> perform the evaluation of reporting criteria as specified in section 5.5.4;
- 1> if a *measId* is configured for which the *purpose* within the associated *reportConfig* is set to ‘*reportCGI*’:
 - 2> try to acquire the global cell identity of the cell indicated by the *cellForWhichToReportCGI* in the associated *measObject* by acquiring the relevant system information from the concerned cell;
 - 2> if the cell indicated by the *cellForWhichToReportCGI* included in the associated *measObject* is an E-UTRAN cell:
 - 3> try to acquire the list of additional PLMN Identities, as included in the *plmn-IdentityList*, if multiple PLMN identities are broadcast in the concerned cell;

NOTE: The ‘primary’ PLMN is part of the global cell identity.

- 2> if the cell indicated by the *cellForWhichToReportCGI* included in the associated *measObject* is a UTRAN cell:
 - 3> try to acquire the LAC, the RAC and the list of additional PLMN Identities, if multiple PLMN identities are broadcast in the concerned cell;
- 2> if the cell indicated by the *cellForWhichToReportCGI* included in the associated *measObject* is a GERAN cell:
 - 3> try to acquire the RAC in the concerned cell;
- 2> if the cell indicated by the *cellForWhichToReportCGI* included in the associated *measObject* is a CDMA2000 cell and the *cdma2000-Type* included in the *measObject* is ‘*typeHRPD*’:
 - 3> try to acquire the Sector ID in the concerned cell;
- 2> if the cell indicated by the *cellForWhichToReportCGI* included in the associated *measObject* is a CDMA2000 cell and the *cdma2000-Type* included in the *measObject* is ‘*type1XRTT*’:
 - 3> try to acquire the BASE ID, SID and NID in the concerned cell;

...

[TS 36.331, clause 5.5.4.1]

The UE shall:

- 1> for each *measId* included in the *measIdList* within *VarMeasConfig*:
 - 2> if the corresponding *reportConfig* includes a purpose set to ‘*reportStrongestCellsForSON*’:
 - 3> consider any neighbouring cell detected on the associated frequency to be applicable;
 - 2> else if the corresponding *reportConfig* includes a purpose set to ‘*reportCGI*’:
 - 3> consider any neighbouring cell detected on the associated frequency/ set of frequencies (GERAN) which has a physical cell identity matching the value of the *cellForWhichToReportCGI* included in the corresponding *measObject* within the *VarMeasConfig* to be applicable;
 - 2> else:
 - 3> if the corresponding *measObject* concerns E-UTRA:
 - 4> consider any neighbouring cell detected on the associated frequency to be applicable when the concerned cell is not included in the *blackCellsToAddModList* defined within the *VarMeasConfig* for this *measId*;
 - 3> else if the corresponding *measObject* concerns UTRA or CDMA2000:

- 4> consider a neighbouring cell on the associated frequency to be applicable when the concerned cell is included in the *cellsToAddModList* defined within the *VarMeasConfig* for this *measId* (i.e. the cell is included in the white-list);
- 3> else if the corresponding *measObject* concerns GERAN:
 - 4> consider a neighbouring cell on the associated set of frequencies to be applicable when the concerned cell matches the *ncc-Permitted* defined within the *VarMeasConfig* for this *measId*;
- 2> if the *triggerType* is set to 'event' and if the entry condition applicable for this event, i.e. the event corresponding with the *eventId* of the corresponding *reportConfig* within *VarMeasConfig*, is fulfilled for one or more applicable cells for all measurements after layer 3 filtering taken during *timeToTrigger* defined for this event within the *VarMeasConfig*, while the *VarMeasReportList* does not include an measurement reporting entry for this *measId* (a first cell triggers the event):
 - 3> include a measurement reporting entry within the *VarMeasReportList* for this *measId*;
 - 3> set the *numberOfReportsSent* defined within the *VarMeasReportList* for this *measId* to 0;
 - 3> include the concerned cell(s) in the *cellsTriggeredList* defined within the *VarMeasReportList* for this *measId*;
 - 3> initiate the measurement reporting procedure, as specified in 5.5.5;
- 2> if the *triggerType* is set to 'event' and if the entry condition applicable for this event, i.e. the event corresponding with the *eventId* of the corresponding *reportConfig* within *VarMeasConfig*, is fulfilled for one or more applicable cells not included in the *cellsTriggeredList* for all measurements after layer 3 filtering taken during *timeToTrigger* defined for this event within the *VarMeasConfig* (a subsequent cell triggers the event):
 - 3> set the *numberOfReportsSent* defined within the *VarMeasReportList* for this *measId* to 0;
 - 3> include the concerned cell(s) in the *cellsTriggeredList* defined within the *VarMeasReportList* for this *measId*;
 - 3> initiate the measurement reporting procedure, as specified in 5.5.5;
- 2> if the *triggerType* is set to 'event' and if the leaving condition applicable for this event is fulfilled for one or more of the cells included in the *cellsTriggeredList* defined within the *VarMeasReportList* for this *measId* for all measurements after layer 3 filtering taken during *timeToTrigger* defined within the *VarMeasConfig* for this event:
 - 3> remove the concerned cell(s) in the *cellsTriggeredList* defined within the *VarMeasReportList* for this *measId*;
 - 3> if *reportOnLeave* is set to *TRUE* for the corresponding reporting configuration:
 - 4> initiate the measurement reporting procedure, as specified in 5.5.5;
 - 3> if the *cellsTriggeredList* defined within the *VarMeasReportList* for this *measId* is empty:
 - 4> remove the measurement reporting entry within the *VarMeasReportList* for this *measId*;
 - 4> stop the periodical reporting timer for this *measId*, if running;
- 2> if the *purpose* is included and set to 'reportStrongestCells' or to 'reportStrongestCellsForSON' and if a (first) measurement result is available for one or more applicable cells:
 - 3> include a measurement reporting entry within the *VarMeasReportList* for this *measId*;
 - 3> set the *numberOfReportsSent* defined within the *VarMeasReportList* for this *measId* to 0;
 - 3> initiate the measurement reporting procedure, as specified in 5.5.5;

NOTE 1: If the *purpose* is set to *'reportStrongestCells'*, the UE initiates a first measurement report immediately after the quantity to be reported becomes available for at least either serving cell or one of the applicable cells. If the purpose is set to *'reportStrongestCellsForSON'*, the UE initiates a first measurement report when it has determined the strongest cells on the associated frequency.

- 2> upon expiry of the periodical reporting timer for this *measId*:
 - 3> initiate the measurement reporting procedure, as specified in 5.5.5;
- 2> if the *purpose* is included and set to *'reportCGI'* and if the UE acquired the information needed to set all fields of *cgi-Info* for the requested cell:
 - 3> include a measurement reporting entry within the *VarMeasReportList* for this *measId*;
 - 3> set the *numberOfReportsSent* defined within the *VarMeasReportList* for this *measId* to 0;
 - 3> stop timer T321;
 - 3> initiate the measurement reporting procedure, as specified in 5.5.5;
- 2> upon expiry of the T321 for this *measId*:
 - 3> include a measurement reporting entry within the *VarMeasReportList* for this *measId*;
 - 3> set the *numberOfReportsSent* defined within the *VarMeasReportList* for this *measId* to 0;
 - 3> initiate the measurement reporting procedure, as specified in 5.5.5;

NOTE 2: The UE does not stop the periodical reporting with *triggerType* set to *'event'* or to *'periodical'* while the corresponding measurement is not performed due to the serving cell RSRP being equal to or better than *s-Measure* or due to the measurement gap not being setup.

NOTE 3: If the UE is configured with DRX, the UE may delay the measurement reporting for event triggered and periodical triggered measurements until the Active Time, which is defined in TS 36.321 [6].

[TS 36.331, clause 5.5.5]

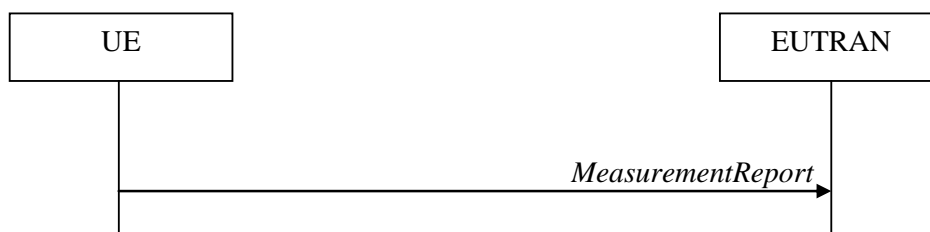

Figure 5.5.5-1: Measurement reporting

The purpose of this procedure is to transfer measurement results from the UE to E-UTRAN.

For the *measId* for which the measurement reporting procedure was triggered, the UE shall set the *measResults* within the *MeasurementReport* message as follows:

- 1> set the *measId* to the measurement identity that triggered the measurement reporting;
- 1> set the *measResultServCell* to include the quantities of serving cell;
- 1> if there is at least one applicable neighbouring cell to report:
 - 2> set the *measResultNeighCells* to include the best neighbouring cells up to *maxReportCells* in accordance with the following:
 - 3> if the *triggerType* is set to *'event'*:

4> include the cells included in the *cellsTriggeredList* as defined within the *VarMeasReportList* for this *measId*;

3> else:

4> include the applicable cells for which the new measurement results became available since the last periodical reporting or since the measurement was initiated or reset;

NOTE: The reliability of the report (i.e. the certainty it contains the strongest cells on the concerned frequency) depends on the measurement configuration i.e. the *reportInterval*. The related performance requirements are specified in TS 36.133 [16].

3> for each cell that is included in the *measResultNeighCells*, include the *physCellId*;

3> if the *triggerType* is set to 'event'; or the *purpose* is set to 'reportStrongestCells' or to 'reportStrongestCellsForSON':

4> for each included cell, include the layer 3 filtered measured results in accordance with the *reportConfig* for this *measId*, ordered as follows:

5> if the *measObject* associated with this *measId* concerns E-UTRA:

6> set the *measResult* to include the quantity(ies) indicated in the *reportQuantity* within the concerned *reportConfig* in order of decreasing *triggerQuantity*, i.e. the best cell is included first;

5> else:

6> set the *measResult* to the quantity as configured for the concerned RAT within the *quantityConfig* in order of decreasing quantity, i.e. the best cell is included first;

3> else if the *purpose* is set to 'reportCGI':

4> if the mandatory present fields of the *cgi-Info* for the cell indicated by the *cellForWhichToReportCGI* in the associated *measObject* have been obtained:

5> include the *cgi-Info* containing all the fields that have been successfully acquired;

1> increment the *numberOfReportsSent* as defined within the *VarMeasReportList* for this *measId* by 1;

1> stop the periodical reporting timer, if running;

1> if the *numberOfReportsSent* as defined within the *VarMeasReportList* for this *measId* is less than the *reportAmount* as defined within the corresponding *reportConfig* for this *measId*:

2> start the periodical reporting timer with the value of *reportInterval* as defined within the corresponding *reportConfig* for this *measId*;

1> else:

2> if the *triggerType* is set to 'periodical':

3> remove the entry within the *VarMeasReportList* for this *measId*;

3> remove this *measId* from the *measIdList* within *VarMeasConfig*;

1> if the measured results are for CDMA2000 HRPD:

2> set the *preRegistrationStatusHRPD* to the UE's CDMA2000 upper layer's HRPD *preRegistrationStatus*;

1> if the measured results are for CDMA2000 1xRTT:

2> set the *preRegistrationStatusHRPD* to 'FALSE';

1> submit the *MeasurementReport* message to lower layers for transmission, upon which the procedure ends;

...

8.3.3.1.3 Test description

8.3.3.1.3.1 Pre-test conditions

System Simulator:

- Cell 1 and Cell 2

Preamble:

- The UE is in state Generic RB Established (state 3) on Cell 1 according to [18].

8.3.3.1.3.2 Test procedure sequence

Table 8.3.3.1.3.2-1 illustrates the downlink power levels to be applied for Cell 1 and Cell 2 at various time instants of the test execution. Row marked "T0" denotes the conditions after the preamble, while row marked "T1" is to be applied subsequently. The exact instants on which these values shall be applied are described in the texts in this clause.

Table 8.3.3.1.3.2-1: Power levels

	Parameter	Unit	Cell 1	Cell 2 (DL only)	Remark
T0	Cell-specific RS EPRE	dBm/15kHz	-85	-91	Power levels shall be such that entry condition for event A3 is not satisfied: $Mn + Ofn + Ocn + Hys < Ms + Ofs + Ocs + Off$
T1	Cell-specific RS EPRE	dBm/15kHz	-85	-79	Power levels shall be such that entry condition for event A3 is satisfied: $Mn + Ofn + Ocn - Hys > Ms + Ofs + Ocs + Off$

Table 8.3.3.1.3.2-2: Main behaviour

St	Procedure	Message Sequence		TP	Verdict
		U - S	Message		
1	The SS transmits an <i>RRCCONNECTIONRECONFIGURATION</i> message including <i>measConfig</i> to setup intra LTE measurement and reporting for event A3 (intra frequency measurement) and set <i>timeAlignmentTimerDedicated</i> to <i>infinity</i> .	<--	<i>RRCCONNECTIONRECONFIGURATION</i>	-	-
2	The UE transmits an <i>RRCCONNECTIONRECONFIGURATIONCOMPLETE</i> message.	-->	<i>RRCCONNECTIONRECONFIGURATIONCOMPLETE</i>	-	-
3	The SS re-adjusts the cell-specific reference signal level according to row "T1" in table 8.3.3.1.3.2-1.	-	-	-	-
4	Check: Does the UE transmit a <i>MEASUREMENTREPORT</i> message to report event A3 with the measured RSRP value for Cell 2?	-->	<i>MEASUREMENTREPORT</i>	1	P
5	The SS transmits an <i>RRCCONNECTIONRECONFIGURATION</i> message including <i>measConfig</i> including <i>reportCGI</i> for Cell 2 and sufficient idle periods for UE to acquire the relevant system information from Cell 2.	<--	<i>RRCCONNECTIONRECONFIGURATION</i>	-	-
6	The UE transmits an <i>RRCCONNECTIONRECONFIGURATIONCOMPLETE</i> message.	-->	<i>RRCCONNECTIONRECONFIGURATIONCOMPLETE</i>	-	-
7	Check: Does the UE transmit a <i>MEASUREMENTREPORT</i> message with <i>cellGlobalId</i> of Cell 2 within 1 sec.	-->	<i>MEASUREMENTREPORT</i>	2	P

8.3.3.1.3.3 Specific message contents

Table 8.3.3.1.3.3-1: SystemInformationBlockType2 for Cell 1 (preamble and all the steps in Table 8.3.3.1.3.2-2)

Derivation Path: 36.508 clause 4.4.3.3-1			
Information Element	Value/remark	Comment	Condition
SystemInformationBlockType2 ::= SEQUENCE {			
RadioResourceConfigCommonSIB-DEFAULT ::= SEQUENCE {			
pcch-Config	PCCH-Config-LONGCYCLE		
}			
PCCH-Config-LONGCYCLE ::= SEQUENCE {			
defaultPagingCycle	rf256		
nB	oneT		
}			
}			

Table 8.3.3.1.3.3-1A: SystemInformationBlockType1 for Cell 2 (preamble and all steps, Table 8.3.3.1.3.2-2)

Derivation Path: 36.508 Table 4.4.3.2-3			
Information Element	Value/remark	Comment	Condition
SystemInformationBlockType1 ::= SEQUENCE {			
cellAccessRelatedInfo SEQUENCE {			
plmn-IdentityList SEQUENCE (SIZE (1..6)) OF SEQUENCE {	2 entries		
plmn-Identity[1] SEQUENCE {			
mcc	See Table 8.3.3.1.3.3-1B		
mnc	See Table 8.3.3.1.3.3-1B		
}			
cellReservedForOperatorUse[1]	notReserved		
plmn-Identity[2] SEQUENCE {			
mcc	See Table 8.3.3.1.3.3-1B		
mnc	See Table 8.3.3.1.3.3-1B		
}			
cellReservedForOperatorUse[2]	notReserved		
}			
}			
}			

The PLMN Identity list broadcasted on the BCCH in Cell 2 shall be configured as defined in the table below.

Table 8.3.3.1.3.3-1B: PLMN Identity List broadcasted for Cell 2

Cell	PLMN Identity (1)		PLMN Identity (2)	
	MCC digits	MNC digits	MCC digits	MNC digits
2	PLMN 1	PLMN 1	PLMN 2	PLMN 2

The definition of each PLMN code is found in table below.

PLMN	MCC digit			MNC digit		
	1	2	3	1	2	3
1	0	0	1	0	1	-
2	0	0	1	0	2	-

NOTE: “-“ (dash) denotes “not present”

Table 8.3.3.1.3.3-2: RRCConnectionReconfiguration (step 1, Table 8.3.3.1.3.2-2)

Derivation Path: 36.508 clause 4.6.1 table 4.6.1-8 with condition MEAS			
Information Element	Value/remark	Comment	Condition
RadioResourceConfigDedicated ::= SEQUENCE {			
srb-ToAddModList	Not present		
drb-ToAddModList	Not present		
drb-ToReleaseList	Not present		
mac-MainConfig CHOICE {			
explicitValue SEQUENCE {			
ul-SCH-Config	Not present		
drx-Config	Not present		
timeAlignmentTimerDedicated	infinity		
phr-Config	Not present		
}			
}			
sps-Config	Not present		
physicalConfigDedicated	Not present		
}			

Table 8.3.3.1.3.3-3 MeasConfig (step 1, Table 8.3.3.1.3.2-2)

Derivation Path: 36.508 clause 4.6.6 table 4.6.6-1			
Information Element	Value/remark	Comment	Condition
MeasConfig ::= SEQUENCE {			
measIdToAddModList ::= SEQUENCE (SIZE (1..maxMeasId)) OF SEQUENCE {	1 entry		
measId[1]	1		
measObjectId[1]	IdMeasObject-f1		
reportConfigId[1]	IdReportConfig-A3		
}			
measObjectToAddModList ::= SEQUENCE (SIZE (1..maxObjectId)) OF SEQUENCE {	1 entry		
measObjectId[1]	IdMeasObject-f1		
measObject[1]	MeasObjectEUTRA-GENERIC(f1)		
}			
reportConfigToAddModList ::= SEQUENCE (SIZE (1..maxReportConfigId)) OF SEQUENCE {	1 entry		
reportConfigId[1]	IdReportConfig-A3		
reportConfig[1]	ReportConfig-A3-H		
}			
}			

Table 8.3.3.1.3.3-4 ReportConfig-A3-H (step 1, Table 8.3.3.1.3.2-2)

Derivation path: 36.508 clause 4.6.6 table 4.6.6-6 ReportConfigEUTRA-A3			
Information Element	Value/remark	Comment	Condition
ReportConfigEUTRA-A3 ::= SEQUENCE {			
triggerType CHOICE {			
event SEQUENCE {			
eventId CHOICE {			
eventA3 SEQUENCE {			
}			
}			
}			
timeToTrigger	ms0		
}			
}			
reportQuantity	sameAsTriggerQuantity		
}			

Table 8.3.3.1.3.3-5 MeasurementReport (step 4, Table 8.3.3.1.3.2-2)

Derivation path: 36.508 4.6.1 table 4.6.1-5			
Information Element	Value/Remark	Comment	Condition
MeasurementReport ::= SEQUENCE {			
criticalExtensions CHOICE {			
c1 CHOICE {			
measurementReport-r8 SEQUENCE {			
measResults ::= SEQUENCE {			
measId	1		
measResultServCell ::= SEQUENCE {		Report Cell 1	
rsrpResult	(0..97)		
rsrqResult	(0..34)		
}			
measResultNeighCells CHOICE {			
measResultListEUTRA SEQUENCE (SIZE (1..maxCellReport)) OF SEQUENCE {		Report Cell 2	
physCellId	PhysCellId of the Cell 2.		
cgi-Info	Not present		
measResult SEQUENCE{			
rsrpResult	(0..97)		
rsrqResult	Not present		
}			
}			
}			
}			
}			
}			
}			

Table 8.3.3.1.3.3-6: RRCConnectionReconfiguration (step 5, Table 8.3.3.1.3.2-2)

Derivation Path: 36.508 clause 4.6.1 table 4.6.1-8 with condition MEAS			
Information Element	Value/remark	Comment	Condition
RRCConnectionReconfiguration ::= SEQUENCE {			
radioResourceConfigDedicated	RadioResourceConfigDedicated-DRX		
}			

Table 8.3.3.1.3.3-7 *MeasConfig* (step 5, Table 8.3.3.1.3.2-2)

Derivation Path: 36.508 clause 4.6.6 table 4.6.6-1			
Information Element	Value/remark	Comment	Condition
MeasConfig ::= SEQUENCE {			
measIdToAddModList ::= SEQUENCE (SIZE (1..maxMeasId)) OF SEQUENCE {	1 entry		
measId[1]	2		
measObjectId[1]	IdMeasObject-f1		
reportConfigId[1]	ReportConfigId-CGI		
}			
measObjectToAddModList ::= SEQUENCE (SIZE (1..maxObjectId)) OF SEQUENCE {	1 entry		
measObjectId[1]	IdMeasObject-f1		
measObject[1]	MeasObjectEUTRA-CGI		
}			
reportConfigToRemoveList ::= SEQUENCE (SIZE (1..maxReportConfigId)) OF SEQUENCE {			
reportConfigId	IdReportConfig-A3		
}			
reportConfigToAddModList ::= SEQUENCE (SIZE (1..maxReportConfigId)) OF SEQUENCE {	1 entry		
reportConfigId[1]	ReportConfigId-CGI		
reportConfig[1]	ReportConfig-CGI		
}			
}			

Table 8.3.3.1.3.3-8: *MeasObjectEUTRA-CGI* (step 5, Table 8.3.3.1.3.2-2)

Derivation Path: 36.508 clause 4.6.6 table 4.6.6-2			
Information Element	Value/remark	Comment	Condition
MeasObjectEUTRA-CGI ::= SEQUENCE {			
carrierFreq SEQUENCE {}	Downlink EARFCN for f1		
cellForWhichToReportCGI	PhysCellId of the Cell 2.		
}			

Table 8.3.3.1.3.3-9: *ReportConfig-CGI* (step 5, Table 8.3.3.1.3.2-2)

Derivation Path: 36.508, Table 4.6.6-7			
Information Element	Value/remark	Comment	Condition
ReportConfigEUTRA ::= SEQUENCE {			
triggerType CHOICE {			
periodical SEQUENCE {			
purpose CHOICE {			
reportCGI	NULL		
}			
}			
reportQuantity	sameAsTriggerQuantity		
reportAmount	r1		
}			

Table 8.3.3.1.3.3-10: RadioResourceConfigDedicated-DRX (step 5, Table 8.3.3.1.3.2-2)

Derivation Path: 36.508 clause 4.6.3.19			
Information Element	Value/remark	Comment	Condition
RadioResourceConfigDedicated-DRX ::= SEQUENCE {			
mac-MainConfig CHOICE {			
explicitValue SEQUENCE {			
ul-SCH-Config SEQUENCE {			
maxHARQ-Tx	n5		
periodicBSR-Timer	infinity		
retxBSR-Timer	sf10240		
ttiBundling	FALSE		
}			
drx-Config CHOICE {			
setup SEQUENCE {			
onDurationTimer	psf6		
drx-InactivityTimer	psf60		
drx-RetransmissionTimer	sf16		
longDRX-CycleStartOffset CHOICE {			
sf1280	4		
}			
shortDRX	Not present		
}			
}			
timeAlignmentTimerDedicated	infinity		
phr-Config CHOICE {			
release	NULL		
}			
}			
}			
physicalConfigDedicated	Not present		
}			

Table 8.3.3.1.3.3-11: *MeasurementReport* (step 7, Table 8.3.3.1.3.2-2)

Derivation path: 36.508 4.6.1 table 4.6.1-5			
Information Element	Value/remark	Comment	Condition
MeasurementReport ::= SEQUENCE {			
criticalExtensions CHOICE {			
c1 CHOICE {			
measurementReport-r8 SEQUENCE {			
measResults ::= SEQUENCE {			
measId	2		
measResultServCell SEQUENCE {		Report Cell 1	
rsrpResult	(0..97)		
rsrqResult	(0..34)		
}			
measResultNeighCells CHOICE {			
measResultListEUTRA SEQUENCE (SIZE (1..maxCellReport)) OF SEQUENCE {	1 entry		
physCellId[1]	PhysCellId of Cell 2		
cgi-Info[1] SEQUENCE {			
cellGlobalId	cellGlobalId of formed from the first entry in 'plmn-IdentityList' and 'cellIdentity' Cell 2		
trackingAreaCode	trackingAreaCode of Cell 2		
plmn-IdentityList {}	List of identities starting from the second entry of plmn-IdentityList of Cell 2		
}			
}			
measResult[1] SEQUENCE {			
rsrpResult	Not present		
rsrqResult	Not present		
}			
}			
}			
}			
}			

8.3.3.2 Measurement configuration control and reporting / SON / ANR / CGI reporting of UTRAN cell

8.3.3.2.1 Test Purpose (TP)

(1)

```
with { UE in E-UTRA RRC_CONNECTED state and measurement configured for periodic reporting of UTRA cells with the purpose of SON }
ensure that {
  when { The UE receives reference signal power for cells on the UTRA frequency where measurements are configured }
  then { UE sends MeasurementReport message at regular intervals for these UTRA cells }
}
```

(2)

```
with { UE in E-UTRA RRC_CONNECTED state }
ensure that {
  when { UE is commanded to report the global cell identity of the inter-RAT(UTRAN) neighbour cell }
  then { UE determines the global cell identity of the inter-RAT(UTRAN) cell included in the associated measurement object by acquiring the relevant system information from the concerned cell and reports the global cell identity in the MeasurementReport message }
}
```

8.3.3.2.2 Conformance requirements

References: The conformance requirements covered in the current TC are specified in: TS 36.331, clauses 5.3.5.3, 5.5.2.3, 5.5.3, 5.5.4.1 and 5.5.5.

[TS 36.331, clause 5.3.5.3]

If the *RRConnectionReconfiguration* message does not include the *mobilityControlInfo* and the UE is able to comply with the configuration included in this message, the UE shall:

...

- 1> if the *RRConnectionReconfiguration* message includes the *measConfig*:
- 2> perform the measurement configuration procedure as specified in 5.5.2;

...

[TS 36.331, clause 5.5.2.3]

The UE shall:

...

- 2> if the *triggerType* is set to '*periodical*' and the *purpose* is set to '*reportCGI*' in the *reportConfig* associated with this *measId*:
- 3> if the *measObject* associated with this *measId* concerns E-UTRA:
 - 4> start timer T321 with the timer value set to 1 second for this *measId*;
- 3> else:
 - 4> start timer T321 with the timer value set to 8 seconds for this *measId*;

[TS 36.331, clause 5.5.3]

The UE supports measurements using a reporting configuration with the *purpose* set to '*reportCGI*', if the network provides sufficient idle periods.

The UE applies the layer 3 filtering as specified in 5.5.3.2, before using the measured results for evaluation of reporting criteria or for measurement reporting.

The UE shall:

- 1> for each *measId* included in the *measIdList* within *VarMeasConfig*:
 - 2> if a measurement gap configuration is setup; or
 - 2> the UE does not require measurement gaps to perform the concerned measurement:
 - 3> if *s-Measure* is not configured; or
 - 3> if *s-Measure* is configured and the serving cell RSRP, after layer 3 filtering, is lower than this value; or
 - 3> if the *purpose* for the associated *reportConfig* is set to '*reportCGI*':
 - 4> perform the corresponding measurements of neighbouring cells on the frequencies and RATs indicated in the concerned *measObject*;
 - 2> perform the evaluation of reporting criteria as specified in section 5.5.4;
- 1> if a *measId* is configured for which the *purpose* within the associated *reportConfig* is set to '*reportCGI*':
 - 2> if the cell indicated by the *cellForWhichToReportCGI* included in the associated *measObject* is a UTRAN cell:

...

- 3> try to acquire the LAC, the RAC and the list of additional PLMN Identities, if multiple PLMN identities are broadcast in the concerned cell;

...

[TS 36.331, clause 5.5.4.1]

The UE shall:

- 1> for each *measId* included in the *measIdList* within *VarMeasConfig*:
 - 2> if the corresponding *reportConfig* includes a purpose set to '*reportStrongestCellsForSON*':
 - 3> consider any neighbouring cell detected on the associated frequency to be applicable;
 - 2> else if the corresponding *reportConfig* includes a purpose set to '*reportCGI*':
 - 3> consider any neighbouring cell detected on the associated frequency/ set of frequencies (GERAN) which has a physical cell identity matching the value of the *cellForWhichToReportCGI* included in the corresponding *measObject* within the *VarMeasConfig* to be applicable;
 - 2> else:
 - 3> if the corresponding *measObject* concerns E-UTRA:
 - ...
 - 3> else if the corresponding *measObject* concerns UTRA or CDMA2000:
 - 4> consider a neighbouring cell on the associated frequency to be applicable when the concerned cell is included in the *cellsToAddModList* defined within the *VarMeasConfig* for this *measId* (i.e. the cell is included in the white-list);
 - 3> else if the corresponding *measObject* concerns GERAN:
 - ...
 - 2> upon expiry of the periodical reporting timer for this *measId*:
 - 3> initiate the measurement reporting procedure, as specified in 5.5.5;
 - 2> if the *purpose* is included and set to '*reportCGI*' and if the UE acquired the information needed to set all fields of *cgi-Info* for the requested cell:
 - 3> include a measurement reporting entry within the *VarMeasReportList* for this *measId*;
 - 3> set the *numberOfReportsSent* defined within the *VarMeasReportList* for this *measId* to 0;
 - 3> stop timer T321;
 - 3> initiate the measurement reporting procedure, as specified in 5.5.5;
 - 2> upon expiry of the T321 for this *measId*:
 - 3> include a measurement reporting entry within the *VarMeasReportList* for this *measId*;
 - 3> set the *numberOfReportsSent* defined within the *VarMeasReportList* for this *measId* to 0;
 - 3> initiate the measurement reporting procedure, as specified in 5.5.5;

NOTE 2: The UE does not stop the periodical reporting with *triggerType* set to '*event*' or to '*periodical*' while the corresponding measurement is not performed due to the serving cell RSRP being equal to or better than *s-Measure* or due to the measurement gap not being setup.

NOTE 3: If the UE is configured with DRX, the UE may delay the measurement reporting for event triggered and periodical triggered measurements until the Active Time, which is defined in TS 36.321 [6].

[TS 36.331, clause 5.5.5]

For the *measId* for which the measurement reporting procedure was triggered, the UE shall set the *measResults* within the *MeasurementReport* message as follows:

- 1> set the *measId* to the measurement identity that triggered the measurement reporting;
- 1> set the *measResultServCell* to include the quantities of serving cell;
- 1> if there is at least one applicable neighbouring cell to report:
 - 2> set the *measResultNeighCells* to include the best neighbouring cells up to *maxReportCells* in accordance with the following:
 - 3> if the *triggerType* is set to 'event':
 - 4> include the cells included in the *cellsTriggeredList* as defined within the *VarMeasReportList* for this *measId*;
 - 3> else:
 - 4> include the applicable cells for which the new measurement results became available since the last periodical reporting or since the measurement was initiated or reset;

NOTE: The reliability of the report (i.e. the certainty it contains the strongest cells on the concerned frequency) depends on the measurement configuration i.e. the *reportInterval*. The related performance requirements are specified in TS 36.133 [16].

- 3> for each cell that is included in the *measResultNeighCells*, include the *physCellId*;
- 3> if the *triggerType* is set to 'event'; or the *purpose* is set to 'reportStrongestCells' or to 'reportStrongestCellsForSON':
 - 4> for each included cell, include the layer 3 filtered measured results in accordance with the *reportConfig* for this *measId*, ordered as follows:
 - 5> if the *measObject* associated with this *measId* concerns E-UTRA:
 - 6> set the *measResult* to include the quantity(ies) indicated in the *reportQuantity* within the concerned *reportConfig* in order of decreasing *triggerQuantity*, i.e. the best cell is included first;
 - 5> else:
 - 6> set the *measResult* to the quantity as configured for the concerned RAT within the *quantityConfig* in order of decreasing quantity, i.e. the best cell is included first;
 - 3> else if the *purpose* is set to 'reportCGI':
 - 4> if the mandatory present fields of the *cgi-Info* for the cell indicated by the *cellForWhichToReportCGI* in the associated *measObject* have been obtained:
 - 5> include the *cgi-Info* containing all the fields that have been successfully acquired;
- 1> increment the *numberOfReportsSent* as defined within the *VarMeasReportList* for this *measId* by 1;
- 1> stop the periodical reporting timer, if running;
- 1> if the *numberOfReportsSent* as defined within the *VarMeasReportList* for this *measId* is less than the *reportAmount* as defined within the corresponding *reportConfig* for this *measId*:
 - 2> start the periodical reporting timer with the value of *reportInterval* as defined within the corresponding *reportConfig* for this *measId*;
- 1> else:
 - 2> if the *triggerType* is set to 'periodical':
 - 3> remove the entry within the *VarMeasReportList* for this *measId*;

3> remove this *measId* from the *measIdList* within *VarMeasConfig*;

...

8.3.3.2.3 Test description

8.3.3.2.3.1 Pre-test conditions

System Simulator:

- Cell 1 and Cell 5.
- System information combination 4 as defined in TS 36.508 [18] clause 4.4.3.1 is used in E-UTRA cells.

UE:

None.

Preamble:

- The UE is in state Generic RB Established (state 3) on Cell 1 according to [18].

8.3.3.2.3.2 Test procedure sequence

Table 8.3.3.2.3.2-1 illustrates the downlink power levels to be applied for cells at various time instants of the test execution. Row marked "T0" denotes the conditions after the preamble, while row marked "T1" is to be applied subsequently. The exact instants on which these values shall be applied are described in the texts in this clause.

Table 8.3.3.2.3.2-1: Time instance of cell power levels

	Parameter	Unit	Cell 1	Cell 5	Remark
T0	Cell-specific RS EPRE	dBm/15k Hz	-80	-	
	CPICH_Ec	dBm/3.8 4MHz	-	Off	For Cell 5 is a UTRA FDD Cell
	P-CCPCH	dBm/1.2 8 MHz		Off	For Cell 5 is a UTRA TDD Cell
T1	Cell-specific RS EPRE	dBm/15k Hz	-60	-	
	CPICH_Ec	dBm/3.8 4MHz	-	-75	For Cell 5 is a UTRA FFDD Cell
	P-CCPCH	dBm/1.2 8 MHz		-78	For Cell 5 is a UTRA TDD Cell

Table 8.3.3.2.3.2-2: Main behaviour

St	Procedure	Message Sequence		TP	Verdict
		U - S	Message		
1	The SS transmits an <i>RRCCONNECTIONRECONFIGURATION</i> message including <i>measConfig</i> to setup inter RAT measurement for the purpose of SON and set <i>timeAlignmentTimerDedicated</i> to <i>infinity</i> .	<--	<i>RRCCONNECTIONRECONFIGURATION</i>	-	-
2	The UE transmits an <i>RRCCONNECTIONRECONFIGURATIONCOMPLETE</i> message.	-->	<i>RRCCONNECTIONRECONFIGURATIONCOMPLETE</i>	-	-
3	The SS changes Cell 5 power level according to the row "T1" in table 8.3.3.2.3.2-1.	-	-	-	-
4	Check: Does the UE transmit a <i>MEASUREMENTREPORT</i> message to report the measured result for Cell 5?	-->	<i>MEASUREMENTREPORT</i>	1	P
5	The SS transmits an <i>RRCCONNECTIONRECONFIGURATION</i> message including <i>measConfig</i> including <i>reportCGI</i> for Cell 5 and sufficient idle periods for UE to acquire the relevant system information from Cell 5.	<--	<i>RRCCONNECTIONRECONFIGURATION</i>	-	-
6	The UE transmits an <i>RRCCONNECTIONRECONFIGURATIONCOMPLETE</i> message.	-->	<i>RRCCONNECTIONRECONFIGURATIONCOMPLETE</i>	-	-
7	Check: Does the UE transmit a <i>MEASUREMENTREPORT</i> message with <i>cellGlobalId</i> of Cell 5 within 8 sec?	-->	<i>MEASUREMENTREPORT</i>	2	P

8.3.3.2.3.3 Specific message contents

Table 8.3.3.2.3.3-1: SystemInformationBlockType2 for Cell 1 (preamble and all the steps in Table 8.3.3.2.3.2-2)

Derivation Path: 36.508 clause 4.4.3.3-1			
Information Element	Value/remark	Comment	Condition
SystemInformationBlockType2 ::= SEQUENCE {			
RadioResourceConfigCommonSIB-DEFAULT ::= SEQUENCE {			
pcch-Configuration	PCCH-Configuration-LONGCYCLE		
}			
PCCH-Configuration-LONGCYCLE ::= SEQUENCE {			
defaultPagingCycle	rf256		
}			
}			

Table 8.3.3.2.3.3-1A: Master Information Block for Cell 5 (preamble and all the steps in Table 8.3.3.2.3.2-2)

Derivation Path: 34.108 clause 6.1.0a.3			
Information Element	Value/remark	Comment	Condition
MasterInformationBlock ::= SEQUENCE {			
plmn-Type ::= CHOICE {			
gsm-MAP SEQUENCE {			
plmn-Identity SEQUENCE {			
mcc	See Table 8.3.3.2.3.3-1B	(SIZE (3)) OF Digit	
mnc	See Table 8.3.3.2.3.3-1B	(SIZE (2..3)) OF Digit	
}			
}			
}			
v690NonCriticalExtensions SEQUENCE {			
masterInformationBlock-v690ext SEQUENCE {			
multiplePLMN-List SEQUENCE {			
mibPLMN-Identity	TRUE		
multiplePLMNs SEQUENCE (SIZE (1..5)) OF SEQUENCE {	1 entry		
mcc	See Table 8.3.3.2.3.3-1B	(SIZE (3)) OF Digit	
mnc	See Table 8.3.3.2.3.3-1B	(SIZE (2..3)) OF Digit	
}			
}			
}			
}			
}			

The MIB PLMN Identity and PLMN codes broadcasted on the BCCH in Cell 5 shall be configured as defined in the table below.

Cell	MIB PLMN Identity	PLMN Identity		Multiple PLMNs (1)	
		MCC digits	MNC digits	MCC digits	MNC digits
5	TRUE	PLMN 3	PLMN 3	PLMN 2	PLMN 2

Table 8.3.3.2.3.3-1B: PLMN Identity List broadcasted for Cell 5

The definition of each PLMN code is found in table below.

PLMN	MCC digit			MNC digit		
	1	2	3	1	2	3
1	0	0	1	0	1	-
2	0	0	1	0	2	-
3	0	0	1	0	3	-

NOTE: “-“ (dash) denotes “not present”

Table 8.3.3.2.3.3-1C: System Information Block type 1 for Cell 5 (preamble and all the steps in Table 8.3.3.2.3.2-2)

Derivation Path: 34.108 clause 6.1.0b with Condition A1 "UTRAN cell environment"
--

Table 8.3.3.2.3.3-1D: System Information Block type 3 (FDD) for Cell 5 (preamble and all the steps in Table 8.3.3.2.3.2-2)

Derivation Path: 34.108 clause 6.1.0b

Table 8.3.3.2.3.3-2: RRCConnectionReconfiguration (step 1, Table 8.3.3.2.3.2-2)

Derivation Path: 36.508 clause 4.6.1 table 4.6.1-8 with condition MEAS			
Information Element	Value/remark	Comment	Condition
RadioResourceConfigDedicated ::= SEQUENCE {			
srb-ToAddModList	Not present		
drb-ToAddModList	Not present		
drb-ToReleaseList	Not present		
mac-MainConfig CHOICE {			
explicitValue SEQUENCE {			
ul-SCH-Config	Not present		
drx-Config	Not present		
timeAlignmentTimerDedicated	infinity		
phr-Config	Not present		
}			
}			
sps-Config	Not present		
physicalConfigDedicated	Not present		
}			

Table 8.3.3.2.3.3-3 MeasConfig (step 1, Table 8.3.3.2.3.2-2)

Derivation Path: 36.508, Table 4.6.6-1 condition UTRAN			
Information Element	Value/remark	Comment	Condition
MeasConfig ::= SEQUENCE {			
measObjectToAddModList SEQUENCE (SIZE (1..maxObjectId)) OF SEQUENCE {	2 entries		
measObjectId[1]	IdMeasObject-f1		
measObject[1]	MeasObjectEUTRA-GENERIC(f1)		
measObjectId[2]	IdMeasObject-f8		
measObject[2]	MeasObjectUTRA-f8	UTRA frequency	
}			
reportConfigToAddModList SEQUENCE (SIZE (1..maxReportConfigId)) OF SEQUENCE {	1 entry		
reportConfigId[1]	IdReportConfig-P-UTRA		
reportConfig[1]	ReportConfigInterRAT-P-UTRA		
}			
measIdToAddModList SEQUENCE (SIZE (1..maxMeasId)) OF SEQUENCE {	1 entry		
measId[1]	1		
measObjectId[1]	IdMeasObject-f8		
reportConfigId[1]	IdReportConfig-P-UTRA		
}			
quantityConfig SEQUENCE {			
quantityConfigUTRA SEQUENCE {			
measQuantityUTRA-FDD	cpich-RSCP		UTRA-FDD
measQuantityUTRA-TDD	pccpch-RSCP		UTRA-TDD
filterCoefficient	fc0		
}			
}			
}			

Condition	Explanation
UTRA-FDD	UTRA-FDD cell environment
UTRA-TDD	UTRA-TDD cell environment

Table 8.3.3.2.3.3-4 MeasObjectUTRA-f8 (step 1, Table 8.3.3.2.3.2-2)

Derivation path: 36.508 table 4.6.6-3 MeasObjectUTRA-GENERIC(f8)			
Information Element	Value/Remark	Comment	Condition
MeasObjectUTRA-GENERIC(f8) ::= SEQUENCE {			
carrierFreq	UTRA DL carrier frequency of the cell 5		
cellsToAddModList CHOICE {			
cellsToAddModListUTRA-FDD ::= SEQUENCE (SIZE (1.. maxCellMeas)) OF SEQUENCE {			UTRA-FDD
cellIndex [1]	1		
physCellId [1]	physicalCellIdentity – Cell 5		
}			
cellsToAddModListUTRA-TDD ::= SEQUENCE (SIZE (1..maxMeasId)) OF SEQUENCE {			UTRA-TDD
cellIndex [1]	1		
physCellId [1]	physicalCellIdentity – Cell 5		
}			
}			
}			

Condition	Explanation
UTRA-FDD	UTRA-FDD cell environment
UTRA-TDD	UTRA-TDD cell environment

Table 8.3.3.2.3.3-5: ReportConfigInterRAT-P-UTRA (step 1, Table 8.3.2.3.3.2-2)

Derivation Path: 36.508, Table 4.6.6-9 ReportConfigInterRAT-PERIODICAL			
Information Element	Value/remark	Comment	Condition
ReportConfigInterRAT-PERIODICAL ::= SEQUENCE {			
triggerType CHOICE {			
periodical SEQUENCE {			
purpose CHOICE {			
reportStrongestCellsForSON	NULL		
}			
}			
}			
reportAmount	r1		
}			

Table 8.3.3.2.3.3-6 MeasurementReport (step 4, Table 8.3.3.2.3.2-2)

Derivation path: 36.508 4.6.1 table 4.6.1-5			
Information Element	Value/Remark	Comment	Condition
MeasurementReport ::= SEQUENCE {			
criticalExtensions CHOICE {			
c1 CHOICE {			
measurementReport-r8 SEQUENCE {			
measResults SEQUENCE {			
measId	1		
measResultServCell SEQUENCE {		Report Cell 1	
rsrpResult	(0..97)		
rsrqResult	(0..34)		
}			
measResultNeighCells CHOICE {			
measResultListUTRA SEQUENCE (SIZE (1..maxCellReport)) OF SEQUENCE {	1 entry	Report Cell 5	
physCellId	PhysicalCellIdentity of the Cell 5.		
cgi-Info	Not present		
measResult SEQUENCE{			
utra-RSCP	(-5..91)		
}			
}			
}			
}			
}			
}			

Condition	Explanation
UTRA-FDD	UTRA-FDD cell environment
UTRA-TDD	UTRA-TDD cell environment

Table 8.3.3.2.3.3-7: RRCConnectionReconfiguration (step 5, Table 8.3.3.2.3.2-2)

Derivation Path: 36.508 clause 4.6.1 table 4.6.1-8 with condition MEAS			
Information Element	Value/remark	Comment	Condition
RRCConnectionReconfiguration ::= SEQUENCE {			
radioResourceConfiguration	RadioResourceConfigDedicated-DRX		
}			

Table 8.3.3.2.3.3-8 MeasConfig (step 5, Table 8.3.3.2.3.2-2)

Derivation Path: 36.508 clause 4.6.6 table 4.6.6-1			
Information Element	Value/remark	Comment	Condition
MeasConfig ::= SEQUENCE {			
measObjectToAddModList SEQUENCE (SIZE (1..maxObjectId)) OF SEQUENCE {	1 entry		
measObjectId[1]	IdMeasObject-f8		
measObject[1]	MeasObjectUTRA-CGI		
}			
reportConfigToAddModList SEQUENCE (SIZE (1..maxReportConfigId)) OF SEQUENCE {	1 entry		
reportConfigId[1]	ReportConfigId-CGI		
reportConfig[1]	ReportConfigUTRA-CGI		
}			
measIdToAddModList SEQUENCE (SIZE (1..maxMeasId)) OF SEQUENCE {	1 entry		
measId[1]	2		
measObjectId[1]	IdMeasObject-f8		
reportConfigId[1]	ReportConfigId-CGI		
}			
}			

Table 8.3.3.2.3.3-9: MeasObjectUTRA-CGI (step 5, Table 8.3.3.2.3.2-2)

Derivation Path: 36.508 clause 4.6.6 table 4.6.6-3			
Information Element	Value/remark	Comment	Condition
MeasObjectUTRA-CGI ::= SEQUENCE {			
carrierFreq	Downlink UARFCN of f8		
cellForWhichToReportCGI	PhysicalCellIdentity of the Cell 5.		
}			

Table 8.3.3.2.3.3-10: ReportConfigUTRA-CGI (step 5, Table 8.3.3.2.3.2-2)

Derivation Path: 36.508, Table 4.6.6-9 ReportConfigInterRAT-PERIODICAL			
Information Element	Value/remark	Comment	Condition
ReportConfigInterRAT-PERIODICAL ::= SEQUENCE {			
triggerType CHOICE {			
periodical SEQUENCE {			
purpose CHOICE {			
reportCGI	NULL		
}			
}			
}			
reportAmount	r1		
}			

Table 8.3.3.2.3.3-11: RadioResourceConfigDedicated-DRX (step 5, Table 8.3.3.2.3.2-2)

Derivation Path: 36.508 clause 4.6.3.19			
Information Element	Value/remark	Comment	Condition
RadioResourceConfigDedicated-DRX ::= SEQUENCE {			
mac-MainConfig CHOICE {			
explicitValue SEQUENCE {			
ul-SCH-Config SEQUENCE {			
maxHARQ-Tx	n5		
periodicBSR-Timer	infinity		
retxBSR-Timer	sf10240		
ttiBundling	FALSE		
}			
drx-Config CHOICE {			
setup SEQUENCE {			
onDurationTimer	psf6		
drx-InactivityTimer	psf60		
drx-RetransmissionTimer	sf16		
longDRX-CycleStartOffset CHOICE {			
sf2560	4		
}			
shortDRX	Not present		
}			
timeAlignmentTimerDedicated	infinity		
phr-Config CHOICE {			
release	NULL		
}			
}			
}			
physicalConfigDedicated	Not present		
}			

Table 8.3.3.2.3.3-12: *MeasurementReport* (step 7, Table 8.3.3.2.3.2-2)

Derivation path: 36.508 4.6.1 table 4.6.1-5			
Information Element	Value/remark	Comment	Condition
MeasurementReport ::= SEQUENCE {			
criticalExtensions CHOICE {			
c1 CHOICE {			
measurementReport-r8 SEQUENCE {			
measResults ::= SEQUENCE {			
measId	2		
measResultServCell SEQUENCE {		Report Cell 1	
rsrpResult	(0..97)		
rsrqResult	(0..34)		
}			
measResultNeighCells CHOICE {			
measResultListUTRA ::= SEQUENCE (SIZE (1..maxCellReport)) OF SEQUENCE {	1 entry		
physCellId[1]	PhysicalCellIdentity of Cell 5		
cgi-Info[1] SEQUENCE {			
cellGlobalId	cellGlobalId formed from 'PLMN Identity' and 'Cell identity' of Cell 5		
locationAreaCode	locationAreaCode of Cell 5		
routingAreaCode	routingAreaCode of Cell 5		
plmn-IdentityList	'Multiple PLMN List' of Cell 5		
}			
}			
measResult[1] SEQUENCE {			
utra-RSCP	Not Checked		
}			
}			
}			
}			
}			

Condition	Explanation
UTRA-FDD	UTRA-FDD cell environment
UTRA-TDD	UTRA-TDD cell environment

8.3.3.3 Measurement configuration control and reporting / SON / ANR / CGI reporting of GERAN cell

8.3.3.3.1 Test Purpose (TP)

(1)

```
with { UE having completed the radio bearer establishment, initial security activation procedure and
performed the inter RAT measurement for GERAN cell and not detected entering condition for the event
B2 is met }
ensure that {
  when { UE detects entering condition for the event B2 is met }
  then { UE transmits a MeasurementReport }
}
```

(2)

```
with { UE in E-UTRA RRC_CONNECTED state }
ensure that {
  when { UE is commanded to report the global cell identity of the inter-RAT(GERAN) neighbour cell }
```

```

    then { UE determines the global cell identity of the inter-RAT(GERAN) cell included in the
associated measurement object by acquiring the relevant system information from the concerned cell
and reports the global cell identity in the MeasurementReport }
}

```

8.3.3.3.2 Conformance requirements

References: The conformance requirements covered in the current TC are specified in: TS 36.331, clauses 5.3.5.3, 5.5.2.3, 5.5.3, 5.5.4.1 and 5.5.5.

[TS 36.331, clause 5.3.5.3]

If the *RRCConnectionReconfiguration* message does not include the *mobilityControlInfo* and the UE is able to comply with the configuration included in this message, the UE shall:

...

1> if the *RRCConnectionReconfiguration* message includes the *measConfig*:

2> perform the measurement configuration procedure as specified in 5.5.2;

[TS 36.331, clause 5.5.2.3]

The UE shall:

...

2> if the *triggerType* is set to 'periodical' and the *purpose* is set to 'reportCGI' in the *reportConfig* associated with this *measId*:

3> if the *measObject* associated with this *measId* concerns E-UTRA:

4> start timer T321 with the timer value set to 1 second for this *measId*;

3> else:

4> start timer T321 with the timer value set to 8 seconds for this *measId*;

[TS 36.331, clause 5.5.3]

The UE supports measurements using a reporting configuration with the *purpose* set to 'reportCGI', if the network provides sufficient idle periods.

The UE applies the layer 3 filtering as specified in 5.5.3.2, before using the measured results for evaluation of reporting criteria or for measurement reporting.

The UE shall:

1> for each *measId* included in the *measIdList* within *VarMeasConfig*:

2> if a measurement gap configuration is setup; or

2> the UE does not require measurement gaps to perform the concerned measurement:

3> if *s-Measure* is not configured; or

3> if *s-Measure* is configured and the serving cell RSRP, after layer 3 filtering, is lower than this value; or

3> if the *purpose* for the associated *reportConfig* is set to 'reportCGI':

4> perform the corresponding measurements of neighbouring cells on the frequencies and RATs indicated in the concerned *measObject*;

2> perform the evaluation of reporting criteria as specified in section 5.5.4;

1> if a *measId* is configured for which the *purpose* within the associated *reportConfig* is set to 'reportCGI':

- 2> try to acquire the global cell identity of the cell indicated by the *cellForWhichToReportCGI* in the associated *measObject* by acquiring the relevant system information from the concerned cell;
- 2> if the cell indicated by the *cellForWhichToReportCGI* included in the associated *measObject* is an E-UTRAN cell:
 - 3> try to acquire the list of additional PLMN Identities, as included in the *plmn-IdentityList*, if multiple PLMN identities are broadcast in the concerned cell;

NOTE: The 'primary' PLMN is part of the global cell identity.

- 2> if the cell indicated by the *cellForWhichToReportCGI* included in the associated *measObject* is a UTRAN cell:
 - 3> try to acquire the LAC, the RAC and the list of additional PLMN Identities, if multiple PLMN identities are broadcast in the concerned cell;
- 2> if the cell indicated by the *cellForWhichToReportCGI* included in the associated *measObject* is a GERAN cell:
 - 3> try to acquire the RAC in the concerned cell;

[TS 36.331, clause 5.5.4.1]

The UE shall:

- 1> for each *measId* included in the *measIdList* within *VarMeasConfig*:
 - 2> if the corresponding *reportConfig* includes a purpose set to '*reportStrongestCellsForSON*':
 - 3> consider any neighbouring cell detected on the associated frequency to be applicable;
 - 2> else if the corresponding *reportConfig* includes a purpose set to '*reportCGI*':
 - 3> consider any neighbouring cell detected on the associated frequency/ set of frequencies (GERAN) which has a physical cell identity matching the value of the *cellForWhichToReportCGI* included in the corresponding *measObject* within the *VarMeasConfig* to be applicable;
 - 2> else:
 - 3> if the corresponding *measObject* concerns E-UTRA:
 - ...
 - 3> else if the corresponding *measObject* concerns GERAN:
 - 4> consider a neighbouring cell on the associated set of frequencies to be applicable when the concerned cell matches the *ncc-Permitted* defined within the *VarMeasConfig* for this *measId*;
- ...
- 2> upon expiry of the periodical reporting timer for this *measId*:
 - 3> initiate the measurement reporting procedure, as specified in 5.5.5;
- 2> if the *purpose* is included and set to '*reportCGI*' and if the UE acquired the information needed to set all fields of *cgi-Info* for the requested cell:
 - 3> include a measurement reporting entry within the *VarMeasReportList* for this *measId*;
 - 3> set the *numberOfReportsSent* defined within the *VarMeasReportList* for this *measId* to 0;
 - 3> stop timer T321;
 - 3> initiate the measurement reporting procedure, as specified in 5.5.5;
- 2> upon expiry of the T321 for this *measId*:

- 3> include a measurement reporting entry within the *VarMeasReportList* for this *measId*;
- 3> set the *numberOfReportsSent* defined within the *VarMeasReportList* for this *measId* to 0;
- 3> initiate the measurement reporting procedure, as specified in 5.5.5;

NOTE 2: The UE does not stop the periodical reporting with *triggerType* set to 'event' or to 'periodical' while the corresponding measurement is not performed due to the serving cell RSRP being equal to or better than *s-Measure* or due to the measurement gap not being setup.

NOTE 3: If the UE is configured with DRX, the UE may delay the measurement reporting for event triggered and periodical triggered measurements until the Active Time, which is defined in TS 36.321 [6].

[TS 36.331, clause 5.5.5]

For the *measId* for which the measurement reporting procedure was triggered, the UE shall set the *measResults* within the *MeasurementReport* message as follows:

- 1> set the *measId* to the measurement identity that triggered the measurement reporting;
- 1> set the *measResultServCell* to include the quantities of serving cell;
- 1> if there is at least one applicable neighbouring cell to report:
 - 2> set the *measResultNeighCells* to include the best neighbouring cells up to *maxReportCells* in accordance with the following:
 - 3> if the *triggerType* is set to 'event':
 - 4> include the cells included in the *cellsTriggeredList* as defined within the *VarMeasReportList* for this *measId*;
 - 3> else:
 - 4> include the applicable cells for which the new measurement results became available since the last periodical reporting or since the measurement was initiated or reset;

NOTE: The reliability of the report (i.e. the certainty it contains the strongest cells on the concerned frequency) depends on the measurement configuration i.e. the *reportInterval*. The related performance requirements are specified in TS 36.133 [16].

- 3> for each cell that is included in the *measResultNeighCells*, include the *physCellId*;
- 3> if the *triggerType* is set to 'event'; or the *purpose* is set to 'reportStrongestCells' or to 'reportStrongestCellsForSON':
 - 4> for each included cell, include the layer 3 filtered measured results in accordance with the *reportConfig* for this *measId*, ordered as follows:
 - 5> if the *measObject* associated with this *measId* concerns E-UTRA:
 - 6> set the *measResult* to include the quantity(ies) indicated in the *reportQuantity* within the concerned *reportConfig* in order of decreasing *triggerQuantity*, i.e. the best cell is included first;
 - 5> else:
 - 6> set the *measResult* to the quantity as configured for the concerned RAT within the *quantityConfig* in order of decreasing quantity, i.e. the best cell is included first;
 - 3> else if the *purpose* is set to 'reportCGI':
 - 4> if the mandatory present fields of the *cgi-Info* for the cell indicated by the *cellForWhichToReportCGI* in the associated *measObject* have been obtained:
 - 5> include the *cgi-Info* containing all the fields that have been successfully acquired;

- 1> increment the *numberOfReportsSent* as defined within the *VarMeasReportList* for this *measId* by 1;
- 1> stop the periodical reporting timer, if running;
- 1> if the *numberOfReportsSent* as defined within the *VarMeasReportList* for this *measId* is less than the *reportAmount* as defined within the corresponding *reportConfig* for this *measId*:
 - 2> start the periodical reporting timer with the value of *reportInterval* as defined within the corresponding *reportConfig* for this *measId*;
- 1> else:
 - 2> if the *triggerType* is set to 'periodical':
 - 3> remove the entry within the *VarMeasReportList* for this *measId*;
 - 3> remove this *measId* from the *measIdList* within *VarMeasConfig*;
- 1> submit the *MeasurementReport* message to lower layers for transmission, upon which the procedure ends;

8.3.3.3.3 Test description

8.3.3.3.3.1 Pre-test conditions

System Simulator:

- Cell 1 and Cell 24.
- System information combination 5 as defined in TS 36.508 [18] clause 4.4.3.1 is used in E-UTRA cells.

UE:

None.

Preamble:

- The UE is in state Generic RB Established (state 3) on Cell 1 according to [18].

8.3.3.3.3.2 Test procedure sequence

Table 8.3.3.3.3.2-1 illustrates the downlink power levels to be applied for Cell 1 and Cell 24 at various time instants of the test execution. Row marked "T0" denotes the conditions after the preamble, while row marked "T1" is to be applied subsequently. The exact instants on which these values shall be applied are described in the texts in this clause.

Table 8.3.3.3.3.2-1: Time instances of cell power levels

	Parameter	Unit	Cell 1	Cell 24	Remark
T0	Cell-specific RS EPRE	dBm/15k Hz	-60	-	Power levels are shall be such that entry condition for event B2 is not satisfied:
	RSSI	dBm	-	-85	
T1	Cell-specific RS EPRE	dBm/15k Hz	[-80]	-	Power levels are shall be such that entry condition for event B2 is satisfied:
	RSSI	dBm	-	-65	

Table 8.3.3.3.2-2: Main behaviour

St	Procedure	Message Sequence		TP	Verdict
		U - S	Message		
1	The SS transmits an <i>RRCCONNECTIONRECONFIGURATION</i> message including <i>measConfig</i> to setup inter-RAT measurements and reporting for event B2 and set <i>timeAlignmentTimerDedicated</i> to <i>infinity</i> .	<--	<i>RRCCONNECTIONRECONFIGURATION</i>	-	-
2	The UE transmits an <i>RRCCONNECTIONRECONFIGURATIONCOMPLETE</i> message.	-->	<i>RRCCONNECTIONRECONFIGURATIONCOMPLETE</i>	-	-
3	The SS re-adjusts the cell-specific reference signal level according to row "T1" in table 8.3.3.3.2-1.	-	-	-	-
4	Check: Does the UE transmit a <i>MEASUREMENTREPORT</i> message to report event B2 for Cell 24?	-->	<i>MEASUREMENTREPORT</i>	1	P
5	The SS transmits an <i>RRCCONNECTIONRECONFIGURATION</i> message including <i>measConfig</i> including <i>reportCGI</i> for Cell 24 and sufficient idle periods for UE to acquire the relevant system information from Cell 24.	<--	<i>RRCCONNECTIONRECONFIGURATION</i>	-	-
6	The UE transmits an <i>RRCCONNECTIONRECONFIGURATIONCOMPLETE</i> message.	-->	<i>RRCCONNECTIONRECONFIGURATIONCOMPLETE</i>	-	-
7	Check: Does the UE transmit a <i>MEASUREMENTREPORT</i> message with <i>cellGlobalId</i> of Cell 24 within 8 sec?	-->	<i>MEASUREMENTREPORT</i>	2	P

8.3.3.3.3 Specific message contents

Table 8.3.3.3.3-1: *SystemInformationBlockType2* for Cell 1 (preamble and all the steps in Table 8.3.3.3.2-2)

Derivation Path: 36.508 clause 4.4.3.3-1			
Information Element	Value/remark	Comment	Condition
<i>SystemInformationBlockType2</i> ::= SEQUENCE {			
<i>RadioResourceConfigCommonSIB-DEFAULT</i> ::= SEQUENCE {			
<i>pcch-Configuration</i>	<i>PCCH-Configuration-LONGCYCLE</i>		
}			
<i>PCCH-Configuration-LONGCYCLE</i> ::= SEQUENCE {			
<i>defaultPagingCycle</i>	rf256		
}			
}			

Table 8.3.3.3.3-2: RRCConnectionReconfiguration (step 1, Table 8.3.3.3.2-2)

Derivation Path: 36.508 clause 4.6.1 table 4.6.1-8 with condition MEAS			
Information Element	Value/remark	Comment	Condition
RadioResourceConfigDedicated ::= SEQUENCE {			
srb-ToAddModList	Not present		
drb-ToAddModList	Not present		
drb-ToReleaseList	Not present		
mac-MainConfig CHOICE {			
explicitValue SEQUENCE {			
ul-SCH-Config	Not present		
drx-Config	Not present		
timeAlignmentTimerDedicated	infinity		
phr-Config	Not present		
}			
}			
sps-Config	Not present		
physicalConfigDedicated	Not present		
}			

Table 8.3.3.3.3-3: MeasConfig (step 1, Table 8.3.3.3.2-2)

Derivation Path: 36.508, Table 4.6.6-1 with condition GERAN			
Information Element	Value/remark	Comment	Condition
MeasConfig ::= SEQUENCE {			
measObjectToAddModList SEQUENCE (SIZE (1..maxObjectId)) OF SEQUENCE {	2 entries		
measObjectId[1]	IdMeasObject-f1		
measObject[1]	MeasObjectEUTRA- GENERIC(f1)		
measObjectId[2]	IdMeasObject-f11		
measObject[2]	MeasObjectGERAN- GENERIC(f11)		
}			
reportConfigToAddModList SEQUENCE (SIZE (1..maxReportConfigId)) OF SEQUENCE {	1 entry		
reportConfigId[1]	IdReportConfig-B2- GERAN		
reportConfig[1]	ReportConfigInterRAT- B2-GERAN(-69, -79)	EUTRA-Thres = - 69; GERAN-Thres = - 79; threshold-RSRP = EUTRA- Thres+140 = 71; b2- Threshold2GERA N = GERAN- Thres + 110 = 31.	
}			
measIdToAddModList SEQUENCE (SIZE (1..maxMeasId)) OF SEQUENCE {	1 entry		
measId[1]	1		
measObjectId[1]	IdMeasObject-f11		
reportConfigId[1]	IdReportConfig-B2- GERAN		
}			
quantityConfig SEQUENCE {			
quantityConfigGERAN SEQUENCE {			
measQuantityGERAN	rsi		
filterCoefficient	fc0		
}			
}			

Table 8.3.3.3.3-4: MeasObjectGERAN-GENERIC(f11) (step 1, Table 8.3.3.3.2-2)

Derivation Path: 36.508 Table 4.6.6-2A			
Information Element	Value/remark	Comment	Condition
MeasObjectGERAN-GENERIC(Freq) ::= SEQUENCE {			
carrierFreqs SEQUENCE {			
startingARFCN	Same as Cell 24		
bandIndicator	Same as Cell 24		
followingARFCNs CHOICE {			
explicitListOfARFCNs	Same as Cell 24		
}			
}			
ncc-Permitted	'01000000'B		
}			

Table 8.3.3.3.3-5: Void

Table 8.3.3.3.3-6: MeasurementReport (step 4, Table 8.3.3.3.2-2)

Derivation path: 36.508, Table 4.6.1-5			
Information Element	Value/Remark	Comment	Condition
MeasurementReport ::= SEQUENCE {			
criticalExtensions CHOICE {			
c1 CHOICE {			
measurementReport-r8 SEQUENCE {			
measResults SEQUENCE {			
measId	1		
measResultServCell SEQUENCE {		Report Cell 1	
rsrpResult	(0..97)		
rsrqResult	(0..34)		
}			
measResultNeighCells CHOICE {			
measResultListGERAN SEQUENCE (SIZE (1..maxCellReport)) OF SEQUENCE {	1 entry	Report Cell 24	
carrierFreq[1] SEQUENCE {		CarrierFreq of Cell 24	
arfcn	Downlink arfcn of Cell 24		
bandIndicator	Same bandindicator as Cell 24		
}			
physCellId[1]	PhysicalCellIdentity of Cell 24.		
cgi-info[1]	Not present		
measResult[1] SEQUENCE{			
rssi	(0..63)		
}			
}			
}			
}			
}			
}			

Table 8.3.3.3.3-7: RRCConnectionReconfiguration (step 5, Table 8.3.3.3.2-2)

Derivation Path: 36.508 clause 4.6.1 table 4.6.1-8 with condition MEAS			
Information Element	Value/remark	Comment	Condition
RRCConnectionReconfiguration ::= SEQUENCE {			
radioResourceConfigDedicated	RadioResourceConfigDe dedicated-DRX		
}			

Table 8.3.3.3.3-8: MeasConfig (step 5, Table 8.3.3.3.2-2)

Derivation Path: 36.508 clause 4.6.6 table 4.6.6-1			
Information Element	Value/remark	Comment	Condition
MeasConfig ::= SEQUENCE {			
measObjectToAddModList ::= SEQUENCE (SIZE (1..maxObjectId)) OF SEQUENCE {	1 entry		
measObjectId[1]	IdMeasObject-f11		
measObject[1] CHOICE {			
measObjectGERAN	MeasObjectGERAN-CGI		
}			
reportConfigToRemoveList ::= SEQUENCE (SIZE (1..maxReportConfigId)) OF SEQUENCE {	1 entry		
reportConfigId[1]	IdReportConfig-B2- GERAN		
}			
reportConfigToAddModList ::= SEQUENCE (SIZE (1..maxReportConfigId)) OF SEQUENCE {	1 entry		
reportConfigId[1]	ReportConfigId-CGI		
reportConfig[1] CHOICE {			
reportConfigGERAN	ReportConfigGERAN- CGI		
}			
measIdToAddModList ::= SEQUENCE (SIZE (1..maxMeasId)) OF SEQUENCE {	1 entry		
measId[1]	2		
measObjectId[1]	IdMeasObject-f11		
reportConfigId[1]	ReportConfigId-CGI		
}			
}			

Table 8.3.3.3.3-9: MeasObjectGERAN-CGI (step 5, Table 8.3.3.3.2-2)

Derivation Path: 36.308, Table 4.6.6-2A			
Information Element	Value/remark	Comment	Condition
MeasObjectGERAN-GENERIC(Freq) ::= SEQUENCE {			
carrierFreqs SEQUENCE {			
startingARFCN	Same as Cell 24		
bandIndicator	Same as Cell 24		
followingARFCNs CHOICE {			
explicitListOfARFCNs	Same as Cell 24		
}			
}			
offsetFreq	Not present		
ncc-Permitted	'01000000'B		
cellForWhichToReportCGI	PhysicalCellIdentity of Cell 24.		
}			

Table 8.3.3.3.3-10: ReportConfigGERAN-CGI (step 5, Table 8.3.3.3.2-2)

Derivation Path: 36.508, Table 4.6.6-9			
Information Element	Value/remark	Comment	Condition
ReportConfigInterRAT ::= SEQUENCE {			
triggerType CHOICE {			
periodical SEQUENCE {			
purpose CHOICE {			
reportCGI	NULL		
}			
}			
}			
reportAmount	r1		
}			

Table 8.3.3.3.3-11: RadioResourceConfigDedicated-DRX (step 5, Table 8.3.3.3.2-2)

Derivation Path: 36.508 clause 4.6.3.19			
Information Element	Value/remark	Comment	Condition
RadioResourceConfigDedicated-DRX ::= SEQUENCE {			
mac-MainConfig CHOICE {			
explicitValue SEQUENCE {			
ul-SCH-Config SEQUENCE {			
maxHARQ-Tx	n5		
periodicBSR-Timer	infinity		
retxBSR-Timer	sf10240		
ttiBundling	FALSE		
}			
drx-Config CHOICE {			
setup SEQUENCE {			
onDurationTimer	psf6		
drx-InactivityTimer	psf60		
drx-RetransmissionTimer	sf16		
longDRX-CycleStartOffset CHOICE {			
sf2560	4		
}			
shortDRX	Not present		
}			
timeAlignmentTimerDedicated	infinity		
phr-Config CHOICE {			
release	NULL		
}			
physicalConfigDedicated	Not present		
}			

Table 8.3.3.3.3-12: *MeasurementReport* (step 7, Table 8.3.3.3.3-2)

Derivation path: 36.508 4.6.1 table 4.6.1-5			
Information Element	Value/remark	Comment	Condition
MeasurementReport ::= SEQUENCE {			
criticalExtensions CHOICE {			
c1 CHOICE {			
measurementReport-r8 SEQUENCE {			
measResults SEQUENCE {			
measId	2		
measResultServCell SEQUENCE {		Report Cell 1	
rsrpResult	(0..97)		
rsrqResult	(0..34)		
}			
measResultNeighCells CHOICE {			
measResultListGERAN ::= SEQUENCE (SIZE (1..maxCellReport)) OF SEQUENCE {	1 entry	Report Cell 24	
carrierFreq[1] SEQUENCE {		CarrierFreq of Cell 24	
arcfn	Downlink arcfn of Cell 24		
bandIndicator	Same bandIndicator as Cell 24		
}			
physCellId[1]	PhysicalCellId of Cell 24		
cgi-Info[1] SEQUENCE {			
cellGlobalId SEQUENCE {		CellGlobalId of Cell 24	
plmn-Identity	PLMN Identity of Cell 24		
locationAreaCode	Location Area Code of Cell 24		
cellIdentity	Cell Identity of Cell 24		
}			
routingAreaCode	Routing Area Code of Cell 24		
}			
measResult[1] SEQUENCE {			
rssi	(0..63)		
}			
}			
}			
}			
}			

8.3.3.4 Measurement configuration control and reporting / SON / ANR / CGI reporting of HRPD cell

8.3.3.4.1 Test Purpose (TP)

(1)

```
with { UE in E-UTRA RRC_CONNECTED state }
ensure that {
  when { UE detects that entering conditions for event B2 are met }
  then { UE sends MeasurementReport for event B2 }
}
```

(2)

```
with { UE in E-UTRA RRC_CONNECTED state }
ensure that {
  when { UE is commanded to report the global cell identity of the
        neighbour cell }
  then { UE determines the global cell identity of the cell included
}
```



```

    in the associated measurement object by acquiring the
    relevant system information from the concerned cell and
    reports the global cell identity in the MeasurementReport}
}

```

8.3.3.4.2 Conformance requirements

References: The conformance requirements covered in the present TC are specified in: TS 36.331, clauses 5.3.5.3, 5.5.2.3, 5.5.3.1, 5.5.4.1, 5.5.4.8, 5.5.5.

[TS 36.331, clause 5.3.5.3]

If the *RRCConnectionReconfiguration* message does not include the *mobilityControlInfo* and the UE is able to comply with the configuration included in this message, the UE shall:

- 1> if the *RRCConnectionReconfiguration* message includes the *measConfig*:
- 2> perform the measurement configuration procedure as specified in 5.5.2;

[TS 36.331, clause 5.5.2.3]

The UE shall:

- 1> for each *measId* included in the received *measIdToAddModList*:
 - 2> if the *triggerType* is set to 'periodical' and the *purpose* is set to 'reportCGI' in the *reportConfig* associated with this *measId*:
 - 3> if the *measObject* associated with this *measId* concerns E-UTRA:
 - 4> start timer T321 with the timer value set to 1 second for this *measId*;
 - 3> else:
 - 4> start timer T321 with the timer value set to 8 seconds for this *measId*;

[TS 36.331, clause 5.5.3.1]

The UE supports measurements using a reporting configuration with the *purpose* set to 'reportCGI', if the network provides sufficient idle periods.

The UE applies the layer 3 filtering as specified in 5.5.3.2, before using the measured results for evaluation of reporting criteria or for measurement reporting.

The UE shall:

- 1> for each *measId* included in the *measIdList* within *VarMeasConfig*:
 - 2> if a measurement gap configuration is setup; or
 - 2> the UE does not require measurement gaps to perform the concerned measurement:
 - 3> if *s-Measure* is not configured; or
 - 3> if *s-Measure* is configured and the serving cell RSRP, after layer 3 filtering, is lower than this value; or
 - 3> if the *purpose* for the associated *reportConfig* is set to 'reportCGI':
 - 4> perform the corresponding measurements of neighbouring cells on the frequencies and RATs indicated in the concerned *measObject*;
 - 2> perform the evaluation of reporting criteria as specified in section 5.5.4;
- 1> if a *measId* is configured for which the *purpose* within the associated *reportConfig* is set to 'reportCGI':
 - 2> try to acquire the global cell identity of the cell indicated by the *cellForWhichToReportCGI* in the associated *measObject* by acquiring the relevant system information from the concerned cell;

- 2> if the cell indicated by the *cellForWhichToReportCGI* included in the associated *measObject* is an E-UTRAN cell:
 - 3> try to acquire the list of additional PLMN Identities, as included in the *plmn-IdentityList*, if multiple PLMN identities are broadcast in the concerned cell;

NOTE: The 'primary' PLMN is part of the global cell identity.

- 2> if the cell indicated by the *cellForWhichToReportCGI* included in the associated *measObject* is a UTRAN cell:
 - 3> try to acquire the LAC, the RAC and the list of additional PLMN Identities, if multiple PLMN identities are broadcast in the concerned cell;
- 2> if the cell indicated by the *cellForWhichToReportCGI* included in the associated *measObject* is a GERAN cell:
 - 3> try to acquire the RAC in the concerned cell;
- 2> if the cell indicated by the *cellForWhichToReportCGI* included in the associated *measObject* is a CDMA2000 cell and the *cdma2000-Type* included in the *measObject* is 'typeHRPD':
 - 3> try to acquire the Sector ID in the concerned cell;

[TS 36.331, clause 5.5.4.1]

The UE shall:

- 1> for each *measId* included in the *measIdList* within *VarMeasConfig*:
 - 2> if the corresponding *reportConfig* includes a purpose set to 'reportStrongestCellsForSON':
 - 3> consider any neighbouring cell detected on the associated frequency to be applicable;
 - 2> else if the corresponding *reportConfig* includes a purpose set to 'reportCGI':
 - 3> consider any neighbouring cell detected on the associated frequency/ set of frequencies (GERAN) which has a physical cell identity matching the value of the *cellForWhichToReportCGI* included in the corresponding *measObject* within the *VarMeasConfig* to be applicable;
 - 2> else:
 - 3> if the corresponding *measObject* concerns E-UTRA:
 - 4> consider any neighbouring cell detected on the associated frequency to be applicable when the concerned cell is not included in the *blackCellsToAddModList* defined within the *VarMeasConfig* for this *measId*;
 - 3> else if the corresponding *measObject* concerns UTRA or CDMA2000:
 - 4> consider a neighbouring cell on the associated frequency to be applicable when the concerned cell is included in the *cellsToAddModList* defined within the *VarMeasConfig* for this *measId* (i.e. the cell is included in the white-list);
 - 3> else if the corresponding *measObject* concerns GERAN:
 - 4> consider a neighbouring cell on the associated set of frequencies to be applicable when the concerned cell matches the *ncc-Permitted* defined within the *VarMeasConfig* for this *measId*;
 - 2> if the *triggerType* is set to 'event' and if the entry condition applicable for this event, i.e. the event corresponding with the *eventId* of the corresponding *reportConfig* within *VarMeasConfig*, is fulfilled for one or more applicable cells for all measurements after layer 3 filtering taken during *timeToTrigger* defined for this event within the *VarMeasConfig*, while the *VarMeasReportList* does not include an measurement reporting entry for this *measId* (a first cell triggers the event):
 - 3> include a measurement reporting entry within the *VarMeasReportList* for this *measId*;

- 3> set the *numberOfReportsSent* defined within the *VarMeasReportList* for this *measId* to 0;
 - 3> include the concerned cell(s) in the *cellsTriggeredList* defined within the *VarMeasReportList* for this *measId*;
 - 3> initiate the measurement reporting procedure, as specified in 5.5.5;
 - 2> if the *triggerType* is set to 'event' and if the entry condition applicable for this event, i.e. the event corresponding with the *eventId* of the corresponding *reportConfig* within *VarMeasConfig*, is fulfilled for one or more applicable cells not included in the *cellsTriggeredList* for all measurements after layer 3 filtering taken during *timeToTrigger* defined for this event within the *VarMeasConfig* (a subsequent cell triggers the event):
 - 3> set the *numberOfReportsSent* defined within the *VarMeasReportList* for this *measId* to 0;
 - 3> include the concerned cell(s) in the *cellsTriggeredList* defined within the *VarMeasReportList* for this *measId*;
 - 3> initiate the measurement reporting procedure, as specified in 5.5.5;
 - 2> if the *triggerType* is set to 'event' and if the leaving condition applicable for this event is fulfilled for one or more of the cells included in the *cellsTriggeredList* defined within the *VarMeasReportList* for this *measId* for all measurements after layer 3 filtering taken during *timeToTrigger* defined within the *VarMeasConfig* for this event:
 - 3> remove the concerned cell(s) in the *cellsTriggeredList* defined within the *VarMeasReportList* for this *measId*;
 - 3> if *reportOnLeave* is set to *TRUE* for the corresponding reporting configuration:
 - 4> initiate the measurement reporting procedure, as specified in 5.5.5;
 - 3> if the *cellsTriggeredList* defined within the *VarMeasReportList* for this *measId* is empty:
 - 4> remove the measurement reporting entry within the *VarMeasReportList* for this *measId*;
 - 4> stop the periodical reporting timer for this *measId*, if running;
 - 2> if the *purpose* is included and set to 'reportStrongestCells' or to 'reportStrongestCellsForSON' and if a (first) measurement result is available for one or more applicable cells:
 - 3> include a measurement reporting entry within the *VarMeasReportList* for this *measId*;
 - 3> set the *numberOfReportsSent* defined within the *VarMeasReportList* for this *measId* to 0;
 - 3> initiate the measurement reporting procedure, as specified in 5.5.5;
- NOTE 1: If the *purpose* is set to 'reportStrongestCells', the UE initiates a first measurement report immediately after the quantity to be reported becomes available for at least either serving cell or one of the applicable cells. If the *purpose* is set to 'reportStrongestCellsForSON', the UE initiates a first measurement report when it has determined the strongest cells on the associated frequency.
- 2> upon expiry of the periodical reporting timer for this *measId*:
 - 3> initiate the measurement reporting procedure, as specified in 5.5.5;
 - 2> if the *purpose* is included and set to 'reportCGI' and if the UE acquired the information needed to set all fields of *cgi-Info* for the requested cell:
 - 3> include a measurement reporting entry within the *VarMeasReportList* for this *measId*;
 - 3> set the *numberOfReportsSent* defined within the *VarMeasReportList* for this *measId* to 0;
 - 3> stop timer T321;
 - 3> initiate the measurement reporting procedure, as specified in 5.5.5;

- 2> upon expiry of the T321 for this *measId*:
- 3> include a measurement reporting entry within the *VarMeasReportList* for this *measId*;
- 3> set the *numberOfReportsSent* defined within the *VarMeasReportList* for this *measId* to 0;
- 3> initiate the measurement reporting procedure, as specified in 5.5.5;

NOTE 2: The UE does not stop the periodical reporting with *triggerType* set to 'event' or to 'periodical' while the corresponding measurement is not performed due to the serving cell RSRP being equal to or better than *s-Measure* or due to the measurement gap not being setup.

[TS 36.331, clause 5.5.4.8]

The UE shall:

- 1> for UTRA and CDMA2000, only trigger the event for cells included in the corresponding measurement object;
- 1> consider the entering condition for this event to be satisfied when both condition B2-1 and condition B2-2, as specified below, are fulfilled apply inequality B2-1 and inequality B2-2 i.e. both have to be fulfilled, as specified below, as the entry condition for this event;
- 1> consider the leaving condition for this event to be satisfied when condition B2-3 or condition B2-4, i.e. at least one of the two, as specified below, is fulfilled apply inequality B3-3 and inequality B2-4 i.e. at least one of the two has to be fulfilled, as specified below, as the leaving condition for this event;

Inequality B2-1 (Entering condition 1)

$$M_s + H_{ys} < Thresh1$$

Inequality B2-2 (Entering condition 2)

$$M_n + Ofn - H_{ys} > Thresh2$$

Inequality B2-3 (Leaving condition 1)

$$M_s - H_{ys} > Thresh1$$

Inequality B2-4 (Leaving condition 2)

$$M_n + Ofn + H_{ys} < Thresh2$$

The variables in the formula are defined as follows:

M_s is the measurement result of the serving cell, not taking into account any cell individual offsets.

M_n is the measurement result of the inter-RAT neighbour cell, not taking into account any offsets neighbouring inter RAT cell.

Ofn is the frequency specific offset of the frequency of the inter-RAT neighbour cell (i.e. *offsetFreq* as defined within the *measObject* corresponding to the frequency of the inter-RAT neighbour cell)neighbour cell.

H_{ys} is the hysteresis parameter for this event (i.e. *hysteresis* as defined within *reportConfigInterRAT* the *VarMeasurementConfiguration* for this event).

Thresh1 is the threshold parameter for this event (i.e. *b2-Threshold1* as defined within *reportConfigInterRAT* the *VarMeasurementConfiguration* for this event).

Thresh2 is the threshold parameter for this event (i.e. *b2-Threshold2* as defined within *reportConfigInterRAT* the *VarMeasurementConfiguration* for this event).

M_s is expressed in dBm in case of RSRP, or in dB in case of RSRQ.

M_n is expressed in dBm or dB, depending on the measurement quantity of the inter-RAT neighbouring inter RAT cell.

Ofn, ***H_{ys}*** are expressed in dB.

Thresh1 is expressed in the same unit as *MndBm* in case *Ms* is expressed in dBm; otherwise it is expressed in dB.

Thresh2 is expressed in the same unit as *MndBm* in case *Mn* is expressed in dBm; otherwise it is expressed in dB.

[TS 36.331, clause 5.5.5]

The purpose of this procedure is to transfer measurement results from the UE to E-UTRAN.

For the *measId* for which the measurement reporting procedure was triggered, the UE shall set the *measResults* within the *MeasurementReport* message as follows:

- 1> set the *measId* to the measurement identity that triggered the measurement reporting;
 - 1> set the *measResultServCell* to include the quantities of serving cell;
 - 1> if there is at least one applicable neighbouring cell to report:
 - 2> set the *measResultNeighCells* to include the best neighbouring cells up to *maxReportCells* in accordance with the following:
 - 3> if the *triggerType* is set to 'event':
 - 4> include the cells included in the *cellsTriggeredList* as defined within the *VarMeasReportList* for this *measId*;
 - 3> else:
 - 4> include the applicable cells for which the new measurement results became available since the last periodical reporting or since the measurement was initiated or reset;
- NOTE: The reliability of the report (i.e. the certainty it contains the strongest cells on the concerned frequency) depends on the measurement configuration i.e. the *reportInterval*. The related performance requirements are specified in TS 36.133 [16].
- 3> for each cell that is included in the *measResultNeighCells*, include the *physCellId*;
 - 3> if the *triggerType* is set to 'event'; or the *purpose* is set to 'reportStrongestCells' or to 'reportStrongestCellsForSON':
 - 4> for each included cell, include the layer 3 filtered measured results in accordance with the *reportConfig* for this *measId*, ordered as follows:
 - 5> if the *measObject* associated with this *measId* concerns E-UTRA:
 - 6> set the *measResult* to include the quantity(ies) indicated in the *reportQuantity* within the concerned *reportConfig* in order of decreasing *triggerQuantity*, i.e. the best cell is included first;
 - 5> else:
 - 6> set the *measResult* to the quantity as configured for the concerned RAT within the *quantityConfig* in order of decreasing quantity, i.e. the best cell is included first;
 - 3> else if the *purpose* is set to 'reportCGI':
 - 4> if the mandatory present fields of the *cgi-Info* for the cell indicated by the *cellForWhichToReportCGI* in the associated *measObject* have been obtained:
 - 5> include the *cgi-Info* containing all the fields that have been successfully acquired;
 - 1> increment the *numberOfReportsSent* as defined within the *VarMeasReportList* for this *measId* by 1;
 - 1> stop the periodical reporting timer, if running;
 - 1> if the *numberOfReportsSent* as defined within the *VarMeasReportList* for this *measId* is less than the *reportAmount* as defined within the corresponding *reportConfig* for this *measId*:

2> start the periodical reporting timer with the value of *reportInterval* as defined within the corresponding *reportConfig* for this *measId*;

1> else:

2> if the *triggerType* is set to 'periodical':

3> remove the entry within the *VarMeasReportList* for this *measId*;

3> remove this *measId* from the *measIdList* within *VarMeasConfig*;

1> if the measured results are for CDMA2000 HRPD:

2> set the *preRegistrationStatusHRPD* to the UE's CDMA2000 upper layer's HRPD *preRegistrationStatus*;

1> submit the *MeasurementReport* message to lower layers for transmission, upon which the procedure ends;

8.3.3.4.3 Test description

8.3.3.4.3.1 Pre-test conditions

System Simulator:

- Cell 1 and Cell 15
- System information combination 6 as defined in TS 36.508 [18] clause 4.4.3.1 is used in E-UTRA cells.

Preamble:

- The UE is in state Generic RB Established (state 3) on Cell 1 according to [18].

UE:

None.

8.3.3.4.3.2 Test procedure sequence

Table 8.3.3.4.3.2-1 illustrates the downlink power levels to be applied for Cell 1 and Cell 15 at various time instants of the test execution. Row marked "T0" denotes the conditions after the preamble, while row marked "T1" is to be applied subsequently. The exact instants on which these values shall be applied are described in the texts in this clause.

Table 8.3.3.4.3.2-1: Time instances of cell power level and parameter changes

	Parameter	Unit	Cell 1	Cell 15	Remark
T0	Cell-specific RS EPRE	dBm/15kHz	-60	-	The power level values are such that entering conditions for event B2 are not satisfied: Inequality B2-1 (Entering condition 1) $Ms + Hys > Thresh1$ Inequality B2-2 (Entering condition 2) $Mn + Ofn - Hys < Thresh2$
	Δ lor/loc	dB	-	-20	
	loc	dBm/1.23MHz	-	-55	
	Pilot_Ec/Io (Note 1)	dB	-	-20	
T1	Cell-specific RS EPRE	dBm/15kHz	-80	-	The power level values are such that entering conditions for event B2 are satisfied: Inequality B2-1 (Entering condition 1) $Ms + Hys < Thresh1$ Inequality B2-2 (Entering condition 2) $Mn + Ofn - Hys > Thresh2$
	Δ lor/loc	dB	-	-5	
	loc	dBm/1.23MHz	-	-55	
	Pilot_Ec/Io (Note 1)	dB	-	-6	
Note 1: This parameter is not directly settable, but is derived by calculation from the other parameters set by the SS					

Table 8.3.3.4.3.2-2: Main behaviour

St	Procedure	Message Sequence		TP	Verdict
		U - S	Message		
1	The SS transmits an <i>RRCCONNECTIONRECONFIGURATION</i> message including <i>measConfig</i> to setup inter RAT measurement and reporting for event B2 and set <i>timeAlignmentTimerDedicated</i> to <i>infinity</i> .	<--	<i>RRCCONNECTIONRECONFIGURATION</i>	-	-
2	The UE transmits an <i>RRCCONNECTIONRECONFIGURATIONCOMPLETE</i> message.	-->	<i>RRCCONNECTIONRECONFIGURATIONCOMPLETE</i>	-	-
3	The SS re-adjusts the cell-specific reference signal level according to row "T1" in table 8.3.3.4.3.2-1.	-	-	-	-
4	Check: Does the UE transmit a <i>MEASUREMENTREPORT</i> message to report event B2 on Cell 15?	-->	<i>MEASUREMENTREPORT</i>	1	P
5	The SS transmits an <i>RRCCONNECTIONRECONFIGURATION</i> message including <i>measConfig</i> including <i>reportCGI</i> for Cell 15 and sufficient idle periods for UE to acquire the relevant system information from Cell 15.	<--	<i>RRCCONNECTIONRECONFIGURATION</i>	-	-
6	The UE transmits an <i>RRCCONNECTIONRECONFIGURATIONCOMPLETE</i> message.	-->	<i>RRCCONNECTIONRECONFIGURATIONCOMPLETE</i>	-	-
7	Check: Does the UE transmit a <i>MEASUREMENTREPORT</i> message with <i>cellGlobalId</i> of Cell 15 within 8 sec?	-->	<i>MEASUREMENTREPORT</i>	2	P

8.3.3.4.3.3 Specific message contents

Table 8.3.3.4.3.3-1: SystemInformationBlockType2 for Cell 1 (preamble and all the steps in Table 8.3.3.4.3.2-2)

Derivation Path: TS 36.508 clause 4.4.3.3-1			
Information Element	Value/remark	Comment	Condition
SystemInformationBlockType2 ::= SEQUENCE {			
RadioResourceConfigCommonSIB-DEFAULT ::= SEQUENCE {			
pcch-Config	PCCH-Config-LONGCYCLE		
}			
PCCH-Config-LONGCYCLE ::= SEQUENCE {			
defaultPagingCycle	rf256		
nB	oneT		
}			
}			

Table 8.3.3.4.3.3-2: RRCConnectionReconfiguration (step 1, Table 8.3.3.4.3.2-2)

Derivation Path: 36.508 clause 4.6.1 table 4.6.1-8 with condition MEAS			
Information Element	Value/remark	Comment	Condition
RadioResourceConfigDedicated ::= SEQUENCE {			
srb-ToAddModList	Not present		
drb-ToAddModList	Not present		
drb-ToReleaseList	Not present		
mac-MainConfig CHOICE {			
explicitValue SEQUENCE {			
ul-SCH-Config	Not present		
drx-Config	Not present		
timeAlignmentTimerDedicated	infinity		
phr-Config	Not present		
}			
}			
sps-Config	Not present		
physicalConfigDedicated	Not present		
}			

Table 8.3.3.4.3.3-3: MeasConfig (step 1, Table 8.3.3.4.3.2-2)

Derivation Path: 36.508, Table 4.6.6-1			
Information Element	Value/remark	Comment	Condition
MeasConfig ::= SEQUENCE {			
measObjectToAddModList SEQUENCE (SIZE (1..maxObjectId)) OF SEQUENCE {	2 entries		
measObjectId[1]	IdMeasObject-f1		
measObject[1]	MeasObjectEUTRA-GENERIC(f1)		
measObjectId[2]	IdMeasObject-f14		
measObject[2]	MeasObjectCDMA2000-GENERIC		
}			
reportConfigToAddModList SEQUENCE (SIZE (1..maxReportConfigId)) OF SEQUENCE {	1 entry		
reportConfigId[1]	IdReportConfig-B2-CDMA2000		
reportConfig[1]	ReportConfigInterRAT-B2-CDMA2000(-69, -18)		
}			
measIdToAddModList SEQUENCE (SIZE (1..maxMeasId)) OF SEQUENCE {	1 entry		
measId[1]	1		
measObjectId[1]	IdMeasObject-f14		
reportConfigId[1]	IdReportConfig-B2-CDMA2000		
}			
quantityConfig SEQUENCE {			
quantityConfigCDMA2000 SEQUENCE {			
measQuantityCDMA2000	pilotStrength		
}			
}			
measGapConfig CHOICE {			
setup SEQUENCE {			
gapOffset CHOICE {			
gp1	30		
}			
}			
}			
}			

Table 8.3.3.4.3.3-7 MeasConfig (step 5, Table 8.3.3.4.3.2-2)

Derivation Path: TS 36.508 clause 4.6.6 table 4.6.6-1			
Information Element	Value/remark	Comment	Condition
MeasConfig ::= SEQUENCE {			
measIdToAddModList ::= SEQUENCE (SIZE (1..maxMeasId)) OF SEQUENCE {	1 entry		
measId[1]	2		
measObjectId[1]	IdMeasObject-f14		
reportConfigId[1]	ReportConfigId-CGI		
}			
measObjectToAddModList ::= SEQUENCE (SIZE (1..maxObjectId)) OF SEQUENCE {	1 entry		
measObjectId[1]	IdMeasObject-f14		
measObject[1]	MeasObjectCDMA2000-CGI		
}			
reportConfigToRemoveList ::= SEQUENCE (SIZE (1..maxReportConfigId)) OF SEQUENCE {			
reportConfigId	IdReportConfig-B2		
}			
reportConfigToAddModList ::= SEQUENCE (SIZE (1..maxReportConfigId)) OF SEQUENCE {	1 entry		
reportConfigId[1]	ReportConfigId-CGI		
reportConfig[1]	ReportConfigCDMA2000-CGI		
}			
}			

Table 8.3.3.4.3.3-7A: MeasObjectCDMA2000-CGI (step 5, Table 8.3.3.4.3.2-2)

Derivation Path: TS 36.508, Table 4.6.6-1C			
Information Element	Value/remark	Comment	Condition
MeasObjectCDMA2000-GENERIC ::= SEQUENCE {			
cdma2000-Type	TypeHRPD		
carrierFreq SEQUENCE {			
bandClass	Band Class of frequency under test		
arfcn	f14		
}			
searchWindowSize	15		
cellForWhichToReportCGI	PhysicalCellIdentity of Cell 15		
}			

Table 8.3.3.4.3.3-8: ReportConfigCDMA2000-CGI (step 5, Table 8.3.3.4.3.2-2)

Derivation Path: 36.508, Table 4.6.6-9 ReportConfigInterRAT-PERIODICAL			
Information Element	Value/remark	Comment	Condition
ReportConfigInterRAT-PERIODICAL ::= SEQUENCE {			
triggerType CHOICE {			
periodical SEQUENCE {			
purpose CHOICE {			
reportCGI	NULL		
}			
}			
}			
reportAmount	r1		
}			

Table 8.3.3.4.3.3-9: RadioResourceConfigDedicated-DRX (step 5, Table 8.3.3.4.3.2-2)

Derivation Path: TS 36.508 clause 4.6.3.19			
Information Element	Value/remark	Comment	Condition
RadioResourceConfigDedicated-DRX ::= SEQUENCE {			
mac-MainConfig CHOICE {			
explicitValue SEQUENCE {			
ul-SCH-Config SEQUENCE {			
maxHARQ-Tx	n5		
periodicBSR-Timer	infinity		
retxBSR-Timer	sf10240		
ttiBundling	FALSE		
}			
drx-Config CHOICE {			
setup SEQUENCE {			
onDurationTimer	psf6		
drx-InactivityTimer	psf60		
drx-RetransmissionTimer	sf16		
longDRX-CycleStartOffset CHOICE {			
sf2560	0		
}			
shortDRX	Not present		
}			
timeAlignmentTimerDedicated	infinity		
phr-Config CHOICE {			
release	NULL		
}			
}			
}			
physicalConfigDedicated	Not present		
}			

Table 8.3.3.4.3.3-10: *MeasurementReport* (step 7, Table 8.3.3.4.3.2-2)

Derivation path: TS 36.508 4.6.1 table 4.6.1-5			
Information Element	Value/remark	Comment	Condition
MeasurementReport ::= SEQUENCE {			
criticalExtensions CHOICE {			
c1 CHOICE{			
measurementReport-r8 SEQUENCE {			
measuredResults SEQUENCE {			
measId	2		
measResultServing SEQUENCE {		Report Cell 15	
rsrpResult	(0..97)		
rsrqResult	(0..34)		
}			
measResultNeighCells CHOICE {			
measResultsCDMA2000 SEQUENCE {			
preRegistrationStatusHRPD	FALSE		
measResultListCDMA2000 SEQUENCE	1 entry		
(SIZE (1..maxCellReport)) OF SEQUENCE {			
physCellId[1]	PhysicalCellId of Cell 15		
cgi-Info[1] CHOICE {			
cellGlobalIdHRPD	cellGlobalId of Cell 15		
}			
measResult[1] SEQUENCE {			
pilotStrength	(0..63)		
}			
}			
}			
}			
}			
}			
}			

8.3.3.5 Void

8.3.4 Measurement for CSG, Hybrid and Open cells

8.3.4.1 Intra-frequency SI acquisition / CSG cell and non-CSG cell

8.3.4.1.1 Test Purpose (TP)

(1)

```
with { UE in E-UTRA RRC_CONNECTED state }
ensure that {
  when { UE is configured to acquire the System Information of a neighbour member CSG cell }
  then { UE acquires the System Information of the cell included in the associated measurement
object and reports the global cell identity, the TAI, the CSG ID and its membership status in the
MeasurementReport }
}
```

(2)

```
with { UE in E-UTRA RRC_CONNECTED state }
ensure that {
  when { UE is configured to acquire the System Information of a neighbour non-member CSG cell }
  then { UE acquires the System Information of the cell included in the associated measurement
object and reports the global cell identity, the TAI and the CSG ID in the MeasurementReport }
}
```

(3)

```
with { UE in E-UTRA RRC_CONNECTED state }
```

```

ensure that {
  when { UE is configured to acquire the System Information of a neighbour non-CSG cell }
  then { UE acquires the System Information of the cell included in the associated measurement
object and reports the global cell identity and the TAI in the MeasurementReport }
}

```

8.3.4.1.2 Conformance requirements

References: The conformance requirements covered in the current TC are specified in: TS 36.331, clauses 5.5.2.3, 5.5.3.1 and 5.5.5, and TS 36.133, clause 8.1.2.2.3.1.

[TS 36.331, clause 5.5.2.3]

...

The UE shall:

...

2> if the *triggerType* is set to 'periodical' and the *purpose* is set to 'reportCGI' in the *reportConfig* associated with this *measId*:

3> if the *measObject* associated with this *measId* concerns E-UTRA:

4> if the *si-RequestForHO* is included in the *reportConfig* associated with this *measId*:

5> start timer T321 with the timer value set to 150 ms for this *measId*;

...

3> if the cell indicated by the *cellForWhichToReportCGI* included in the associated *measObject* is an E-UTRAN cell:

4> try to acquire the CSG identity, if the CSG identity is broadcast in the concerned cell;

...

[TS 36.331, clause 5.5.3.1]

...

The UE shall:

1> for each *measId* included in the *measIdList* within *VarMeasConfig*:

2> if the *purpose* for the associated *reportConfig* is set to 'reportCGI':

3> if *si-RequestForHO* is configured for the associated *reportConfig*:

4> perform the corresponding measurements on the frequency and RAT indicated in the associated *measObject* using autonomous gaps as necessary;

...

[TS 36.331, clause 5.5.5]

For the *measId* for which the measurement reporting procedure was triggered, the UE shall set the *measResults* within the *MeasurementReport* message as follows:

...

1> if there is at least one applicable neighbouring cell to report:

2> set the *measResultNeighCells* to include the best neighbouring cells up to *maxReportCells* in accordance with the following:

...

3> else if the *purpose* is set to 'reportCGI':

4> if the mandatory present fields of the *cgi-Info* for the cell indicated by the *cellForWhichToReportCGI* in the associated *measObject* have been obtained:

5> if the cell broadcasts a CSG identity:

6> include the *csg-Identity*;

6> include the *csg-MemberStatus* and set it to 'member' if the CSG identity is included in the UE's CSG whitelist;

...

[TS 36.133, clause 8.1.2.2.3.1]

No explicit neighbour list is provided to the UE for identifying a new CGI of E-UTRA cell. The UE shall identify and report the CGI when requested by the network for the purpose 'reportCGI'. The UE may make autonomous gaps in downlink reception and uplink transmission for receiving MIB and SIB1 message according to section 5.5.3.1 of 36.331 [2]. Note that a UE is not required to use autonomous gap if si-RequestForHO is set to false. If autonomous gaps are used for measurement with the purpose of 'reportCGI', the UE shall be able to identify a new CGI of E-UTRA cell within:

$$T_{\text{identify_CGI, intra}} = T_{\text{basic_identify_CGI, intra}} \quad ms$$

Where

$T_{\text{basic_identify_CGI, intra}} = 150$ ms. This is the time period used in the above equation where the maximum allowed time for the UE to identify a new CGI of an E-UTRA cell is defined.

A cell shall be considered identifiable following conditions are fulfilled:

- RSRP related side conditions given in Section 9.1 are fulfilled for a corresponding Band,
- $SCH_RP|dBm \geq -127$ dBm for Bands 1, 4, 6, 10, 11, 18, 19, 21 and $SCH \hat{E}s/Iot \geq -6$ dB,
- $SCH_RP|dBm \geq -126$ dBm for Band 9 and $SCH \hat{E}s/Iot \geq -6$ dB,
- $SCH_RP|dBm \geq -125$ dBm for Bands 2, 5, 7 and $SCH \hat{E}s/Iot \geq -6$ dB,
- $SCH_RP|dBm \geq -124$ dBm for Bands 3, 8, 12, 13, 14, 17, 20 and $SCH \hat{E}s/Iot \geq -6$ dB.

The requirement for identifying a new CGI of an E-UTRA cell within $T_{\text{basic_identify_CGI, intra}}$ is applicable when no DRX is used as well as when all the DRX cycles specified in 3GPP TS 36.331 [2] are used.

...

8.3.4.1.3 Test description

8.3.4.1.3.1 Pre-test conditions

System Simulator:

- Cell 1, Cell 2, Cell 4 and Cell 11.
- Cell 1 and Cell 11 are not CSG cells.
- Cell 2 and Cell 4 are CSG cells.
- System information combination 7 as defined in TS 36.508 [18] clause 4.4.3.1 is used in E-UTRA Cell 2 and Cell 4.

UE:

- The UE's Allowed CSG list contains the CSG ID of Cell 2.

Preamble:

- The UE is in state Generic RB Established (state 3) on Cell 1 according to [18].

8.3.4.1.3.2 Test procedure sequence

Table 8.3.4.1.3.2-1 illustrates the downlink power levels to be applied for Cell 1, Cell 2, Cell 4 and Cell 11 at various time instants of the test execution. The exact instants on which these values shall be applied are described in the texts in this clause.

Table 8.3.4.1.3.2-1: Time instances of cell power level and parameter changes

	Parameter	Unit	Cell 1	Cell 2 (DL only)	Cell 4 (DL only)	Cell 11 (DL only)	Remark
T1	Cell-specific RS EPRE	dBm/ 15kHz	-85	-79	Off	Off	Power levels are such that entry condition for event A3 on Cell 2 is satisfied: $Mn + Ofn + Ocn - Hys > Ms + Ofs + Ocs + Off$
T2	Cell-specific RS EPRE	dBm/ 15kHz	-85	Off	-79	Off	Power levels are such that entry condition for event A3 on Cell 4 is satisfied: $Mn + Ofn + Ocn - Hys > Ms + Ofs + Ocs + Off$
T3	Cell-specific RS EPRE	dBm/ 15kHz	-85	Off	Off	-79	Power levels are such that entry condition for event A3 on Cell 11 is satisfied: $Mn + Ofn + Ocn - Hys > Ms + Ofs + Ocs + Off$

Table 8.3.4.1.3.2-2: Main behaviour

St	Procedure	Message Sequence		TP	Verdict
		U - S	Message		
1	The SS transmits an <i>RRCCONNECTIONRECONFIGURATION</i> message including <i>measConfig</i> to setup intra LTE measurement and reporting for event A3 (intra frequency measurement) and set <i>timeAlignmentTimerDedicated</i> to <i>infinity</i> .	<--	<i>RRCCONNECTIONRECONFIGURATION</i>	-	-
2	The UE transmits an <i>RRCCONNECTIONRECONFIGURATIONCOMPLETE</i> message.	-->	<i>RRCCONNECTIONRECONFIGURATIONCOMPLETE</i>	-	-
3	The SS re-adjusts the cell-specific reference signal levels according to row "T1" in table 8.3.4.1.3.2-1.	-	-	-	-
4	The UE transmits a <i>MEASUREMENTREPORT</i> message to report event A3 with the measured RSRP value for Cell 2.	-->	<i>MEASUREMENTREPORT</i>	-	-
5	The SS transmits an <i>RRCCONNECTIONRECONFIGURATION</i> message including <i>measConfig</i> including <i>reportCGI</i> and <i>si-RequestForHO</i> for Cell 2.	<--	<i>RRCCONNECTIONRECONFIGURATION</i>	-	-
6	The UE transmits an <i>RRCCONNECTIONRECONFIGURATIONCOMPLETE</i> message.	-->	<i>RRCCONNECTIONRECONFIGURATIONCOMPLETE</i>	-	-
7	Check: Does the UE transmit a <i>MEASUREMENTREPORT</i> message with the System Information acquired on Cell 2 within 150 ms?	-->	<i>MEASUREMENTREPORT</i>	1	P
8	The SS re-adjusts the cell-specific reference signal level according to row "T2" in table 8.3.4.1.3.2-1.	-	-	-	-
9	The UE transmits a <i>MEASUREMENTREPORT</i> message to report event A3 with the measured RSRP value for Cell 4.	-->	<i>MEASUREMENTREPORT</i>	-	-
10	The SS transmits an <i>RRCCONNECTIONRECONFIGURATION</i> message including <i>measConfig</i> including <i>reportCGI</i> and <i>si-RequestForHO</i> for Cell 4.	<--	<i>RRCCONNECTIONRECONFIGURATION</i>	-	-
11	The UE transmits an <i>RRCCONNECTIONRECONFIGURATIONCOMPLETE</i> message.	-->	<i>RRCCONNECTIONRECONFIGURATIONCOMPLETE</i>	-	-
12	Check: Does the UE transmit a <i>MEASUREMENTREPORT</i> message with the System Information acquired on Cell 4 within 150 ms?	-->	<i>MEASUREMENTREPORT</i>	2	P
13	The SS re-adjusts the cell-specific reference signal level according to row "T3" in table 8.3.4.1.3.2-1.	-	-	-	-
14	The UE transmits a <i>MEASUREMENTREPORT</i> message to report event A3 with the measured RSRP value for Cell 11.	-->	<i>MEASUREMENTREPORT</i>	-	-
15	The SS transmits an <i>RRCCONNECTIONRECONFIGURATION</i> message including <i>measConfig</i> including <i>reportCGI</i> and <i>si-RequestForHO</i> for Cell 11.	<--	<i>RRCCONNECTIONRECONFIGURATION</i>	-	-
16	The UE transmits an <i>RRCCONNECTIONRECONFIGURATIONCOMPLETE</i> message.	-->	<i>RRCCONNECTIONRECONFIGURATIONCOMPLETE</i>	-	-
17	Check: Does the UE transmit a <i>MEASUREMENTREPORT</i> message with the System Information acquired on Cell 11 within 150 ms?	-->	<i>MEASUREMENTREPORT</i>	3	P

8.3.4.1.3.3 Specific message contents

Table 8.3.4.1.3.3-1: Conditions for Tables 8.3.4.1.3.3-2 and 8.3.4.1.3.3-3

Condition	Explanation
Cell 1	This condition applies to system information transmitted on Cell 1.
Cell 2	This condition applies to system information transmitted on Cell 2.
Cell 4	This condition applies to system information transmitted on Cell 4.
Cell 11	This condition applies to system information transmitted on Cell 11.

Table 8.3.4.1.3.3-2: SystemInformationBlockType1 for Cells 1, 2, 4 and 11 (preamble and all steps, Table 8.3.4.1.3.2-2)

Derivation Path: 36.508 clause 4.4.3.2			
Information Element	Value/remark	Comment	Condition
SystemInformationBlockType1 ::= SEQUENCE {			
cellAccessRelatedInfo SEQUENCE {			
csg-Indication	FALSE		Cell1 Cell 11
	TRUE		Cell 2 Cell 4
csg-Identity	Not present		Cell 1 Cell 11
	'000 0000 0000 0000 0000 0000 0010'B		Cell 2
	'000 0000 0000 0000 0000 0000 0100'B		Cell 4
}			
}			

Table 8.3.4.1.3.3-3: SystemInformationBlockType4 for Cells 2 and 4 (preamble and all steps, Table 8.3.4.1.3.2-2)

Derivation Path: 36.508 clause 4.4.3.3, Table 4.4.3.3-3			
Information Element	Value/remark	Comment	Condition
SystemInformationBlockType4 ::= SEQUENCE {			
csg-PhysCellIdRange ::= SEQUENCE {			
Start	2		
Range	n4		
}			
}			

Table 8.3.4.1.3.3-4: RRCConnectionReconfiguration (Step 1, Table 8.3.4.1.3.2-2)

Derivation Path: 36.508 clause 4.6.1 table 4.6.1-8 with condition MEAS			
Information Element	Value/remark	Comment	Condition
RadioResourceConfigDedicated ::= SEQUENCE {			
srb-ToAddModList	Not present		
drb-ToAddModList	Not present		
drb-ToReleaseList	Not present		
mac-MainConfig CHOICE {			
explicitValue SEQUENCE {			
ul-SCH-Config	Not present		
drx-Config	Not present		
timeAlignmentTimerDedicated	infinity		
phr-Config	Not present		
}			
}			
sps-Config	Not present		
physicalConfigDedicated	Not present		
}			

Table 8.3.4.1.3.3-5: *MeasConfig* (Step 1, Table 8.3.4.1.3.2-2)

Derivation Path: 36.508 clause 4.6.6 table 4.6.6-1			
Information Element	Value/remark	Comment	Condition
MeasConfig ::= SEQUENCE {			
measIdToAddModList ::= SEQUENCE (SIZE (1..maxMeasId)) OF SEQUENCE {	1 entry		
measId[1]	1		
measObjectId[1]	IdMeasObject-f1		
reportConfigId[1]	IdReportConfig-A3		
}			
measObjectToAddModList ::= SEQUENCE (SIZE (1..maxObjectId)) OF SEQUENCE {	1 entry		
measObjectId[1]	IdMeasObject-f1		
measObject[1]	MeasObjectEUTRA-GENERIC(f1)		
}			
reportConfigToAddModList ::= SEQUENCE (SIZE (1..maxReportConfigId)) OF SEQUENCE {	1 entry		
reportConfigId[1]	IdReportConfig-A3		
reportConfig[1]	ReportConfig-A3-H		
}			
}			

Table 8.3.4.1.3.3-6: *ReportConfig-A3-H* (Step 1, Table 8.3.4.1.3.2-2)

Derivation path: 36.508 clause 4.6.6 table 4.6.6-6 ReportConfigEUTRA-A3			
Information Element	Value/remark	Comment	Condition
ReportConfigEUTRA-A3 ::= SEQUENCE {			
triggerType CHOICE {			
event SEQUENCE {			
eventId CHOICE {			
eventA3 SEQUENCE {			
}			
}			
}			
timeToTrigger	ms0		
}			
reportQuantity	sameAsTriggerQuantity		
}			

Table 8.3.4.1.3.3-7 MeasurementReport (Step 4, Table 8.3.4.1.3.2-2)

Derivation path: 36.508 4.6.1 table 4.6.1-5			
Information Element	Value/Remark	Comment	Condition
MeasurementReport ::= SEQUENCE {			
criticalExtensions CHOICE {			
c1 CHOICE {			
measurementReport-r8 SEQUENCE {			
measResults ::= SEQUENCE {			
measId	1		
measResultServCell ::= SEQUENCE {		Report Cell 1	
rsrpResult	(0..97)		
rsrqResult	(0..34)		
}			
measResultNeighCells CHOICE {			
measResultListEUTRA SEQUENCE (SIZE (1..maxCellReport)) OF SEQUENCE {		Report Cell 2	
physCellId	PhysCellId of Cell 2		
cgi-Info	Not present		
measResult SEQUENCE{			
rsrpResult	(0..97)		
rsrqResult	Not present		
}			
}			
}			
}			
}			
}			
}			
}			

Table 8.3.4.1.3.3-8: RRCConnectionReconfiguration (Steps 5, 10 and 15, Table 8.3.4.1.3.2-2)

Derivation Path: 36.508 clause 4.6.1 table 4.6.1-8 with condition MEAS
--

Table 8.3.4.1.3.3-9: MeasConfig (Steps 5, 10 and 15, Table 8.3.4.1.3.2-2)

Derivation Path: 36.508 clause 4.6.6 table 4.6.6-1			
Information Element	Value/remark	Comment	Condition
MeasConfig ::= SEQUENCE {			
measIdToAddModList ::= SEQUENCE (SIZE (1..maxMeasId)) OF SEQUENCE {	1 entry		
measId[1]	2		
measObjectId[1]	IdMeasObject-f1		
reportConfigId[1]	ReportConfigId-CGI		
}			
measObjectToAddModList ::= SEQUENCE (SIZE (1..maxObjectId)) OF SEQUENCE {	1 entry		
measObjectId[1]	IdMeasObject-f1		
measObject[1]	MeasObjectEUTRA-CGI		
}			
reportConfigToRemoveList ::= SEQUENCE (SIZE (1..maxReportConfigId)) OF SEQUENCE {			
reportConfigId	IdReportConfig-A3		
}			
reportConfigToAddModList ::= SEQUENCE (SIZE (1..maxReportConfigId)) OF SEQUENCE {	1 entry		
reportConfigId[1]	ReportConfigId-CGI		
reportConfig[1]	ReportConfig-CGI		
}			
}			

Table 8.3.4.1.3.3-10: MeasObjectEUTRA-CGI (Step 5, Table 8.3.4.1.3.2-2)

Derivation Path: 36.508 clause 4.6.6 table 4.6.6-2			
Information Element	Value/remark	Comment	Condition
MeasObjectEUTRA-CGI ::= SEQUENCE {			
carrierFreq SEQUENCE {}	Downlink EARFCN for f1		
cellForWhichToReportCGI	PhysCellId of Cell 2		
}			

Table 8.3.4.1.3.3-11: ReportConfig-CGI (Steps 5, 10 and 15, Table 8.3.4.1.3.2-2)

Derivation Path: 36.508, Table 4.6.6-7			
Information Element	Value/remark	Comment	Condition
ReportConfigEUTRA ::= SEQUENCE {			
triggerType CHOICE {			
periodical SEQUENCE {			
purpose	reportCGI		
}			
reportQuantity	sameAsTriggerQuantity		
reportAmount	r1		
si-RequestForHO	setup		
}			

Table 8.3.4.1.3.3-12: *MeasurementReport* (Step 7, Table 8.3.4.1.3.2-2)

Derivation path: 36.508 4.6.1 table 4.6.1-5			
Information Element	Value/remark	Comment	Condition
MeasurementReport ::= SEQUENCE {			
criticalExtensions CHOICE {			
c1 CHOICE {			
measurementReport-r8 SEQUENCE {			
measResults ::= SEQUENCE {			
measId	2		
measResultServCell SEQUENCE {		Report Cell 1	
rsrpResult	(0..97)		
rsrqResult	(0..34)		
}			
measResultNeighCells CHOICE {			
measResultListEUTRA SEQUENCE (SIZE (1..maxCellReport)) OF SEQUENCE {	1 entry		
physCellId[1]	PhysCellId of Cell 2		
cgi-Info[1] SEQUENCE {			
cellGlobalId	cellGlobalId formed from the first entry in 'plmn-IdentityList' and 'cellIdentity' of Cell 2		
trackingAreaCode	trackingAreaCode of Cell 2		
plmn-IdentityList	Not present		
}			
measResult[1] SEQUENCE {			
rsrpResult	Not present		
rsrqResult	Not present		
csg-MemberStatus	member		
csg-Identity	'000 0000 0000 0000 0000 0000 0010'B	CSG ID of Cell 2	
}			
}			
}			
}			
}			
}			

Table 8.3.4.1.3.3-13: *MeasurementReport* (Step 9, Table 8.3.4.1.3.2-2)

Derivation path: 36.508 4.6.1 table 4.6.1-5			
Information Element	Value/Remark	Comment	Condition
MeasurementReport ::= SEQUENCE {			
criticalExtensions CHOICE {			
c1 CHOICE {			
measurementReport-r8 SEQUENCE {			
measResults ::= SEQUENCE {			
measId	1		
measResultServCell ::= SEQUENCE {		Report Cell 1	
rsrpResult	(0..97)		
rsrqResult	(0..34)		
}			
measResultNeighCells CHOICE {			
measResultListEUTRA SEQUENCE (SIZE (1..maxCellReport)) OF SEQUENCE {		Report Cell 4	
physCellId	PhysCellId of Cell 4		
cgi-Info	Not present		
measResult SEQUENCE {			
rsrpResult	(0..97)		
rsrqResult	Not present		
}			
}			
}			
}			
}			
}			
}			

Table 8.3.4.1.3.3-14: *MeasObjectEUTRA-CGI* (Step 10, Table 8.3.4.1.3.2-2)

Derivation Path: 36.508 clause 4.6.6 table 4.6.6-2			
Information Element	Value/remark	Comment	Condition
MeasObjectEUTRA-CGI ::= SEQUENCE {			
carrierFreq SEQUENCE {	Downlink EARFCN for f1		
cellForWhichToReportCGI	PhysCellId of Cell 4		
}			

Table 8.3.4.1.3.3-15: MeasurementReport (Step 12, Table 8.3.4.1.3.2-2)

Derivation path: 36.508 4.6.1 table 4.6.1-5			
Information Element	Value/remark	Comment	Condition
MeasurementReport ::= SEQUENCE {			
criticalExtensions CHOICE {			
c1 CHOICE {			
measurementReport-r8 SEQUENCE {			
measResults ::= SEQUENCE {			
measId	2		
measResultServCell SEQUENCE {		Report Cell 1	
rsrpResult	(0..97)		
rsrqResult	(0..34)		
}			
measResultNeighCells CHOICE {			
measResultListEUTRA SEQUENCE (SIZE (1..maxCellReport)) OF SEQUENCE {	1 entry		
physCellId[1]	PhysCellId of Cell 4		
cgi-Info[1] SEQUENCE {			
cellGlobalId	cellGlobalId formed from the first entry in 'plmn-IdentityList' and 'cellIdentity' of Cell 4		
trackingAreaCode	trackingAreaCode of Cell 4		
plmn-IdentityList	Not present		
}			
measResult[1] SEQUENCE {			
rsrpResult	Not present		
rsrqResult	Not present		
csg-MemberStatus	Not present		
csg-Identity	'000 0000 0000 0000 0000 0000 0100'B	CSG ID of Cell 4	
}			
}			
}			
}			
}			
}			

Table 8.3.4.1.3.3-16: *MeasurementReport* (Step 14, Table 8.3.4.1.3.2-2)

Derivation path: 36.508 4.6.1 table 4.6.1-5			
Information Element	Value/Remark	Comment	Condition
MeasurementReport ::= SEQUENCE {			
criticalExtensions CHOICE {			
c1 CHOICE {			
measurementReport-r8 SEQUENCE {			
measResults ::= SEQUENCE {			
measId	1		
measResultServCell ::= SEQUENCE {		Report Cell 1	
rsrpResult	(0..97)		
rsrqResult	(0..34)		
}			
measResultNeighCells CHOICE {			
measResultListEUTRA SEQUENCE (SIZE (1..maxCellReport)) OF SEQUENCE {		Report Cell 11	
physCellId	PhysCellId of Cell 11		
cgi-Info	Not present		
measResult SEQUENCE {			
rsrpResult	(0..97)		
rsrqResult	Not present		
}			
}			
}			
}			
}			
}			
}			

Table 8.3.4.1.3.3-17: *MeasObjectEUTRA-CGI* (Step 15, Table 8.3.4.1.3.2-2)

Derivation Path: 36.508 clause 4.6.6 table 4.6.6-2			
Information Element	Value/remark	Comment	Condition
MeasObjectEUTRA-CGI ::= SEQUENCE {			
carrierFreq SEQUENCE {	Downlink EARFCN for f1		
cellForWhichToReportCGI	PhysCellId of Cell 11		
}			

Table 8.3.4.1.3.3-18: *MeasurementReport* (Step 17, Table 8.3.4.1.3.2-2)

Derivation path: 36.508 4.6.1 table 4.6.1-5			
Information Element	Value/remark	Comment	Condition
MeasurementReport ::= SEQUENCE {			
criticalExtensions CHOICE {			
c1 CHOICE {			
measurementReport-r8 SEQUENCE {			
measResults ::= SEQUENCE {			
measId	2		
measResultServCell SEQUENCE {		Report Cell 1	
rsrpResult	(0..97)		
rsrqResult	(0..34)		
}			
measResultNeighCells CHOICE {			
measResultListEUTRA SEQUENCE (SIZE (1..maxCellReport)) OF SEQUENCE {	1 entry		
physCellId[1]	PhysCellId of Cell 11		
cgi-Info[1] SEQUENCE {			
cellGlobalId	cellGlobalId formed from the first entry in 'plmn-IdentityList' and 'cellIdentity' of Cell 11		
trackingAreaCode	trackingAreaCode of Cell 11		
plmn-IdentityList	Not present		
}			
measResult[1] SEQUENCE {			
rsrpResult	Not present		
rsrqResult	Not present		
csg-MemberStatus	Not present		
csg-Identity	Not present		
}			
}			
}			
}			
}			
}			

8.3.4.2 Inter-frequency SI acquisition / Non-member hybrid cell

8.3.4.2.1 Test Purpose (TP)

(1)

```
with { UE in E-UTRA RRC_CONNECTED state }
ensure that {
  when { UE is configured to acquire the System Information of a neighbour non-member hybrid cell }
  then { UE acquires the System Information of the cell included in the associated measurement object and reports the global cell identity, the TAI and the CSG ID in the MeasurementReport }
}
```

8.3.4.2.2 Conformance requirements

References: The conformance requirements covered in the current TC are specified in: TS 36.331, clauses 5.5.2.3, 5.5.3.1 and 5.5.5, and TS 36.133, clause 8.1.2.2.3.1.

[TS 36.331, clause 5.5.2.3]

...

The UE shall:

...

- 2> if the *triggerType* is set to 'periodical' and the *purpose* is set to 'reportCGI' in the *reportConfig* associated with this *measId*:
- 3> if the *measObject* associated with this *measId* concerns E-UTRA:
 - 4> if the *si-RequestForHO* is included in the *reportConfig* associated with this *measId*:
 - 5> start timer T321 with the timer value set to 150 ms for this *measId*;

...

[TS 36.331, clause 5.5.3.1]

...

The UE shall:

- 1> for each *measId* included in the *measIdList* within *VarMeasConfig*:
 - 2> if the *purpose* for the associated *reportConfig* is set to 'reportCGI':
 - 3> if *si-RequestForHO* is configured for the associated *reportConfig*:
 - 4> perform the corresponding measurements on the frequency and RAT indicated in the associated *measObject* using autonomous gaps as necessary;
 - ...
 - 3> if the cell indicated by the *cellForWhichToReportCGI* included in the associated *measObject* is an E-UTRAN cell:
 - 4> try to acquire the CSG identity, if the CSG identity is broadcast in the concerned cell;
 - 4> if *si-RequestForHO* is not configured for the associated *reportConfig*:
 - 5> try to acquire the list of additional PLMN Identities, as included in the *plmn-IdentityList*, if multiple PLMN identities are broadcast in the concerned cell;

...

[TS 36.331, clause 5.5.5]

...

For the *measId* for which the measurement reporting procedure was triggered, the UE shall set the *measResults* within the *MeasurementReport* message as follows:

...

- 1> if there is at least one applicable neighbouring cell to report:
 - 2> set the *measResultNeighCells* to include the best neighbouring cells up to *maxReportCells* in accordance with the following:
 - ...
 - 3> else if the *purpose* is set to 'reportCGI':
 - 4> if the mandatory present fields of the *cgi-Info* for the cell indicated by the *cellForWhichToReportCGI* in the associated *measObject* have been obtained:
 - 5> if the cell broadcasts a CSG identity:
 - 6> include the *csg-Identity*;
 - 6> include the *csg-MemberStatus* and set it to 'member' if the CSG identity is included in the UE's CSG whitelist;

5> if the '*si-RequestForHO*' is configured within the *reportConfig* associated with this *measId*:

6> include the *cgi-Info* containing all the fields that have been successfully acquired, except for the *plmn-IdentityList*;

5> else:

6> include the *cgi-Info* containing all the fields that have been successfully acquired;

...

[TS 36.133, clause 8.1.2.2.3.1]

No explicit neighbour list is provided to the UE for identifying a new CGI of E-UTRA cell. The UE shall identify and report the CGI when requested by the network for the purpose 'reportCGI'. The UE may make autonomous gaps in downlink reception and uplink transmission for receiving MIB and SIB1 message according to section 5.5.3.1 of 36.331 [2]. Note that a UE is not required to use autonomous gap if *si-RequestForHO* is set to false. If autonomous gaps are used for measurement with the purpose of 'reportCGI', the UE shall be able to identify a new CGI of E-UTRA cell within:

$$T_{\text{identify_CGI, intra}} = T_{\text{basic_identify_CGI, intra}} \quad ms$$

Where

$T_{\text{basic_identify_CGI, intra}} = 150$ ms. This is the time period used in the above equation where the maximum allowed time for the UE to identify a new CGI of an E-UTRA cell is defined.

A cell shall be considered identifiable following conditions are fulfilled:

- RSRP related side conditions given in Section 9.1 are fulfilled for a corresponding Band,
- $SCH_RP[dBm] \geq -127$ dBm for Bands 1, 4, 6, 10, 11, 18, 19, 21 and $SCH \hat{E}s/Iot \geq -6$ dB,
- $SCH_RP[dBm] \geq -126$ dBm for Band 9 and $SCH \hat{E}s/Iot \geq -6$ dB,
- $SCH_RP[dBm] \geq -125$ dBm for Bands 2, 5, 7 and $SCH \hat{E}s/Iot \geq -6$ dB,
- $SCH_RP[dBm] \geq -124$ dBm for Bands 3, 8, 12, 13, 14, 17, 20 and $SCH \hat{E}s/Iot \geq -6$ dB.

The requirement for identifying a new CGI of an E-UTRA cell within $T_{\text{basic_identify_CGI, intra}}$ is applicable when no DRX is used as well as when all the DRX cycles specified in 3GPP TS 36.331 [2] are used.

...

8.3.4.2.3 Test description

8.3.4.2.3.1 Pre-test conditions

System Simulator:

- Cell 1 and Cell 3 are E-UTRA cells.
- Cell 1 is a non CSG cell.
- Cell 3 is a hybrid cell.
- System information combination 3 as defined in TS 36.508 [18] clause 4.4.3.1 is used in E-UTRA Cell 1.
- System information combination 13 as defined in TS 36.508 [18] clause 4.4.3.1 is used in E-UTRA Cell 3.

UE:

- The UE's Allowed CSG list is empty.

Preamble:

- The UE is in state Generic RB Established (state 3) on Cell 1 according to [18].

8.3.4.2.3.2 Test procedure sequence

Table 8.3.4.2.3.2-1 illustrates the downlink power levels to be applied for Cell 1 and Cell 3 at various time instants of the test execution. The exact instants on which these values shall be applied are described in the texts in this clause.

Table 8.3.4.2.3.2-1: Time instances of cell power level and parameter changes

	Parameter	Unit	Cell 1	Cell 3 (DL only)	Remark
T1	Cell-specific RS EPRE	dBm/15kHz	-85	-73	Power levels are such that entry condition for event A3 on Cell 3 is satisfied: $Mn + Ofn + Ocn - Hys > Ms + Of_s + Ocs + Off$

Table 8.3.4.2.3.2-2: Main behaviour

St	Procedure	Message Sequence		TP	Verdict
		U - S	Message		
1	The SS transmits an <i>RRCCONNECTIONRECONFIGURATION</i> message including <i>measConfig</i> to setup intra LTE measurement and reporting for event A3 (inter frequency measurement) and set <i>timeAlignmentTimerDedicated</i> to <i>infinity</i> .	<--	<i>RRCCONNECTIONRECONFIGURATION</i>	-	-
2	The UE transmits an <i>RRCCONNECTIONRECONFIGURATIONCOMPLETE</i> message.	-->	<i>RRCCONNECTIONRECONFIGURATIONCOMPLETE</i>	-	-
3	The SS re-adjusts the cell-specific reference signal levels according to row "T1" in table 8.3.4.2.3.2-1.	-	-	-	-
4	The UE transmits a <i>MEASUREMENTREPORT</i> message to report event A3 with the measured RSRP value for Cell 3.	-->	<i>MEASUREMENTREPORT</i>	-	-
5	The SS transmits an <i>RRCCONNECTIONRECONFIGURATION</i> message including <i>measConfig</i> including <i>reportCGI</i> and <i>si-RequestForHO</i> for Cell 3.	<--	<i>RRCCONNECTIONRECONFIGURATION</i>	-	-
6	The UE transmits an <i>RRCCONNECTIONRECONFIGURATIONCOMPLETE</i> message.	-->	<i>RRCCONNECTIONRECONFIGURATIONCOMPLETE</i>	-	-
7	Check: Does the UE transmit a <i>MEASUREMENTREPORT</i> message with the System Information acquired on Cell 3 within 150 ms?	-->	<i>MEASUREMENTREPORT</i>	1	P

8.3.4.2.3.3 Specific message contents

Table 8.3.4.2.3.3-1: Conditions for Tables 8.3.4.2.3.3-2

Condition	Explanation
Cell 1	This condition applies to system information transmitted on Cell 1.
Cell 3	This condition applies to system information transmitted on Cell 3.

Table 8.3.4.2.3.3-2: SystemInformationBlockType1 for Cells 1 and 3 (preamble and all steps, Table 8.3.4.2.3.2-2)

Derivation Path: 36.508 clause 4.4.3.2			
Information Element	Value/remark	Comment	Condition
SystemInformationBlockType1 ::= SEQUENCE {			
cellAccessRelatedInfo SEQUENCE {			
csg-Indication	FALSE		
csg-Identity	Not present		Cell 1
	'000 0000 0000 0000 0000 0000 0010'B		Cell 3
}			
}			

Table 8.3.4.2.3.3-3: SystemInformationBlockType4 for Cell 3 (preamble and all steps, Table 8.3.4.2.3.2-2)

Derivation Path: 36.508 clause 4.4.3.3, Table 4.4.3.3-3			
Information Element	Value/remark	Comment	Condition
SystemInformationBlockType4 ::= SEQUENCE {			
csg-PhysCellIdRange ::= SEQUENCE {			
start	4		
range	Not present		
}			
}			

Table 8.3.4.2.3.3-4: RRCConnectionReconfiguration (Step 1, Table 8.3.4.2.3.2-2)

Derivation Path: 36.508 clause 4.6.1 table 4.6.1-8 with condition MEAS			
Information Element	Value/remark	Comment	Condition
RadioResourceConfigDedicated ::= SEQUENCE {			
srb-ToAddModList	Not present		
drb-ToAddModList	Not present		
drb-ToReleaseList	Not present		
mac-MainConfig CHOICE {			
explicitValue SEQUENCE {			
ul-SCH-Config	Not present		
drx-Config	Not present		
timeAlignmentTimerDedicated	infinity		
phr-Config	Not present		
}			
}			
sps-Config	Not present		
physicalConfigDedicated	Not present		
}			

Table 8.3.4.2.3.3-5: MeasConfig (Step 1, Table 8.3.4.2.3.2-2)

Derivation Path: 36.508 clause 4.6.6 table 4.6.6-1 with condition INTER-FREQ			
Information Element	Value/remark	Comment	Condition
MeasConfig ::= SEQUENCE {			
measObjectToAddModList ::= SEQUENCE (SIZE (1..maxObjectId)) OF SEQUENCE {	2 entries		
measObjectId[1]	IdMeasObject-f1		
measObject[1]	MeasObjectEUTRA-GENERIC(f1)		
measObjectId[2]	IdMeasObject-f2		
measObject[2]	MeasObjectEUTRA-GENERIC(f2)		
}			
reportConfigToAddModList ::= SEQUENCE (SIZE (1..maxReportConfigId)) OF SEQUENCE {	1 entry		
reportConfigId[1]	IdReportConfig-A3		
reportConfig[1]	ReportConfig-A3-H		
}			
measIdToAddModList ::= SEQUENCE (SIZE (1..maxMeasId)) OF SEQUENCE {	1 entry		
measId[1]	1		
measObjectId[1]	IdMeasObject-f2		
reportConfigId[1]	IdReportConfig-A3		
}			
}			

Table 8.3.4.2.3.3-6: ReportConfig-A3-H (Step 1, Table 8.3.4.2.3.2-2)

Derivation path: 36.508 clause 4.6.6 table 4.6.6-6 ReportConfigEUTRA-A3			
Information Element	Value/remark	Comment	Condition
ReportConfigEUTRA-A3 ::= SEQUENCE {			
triggerType CHOICE {			
event SEQUENCE {			
eventId CHOICE {			
eventA3 SEQUENCE {			
}			
}			
}			
timeToTrigger	ms0		
}			
reportQuantity	sameAsTriggerQuantity		
}			

Table 8.3.4.2.3.3-7: MeasurementReport (Step 4, Table 8.3.4.2.3.2-2)

Derivation path: 36.508 4.6.1 table 4.6.1-5			
Information Element	Value/Remark	Comment	Condition
MeasurementReport ::= SEQUENCE {			
criticalExtensions CHOICE {			
c1 CHOICE {			
measurementReport-r8 SEQUENCE {			
measResults ::= SEQUENCE {			
measId	1		
measResultServCell ::= SEQUENCE {		Report Cell 1	
rsrpResult	(0..97)		
rsrqResult	(0..34)		
}			
measResultNeighCells CHOICE {			
measResultListEUTRA SEQUENCE (SIZE (1..maxCellReport)) OF SEQUENCE {		Report Cell 3	
physCellId	PhysCellId of Cell 3		
cgi-Info	Not present		
measResult SEQUENCE{			
rsrpResult	(0..97)		
rsrqResult	Not present		
}			
}			
}			
}			
}			
}			
}			
}			

Table 8.3.4.2.3.3-8: RRCConnectionReconfiguration (Step 5, Table 8.3.4.2.3.2-2)

Derivation Path: 36.508 clause 4.6.1 table 4.6.1-8 with condition MEAS
--

Table 8.3.4.2.3.3-9: MeasConfig (Step 5, Table 8.3.4.2.3.2-2)

Derivation Path: 36.508 clause 4.6.6 table 4.6.6-1			
Information Element	Value/remark	Comment	Condition
MeasConfig ::= SEQUENCE {			
measIdToAddModList ::= SEQUENCE (SIZE (1..maxMeasId)) OF SEQUENCE {	1 entry		
measId[1]	2		
measObjectId[1]	IdMeasObject-f2		
reportConfigId[1]	ReportConfigId-CGI		
}			
measObjectToAddModList ::= SEQUENCE (SIZE (1..maxObjectId)) OF SEQUENCE {	1 entry		
measObjectId[1]	IdMeasObject-f2		
measObject[1]	MeasObjectEUTRA-CGI		
}			
reportConfigToRemoveList ::= SEQUENCE (SIZE (1..maxReportConfigId)) OF SEQUENCE {			
reportConfigId	IdReportConfig-A3		
}			
reportConfigToAddModList ::= SEQUENCE (SIZE (1..maxReportConfigId)) OF SEQUENCE {	1 entry		
reportConfigId[1]	ReportConfigId-CGI		
reportConfig[1]	ReportConfig-CGI		
}			
measGapConfig CHOICE {			
release	NULL		
}			
}			

Table 8.3.4.2.3.3-10: MeasObjectEUTRA-CGI (Step 5, Table 8.3.4.2.3.2-2)

Derivation Path: 36.508 clause 4.6.6 table 4.6.6-2			
Information Element	Value/remark	Comment	Condition
MeasObjectEUTRA-CGI ::= SEQUENCE {			
carrierFreq SEQUENCE {	Downlink EARFCN of Cell 3		
cellForWhichToReportCGI	PhysCellId of Cell 3		
}			

Table 8.3.4.2.3.3-11: ReportConfig-CGI (Step 5, Table 8.3.4.2.3.2-2)

Derivation Path: 36.508, Table 4.6.6-7 ReportConfigEUTRA-PERIODICAL			
Information Element	Value/remark	Comment	Condition
ReportConfigEUTRA ::= SEQUENCE {			
triggerType CHOICE {			
periodical SEQUENCE {			
purpose	reportCGI		
}			
}			
reportQuantity	sameAsTriggerQuantity		
reportAmount	r1		
si-RequestForHO	setup		
}			

Table 8.3.4.2.3.3-12: MeasurementReport (Step 7, Table 8.3.4.2.3.2-2)

Derivation path: 36.508 4.6.1 table 4.6.1-5			
Information Element	Value/remark	Comment	Condition
MeasurementReport ::= SEQUENCE {			
criticalExtensions CHOICE {			
c1 CHOICE {			
measurementReport-r8 SEQUENCE {			
measResults ::= SEQUENCE {			
measId	2		
measResultServCell SEQUENCE {		Report Cell 1	
rsrpResult	(0..97)		
rsrqResult	(0..34)		
}			
measResultNeighCells CHOICE {			
measResultListEUTRA SEQUENCE (SIZE (1..maxCellReport)) OF SEQUENCE {	1 entry		
physCellId[1]	PhysCellId of Cell 3		
cgi-Info[1] SEQUENCE {			
cellGlobalId	cellGlobalId formed from the first entry in 'plmn-IdentityList' and 'cellIdentity' of Cell 3		
trackingAreaCode	trackingAreaCode of Cell 3		
plmn-IdentityList	Not present		
}			
measResult[1] SEQUENCE {			
rsrpResult	Not present		
rsrqResult	Not present		
additionalSI-Info-r9 SEQUENCE {			
csg-MemberStatus	Not present		
csg-Identity	'000 0000 0000 0000 0000 0000 0010'B	CSG ID of Cell 3	
}			
}			
}			
}			
}			
}			

8.3.4.3 Inter-frequency SI acquisition / Member hybrid cell

8.3.4.3.1 Test Purpose (TP)

(1)

```
with { UE in E-UTRA RRC_CONNECTED state}
ensure that {
  when { UE is configured to acquire the System Information of a neighbour member hybrid cell }
  then { UE acquires the System Information of the cell included in the associated measurement object and reports the global cell identity, the TAI, the MemberStatus and the CSG ID in the MeasurementReport}
}
```

8.3.4.3.2 Conformance requirements

References: The conformance requirements covered in the current TC are specified in: TS 36.331, clauses 5.5.2.3, 5.5.3.1, 5.5.5 and TS 36.133, clause 8.1.2.3.5.1.

[TS 36.331, clause 5.5.2.3]

...

The UE shall:

...

- 2> if the *triggerType* is set to 'periodical' and the *purpose* is set to 'reportCGI' in the *reportConfig* associated with this *measId*:
- 3> if the *measObject* associated with this *measId* concerns E-UTRA:
 - 4> if the *si-RequestForHO* is included in the *reportConfig* associated with this *measId*:
 - 5> start timer T321 with the timer value set to 150 ms for this *measId*;

...

[TS 36.331, clause 5.5.3.1]

...

The UE shall:

- 1> for each *measId* included in the *measIdList* within *VarMeasConfig*:
 - 2> if the *purpose* for the associated *reportConfig* is set to 'reportCGI':
 - 3> if *si-RequestForHO* is configured for the associated *reportConfig*:
 - 4> perform the corresponding measurements on the frequency and RAT indicated in the associated *measObject* using autonomous gaps as necessary;
 - ...
 - 3> if the cell indicated by the *cellForWhichToReportCGI* included in the associated *measObject* is an E-UTRAN cell:
 - 4> try to acquire the CSG identity, if the CSG identity is broadcast in the concerned cell;
 - 4> if *si-RequestForHO* is not configured for the associated *reportConfig*:
 - 5> try to acquire the list of additional PLMN Identities, as included in the *plmn-IdentityList*, if multiple PLMN identities are broadcast in the concerned cell;

...

[TS 36.331, clause 5.5.5]

...

For the *measId* for which the measurement reporting procedure was triggered, the UE shall set the *measResults* within the *MeasurementReport* message as follows:

...

- 1> if there is at least one applicable neighbouring cell to report:
 - 2> set the *measResultNeighCells* to include the best neighbouring cells up to *maxReportCells* in accordance with the following:
 - ...
 - 3> else if the *purpose* is set to 'reportCGI':
 - 4> if the mandatory present fields of the *cgi-Info* for the cell indicated by the *cellForWhichToReportCGI* in the associated *measObject* have been obtained:
 - 5> if the cell broadcasts a CSG identity:
 - 6> include the *csg-Identity*;

6> include the *csg-MemberStatus* and set it to 'member' if the CSG identity is included in the UE's CSG whitelist;

5> if the '*si-RequestForHO*' is configured within the *reportConfig* associated with this *measId*:

6> include the *cgi-Info* containing all the fields that have been successfully acquired, except for the *plmn-IdentityList*;

5> else:

6> include the *cgi-Info* containing all the fields that have been successfully acquired;

...

[TS 36.133, clause 8.1.2.3.5.1]

No explicit neighbour list is provided to the UE for identifying a new CGI of E-UTRA cell. The UE shall identify and report the CGI when requested by the network for the purpose of 'reportCGI'. The UE may make autonomous gaps in both downlink reception and uplink transmission for receiving MIB and SIB1 message according to section 5.5.3.1 of 36.331 [2]. Note that a UE is not required to use autonomous gap if *si-RequestForHO* is set to false. If autonomous gaps are used for measurement with the purpose of 'reportCGI', regardless of whether DRX is used or not, the UE shall be able to identify a new CGI of E-UTRA cell within:

$$T_{\text{identify_CGI,inter}} = T_{\text{basic_identify_CGI,inter}} \quad ms$$

Where

$T_{\text{basic_identify_CGI,inter}} = 150$ ms. This is the time period used in the above equation where the maximum allowed time for the UE to identify a new CGI of E-UTRA cell is defined.

A cell shall be considered identifiable following conditions are fulfilled:

- RSRP related side conditions given in Section 9.1 are fulfilled for a corresponding Band,
- $SCH_RP|dBm \geq -125$ dBm for Bands 1, 4, 6, 10, 11, 18, 19, 21 and $SCH \hat{E}s/Iot \geq -4$ dB,
- $SCH_RP|dBm \geq -124$ dBm for Band 9 and $SCH \hat{E}s/Iot \geq -4$ dB,
- $SCH_RP|dBm \geq -123$ dBm for Bands 2, 5, 7 and $SCH \hat{E}s/Iot \geq -4$ dB,
- $SCH_RP|dBm \geq -122$ dBm for Bands 3, 8, 12, 13, 14, 17, 20 and $SCH \hat{E}s/Iot \geq -4$ dB.

The requirement for identifying a new CGI of an E-UTRA cell within $T_{\text{basic_identify_CGI,inter}}$ is applicable when no DRX is used as well as when all the DRX cycles specified in 3GPP TS 36.331 [2] are used.

Given that continuous DL data allocation and no DRX is used, and no measurement gaps are configured, the UE shall have more than [60] ACK/NACK transmitted during identification of a new CGI of E-UTRA cell.

8.3.4.3.3 Test description

8.3.4.3.3.1 Pre-test conditions

System Simulator:

- Cell 1 and Cell 3 are E-UTRA cells.
- Cell 1 is a non CSG cell.
- Cell 3 is a hybrid cell.
- System information combination 3 as defined in TS 36.508 [18] clause 4.4.3.1 is used in E-UTRA Cell 1.
- System information combination 13 as defined in TS 36.508 [18] clause 4.4.3.1 is used in E-UTRA Cell 3.

UE:

- The UE's Allowed CSG list contains the CSG ID of the Cell 3.

Preamble:

- The UE is in state Generic RB Established (state 3) on Cell 1 according to [18].

8.3.4.3.3.2 Test procedure sequence

Table 8.3.4.3.3.2-1 illustrates the downlink power levels to be applied for Cell 1 and Cell 3 at various time instants of the test execution. The exact instants on which these values shall be applied are described in the texts in this clause.

Table 8.3.4.3.3.2-1: Time instances of cell power level and parameter changes

	Parameter	Unit	Cell 1	Cell 3 (DL only)	Remark
T1	Cell-specific RS EPRE	dBm/ 15kHz z	-85	-73	Power levels are such that entry condition for event A3 on Cell 3 is satisfied: $Mn + Ofn + Ocn - Hys > Ms + OfS + Ocs + Off$

Table 8.3.4.3.3.2-2: Main behaviour

St	Procedure	Message Sequence		TP	Verdict
		U - S	Message		
1	The SS transmits an <i>RRCCONNECTIONRECONFIGURATION</i> message including <i>measConfig</i> to setup intra LTE measurement and reporting for event A3 (inter frequency measurement) and set <i>timeAlignmentTimerDedicated</i> to <i>infinity</i> .	<--	<i>RRCCONNECTIONRECONFIGURATION</i>	-	-
2	The UE transmits an <i>RRCCONNECTIONRECONFIGURATIONCOMPLETE</i> message.	-->	<i>RRCCONNECTIONRECONFIGURATIONCOMPLETE</i>	-	-
3	The SS re-adjusts the cell-specific reference signal levels according to row "T1" in table 8.3.4.3.3.2-1.	-	-	-	-
4	The UE transmits a <i>MEASUREMENTREPORT</i> message to report event A3 with the measured RSRP value for Cell 3.	-->	<i>MEASUREMENTREPORT</i>	-	-
5	The SS transmits an <i>RRCCONNECTIONRECONFIGURATION</i> message including <i>measConfig</i> including <i>reportCGI</i> and <i>si-RequestForHO</i> for Cell 3.	<--	<i>RRCCONNECTIONRECONFIGURATION</i>	-	-
6	The UE transmits an <i>RRCCONNECTIONRECONFIGURATIONCOMPLETE</i> message.	-->	<i>RRCCONNECTIONRECONFIGURATIONCOMPLETE</i>	-	-
7	Check: Does the UE transmit a <i>MEASUREMENTREPORT</i> message with the System Information acquired on Cell 3 within 150 ms?	-->	<i>MEASUREMENTREPORT</i>	1	P

8.3.4.3.3.3 Specific message contents

Table 8.3.4.3.3.3-1: Conditions for Tables 8.3.4.3.3.3-2

Condition	Explanation
Cell 1	This condition applies to system information transmitted on Cell 1.
Cell 3	This condition applies to system information transmitted on Cell 3.

Table 8.3.4.3.3-2: SystemInformationBlockType1 for Cells 1 and 3 (preamble and all steps, Table 8.3.4.3.3.2-2)

Derivation Path: 36.508 clause 4.4.3.2			
Information Element	Value/remark	Comment	Condition
SystemInformationBlockType1 ::= SEQUENCE {			
cellAccessRelatedInfo SEQUENCE {			
csg-Indication	FALSE		
csg-Identity	Not present		Cell 1
	'000 0000 0000 0000 0000 0000 0010'B		Cell 3
}			
}			

Table 8.3.4.3.3-3: SystemInformationBlockType4 for Cell 3 (preamble and all steps, Table 8.3.4.2.3.2-2)

Derivation Path: 36.508 clause 4.4.3.3, Table 4.4.3.3-3			
Information Element	Value/remark	Comment	Condition
SystemInformationBlockType4 ::= SEQUENCE {			
csg-PhysCellIdRange ::= SEQUENCE {			
start	4		
range	Not present		
}			
}			

Table 8.3.4.3.3-4: RRCConnectionReconfiguration (Step 1, Table 8.3.4.3.3.2-2)

Derivation Path: 36.508 clause 4.6.1 table 4.6.1-8 with condition MEAS			
Information Element	Value/remark	Comment	Condition
RadioResourceConfigDedicated ::= SEQUENCE {			
srb-ToAddModList	Not present		
drb-ToAddModList	Not present		
drb-ToReleaseList	Not present		
mac-MainConfig CHOICE {			
explicitValue SEQUENCE {			
ul-SCH-Config	Not present		
drx-Config	Not present		
timeAlignmentTimerDedicated	infinity		
phr-Config	Not present		
}			
}			
sps-Config	Not present		
physicalConfigDedicated	Not present		
}			

Table 8.3.4.3.3-5: *MeasConfig* (Step 1, Table 8.3.4.3.3.2-2)

Derivation Path: 36.508 clause 4.6.6 table 4.6.6-1 with condition INTER-FREQ			
Information Element	Value/remark	Comment	Condition
MeasConfig ::= SEQUENCE {			
measObjectToAddModList ::= SEQUENCE (SIZE (1..maxObjectId)) OF SEQUENCE {	2 entries		
measObjectId[1]	IdMeasObject-f1		
measObject[1]	MeasObjectEUTRA-GENERIC(f1)		
measObjectId[2]	IdMeasObject-f2		
measObject[2]	MeasObjectEUTRA-GENERIC(f2)		
}			
reportConfigToAddModList ::= SEQUENCE (SIZE (1..maxReportConfigId)) OF SEQUENCE {	1 entry		
reportConfigId[1]	IdReportConfig-A3		
reportConfig[1]	ReportConfig-A3-H		
}			
measIdToAddModList ::= SEQUENCE (SIZE (1..maxMeasId)) OF SEQUENCE {	1 entry		
measId[1]	1		
measObjectId[1]	IdMeasObject-f2		
reportConfigId[1]	IdReportConfig-A3		
}			
}			

Table 8.3.4.3.3-6: *ReportConfig-A3-H* (Step 1, Table 8.3.4.3.3.2-2)

Derivation path: 36.508 clause 4.6.6 table 4.6.6-6 ReportConfigEUTRA-A3			
Information Element	Value/remark	Comment	Condition
ReportConfigEUTRA-A3 ::= SEQUENCE {			
triggerType CHOICE {			
event SEQUENCE {			
eventId CHOICE {			
eventA3 SEQUENCE {			
}			
}			
}			
timeToTrigger	ms0		
}			
reportQuantity	sameAsTriggerQuantity		
}			

Table 8.3.4.3.3-7: MeasurementReport (Step 4, Table 8.3.4.3.3.2-2)

Derivation path: 36.508 4.6.1 table 4.6.1-5			
Information Element	Value/Remark	Comment	Condition
MeasurementReport ::= SEQUENCE {			
criticalExtensions CHOICE {			
c1 CHOICE {			
measurementReport-r8 SEQUENCE {			
measResults ::= SEQUENCE {			
measId	1		
measResultServCell ::= SEQUENCE {		Report Cell 1	
rsrpResult	(0..97)		
rsrqResult	(0..34)		
}			
measResultNeighCells CHOICE {			
measResultListEUTRA SEQUENCE (SIZE (1..maxCellReport)) OF SEQUENCE {		Report Cell 3	
physCellId	PhysCellId of Cell 3		
cgi-Info	Not present		
measResult SEQUENCE{			
rsrpResult	(0..97)		
rsrqResult	Not present		
}			
}			
}			
}			
}			
}			
}			
}			

Table 8.3.4.3.3-8: RRCConnectionReconfiguration (Step 5, Table 8.3.4.3.3.2-2)

Derivation Path: 36.508 clause 4.6.1 table 4.6.1-8 with condition MEAS
--

Table 8.3.4.3.3-9: MeasConfig (Step 5, Table 8.3.4.3.3.2-2)

Derivation Path: 36.508 clause 4.6.6 table 4.6.6-1			
Information Element	Value/remark	Comment	Condition
MeasConfig ::= SEQUENCE {			
measIdToAddModList ::= SEQUENCE (SIZE (1..maxMeasId)) OF SEQUENCE {	1 entry		
measId[1]	2		
measObjectId[1]	IdMeasObject-f2		
reportConfigId[1]	ReportConfigId-CGI		
}			
measObjectToAddModList ::= SEQUENCE (SIZE (1..maxObjectId)) OF SEQUENCE {	1 entry		
measObjectId[1]	IdMeasObject-f2		
measObject[1]	MeasObjectEUTRA-CGI		
}			
reportConfigToRemoveList ::= SEQUENCE (SIZE (1..maxReportConfigId)) OF SEQUENCE {			
reportConfigId	IdReportConfig-A3		
}			
reportConfigToAddModList ::= SEQUENCE (SIZE (1..maxReportConfigId)) OF SEQUENCE {	1 entry		
reportConfigId[1]	ReportConfigId-CGI		
reportConfig[1]	ReportConfig-CGI		
}			
measGapConfig CHOICE {			
release	NULL		
}			
}			

Table 8.3.4.3.3-10: MeasObjectEUTRA-CGI (Step 5, Table 8.3.4.3.3.2-2)

Derivation Path: 36.508 clause 4.6.6 table 4.6.6-2			
Information Element	Value/remark	Comment	Condition
MeasObjectEUTRA-CGI ::= SEQUENCE {			
carrierFreq SEQUENCE {	Downlink EARFCN of Cell 3		
cellForWhichToReportCGI	PhysCellId of Cell 3		
}			

Table 8.3.4.3.3-11: ReportConfig-CGI (Step 5, Table 8.3.4.3.3.2-2)

Derivation Path: 36.508, Table 4.6.6-7 ReportConfigEUTRA-PERIODICAL			
Information Element	Value/remark	Comment	Condition
ReportConfigEUTRA ::= SEQUENCE {			
triggerType CHOICE {			
periodical SEQUENCE {			
purpose	reportCGI		
}			
}			
reportQuantity	sameAsTriggerQuantity		
reportAmount	r1		
si-RequestForHO	setup		
}			

Table 8.3.4.3.3-12: MeasurementReport (Step 7, Table 8.3.4.3.3.2-2)

Derivation path: 36.508 4.6.1 table 4.6.1-5			
Information Element	Value/remark	Comment	Condition
MeasurementReport ::= SEQUENCE {			
criticalExtensions CHOICE {			
c1 CHOICE {			
measurementReport-r8 SEQUENCE {			
measResults ::= SEQUENCE {			
measId	2		
measResultServCell SEQUENCE {		Report Cell 1	
rsrpResult	(0..97)		
rsrqResult	(0..34)		
}			
measResultNeighCells CHOICE {			
measResultListEUTRA SEQUENCE (SIZE (1..maxCellReport)) OF SEQUENCE {	1 entry		
physCellId[1]	PhysCellId of Cell 3		
cgi-Info[1] SEQUENCE {			
cellGlobalId	cellGlobalId formed from the first entry in 'plmn-IdentityList' and 'cellIdentity' of Cell 3		
trackingAreaCode	trackingAreaCode of Cell 3		
plmn-IdentityList	Not present		
}			
measResult[1] SEQUENCE {			
rsrpResult	Not present		
rsrqResult	Not present		
additionalSI-Info-r9 SEQUENCE {			
csg-MemberStatus	member		
csg-Identity	'000 0000 0000 0000 0000 0000 0010'B	CSG ID of Cell 3	
}			
}			
}			
}			
}			
}			
}			

8.3.4.4 Inter-RAT SI acquisition / RRC_CONNECTED / UMTS member CSG cell

8.3.4.4.1 Test Purpose (TP)

(1)

```
with { UE in E-UTRA RRC_CONNECTED state }
ensure that {
  when { UE is configured to acquire the System Information of a neighbour UTRA member CSG cell }
  then { UE acquires the System Information of the cell included in the associated measurement object and reports the global cell identity, the LAC, the RAC, the CSG ID and its membership status in the MeasurementReport }
}
```

8.3.4.4.2 Conformance requirements

References: The conformance requirements covered in the current TC are specified in: TS 36.331, clauses 5.5.2.3, 5.5.3.1 and 5.5.5.

[TS 36.331, clause 5.5.2.3]

...

The UE shall:

...

- 2> if the *triggerType* is set to 'periodical' and the *purpose* is set to 'reportCGI' in the *reportConfig* associated with this *measId*:

...

- 3> else if the *measObject* associated with this *measId* concerns UTRA:

- 4> if the *si-RequestForHO* is included in the *reportConfig* associated with this *measId*:

- 5> start timer T321 with the timer value set to [1 second] for this *measId*;

...

[TS 36.331, clause 5.5.3.1]

...

The UE shall:

- 1> for each *measId* included in the *measIdList* within *VarMeasConfig*:

- 2> if the *purpose* for the associated *reportConfig* is set to 'reportCGI':

- 3> if *si-RequestForHO* is configured for the associated *reportConfig*:

- 4> perform the corresponding measurements on the frequency and RAT indicated in the associated *measObject* using autonomous gaps as necessary;

...

- 3> if the cell indicated by the *cellForWhichToReportCGI* included in the associated *measObject* is a UTRAN cell:

- 4> try to acquire the LAC, the RAC and the list of additional PLMN Identities, if multiple PLMN identities are broadcast in the concerned cell;

- 4> try to acquire the CSG identity, if the CSG identity is broadcast in the concerned cell;

...

[TS 36.331, clause 5.5.5]

...

For the *measId* for which the measurement reporting procedure was triggered, the UE shall set the *measResults* within the *MeasurementReport* message as follows:

...

- 1> if there is at least one applicable neighbouring cell to report:

- 2> set the *measResultNeighCells* to include the best neighbouring cells up to *maxReportCells* in accordance with the following:

...

- 3> else if the *purpose* is set to 'reportCGI':

- 4> if the mandatory present fields of the *cgi-Info* for the cell indicated by the *cellForWhichToReportCGI* in the associated *measObject* have been obtained:

- 5> if the cell broadcasts a CSG identity:

- 6> include the *csg-Identity*;

6> include the *csg-MemberStatus* and set it to 'member' if the CSG identity is included in the UE's CSG whitelist;

5> if the '*si-RequestForHO*' is configured within the *reportConfig* associated with this *measId*:

6> include the *cgi-Info* containing all the fields that have been successfully acquired, except for the *plmn-IdentityList*;

5> else:

6> include the *cgi-Info* containing all the fields that have been successfully acquired;

...

8.3.4.4.3 Test description

8.3.4.4.3.1 Pre-test conditions

System Simulator:

- Cell 1 is E-UTRA cell.
- Cell 5 is UTRA cell.
- Cell 1 is a non CSG cell.
- Cell 5 is a CSG cell.
- System information combination 4 as defined in TS 36.508 [18] clause 4.4.3.1 is used in E-UTRA Cell.

UE:

- The UE's Allowed CSG list contains the CSG ID of Cell 5.

Preamble:

- The UE is in state Generic RB Established (state 3) on Cell 1 according to [18].

8.3.4.4.3.2 Test procedure sequence

Table 8.3.4.4.3.2-1 illustrates the downlink power levels to be applied for Cell 1 and Cell 5 at various time instants of the test execution. The exact instants on which these values shall be applied are described in the texts in this clause.

Table 8.3.4.4.3.2-1: Time instances of cell power level and parameter changes

	Parameter	Unit	Cell 1	Cell 5 (DL only)	Remark
T1	Cell-specific RS EPRE	dBm/15kHz	-85	-12.5	Power levels are such that entry condition for event B2 on Cell 5 is satisfied.

Table 8.3.4.4.3.2-2: Main behaviour

St	Procedure	Message Sequence		TP	Verdict
		U - S	Message		
1	The SS transmits an <i>RRCCONNECTIONRECONFIGURATION</i> message including <i>measConfig</i> to setup inter RAT measurement and reporting for event B2 and set <i>timeAlignmentTimerDedicated</i> to <i>infinity</i> .	<--	<i>RRCCONNECTIONRECONFIGURATION</i>	-	-
2	The UE transmits an <i>RRCCONNECTIONRECONFIGURATIONCOMPLETE</i> message.	-->	<i>RRCCONNECTIONRECONFIGURATIONCOMPLETE</i>	-	-
3	The SS re-adjusts the cell-specific reference signal levels according to row "T1" in table 8.3.4.4.3.2-1.	-	-	-	-
4	The UE transmits a <i>MEASUREMENTREPORT</i> message to report event B2 for Cell 5.	-->	<i>MEASUREMENTREPORT</i>	-	-
5	The SS transmits an <i>RRCCONNECTIONRECONFIGURATION</i> message including <i>measConfig</i> including <i>reportCGI</i> and <i>si-RequestForHO</i> for Cell 5.	<--	<i>RRCCONNECTIONRECONFIGURATION</i>	-	-
6	The UE transmits an <i>RRCCONNECTIONRECONFIGURATIONCOMPLETE</i> message.	-->	<i>RRCCONNECTIONRECONFIGURATIONCOMPLETE</i>	-	-
7	Check: Does the UE transmit a <i>MEASUREMENTREPORT</i> message with the System Information acquired on Cell 5 within [1] s?	-->	<i>MEASUREMENTREPORT</i>	1	P

8.3.4.4.3.3 Specific message contents

Table 8.3.4.4.3.3-1: Master Information Block for Cell 5 (preamble and all steps, Table 8.3.4.4.3.2-2)

Derivation Path: 34.108 clause 6.1.0a.3			
Information Element	Value/remark	Comment	Condition
- CSG Indicator	TRUE		

Table 8.3.4.4.3.3-2: System Information Block type 3 for Cell 5 (preamble and all steps, Table 8.3.4.4.3.2-2)

Derivation Path: 34.108 clause 6.1.0b			
Information Element	Value/remark	Comment	Condition
- CSG Identity	'000 0000 0000 0000 0000 0000 0010'B		
- CSG PSC Split Information			
- Start PSC	104		
- Number of PSCs	5		
- PSC Range 2 Offset	Not present		

Table 8.3.4.4.3.3-3: RRCConnectionReconfiguration (Step 1, Table 8.3.4.4.3.2-2)

Derivation Path: 36.508 clause 4.6.1 table 4.6.1-8 with condition MEAS			
Information Element	Value/remark	Comment	Condition
RadioResourceConfigDedicated ::= SEQUENCE {			
srb-ToAddModList	Not present		
drb-ToAddModList	Not present		
drb-ToReleaseList	Not present		
mac-MainConfig CHOICE {			
explicitValue SEQUENCE {			
ul-SCH-Config	Not present		
drx-Config	Not present		
timeAlignmentTimerDedicated	infinity		
phr-Config	Not present		
}			
}			
sps-Config	Not present		
physicalConfigDedicated	Not present		
}			

Table 8.3.4.4.3.3-4: MeasConfig (Step 1, Table 8.3.4.4.3.2-2)

Derivation Path: 36.508 clause 4.6.6 table 4.6.6-1 with condition UTRAN			
Information Element	Value/remark	Comment	Condition
MeasConfig ::= SEQUENCE {			
measObjectToAddModList ::= SEQUENCE (SIZE (1..maxObjectId)) OF SEQUENCE {	2 entries		
measObjectId[1]	IdMeasObject-f1		
measObject[1]	MeasObjectEUTRA-GENERIC(f1)		
measObjectId[2]	IdMeasObject-f8		
measObject[2]	MeasObjectUTRA-f8		
}			
reportConfigToAddModList ::= SEQUENCE (SIZE (1..maxReportConfigId)) OF SEQUENCE {	1 entry		
reportConfigId[1]	IdReportConfig-B2-UTRA		
reportConfig[1]	ReportConfigInterRAT-B2-UTRA(-69,-18)		
}			
measIdToAddModList ::= SEQUENCE (SIZE (1..maxMeasId)) OF SEQUENCE {	1 entry		
measId[1]	1		
measObjectId[1]	IdMeasObject-f8		
reportConfigId[1]	IdReportConfig-B2-UTRA		
}			
}			

Table 8.3.4.4.3.3-5: MeasObjectUTRA-f8 (Step 1, Table 8.3.4.4.3.2-2)

Derivation path: 36.508 table 4.6.6-3 MeasObjectUTRA-GENERIC(f8)			
Information Element	Value/Remark	Comment	Condition
MeasObjectUTRA-GENERIC(f8) ::= SEQUENCE {			
carrierFreq	UTRA DL carrier frequency of the cell 5		
cellsToAddModList CHOICE {			
cellsToAddModListUTRA-FDD ::= SEQUENCE (SIZE (1..maxCellMeas)) OF SEQUENCE {			UTRA-FDD
cellIndex [1]	1		
physCellId [1]	physicalCellIdentity – Cell 5		
}			
cellsToAddModListUTRA-TDD ::= SEQUENCE (SIZE (1..maxMeasId)) OF SEQUENCE {			UTRA-TDD
cellIndex [1]	1		
physCellId [1]	physicalCellIdentity – Cell 5		
}			
}			
}			

Condition	Explanation
UTRA-FDD	UTRA-FDD cell environment
UTRA-TDD	UTRA-TDD cell environment

Table 8.3.4.4.3.3-6: ReportConfigInterRAT-B2-UTRA (Step 1, Table 8.3.4.4.3.2-2)

Derivation path: 36.508 clause 4.6.6 table 4.6.6-8 ReportConfigInterRAT-B2-UTRA(-69,-18)
--

Table 8.3.4.4.3.3-7: MeasurementReport (Step 4, Table 8.3.4.4.3.2-2)

Derivation path: 36.508 4.6.1 table 4.6.1-5			
Information Element	Value/Remark	Comment	Condition
MeasurementReport ::= SEQUENCE {			
criticalExtensions CHOICE {			
c1 CHOICE {			
measurementReport-r8 SEQUENCE {			
measResults ::= SEQUENCE {			
measId	1		
measResultServCell ::= SEQUENCE {		Report Cell 1	
rsrpResult	(0..97)		
rsrqResult	(0..34)		
}			
measResultNeighCells CHOICE {			
measResultListUTRA SEQUENCE (SIZE (1..maxCellReport)) OF SEQUENCE {	1 entry	Report Cell 5	
physCellId[1]	PhysCellId of Cell 5		
cgi-Info[1]	Not present		
measResult[1] SEQUENCE{			
utra-RSCP	(-5..91)		UTRA-TDD
utra-EcN0	(0..49)		UTRA-FDD
}			
}			
}			
}			
}			

Condition	Explanation
-----------	-------------

UTRA-FDD	UTRA-FDD cell environment
UTRA-TDD	UTRA-TDD cell environment

Table 8.3.4.4.3.3-8: RRCConnectionReconfiguration (Step 5, Table 8.3.4.4.3.2-2)

Derivation Path: 36.508 clause 4.6.1 table 4.6.1-8 with condition MEAS

Table 8.3.4.4.3.3-9: MeasConfig (Step 5, Table 8.3.4.4.3.2-2)

Derivation Path: 36.508 clause 4.6.6 table 4.6.6-1			
Information Element	Value/remark	Comment	Condition
MeasConfig ::= SEQUENCE {			
measIdToAddModList ::= SEQUENCE (SIZE (1..maxMeasId)) OF SEQUENCE {	1 entry		
measId[1]	2		
measObjectId[1]	IdMeasObject-f8		
reportConfigId[1]	ReportConfigId-CGI		
}			
measObjectToAddModList ::= SEQUENCE (SIZE (1..maxObjectId)) OF SEQUENCE {	1 entry		
measObjectId[1]	IdMeasObject-f8		
measObject[1]	MeasObjectUTRA-CGI		
}			
reportConfigToRemoveList ::= SEQUENCE (SIZE (1..maxReportConfigId)) OF SEQUENCE {			
reportConfigId	IdReportConfig-B2-UTRA		
}			
reportConfigToAddModList ::= SEQUENCE (SIZE (1..maxReportConfigId)) OF SEQUENCE {	1 entry		
reportConfigId[1]	ReportConfigId-CGI		
reportConfig[1]	ReportConfigUTRA-CGI		
}			
measGapConfig CHOICE {			
release	NULL		
}			
}			

Table 8.3.4.4.3.3-10: MeasObjectUTRA-CGI (Step 5, Table 8.3.4.4.3.2-2)

Derivation Path: 36.508 clause 4.6.6 table 4.6.6-3			
Information Element	Value/remark	Comment	Condition
MeasObjectUTRA-CGI ::= SEQUENCE {			
carrierFreq SEQUENCE {	Downlink EARFCN of Cell 5		
cellForWhichToReportCGI	PhysCellId of Cell 5		
}			

Table 8.3.4.4.3.3-11: ReportConfigUTRA-CGI (Step 5, Table 8.3.4.4.3.2-2)

Derivation Path: 36.508, Table 4.6.6-9 ReportConfigInterRAT-PERIODICAL			
Information Element	Value/remark	Comment	Condition
ReportConfigInterRAT-PERIODICAL ::= SEQUENCE {			
triggerType CHOICE {			
periodical SEQUENCE {			
purpose	reportCGI		
}			
}			
reportAmount	r1		
si-RequestForHO	setup		
}			

Table 8.3.4.4.3-12: *MeasurementReport* (Step 7, Table 8.3.4.4.3.2-2)

Derivation path: 36.508 4.6.1 table 4.6.1-5			
Information Element	Value/remark	Comment	Condition
MeasurementReport ::= SEQUENCE {			
criticalExtensions CHOICE {			
c1 CHOICE {			
measurementReport-r8 SEQUENCE {			
measResults ::= SEQUENCE {			
measId	2		
measResultServCell SEQUENCE {		Report Cell 1	
rsrpResult	(0..97)		
rsrqResult	(0..34)		
}			
measResultNeighCells CHOICE {			
measResultListUTRA SEQUENCE (SIZE (1..maxCellReport)) OF SEQUENCE {	1 entry		
physCellId[1]	PhysCellId of Cell 5		
cgi-Info[1] SEQUENCE {			
cellGlobalId	cellGlobalId formed from 'PLMN Identity' and 'Cell Identity' of Cell 5		
locationAreaCode	locationAreaCode of Cell 5		
routingAreaCode	routingAreaCode of Cell 5		
plmn-IdentityList	Not present		
}			
measResult[1] SEQUENCE {			
utra-RSCP	Not present		
utra-EcN0	Not present		
additionalSI-Info-r9 SEQUENCE {			
csg-MemberStatus	member		
csg-Identity	'000 0000 0000 0000 0000 0000 0010'B	CSG ID of Cell 5	
}			
}			
}			
}			
}			
}			
}			

8.3.4.5 Inter-frequency E-UTRAN FDD – FDD / CSG Proximity Indication

8.3.4.5.1 Test Purpose (TP)

(1)

```
with { UE in E-UTRA RRC_CONNECTED state }
ensure that {
  when { UE is configured with the proximity indicator control by sending the
RRCConnectionReconfiguration message with reportProximityConfig and the UE is not in the vicinity of
the CSG cell}
  then { UE is not expected to send any ProximityIndication message set to "entering" proximity }
}
```

(2)

```
with { UE in E-UTRA RRC_CONNECTED state }
ensure that {
  when { UE is configured with the proximity indicator control by sending the
RRCConnectionReconfiguration message with reportProximityConfig and the UE is in the vicinity of the
CSG cell}
  then { The UE is expected to send a ProximityIndication message set to "entering" proximity }
```

}

(3)

```

with { UE in E-UTRA RRC_CONNECTED state }
ensure that {
  when { UE is configured with the proximity indicator control by sending the
  RRCConnectionReconfiguration message with reportProximityConfig and the UE leaves the proximity of
  the CSG cell }
  then { The UE is expected to send a ProximityIndication message set to "leaving" proximity }
}

```

8.3.4.5.2 Conformance requirements

References: The conformance requirements covered in the current TC are specified in: TS 36.331, clauses 5.3.14.1, 5.3.14.2 and 5.3.14.3, and TS 36.133, clause 6.4.1, 6.4.2, A.8.21.1, and A.8.21.2.

[TS 36.331, clause 5.3.14.1]

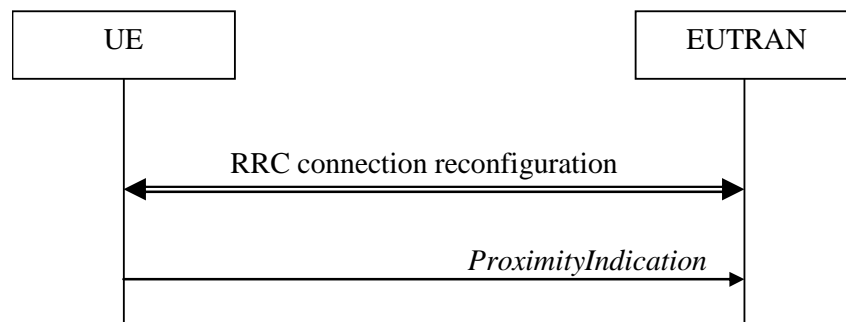

Figure 5.3.14.1-1: Proximity indication

The purpose of this procedure is to indicate that the UE is entering or leaving the proximity of one or more CSG member cells. The detection of proximity is based on an autonomous search function as defined in TS 36.304 [4].

[TS 36.331, clause 5.3.14.2]

A UE in RRC_CONNECTED shall:

- 1> if the UE enters the proximity of one or more CSG member cell(s) on an E-UTRA frequency while proximity indication is enabled for such E-UTRA cells; or
- 1> if the UE enters the proximity of one or more CSG member cell(s) on an UTRA frequency while proximity indication is enabled for such UTRA cells; or
- 1> if the UE leaves the proximity of all CSG member cell(s) on an E-UTRA frequency while proximity indication is enabled for such E-UTRA cells; or
- 1> if the UE leaves the proximity of all CSG member cell(s) on an UTRA frequency while proximity indication is enabled for such UTRA cells:
 - 2> if the UE has previously not transmitted a *ProximityIndication* for the RAT and frequency during the current RRC connection, or if more than 5 s has elapsed since the UE has last transmitted a *ProximityIndication* (either entering or leaving) for the RAT and frequency:
 - 3> initiate transmission of the *ProximityIndication* message in accordance with 5.3.14.3;

NOTE: In the conditions above, "if the UE enters the proximity of one or more CSG member cell(s)" includes the case of already being in the proximity of such cell(s) at the time proximity indication for the corresponding RAT is enabled.

[TS 36.331, clause 5.3.14.3]

The UE shall set the contents of *ProximityIndication* message as follows:

- 1> if the UE applies the procedure to report entering the proximity of CSG member cell(s):
 - 2> set *type* to *entering*;
- 1> else if the UE applies the procedure to report leaving the proximity of CSG member cell(s):
 - 2> set *type* to *leaving*;
- 1> if the proximity indication was triggered for one or more CSG member cell(s) on an E-UTRA frequency:
 - 2> set the *carrierFreq* to *eutra* with the value set to the E-ARFCN value of the E-UTRA cell(s) for which proximity indication was triggered;
- 1> else if the proximity indication was triggered for one or more CSG member cell(s) on a UTRA frequency:
 - 2> set the *carrierFreq* to *utra* with the value set to the ARFCN value of the UTRA cell(s) for which proximity indication was triggered;

The UE shall submit the *ProximityIndication* message to lower layers for transmission.

[TS 36.133, clause 6.4.1]

The requirements defined in this section are applicable to a UE supporting and configured with CSG proximity indication and are valid when a UE is entering the proximity of one or more CSG member cell(s) or leaving the proximity of all CSG member cell(s) on a UTRA or E-UTRA frequency as specified in [2].

The detection of CSG proximity is based on a UE autonomous search function.

[TS 36.133, clause 6.4.2]

The UE shall initiate transmission of the *ProximityIndication* message with “entering” according to [2] within [6] minutes after entering the proximity of one or more CSG member cell(s) on a UTRA or E-UTRA frequency.

The UE shall initiate transmission of the *ProximityIndication* message with “leaving” according to [2] within [6] minutes after leaving the proximity of all CSG member cell(s) on a UTRA or E-UTRA frequency.

There is no need for statistical testing of this requirement.

NOTE: Entering the proximity of one or more CSG member cell(s) means that the UE is near a cell whose CSG ID is in the UE’s CSG whitelist (as determined based on autonomous search procedures). Leaving the proximity of one or more CSG member cell(s) means that the UE is no longer near any cell whose CSG ID is in the UE’s CSG whitelist.

[TS 36.133, clause A.8.21.1]

The purpose of this test is to verify the UE has implemented properly the feature for indicating that the UE is entering or leaving the proximity of one or more CSG member cells based on proximity detection with an autonomous search function, as defined by the requirements in Section 6.4.

The test case consists of three successive segments: Test Preparation, Negative Test, and Positive Test. The test scenario comprises of two E-UTRAN FDD cells on different carriers. Cell 1 represents the serving cell and Cell 2 the CSG cell. Cell 1 is active during the whole test, while Cell 2 is only active in time duration T1 in the Test Preparation. The description of the test procedure is shown in Table A.8.21-1. The general test parameters and cell specific test parameters for the handover from serving cell to CSG cell in Test Preparation and the proximity detection are presented in Table A.8.21-2 and Table A.8.21-3 respectively.

Table A.8.21-1: Description of the test procedures

Parameter	Cell Status	Comment
Test Preparation		
Initial Condition	Cell 1 is active	Clean up the UE memory to be free from previously stored cell information for proximity detection. Configure the UE to include Cell 2's CSG Identity in its whitelist. Turn on the UE and set up connection between the UE and Cell 1.
Time duration T1	Cell 1 and Cell 2	Turn on Cell 2 at the start of T1. Perform manual CSG selection towards Cell 2. The UE is expected to store necessary information experienced during handover for later proximity detection.
End condition	Cell 1 is active	Turn off the UE. Turn off Cell 2.
Negative Test		
Initial Condition	Cell 1 is active	Re-Configure Cell 1 to a different global cell identity to simulate the UE is not in the vicinity of the CSG cell. Turn on the UE and set up connection between the UE and Cell 1.
Time duration T2	Cell 1 is active	Configure the UE with proximity indication control by sending the Reconfiguration message with ReportProximityConfig at the start of T2. The UE is not expected to report "entering" proximity in the negative test.
End condition	Cell 1 is active	Turn off the UE.
Positive Test		
Initial Condition	Cell 1 is active	Re-Configure Cell 1 to the same global cell identity as in the Test Preparation, under which the UE was manually selected towards the CSG cell. Turn on the UE and set up connection between the UE and Cell 1.
Time duration T3	Cell 1 and Cell 2 are active	Configure the UE with proximity indication control by sending the Reconfiguration message with reportProximityConfig at the start of T3. The UE is expected to report "entering" proximity before end of T3.
Time duration T4	Cell 1 is active	Re-Configure Cell 1 to a different global cell identity to simulate the situation that UE leaves the proximity of the CSG cell. The UE is expected to report "leaving" proximity before end of T4.
End condition	Cell 1 is active	Turn off the UE.

Table A.8.21-2: General test parameters for E-UTRAN FDD-FDD inter frequency cell proximity detection test case

Parameter	Unit	Value	Comment
PDSCH parameters		DL Reference Measurement Channel R.0 FDD	As specified in section A.3.1.1.1
PDSCH allocation	n_{PRB}	2—3	13—36
PCFICH/PDCCH/PHICH parameters		DL Reference Measurement Channel R.6 FDD	As specified in section A.3.1.2.1
A3-Offset	dB	-4	
Hysteresis	dB	0	
TimeToTrigger	s	0	
Filter coefficient		0	L3 filtering is not used
DRX		off	As specified in section A.3.3
PRACH configuration		4	As specified in table 5.7.1-2 in 3GPP TS 36.211
Access Barring Information	-	Not sent	No additional delays in random access procedure
Time offset between cells		3 ms	Asynchronous cells
Gap pattern configuration Id		0	As specified in Table 8.1.2.1-1 started before T1 starts
Time duration T1	s	[10]	Defined to give enough time for completing the handover from serving cell to the CSG cell successfully.
Time duration T2	s	[360]	Defined to be longer enough to see whether the UE will report enter "proximity" indication.
Time duration T3 ^{Note 1}	s	[<=360]	The time duration for a UE to report enters "proximity" when the UE is near a CSG cell.
Time duration T4 ^{Note 1}	s	[<=360]	The time duration for a UE to report leaving "proximity" when the UE is no longer nears a CSG cell.
<p>Note 1: The maximum allowed time duration for the UE to decide either entering or leaving "proximity" is 360s. To reduce test time, T3 may end once UE reports entering "proximity" and T4 may end once UE reports leaving "proximity".</p> <p>Note 2: The test case assumes an environment where CSG proximity detection results not being impact by non-3GPP signals, such as GPS and WiFi. When the test case is being executed, the UE may ignore any radio signals which are not provided by the test setup which it would otherwise use in proximity estimation.</p>			

Table A.8.21-3: Cell specific test parameters for E-UTRAN FDD-FDD inter frequency cell proximity detection test case

Parameter	Unit	Cell 1				Cell 2			
		T1	T2	T3	T4	T1	T2	T3	T4

E-UARFCN		Channel 1				Channel 2			
CSG indicator		False				True	N/A	True	N/A
Physical cell global identity		1	2	1	3	3	N/A	N/A	N/A
CSG identity		Not sent				Sent	N/A	Sent	N/A
$BW_{channel}$	MHz	10				10			
OCNG Patterns defined in A.3.2.1.1 (OP.1 FDD) and in A.3.2.1.2 (OP.2 FDD)		OP.1 FDD	OP.2 FDD	OP.2 FDD	OP.2 FDD	OP.2 FDD	N/A	OP.2 FDD	N/A
PBCH_RA	dB	0				0			
PBCH_RB	dB								
PSS_RA	dB								
SSS_RA	dB								
PCFICH_RB	dB								
PHICH_RA	dB								
PHICH_RB	dB								
PDCCH_RA	dB								
PDCCH_RB	dB								
PDSCH_RA	dB								
PDSCH_RB	dB								
OCNG_RA ^{Note 1}	dB								
OCNG_RB ^{Note 1}	dB								
\hat{E}_s / I_{ot}	dB								
N_{oc} ^{Note 2}	dBm/15 kHz	-98				-98			
\hat{E}_s / N_{oc}	dB	0	4	4	4	7	-inf	7	-inf
RSRP ^{Note 3}	dBm/15 KHz	-98	-94	-94	-94	-91	-inf	-91	-inf
Propagation Condition		AWGN				AWGN			
<p>Note 1: OCNG shall be used such that both cells are fully allocated and a constant total transmitted power spectral density is achieved for all OFDM symbols.</p> <p>Note 2: Interference from other cells and noise sources not specified in the test is assumed to be constant over subcarriers and time and shall be modelled as AWGN of appropriate power for N_{oc} to be fulfilled.</p> <p>Note 3: RSRP levels have been derived from other parameters for information purposes. They are not settable parameters themselves.</p>									

[TS 36.133, A.8.21.2]

The UE shall not send an “entering” proximity indication in T2 during Negative Test.

The UE shall send an “entering” proximity indication in T3 and send a “leaving” proximity indication in T4 during Positive Test.

8.3.4.5.3 Test description

8.3.4.5.3.1 Pre-test conditions

System Simulator:

- Cell 1, Cell 2 and Cell 23 are used.
- Cell 1 and Cell 2 are not CSG cells.
- Cell 23 is a CSG cell.
- System information combination 7 as defined in TS 36.508 [18] clause 4.4.3.1 is used in E-UTRA Cell 23.

UE:

- The UE's Allowed CSG list contains the CSG ID of Cell 23.
- The UE memory shall be cleaned up to be free from previously stored cell information for proximity detection [method how to achieve this is TBD].

- The UE non-3GPP radio receivers shall be switched off [method how to achieve this is TBD].

Preamble:

- The UE is in state Switched OFF (state 1) according to [18].

8.3.4.5.3.2 Test procedure sequence

Table 8.3.4.5.3.2-1 illustrates the downlink power levels to be applied for Cell 1, Cell 2 and Cell 23 at various time instants of the test execution. The exact instants on which these values shall be applied are described in the texts in this clause.

Table 8.3.4.5.3.2-1: Time instances of cell power level and parameter changes

	Parameter	Unit	Cell 1	Cell 2	Cell 23	Remark
T0	Cell-specific RS EPRE	dBm/1 5kHz	-85	Off	Off	The power level values are assigned to such that camping on Cell 1 is guaranteed. Cell 2 and Cell 23 are "Off".
T1	Cell-specific RS EPRE	dBm/1 5kHz	-85	Off	-79	
T2	Cell-specific RS EPRE	dBm/1 5kHz	- Off	-85	Off	The power level values are assigned to such that camping on Cell 2 is guaranteed. Cell 1 and Cell 23 are "Off".
T3	Cell-specific RS EPRE	dBm/1 5kHz	-85	Off	Off	The power level values are assigned to such that camping on Cell 1 is guaranteed. Cell 2 and Cell 23 are "Off".
T4	Cell-specific RS EPRE	dBm/1 5kHz	-85	Off	-79	
T5	Cell-specific RS EPRE	dBm/1 5kHz	-91	-85	Off	

Table 8.3.4.5.3.2-2: Main behaviour

St	Procedure	Message Sequence		TP	Verdict
		U - S	Message		
1	The SS adjusts cell levels according to row T0 of Table 8.3.4.5.3.2-1	-	-	-	-
2	Power on the UE.	-	-	-	-
3-18	Steps 2 to 17 of the registration procedure described in TS 36.508 subclause 4.5.2.3 are performed on Cell 1. NOTE: The UE performs registration and the RRC connection is released.	-	-	-	-
19	The SS adjusts cell levels according to row T1 of Table 8.3.4.5.3.2-1	-	-	-	-
20	The UE is made to perform manual CSG ID selection and select Cell 23.	-	-	-	-
21-26	Steps 1 to 6 of the TAU procedure described in TS 36.508 subclause 6.4.2.7 are performed on Cell 23. NOTE: the UE performs a TAU and the RRC connection is released.	-	-	-	-
27	Power off the UE.	-	-	-	-
28	The SS adjusts cell levels according to row T2 of Table 8.3.4.5.3.2-1	-	-	-	-
29	Power on the UE.	-	-	-	-
30-45	Steps 2 to 17 of the registration procedure described in TS 36.508 subclause 4.5.2.3 are performed on Cell 2. NOTE: The UE performs registration and the RRC connection is released.	-	-	-	-
46-53	Steps 2 to 9 of the generic test procedure in TS 36.508 subclause 4.5.3.3 are performed on Cell 2. NOTE: The UE performs the establishment of the new data radio bearer associated with the default EPS bearer context.	-	-	-	-
54	The SS transmits an <i>RRCCConnectionReconfiguration</i> message on Cell 2 including <i>proximityIndicationEUTRA-r9</i> set to enabled.	<--	<i>RRCCConnectionReconfiguration</i>	-	-
55	The UE transmits an <i>RRCCConnectionReconfigurationComplete</i> message.	-->	<i>RRCCConnectionReconfigurationComplete</i>	-	-
56	Check: Does the UE transmit a <i>ProximityIndication</i> message with <i>type-r9</i> set to "entering" proximity on Cell 2 within [360]s?	-->	<i>ProximityIndication</i>	1	F
57	Power off the UE.				
58	The SS adjusts cell levels according to row T3 of Table 8.3.4.5.3.2-1	-	-	-	-
59	Power on the UE.	-	-	-	-
60-75	Steps 2 to 17 of the registration procedure described in TS 36.508 subclause 4.5.2.3 are performed on Cell 1. NOTE: The UE performs registration and the RRC connection is released.	-	-	-	-
76-83	Steps 2 to 9 of the generic test procedure in TS 36.508 subclause 4.5.3.3 are performed on Cell 1. NOTE: The UE performs the establishment of the new data radio bearer associated with the default EPS bearer context.	-	-	-	-
84	The SS transmits an <i>RRCCConnectionReconfiguration</i> message on Cell 1 including <i>proximityIndicationEUTRA-r9</i> set to enabled.	<--	<i>RRCCConnectionReconfiguration</i>	-	-
85	The UE transmits an <i>RRCCConnectionReconfigurationComplete</i>	-->	<i>RRCCConnectionReconfigurationComplete</i>	-	-

	message.				
86	The SS adjusts cell levels according to row T4 of Table 8.3.4.5.3.2-1	-	-	-	-
87	Check: Does the UE transmit a <i>ProximityIndication</i> message with <i>type-r9</i> set to "entering" proximity on Cell 1 within [360]s?	-->	<i>ProximityIndication</i>	2	P
88	The SS adjusts cell levels according to row T5 of Table 8.3.4.5.3.2-1	-	-	-	-
89	The SS transmits an <i>RRCCoReonfiguration</i> message to order the UE to perform intra frequency handover to Cell 2 and 2 including <i>proximityIndicationEUTRA-r9</i> set to enabled.	<--	<i>RRCCoReonfiguration</i>	-	-
90	The UE transmits an <i>RRCCoReonfigurationComplete</i> message on Cell 2 to confirm the successful completion of the intra frequency handover.	-->	<i>RRCCoReonfigurationC omplete</i>	-	-
91	Check: Does the UE transmit a <i>ProximityIndication</i> message with <i>type-r9</i> set to "leaving" proximity on Cell 2 within [360]s?	-->	<i>ProximityIndication</i>	3	P

8.3.4.5.3.3 Specific message contents

Table 8.3.4.5.3.3-1: *SystemInformationBlockType1* for Cell 23 (preamble and all steps, Table 8.3.4.5.3.2-2)

Derivation Path: 36.508 clause 4.4.3.2			
Information Element	Value/remark	Comment	Condition
<i>SystemInformationBlockType1</i> ::= SEQUENCE {			
<i>cellAccessRelatedInfo</i> SEQUENCE {			
<i>csg-Indication</i>	TRUE		
<i>csg-Identity</i>	'000 0000 0000 0000 0000 0000 1011'B		
}			
}			

Table 8.3.4.5.3.3-2: *SystemInformationBlockType4* for Cell 23 (preamble and all steps, Table 8.3.4.5.3.2-2)

Derivation Path: 36.508 clause 4.4.3.3, Table 4.4.3.3-3			
Information Element	Value/remark	Comment	Condition
<i>SystemInformationBlockType4</i> ::= SEQUENCE {			
<i>csg-PhysCellIdRange</i> ::= SEQUENCE {			
Start	2		
Range	n4		
}			
}			

Table 8.3.4.5.3.3-3: RRCConnectionReconfiguration (Step 54 and Step 84, Table 8.3.4.5.3.2-2)

Derivation Path: 36.508 clause 4.6.1 table 4.6.1-8			
Information Element	Value/remark	Comment	Condition
RRCConnectionReconfiguration ::= SEQUENCE {			
criticalExtensions CHOICE {			
c1 CHOICE{			
rrcConnectionReconfiguration-r8 SEQUENCE {			
nonCriticalExtension SEQUENCE {			
nonCriticalExtension SEQUENCE {			
otherConfig-r9 ::= SEQUENCE {			
reportProximityConfig-r9			
proximityIndicationEUTRA-r9	enabled		
}			
nonCriticalExtension	Not present		
}			
}			
}			
}			

Table 8.3.4.5.3.3-4: RRCConnectionReconfiguration (step 89, Table 8.3.4.5.3.2-2)

Derivation Path: 36.508, Table 4.6.1-8, condition HO			
Information Element	Value/remark	Comment	Condition
RRCConnectionReconfiguration ::= SEQUENCE {			
criticalExtensions CHOICE {			
c1 CHOICE{			
rrcConnectionReconfiguration-r8 SEQUENCE {			
nonCriticalExtension SEQUENCE {			
nonCriticalExtension SEQUENCE {			
otherConfig-r9 ::= SEQUENCE {			
reportProximityConfig-r9			
proximityIndicationEUTRA-r9	enabled		
}			
nonCriticalExtension	Not present		
}			
}			
}			
}			

Table 8.3.4.5.3.3-5: ProximityIndication (Step 87 and Step 56, Table 8.3.4.5.3.2-2)

Derivation Path: 36.331 clause 6.2.2			
Information Element	Value/remark	Comment	Condition
ProximityIndication-r9 ::= SEQUENCE {			
criticalExtensions CHOICE {			
c1 CHOICE{			
proximityIndication-r9 ::= SEQUENCE {			
type-r9	entering		
carrierFreq-r9 CHOICE {			
eutra-r9	Downlink EARFCN of Cell 23		
}			
nonCriticalExtension	Not present		
}			
}			

Table 8.3.4.5.3.3-6: ProximityIndication (Step 91, Table 8.3.4.5.3.2-2)

Derivation Path: 36.331 clause 6.2.2			
Information Element	Value/remark	Comment	Condition
ProximityIndication-r9 ::= SEQUENCE {			
criticalExtensions CHOICE {			
c1 CHOICE{			
proximityIndication-r9 ::= SEQUENCE {			
type-r9	leaving		
carrierFreq-r9 CHOICE {			
eutra-r9	Downlink EARFCN of Cell 23		
}			
nonCriticalExtension	Not present		
}			
}			
}			
}			
}			

8.4 Inter-RAT handover

8.4.1 Inter-RAT handover E-UTRA to UTRA

8.4.1.1 Void

8.4.1.2 Inter-RAT handover / From E-UTRA to UTRA PS / Data

8.4.1.2.1 Test Purpose (TP)

(1)

```
with { UE in E-UTRA RRC_CONNECTED state }
ensure that {
  when { UE receives a MobilityFromEUTRACommand message and a DPCH PS RAB combination is configured
  for an UTRA cell }
  then { UE transmits a HANDOVER TO UTRAN COMPLETE message on the utra cell }
}
```

8.4.1.2.2 Conformance requirements

References: The conformance requirements covered in the present TC are specified in: TS 36.331, clause 5.4.3.3.

[TS 36.331, clause 5.4.3.3]

The UE shall be able to receive a *MobilityFromEUTRACommand* message and perform a cell change order to GERAN, even if no prior UE measurements have been performed on the target cell.

The UE shall:

- 1> stop timer T310, if running;
- 1> if the *MobilityFromEUTRACommand* message includes the *purpose* set to 'handover':
 - 2> if the *targetRAT-Type* is set to 'utra' or 'geran':
 - 3> consider inter-RAT mobility as initiated towards the RAT indicated by the *targetRAT-Type* included in the *MobilityFromEUTRACommand* message;
 - 3> forward the *nas-SecurityParamFromEUTRA* to the upper layers;
 - 3> access the target cell indicated in the inter-RAT message in accordance with the specifications of the target RAT;

8.4.1.2.3 Test description

8.4.1.2.3.1 Pre-test conditions

System Simulator:

- Cell 1 and Cell 5.
- System information combination 4 as defined in TS 36.508 [18] clause 4.4.3.1 is used in E-UTRA cells.

UE:

- The UE is previously registered on cell 5.

Preamble:

- The UE is in state Generic RB Established (state 3) on Cell 1 according to [18].

8.4.1.2.3.2 Test procedure sequence

Table 8.4.1.2.3.2-1: Main behaviour

St	Procedure	Message Sequence		TP	Verdict
		U - S	Message		
1	The SS configures UTRA cell 5 to reference configuration according 36.508 table 4.8.3-1, condition UTRA PS RB.	-	-	-	-
1A	The SS transmits a <i>UECapabilityEnquiry</i> message to request UE radio access capability information for E-UTRA and UTRA.	<--	<i>UECapabilityEnquiry</i>	-	-
1B	The UE transmit a <i>UECapabilityInformation</i> message on Cell 1. NOTE: The start-PS values received, should be used to configure ciphering on cell 5.	-->	<i>UECapabilityInformation</i>	-	-
2	The SS transmits a <i>MobilityFromEUTRACommand</i> message on Cell 1.	<--	<i>MobilityFromEUTRACommand</i>	-	-
3	Check: Does the UE transmit a HANDOVER TO UTRAN COMPLETE message on cell 5?	-->	HANDOVER TO UTRAN COMPLETE	1	P
4	The SS transmits a SECURITY MODE COMMAND message on Cell 5 in order to activate integrity protection.	<--	SECURITY MODE COMMAND	-	-
5	The UE transmits a SECURITY MODE COMPLETE message on Cell 5.	-->	SECURITY MODE COMPLETE	-	-
6	The SS transmits an UTRAN MOBILITY INFORMATION message to notify CN information on Cell 5.	<--	UTRAN MOBILITY INFORMATION	-	-
7	The UE transmits an UTRAN MOBILITY INFORMATION CONFIRM message on Cell 5.	-->	UTRAN MOBILITY INFORMATION CONFIRM	-	-

8.4.1.2.3.3 Specific message contents

Table 8.4.1.2.3.3-1: *MobilityFromEUTRACommand* (step 2, Table 8.4.1.2.3.2-1)

Derivation Path: 36.508 table 4.6.1-6			
Information Element	Value/remark	Comment	Condition
MobilityFromEUTRACommand ::= SEQUENCE {			
criticalExtensions CHOICE {			
c1 CHOICE{			
mobilityFromEUTRACommand-r8 SEQUENCE {			
purpose CHOICE {			
handover SEQUENCE {			
targetRAT-Type	utra		
targetRAT-MessageContainer	HANDOVER TO UTRAN COMMAND		
nas-SecurityParamFromEUTRA	The 4 least significant bits of the NAS downlink COUNT value		
systemInformation	Not present		
}			
}			
}			
}			
}			

Table 8.4.1.2.3.3-2: HANDOVER TO UTRAN COMMAND (Table 8.4.1.2.3.3-1)

Derivation Path: 36.508 table 4.7B.1-1, condition UTRA PS RB
--

Table 8.4.1.2.3.3-3: SECURITY MODE COMMAND (step 4, Table 8.4.1.2.3.2-1)

Derivation Path: 34.108 clause 9.1.1 (SECURITY MODE COMMAND message)		
Information Element	Condition	Value/remark
Ciphering mode info		Not Present

Table 8.4.1.2.3.3-4: UTRAN MOBILITY INFORMATION (step 6, Table 8.4.1.2.3.2-1)

Derivation Path: 34.108 clause 9.1.1 (UTRAN MOBILITY INFORMATION message)	
Information Element	Value/remark
CN information info	
- PLMN identity	
- MCC	001
- MNC	01
- CN common GSM-MAP NAS system information	00 01H
- CN domain information list full	
- CN domain identity	PS
- CN domain specific NAS system information	01 00H
- DRX cycle length coefficient	7
- CN domain identity	CS
- CN domain specific NAS system information	1E 01H
- DRX cycle length coefficient	7

Table 8.4.1.2.3.3-5: UECapabilityEnquiry (step 1A, Table 8.4.1.2.3.2-1)

Derivation path: 36.508 clause 4.6.1 table 4.6.1-22			
Information Element	Value/Remark	Comment	Condition
UECapabilityEnquiry ::= SEQUENCE {			
criticalExtensions CHOICE {			
c1 CHOICE {			
ueCapabilityEnquiry-r8 SEQUENCE {			
ue-CapabilityRequest SEQUENCE (SIZE (1..maxRAT-Capabilities)) OF SEQUENCE {	2 entry		
RAT-Type[1]	eutra		
RAT-Type[2]	utra		
}			
}			
}			
}			
}			

8.4.1.3 Void

8.4.1.4 Inter-RAT handover / From E-UTRA to UTRA HSDPA / Data

8.4.1.4.1 Test Purpose (TP)

(1)

```

with { UE in E-UTRA RRC_CONNECTED state }
ensure that {
  when { UE receives a MobilityFromEUTRACommand message and a DPCCH and HS-PDSCH PS RAB combination
is configured for an UTRA cell}
  then { UE transmits a HANDOVER TO UTRAN COMPLETE message on the utra cell}
}

```

8.4.1.4.2 Conformance requirements

References: The conformance requirements covered in the present TC are specified in: TS 36.331, clause 5.4.3.3.

[TS 36.331, clause 5.4.3.3]

The UE shall be able to receive a *MobilityFromEUTRACommand* message and perform a cell change order to GERAN, even if no prior UE measurements have been performed on the target cell.

The UE shall:

- 1> stop timer T310, if running;
- 1> if the *MobilityFromEUTRACommand* message includes the *purpose* set to 'handover':
 - 2> if the *targetRAT-Type* is set to 'utra' or 'geran':
 - 3> consider inter-RAT mobility as initiated towards the RAT indicated by the *targetRAT-Type* included in the *MobilityFromEUTRACommand* message;
 - 3> forward the *nas-SecurityParamFromEUTRA* to the upper layers;
 - 3> access the target cell indicated in the inter-RAT message in accordance with the specifications of the target RAT;

8.4.1.4.3 Test description

8.4.1.4.3.1 Pre-test conditions

System Simulator:

- Cell 1 and Cell 5.
- System information combination 4 as defined in TS 36.508 [18] clause 4.4.3.1 is used in E-UTRA cells.

UE:

- The UE is previously registered on cell 5.

Preamble:

- The UE is in state Generic RB Established (state 3) on Cell 1 according to [18].

8.4.1.4.3.2 Test procedure sequence

Table 8.4.1.4.3.2-1: Main behaviour

St	Procedure	Message Sequence		TP	Verdict
		U - S	Message		
1	The SS configures UTRA cell 5 to reference configuration according 36.508 table 4.8.3-1, condition UTRA HSDPA RB..	-	-	-	-
1A	The SS transmits a <i>UECapabilityEnquiry</i> message to request UE radio access capability information for E-UTRA and UTRA.	<--	<i>UECapabilityEnquiry</i>	-	-
1B	The UE transmit a <i>UECapabilityInformation</i> message on Cell 1. NOTE: The start-PS values received, should be used to configure ciphering on cell 5.	-->	<i>UECapabilityInformation</i>	-	-
2	The SS transmits a <i>MobilityFromEUTRACommand</i> message on Cell 1.	<--	<i>MobilityFromEUTRACommand</i>	-	-
3	Check: Does the UE transmit a HANDOVER TO UTRAN COMPLETE message on cell 5?	-->	HANDOVER TO UTRAN COMPLETE	1	P
4	The SS transmits a SECURITY MODE COMMAND message on Cell 5 in order to activate integrity protection.	<--	SECURITY MODE COMMAND	-	-
5	The UE transmits a SECURITY MODE COMPLETE message on Cell 5.	-->	SECURITY MODE COMPLETE	-	-
6	The SS transmits an UTRAN MOBILITY INFORMATION message to notify CN information on Cell 5.	<--	UTRAN MOBILITY INFORMATION	-	-
7	The UE transmits an UTRAN MOBILITY INFORMATION CONFIRM message on Cell 5.	-->	UTRAN MOBILITY INFORMATION CONFIRM	-	-

8.4.1.4.3.3 Specific message contents

Table 8.4.1.4.3.3-1: *MobilityFromEUTRACommand* (step 2, Table 8.4.1.4.3.2-1)

Derivation Path: 36.508 table 4.6.1-6			
Information Element	Value/remark	Comment	Condition
MobilityFromEUTRACommand ::= SEQUENCE {			
criticalExtensions CHOICE {			
c1 CHOICE{			
mobilityFromEUTRACommand-r8 SEQUENCE {			
purpose CHOICE {			
handover SEQUENCE {			
targetRAT-Type	utra		
targetRAT-MessageContainer	HANDOVER TO UTRAN COMMAND		
nas-SecurityParamFromEUTRA	The 4 least significant bits of the NAS downlink COUNT value		
systemInformation	Not present		
}			
}			
}			
}			
}			

Table 8.4.1.4.3.3-2: HANDOVER TO UTRAN COMMAND (Table 8.4.1.4.3.3-1)

Derivation Path: 36.508 table 4.7B.1-1, condition UTRA HSDPA RB

Table 8.4.1.4.3.3-3: SECURITY MODE COMMAND (step 4, Table 8.4.1.4.3.2-1)

Derivation Path: 34.108 clause 9.1.1 (SECURITY MODE COMMAND message)		
Information Element	Condition	Value/remark
Ciphering mode info		Not Present

Table 8.4.1.4.3.3-4: UTRAN MOBILITY INFORMATION (step 6, Table 8.4.1.4.3.2-1)

Derivation Path: 34.108 clause 9.1.1 (UTRAN MOBILITY INFORMATION message)	
Information Element	Value/remark
CN information info	
- PLMN identity	
- MCC	001
- MNC	01
- CN common GSM-MAP NAS system information	00 01H
- CN domain information list full	
- CN domain identity	PS
- CN domain specific NAS system information	01 00H
- DRX cycle length coefficient	7
- CN domain identity	CS
- CN domain specific NAS system information	1E 01H
- DRX cycle length coefficient	7

Table 8.4.1.4.3.3-5: UECapabilityEnquiry (step 1A, Table 8.4.1.4.3.2-1)

Derivation path: 36.508 clause 4.6.1 table 4.6.1-22			
Information Element	Value/Remark	Comment	Condition
UECapabilityEnquiry ::= SEQUENCE {			
criticalExtensions CHOICE {			
c1 CHOICE {			
ueCapabilityEnquiry-r8 SEQUENCE {			
ue-CapabilityRequest SEQUENCE (SIZE (1..maxRAT-Capabilities)) OF SEQUENCE {	2 entry		
RAT-Type[1]	eutra		
RAT-Type[2]	utra		
}			
}			
}			
}			
}			

8.4.1.5 Inter-RAT Handover / from E-UTRA to UTRA(HSUPA/HSDPA) / Data

8.4.1.5.1 Test Purpose (TP)

(1)

```

with { UE in E-UTRA RRC_CONNECTED state }
ensure that {
  when { UE receives a MobilityFromEUTRACommand message and a E-DCH and HS-DSCH PS RAB combination
is configured for an UTRA cell}
  then { UE transmits a HANDOVER TO UTRAN COMPLETE message on the utra cell}
}

```

8.4.1.5.2 Conformance requirements

References: The conformance requirements covered in the present TC are specified in: TS 36.331, clause 5.4.3.3.

[TS 36.331, clause 5.4.3.3]

The UE shall be able to receive a *MobilityFromEUTRACommand* message and perform a cell change order to GERAN, even if no prior UE measurements have been performed on the target cell.

The UE shall:

- 1> stop timer T310, if running;
- 1> if the *MobilityFromEUTRACommand* message includes the *purpose* set to 'handover':
 - 2> if the *targetRAT-Type* is set to 'utra' or 'geran':
 - 3> consider inter-RAT mobility as initiated towards the RAT indicated by the *targetRAT-Type* included in the *MobilityFromEUTRACommand* message;
 - 3> forward the *nas-SecurityParamFromEUTRA* to the upper layers;
 - 3> access the target cell indicated in the inter-RAT message in accordance with the specifications of the target RAT;

8.4.1.5.3 Test description

8.4.1.5.3.1 Pre-test conditions

System Simulator:

- Cell 1 and Cell 5.
- System information combination 4 as defined in TS 36.508 [18] clause 4.4.3.1 is used in E-UTRA cells.

UE:

- The UE is previously registered on cell 5.

Preamble:

- The UE is in state Generic RB Established (state 3) on Cell 1 according to [18].

8.4.1.5.3.2 Test procedure sequence

Table 8.4.1.5.3.2-1: Main behaviour

St	Procedure	Message Sequence		TP	Verdict
		U - S	Message		
1	The SS configures UTRA cell 5 to reference configuration according 36.508 table 4.8.3-1, condition UTRA HSUPA/HSDPA RB.	-	-	-	-
1A	The SS transmits a <i>UECapabilityEnquiry</i> message to request UE radio access capability information for E-UTRA and UTRA.	<--	<i>UECapabilityEnquiry</i>	-	-
1B	The UE transmit a <i>UECapabilityInformation</i> message on Cell 1. NOTE: The start-PS values received, should be used to configure ciphering on cell 5.	-->	<i>UECapabilityInformation</i>	-	-
2	The SS transmits a <i>MobilityFromEUTRACommand</i> message on Cell 1.	<--	<i>MobilityFromEUTRACommand</i>	-	-
3	Check: Does the UE transmit a HANOVER TO UTRAN COMPLETE message on cell 5?	-->	HANOVER TO UTRAN COMPLETE	1	P
4	The SS transmits a SECURITY MODE COMMAND message on Cell 5 in order to activate integrity protection.	<--	SECURITY MODE COMMAND	-	-
5	The UE transmits a SECURITY MODE COMPLETE message on Cell 5.	-->	SECURITY MODE COMPLETE	-	-
6	The SS transmits an UTRAN MOBILITY INFORMATION message to notify CN information on Cell 5.	<--	UTRAN MOBILITY INFORMATION	-	-
7	The UE transmits an UTRAN MOBILITY INFORMATION CONFIRM message on Cell 5.	-->	UTRAN MOBILITY INFORMATION CONFIRM	-	-

8.4.1.5.3.3 Specific message contents

Table 8.4.1.5.3.3-1: MobilityFromEUTRACommand (step 2, Table 8.4.1.5.3.2-1)

Derivation Path: 36.508 table 4.6.1-6			
Information Element	Value/remark	Comment	Condition
MobilityFromEUTRACommand ::= SEQUENCE {			
criticalExtensions CHOICE {			
c1 CHOICE{			
mobilityFromEUTRACommand-r8 SEQUENCE {			
purpose CHOICE {			
handover SEQUENCE {			
targetRAT-Type	utra		
targetRAT-MessageContainer	HANDOVER TO UTRAN COMMAND		
nas-SecurityParamFromEUTRA	The 4 least significant bits of the NAS downlink COUNT value		
systemInformation	Not present		
}			
}			
}			
}			
}			
}			
}			

Table 8.4.1.5.3.3-2: HANDOVER TO UTRAN COMMAND (Table 8.4.1.5.3.3-1)

Derivation Path: 36.508 table 4.7B.1-1, condition UTRA HSUPA/HSDPA RB

Table 8.4.1.5.3.3-3: SECURITY MODE COMMAND (step 4, Table 8.4.1.5.3.2-1)

Derivation Path: 34.108 clause 9.1.1 (SECURITY MODE COMMAND message)		
Information Element	Condition	Value/remark
Ciphering mode info		Not Present

Table 8.4.1.5.3.3-4: UTRAN MOBILITY INFORMATION (step 6, Table 8.4.1.5.3.2-1)

Derivation Path: 34.108 clause 9.1.1 (UTRAN MOBILITY INFORMATION message)	
Information Element	Value/remark
CN information info	
- PLMN identity	
- MCC	001
- MNC	01
- CN common GSM-MAP NAS system information	00 01H
- CN domain information list full	
- CN domain identity	PS
- CN domain specific NAS system information	01 00H
- DRX cycle length coefficient	7
- CN domain identity	CS
- CN domain specific NAS system information	1E 01H
- DRX cycle length coefficient	7

Table 8.4.1.5.3.3-5: UECapabilityEnquiry (step 1A, Table 8.4.1.5.3.2-1)

Derivation path: 36.508 clause 4.6.1 table 4.6.1-22			
Information Element	Value/Remark	Comment	Condition
UECapabilityEnquiry ::= SEQUENCE {			
criticalExtensions CHOICE {			
c1 CHOICE {			
ueCapabilityEnquiry-r8 SEQUENCE {			
ue-CapabilityRequest SEQUENCE (SIZE (1..maxRAT-Capabilities)) OF SEQUENCE {	2 entry		
RAT-Type[1]	eutra		
RAT-Type[2]	utra		
}			
}			
}			
}			
}			

8.4.2 Inter-RAT handover UTRA to E-UTRA

8.4.2.1 Void

8.4.2.2 Inter-RAT handover / From UTRA PS to E-UTRA / Data

8.4.2.2.1 Test Purpose (TP)

(1)

```
with { UE in UTRA CELL_DCH(PD-DCCH+DTCH_DCH) state }
ensure that {
  when { UE receives a HANDOVER FROM UTRAN COMMAND message including the eutra-Message }
  then { UE transmits an RRCConnectionReconfigurationComplete message and enters E-UTRA
RRC_CONNECTED state }
}
```

8.4.2.2.2 Conformance requirements

References: The conformance requirements covered in the present TC are specified in: TS 36.331, clause 5.4.2.3.

[TS 36.331, clause 5.4.2.3]

If the UE is able to comply with the configuration included in the *RRCConnectionReconfiguration* message, the UE shall:

- 1> apply the default physical channel configuration as specified in 9.2.4;
- 1> apply the default semi-persistent scheduling configuration as specified in 9.2.3;
- 1> apply the default MAC main configuration as specified in 9.2.2;
- 1> start timer T304 with the timer value set to *t304*, as included in the *mobilityControlInfo*;
- 1> consider the target cell to be one on the frequency indicated by the *carrierFreq* with a physical cell identity indicated by the *targetPhysCellId*;
- 1> start synchronising to the DL of the target cell;
- 1> set the C-RNTI to the value of the *newUE-Identity*;
- 1> for the target cell, apply the downlink bandwidth indicated by the *dl-Bandwidth*;
- 1> for the target cell, apply the uplink bandwidth indicated by (the absence or presence of) the *ul-Bandwidth*;
- 1> perform the radio resource configuration procedure as specified in 5.3.10;
- 1> forward the *nas-SecurityParamToEUTRA* to the upper layers;

- 1> derive the K_{eNB} key, as specified in TS 33.401 [32];
- 1> store the *nextHopChainingCount* value;
- 1> derive the K_{RRCint} key associated with the *integrityProtAlgorithm*, as specified in TS 33.401 [32];
- 1> derive the K_{RRCenc} key and the K_{UPenc} key associated with the *cipheringAlgorithm*, as specified in TS 33.401 [32];
- 1> configure lower layers to apply the indicated integrity protection algorithm and the K_{RRCint} key immediately, i.e. the indicated integrity protection configuration shall be applied to all subsequent messages received and sent by the UE, including the message used to indicate the successful completion of the procedure;
- 1> configure lower layers to apply the indicated ciphering algorithm, the K_{RRCenc} key and the K_{UPenc} key immediately, i.e. the indicated ciphering configuration shall be applied to all subsequent messages received and sent by the UE, including the message used to indicate the successful completion of the procedure;
- 1> if the *RRCConnectionReconfiguration* message includes the *measConfig*:
 - 2> perform the measurement configuration procedure as specified in 5.5.2;
- 1> submit the *RRCConnectionReconfigurationComplete* message to lower layers for transmission using the new configuration;
- 1> use the default values specified in 9.2.5 for timer T310, T311 and constant N310, N311;
- 1> if MAC successfully completes the random access procedure:
 - 2> stop timer T304;
 - 2> apply the parts of the configuration that do not require the UE to know the SFN of the target cell;
 - 2> apply the parts of the measurement and the radio resource configuration that require the UE to know the SFN of the target cell (e.g. measurement gaps, periodic CQI reporting, scheduling request configuration, sounding RS configuration), if any, upon acquiring the SFN of the target cell;
 - 2> enter E-UTRA RRC_CONNECTED, upon which the procedure ends;

8.4.2.2.3 Test description

8.4.2.2.3.1 Pre-test conditions

System Simulator:

- Cell 1 and Cell 5.
- System information combination 4 as defined in TS 36.508 [18] clause 4.4.3.1 is used in E-UTRA cells.

UE:

None.

Preamble:

- The UE is in state Registered, Idle mode (state 2) on Cell 1 (serving cell) according to [18].

8.4.2.2.3.2 Test procedure sequence

Table 8.4.2.2.3.2-1 illustrates the downlink power levels and other changing parameters to be applied for the cells at various time instants of the test execution. Subsequent configurations marked "T1" and "T2" are applied at the points indicated in the Main behaviour description in Table 8.4.2.2.3.2-2.

Table 8.4.2.3.2-1: Time instances of cell power level and parameter changes

	Parameter	Unit	Cell 1	Cell 5	Remark
T1	Cell-specific RS EPRE	dBm/15k Hz	-90	-	The power level values are assigned to satisfy $\text{Thresh}_{x,\text{high}} < \text{SrxleV}_{\text{cell } 5}$.
	CPICH Ec (UTRA FDD)	dBm/3.8 4 MHz	-	-65	
	PCCPCH Ec (UTRA LCR TDD)	dBm/1.2 8 MHz	-	-65	
T2	Cell-specific RS EPRE	dBm/15k Hz	-70	-	The power level values are such that entering conditions for event 3a are satisfied.
	CPICH Ec (UTRA FDD)	dBm/3.8 4 MHz	-	-85	
	PCCPCH Ec (UTRA LCR TDD)	dBm/1.2 8 MHz	-	-85	

Table 8.4.2.2.3.2-2: Main behaviour

St	Procedure	Message Sequence		TP	Verdict
		U - S	Message		
0	Wait for 6 s for UE to receive system information.	-	-	-	-
1	The SS changes Cell 1 and Cell 5 level according to the row "T1" in table 8.4.2.2.3.2-1.	-	-	-	-
2	Generic test procedure in TS 36.508 subclause 6.4.2.8 is performed on Cell 5. NOTE: The UE performs an RAU procedure and the RRC connection is released.	-	-	-	-
3-4	Void	-	-	-	-
4A-4E	Step 7 to 11 of test procedure in TS 34.123-1 subclause 12.9.14.4 is performed on Cell 5 using the UTRA reference radio bearer parameters and combination "UTRA PS RB" according to TS 36.508 subclause 4.8.3 and Table 4.8.3-1. NOTE: The UE performs Network initiated RAB re-establishment in a UTRAN cell.	-	-	-	-
-	For UTRAN FDD, EXCEPTION: Steps 5a1 to 5a2 describe behaviour that depends on the UE capability; the "lower case letter" identifies a step sequence that takes place if a capability is supported. For UTRAN TDD, goto step8.	-	-	-	-
5a1	IF <i>pc_UTRA_CompandedModeRequired</i> THEN the SS transmits a PHYSICAL CHANNEL RECONFIGURATION message on Cell 5 including the DPCH compressed mode info.	<--	PHYSICAL CHANNEL RECONFIGURATION	-	-
5a2	The UE transmits a PHYSICAL CHANNEL RECONFIGURATION COMPLETE message on Cell 5.	-->	PHYSICAL CHANNEL RECONFIGURATION COMPLETE	-	-
6-7	Void	-	-	-	-
8	The SS transmits a MEASUREMENT CONTROL message to setup inter-RAT measurement on Cell 5.	<--	MEASUREMENT CONTROL	-	-
9	The SS changes Cell 1 and Cell 5 level according to the row "T2" in table 8.4.2.2.3.2-1.	-	-	-	-
10	The UE transmits a MEASUREMENT REPORT message on Cell 5 including the E-UTRA event results.	-->	MEASUREMENT REPORT	-	-
11	The SS transmits a HANDOVER FROM UTRAN COMMAND message on Cell 5.	<--	HANDOVER FROM UTRAN COMMAND	-	-
12	Check: Does the UE transmit an <i>RRCConnectionReconfigurationComplete</i> message on Cell 1 using the security key derived from the new K_{eNB} ?	-->	<i>RRCConnectionReconfigurationComplete</i>	1	P
12 A	Generic test procedure in TS 36.508 subclause 6.4.2.10 is performed on Cell 1. NOTE: The UE performs tracking area updating procedure without ISR and security reconfiguration after successful completion of handover from UTRA.	-	-	-	-
13-19	Void	-	-	-	-
20	Check: Does the test result of generic test procedure in TS 36.508 subclause 6.4.2.3 indicate that the UE is in E-UTRA RRC CONNECTED state on Cell 1?	-	-	1	-

8.4.2.2.3.3 Specific message contents

Table 8.4.2.2.3.3-1: Void

Table 8.4.2.2.3.3-2: SystemInformationBlockType6 for Cell 1 (preamble, Table 8.4.2.2.3.2-2)

Derivation Path: 36.508, Table 4.4.3.3-5			
Information Element	Value/remark	Comment	Condition
SystemInformationBlockType6 ::= SEQUENCE {			
carrierFreqListUTRA-FDD SEQUENCE (SIZE (1..maxUTRA-FDD-Carrier)) OF SEQUENCE {			UTRA-FDD
carrierFreq[n]	Same downlink UARFCN as used for Cell 5		
cellReselectionPriority[n]	5		
p-MaxUTRA[1]	0		
}			
carrierFreqListUTRA-TDD SEQUENCE (SIZE (1..maxUTRA-TDD-Carrier)) OF SEQUENCE {			UTRA-TDD
carrierFreq[1]	The same number of entries as the configured UTRA TDD carriers		
carrierFreq[1]	Same downlink ARFCN as used for Cell 5		
cellReselectionPriority[n]	5		
p-MaxUTRA[n]	0		
}			
}			

Condition	Explanation
UTRA-FDD	UTRA FDD cell environment
UTRA-TDD	UTRA TDD cell environment

Table 8.4.2.2.3.3-3: Void

Table 8.4.2.2.3.3-4: Void

Table 8.4.2.2.3.3-5: HANDOVER FROM UTRAN COMMAND (step 11, Table 8.4.2.2.3.2-2)

Derivation Path: 36.508, Table 4.7B.1-2

Table 8.4.2.2.3.3-6: RRCConnectionReconfiguration (Table 8.4.2.2.3.3-5)

Derivation Path: 36.508, Table 4.6.1-8, condition HO-TO-EUTRA(1,0)
--

Table 8.4.2.2.3.3-7: MobilityControlInfo (Table 8.4.2.2.3.3-5)

Derivation Path: 36.508, Table 4.6.5-1			
Information Element	Value/remark	Comment	Condition
MobilityControlInfo ::= SEQUENCE {			
targetPhysCellId	PhysicalCellIdentity of Cell 1.		
carrierFreq SEQUENCE {			
dl-CarrierFreq	Same downlink EARFCN as used for Cell 1.		
ul-CarrierFreq	Not present		
}			
carrierBandwidth SEQUENCE {			
dl-Bandwidth	Downlink system bandwidth under test.		
ul-Bandwidth	Uplink Bandwidth under test.		FDD
ul-Bandwidth	Not present		TDD
}			
additionalSpectrumEmission	1		
}			

Condition	Explanation
FDD	FDD cell environment
TDD	TDD cell environment

Table 8.4.2.2.3.3-8: *SecurityConfigHO* (Table 8.4.2.2.3.3-5)

Derivation Path: 36.508, Table 4.6.4-1			
Information Element	Value/remark	Comment	Condition
SecurityConfigHO ::= SEQUENCE {			
handoverType CHOICE {			
interRAT SEQUENCE {			
securityAlgorithmConfig SEQUENCE {			
cipheringAlgorithm	Set according to PIXIT parameter for default ciphering protection algorithm		
integrityProtAlgorithm	Set according to PIXIT parameter for default integrity algorithm		
}			
nas-SecurityParamToEUTRA	Octets 1 to 4 are arbitrarily selected. Bits 1 to 3 of octet 5 are set according to PIXIT parameter for default integrity protection algorithm. Bits 5 to 7 of octet 5 are set according to PIXIT parameter for default ciphering algorithm. Bits 1 to 3 of octet 6 are arbitrarily selected between '000'B and '110'B, different from the valid NAS key set identifier of the UE if such a value exists. Bit 4 of octet 6 is set to 1.	Octets 1 to 4 include the NonceMME value. Bits 1 to 3 of octet 5 include the Type of integrity protection algorithm Bits 5 to 7 of octet 5 include the Type of ciphering algorithm. Bits 1 to 4 of octet 6 include the NAS key set identifier.	
}			
}			
}			
}			

Table 8.4.2.2.3.3-9: MEASUREMENT CONTROL (step 8, Table 8.4.2.2.3.2-2)

Derivation Path: 36.508, clause 4.7B.1-3			
Information Element	Value/remark	Comment	Condition
- Inter-RAT measurement quantity			
- Measurement quantity for UTRAN quality estimate			
- Filter coefficient	0		
- CHOICE mode	FDD		
- Measurement quantity	CPICH RSCP		
- CHOICE system	E-UTRA		
- Measurement quantity	RSRP		
- Filter coefficient	0		
- Inter-RAT reporting quantity			
- UTRAN estimated quality	FALSE		
- CHOICE system	E-UTRA		
- Reporting quantity	both		
- Reporting cell status	Not present		
- CHOICE report criteria	Inter-RAT measurement reporting criteria		
- Parameters required for each event	1 entry		
- Inter-RAT event identity	3a		
- Threshold own system	-66		

- W	0		
- Threshold other system	-80		
- Hysteresis	0		
- Time to trigger	10 ms		
- Reporting cell status			
- CHOICE reported cell	Report cells within active set or within virtual active set or of the other RAT		
- Maximum number of reported cells	2		

Table 8.4.2.3.3-10: System Information Block type 19 for Cell 5 (preamble, Table 8.4.2.3.2-2)

Derivation Path: 36.508 clause 4.4.4.1, Table 4.4.4.1-1			
Information Element	Value/remark	Comment	Condition
SysInfoType19 ::= SEQUENCE {			
utra-PriorityInfoList SEQUENCE {			
utra-ServingCell SEQUENCE {			
Priority	5	higher priority than E-UTRA	
}			
}			
}			

8.4.2.3 Void

8.4.2.4 Inter-RAT handover / From UTRA HSPA to E-UTRA / Data

8.4.2.4.1 Test Purpose (TP)

(1)

```

with { UE in UTRA CELL_DCH(PS-DCCH+DTCH_HS-DSCH) state }
ensure that {
  when { UE receives a HANDOVER FROM UTRAN COMMAND message including the eutra-Message }
  then { UE transmits an RRCConnectionReconfigurationComplete message and enters E-UTRA
RRC_CONNECTED state }
}

```

8.4.2.4.2 Conformance requirements

References: The conformance requirements covered in the present TC are specified in: TS 36.331, clause 5.4.2.3.

[TS 36.331, clause 5.4.2.3]

If the UE is able to comply with the configuration included in the *RRCConnectionReconfiguration* message, the UE shall:

- 1> apply the default physical channel configuration as specified in 9.2.4;
- 1> apply the default semi-persistent scheduling configuration as specified in 9.2.3;
- 1> apply the default MAC main configuration as specified in 9.2.2;
- 1> start timer T304 with the timer value set to *t304*, as included in the *mobilityControlInfo*;
- 1> consider the target cell to be one on the frequency indicated by the *carrierFreq* with a physical cell identity indicated by the *targetPhysCellId*;
- 1> start synchronising to the DL of the target cell;
- 1> set the C-RNTI to the value of the *newUE-Identity*;
- 1> for the target cell, apply the downlink bandwidth indicated by the *dl-Bandwidth*;
- 1> for the target cell, apply the uplink bandwidth indicated by (the absence or presence of) the *ul-Bandwidth*;

- 1> perform the radio resource configuration procedure as specified in 5.3.10;
- 1> forward the *nas-SecurityParamToEUTRA* to the upper layers;
- 1> derive the K_{eNB} key, as specified in TS 33.401 [32];
- 1> store the *nextHopChainingCount* value;
- 1> derive the K_{RRCint} key associated with the *integrityProtAlgorithm*, as specified in TS 33.401 [32];
- 1> derive the K_{RRCenc} key and the K_{UPenc} key associated with the *cipheringAlgorithm*, as specified in TS 33.401 [32];
- 1> configure lower layers to apply the indicated integrity protection algorithm and the K_{RRCint} key immediately, i.e. the indicated integrity protection configuration shall be applied to all subsequent messages received and sent by the UE, including the message used to indicate the successful completion of the procedure;
- 1> configure lower layers to apply the indicated ciphering algorithm, the K_{RRCenc} key and the K_{UPenc} key immediately, i.e. the indicated ciphering configuration shall be applied to all subsequent messages received and sent by the UE, including the message used to indicate the successful completion of the procedure;
- 1> if the *RRCConnectionReconfiguration* message includes the *measConfig*:
 - 2> perform the measurement configuration procedure as specified in 5.5.2;
- 1> submit the *RRCConnectionReconfigurationComplete* message to lower layers for transmission using the new configuration;
- 1> use the default values specified in 9.2.5 for timer T310, T311 and constant N310, N311;
- 1> if MAC successfully completes the random access procedure:
 - 2> stop timer T304;
 - 2> apply the parts of the configuration that do not require the UE to know the SFN of the target cell;
 - 2> apply the parts of the measurement and the radio resource configuration that require the UE to know the SFN of the target cell (e.g. measurement gaps, periodic CQI reporting, scheduling request configuration, sounding RS configuration), if any, upon acquiring the SFN of the target cell;
 - 2> enter E-UTRA RRC_CONNECTED, upon which the procedure ends;

8.4.2.4.3 Test description

8.4.2.4.3.1 Pre-test conditions

System Simulator:

- Cell 1 and Cell 5.
- System information combination 4 as defined in TS 36.508 [18] clause 4.4.3.1 is used in E-UTRA cells.

UE:

None.

Preamble:

- The UE is in state Registered, Idle mode (state 2) on Cell 1 (serving cell) according to [18].

8.4.2.4.3.2 Test procedure sequence

Table 8.4.2.4.3.2-1 illustrates the downlink power levels and other changing parameters to be applied for the cells at various time instants of the test execution. Subsequent configurations marked "T1" and "T2" are applied at the points indicated in the Main behaviour description in Table 8.4.2.4.3.2-2.

Table 8.4.2.4.3.2-1: Time instances of cell power level and parameter changes

	Parameter	Unit	Cell 1	Cell 5	Remark
T1	Cell-specific RS EPRE	dBm/15k Hz	-90	-	The power level values are assigned to satisfy $\text{Thresh}_{x,\text{high}} < \text{SrxleV}_{\text{cell } 5}$.
	CPICH Ec (UTRA FDD)	dBm/3.8 4 MHz	-	-65	
	PCCPCH Ec(UTRA LCR TDD)	dBm/1.2 8 MHz	-	-65	
T2	Cell-specific RS EPRE	dBm/15k Hz	-70	-	The power level values are such that entering conditions for event 3a are satisfied.
	CPICH Ec (UTRA FDD)	dBm/3.8 4 MHz	-	-85	
	PCCPCH Ec (UTRA LCR TDD)	dBm/1.2 8 MHz	-	-85	

Table 8.4.2.4.3.2-2: Main behaviour

St	Procedure	Message Sequence		TP	Verdict
		U - S	Message		
1	The SS changes Cell 1 and Cell 5 level according to the row "T1" in table 8.4.2.4.3.2-1.	-	-	-	-
2	Generic test procedure in TS 36.508 subclause 6.4.2.8 is performed on Cell 5. NOTE: The UE performs an RAU procedure and the RRC connection is released.	-	-	-	-
3-4	Void	-	-	-	-
4A-4E	Step 7 to 11 of test procedure in TS 34.123-1 subclause 12.9.14.4 is performed on Cell 5 using the UTRA reference radio bearer parameters and combination "UTRA HSDPA RB" according to TS 36.508 subclause 4.8.3 and Table 4.8.3-1. NOTE: The UE performs Network initiated RAB re-establishment in a UTRAN cell.	-	-	-	-
-	UTRAN FDD: EXCEPTION: Steps 5a1 to 5a2 describe behaviour that depends on the UE capability; the "lower case letter" identifies a step sequence that takes place if a capability is supported. UTRAN TDD : go to step 8	-	-	-	-
5a1	IF <code>pc_UTRA_CompressedModeRequired</code> THEN the SS transmits a PHYSICAL CHANNEL RECONFIGURATION message on Cell 5 including the DPCH compressed mode info.	<--	PHYSICAL CHANNEL RECONFIGURATION	-	-
5a2	The UE transmits a PHYSICAL CHANNEL RECONFIGURATION COMPLETE message on Cell 5.	-->	PHYSICAL CHANNEL RECONFIGURATION COMPLETE	-	-
6-7	Void	-	-	-	-
8	The SS transmits a MEASUREMENT CONTROL message to setup inter-RAT measurement on Cell 5.	<--	MEASUREMENT CONTROL	-	-
9	The SS changes Cell 1 and Cell 5 level according to the row "T2" in table 8.4.2.4.3.2-1.	-	-	-	-
10	The UE transmits a MEASUREMENT REPORT message on Cell 5 including the E-UTRA event results.	-->	MEASUREMENT REPORT	-	-
11	The SS transmits a HANDOVER FROM UTRAN COMMAND message on Cell 5.	<--	HANDOVER FROM UTRAN COMMAND	-	-
12	Check: Does the UE transmit an <i>RRCCConnectionReconfigurationComplete</i> message on Cell 1 using the security key derived from the new K_{eNB} ?	-->	<i>RRCCConnectionReconfigurationComplete</i>	1	P
12 A	Generic test procedure in TS 36.508 subclause 6.4.2.10 is performed on Cell 1. NOTE: The UE performs tracking area updating procedure without ISR and security reconfiguration after successful completion of handover from UTRA.	-	-	-	-
13-19	Void	-	-	-	-
20	Check: Does the test result of generic test procedure in TS 36.508 subclause 6.4.2.3 indicate that the UE is in E-UTRA RRC CONNECTED state on Cell 1?	-	-	1	-

8.4.2.4.3.3 Specific message contents

Table 8.4.2.4.3.3-1: Void**Table 8.4.2.4.3.3-2: SystemInformationBlockType6 for Cell 1 (preamble, Table 8.4.2.4.3.2-2)**

Derivation Path: 36.508, Table 4.4.3.3-5			
Information Element	Value/remark	Comment	Condition
SystemInformationBlockType6 ::= SEQUENCE {			
carrierFreqListUTRA-FDD SEQUENCE (SIZE (1..maxUTRA-FDD-Carrier)) OF SEQUENCE {			UTRA-FDD
carrierFreq[n]	Same downlink UARFCN as used for Cell 5		
cellReselectionPriority[n]	5		
p-MaxUTRA[n]	0		
}			
carrierFreqListUTRA-TDD SEQUENCE (SIZE (1..maxUTRA-TDD-Carrier)) OF SEQUENCE {			UTRA-TDD
carrierFreq[n]	Same downlink UARFCN as used for Cell 5		
cellReselectionPriority[n]	5		
p-MaxUTRA[n]	0		
}			
}			

Condition	Explanation
UTRA-FDD	UTRA FDD cell environment
UTRA-TDD	UTRA TDD cell environment

Table 8.4.2.4.3.3-3: Void**Table 8.4.2.4.3.3-4: Void****Table 8.4.2.4.3.3-5: HANDOVER FROM UTRAN COMMAND (step 11, Table 8.4.2.4.3.2-2)**

Derivation Path: 36.508, Table 4.7B.1-2

Table 8.4.2.4.3.3-6: RRCConnectionReconfiguration (Table 8.4.2.4.3.3-5)

Derivation Path: 36.508, Table 4.6.1-8, condition HO-TO-EUTRA(1,0)

Table 8.4.2.4.3.3-7: MobilityControlInfo (Table 8.4.2.4.3.3-5)

Derivation Path: 36.508, Table 4.6.5-1			
Information Element	Value/remark	Comment	Condition
MobilityControlInfo ::= SEQUENCE {			
targetPhysCellId	PhysicalCellId of Cell 1.		
carrierFreq SEQUENCE {			
dl-CarrierFreq	Same downlink EARFCN as used for Cell 1.		
ul-CarrierFreq	Not present		
}			
carrierBandwidth SEQUENCE {			
dl-Bandwidth	Downlink system bandwidth under test.		
ul-Bandwidth	Uplink Bandwidth under test.		FDD
ul-Bandwidth	Not present		TDD
}			
additionalSpectrumEmission	1		
}			

Condition	Explanation
FDD	FDD cell environment
TDD	TDD cell environment

Table 8.4.2.4.3.3-8: SecurityConfigHO (Table 8.4.2.4.3.3-5)

Derivation Path: 36.508, Table 4.6.4-1			
Information Element	Value/remark	Comment	Condition
SecurityConfigHO ::= SEQUENCE {			
handoverType CHOICE {			
interRAT SEQUENCE {			
securityAlgorithmConfig SEQUENCE {			
cipheringAlgorithm	Set according to PIXIT parameter for default ciphering protection algorithm		
integrityProtAlgorithm	Set according to PIXIT parameter for default integrity algorithm		
}			
nas-SecurityParamToEUTRA	Octets 1 to 4 set to 11223344. Bits 1 to 3 of octet 5 are set according to PIXIT parameter for default integrity protection algorithm. Bits 5 to 7 of octet 5 are set according to PIXIT parameter for default ciphering algorithm. Bits 1 to 3 of octet 6 are set to the NAS key set identifier of the current security context. Bit 4 of octet 6 is set to 1.	Octets 1 to 4 include the NonceMME value and are arbitrarily selected. Bits 1 to 3 of octet 5 include the Type of integrity protection algorithm Bits 5 to 7 of octet 5 include the Type of ciphering algorithm. Bits 1 to 4 of octet 6 include the NAS key set identifier.	
}			
}			
}			
}			

Table 8.4.2.4.3.3-9: PHYSICAL CHANNEL RECONFIGURATION (step 5a1, Table 8.4.2.4.3.2-2)

Derivation Path: 34.108 clause 9.1.1 (PHYSICAL CHANNEL RECONFIGURATION message)	
Information Element	Value/remark
- CHOICE mode	FDD
- DPCH compressed mode info	
- TGPSI	1
- TGPS Status Flag	deactivate
- TGCFN	Not Present
- Transmission gap pattern sequence configuration parameters	
- TGMP	FDD Measurement
- TGPRC	Infinity
- TGSN	8
- TGL1	10
- TGL2	Not Present
- TGD	270
- TGPL1	12
- TGPL2	Not Present
- RPP	mode 0
- ITP	mode 0

Derivation Path: 34.108 clause 9.1.1 (PHYSICAL CHANNEL RECONFIGURATION message)	
Information Element	Value/remark
- CHOICE UL/DL Mode	UL and DL, UL only, or DL only, depending on UE capability
- Downlink compressed mode method	SF/2 or Not present depending on UE capability
- Uplink compressed mode method	Higher Layer Scheduling or Not Present depending on UE capability
- Downlink frame type	B
- DeltaSIR1	20 (2.0)
- DeltaSIRAfter1	10 (1.0)
- DeltaSIR2	Not Present
- DeltaSIRAfter2	Not Present
- N identify abort	Not Present
- T Reconfirm abort	Not Present

Table 8.4.2.4.3.3-10: System Information Block type 19 for Cell 5 (preamble, Table 8.4.2.4.3.2-2)

Derivation Path: 36.508 clause 4.4.4.1, Table 4.4.4.1-1			
Information Element	Value/remark	Comment	Condition
SysInfoType19 ::= SEQUENCE {			
utra-PriorityInfoList SEQUENCE {			
utra-ServingCell SEQUENCE {			
Priority	5	higher priority than E-UTRA	
}			
}			
}			

8.4.2.5 Void

8.4.2.6 Void

8.4.2.7 CA / RRC connection reconfiguration / Handover UTRAN to E-UTRAN/
Success / SCell addition

8.4.2.7.1 CA / RRC connection reconfiguration / Handover UTRAN to E-UTRAN/ Success /
SCell addition / Intra-band Contiguous CA

8.4.2.7.1.1 Test Purpose (TP)

(1)

```
with { UE in UTRA CELL_DCH(P5-DCCH+DTCH_HS-DSCH) state }
ensure that {
  when { UE receives a HANDOVER FROM UTRAN COMMAND message including the eutra-Message with
RRCCOnnectionReconfiguration including the sCellToAddModList }
  then { UE transmits an RRCCOnnectionReconfigurationComplete message and enters E-UTRA
RRC_CONNECTED state with both PCell and SCell }
}
```

8.4.2.7.1.2 Conformance requirements

References: The conformance requirements covered in the present TC are specified in: Reference TS 36.331 clause 5.4.2.3, and 5.3.10.3b]

[TS 36.331, clause 5.4.2.3]

If the UE is able to comply with the configuration included in the *RRCCOnnectionReconfiguration* message, the UE shall:

- 1> apply the default physical channel configuration as specified in 9.2.4;
- 1> apply the default semi-persistent scheduling configuration as specified in 9.2.3;

- 1> apply the default MAC main configuration as specified in 9.2.2;
- 1> start timer T304 with the timer value set to $t304$, as included in the *mobilityControlInfo*;
- 1> consider the target PCell to be one on the frequency indicated by the *carrierFreq* with a physical cell identity indicated by the *targetPhysCellId*;
- 1> start synchronising to the DL of the target PCell;
- 1> set the C-RNTI to the value of the *newUE-Identity*;
- 1> for the target PCell, apply the downlink bandwidth indicated by the *dl-Bandwidth*;
- 1> for the target PCell, apply the uplink bandwidth indicated by (the absence or presence of) the *ul-Bandwidth*;
- 1> configure lower layers in accordance with the received *radioResourceConfigCommon*;
- 1> configure lower layers in accordance with any additional fields, not covered in the previous, if included in the received *mobilityControlInfo*;
- 1> perform the radio resource configuration procedure as specified in 5.3.10;
- 1> forward the *nas-SecurityParamToEUTRA* to the upper layers;
- 1> derive the K_{eNB} key, as specified in TS 33.401 [32];
- 1> derive the K_{RRCint} key associated with the *integrityProtAlgorithm*, as specified in TS 33.401 [32];
- 1> derive the K_{RRCenc} key and the K_{UPenc} key associated with the *cipheringAlgorithm*, as specified in TS 33.401 [32];
- 1> configure lower layers to apply the indicated integrity protection algorithm and the K_{RRCint} key immediately, i.e. the indicated integrity protection configuration shall be applied to all subsequent messages received and sent by the UE, including the message used to indicate the successful completion of the procedure;
- 1> configure lower layers to apply the indicated ciphering algorithm, the K_{RRCenc} key and the K_{UPenc} key immediately, i.e. the indicated ciphering configuration shall be applied to all subsequent messages received and sent by the UE, including the message used to indicate the successful completion of the procedure;
- 1> if the received *RRCCConnectionReconfiguration* includes the *sCellToAddModList*:
 - 2> perform SCell addition as specified in 5.3.10.3b;
- 1> if the *RRCCConnectionReconfiguration* message includes the *measConfig*:
 - 2> perform the measurement configuration procedure as specified in 5.5.2;
- 1> perform the measurement identity autonomous removal as specified in 5.5.2.2a;
- 1> if the *RRCCConnectionReconfiguration* message includes the *reportProximityConfig*:
 - 2> perform the proximity indication configuration in accordance with the received *reportProximityConfig*;
- 1> set the content of *RRCCConnectionReconfigurationComplete* message as follows:
 - 2> if the UE has radio link failure or handover failure information available in *VarRLF-Report* and *plmn-Identity* stored in *VarRLF-Report* is equal to the RPLMN:
 - 3> include *rlf-InfoAvailable*;
 - 2> if the UE has logged measurements available for E-UTRA and *plmn-Identity* stored in *VarLogMeasReport* is equal to the RPLMN:
 - 3> include the *logMeasAvailable*;
- 1> submit the *RRCCConnectionReconfigurationComplete* message to lower layers for transmission using the new configuration;
- 1> if the *RRCCConnectionReconfiguration* message does not include *rlf-TimersAndConstants* set to *setup*:

2> use the default values specified in 9.2.5 for timer T310, T311 and constant N310, N311;

1> if MAC successfully completes the random access procedure:

2> stop timer T304;

2> apply the parts of the CQI reporting configuration, the scheduling request configuration and the sounding RS configuration that do not require the UE to know the SFN of the target PCell, if any;

2> apply the parts of the measurement and the radio resource configuration that require the UE to know the SFN of the target PCell (e.g. measurement gaps, periodic CQI reporting, scheduling request configuration, sounding RS configuration), if any, upon acquiring the SFN of the target PCell;

NOTE 1: Whenever the UE shall setup or reconfigure a configuration in accordance with a field that is received it applies the new configuration, except for the cases addressed by the above statements.

2> enter E-UTRA RRC_CONNECTED, upon which the procedure ends;

NOTE 2: The UE is not required to determine the SFN of the target PCell by acquiring system information from that cell before performing RACH access in the target PCell.

[TS 36.331, clause 5.3.10b]

The UE shall:

1> for each *sCellIndex* value included in the *sCellToAddModList* that is not part of the current UE configuration (SCell addition):

2> add the SCell, corresponding to the *cellIdentification*, in accordance with the received *radioResourceConfigCommonSCell* and *radioResourceConfigDedicatedSCell*;

2> configure lower layers to consider the SCell to be in deactivated state;

1> for each *sCellIndex* value included in the *sCellToAddModList* that is part of the current UE configuration (SCell modification):

2> modify the SCell configuration in accordance with the received *radioResourceConfigDedicatedSCell*;

8.4.2.7.1.3 Test description

8.4.2.7.1.3.1 Pre-test conditions

System Simulator:

- Cell 5 is UTRAN Cell
- Cell 1 is the PCell, Cell 3 is SCell to be added
- Cell 3 is an Inactive SCell according to [18] cl. 6.3.4
- System information combination 9 as defined in TS 36.508 [18] clause 4.4.3.1 is used in E-UTRA cells.

UE:

- None

Preamble:

- The UE is in state Registered, Idle mode (state 2) on Cell 1 according to [18].

8.4.2.7.1.3.2 Test procedure sequence

Table 8.4.2.7.1.3.2-1 illustrates the downlink power levels and other changing parameters to be applied for the cells at various time instants of the test execution. Subsequent configurations marked "T1" and "T2" are applied at the points indicated in the Main behaviour description in Table 8.4.2.7.1.3.2-2.

Table 8.4.2.7.1.3.2-1: Time instances of cell power level and parameter changes

	Parameter	Unit	Cell 1	Cell 3	Cell 5	Remark
T1	Cell-specific RS EPRE	dBm/15k Hz	-90	-90		The power level values are assigned to satisfy $\text{Thresh}_{x,\text{high}} < \text{Srxlev}_{\text{cell } 5}$.
	CPICH Ec (UTRA FDD)	dBm/3.8 4 MHz	-	-	-65	
	PCCPCH Ec(UTRA LCR TDD)	dBm/1.2 8 MHz	-	-	-65	
T2	Cell-specific RS EPRE	dBm/15k Hz	-70	-70	-	The power level values are such that entering conditions for event 3a are satisfied.
	CPICH Ec (UTRA FDD)	dBm/3.8 4 MHz	-	-	-85	
	PCCPCH Ec (UTRA LCR TDD)	dBm/1.2 8 MHz	-	-	-85	

Table 8.4.2.7.1.3.2-2: Main behaviour

St	Procedure	Message Sequence		TP	Verdict
		U - S	Message		
1	The SS changes Cell 5, Cell 1 and Cell 3 level according to the row "T1" in table 8.4.2.7.1.3.2-1.	-	-	-	-
2	Generic test procedure in TS 36.508 subclause 6.4.2.8 is performed on Cell 5. NOTE: The UE performs an RAU procedure and the RRC connection is released.	-	-	-	-
3-7	Step 7 to 11 of test procedure in TS 34.123-1 subclause 12.9.14.4 is performed on Cell 5 using the UTRA reference radio bearer parameters and combination "UTRA HSDPA RB" according to TS 36.508 subclause 4.8.3 and Table 4.8.3-1. NOTE: The UE performs Network initiated RAB re-establishment in a UTRAN cell.	-	-	-	-
-	EXCEPTION: Steps 8a1 to 8a2 describe behaviour that depends on the UE capability; the "lower case letter" identifies a step sequence that takes place if a capability is supported.	-	-	-	-
8a1	IF <code>pc_FDD AND pc_UTRA_CompressedModeRequired</code> THEN the SS transmits a PHYSICAL CHANNEL RECONFIGURATION message on Cell 5 including the DPCH compressed mode info.	<--	PHYSICAL CHANNEL RECONFIGURATION	-	-
8a2	The UE transmits a PHYSICAL CHANNEL RECONFIGURATION COMPLETE message on Cell 5.	-->	PHYSICAL CHANNEL RECONFIGURATION COMPLETE	-	-
9	The SS transmits a MEASUREMENT CONTROL message to setup inter-RAT measurement on Cell 5.	<--	MEASUREMENT CONTROL	-	-
10	The SS changes Cell 5, Cell 1 and Cell 3 level according to the row "T2" in table 8.4.2.7.1.3.2-1.	-	-	-	-
11	The UE transmits a MEASUREMENT REPORT message on Cell 5 including the E-UTRA event results.	-->	MEASUREMENT REPORT	-	-
12	The SS transmits a HANDOVER FROM UTRAN COMMAND message on Cell 5.	<--	HANDOVER FROM UTRAN COMMAND	-	-
13	Check: Does the UE transmit an <i>RRCCoNNECTIONReconfigurationComplete</i> message on Cell 1 to confirm the successful completion of the handover and SCell addition of Cell 3?	-->	<i>RRCCoNNECTIONReconfigurationComplete</i>	1	P
14	Check: Does the test result of generic test procedure in TS 36.508 subclause 6.4.2.3 indicates that the UE is in E-UTRA RRC_CONNECTED state on Cell 1?	-	-	1	-

8.4.2.7.1.3.3 Specific message contents

Table 8.4.2.7.1.3.3-1: SystemInformationBlockType6 for Cell 1 (preamble, Table 8.4.2.7.1.3.2-2)

Derivation Path: 36.508, Table 4.4.3.3-5			
Information Element	Value/remark	Comment	Condition
SystemInformationBlockType6 ::= SEQUENCE {			
carrierFreqListUTRA-FDD SEQUENCE (SIZE (1..maxUTRA-FDD-Carrier)) OF SEQUENCE {			UTRA-FDD
carrierFreq[n]	Same downlink UARFCN as used for Cell 5		
cellReselectionPriority[n]	5		
p-MaxUTRA[1]	0		
}			
carrierFreqListUTRA-TDD SEQUENCE (SIZE (1..maxUTRA-TDD-Carrier)) OF SEQUENCE {			UTRA-TDD
carrierFreq[1]	The same number of entries as the configured UTRA TDD carriers		
carrierFreq[1]	Same downlink ARFCN as used for Cell 5		
cellReselectionPriority[n]	5		
p-MaxUTRA[n]	0		
}			
}			

Condition	Explanation
UTRA-FDD	UTRA FDD cell environment
UTRA-TDD	UTRA TDD cell environment

Table 8.4.2.7.1.3.3-2: MEASUREMENT CONTROL (step 9, Table 8.4.2.7.1.3.2-2)

Derivation Path: 36.508, clause 4.7B.1-3			
Information Element	Value/remark	Comment	Condition
- Inter-RAT measurement quantity			
- Measurement quantity for UTRAN quality estimate			
- Filter coefficient	0		
- CHOICE mode	FDD		
- Measurement quantity	CPICH RSCP		
- CHOICE system	E-UTRA		
- Measurement quantity	RSRP		
- Filter coefficient	0		
- Inter-RAT reporting quantity			
- UTRAN estimated quality	FALSE		
- CHOICE system	E-UTRA		
- Reporting quantity	both		
- Reporting cell status	Not present		
- CHOICE report criteria	Inter-RAT measurement reporting criteria		
- Parameters required for each event	1 entry		
- Inter-RAT event identity	3a		
- Threshold own system	-66		
- W	0		
- Threshold other system	-80		
- Hysteresis	0		
- Time to trigger	10 ms		
- Reporting cell status			
- CHOICE reported cell	Report cells within active set or within virtual active set or of the other RAT		
- Maximum number of reported cells	2		

Table 8.4.2.7.1.3.3-3: HANDOVER FROM UTRAN COMMAND (step 12, Table 8.4.2.7.1.3.2-2)

Derivation Path: 36.508, Table 4.7B.1-2

Table 8.4.2.7.1.3.3-4: RRCConnectionReconfiguration (Table 8.4.2.7.1.3.3-3)

Derivation Path: 36.508, Table 4.6.1-8, condition HO-TO-EUTRA(1,0) and SCell_AddMod

Table 8.4.2.7.1.3.3-5: MobilityControlInfo (Table 8.4.2.7.1.3.3-4)

Derivation Path: 36.508, Table 4.6.5-1			
Information Element	Value/remark	Comment	Condition
MobilityControlInfo ::= SEQUENCE {			
targetPhysCellId	PhysicalCellIdentity of Cell 1.		
carrierFreq SEQUENCE {			
dl-CarrierFreq	Same downlink EARFCN as used for Cell 1.		
ul-CarrierFreq	Not present		
}			
carrierBandwidth SEQUENCE {			
dl-Bandwidth	Downlink system bandwidth under test.		
ul-Bandwidth	Uplink Bandwidth under test.		FDD
ul-Bandwidth	Not present		TDD
}			
additionalSpectrumEmission	1		
}			

Condition	Explanation
FDD	FDD cell environment
TDD	TDD cell environment

Table 8.4.2.7.1.3.3-6: SecurityConfigHO (Table 8.4.2.7.1.3.3-4)

Derivation Path: 36.508, Table 4.6.4-1			
Information Element	Value/remark	Comment	Condition
SecurityConfigHO ::= SEQUENCE {			
handoverType CHOICE {			
interRAT SEQUENCE {			
securityAlgorithmConfig SEQUENCE {			
cipheringAlgorithm	Set according to PIXIT parameter for default ciphering protection algorithm		
integrityProtAlgorithm	Set according to PIXIT parameter for default integrity algorithm		
}			
nas-SecurityParamToEUTRA	<p>Octets 1 to 4 are arbitrarily selected.</p> <p>Bits 1 to 3 of octet 5 are set according to PIXIT parameter for default integrity protection algorithm.</p> <p>Bits 5 to 7 of octet 5 are set according to PIXIT parameter for default ciphering algorithm.</p> <p>Bits 1 to 3 of octet 6 are arbitrarily selected between '000'B and '110'B, different from the valid NAS key set identifier of the UE if such a value exists.</p> <p>Bit 4 of octet 6 is set to 1.</p>	<p>Octets 1 to 4 include the NonceMME value.</p> <p>Bits 1 to 3 of octet 5 include the Type of integrity protection algorithm</p> <p>Bits 5 to 7 of octet 5 include the Type of ciphering algorithm.</p> <p>Bits 1 to 4 of octet 6 include the NAS key set identifier.</p>	
}			
}			
}			
}			

Table 8.4.2.7.1.3.3-7: SCellToAddMod-r10-f2 (Table 8.4.2.7.1.3.3-4)

Derivation Path: 36.508 clause 4.6.1 table 4.6.3-19D SCellToAddMod-r10-DEFAULT			
Information Element	Value/remark	Comment	Condition
SCellToAddMod-r10 ::= SEQUENCE (SIZE (1..maxSCell-r10)) OF SEQUENCE {	1 entry		
sCellIndex-r10	1		
cellIdentification-r10 SEQUENCE {			
physCellId-r10	Physical Cell Identity of Cell 3		
dl-CarrierFreq-r10	Same downlink EARFCN as used for Cell 3		
}			
radioResourceConfigCommonSCell-r10	RadioResourceConfigCommonSCell-r10-f2		
}			

Table 8.4.2.7.1.3.3-8: RadioResourceConfigCommonSCell-r10-f2 (Table 8.4.2.7.1.3.3-7)

Derivation Path: 36.508 clause 4.6.3 table 4.6.3-13A			
Information Element	Value/remark	Comment	Condition
RadioResourceConfigCommonSCell-r10 ::= SEQUENCE {			
nonUL-Configuration-r10 SEQUENCE {			
dl-Bandwidth-r10	Same downlink system bandwidth as used for Cell 3		
}			
}			

8.4.2.7.2 CA / RRC connection reconfiguration / Handover UTRAN to E-UTRAN/ Success / SCell addition / Inter-band CA

The scope and description of the present TC is the same as test case 8.4.2.7.1 with the following differences:

- CA configuration: Inter-band CA replaces Intra-band Contiguous CA
- Cells configuration: Cell 10 replaces Cell 3
 - Cell 10 is an Inactive SCell according to [18] cl. 6.3.4

8.4.3 Inter-RAT mobility E-UTRA to GERAN

8.4.3.1 Inter-RAT handover / From E-UTRA to GPRS / PS HO

8.4.3.1.1 Test Purpose (TP)

(1)

```
with { UE in E-UTRA (data) RRC_CONNECTED state }
ensure that {
  when { UE receives a MobilityFromEUTRACommand message including radio resources that have been
    allocated for the UE in the target cell }
  then { UE successfully completes the handover and leaves the RRC_CONNECTED, enter the
    GPRS_Packet_Transfer_Mode }
}
```

8.4.3.1.2 Conformance requirements [D]

References: The conformance requirements covered in the present TC are specified in: TS 36.331, clauses 5.4.3.3, 5.4.3.4.

[TS 36.331, clause 5.4.3.3]

The UE shall be able to receive a *MobilityFromEUTRACommand* message and perform a cell change order to GERAN, even if no prior UE measurements have been performed on the target cell.

The UE shall:

- 1> stop timer T310, if running;
- 1> if the *MobilityFromEUTRACommand* message includes the *purpose* set to 'handover':
 - 2> if the *targetRAT-Type* is set to 'utra' or 'geran':
 - 3> consider inter-RAT mobility as initiated towards the RAT indicated by the *targetRAT-Type* included in the *MobilityFromEUTRACommand* message;
 - 3> forward the *nas-SecurityParamFromEUTRA* to the upper layers;
 - 3> access the target cell indicated in the inter-RAT message in accordance with the specifications of the target RAT;
 - 3> if the *targetRAT-Type* is set to 'geran':

- 4> use the contents of *systemInformation*, if provided for PS Handover, as the system information to begin access on the target GERAN cell;

NOTE 1: If there are DRBs for which no radio bearers are established in the target RAT as indicated in the *targetRAT-MessageContainer* in the message, the E-UTRA RRC part of the UE does not indicate the release of the concerned DRBs to the upper layers. Upper layers may derive which bearers are not established from information received from the AS of the target RAT.

[TS 36.331, clause 5.4.3.4]

Upon successfully completing the handover or the cell change order, the UE shall:

- 1> perform the actions upon leaving RRC_CONNECTED as specified in 5.3.12, with release cause 'other';
- 1> stop timer T304, if running;

8.4.3.1.3 Test description

8.4.3.1.3.1 Pre-test conditions

System Simulator:

- Cell 1 and Cell 24 - Cell 1 is an E-UTRAN cell, Cell 24 is a GERAN cell.
- All cells belong to the same PLMN.
- System information combination 5 as defined in TS 36.508 [18] clause 4.4.3.1 is used in E-UTRA cells.

UE:

- None.

Preamble:

- UE is in state3 (Generic RB Established) in cell 1 as specified in clause 4.5.3 of TS 36.508.

8.4.3.1.3.2 Test procedure sequence

Table 8.4.3.1.3.2-1 illustrates the downlink power levels and other changing parameters to be applied for the cells at various time instants of the test execution. Row marked "T0" denotes the initial condition after preamble, while columns marked "T1" is to be applied subsequently. The exact instants on which these values shall be applied are described in the texts in this clause.

Table 8.4.3.1.3.2-1: Time instances of cell power level and parameter changes

	Parameter	Unit	Cell 1	Cell 24	Remark
T0	Cell-specific RS EPRE	dBm/15k Hz	-60	-	-
	RSSI	dBm	-	[-85]	-
T1	Cell-specific RS EPRE	dBm/15k Hz	-80	-	-
	RSSI	dBm	-	[-65]	-

Table 8.4.3.1.3.2-2: Main behaviour

St	Procedure	Message Sequence		TP	Verdict
		U - S	Message		
1	The SS configures cell 1 and GERAN cell 24 according to the row "T1" in Table 8.4.3.1.3.2-1	-	-	-	-
2	The SS transmits a <i>MobilityFromEUTRACCommand</i> message on Cell 1.	<--	<i>MobilityFromEUTRACCommand</i>	-	-
3	Check: Does the UE transmit a PS HANDOVER ACCESS message on cell 24?	-->	PS HANDOVER ACCESS	1	P

8.4.3.1.3.3 Specific message contents

Table 8.4.3.1.3.3-1: *MobilityFromEUTRACommand* (step 2, Table 8.4.1.2.3.2-1)

Derivation Path: 36.508 table 4.6.1-6			
Information Element	Value/remark	Comment	Condition
MobilityFromEUTRACommand ::= SEQUENCE {			
criticalExtensions CHOICE {			
c1 CHOICE{			
mobilityFromEUTRACommand-r8 SEQUENCE {			
CS-FallbackIndicator	false	Applies only for Rel.9	
purpose CHOICE {			
handover SEQUENCE {			
targetRAT-Type	geran		
targetRAT-MessageContainer	PS HANDOVER COMMAND		
nas-SecurityParamFromEUTRA			UTRAGER AN
systemInformation	PSI-GERAN		PS HO
}			
}			
}			
}			
}			
}			

Table 8.4.3.1.3.3-2: PS HANDOVER COMMAND (Table 8.4.3.1.3.3-1)

Derivation Path: TS 36.508, Table 4.7D.1-1: PS HANDOVER COMMAND			
Information Element	Value/remark	Comment	Condition
NAS Container for PS Handover	Present		

Table 8.4.3.1.3.3-3: NAS Container for PS Handover (Table 8.4.3.1.3.3-2)

Information Element	Value/remark	Comment	Condition
NAS_CONTAINER_LENGTH	Present	Set accordingly	
Type of ciphering algorithm	Present		
old XID	Present	Reset with the old XID parameters	
IOV-UI value	'00000000'O		

8.4.3.2 Inter-RAT cell change order / From E-UTRA data RRC_CONNECTED to GPRS / Without NACC

8.4.3.2.1 Test Purpose (TP)

(1)

```

with { UE in E-UTRA (data) RRC_CONNECTED state }
ensure that {
  when { UE receives a MobilityFromEUTRACommand message including information facilitating access of
the target cell }
  then { UE successfully completing the cell change order and leaves the RRC_CONNECTED, enter the
GPRS_Packet_Idle}
}

```

8.4.3.2.2 Conformance requirements[D]

References: The conformance requirements covered in the present TC are specified in: TS 36.331, clauses 5.4.3.3, 5.4.3.4.

[TS 36.331, clause 5.4.3.3]

The UE shall be able to receive a *MobilityFromEUTRACommand* message and perform a cell change order to GERAN, even if no prior UE measurements have been performed on the target cell.

The UE shall:

- 1> stop timer T310, if running;
- 1> if the *MobilityFromEUTRACommand* message includes the *purpose* set to 'handover':
 - 2> if the *targetRAT-Type* is set to 'utra' or 'geran':
 - 3> consider inter-RAT mobility as initiated towards the RAT indicated by the *targetRAT-Type* included in the *MobilityFromEUTRACommand* message;
 - 3> forward the *nas-SecurityParamFromEUTRA* to the upper layers;
 - 3> access the target cell indicated in the inter-RAT message in accordance with the specifications of the target RAT;
 - 3> if the *targetRAT-Type* is set to 'geran':
 - 4> use the contents of *systemInformation*, if provided for PS Handover, as the system information to begin access on the target GERAN cell;

NOTE 1: If there are DRBs for which no radio bearers are established in the target RAT as indicated in the *targetRAT-MessageContainer* in the message, the E-UTRA RRC part of the UE does not indicate the release of the concerned DRBs to the upper layers. Upper layers may derive which bearers are not established from information received from the AS of the target RAT.

- 2> else if the *targetRAT-Type* is set to 'cdma2000-1XRTT' or 'cdma2000-HRPD':
 - 3> forward the *targetRAT-Type* and the *targetRAT-MessageContainer* to the CDMA2000 upper layers for the UE to access the cell indicated in the inter-RAT message in accordance with the specifications of the CDMA2000 target-RAT;
- 1> else if the *MobilityFromEUTRACommand* message includes the *purpose* set to 'cellChangeOrder':
 - 2> start timer T304 with the timer value set to *t304*, as included in the *MobilityFromEUTRACommand* message;
 - 2> if the *targetRAT-Type* is set to 'geran':
 - 3> if *networkControlOrder* is included in the *MobilityFromEUTRACommand* message:
 - 4> apply the value as specified in TS 44.060 [36];
 - 3> else:
 - 4> acquire *networkControlOrder* and apply the value as specified in TS 44.060 [36];
 - 3> use the contents of *systemInformation*, if provided, as the system information to begin access on the target GERAN cell;

NOTE 2: The *systemInformation* is constructed in the same way as in 2G to 2G NACC, i.e. the PSI messages are encoded as such, whereas the SI messages exclude 2 octets of headers, see TS 44.060[36].

- 2> establish the connection to the target cell indicated in the *CellChangeOrder*;

NOTE 3: The criteria for success or failure of the cell change order to GERAN are specified in TS 44.060[36].

[TS 36.331, clause 5.4.3.4]

Upon successfully completing the handover or the cell change order, the UE shall:

- 1> perform the actions upon leaving RRC_CONNECTED as specified in 5.3.12, with release cause 'other';
- 1> stop timer T304, if running;

8.4.3.2.3 Test description

8.4.3.2.3.1 Pre-test conditions

System Simulator:

- Cell 1 and Cell 24 - Cell 1 is an E-UTRAN cell, Cell 24 is a GERAN cell.
- All cells belong to the same PLMN.
- System information combination 5 as defined in TS 36.508 [18] clause 4.4.3.1 is used in E-UTRA cells.

UE:

- None.

Preamble:

- UE is in state3 (Generic RB Established) in cell 1 as specified in clause 4.5.3 of TS 36.508.

8.4.3.2.3.2 Test procedure sequence

Table 8.4.3.2.3.2-1 illustrates the downlink power levels and other changing parameters to be applied for the cells at various time instants of the test execution. Row marked "T0" denotes the initial condition after preamble, while columns marked "T1" is to be applied subsequently. The exact instants on which these values shall be applied are described in the texts in this clause.

Table 8.4.3.2.3.2-1: Time instances of cell power level and parameter changes

	Parameter	Unit	Cell 1	Cell 24	Remark
T0	Cell-specific RS EPRE	dBm/15k Hz	-60	-	-
	RSSI	dBm	-	-85	
T1	Cell-specific RS EPRE	dBm/15k Hz	-80	-	-
	RSSI	dBm	-	-65	
T2	Cell-specific RS EPRE	dBm/15k Hz	-115	-	The power levels are such that reselection back to cell 1 should not occur

Table 8.4.3.2.3.2-2: Main behaviour

St	Procedure	Message Sequence		TP	Verdict
		U - S	Message		
1	The SS transmits an <i>RRCConnectionReconfiguration</i> message to setup inter RAT measurement on Cell 1.	<--	<i>RRCConnectionReconfiguration</i>	-	-
2	The UE transmits an <i>RRCConnectionReconfigurationComplete</i> message to confirm the setup of inter RAT measurement on Cell 1.	-->	<i>RRCConnectionReconfigurationComplete</i>	-	-
3	The SS changes Cell 1 and Cell 24 parameters according to the row "T1" in table 8.4.3.2.3.2-1.	-	-	-	-
4	The UE transmit a <i>MeasurementReport</i> message to report the event B2 for Cell 24.	-->	<i>MeasurementReport</i>	-	-
5	The SS transmits a <i>MobilityFromEUTRACommand</i> message on Cell 1.	<--	<i>MobilityFromEUTRACommand</i>	-	-
5A	The UE transmits a CHANNEL REQUEST message on Cell24.	-->	CHANNEL REQUEST	-	-
5B	The SS changes cell 1 power level according to the row "T2"	-	-	-	-
6-15	Check: Does the test result of steps 2-11 in generic test procedure in TS 36.508 subclause 6.4.2.9 indicate that the UE is camped on GERAN Cell 24? NOTE: The UE performs an RAU procedure and the RRC connection is released.	-	-	1	P

8.4.3.2.3.3 Specific message contents

Table 8.4.3.2.3.3-1: *RRCConnectionReconfiguration* (step 1, Table 8.4.3.2.3.2-2)

Derivation Path: 36.508, Table 4.6.1-8, condition MEAS
--

Table 8.4.3.2.3.3-2: *MeasConfig* (step 1, Table 8.4.3.2.3.2-2)

Derivation Path: 36.508, Table 4.6.6-1, condition GERAN			
Information Element	Value/remark	Comment	Condition
MeasConfig ::= SEQUENCE {			
measObjectToAddModList SEQUENCE (SIZE (1..maxObjectId)) OF SEQUENCE {	2 entries		
measObjectId[1]	IdMeasObject-f1		
measObject[1]	MeasObjectEUTRA- GENERIC(f1)		
measObjectId[2]	IdMeasObject-f11		
measObject[2]	MeasObjectGERAN- GENERIC(f11)		
}			
reportConfigToAddModList SEQUENCE (SIZE (1..maxReportConfigId)) OF SEQUENCE {	1 entry		
reportConfigId[1]	IdReportConfig-B2- GERAN		
reportConfig[1]	ReportConfigInterRAT- B2-GERAN(-69, -79)		
}			
measIdToAddModList SEQUENCE (SIZE (1..maxMeasId)) OF SEQUENCE {	1 entry		
measId[1]	1		
measObjectId[1]	IdMeasObject-f11		
reportConfigId[1]	IdReportConfig-B2- GERAN		
}			
quantityConfig SEQUENCE {			
quantityConfigGERAN SEQUENCE {			
measQuantityGERAN	rssi		
filterCoefficient	fc0		
}			
}			
}			

Table 8.4.3.2.3.3-3: *MobilityFromEUTRACommand* (step 5, Table 8.4.3.2.3.2-2)

Derivation Path: 36.508 table 4.6.1-6			
Information Element	Value/remark	Comment	Condition
MobilityFromEUTRACommand ::= SEQUENCE {			
rrc-TransactionIdentifier	RRC-TransactionIdentifier-DL		
criticalExtensions CHOICE {			
c1 CHOICE {			
mobilityFromEUTRACommand-r8 ::= SEQUENCE {			
csFallbackIndicator	False		
purpose CHOICE {			
cellChangeOrder ::= SEQUENCE {			
t304	ms8000		
targetRAT-Type CHOICE {			
geran ::= SEQUENCE {			
physCellId	0001H		
carrierFreq ::= SEQUENCE {			
arfcn	Downlink ARFCN of Cell 24		
bandIndicator	The same band indicator of the Cell 24		
}			
}			
}			
}			
}			
}			
}			
}			

8.4.3.3 Inter-RAT cell change order / From E-UTRA data to GPRS / With NACC

8.4.3.3.1 Test Purpose (TP)

(1)

```

with { UE in E-UTRA (data) RRC_CONNECTED state }
ensure that {
  when { UE receives a MobilityFromEUTRACommand message including information facilitating access of
the target cell }
  then { UE successfully completing the cell change order and leaves the RRC_CONNECTED, enter the
GPRS_Packet_Idle }
}

```

8.4.3.3.2 Conformance requirements[D]

References: The conformance requirements covered in the present TC are specified in: TS 36.331, clauses 5.4.3.3, 5.4.3.4.

[TS 36.331, clause 5.4.3.3]

The UE shall be able to receive a *MobilityFromEUTRACommand* message and perform a cell change order to GERAN, even if no prior UE measurements have been performed on the target cell.

The UE shall:

- 1> stop timer T310, if running;
- 1> if the *MobilityFromEUTRACommand* message includes the *purpose* set to 'handover':
 - 2> if the *targetRAT-Type* is set to 'utra' or 'geran':

- 3> consider inter-RAT mobility as initiated towards the RAT indicated by the *targetRAT-Type* included in the *MobilityFromEUTRACommand* message;
- 3> forward the *nas-SecurityParamFromEUTRA* to the upper layers;
- 3> access the target cell indicated in the inter-RAT message in accordance with the specifications of the target RAT;
- 3> if the *targetRAT-Type* is set to 'geran':
 - 4> use the contents of *systemInformation*, if provided for PS Handover, as the system information to begin access on the target GERAN cell;

NOTE 1: If there are DRBs for which no radio bearers are established in the target RAT as indicated in the *targetRAT-MessageContainer* in the message, the E-UTRA RRC part of the UE does not indicate the release of the concerned DRBs to the upper layers. Upper layers may derive which bearers are not established from information received from the AS of the target RAT.

- 2> else if the *targetRAT-Type* is set to 'cdma2000-1XRTT' or 'cdma2000-HRPD':
 - 3> forward the *targetRAT-Type* and the *targetRAT-MessageContainer* to the CDMA2000 upper layers for the UE to access the cell indicated in the inter-RAT message in accordance with the specifications of the CDMA2000 target-RAT;
- 1> else if the *MobilityFromEUTRACommand* message includes the *purpose* set to 'cellChangeOrder':
 - 2> start timer T304 with the timer value set to *t304*, as included in the *MobilityFromEUTRACommand* message;
 - 2> if the *targetRAT-Type* is set to 'geran':
 - 3> if *networkControlOrder* is included in the *MobilityFromEUTRACommand* message:
 - 4> apply the value as specified in TS 44.060 [36];
 - 3> else:
 - 4> acquire *networkControlOrder* and apply the value as specified in TS 44.060 [36];
 - 3> use the contents of *systemInformation*, if provided, as the system information to begin access on the target GERAN cell;

NOTE 2: The *systemInformation* is constructed in the same way as in 2G to 2G NACC, i.e. the PSI messages are encoded as such, whereas the SI messages exclude 2 octets of headers, see TS 44.060[36].

- 2> establish the connection to the target cell indicated in the *CellChangeOrder*;

NOTE 3: The criteria for success or failure of the cell change order to GERAN are specified in TS 44.060[36].

[TS 36.331, clause 5.4.3.4]

Upon successfully completing the handover or the cell change order, the UE shall:

- 1> perform the actions upon leaving RRC_CONNECTED as specified in 5.3.12, with release cause 'other';
- 1> stop timer T304, if running;

8.4.3.3.3 Test description

8.4.3.3.3.1 Pre-test conditions

System Simulator:

- Cell 1 and Cell 24 - Cell 1 is an E-UTRAN cell, Cell 24 is a GERAN cell.
- All cells belong to the same PLMN.
- System information combination 5 as defined in TS 36.508 [18] clause 4.4.3.1 is used in E-UTRA cells.

UE:

- None.

Preamble:

- UE is in state3 (Generic RB Established)in cell 1 as specified in clause 4.5.3 of TS 36.508.

8.4.3.3.3.2 Test procedure sequence

Table 8.4.3.3.3.2-1 illustrates the downlink power levels and other changing parameters to be applied for the cells at various time instants of the test execution. Row marked "T0" denotes the initial conditions after preamble, while columns marked "T1" is to be applied subsequently. The exact instants on which these values shall be applied are described in the texts in this clause.

Table 8.4.3.3.3.2-1: Time instances of cell power level and parameter changes

	Parameter	Unit	Cell 1	Cell 24	Remark
T0	Cell-specific RS EPRE	dBm/15k Hz	-60	-	-
	RSSI	dBm	-	[-85]	
T1	Cell-specific RS EPRE	dBm/15k Hz	-80	-	-
	RSSI	dBm	-	[-65]	
<u>T2</u>	<u>Cell-specific RS EPRE</u>	<u>dBm/15k Hz</u>	<u>-115</u>	<u>-</u>	The power levels are such that reselection back to cell 1 should not occur

Table 8.4.3.3.3.2-2: Main behaviour

St	Procedure	Message Sequence		TP	Verdict
		U - S	Message		
1	The SS transmits an <i>RRCCONNECTIONRECONFIGURATION</i> message to setup inter RAT measurement on Cell 1.	<--	<i>RRCCONNECTIONRECONFIGURATION</i>	-	-
2	The UE transmits an <i>RRCCONNECTIONRECONFIGURATIONCOMPLETE</i> message to confirm the setup of inter RAT measurement on Cell 1.	-->	<i>RRCCONNECTIONRECONFIGURATIONCOMPLETE</i>	-	-
3	The SS changes Cell 1 and Cell 24 parameters according to the row "T1" in table 8.4.3.3.3.2-1.			-	-
4	The UE transmit a <i>MEASUREMENTREPORT</i> message to report the event B2 for Cell 24.	-->	<i>MEASUREMENTREPORT</i>	-	-
5	The SS transmits a <i>MOBILITYFROMEUTRACOMMAND</i> message on Cell 1.	<--	<i>MOBILITYFROMEUTRACOMMAND</i>	-	-
5A	Check: Does the UE send a CHANNEL REQUEST message on the cell(s) specified in the test case?	-->	CHANNEL REQUEST	1	P
5AA	The SS changes cell 1 power level according to the row "T2"	-	-	-	-
5B	An uplink TBF is established in order to allow the UE to transmit a ROUTING AREA UPDATE REQUEST message signalling.	-	-	-	-
5C	The UE transmits a ROUTING AREA UPDATE REQUEST message.	-->	ROUTING AREA UPDATING REQUEST	-	-
5D	the UE transmits a PACKET SI STATUS message	-->	PACKET SI STATUS		
6 -13	The reminder (steps 4 – 11) of generic test procedure in TS 36.508 subclause 6.4.2.9 is performed. NOTE: The UE performs an RAU procedure and the RRC connection is released.	-	-		

8.4.3.3.3.3 Specific message contents

Table 8.4.3.3.3-1: RRCConnectionReconfiguration (step 1, Table 8.4.3.3.2-2)

Derivation Path: 36.508, Table 4.6.1-8, condition MEAS

Table 8.4.3.3.3-2: MeasConfig (step 1, Table 8.4.3.3.2-2)

Derivation Path: 36.508, Table 4.6.6-1, condition GERAN			
Information Element	Value/remark	Comment	Condition
MeasConfig ::= SEQUENCE {			
measObjectToAddModList SEQUENCE (SIZE (1..maxObjectId)) OF SEQUENCE {	2 entries		
measObjectId[1]	IdMeasObject-f1		
measObject[1]	MeasObjectEUTRA- GENERIC(f1)		
measObjectId[2]	IdMeasObject-f11		
measObject[2]	MeasObjectGERAN- GENERIC(f11)		
}			
reportConfigToAddModList SEQUENCE (SIZE (1..maxReportConfigId)) OF SEQUENCE {	1 entry		
reportConfigId[1]	IdReportConfig-B2- GERAN		
reportConfig[1]	ReportConfigInterRAT- B2-GERAN(-69, [-79])		
}			
measIdToAddModList SEQUENCE (SIZE (1..maxMeasId)) OF SEQUENCE {	1 entry		
measId[1]	1		
measObjectId[1]	IdMeasObject-f11		
reportConfigId[1]	IdReportConfig-B2- GERAN		
}			
quantityConfig SEQUENCE {			
quantityConfigGERAN SEQUENCE {			
measQuantityGERAN	rssi		
filterCoefficient	fc0		
}			
}			
}			

Table 8.4.3.3.3-3: MobilityFromEUTRACommand (step 5, Table 8.4.3.3.2-2)

Derivation Path: 36.508 table 4.6.1-6			
Information Element	Value/remark	Comment	Condition
MobilityFromEUTRACommand ::= SEQUENCE {			
rrc-TransactionIdentifier	RRC-TransactionIdentifier-DL		
criticalExtensions CHOICE {			
c1 CHOICE {			
mobilityFromEUTRACommand-r8 ::= SEQUENCE {			
csFallbackIndicator	False		
purpose CHOICE {			
cellChangeOrder ::= SEQUENCE {			
t304	ms2000		
targetRAT-Type CHOICE {			
geran ::= SEQUENCE {			
physCellId	0001H		
carrierFreq ::= SEQUENCE {			
arfcn	Downlink ARFCN of Cell 24		
bandIndicator	The same band indicator of the Cell 24		
}			
networkControlOrder	00	NC0: MS controlled cell re-selection, no measurement reporting	
}			PS HO
SI-OrPSI-GERAN ::= CHOICE {			
SystemInfoListGERAN ::= SEQUENCE {			
SYSTEM INFORMATION TYPE 1	Set according to clause 4.4.5 in TS36.508.		
SYSTEM INFORMATION TYPE 3	Set according to clause 4.4.5 in TS36.508.		
SYSTEM INFORMATION TYPE 13	Set according to clause 4.4.5 in TS36.508.		
}			
}			
}			
}			
}			
}			

Table 8.4.3.3.3-4: System Information 13 (Preamble onwards)

Derivation Path: 51.010, Clause 40.2.1.1.1	
SI 13 Rest Octets - SI_STATUS_IND bit	1 PACKET SI STATUS message supported

Table 8.4.3.3.3-5: Packet SI Status

Information element	Value/remark
< GLOBAL_TFI : Global TFI IE >	Present, any Value
< BCCH_CHANGE_MARK : bit (3) >	Present, any Value
< Received SI Message List : { 1 < SI_MESSAGE_TYPE : bit (8) > { < MESS_REC : bit (2) } } < SI_MESSAGE_TYPE : bit (8) > { < MESS_REC : bit (2) } } ** 0 < ADDITIONAL_MSG_TYPE : bit > ;	1 00011001 (SI1) 01 (Message type supported and received, single instance) 1 00011011 (SI3) 1 Not Checked, The UE may include additional information Present, any Value
< Received Unknown SI Message List : { 1 < SI_MESSAGE_TYPE : bit (8) > } ** 0 < ADDITIONAL_MSG_TYPE : bit > ;	0 (not present) Present, any Value
1 -- Additions for REL-6 : < PSCSI_SUPPORT : bit > < PS_REL_REQ : bit >	Not Checked Not Checked Not Checked

8.4.4 Void

8.4.5 Inter-RAT handover E-UTRA to HRPD

8.4.5.1 Void

8.4.5.2 Void

8.4.5.3 Void

8.4.5.4 Pre-registration at HRPD and inter-RAT handover / From E-UTRA to HRPD Active / Data

8.4.5.4.1 Test Purpose (TP)

(1)

```
with { UE in E-UTRA RRC_CONNECTED state and UE has performed pre-registration on HRPD neighbour cell }
ensure that {
  when { UE receives a HandoverFromEUTRAPreparationRequest message with cdma2000-type set to 'HRPD' }
  then { UE transmits a ULHandoverPreparationTransfer message containing tunnelled HRPD ConnectionRequest and RouteUpdate messages }
}
```

(2)

```
with { UE in E-UTRA RRC_CONNECTED state and UE has performed pre-registration on HRPD neighbour cell }
ensure that {
  when { UE receives a MobilityFromEUTRACommand message containing tunnelled HRPD TrafficChannelAssignment, HRPDSilenceParameters and HRPDOpenLoopParameters messages }
  then { UE transmits a TrafficChannelComplete message on the target HRPD cell }
}
```

8.4.5.4.2 Conformance requirements

References: The conformance requirements covered in the present TC are specified in: TS 36.331, clauses 5.4.3.3, 5.4.4.3, 5.4.5.1 and 5.4.5.3, TS 23.402, clause 9.3.2 and 3GPP2 X.S0057- B v1.0, clause 13.1.2.

[TS 36.331, clause 5.4.3.3]

The UE shall be able to receive a *MobilityFromEUTRACommand* message and perform a cell change order to GERAN, even if no prior UE measurements have been performed on the target cell.

The UE shall:

- 1> stop timer T310, if running;
- 1> if the *MobilityFromEUTRACommand* message includes the *purpose* set to 'handover':
 - 2> if the *targetRAT-Type* is set to 'utra' or 'geran':
 - ...
 - 2> else if the *targetRAT-Type* is set to 'cdma2000-1XRTT' or 'cdma2000-HRPD':
 - 3> forward the *targetRAT-Type* and the *targetRAT-MessageContainer* to the CDMA2000 upper layers for the UE to access the cell indicated in the inter-RAT message in accordance with the specifications of the CDMA2000 target-RAT;

[TS 36.331, clause 5.4.4.3]

Upon reception of the *HandoverFromEUTRAPreparationRequest* message, the UE shall:

- 1> indicate the request to prepare handover and forward the *cdma2000-Type* to the CDMA2000 upper layers;
- 1> if *cdma2000-Type* is set to 'type1XRTT':
 - 2> forward the *rand* and the *mobilityParametersCDMA2000* to the CDMA2000 upper layers;

[TS 36.331, clause 5.4.5.1]



Figure 5.4.5.1-1: UL handover preparation transfer

The purpose of this procedure is to tunnel the handover related CDMA2000 dedicated information from UE to E-UTRAN when requested by the higher layers. The procedure is triggered by the higher layers on receipt of *HandoverFromEUTRAPreparationRequest* message. This procedure applies to CDMA2000 capable UEs only.

[TS 36.331, clause 5.4.5.3]

The UE shall set the contents of the *ULHandoverPreparationTransfer* message as follows:

- 1> include the *cdma2000-Type* and the *dedicatedInfoCDMA2000*;
- 1> if the *cdma2000-Type* is set to 'type1XRTT':
 - 2> include the *meid* and set it to the value received from the CDMA2000 upper layers;
- 1> submit the *ULHandoverPreparationTransfer* message to lower layers for transmission, upon which the procedure ends;

[TS 23.402, clause 9.3.2]

Figure 9.3.2-1 illustrates a high-level call flow for the optimised E-UTRAN to HRPD handover procedure, Handover phase. The prerequisite of the handover phase is the successfully performed Pre-registration phase as it is specified in clause 9.3.1.

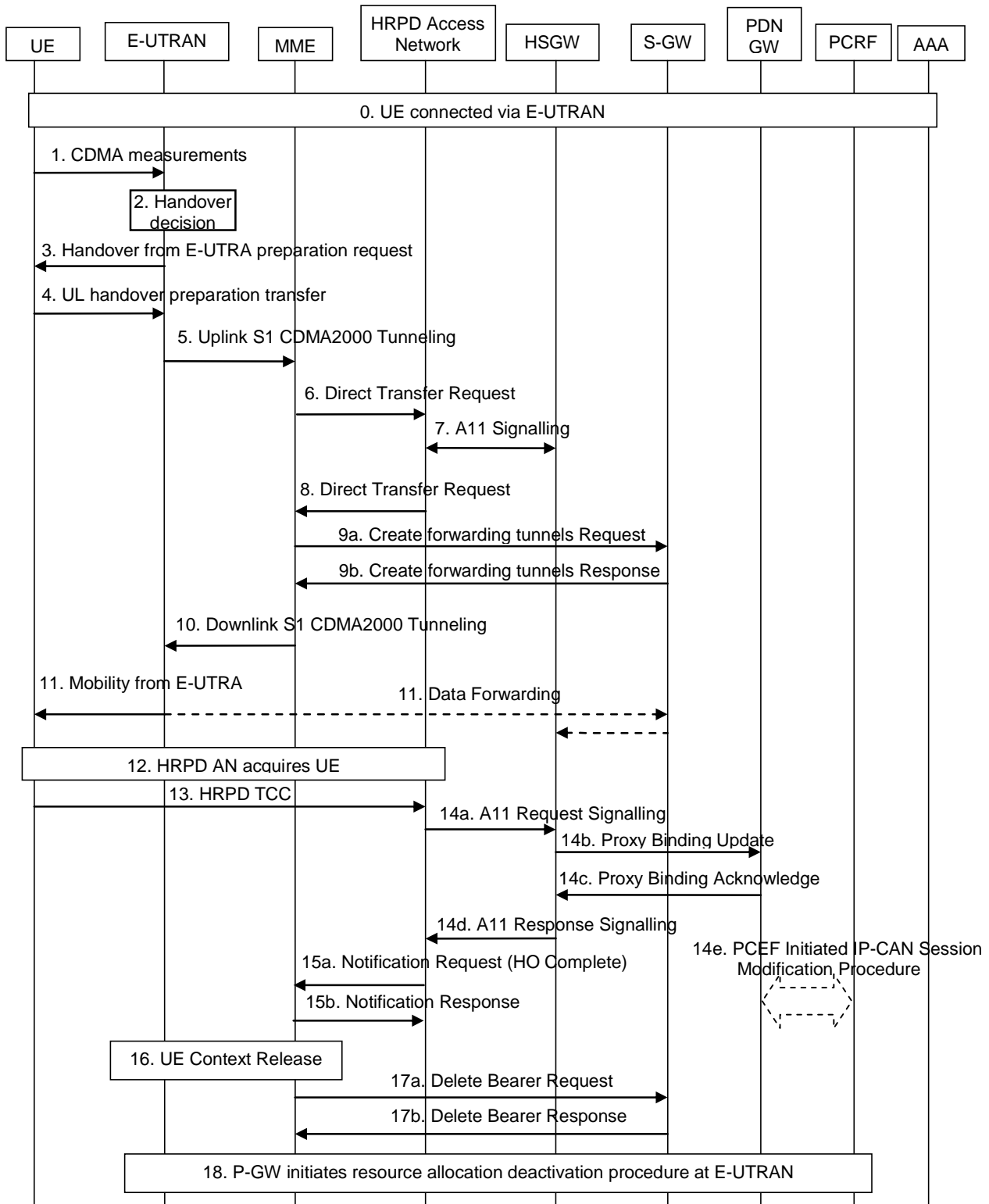

Figure 9.3.2-1: E-UTRAN to HRPD handover

[3GPP2 X.S0057- B v1.0, clause 13.1.2]

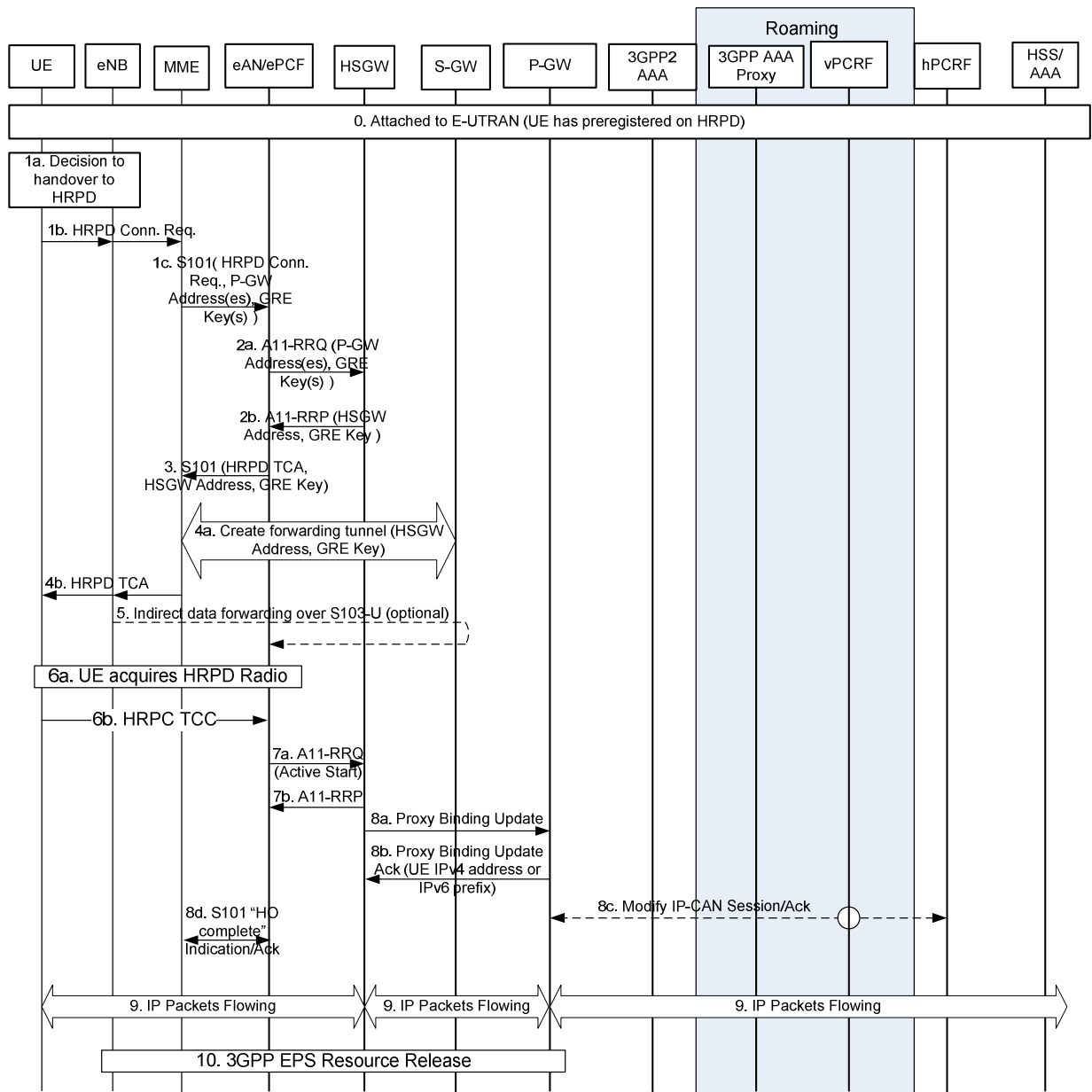

Figure 9.3.2-2

8.4.5.4.3 Test description

8.4.5.4.3.1 Pre-test conditions

System Simulator:

- Cell 1 and Cell 15.
- System information combination 6 as defined in TS 36.508 [18] clause 4.4.3.1 is used in E-UTRA cells.

UE:

None.

Preamble:

- The UE is in state Generic RB Established (state 3B) on Cell 1 according to [18].
- The UE has performed HRPD pre-registration on Cell 15.

8.4.5.4.3.2 Test procedure sequence

Table 8.4.5.4.3.2-1 illustrates the downlink power levels and other changing parameters to be applied for the cells at various time instants of the test execution. Row marked "T0" denotes the initial conditions, while row marked "T1" is to be applied subsequently. The exact instants on which these values shall be applied are described in the texts in this clause.

Table 8.4.5.4.3.2-1: Time instances of cell power level and parameter changes

	Parameter	Unit	Cell 1	Cell 15	Remark
T0	Cell-specific RS EPRE	dBm/15k Hz	-75	-	The power level values are such that camping on Cell 1 is guaranteed.
	̂or/loc	dB	-	-20	
	loc	dBm/1.23 MHz	-	-55	
	Pilot Ec/Io (Note 1)	dB	-	-20	
T1	Cell-specific RS EPRE	dBm/15k Hz	-80	-	The power level values are such that entering conditions for event B2 on Cell 15 are satisfied.
	̂or/loc	dB	-	-5	
	loc	dBm/1.23 MHz	-	-55	
	Pilot Ec/Io (Note 1)	dB	-	-6	
Note 1: This parameter is not directly settable, but is derived by calculation from the other parameters set by the SS.					

Table 8.4.5.4.3.2-2: Main behaviour

St	Procedure	Message Sequence		TP	Verdict
		U - S	Message		
1	The SS transmits an <i>RRConnectionReconfiguration</i> message on Cell 1 to setup inter RAT measurement on Cell 15.	<--	<i>RRConnectionReconfiguration</i>	-	-
2	The UE transmits an <i>RRConnectionReconfigurationComplete</i> message on Cell 1 to confirm the setup of inter RAT measurement.	-->	<i>RRConnectionReconfigurationComplete</i>	-	-
3	The SS changes Cell 1 and Cell 15 parameters according to row "T1" in table 8.4.5.4.3.2-1.	-	-	-	-
4	The UE transmits a <i>MeasurementReport</i> message on Cell 1 to report event B2 for Cell 15.	-->	<i>MeasurementReport</i>	-	-
5	The SS transmits a <i>HandoverFromEUTRAPreparationRequest</i> on Cell 1.	<--	<i>HandoverFromEUTRAPreparationRequest</i>	-	-
6	Check: Does the UE transmit tunnelled HRPD <i>Connection Request</i> and <i>Route Update</i> messages contained in an <i>ULHandoverPreparationTransfer</i> message on Cell 1?	-->	<i>ULHandoverPreparationTransfer</i>	1	P
7	The SS transmits tunnelled HRPD <i>Traffic Channel Assignment</i> , <i>HRPD Silence Parameters</i> and <i>HRPD Open Loop Parameters</i> messages contained in a <i>MobilityFromEUTRACommand</i> on Cell1 to order the UE to perform inter RAT handover to Cell 15.	<--	<i>MobilityFromEUTRACommand</i>	-	-
8	The UE tunes to HRPD radio.	-	-	-	-
9	Check: Does the UE transmit a <i>Traffic Channel Complete</i> message on Cell 15?	-->	<i>Traffic Channel Complete</i>	2	P

Table 8.4.5.4.3.3-3: MeasObjectCDMA2000-GENERIC (step 1, Table 8.4.5.4.3.2-2)

Derivation Path: 36.508, Table 4.6.6-1C			
Information Element	Value/remark	Comment	Condition
MeasObjectCDMA2000-GENERIC ::= SEQUENCE {			
cdma2000-Type	TypeHRPD		
CarrierFreqCDMA2000 SEQUENCE {			
bandClass	Band Class of frequency under test		
arfcn	f14		
}			
SearchWindowSize	15		
offsetFreq	db0		
cellsToRemoveList	Not present		
cellsToAddModList CHOICE {}	Cell 15	Listed cell parameters to be reported	
cellForWhichToReportCGI	Not present		
}			

Table 8.4.5.4.3.3-4: MeasurementReport (step 4, Table 8.4.5.4.3.2-2)

Derivation Path: 36.508, Table 4.6.1-5			
Information Element	Value/remark	Comment	Condition
MeasurementReport ::= SEQUENCE {			
criticalExtensions CHOICE {			
c1 CHOICE{			
measurementReport-r8 SEQUENCE {			
measResults SEQUENCE {			
measId	1		
measResultServCell SEQUENCE {			
rsrpResult	(0..97)		
rsrqResult	(0..34)		
}			
measResultNeighCells CHOICE {			
measResultsCDMA2000 ::=SEQUENCE {			
preRegistrationStatusHRPD	TRUE		
measResultListCDMA2000 ::=SEQUENCE (SIZE (1..maxCellReport)) OF SEQUENCE {	1 entry	Note 1	
physCellId[1]	PhysicalCellIdentity of Cell 15		
cgi-Info[1]	Not present		
measResult[1] SEQUENCE {			
pilotStrength	(0..63)		
}			
}			
}			
}			
}			
}			
}			
}			

Table 8.4.5.4.3.3-5: HandoverFromEUTRAPreparationRequest (step 5, Table 8.4.5.4.3.2-2)

Derivation Path: 36.508 Table 4.6.1-4			
Information Element	Value/remark	Comment	Condition
HandoverFromEUTRAPreparationRequest ::= SEQUENCE {			
criticalExtensions CHOICE {			
c1 CHOICE {			
handoverFromEUTRAPreparationRequest-r8			
SEQUENCE {			
cdma2000-Type	typeHRPD		
rand	Not present		
mobilityParameters	Not present		
}			
}			
}			

Table 8.4.5.4.3.3-6: ULHandoverPreparationTransfer (step 6, Table 8.4.5.4.3.2-2)

Derivation Path: 36.508 Table 4.6.1-24			
Information Element	Value/remark	Comment	Condition
ULHandoverPreparationTransfer ::= SEQUENCE {			
criticalExtensions CHOICE {			
c1 CHOICE {			
ulHandoverPreparationTransfer-r8 SEQUENCE {			
cdma2000-Type	typeHRPD		
meid	Not present		
dedicatedInfo	Set according to Table 8.4.5.4.3.3-6A	HRPD Connection Request and Route Update	
}			
}			
}			
}			

Table 8.4.5.4.3.3-6A: *dedicatedInfo* in *ULHandoverPreparationTransfer* (step 6, Table 8.4.5.4.3.2-2)

Information Element	Value/remark	Comment	Condition
SAPState	'0'B	SAP Header	
SessionConfigurationToken	16 bits, Set by UE		
ConnectionLayerFormat	1 bit, Set by UE		
ATI Record	34 bits, Set based on UATI assigned to UE		
Reserved	'0000'B		
Length	Length of <i>HRPD Route Update</i> message (Table 8.4.5.4.3.3-7A) + length of StreamHeader + length of SLPHeader + length of SNPHeader below, Set by SS	Connection Layer Header	
StreamHeader	'00'B	Stream Layer header. Stream 0 is assigned to the Default Signalling Application	
SLPHeader	Set by the UE	Signalling Link Protocol SLP-D and SLP-F headers.	
SNPHeader	'00001110'	Signalling Network Protocol header. InConfigurationProtocol=0, Type=Route Update.	
SessionLayerPacket	<i>HRPD Route Update</i> message (Table 8.4.5.4.3.3-7A)		
Length	Length of <i>HRPD Connection Request</i> message (Table 8.4.5.4.3.3-7) + length of StreamHeader + length of SLPHeader + length of SNPHeader below, Set by SS	Connection Layer Header	
StreamHeader	'00'B	Stream Layer header. Stream 0 is assigned to the Default Signalling Application	
SLPHeader	Set by the UE	Signalling Link Protocol SLP-D and SLP-F headers.	
SNPHeader	'00001100'	Signalling Network Protocol header. InConfigurationProtocol=0, Type=Idle State.	
SessionLayerPacket	<i>HRPD Connection Request</i> message (Table 8.4.5.4.3.3-7)		

Table 8.4.5.4.3.3-7: HRPD Connection Request (step 6, Table 8.4.5.4.3.2-2)

Information Element	Value/remark	Comment	Condition
MessageID	'0000001'	Connection Request	this value shall be verified by TTCN
TransactionID	Any allowed value	8 bit field	
RequestReason	'0000'	Access Terminal Initiated	

Table 8.4.5.4.3.3-7A: HRPD Route Update (step 6, Table 8.4.5.4.3.2-2)

Information Element	Value/remark	Comment	Condition
MessageID	'0000000'B	Route Update	this value shall be verified by TTCN
MessageSequence	8 bits, Set by UE		
ReferencePilotPN	9 bits, Set by UE		
ReferencePilotStrength	6 bits, Set by UE		
ReferenceKeep	'1'B		
NumPilots	'0000'B		
CompatibleReserved	'0'B		
ReferencePilotChannelIncluded	'1'B		
ReferencePilotChannel	24 bits, Set by UE		
ReferencePilotArrivalIncluded	'1'B		
ReferencePilotArrival	15 bits, Set by UE		
Reserved	0-7 bits, Set all 0s by UE		

Table 8.4.5.4.3.3-8: MobilityFromEUTRACommand (step 7, Table 8.4.5.4.3.2-2)

Derivation Path: 36.508, Table 4.6.1-6			
Information Element	Value/remark	Comment	Condition
MobilityFromEUTRACommand ::= SEQUENCE {			
criticalExtensions CHOICE {			
c1 CHOICE{			
mobilityFromEUTRACommand-r8 SEQUENCE {			
csFallbackIndicator	False		
purpose CHOICE{			
handover SEQUENCE {			
targetRAT-Type	cdma2000-HRPD		
targetRAT-MessageContainer	Set according to Table 8.4.5.4.3.3-8 A	HRPD Silence Parameters and HRPD Open Loop Parameters, HRPD Traffic Channel Assignment	
}			
}			
}			
}			
}			
}			

Table 8.4.5.4.3.3-8A: targetRAT-MessageContainer in MobilityFromEUTRACommand (step 7, Table 8.4.5.4.3.2-2)

Information Element	Value/remark	Comment	Condition
SAPState	'1'B	SAP Header	
SessionConfigurationToken	'0'B		
ConnectionLayerFormat	1 bit, Set by SS		
ATI Record	34 bits, Set based on UATI assigned to UE		
Reserved	'0000'B		
Length	Length of <i>HRPD Silence Parameters</i> message (Table 8.4.5.4.3.3-9A) + length of StreamHeader + length of SLPHeader + length of SNPHeader below, Set by SS	Connection Layer Header (Note 1)	
StreamHeader	'00'B	Stream Layer header. Stream 0 is assigned to the Default Signalling Application	
SLPHeader	Set by the SS	Signalling Link Protocol SLP-D and SLP-F headers.	
SNPHeader	'00001111'	Signalling Network Protocol header. InConfigurationProtocol=0, Type=Overhead Messages.	
SessionLayerPacket	<i>HRPD Silence Parameters</i> message (Table 8.4.5.4.3.3-9A)	(Note 1)	
Length	Length of <i>HRPD Open Loop Parameters</i> message (Table 8.4.5.4.3.3-9B) + length of StreamHeader + length of SLPHeader + length of SNPHeader below, Set by SS	Connection Layer Header (Note 1)	
StreamHeader	'00'B	Stream Layer header. Stream 0 is assigned to the Default Signalling Application	
SLPHeader	Set by the SS	Signalling Link Protocol SLP-D and SLP-F headers.	
SNPHeader	'00000100'	Signalling Network Protocol header. InConfigurationProtocol=0, Type=Reverse Traffic Channel MAC.	
SessionLayerPacket	<i>HRPD Open Loop Parameters</i> message (Table 8.4.5.4.3.3-9B)	(Note 1)	
Length	Length of <i>HRPD Traffic Channel Assignment</i> message (Table 8.4.5.4.3.3-9) + length of StreamHeader + length of SLPHeader + length	Connection Layer Header	

	of SNPHeader below, Set by SS		
StreamHeader	'00'B	Stream Layer header. Stream 0 is assigned to the Default Signalling Application	
SLPHeader	Set by the SS	Signalling Link Protocol SLP-D and SLP-F headers.	
SNPHeader	'00001110'	Signalling Network Protocol header. InConfigurationProtocol=0, Type=Route Update.	
SessionLayerPacket	<i>HRPD Traffic Channel Assignment</i> message (Table 8.4.5.4.3.3-9)		

Note 1: *HRPD Silence Parameters* message and *HRPD Open Loop Parameters* message can be sent in any order.

Table 8.4.5.4.3.3-9: HRPD Traffic Channel Assignment (step 7, Table 8.4.5.4.3.2-2)

Information Element	Value/remark	Comment	Condition
MessageID	'0000001'B	Traffic Channel Assignment	
MessageSequence	Set by SS	8 bit field	
ChannelIncluded	'1'B	Channel record included	
Channel	'00000000000000001111010'B	channel record for Cell 15	
FrameOffset	'1010'B	frame offset for Cell 15	
DRCLength	'01'B	DRCLength for Cell 15	
DRCChannelGainBase	'111101'B	ratio of the power level of the DRC Channel (when it is transmitted) to the power level of the Reverse Traffic Pilot Channel expressed as 2's complement value in units of 0.5 dB	
ACKChannelGain	'000110'B	ratio of the power level of the Ack Channel (when it is transmitted) to the power level of the Reverse Traffic Pilot Channel expressed as 2's complement value in units of 0.5 dB	
NumPilots	'1'B		
PilotPN	'000110010'B	PN Offset of target sector (Cell 15)	
SofterHandoff	'0'B	Set to '0'since only 1 pilot included in message	
MACIndexLSBs	Set by SS	6 least significant bits of the MACIndex assigned to UE	
DRCCover	'001'B	index of the DRC cover associated with target sector (Cell 15)	
RABLength	'01'B	2 bit field	
RABOffset	'010'B	3 bit field	

Table 8.4.5.4.3.3-9A: HRPD Silence Parameters (step 7, Table 8.4.5.4.3.2-2)

Information Element	Value/remark	Comment	Condition
MessageID	'00000010'B		
ReverseLinkSilenceDuration	2 bits, Set by SS		
ReverseLinkSilencePeriod	2 bits, Set by SS		
Reserved	0-7 bits, Set all 0s by SS		

Table 8.4.5.4.3.3-9B: HRPD Open Loop Parameters (step 7, Table 8.4.5.4.3.2-2)

Information Element	Value/remark	Comment	Condition
MessageID	'0000111'B		
NumPilots	'0001'B		
PilotPN	9 bits, Set by SS		
OpenLoopAdjust	8 bits, Set by SS		
InitialAdjust	5 bits, Set by SS		
PilotStrengthIncluded	1 bit, Set by SS		
PilotStrengthNominal	3 bits, Set by SS		
PilotStrengthCorrectionMin	3 bits, Set by SS		
PilotStrengthCorrectionMax	3 bits, Set by SS		
Reserved	0-7 bits, Set all 0s by SS		

Table 8.4.5.4.3.3-10: HRPD Traffic Channel Complete (step 9, Table 8.4.5.4.3.2-2)

Information Element	Value/remark	Comment	Condition
MessageID	'00000010'		this value shall be verified by TTCN
MessageSequence	Same value as MessageSequence in HRPD Traffic Channel Assignment message (Table 8.4.5.4.3.3-9)		

8.4.6 Inter-RAT handover HRPD to E-UTRA

8.4.7 Inter-RAT mobility E-UTRA to 1xRTT

8.4.7.1 Inter-RAT handover / SRVCC from E-UTRA to 1xRTT(CS) / Speech

8.4.7.1.1 Test Purpose (TP)

(1)

```
with { UE in E-UTRA RRC_CONNECTED state }
ensure that {
  when { UE receives a HandoverFromEUTRAPreparationRequest message with cdma2000-type set to 'type1xRTT' }
  then { UE transmits an ULHandoverPreparationTransfer message containing a tunnelled 1xRTT Origination message }
}
```

(2)

```
with { UE in E-UTRA RRC_CONNECTED state }
ensure that {
  when { UE receives a MobilityFromEUTRACommand message containing a tunnelled 1xRTT Handoff Direction message }
  then { UE transmits a 1xRTT Handoff Completion message on the target 1xRTT cell }
}
```

8.4.7.1.2 Conformance requirements

References: The conformance requirements covered in the present TC are specified in: TS 36.331, clauses 5.4.3.3, 5.4.4.3, 5.4.5.1 and 5.4.5.3, TS 23.216, clause 6.1.3 and 3GPP2 X.S0042-A v1.0, clause 4.5.1.

[TS 36.331, clause 5.4.3.3]

The UE shall be able to receive a *MobilityFromEUTRACommand* message and perform a cell change order to GERAN, even if no prior UE measurements have been performed on the target cell.

The UE shall:

- 1> stop timer T310, if running;
- 1> if the *MobilityFromEUTRACommand* message includes the *purpose* set to 'handover':
 - 2> if the *targetRAT-Type* is set to 'utra' or 'geran':
 - ...
 - 2> else if the *targetRAT-Type* is set to 'cdma2000-1XRTT' or 'cdma2000-HRPD':
 - 3> forward the *targetRAT-Type* and the *targetRAT-MessageContainer* to the CDMA2000 upper layers for the UE to access the cell indicated in the inter-RAT message in accordance with the specifications of the CDMA2000 target-RAT;

[TS 36.331, clause 5.4.4.3]

Upon reception of the *HandoverFromEUTRAPreparationRequest* message, the UE shall:

- 1> indicate the request to prepare handover and forward the *cdma2000-Type* to the CDMA2000 upper layers;
- 1> if *cdma2000-Type* is set to 'type1XRTT':
 - 2> forward the *rand* and the *mobilityParametersCDMA2000* to the CDMA2000 upper layers;

[TS 36.331, clause 5.4.5.1]



Figure 5.4.5.1-1: UL handover preparation transfer

The purpose of this procedure is to tunnel the handover related CDMA2000 dedicated information from UE to E-UTRAN when requested by the higher layers. The procedure is triggered by the higher layers on receipt of *HandoverFromEUTRAPreparationRequest* message. This procedure applies to CDMA2000 capable UEs only.

[TS 36.331, clause 5.4.5.3]

The UE shall set the contents of the *ULHandoverPreparationTransfer* message as follows:

- 1> include the *cdma2000-Type* and the *dedicatedInfoCDMA2000*;
- 1> if the *cdma2000-Type* is set to 'type1XRTT':
 - 2> include the *meid* and set it to the value received from the CDMA2000 upper layers;
- 1> submit the *ULHandoverPreparationTransfer* message to lower layers for transmission, upon which the procedure ends;

[TS 23.216, clause 6.1.3]

Figure 6.1.3-1 illustrates a high-level call flow for the E-UTRAN-to-1x voice service continuity procedure.

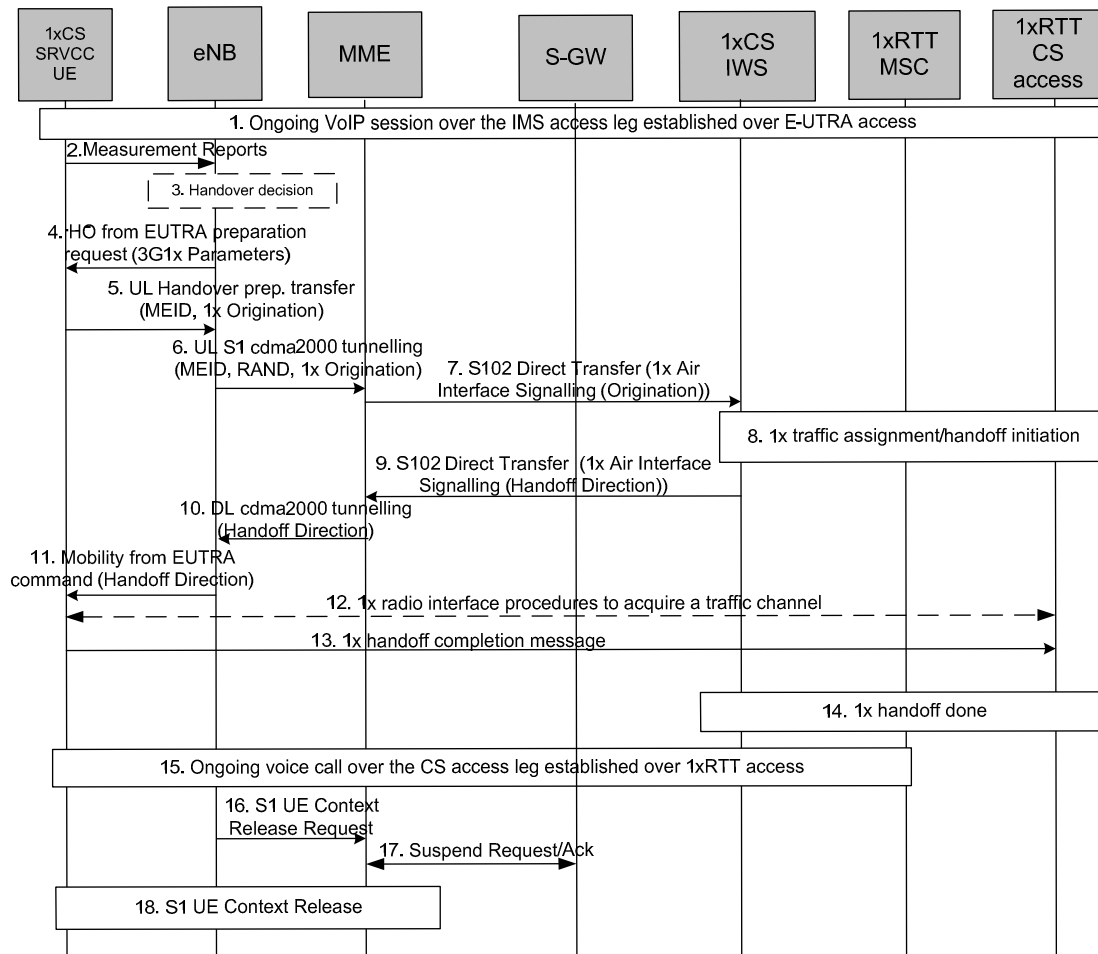

Figure 6.1.3-1: LTE VoIP-to-1x CS voice service continuity

1. Ongoing VoIP session over the IMS access leg established over EPS/E-UTRAN access.
2. 1xCS SRVCC UE sends measurement reports to eNodeB.
3. The E-UTRAN (e.g., based on some trigger, measurement reports) makes a determination to initiate an inter-technology handover to cdma2000 1xRTT.
4. The E-UTRAN signals the UE to perform an inter-technology handover by sending a Handover from EUTRA Preparation Request (3G1x Overhead Parameters, RAND value) message.
5. The UE initiates signalling for establishment of the CS access leg by sending a UL handover preparation message containing the 1xRTT Origination message.
6. The E-UTRAN sends an Uplink S1 cdma2000 Tunnelling (MEID, RAND, 1x Origination, Reference CellID) message to the MME. The eNodeB will also include CDMA2000 HO Required Indication IE to Uplink S1 CDMA2000 Tunnelling message, which indicates to the MME that the handover preparation has started.
7. Upon reception of the Uplink S1 cdma2000 Tunnelling message, the MME selects a 3GPP2 1xCS IWS based on Reference CellID and encapsulates the 1x Origination Message along with the MEID and RAND in a S102 Direct Transfer message (as "1x Air Interface Signalling").
8. The traffic channel resources are established in the 1x RTT system and 3GPP2 1xCS procedures for initiation of Session Transfer are performed as per 3GPP2 X.S0042-A v1.0 [4].

NOTE 1: Step 9 and 3GPP2 1xCS procedures in step 8 are independent of each other.

NOTE 2: The "VDN" parameter referred to in 3GPP2 X.S0042-A v1.0 [4] corresponds to the STN-SR parameter defined in TS 23.237 [14].

9. The 3GPP2 1xCS IWS creates a 1x message and encapsulates it in a S102 Direct Transfer message (1x , Handover indication). If the 3GPP2 access was able to allocate resources successfully, the 1x message is a 1x Handover Direction message and the handover indicator indicates successful resource allocation. Otherwise, the handover indicator indicates to the MME that handover preparation failed and the embedded 1x message indicates the failure to the UE.
10. The MME sends the 1x message and CDMA2000 HO Status IE in a Downlink S1 cdma2000 Tunnelling message to the E-UTRAN. The CDMA2000 HO Status IE is set according to the handover indicator received over the S102 tunnel.
11. If the CDMA2000 HO Status IE indicates successful handover preparation, the E-UTRAN forwards the 1x Handoff Direction message embedded in a Mobility from EUTRA Command message to the UE. This is perceived by the UE as a Handover Command message. If handover preparation failed, DL Information transfer message will be sent instead, with the embedded 1xRTT message that indicates the failure to the UE.
12. Once the UE receives the traffic channel information from the cdma2000 1xRTT system, the UE retunes to the 1xRTT radio access network and performs traffic channel acquisition with the 1xRTT CS access (e.g., 1xRTT BSS).
13. The UE sends a 1xRTT handoff completion message to the 1xRTT CS access (e.g., 1xRTT BSS).
14. The 1xRTT CS Access sends message to 1xRTT MSC to indicate of handoff done. The resources between 1x CS IWS and 1xRTT MSC may be released at this step.
15. Ongoing voice call over the CS access leg established over 1xRTT access. The E-UTRAN/EPS context may be released based on the normal E-UTRAN/EPS procedure.
16. The eNodeB sends an S1 UE Context Release Request (Cause) message to the MME. Cause indicates the S1 release procedure is caused by handover from E-UTRAN to 1xRTT.
17. The MME exchanges Suspend Request/ Acknowledge messages with the Serving GW. The S1-U bearers are released for all EPS bearers and the GBR bearers are deactivated by the MME. The non-GBR bearers are preserved and are marked as suspended in the S-GW. Upon receipt of downlink data the S-GW should not send a downlink data notification message to the MME.
18. S1 UE Context in the eNodeB is released as specified in TS 23.401 [2].

[3GPP2 X.S0042-A v1.0, clause 4.5.1]

Figure 16 illustrates a detailed call flow for the single radio VoIP-to-1x CS voice DT procedure.

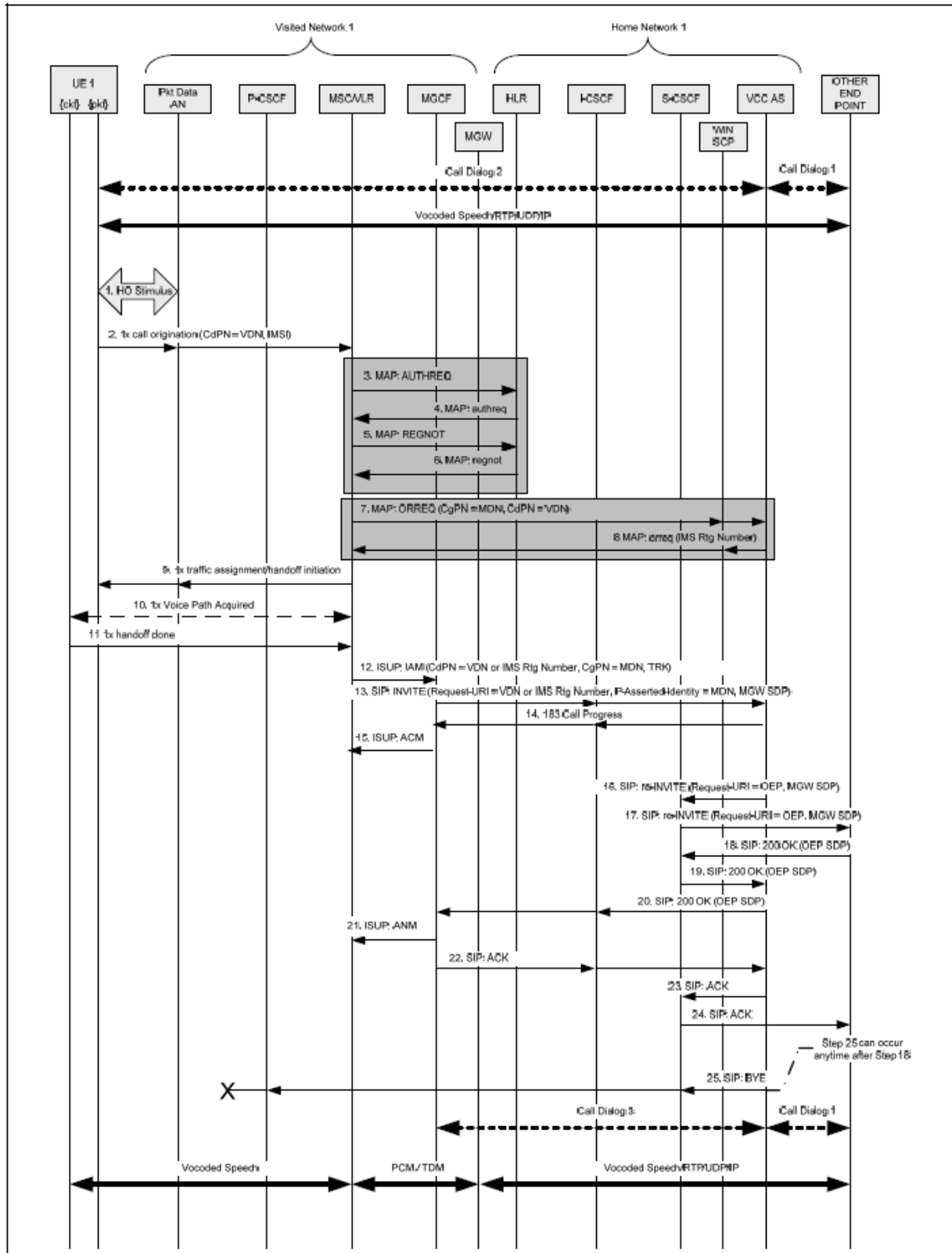

Figure 16 Single Radio VoIP-to-1x CS voice DT

Pre-condition:

It is assumed that initially there is an IMS VoIP call setup between a single radio, dual mode UE 1 and the Other End Point (OEP). SIP call dialog 1 for this voice call is illustrated by a heavy dashed double arrow between the VCC AS and

the OEP. SIP call dialog 2 for this voice call is illustrated by a heavy dashed double arrow between the VCC AS and UE 1. The voice bearer path is illustrated by a heavy solid double arrow between UE 1 and the OEP.

1. UE 1 and the packet data AN interact to initiate a DT. See [A.S0008-C v4.0] and [A.S0009-C v4.0] or [SRVCC] for signalling details.
2. UE 1 sends a 1x call origination to the MSC/VLR via the packet data AN (and optionally, the 1x BS) and includes the VDN. The specific messages and any acknowledgements are not shown for brevity. See [A.S0008-C v4.0] and [A.S0009-C v4.0] or [SRVCC] for signalling details.

NOTE 1: steps 3-6 are optional, depending on whether the UE 1 has previously been 1xCS registered and authenticated.

3. The Visited MSC/VLR may initiate a 1x registration procedure on behalf of UE 1. The Visited MSC sends a MAP AUTHREQ message to UE 1's HLR to authenticate UE 1 prior to allowing registration and prior to allocating a 1x traffic channel to UE 1.
4. UE 1's HLR responds by sending an MAP authreq message to the Visited MSC.
5. The Visited MSC sends an MAP REGNOT message to UE 1's HLR.
6. UE 1's HLR responds by sending an MAP REGNOT message to the Visited MSC.

NOTE 2: Steps 7-8 are shown using the MAP ORREQ operation. Optionally, a post digit analysis trigger using the MAP ANLYZD operation may be used instead to obtain routing information for the DT.

NOTE 3: If either origination triggers are not supported by the MSC/VLR or origination triggers are not armed for this subscriber, proceed to Step 9.

7. Once the visited MSC/VLR has obtained the service profile for the originating subscriber (i.e., by Step 4), the Visited MSC/VLR invokes a call origination trigger to obtain routing information. The Visited MSC/VLR sends a MAP RREQ message to the WIN SCP (or to the HLR), containing the Calling Party Number (MDN) of UE 1 (derived from the IMSI) and the Called Party Number from the call origination. The WIN SCP (or HLR) sends the ORREQ message on to the VCC AS. Optionally, the Visited MSC/VLR may send the ORREQ message directly to a VCC AS that has an integrated WIN SCP function.
8. The VCC AS determines that this is a DT scenario based on the VDN in the Called Party Number (and the Calling Party Number) in the ORREQ message, and then allocates an IMS Routing Number, which is an E.164 temporary routing number associated with this DT. The VCC AS then sends back the MAP ORREQ message to WIN SCP (or HLR), which returns the ORREQ message to the MSC/VLR. Optionally, the VCC AS has an integrated WIN SCP function and sends the ORREQ message directly to the MSC/VLR.
9. Anytime after Step 2 the MSC/VLR sends a 1x traffic assignment/handoff initiation to UE 1 via the packet data AN and the packet data air interface. This instructs UE 1 to perform the handoff and acquire the 1x traffic channel. See [A.S0008-C v4.0] and [A.S0009-C v4.0] or [SRVCC] for signalling details.
10. The 1x BS acquires UE 1's reverse traffic channel and the voice path is established with the MSC.

8.4.7.1.3 Test description

8.4.7.1.3.1 Pre-test conditions

System Simulator:

- Cell 1 and Cell 19.
- System information combination 6 as defined in TS 36.508 [18] clause 4.4.3.1 is used in E-UTRA cells.

UE:

None.

Preamble:

- The UE is in state Generic RB Established (state 3) on Cell 1 according to [18].

8.4.7.1.3.2 Test procedure sequence

Table 8.4.7.1.3.2-1 illustrates the downlink power levels and other changing parameters to be applied for the cells at various time instants of the test execution. Row marked "T0" denotes the initial conditions, while row marked "T1" is to be applied subsequently. The exact instants on which these values shall be applied are described in the texts in this clause.

Table 8.4.7.1.3.2-1: Time instances of cell power level and parameter changes

	Parameter	Unit	Cell 1	Cell 19	Remark
T0	Cell-specific RS EPRE	dBm/15k Hz	-75	-	Cell 19 is off.
	Ior/loc	dB	-	-	
	Pilot Ec/Ior	dB	-	-	
	loc	dBm/1.23 MHz	-	-	
	Pilot Ec/Io (Note 1)	dB	-	-	
T1	Cell-specific RS EPRE	dBm/15k Hz	-75	-	The power level values are such that entering conditions for event B2 on Cell 19 are satisfied.
	Ior/loc	dB	-	0	
	Pilot Ec/Ior	dB	-	-7	
	loc	dBm/1.23 MHz	-	-75	
	Pilot Ec/Io (Note 1)	dB	-	-10	
Note 1: This parameter is not directly settable, but is derived by calculation from the other parameters set by the SS.					

Table 8.4.7.1.3.2-2: Main behaviour

St	Procedure	Message Sequence		TP	Verdict
		U - S	Message		
1	The SS transmits an <i>RRCCConnectionReconfiguration</i> message on Cell 1 to setup inter RAT measurement on Cell 19.	<--	<i>RRCCConnectionReconfiguration</i>	-	-
2	The UE transmits an <i>RRCCConnectionReconfigurationComplete</i> message on Cell 1 to confirm the setup of inter RAT measurement.	-->	<i>RRCCConnectionReconfigurationComplete</i>	-	-
3	The SS changes Cell 1 and Cell 19 parameters according to row "T1" in table 8.4.7.1.3.2-1.	-	-	-	-
4	The UE transmits a <i>MeasurementReport</i> message on Cell 1 to report event B2 for Cell 19.	-->	<i>MeasurementReport</i>	-	-
5	The SS transmits a <i>HandoverFromEUTRAPreparationRequest</i> on Cell 1.	<--	<i>HandoverFromEUTRAPreparationRequest</i>	-	-
6	Check: Does the UE transmit a tunnelled <i>1xRTT GCSNA Encapsulated Origination</i> message contained in an <i>ULHandoverPreparationTransfer</i> message on Cell 1?	-->	<i>ULHandoverPreparationTransfer</i>	1	P
7	The SS transmits a tunnelled <i>1xRT GCSNA Encapsulated T Handoff Direction</i> message contained in a <i>MobilityFromEUTRACommand</i> on Cell1 to order the UE to perform inter RAT handover to Cell 19.	<--	<i>MobilityFromEUTRACommand</i>	-	-
8	The UE tunes to 1xRTT radio.	-	-	-	-
9	Check: Does the UE transmit a <i>1xRTT Handoff Completion</i> message on Cell 19?	-->	<i>Handoff Completion</i>	2	P

8.4.7.1.3.3 Specific message contents

Table 8.4.7.1.3.3-1: RRCConnectionReconfiguration (step 1, Table 8.4.7.1.3.2-2)

Derivation Path: 36.508, Table 4.6.1-8, condition MEAS
--

Table 8.4.7.1.3.3-2: MeasConfig (step 1, Table 8.4.7.1.3.2-2)

Derivation Path: 36.508, Table 4.6.6-1			
Information Element	Value/remark	Comment	Condition
MeasConfig ::= SEQUENCE {			
measObjectToAddModList SEQUENCE (SIZE (1..maxObjectId)) OF SEQUENCE {	2 entries		
measObjectId[1]	IdMeasObject-f1		
measObject[1]	MeasObjectEUTRA-GENERIC(f1)		
measObjectId[2]	IdMeasObject-f17		
measObject[2]	MeasObjectCDMA2000-GENERIC		
}			
reportConfigToAddModList SEQUENCE (SIZE (1..maxReportConfigId)) OF SEQUENCE {	1 entry		
reportConfigId[1]	IdReportConfig-B2-CDMA2000		
reportConfig[1]	ReportConfigInterRAT-B2-CDMA2000(-69, -18)		
}			
measIdToAddModList SEQUENCE (SIZE (1..maxMeasId)) OF SEQUENCE {	1 entry		
measId[1]	1		
measObjectId[1]	IdMeasObject-f17		
reportConfigId[1]	IdReportConfig-B2-CDMA2000		
}			
quantityConfig SEQUENCE {			
quantityConfigEUTRA	Not present		
quantityConfigUTRA	Not present		
quantityConfigGERAN	Not present		
quantityConfigCDMA2000 SEQUENCE {			
measQuantityCDMA2000	pilotPnPhaseAndpilotStrength		
}			
}			
measGapConfig CHOICE {			
setup SEQUENCE {			
gapOffset CHOICE {			
gp1	30		
}			
}			
}			
}			
}			
}			

Table 8.4.7.1.3.3-3: MeasObjectCDMA2000-GENERIC (step 1, Table 8.4.7.1.3.2-2)

Derivation Path: 36.508, Table 4.6.6-1C			
Information Element	Value/remark	Comment	Condition
MeasObjectCDMA2000-GENERIC ::= SEQUENCE {			
cdma2000-Type	Type1XRTT		
CarrierFreqCDMA2000 SEQUENCE {			
bandClass	Band Class of frequency under test		
arfcn	f17		
}			
SearchWindowSize	15		
offsetFreq	db0		
cellsToRemoveList	Not present		
cellsToAddModList CHOICE {}	Cell 19		
cellForWhichToReportCGI	Not present		
}			

Table 8.4.7.1.3.3-4: MeasurementReport (step 4, Table 8.4.7.1.3.2-2)

Derivation Path: 36.508, Table 4.6.1-5			
Information Element	Value/remark	Comment	Condition
MeasurementReport ::= SEQUENCE {			
criticalExtensions CHOICE {			
c1 CHOICE {			
measurementReport-r8 SEQUENCE {			
measResults SEQUENCE {			
measId	1		
measResultServCell SEQUENCE {			
rsrpResult	(0..97)		
rsrqResult	(0..34)		
}			
measResultNeighCells CHOICE {			
measResultsCDMA2000 ::=SEQUENCE {			
preRegistrationStatusHRPD	FALSE		
measResultListCDMA2000 ::=SEQUENCE (SIZE (1..maxCellReport)) OF SEQUENCE {	1 entry		
physCellId[1]	PhysicalCellIdentity of Cell 19		
cgi-Info[1]	Not present		
measResult[1] SEQUENCE {			
pilotPnPhase	(0..32767)		
pilotStrength	(0..63)		
}			
}			
}			
}			
}			

Table 8.4.7.1.3.3-5: HandoverFromEUTRAPreparationRequest (step 5, Table 8.4.7.1.3.2-2)

Derivation Path: 36.508 Table 4.6.1-4			
Information Element	Value/remark	Comment	Condition
HandoverFromEUTRAPreparationRequest ::= SEQUENCE {			
criticalExtensions CHOICE {			
c1 CHOICE {			
handoverFromEUTRAPreparationRequest-r8			
SEQUENCE {			
cdma2000-Type	Type1XRTT		
Rand	Set by SS	Random Challenge Data as broadcast on Cell 19	
mobilityParameters	Set according to 36.508 Table 4.5.2C.4-6	CDMA2000Parameters	
}			
}			
}			

Table 8.4.7.3.3.3-6: Void**Table 8.4.7.1.3.3-7: ULHandoverPreparationTransfer (step 6, Table 8.4.7.1.3.2-2)**

Derivation Path: 36.508 Table 4.6.1-24			
Information Element	Value/remark	Comment	Condition
ULHandoverPreparationTransfer ::= SEQUENCE {			
criticalExtensions CHOICE {			
c1 CHOICE {			
ulHandoverPreparationTransfer-r8 SEQUENCE {			
cdma2000-Type	Type1XRTT		
Meid	UE's meid		
dedicatedInfo	Set according to Table 8.4.7.1.3.3-8	1xRTT GCSNA Encapsulated Origination message	
}			
}			
}			
}			

Table 8.4.7.1.3.3-8: 1xRTT Origination (step 6, Table 8.4.7.1.3.2-2)

Field	Value/remark	Comment	Condition
MessageID	'00000001'B	GCSNA 1xCircuitService message	
GCSNAOption	'00001000'B		
AlternativeGCSNAOption_INCL	'0'B		
IWSIDIncl	'0'B		
AckRequired	'0'B		
StopDupDetect	'0'B		
MessageSequence	6 bits, Set by UE		
NumTLACEncapsulated1xL3PDU	'00'B		
Reserved	'0000'B		
1xLogicalChannel	'0'B		
1xProtocolRevision	'00000110'B		
MsgType	'00000100'B	Origination message	
NumTLACHeaderRecords	'0001'B		
TLACHeaderRecordType	'0000'B		
TLACHeaderRecordLength	4 bits, Set by UE		
MSID_TYPE	3 bits, Set by UE	Should be matched with PREF_MSID_TYP E	
MSID_LEN	4 bits, Set by UE		
MSID	Variable, Set by UE		
Reserved	'0000000'B		
1xL3PDULength	16 bits, Set by UE		
MOB_TERM	'1'B		
SLOT_CYCLE_INDEX	'010'B		
MOB_P_REV	8 bits, Set by UE		
SCM	8 bits, Set by UE		
REQUEST_MODE	'001'B		
SPECIAL_SERVICE	'1'B		
SERVICE_OPTION	16 bits, any value mapping to a voice service option		
PM	'0'B		
DIGIT_MODE	'0'B		
NUMBER_TYPE	3 bits, Set by UE		
NUMBER_PLAN	4 bits, Set by UE		
MORE_FIELDS	'0'B		
NUM_FIELDS	8 bits, Set by UE		
CHARi	Variable, Set by UE		
NAR_AN_CAP	'0'B		
PACA_REORIG	'0'B		
RETURN_CAUSE	'0000'B		
MORE_RECORDS	'0'B		
ENCRYPTION_SUPPORTED	'0000'B		
PACA_SUPPORTED	'0'B		
NUM_ALT_SO	'000'B		
DRS	'1'B		
UZID_INCL	'0'B		
CH_IND	'01'B		
SR_ID	3 bits, Set by UE		
OTD_SUPPORTED	'1'B		
QPCH_SUPPORTED	'1'B		
ENHANCED_RC	'1'B		
FOR_RC_PREF	'00011'B		
REV_RC_PREF	'00011'B		
FCH_SUPPORTED	'1'B		
FCH Capability Type-specific fields	Variable		
DCCH_SUPPORTED	'1'B		
RESERVED	'0'B		
REV_FCH_GATING_REQ	'0'B		

Table 8.4.7.1.3.3-9: *MobilityFromEUTRACommand* (step 7, Table 8.4.7.1.3.2-2)

Derivation Path: 36.508, Table 4.6.1-6			
Information Element	Value/remark	Comment	Condition
MobilityFromEUTRACommand ::= SEQUENCE {			
criticalExtensions CHOICE {			
c1 CHOICE{			
mobilityFromEUTRACommand-r8 SEQUENCE {			
csFallbackIndicator	False		
purpose CHOICE{			
handover SEQUENCE {			
targetRAT-Type	cdma2000-1XRTT		
targetRAT-MessageContainer	Set according to Table 8.4.7.1.3.3-10	1xRTT GCSNA Encapsulated Handoff Direction message	
}			
}			
}			
}			
}			
}			

Table 8.4.7.1.3.3-10: 1xRTT GCSNA Encapsulated Handoff Direction (step 7, Table 8.4.7.1.3.2-2)

Field	Value/remark	Comment	Condition
MessageID	'00000001'B	GCSNA 1xCircuitService message	
GCSNAOption	'00001000'B		
AlternativeGCSNAOption_INCL	'0'B		
IWSIDIncl	'0'B		
AckRequired	'0'B		
StopDupDetect	'0'B		
MessageSequence	Set by SS		
NumTLACEncapsulated1xL3PDU	'00'B		
Reserved	'0000'B		
1xLogicalChannel	'1'B		
1xProtocolRevision	'00000110'B		
MsgType	'00100010'B	Universal Handoff Direction message	
NumTLACHheaderRecords	'0000'B		
Reserved	'000'B		
1xL3PDUlength	16 bits, Set by SS		
USE_TIME	'0'B		
ACTION_TIME	'000000'B		
HDM_SEQ	2 bits, Set by SS		
PARMS_INCL	'1'B		
P_REV	'00000110'B		
SERV_NEG_TYPE	'1'B		
SEARCH_INCLUDED	'1'B		
SRCH_WIN_A	'1000'B		
SRCH_WIN_N	'1001'B		
SRCH_WIN_R	'1011'B		
T_ADD	'010100'B		
T_DROP	'011110'B		
T_COMP	'1010'B		
T_TDROP	'0100'B		
SOFT_SLOPE	'000000'B		
ADD_INTERCEPT	'000000'B		
DROP_INTERCEPT	'000000'B		
EXTRA_PARMS	'1'B		
PACKET_ZONE_ID	'00000000'B		
FRAME_OFFSET	4 bits, Set by SS		
PRIVATE_LCM	'0'B		
RESET_L2	'1'B		
RESET_FPC	'1'B		
ENCRYPT_MODE	'00'B		
NOM_PWR_EXT	'0'B		
NOM_PWR	'0000'B		
RLGAIN_TRAFFIC_PILOT	'000000'B		
DEFAULT_RLAG	'1'B		
NUM_PREAMBLE	'000'B		
BAND_CLASS	5 bits, Set by SS		
CDMA_FREQ	11 bits, Set by SS		
RETURN_IF_HANDOFF_FAIL	'0'B		
PERIODIC_SEARCH	'0'B		
SCR_INCLUDED	'1'B		
NNSCR_INCLUDED	'1'B		
USE_PWR_CNTL_STEP	'0'B		
CLEAR_RETRY_DELAY	'0'B		
SCH_INCL	'1'B		
FPC_SUBCHAN_GAIN	'01010'B		
USE_PC_TIME	'0'B		
CH_IND	'101'B		
ACTIVE_SET_REC_LEN	8 bits, Set by SS		
NUM_PILOTS	'001'B		
SRCH_OFFSET_INCL	'1'B		
PILOT_PN	'000000000'B		

SRCH_OFFSET	'010'B		
ADD_PILOT_REC_INCL	'0'B		
PWR_COMB_IND	'0'B		
CODE_CHAN_FCH	11 bits, Set by SS		
QOF_MASK_ID_FCH	'00'B		
RESERVED	0-7 bits		
REV_FCH_GATING_MODE	'0'B		

Table 8.4.7.1.3.3-11: 1xRTT Handoff Completion (step 9, Table 8.4.7.1.3.2-2)

Information Element	Value/remark	Comment	Condition
MSG_ID	'00001010'		
ACK_SEQ	3 bits		
MSG_SEQ	3 bits		
ACK_REQ	'1'B		
ENCRYPTION	'00'B		
RESERVED	'0'B		
LAST_HDM_SEQ	Same value as HDM_SEQ in 1xRTT Handoff Direction message at Step 7		
PILOT_PN	Same value as PILOT_PN included in 1xRTT Handoff Direction message at Step 7		

8.4.7.2 Void

8.4.7.3 Pre-registration at 1xRTT and inter-RAT Redirection / CS fallback from E-UTRA RRC_IDLE to 1xRTT / MT call

8.4.7.3.1 Test Purpose (TP)

(1)

```
with { UE in E-UTRA RRC_IDLE state having completed the 1xRTT CS pre-registration procedure and
having received a DLInformationTransfer message containing a 1xRTT CS Paging message }
ensure that {
  when { CS paging for the CS Fallback to 1xRTT is accepted at the UE }
  then { UE transmits an ULInformationTransfer message containing an EXTENDED SERVICE REQUEST
message with Service Type IE set to "mobile terminating CS fallback or 1xCS fallback" }
}
```

(2)

```
with { UE having transmitted an ULInformationTransfer message containing an EXTENDED SERVICE REQUEST
message with Service Type IE set to "mobile terminating CS fallback or 1xCS fallback" in response to
a 1xRTT CS Paging message }
ensure that {
  when { SS transmits an RRCConnectionRelease message with redirection to 1xRTT }
  then { UE tunes to 1xRTT cell and transmits a 1xRTT Page Response message on 1xRTT cell }
}
```

8.4.7.3.2 Conformance requirements

References: The conformance requirements covered in the present TC are specified in: TS 23.272, clause B.2.3.

[TS 23.272, clause B.2.3]

This clause describes the mobile terminating call procedures when the UE accepts or rejects CS paging for the CS Fallback to 1xRTT.

When the 1x MSC receives a registration from a UE, it makes note of the RAN equipment from which it received the registration. Subsequent paging activities may thus be directed toward that RAN equipment. However, paging activities by the 1xMSC are not limited to the single RAN equipment from which the registration was received. The MSC may choose to page a wider area, including inter-system paging. If the 1xMSC has direct interfaces to 1xCS IWS, as well as

to 1xRTT access, the MSC may choose to do direct paging activities to both E-UTRAN and 1x RAN equipments in its attempts to contact the UE.

The 1x paging request sent by the 1xMSC to the 1xCS IWS is delivered to the UE via the tunnel. The UE tunes to 1xRTT access, acknowledges the 1x page and performs the 1xCS procedures for mobile terminated call.

The detailed procedure is described in figure B.2.3-1.

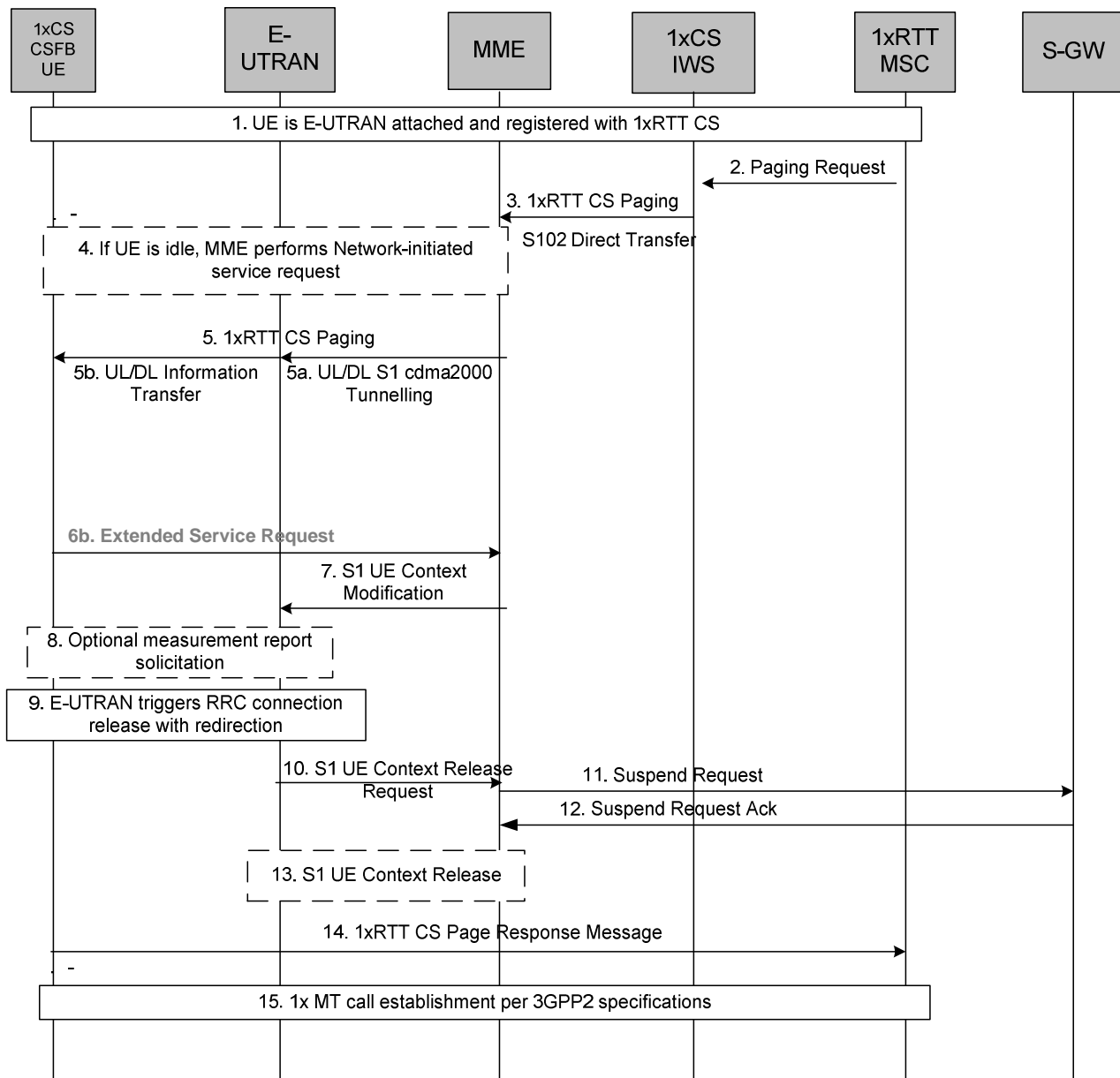

Figure B.2.3-1: CS MT call using fallback to CDMA 1x RTT network

1. UE is E-UTRAN attached and pre-registered with 1xRTT CS as defined in clause B.2.1.1.
2. 1xMSC sends a paging request to the 1xCS IWS node with Caller Line Identification if available.
3. 1xCS IWS node forwards the 1x RTT CS paging request with Caller Line Identification if available via the S102 tunnel to the MME.
4. If the UE is in idle state, the MME performs the network initiated Service Request procedure in order to bring the UE to active state prior to tunnelling of the 1x RTT CS paging request toward the UE.

5. MME forwards the 1xRTT CS paging request to the UE.
- 6a. Void.
- 6b. If the UE accepts CS paging for the CS Fallback to 1xRTT, the UE sends an Extended Service Request (CS Fallback Indicator) to the MME and proceeds with step 7 to step 15 below.
7. MME sends S1-AP: UE Context Modification (UE capabilities, CS Fallback Indicator) to indicate the E-UTRAN to move the UE to 1xRTT.
8. E-UTRAN may optionally solicit a measurement report from the UE to determine the target 1xRTT cell to which the CS Fallback will be performed.
9. E-UTRAN triggers RRC connection release with redirection to 1xCS.
10. E-UTRAN sends an S1 UE Context Release Request (Cause) message to the MME. Cause indicates that the S1 UE Context Release was caused by CS fallback to 1xRTT.
11. MME sets the UE context to suspended status and sends to the S-GW a Suspend Request (IMSI) message that requests the suspension of EPS bearers for the UE. The S1-U bearers are released for all EPS bearers by the MME and all GBR bearers are deactivated. The non-GBR bearers are preserved and are marked as suspended in the S-GW.
12. S-GW acknowledges the Suspend Request message and marks the UE as suspended. When a downlink data arrives at the S-GW, the S-GW should not send a downlink data notification message to the MME if the UE is marked as suspended.
13. S1 UE Context in the E-UTRAN is released as specified in TS 23.401 [2].
14. UE tunes to 1xRTT and acknowledges the page by transmitting a 1xRTT Paging Response message over the 1x Access Channel.
15. Subsequently UE performs the procedure for mobile terminated call establishment as specified in 3GPP2 A.S0013-D v4.0 [18].

8.4.7.3.3 Test description

8.4.7.3.3.1 Pre-test conditions

System Simulator:

- Cell 1 and Cell 19.
- Cell 19 has a lower reselection priority than Cell 1.
- System information combination 6 as defined in TS 36.508 [18] clause 4.4.3.1 is used in E-UTRA cells.

UE:

None.

Preamble:

- The UE is in state Registered, Idle mode pre-registered on 1xRTT (state 2C) on Cell 1 according to [18].
-

8.4.7.3.3.2 Test procedure sequence

Table 8.4.7.3.3.2-1 illustrates the downlink power levels and other changing parameters to be applied for the cells at various time instants of the test execution. Row marked "T0" denotes the initial conditions, while row marked "T1" is to be applied subsequently. The exact instants on which these values shall be applied are described in the texts in this clause.

Table 8.4.7.3.3.2-1: Cell configuration changes over time

	Parameter	Unit	Cell 1	Cell 19	Remark
T0	Cell-specific RS EPRE	dBm/15kHz	-60	-	Srxlev _{Cell 1} > 0 and Cell 19 is off such that camping on Cell 1 is guaranteed.
	I _{or} /I _{oc}	dB	-	-	
	Pilot Ec/I _{or}	dB	-	-	
	I _{oc}	dBm/1.23 MHz	-	-	
	Pilot Ec/I _o (Note 1)	dB	-	-	
T1	Cell-specific RS EPRE	dBm/15kHz	-60	-	Cell 19 is on, with S _{ServingCell} > Thresh _{serv, low} and S _{nonServingCell, x} < Thresh _{x, low} .
	I _{or} /I _{oc}	dB	-	0	
	Pilot Ec/I _{or}	dB	-	-7	
	I _{oc}	dBm/1.23 MHz	-	-75	
	Pilot Ec/I _o (Note 1)	dB	-	-10	
Note 1: This parameter is not directly settable, but is derived by calculation from the other parameters set by the SS.					

Table 8.4.7.3.3.2-2: Main behaviour

St	Procedure	Message Sequence		TP	Verdict
		U - S	Message		
1-8	Steps 2 to 9 of the generic radio bearer establishment procedure (TS 36.508 4.5.3.3-1) are executed to successfully complete the service request procedure.				
9	The SS changes the cell power levels according to "T1" in Table 8.4.7.3.3.2-1.				
10	The SS transmits a <i>DLInformationTransfer</i> containing a <i>1x RTT GCSNA encapsulated General Page</i> message on Cell 1.	<--	<i>DLInformationTransfer</i>	-	-
11	The CS paging for the CS Fallback to 1xRTT is accepted at the UE.	-	-	-	-
12	Check: Does the UE transmit an <i>ULInformationTransfer</i> containing an EXTENDED SERVICE REQUEST with Service Type IE set to "mobile terminating CS fallback or 1xCS fallback" on Cell 1?	-->	<i>ULInformationTransfer</i>	1	P
13	The SS transmits an <i>RRCCConnectionRelease</i> message on Cell 1 redirecting the UE to Cell 19.	<--	<i>RRCCConnectionRelease</i>	-	-
14	The UE tunes to 1xRTT radio.	-	-	-	-
15	Check: Does the UE transmit a <i>Page Response</i> message on Cell 19?	-->	<i>Page Response</i>	2	P
16	The SS transmits an <i>Extended Channel Assignment</i> message on Cell 19.	<--	<i>Extended Channel Assignment</i>	-	-
17	After the SS detects that Traffic Channel Initialization is successful, it transmits an <i>Acknowledgement Order</i> message on Cell 19.	<--	<i>Acknowledgement Order</i>	-	-
18	The SS transmits a <i>Service Connect</i> message on Cell 19.	<--	<i>Service Connect</i>	-	-
19	The UE transmits a <i>Service Connect Completion</i> message on Cell 19.	-->	<i>Service Connect Completion</i>	-	-

8.4.7.3.3.3 Specific message contents

Table 8.4.7.3.3.3-1: Void**Table 8.4.7.3.3.3-2: Void****Table 8.4.7.3.3.3-3: DLInformationTransfer (step 10, Table 8.4.7.3.3.2-2)**

Derivation Path: 36.508 Table 4.6.1-3			
Information Element	Value/remark	Comment	Condition
DLInformationTransfer ::= SEQUENCE {			
criticalExtensions CHOICE {			
c1 CHOICE {			
dlInformationTransfer-r8 SEQUENCE {			
dedicatedInfoType CHOICE {			
dedicatedInfoCDMA2000-1XRTT	Set according to Table 8.4.7.3.3.3-4		
}			
}			
}			
}			

Table 8.4.7.3.3.3-4: 1xRTT GCSNA encapsulated General Page message (step 10, Table 8.4.7.3.3.2-2)

Field	Value/remark	Comment	Condition
MessageID	'00000001'B	GCSNA1xCircuitService message	
GCSNAOption	'00000001'B		
AlternativeGCSNAOption_INCL	'0'B		
IWSIDIncl	'0'B		
AckRequired	'0'B		
StopDupDetect	'0'B		
MessageSequence	6 bits, Set by SS		
NumTLACEncapsulated1xL3PDU	'00'B		
Reserved	'0000'B		
1xLogicalChannel	'0'B		
1xProtocolRevision	'0000110'B		
MsgType	'00010001'B	General Page Message	
NumTLACHeaderRecords	'0000'B		
Reserved	'000'B		
1xL3PDULength	16 bits, Set by SS		
Service_Option	16 bits, Set by SS		

Table 8.4.7.3.3.3-5: ULInformationTransfer (step 12, Table 8.4.7.3.3.2-2)

Derivation Path: 36.508 Table 4.6.1-25			
Information Element	Value/remark	Comment	Condition
ULInformationTransfer ::= SEQUENCE {			
criticalExtensions CHOICE {			
c1 CHOICE {			
ulInformationTransfer-r8 SEQUENCE {			
dedicatedInfoType CHOICE {			
dedicatedInfoNAS	Set according to Table 8.4.7.3.3.3-6	EXTENDED SERVICE REQUEST	
}			
}			
}			
}			

Table 8.4.7.3.3.3-6: EXTENDED SERVICE REQUEST (step 12, Table 8.4.7.3.3.2-2)

Derivation Path: 36.508 Table 4.7.2-14A			
Information Element	Value/remark	Comment	Condition
Protocol discriminator	EMM		
Service type	'0001'B	mobile terminating CS fallback or 1xCS fallback	
CSFB response	'001'B	CS fallback accepted by the UE	

Table 8.4.7.3.3.3-7: RRCConnectionRelease (step 13, Table 8.4.7.3.3.2-2)

Derivation Path: 36.508 table 4.6.1-15			
Information Element	Value/remark	Comment	Condition
RRCConnectionRelease ::= SEQUENCE {			
criticalExtensions CHOICE {			
c1 CHOICE {			
rrcConnectionRelease-r8 SEQUENCE {			
redirectedCarrierInfo ::= CHOICE {			
cdma2000-1xRTT	cdma2000-CarrierInfo for Cell 19		
}			
}			
}			
}			

Table 8.4.7.3.3.3-8: Page Response (step 15, Table 8.4.7.3.3.2-2)

Field PD	Value/remark '01'B	Comment	Condition
MSG_ID	'000101'B	Page Response Message	this value shall be verified by TTCN
LAC Length Field	5 bits, Set by UE		
ACK_SEQ	3 bits, Set by UE		
MSG_SEQ	3 bits, Set by UE		
ACK_REQ	'1'B		
VALID_ACK	'1'B		
ACK_TYPE	'010'B		
MSID_TYPE	3 bits, Set by UE		
MSID_LEN	4 bits, Set by UE		
MSID	Variable, Set by UE		
LAC Padding Field	0 to 7, Set by UE		
ACTIVE_PILOT_STRENGTH	6 bits, set by UE		
FIRST_IS_ACTIVE	1 bit, set by UE		
FIRST_IS_PTA	1 bit, set by UE		
NUM_ADD_PILOTS	'0'B		
MOB_TERM	'1'B		
SLOT_CYCLE_INDEX	'010'B		
MOB_P_REV	8 bits, Set by UE		
SCM	8 bits, Set by UE		
REQUEST_MODE	'001'B		
SERVICE_OPTION	16 bits, Set by UE		
PM	'0'B		
NAAR_AN_CAP	'0'B		
NUM_ALT_SO	'000'B		
UZID_INCL	'0'B		
CH_IND	'01'B		
OTD_SUPPORTED	'1'B		
QPCH_SUPPORTED	'1'B		
ENHANCED_RC	'1'B		
FOR_RC_PREF	'00011'B		
REV_RC_PREF	'00011'B		
FCH_SUPPORTED	'1'B		
FCH_FRAME_SIZE	'0'B		
FOR_FCH_LEN	3 bits, Set by UE		
FOR_FCH_RC_MAP	Variable, Set by UE		
REV_FCH_LEN	3 bits, Set by UE		
REV_FCH_RC_MAP	Variable, Set by UE		
DCCH_SUPPORTED	'1'B		
REV_FCH_GATING_REQ	'0'B		

Table 8.4.7.3.3.3-9: Extended Channel Assignment (step 16, Table 8.4.7.3.3.2-2)

Field	Value/remark	Comment	Condition
MSG_TYPE	'00010101'B	Extended Channel Assignment Message	
ACK_SEQ	3 bits, Set by UE		
MSG_SEQ	3 bits, Set by UE		
ACK_REQ	'0'B		
VALID_ACK	'1'B		
ADDR_TYPE	3 bits, Set by UE		
ADDR_LEN	4 bits, Set by UE		
ADDRESS	Variable, Set by UE		
RESERVED_1	'0'B		
ADD_RECORD_LEN	8 bits, Set by UE		
ASSIGN_MODE	'100'B	Traffic Channel Assignment	
RESERVED_2	'00000'B		
BAND_CLASS	5 bits, Set by SS		
CDMA_FREQ	11 bits, Set by SS		
BYPASS_ALERT_ANSWER	'1'B		
GRANTED_MODE	'10'B		
DEFAULT_CONFIG	'100'B		
FOR_RC	'00011'B		
REV_RC	'00011'B		
FRAME_OFFSET	4 bits, Set by SS		
ENCRYPT_MODE	'00'B		
FPC_SUBCHAN_GAIN	'00001'B		
RLGAIN_ADJ	0000'B		
NUM_PILOTS	'000'B		
CH_IND	'01'B		
CH_RECORD_LEN	5 bits, Set by SS		
CH_RECORD_FIELDS	Variable, Set by SS		
REV_FCH_GATING_MODE	'0'B		
RESERVED	0 – 7 bits, Set by UE		
PDU_PADDING	0 – 7 bits, Set by UE		

Table 8.4.7.3.3.3-10: Acknowledgment Order (step 17, Table 8.4.7.3.3.2-2)

Field	Value/remark	Comment	Condition
MSG_TYPE	'00000001'B	Order Message	
ACK_SEQ	3 bits, Set by SS		
MSG_SEQ	3 bits, Set by SS		
ACK_REQ	'1'B		
ENCRYPTION	'00'B		
ORDER	'010000'B	Base Station Acknowledgment Order	
ORDQ	'00000000'B		

Table 8.4.7.3.3.3-11: Service Connect (step 18, Table 8.4.7.3.3.2-2)

Field	Value/remark	Comment	Condition
MSG_TYPE	'00010100'B	Service Connect Message	
ACK_SEQ	3 bits, Set by SS		
MSG_SEQ	3 bits, Set by SS		
ACK_REQ	1'B		
ENCRYPTION	'00'B		
USE_TIME	'0'B		
ACTION_TIME	'000000'B		
SERV_CON_SEQ	Set by SS		
RESERVED	'00000'B		
RECORD_TYPE	'00000111'B		
RECORD_LEN	8 bits, Set by SS		
Type-specific fields	Variable, Set by SS		
RECORD_TYPE	'00010011'B		
RECORD_LEN	8 bits, Set by SS		
Type-specific fields	Variable, Set by SS		
PDU_PADDING	0-7 bits, Set by SS		

Table 8.4.7.3.3.3-12: Service Connect Completion (step 19, Table 8.4.7.3.3.2-2)

Field	Value/remark	Comment	Condition
MSG_TYPE	'00001110'B	Service Connect Completion Message	this value shall be verified by TTCN
ACK_SEQ	3 bits, Set by UE		
MSG_SEQ	3 bits, Set by UE		
ACK_REQ	'1'B		
ENCRYPTION	'00'B		
RESERVED	'0'B		
SERV_CON_SEQ	Same value as SERV_CON_SEQ received in Service Connect Message (Table 8.4.7.3.3.3-11)		
PDU_PADDING	0-7 bits, Set by UE		

8.4.7.4 Pre-registration at 1xRTT and inter-RAT Redirection / CS fallback from E-UTRA RRC_CONNECTED to 1xRTT / MO call

8.4.7.4.1 Test Purpose (TP)

(1)

```
with { UE in E-UTRA RRC_CONNECTED state and having completed the 1xRTT CS pre-registration procedure }
ensure that {
  when { a voice call is originated at the UE }
  then { UE transmits an EXTENDED SERVICE REQUEST message with Service Type IE set to "mobile originating CS fallback or 1xCS fallback" }
}
```

(2)

```
with { UE having transmitted an ULInformationTransfer message containing an EXTENDED SERVICE REQUEST message with Service Type IE set to "mobile originating CS fallback or 1xCS fallback" }
ensure that {
  when { SS transmits a RRCConnectionRelease message with redirection to 1xRTT }
  then { UE tunes to 1xRTT cell and transmits a 1xRTT Origination message on 1xRTT cell }
}
```

8.4.7.4.2 Conformance requirements

References: The conformance requirements covered in the present TC are specified in: TS 23.272, clause B.2.2.

[TS 23.272, clause B.2.2]

This clause describes the mobile originating call procedures for the CS Fallback to 1xRTT.

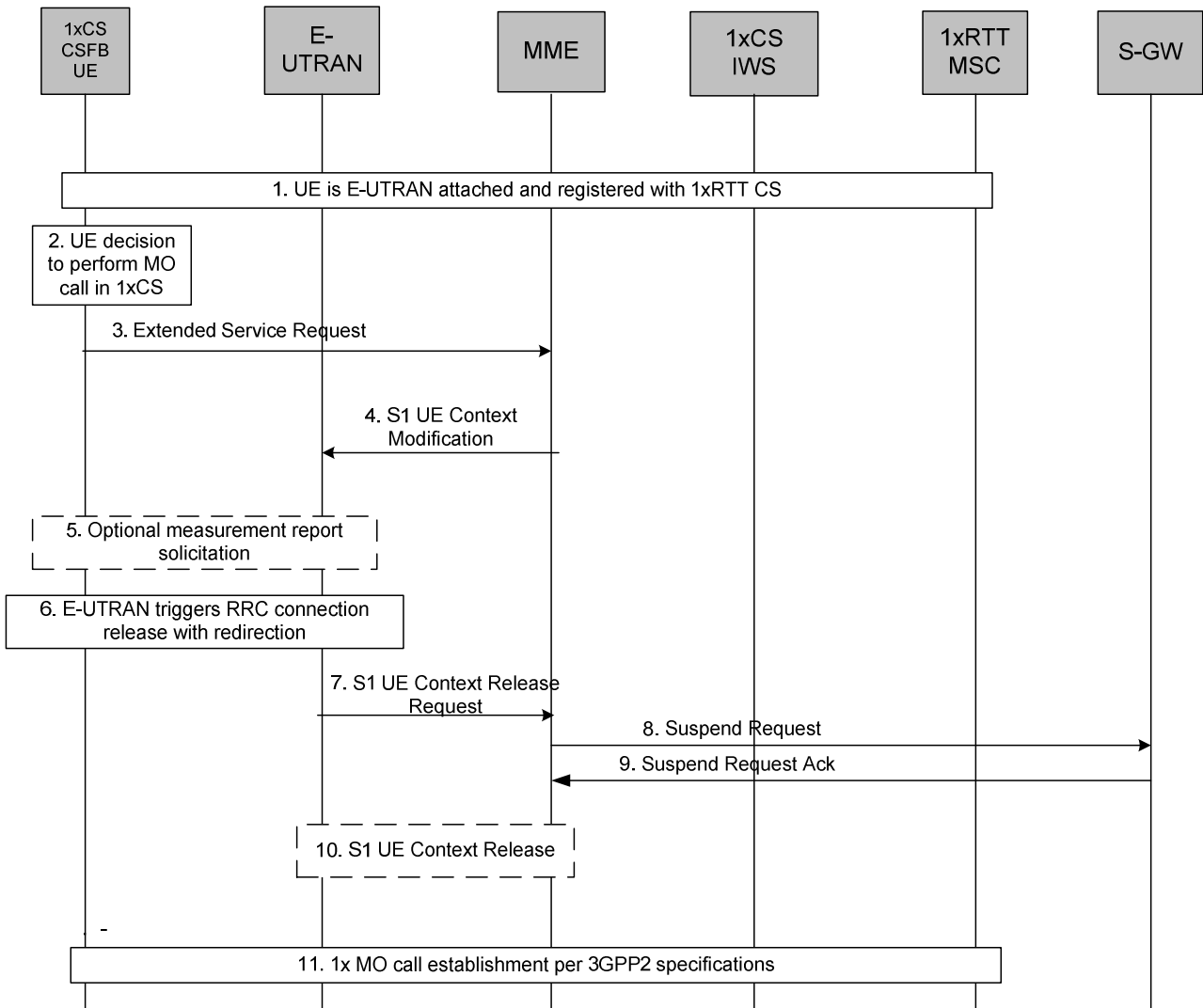

Figure B.2.2-1: CS MO call using fallback to CDMA 1x RTT network

1. UE is E-UTRAN attached and registered with 1xRTT CS as defined in clause B.2.1.1.
2. UE makes a decision to perform a mobile originated CS call.
3. UE sends an Extended Service Request (CS Fallback Indicator) to the MME.
4. MME sends S1-AP: UE Context Modification (UE capabilities, CS Fallback Indicator) to indicate the E-UTRAN to move the UE to 1xRTT.
5. E-UTRAN may optionally solicit a measurement report from the UE to determine the target 1xRTT cell to which the CS Fallback will be performed.

6. E-UTRAN triggers RRC connection release with redirection to 1xCS.
7. E-UTRAN sends an S1 UE Context Release Request (Cause) message to the MME. Cause indicates that the S1 UE Context Release was caused by CS fallback to 1xRTT.
8. MME sets the UE context to suspended status and sends to the S-GW a Suspend Request (IMSI) message that requests the suspension of EPS bearers for the UE. The S1-U bearers are released for all EPS bearers by the MME and all GBR bearers are deactivated. The non-GBR bearers are preserved and are marked as suspended in the S-GW.
9. S-GW acknowledges the Suspend Request message and marks the UE as suspended. When a downlink data arrives at the S-GW, the S-GW should not send a downlink data notification message to the MME if the UE is marked as suspended.
10. S1 UE Context in the E-UTRAN is released as specified in TS 23.401 [2].
11. UE moves to 1xRTT and performs the procedure for mobile originating call as specified in 3GPP2 A.S0013-D v4.0 [18].

8.4.7.4.3 Test description

8.4.7.4.3.1 Pre-test conditions

System Simulator:

- Cell 1 and Cell 19.
- Cell 19 has a lower reselection priority than Cell 1.
- System information combination 6 as defined in TS 36.508 [18] clause 4.4.3.1 is used in E-UTRA cells.

UE:

None.

Preamble:

- The UE is in state Generic RB Established, pre-registered on 1xRTT (state 3C) on Cell 1 according to [18].
-

8.4.7.4.3.2 Test procedure sequence

Table 8.4.7.4.3.2-1 illustrates the downlink power levels and other changing parameters to be applied for the cells at various time instants of the test execution. Row marked "T0" denotes the initial conditions, while row marked "T1" is to be applied subsequently. The exact instants on which these values shall be applied are described in the texts in this clause.

Table 8.4.7.4.3.2-1: Cell configuration changes over time

	Parameter	Unit	Cell 1	Cell 19	Remark
T0	Cell-specific RS EPRE	dBm/15kHz	-60	-	Srxlev _{Cell 1} > 0 and Cell 19 is off such that camping on Cell 1 is guaranteed.
	I _{or} /I _{oc}	dB	-	-	
	Pilot Ec/I _{or}	dB	-	-	
	I _{oc}	dBm/1.23 MHz	-	-	
	Pilot Ec/I _o (Note 1)	dB	-	-	
T1	Cell-specific RS EPRE	dBm/15kHz	-60	-	Cell 19 in on, with S _{ServingCell} > Thresh _{serv, low} and S _{nonServingCell, x} < Thresh _{x, low} .
	I _{or} /I _{oc}	dB	-	0	
	Pilot Ec/I _{or}	dB	-	-7	
	I _{oc}	dBm/1.23 MHz	-	-75	
	Pilot Ec/I _o (Note 1)	dB	-	-10	
Note 1: This parameter is not directly settable, but is derived by calculation from the other parameters set by the SS.					

Table 8.4.7.4.3.2-2: Main behaviour

St	Procedure	Message Sequence		TP	Verdict
		U - S	Message		
1	A voice call is originated at the UE	-	-	-	-
2	Check: Does the UE transmit an <i>ULInformationTransfer</i> containing an EXTENDED SERVICE REQUEST with Service Type IE set to "mobile originating CS fallback or 1xCS fallback" on Cell 1?	-->	<i>ULInformationTransfer</i>	1	P
3	The SS changes the cell power levels according to "T1" in Table 8.4.7.3.3.2-1 and waits for 2 seconds.	-	-	-	-
4	The SS transmits an <i>RRCConnectionRelease</i> message on Cell 1 redirecting the UE to Cell 19.	<--	<i>RRCConnectionRelease</i>	-	-
5	The UE tunes to 1xRTT radio.	-	-	-	-
6	Check: Does the UE transmit an <i>Origination</i> message on Cell 19?	-->	<i>Origination</i>	2	P
7	The SS transmits an <i>Extended Channel Assignment</i> message on Cell 19.	<--	<i>Extended Channel Assignment</i>	-	-
8	After the SS detects that Traffic Channel Initialization is successful, it transmits an <i>Acknowledgement Order</i> message on Cell 19.	<--	<i>Acknowledgement Order</i>	-	-
9	The SS transmits a <i>Service Connect</i> message on Cell 19.	<--	<i>Service Connect</i>	-	-
10	The UE transmits a <i>Service Connect Completion</i> message on Cell 19.	-->	<i>Service Connect Completion</i>	-	-

8.4.7.4.3.3

Specific message contents

Table 8.4.7.4.3.3-1: Void**Table 8.4.7.4.3.3-2: Void**

Table 8.4.7.4.3.3-3: ULInformationTransfer (step 2, Table 8.4.7.4.3.2-2)

Derivation Path: 36.508 Table 4.6.1-25			
Information Element	Value/remark	Comment	Condition
ULInformationTransfer ::= SEQUENCE {			
criticalExtensions CHOICE {			
c1 CHOICE {			
ulInformationTransfer-r8 SEQUENCE {			
dedicatedInfoType CHOICE {			
dedicatedInfoNAS	Set according to Table 8.4.7.4.3.3-4	EXTENDED SERVICE REQUEST	
}			
}			
}			
}			
}			

Table 8.4.7.4.3.3-4: EXTENDED SERVICE REQUEST (step 2, Table 8.4.7.4.3.2-2)

Derivation Path: 36.508 Table 4.7.2-14A			
Information Element	Value/remark	Comment	Condition
Protocol discriminator	EMM		
Service type	'0000'B	mobile originating CS fallback or 1xCS fallback	
CSFB response	Not present		

Table 8.4.7.4.3.3-5: RRCConnectionRelease (step 4, Table 8.4.7.4.3.2-2)

Derivation Path: 36.508 table 4.6.1-15			
Information Element	Value/remark	Comment	Condition
RRCConnectionRelease ::= SEQUENCE {			
criticalExtensions CHOICE {			
c1 CHOICE {			
rrcConnectionRelease-r8 SEQUENCE {			
redirectedCarrierInfo ::= CHOICE {			
cdma2000-1xRTT	cdma2000-CarrierInfo for Cell 19		
}			
}			
}			
}			
}			

Table 8.4.7.4.3.3-6: *Origination* (step 6, Table 8.4.7.4.3.2-2)

Field PD	Value/remark '00'B	Comment	Condition
MSG_ID	'000100'B	Origination Message	this value shall be verified by TTCN
LAC Length Field	5 bits, Set by UE		
ACK_SEQ	3 bits, Set by UE		
MSG_SEQ	3 bits, Set by UE		
ACK_REQ	'1'B		
VALID_ACK	'0'B		
ACK_TYPE	'010'B		
MSID_TYPE	3 bits, Set by UE		
MSID_LEN	4 bits, Set by UE		
MSID	Variable, Set by UE		
LAC Padding Field	0 to 7, Set by UE		
ACTIVE_PILOT_STRENGTH	6 bits, set by UE		
FIRST_IS_ACTIVE	1 bit, set by UE		
FIRST_IS_PTA	1 bit, set by UE		
NUM_ADD_PILOTS	'0'B		
MOB_TERM	'1'B		
SLOT_CYCLE_INDEX	'010'B		
MOB_P_REV	8 bits, Set by UE		
SCM	8 bits, Set by UE		
REQUEST_MODE	'001'B		
SPECIAL_SERVICE	'1'B		
SERVICE_OPTION	16 bits, Any value mapping to a voice service option		
PM	'0'B		
DIGIT_MODE	'0'B		
NUMBER_TYPE	3 bits, Set by UE		
NUMBER_PLAN	4 bits, Set by UE		
MORE_FIELDS	'0'B		
NUM_FIELDS	8 bits, Set by UE		
CHARi	Variable, Set by UE		
NAR_AN_CAP	'0'B		
PACA_REORIG	'0'B		
RETURN_CAUSE	'0000'B		
MORE_RECORDS	'0'B		
ENCRYPTION_SUPPORTED	'0000'B		
PACA_SUPPORTED	'0'B		
NUM_ALT_SO	'000'B		
DRS	'1'B		
UZID_INCL	'0'B		
CH_IND	'01'B		
SR_ID	3 bits, Set by UE		
OTD_SUPPORTED	'1'B		
QPCH_SUPPORTED	'1'B		
ENHANCED_RC	'1'B		
FOR_RC_PREF	'00011'B		
REV_RC_PREF	'00011'B		
FCH_SUPPORTED	'1'B		
FCH_FRAME_SIZE	'0'B		
FOR_FCH_LEN	3 bits, Set by UE		
FOR_FCH_RC_MAP	Variable, Set by UE		
REV_FCH_LEN	3 bits, Set by UE		
REV_FCH_RC_MAP	Variable, Set by UE		
DCCH_SUPPORTED	'1'B		
RESERVED	'0'B		
REV_FCH_GATING_REQ	'0'B		

Table 8.4.7.4.3.3-7: Extended Channel Assignment (step 7, Table 8.4.7.4.3.2-2)

Field	Value/remark	Comment	Condition
MSG_TYPE	'010101'B	Extended Channel Assignment Message	
ACK_SEQ	3 bits, Set by UE		
MSG_SEQ	3 bits, Set by UE		
ACK_REQ	'0'B		
VALID_ACK	'1'B		
ADDR_TYPE	3 bits, Set by UE		
ADDR_LEN	4 bits, Set by UE		
ADDRESS	Variable, Set by UE		
RESERVED_1	'0'B		
ADD_RECORD_LEN	8 bits, Set by UE		
ASSIGN_MODE	'100'B	Traffic Channel Assignment	
RESERVED_2	'00000'B		
BAND_CLASS	5 bits, Set by SS		
CDMA_FREQ	11 bits, Set by SS		
BYPASS_ALERT_ANSWER	'1'B		
GRANTED_MODE	'10'B		
DEFAULT_CONFIG	'100'B		
FOR_RC	'00011'B		
REV_RC	'00011'B		
FRAME_OFFSET	4 bits, Set by SS		
ENCRYPT_MODE	'00'B		
FPC_SUBCHAN_GAIN	'00001'B		
RLGAIN_ADJ	0000'B		
NUM_PILOTS	'000'B		
CH_IND	'01'B		
CH_RECORD_LEN	5 bits, Set by SS		
CH_RECORD_FIELDS	Variable, Set by SS		
REV_FCH_GATING_MODE	'0'B		
RESERVED	0 – 7 bits, Set by UE		
PDU_PADDING	0 – 7 bits, Set by UE		

Table 8.4.7.4.3.3-8: Acknowledgment Order (step 8, Table 8.4.7.4.3.2-2)

Field	Value/remark	Comment	Condition
MSG_TYPE	'00000001'B	Order Message	
ACK_SEQ	3 bits, Set by SS		
MSG_SEQ	3 bits, Set by SS		
ACK_REQ	'1'B		
ENCRYPTION	'00'B		
ORDER	'010000'B	Base Station Acknowledgment Order	
ORDQ	'00000000'B		

Table 8.4.7.4.3.3-9: Service Connect (step 9, Table 8.4.7.4.3.2-2)

Field	Value/remark	Comment	Condition
MSG_TYPE	'00010100'B	Service Connect Message	
ACK_SEQ	3 bits, Set by SS		
MSG_SEQ	3 bits, Set by SS		
ACK_REQ	'1'B		
ENCRYPTION	'00'B		
USE_TIME	'0'B		
ACTION_TIME	'000000'B		
SERV_CON_SEQ	Set by SS		
RESERVED	'00000'B		
RECORD_TYPE	'00000111'B		
RECORD_LEN	8 bits, Set by SS		
Type-specific fields	Variable, Set by SS		
RECORD_TYPE	'00010011'B		
RECORD_LEN	8 bits, Set by SS		
Type-specific fields	Variable, Set by SS		
PDU_PADDING	0-7 bits, Set by SS		

Table 8.4.7.4.3.3-10: Service Connect Completion (step 10, Table 8.4.7.4.3.2-2)

Information Element	Value/remark	Comment	Condition
MSG_TYPE	'00001110'B	Service Connect Completion Message	this value shall be verified by TTCN
ACK_SEQ	3 bits, Set by UE		
MSG_SEQ	3 bits, Set by UE		
ACK_REQ	'1'B		
ENCRYPTION	'00'B		
RESERVED	'0'B		
SERV_CON_SEQ	Same value as SERV_CON_SEQ received in Service Connect Message (Table 8.4.7.4.3.3-9)		
PDU_PADDING	0-7 bits, Set by UE		

8.4.7.5 Pre-registration at 1xRTT and inter-RAT Handover / Enhanced CS fallback from E-UTRA RRC_IDLE to 1xRTT/MT call

8.4.7.5.1 Test Purpose (TP)

(1)

```
with { UE in E-UTRA RRC_IDLE state having completed the 1xRTT CS pre-registration procedure and
having received a DLInformationTransfer message containing a 1xRTT GCSNA Encapsulated Paging message }
ensure that {
  when { CS paging for the CS Fallback to 1xRTT is accepted at the UE }
  then { UE transmits an ULInformationTransfer message containing an EXTENDED SERVICE REQUEST
message with Service Type IE set to "mobile terminating CS fallback or 1xCS fallback" }
}
```

(2)

```
with { UE having transmitted an ULInformationTransfer message containing an EXTENDED SERVICE REQUEST
message with Service Type IE set to "mobile terminating CS fallback or 1xCS fallback" in response to
a 1xRTT CS Paging message }
ensure that {
  when { SS transmits HandoverFromEUTRAPreparationRequest message with cdma2000-type set to
'1xRTT' }
  then { UE transmits an ULHandoverPreparationTransfer message containing a tunnelled 1xRTT GCSNA
Encapsulated Page Response message }
}
```

(3)

```

with { UE in E-UTRA RRC_CONNECTED state }
ensure that {
  when { UE receives a MobilityFromEUTRACommand message containing a tunnelled 1xRTT GCSNA Encapsulated Handoff Direction message }
  then { UE transmits a 1xRTT Handoff Completion message on the target 1xRTT cell }
}
    
```

8.4.7.5.2 Conformance requirements

References: The conformance requirements covered in the present TC are specified in: TS 23.272, clause B.2.3a.4.

[TS 23.272, clause B.2.3a.4]

The following figure describes the mobile terminating call procedures for the enhanced CS Fallback to 1xRTT with concurrent non-optimised PS handover or optimised idle-mode PS handover, or without PS handover, in the normal case. Clause B.2.3b describes the procedure when the procedure is rejected by the MME.

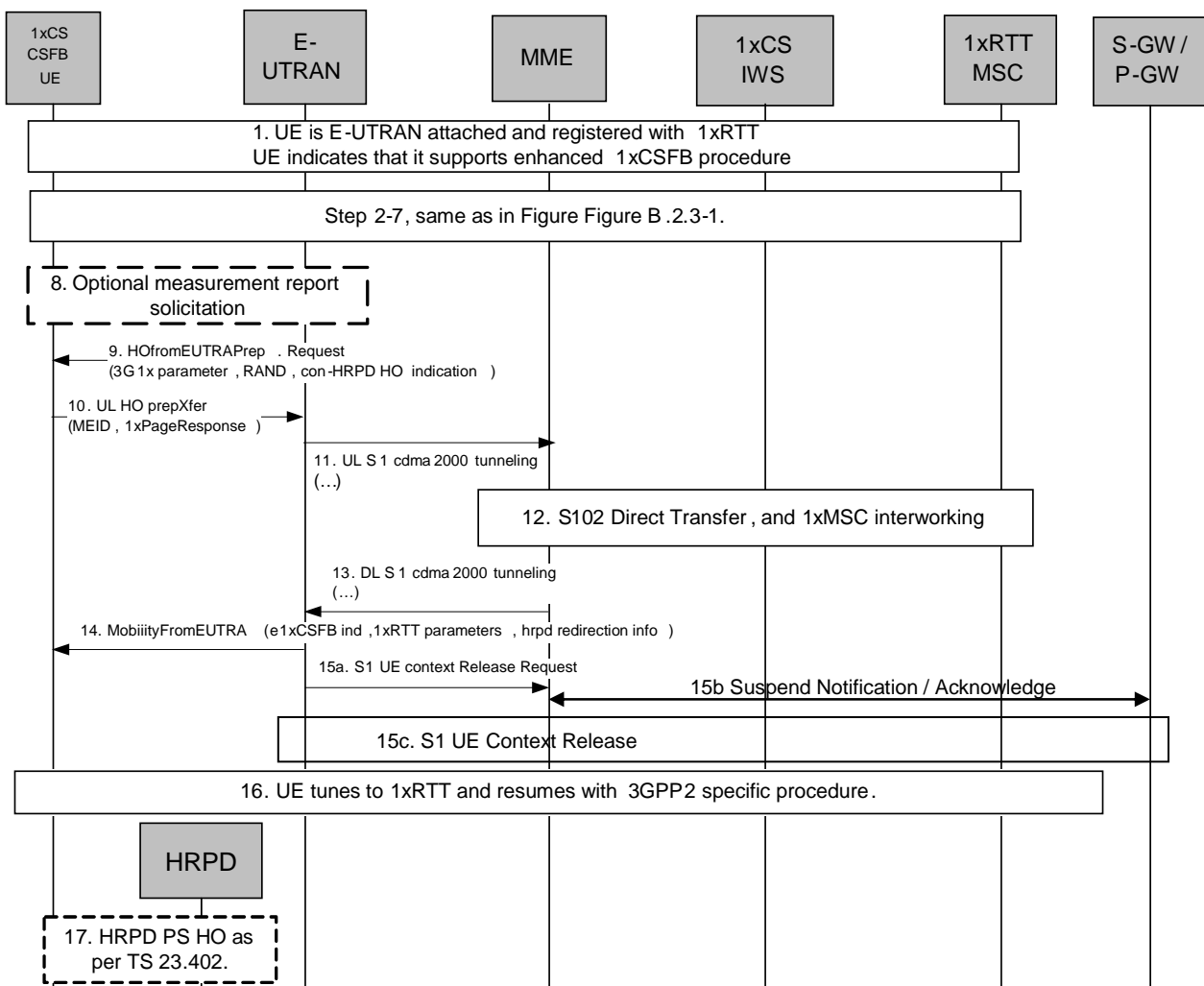

Figure B.2.3a.4-1: Enhanced CS fallback to 1xRTT MT call without PS handover, or with concurrent non-optimised PS handover or optimised idle-mode PS handover

1. UE is E-UTRAN attached and pre-registered with 1xRTT CS as defined in clause B.2.1.1 with enhanced CS fallback to 1xRTT capability indication to the network. The UE may also indicate that it supports concurrent 1xRTT and HRPD capability. The UE may also be pre-registered with HRPD access using procedures defined in TS 23.402 [27], clause 9.3.1.

2-7. Same as step 2-7 in figure B.2.3-1.

8-17. Same as steps 5 – 12 of Figure B.2.3a.2-1, with the modification that the 1x message in step 7 of Figure B.2.3a.2-1 provided by the UE to the E-UTRAN is a 1xPage Response message and 1x messages in step 9a of Figure B.2.3.a.2-1 (step 14a of Figure B.2.3a.4-1) provided by the E-UTRAN to UE may also contain Alert With Information message to provide caller line Identification and alerting trigger with 1x channel assignment message.

8.4.7.5.3 Test description

8.4.7.5.3.1 Pre-test conditions

System Simulator:

- Cell 1 and Cell 19.
- Cell 19 has a lower reselection priority than Cell 1.
- System information combination 6 as defined in TS 36.508 [18] clause 4.4.3.1 is used in E-UTRA cells.

UE:

None.

Preamble:

- The UE is in state Registered, Idle mode pre-registered on 1xRTT (state 2C) on Cell 1 according to [18].
-

8.4.7.5.3.2 Test procedure sequence

Table 8.4.7.5.3.2-1 illustrates the downlink power levels and other changing parameters to be applied for the cells at various time instants of the test execution. Row marked "T0" denotes the initial conditions, while row marked "T1" is to be applied subsequently. The exact instants on which these values shall be applied are described in the texts in this clause.

Table 8.4.7.5.3.2-1: Cell configuration changes over time

	Parameter	Unit	Cell 1	Cell 19	Remark
T0	Cell-specific RS EPRE	dBm/15kHz	-60	-	Srxlev _{Cell 1} > 0 and Cell 19 is off such that camping on Cell 1 is guaranteed.
	Ior/loc	dB	-	-	
	Pilot Ec/Ior	dB	-	-	
	loc	dBm/1.23 MHz	-	-	
	Pilot Ec/Io (Note 1)	dB	-	-	
T1	Cell-specific RS EPRE	dBm/15kHz	-60	-	Cell 19 in on, with S _{ServingCell} > Thresh _{serv, low} and S _{nonServingCell, x} < Thresh _{x, low} .
	Ior/loc	dB	-	0	
	Pilot Ec/Ior	dB	-	-7	
	loc	dBm/1.23 MHz	-	-75	
	Pilot Ec/Io (Note 1)	dB	-	-10	
Note 1: This parameter is not directly settable, but is derived by calculation from the other parameters set by the SS.					

Table 8.4.7.5.3.2-2: Main behaviour

St	Procedure	Message Sequence		TP	Verdict
		U - S	Message		
1-8	Steps 2 to 9 of the generic radio bearer establishment procedure (TS 36.508 4.5.3.3-1) are executed to successfully complete the service request procedure.				
9	The SS changes the cell power levels according to "T1" in Table 8.4.7.5.3.2-1.				
10	The SS transmits a <i>DLInformationTransfer</i> containing a <i>1x RTT GCSNA Encapsulated General Page</i> message on Cell 1.	<--	<i>DLInformationTransfer</i>	-	-
11	The CS paging for the CS Fallback to 1xRTT is accepted at the UE.	-	-	-	-
12	Check: Does the UE transmit an <i>ULInformationTransfer</i> containing an EXTENDED SERVICE REQUEST with Service Type IE set to "mobile terminating CS fallback or 1xCS fallback" on Cell 1?	-->	<i>ULInformationTransfer</i>	1	P
13	The SS transmits an <i>RRCCConnectionReconfiguration</i> message on Cell 1 to setup inter RAT measurement on Cell 19.	<--	<i>RRCCConnectionReconfiguration</i>		
14	The UE transmits an <i>RRCCConnectionReconfigurationComplete</i> message on Cell 1 to confirm the setup of inter RAT measurement.	-->	<i>RRCCConnectionReconfigurationComplete</i>		
15	The UE transmits a <i>MeasurementReport</i> message on Cell 1 to report event B2 for Cell 19.	-->	<i>MeasurementReport</i>		
16	The SS transmits a <i>HandoverFromEUTRAPreparationRequest</i> on Cell 1.	<--	<i>HandoverFromEUTRAPreparationRequest</i>		
17	Check: Does the UE transmit a tunnelled <i>1xRTT GCSNA Encapsulated Page Response</i> message contained in an <i>ULHandoverPreparationTransfer</i> message on Cell 1?	-->	<i>ULHandoverPreparationTransfer</i>	2	P
18	The SS transmits a tunnelled <i>1xRTT GCSNA Encapsulated Handoff Direction</i> message contained in a <i>MobilityFromEUTRACommand</i> on Cell1 to order the UE to perform inter RAT handover to Cell 19.	<--	<i>MobilityFromEUTRACommand</i>		
19	The UE tunes to 1xRTT radio.				
20	Check: Does the UE transmit a <i>1xRTT Handoff Completion</i> message on Cell 19?	-->	<i>Handoff Completion</i>	3	P
21	The SS transmits an <i>Alert With Information</i> message.	<--	<i>Alert With Information</i>		
22	The UE transmits a <i>Connect Order</i> .	-->	<i>Connect Order</i>		

8.4.7.5.3.3 Specific message contents

Table 8.4.7.5.3.3-1: DLInformationTransfer (Step 10, Table 8.4.7.5.3.2-2)

Derivation Path: 36.508 Table 4.6.1-3			
Information Element	Value/remark	Comment	Condition
DLInformationTransfer ::= SEQUENCE {			
criticalExtensions CHOICE {			
c1 CHOICE {			
dlInformationTransfer-r8 SEQUENCE {			
dedicatedInfoType CHOICE {			
dedicatedInfoCDMA2000-1XRTT	Set according to Table 8.4.7.5.3.3-2		
}			
}			
}			
}			
}			

Table 8.4.7.5.3.3-2: 1xRTT GCSNA Encapsulated General Page (Step 10, Table 8.4.7.5.3.2-2)

Field	Value/remark	Comment	Condition
MessageID	'00000001'B	GCSNA1xCircuitService message	
GCSNAOption	'00000001'B		
AlternativeGCSNAOption_INCL	'0'B		
IWSIDIncl	'0'B		
AckRequired	'0'B		
StopDupDetect	'0'B		
MessageSequence	Set by SS		
NumTLACEncapsulated1xL3PDU	'00'B		
Reserved	'0000'B		
1xLogicalChannel	'0'B		
1xProtocolRevision	Set by UE		
MsgType	'00010001'B	General Page Message	
NumTLACHeaderRecords	'0000'B		
Reserved	'000'B		
1xL3PDULength	16 bits, Set by SS		
PDU		1x L3 PDU	
Service_Option	16 bits, Set by SS		

Table 8.4.7.5.3.3-3: ULInformationTransfer (Step 12, Table 8.4.7.5.3.2-2)

Derivation Path: 36.508 Table 4.6.1-25			
Information Element	Value/remark	Comment	Condition
ULInformationTransfer ::= SEQUENCE {			
criticalExtensions CHOICE {			
c1 CHOICE {			
ulInformationTransfer-r8 SEQUENCE {			
dedicatedInfoType CHOICE {			
dedicatedInfoNAS	Set according to Table 8.4.7.5.3.3-4	EXTENDED SERVICE REQUEST	
}			
}			
}			
}			
}			

Table 8.4.7.5.3.3-4: EXTENDED SERVICE REQUEST (Step 12, Table 8.4.7.5.3.2-2)

Derivation Path: 36.508 Table 4.7.2-14A			
Information Element	Value/remark	Comment	Condition
Protocol discriminator	EMM		
Service type	'0001'B	mobile terminating CS fallback or 1xCS fallback	
CSFB response	'001'B	CS fallback accepted by the UE	

Table 8.4.7.5.3.3-5: RRCConnectionReconfiguration (Step 13, Table 8.4.7.5.3.2-2)

Derivation Path: 36.508, Table 4.6.1-8, condition MEAS
--

Table 8.4.7.5.3.3-6: MeasConfig (Step 13, Table 8.4.7.5.3.2-2)

Derivation Path: 36.508, Table 4.6.6-1			
Information Element	Value/remark	Comment	Condition
MeasConfig ::= SEQUENCE {			
measObjectToAddModList SEQUENCE (SIZE (1..maxObjectId)) OF SEQUENCE {	2 entries		
measObjectId[1]	IdMeasObject-f17		
measObject[1]	MeasObjectCDMA2000- GENERIC		
measObjectId[2]	IdMeasObject-f1		
measObject[2]	MeasObjectEUTRA- GENERIC(f1)		
}			
reportConfigToAddModList SEQUENCE (SIZE (1..maxReportConfigId)) OF SEQUENCE {	1 entry		
reportConfigId[1]	IdReportConfig-B2- CDMA2000		
reportConfig[1]	ReportConfigInterRAT- B2-CDMA2000(-69, -18)		
}			
measIdToAddModList SEQUENCE (SIZE (1..maxMeasId)) OF SEQUENCE {	1 entry		
measId[1]	1		
measObjectId[1]	IdMeasObject-f17		
reportConfigId[1]	IdReportConfig-B2- CDMA2000		
}			
quantityConfig SEQUENCE {			
quantityConfigEUTRA	Not present		
quantityConfigUTRA	Not present		
quantityConfigGERAN	Not present		
quantityConfigCDMA2000 SEQUENCE {			
measQuantityCDMA2000	pilotPnPhaseAndPilotStre ngth		
}			
}			
measGapConfig CHOICE {			
setup SEQUENCE {			
gapOffset CHOICE {			
gp1	30		
}			
}			
}			
}			
}			
}			

Table 8.4.7.5.3.3-9: HandoverFromEUTRAPreparationRequest (Step 16, Table 8.4.7.5.3.2-2)

Derivation Path: 36.508 Table 4.6.1-4			
Information Element	Value/remark	Comment	Condition
HandoverFromEUTRAPreparationRequest ::= SEQUENCE {			
criticalExtensions CHOICE {			
c1 CHOICE {			
handoverFromEUTRAPreparationRequest-r8 SEQUENCE {			
cdma2000-Type	Type1XRTT		
Rand	Set by SS	Random Challenge Data as broadcast on Cell 19	
mobilityParameters	Set according to 36.508 Table 4.5.2C.4-6	CDMA2000Parameters	
}			
}			
}			
}			

Table 8.4.7.5.3.3-10: ULHandoverPreparationTransfer (Step 17, Table 8.4.7.5.3.2-2)

Derivation Path: 36.508 Table 4.6.1-24			
Information Element	Value/remark	Comment	Condition
ULHandoverPreparationTransfer ::= SEQUENCE {			
criticalExtensions CHOICE {			
c1 CHOICE {			
ulHandoverPreparationTransfer-r8 SEQUENCE {			
cdma2000-Type	Type1XRTT		
Meid	UE's meid		
dedicatedInfo	Set according to Table 8.4.7.5.3.3-11	1xRTT GCSNA Encapsulated Page Response message	
}			
}			
}			
}			

Table 8.4.7.5.3.3-11: 1xRTT GCSNA Encapsulated Page Response (Step 17, Table 8.4.7.5.3.2-2)

Information Element	Value/remark	Comment	Condition
MessageID	'00000001'B	GCSNA1xCircuitService message	
GCSNAOption	'00000001'B		
AlternativeGCSNAOption_INCL	'0'B		
IWSIDIncl	'0'B		
AckRequired	'0'B		
StopDupDetect	'0'B		
MessageSequence	6 bits, Set by UE		
NumTLACEncapsulated1xL3PDU	'00'B		
Reserved	'0000'B		
1xLogicalChannel	'0'B		
1xProtocolRevision	'00000110'B		
MsgType	'00000101'B	Page Response message	this value shall be verified by TTCN
NumTLACHeaderRecords	'0001'B		
TLACHeaderRecordType	'0000'B		
TLACHeaderRecordLength	8 bits, Set by UE		
MSID_TYPE	3 bits, Set by UE	Should be matched with PREF_MSID_TYPE	
MSID_LEN	4 bits, Set by UE		
MSID	Variable, Set by UE		
Reserved	'0000000'B		
1xL3PDULength	16 bits, Set by UE		
MOB_TERM	'1'B		
SLOT_CYCLE_INDEX	'010'B		
MOB_P_REV	8 bits, Set by UE		
SCM	8 bits, Set by UE		
REQUEST_MODE	'001'B		
SERVICE_OPTION	16 bits, Set by UE		
PM	'0'B		
NAR_AN_CAP	'0'B		
ENCRYPTION_SUPPORTED	'0000'B		
NUM_ALT_SO	'000'B		
UZID_INCL	'0'B		
CH_IND	'0'B		
OTD_SUPPORTED	'0000'B		
QPCH_SUPPORTED	'0'B		
ENHANCED_RC	'0'B		
FOR_RC_PREF	'0000'B		
REV_RC_PREF	'0'B		
FCH_SUPPORTED	'0'B		
FCH Capability Type-specific fields	Variable		
DCCH_SUPPORTED	'1'B		
REV_FCH_GATING_REQ	'0'B		

Table 8.4.7.5.3.3-12: *MobilityFromEUTRACommand* (Step 18, Table 8.4.7.5.3.2-2)

Derivation Path: 36.508, Table 4.6.1-6			
Information Element	Value/remark	Comment	Condition
MobilityFromEUTRACommand ::= SEQUENCE {			
criticalExtensions CHOICE {			
c1 CHOICE{			
mobilityFromEUTRACommand-r9 SEQUENCE {			
csFallbackIndicator	False		
purpose CHOICE{			
e-CSFB-r9 SEQUENCE {			
messageContCDMA2000-1XRTT-r9	Set according to Table 8.4.7.5.3.3-13	1xRTT GCSNA Encapsulated Handoff Direction message	
}			
}			
}			
}			
}			

Table 8.4.7.5.3.3-13: 1xRTT GCSNA Encapsulated Handoff Direction (Step 18, Table 8.4.7.5.3.2-2)

Information Element	Value/remark	Comment	Condition
MessageID	'0000001'B		
GCSNAOption	'0000001'B		
AlternativeGCSNAOption_INCL	'0'B		
IWSIDIncl	'0'B		
AckRequired	'0'B		
StopDupDetect	'0'B		
MessageSequence	Set by SS		
NumTLACEncapsulated1xL3PDU	'00'B		
Reserved	'0000'B		
1xLogicalChannel	'1'B		
1xProtocolRevision	'0000110'B		
MsgType	'00100010'B	Universal Handoff Direction message	
NumTLACHeaderRecords	'0000'B		
Reserved	'000'B		
1xL3PDULength	16 bits, Set by SS		
USE_TIME	'0'B		
ACTION_TIME	'000000'B		
HDM_SEQ	2 bits, Set by SS		
PARMS_INCL	'1'B		
P_REV	'00000110'B		
SERV_NEG_TYPE	'1'B		
SEARCH_INCLUDED	'1'B		
SRCH_WIN_A	'1000'B		
SRCH_WIN_N	'1001'B		
SRCH_WIN_R	'1011'B		
T_ADD	'010100'B		
T_DROP	'011110'B		
T_COMP	'1010'B		
T_TDROP	'0100'B		
SOFT_SLOPE	'000000'B		
ADD_INTERCEPT	'000000'B		
DROP_INTERCEPT	'000000'B		
EXTRA_PARMS	'1'B		
PACKET_ZONE_ID	'00000000'B		
FRAME_OFFSET	4 bits, Set by SS		
PRIVATE_LCM	'0'B		
RESET_L2	'1'B		
RESET_FPC	'1'B		
ENCRYPT_MODE	'00'B		
NOM_PWR_EXT	'0'B		
NOM_PWR	'0000'B		
RLGAIN_TRAFFIC_PILOT	'000000'B		
DEFAULT_RLAG	'1'B		
NUM_PREAMBLE	'000'B		
BAND_CLASS	5 bits, Set by SS		
CDMA_FREQ	11 bits, Set by SS		
RETURN_IF_HANDOFF_FAIL	'0'B		
PERIODIC_SEARCH	'0'B		
SCR_INCLUDED	'1'B		
NNSCR_INCLUDED	'1'B		
USE_PWR_CNTL_STEP	'0'B		
CLEAR_RETRY_DELAY	'0'B		
SCH_INCL	'1'B		
FPC_SUBCHAN_GAIN	'01010'B		
USE_PC_TIME	'0'B		
CH_IND	'101'B		
ACTIVE_SET_REC_LEN	8 bits, Set by SS		
NUM_PILOTS	'001'B		
SRCH_OFFSET_INCL	'1'B		
PILOT_PN	'000000000'B		
SRCH_OFFSET	'010'B		

ADD_PILOT_REC_INCL	'0'B		
PWR_COMB_IND	'0'B		
CODE_CHAN_FCH	11 bits, Set by SS		
QOF_MASK_ID_FCH	'00'B		
RESERVED	0-7 bits		
REV_FCH_GATING_MODE	'0'B		

Table 8.4.7.5.3.3-14: 1xRTT Handoff Completion (Step 20, Table 8.4.7.5.3.2-2)

Information Element	Value/remark	Comment	Condition
MSG_ID	'00001010'	LAC	this value shall be verified by TTCN
ACK_SEQ	3 bits, Set by SS		
MSG_SEQ	3 bits, set by UE		
ACK_REQ	'1'B		
ENCRYPTION	'00'B		
RESERVED	'0'B		
LAST_HDM_SEQ	Same value as HDM_SEQ in 1xRTT Handoff Direction message at Step 9	1xRTT L3 PDU	
PILOT_PN	Same value as PILOT_PN included in 1xRTT Handoff Direction message at Step 9		
PDU_PADDING	0 -7 bits, set by UE		

Table 8.4.7.5.3.3-15: 1xRTT Alert With Information (Step 21, Table 8.4.7.5.3.2-2)

Information Element	Value/remark	Comment	Condition
MSG_ID	'00000011'B	LAC	
ACK_SEQ	FFS		
MSG_SEQ	3 bits, set by UE		
ACK_REQ	'1'B		
ENCRYPTION	'00'B		
RECORD_TYPE	'00000011'	1xRTT L3 PDU	
RECORD_LEN	8bits, Set by SS		
NUMBER_TYPE	3bits, Set by SS		
NUMBER_PLAN	4bits, Set by SS		
CHARi	Variable, set by SS		
RESERVED	'0'B		
PDU_PADDING	0 -7 bits, set by UE		

Table 8.4.7.5.3.3-16: 1xRTT Connect Order (Step 22, Table 8.4.7.5.3.2-2)

Information Element	Value/remark	Comment	Condition
MSG_ID	'00000001'B	LAC	this value shall be verified by TTCN
ACK_SEQ	3 bits, Set by SS		
MSG_SEQ	3 bits, set by UE		
ENCRYPTION	'00'B		
RESERVED	'0'B		
ORDER	'011000'B	1xRTT L3 PDU	
ADD_RECORD_LEN	'001'B		
ORDQ	'00000000'B		
PDU_PADDING	0 -7 bits, set by UE		

8.4.7.6 Pre-registration at 1xRTT and inter-RAT handover / Enhanced CS fallback from E-UTRA RRC_CONNECTED to 1xRTT/MO call

8.4.7.6.1 Test Purpose (TP)

(1)

```
with { UE in E-UTRA RRC_CONNECTED state and having completed the 1xRTT CS pre-registration procedure }
ensure that {
  when { a voice call is originated at the UE }
  then { UE transmits an EXTENDED SERVICE REQUEST message with Service Type IE set to "mobile originating CS fallback or 1xCS fallback" }
}
```

(2)

```
with { UE having transmitted an ULInformationTransfer message containing an EXTENDED SERVICE REQUEST message with Service Type IE set to "mobile originating CS fallback or 1xCS fallback" }
ensure that {
  when { SS transmits HandoverFromEUTRAPreparationRequest message with cdma2000-type set to 'type1XRTT' }
  then { UE transmits an ULHandoverPreparationTransfer message containing a tunnelled 1xRTT GCSNA Encapsulated Origination message }
}
```

(3)

```
with { UE in E-UTRA RRC_CONNECTED state }
ensure that {
  when { UE receives a MobilityFromEUTRACommand message containing a tunnelled 1xRTT GCSNA Encapsulated Handoff Direction message }
  then { UE transmits a 1xRTT Handoff Completion message on the target 1xRTT cell }
}
```

8.4.7.6.2 Conformance requirements

References: The conformance requirements covered in the present TC are specified in: TS 23.272, clause B.2.3a.2.

[TS 23.272, clause B.2.3a.2]

The following figure describes the mobile originating call procedures for the enhanced CS Fallback to 1xRTT with concurrent non-optimised PS handover or optimised idle-mode PS handover, or without concurrent PS handover, in the normal case. Clause B.2.3b describes the procedure when the procedure is rejected by the MME.

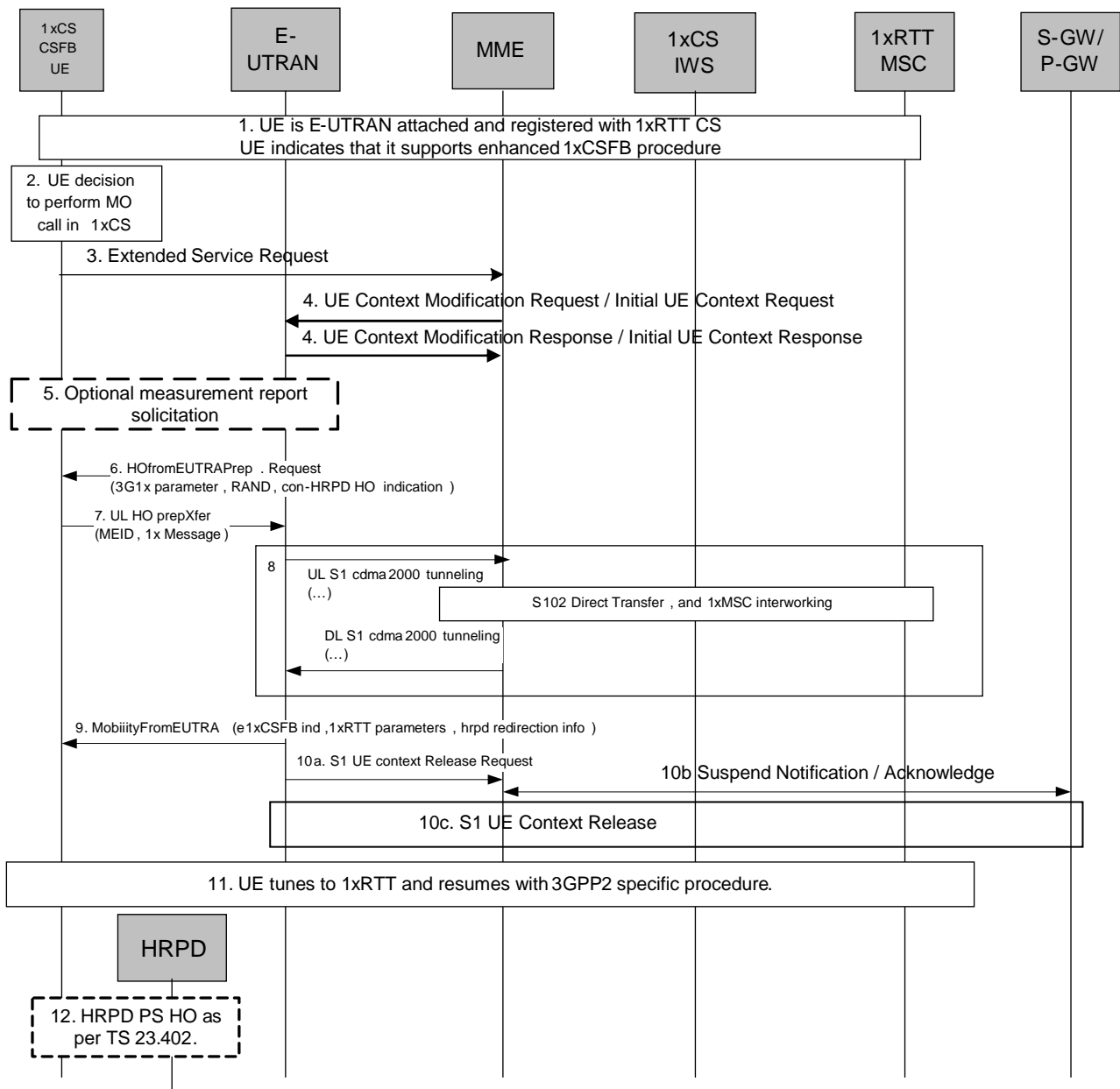

Figure B.2.3a.2-1: Enhanced CS fallback to 1xRTT MO Call with no PS handover, or with concurrent non-optimised PS handover or optimised idle-mode PS handover

1. UE is E UTRAN attached and registered with 1xRTT CS as defined in clause B.2.1.1 with enhanced CS fallback to 1xRTT capability indication to the network. The UE may also indicate that it supports concurrent 1xRTT and HRPD capability.. The UE may also be pre-registered with HRPD access using procedures defined in TS 23.402 [27], clause 9.3.1.
2. UE makes a decision to perform a mobile originated CS call.
3. UE sends an Extended Service Request (CS Fallback Indicator) to the MME.
4. For a UE in active mode, MME sends UE Context Modification Request (CS Fallback Indicator) to E-UTRAN. CS Fallback Indicator indicates to the E UTRAN to move the UE to 1xRTT. E-UTRAN responds with UE Context Modification Response.

For a UE in idle mode, MME sends Initial UE Context Request (CS Fallback Indicator) to E-UTRAN. CS Fallback Indicator indicates to the E-UTRAN to move the UE to 1xRTT. E-UTRAN responds with Initial UE Context Response.

5. E-UTRAN may optionally solicit a 1xRTT measurement report from the UE to determine the target 1xRTT cell to which the CS Fallback will be performed.

If the network supports PS handover procedure to HRPD then E-UTRAN may optionally solicit an HRPD measurement report from the UE to determine whether the target HRPD candidates exist or not. If the network does not support PS handover procedure to HRPD or if no target HRPD candidates exist then E-UTRAN shall release the S1 UE context (see step 10a/b) after executing the enhanced CS fallback to 1xRTT procedure.

6. E-UTRAN sends a HandoverFromE-UTRANPreparation Request message to the UE to start the enhanced 1xCS fallback procedure. It includes 3G1x Overhead Parameters and RAND value. This message also includes an indication that concurrent HRPD handover preparation is not required.
 7. The UE initiates signalling for establishment of the CS access leg by sending UL HandoverPreparation Transfer message which contains the 1xRTT Origination message with called party number.
 8. Messages between MME and 1xIWS are tunnelled using the S102 interface. The 1xRTT MSC initiates the call with the called party number carried in the 1xRTT Origination message.
 9. The E-UTRAN sends Mobility from EUTRA Command to the UE with indication that this is for enhanced 1x CS Fallback operation, 1xRTT related information, and optionally the HRPD redirection information. The 1xRTT information contains 1xRTT messages related to 1x channel assignment and cause the UE to tune to and acquire this 1x channel. This is perceived by the UE as a Handover Command message to 1xRTT. If 1xRTT CS network cannot support this CSFB request (for example due to resource availability), the DL information transfer message is sent instead, with an embedded 1x message that indicates failure to the UE.
 - For either concurrent non-optimised PS handover procedure or optimised idle-mode PS handover procedure along with enhanced CS fallback to 1xRTT, E-UTRAN may also redirect the UE to HRPD as part of this procedure. This is indicated by the HRPD redirection information in the Mobility from EUTRA Command.
- 10a/b/c. If PS handover procedure is not performed then E-UTRAN sends an S1 UE Context Release Request (Cause) message to the MME. Cause indicates that the S1 UE Context Release was caused by CS fallback to 1xRTT. The S1-U bearers are released and the MME starts the preservation and suspension of non-GBR bearers and the deactivation of GBR bearers towards S-GW and P-GW(s). The MME sets the UE context to suspended status.
11. UE returns to the 1xRTT radio access network and performs 1xchannel acquisition with the 1xRTT CS access (e.g. 1xRTT BSS).
 12. UE and Network follow the appropriate procedure for handling non-optimised PS handover procedure or optimised idle-mode PS handover as defined in TS 23.402 [27] if performed. S1 UE Context release procedure is as specified in TS 23.402 [27] for non-optimised PS handover (clause 8.2.2) or optimised idle-mode PS handover (clause 9.4). This step occurs in parallel with step 11.

8.4.7.6.3 Test description

8.4.7.6.3.1 Pre-test conditions

System Simulator:

- Cell 1 and Cell 19.
- Cell 19 has a lower reselection priority than Cell 1.
- System information combination 6 as defined in TS 36.508 [18] clause 4.4.3.1 is used in E-UTRA cells.

UE:

None.

Preamble:

- The UE is in state Generic RB Established, pre-registered on 1xRTT (state 3C) on Cell 1 according to [18].
-

8.4.7.6.3.2 Test procedure sequence

Table 8.4.7.6.3.2-1 illustrates the downlink power levels and other changing parameters to be applied for the cells at various time instants of the test execution. Row marked "T0" denotes the initial conditions, while row marked "T1" is to be applied subsequently. The exact instants on which these values shall be applied are described in the texts in this clause.

Table 8.4.7.6.3.2-1: Cell configuration changes over time

	Parameter	Unit	Cell 1	Cell 19	Remark
T0	Cell-specific RS EPRE	dBm/15kHz	-60	-	S _{rxlev} _{Cell 1} > 0 and Cell 19 is off such that camping on Cell 1 is guaranteed.
	I _{or} /I _{oc}	dB	-	-	
	Pilot E _c /I _{or}	dB	-	-	
	I _{oc}	dBm/1.23 MHz	-	-	
	Pilot E _c /I _o (Note 1)	dB	-	-	
T1	Cell-specific RS EPRE	dBm/15kHz	-60	-	Cell 19 is on, with S _{ServingCell} > Thresh _{serv, low} and S _{nonServingCell, x} < Thresh _{x, low} .
	I _{or} /I _{oc}	dB	-	0	
	Pilot E _c /I _{or}	dB	-	-7	
	I _{oc}	dBm/1.23 MHz	-	-75	
	Pilot E _c /I _o (Note 1)	dB	-	-10	
Note 1: This parameter is not directly settable, but is derived by calculation from the other parameters set by the SS.					

Table 8.4.7.6.3.2-2: Main behaviour

St	Procedure	Message Sequence		TP	Verdict
		U - S	Message		
1	A voice call is originated at the UE	-	-	-	-
2	Check: Does the UE transmit an <i>ULInformationTransfer</i> containing an EXTENDED SERVICE REQUEST with Service Type IE set to "mobile originating CS fallback or 1xCS fallback" on Cell 1?	-->	<i>ULInformationTransfer</i>	1	P
3	The SS changes the cell power levels according to "T1" in Table 8.4.7.6.3.2-1.				
4	The SS transmits an <i>RRCConnectionReconfiguration</i> message on Cell 1 to setup inter RAT measurement on Cell 19.	<--	<i>RRCConnectionReconfiguration</i>		
5	The UE transmits an <i>RRCConnectionReconfigurationComplete</i> message on Cell 1 to confirm the setup of inter RAT measurement.	-->	<i>RRCConnectionReconfigurationComplete</i>		
6	The UE transmits a <i>MeasurementReport</i> message on Cell 1 to report event B2 for Cell 19.	-->	<i>MeasurementReport</i>		
7	The SS transmits a <i>HandoverFromEUTRAPreparationRequest</i> on Cell 1.	<--	<i>HandoverFromEUTRAPreparationRequest</i>		
8	Check: Does the UE transmit a tunnelled <i>1xRTT GCSNA Encapsulated Origination</i> message contained in an <i>ULHandoverPreparationTransfer</i> message on Cell 1?	-->	<i>ULHandoverPreparationTransfer</i>	2	P
9	The SS transmits a tunnelled <i>1xRTT GCSNA Encapsulated Handoff Direction</i> message contained in a <i>MobilityFromEUTRACommand</i> on Cell1 to order the UE to perform inter RAT handover to Cell 19.	<--	<i>MobilityFromEUTRACommand</i>		
10	The UE tunes to 1xRTT radio.				
11	Check: Does the UE transmit a <i>1xRTT Handoff Completion</i> message on Cell 19?	-->	<i>Handoff Completion</i>	3	P

8.4.7.6.3.3 Specific message contents

Table 8.4.7.6.3.3-1: *ULInformationTransfer* (Step 2, Table 8.4.7.6.3.2-2)

Derivation Path: 36.508 Table 4.6.1-25			
Information Element	Value/remark	Comment	Condition
<i>ULInformationTransfer</i> ::= SEQUENCE {			
criticalExtensions CHOICE {			
c1 CHOICE {			
ulInformationTransfer-r8 SEQUENCE {			
dedicatedInfoType CHOICE {			
dedicatedInfoNAS	Set according to Table 8.4.7.6.3.3-2	EXTENDED SERVICE REQUEST	
}			
}			
}			
}			
}			

Table 8.4.7.6.3.3-2: EXTENDED SERVICE REQUEST (Step 2, Table 8.4.7.6.3.2-2)

Derivation Path: 36.508 Table 4.7.2-14A			
Information Element	Value/remark	Comment	Condition
Protocol discriminator	EMM		
Service type	'0000'B	mobile originating CS fallback or 1xCS fallback	
CSFB response	Not present		

Table 8.4.7.6.3.3-3: RRCConnectionReconfiguration (Step 4, Table 8.4.7.6.3.2-2)

Derivation Path: 36.508, Table 4.6.1-8, condition MEAS
--

Table 8.4.7.6.3.3-4: MeasConfig (Step 4, Table 8.4.7.6.3.2-2)

Derivation Path: 36.508, Table 4.6.6-1			
Information Element	Value/remark	Comment	Condition
MeasConfig ::= SEQUENCE {			
measObjectToAddModList SEQUENCE (SIZE (1..maxObjectId)) OF SEQUENCE {	2 entries		
measObjectId[1]	IdMeasObject-f17		
measObject[1]	MeasObjectCDMA2000- GENERIC		
measObjectId[2]	IdMeasObject-f1		
measObject[2]	MeasObjectEUTRA- GENERIC(f1)		
}			
reportConfigToAddModList SEQUENCE (SIZE (1..maxReportConfigId)) OF SEQUENCE {	1 entry		
reportConfigId[1]	IdReportConfig-B2- CDMA2000		
reportConfig[1]	ReportConfigInterRAT- B2-CDMA2000(-69, -18)		
}			
measIdToAddModList SEQUENCE (SIZE (1..maxMeasId)) OF SEQUENCE {	1 entry		
measId[1]	1		
measObjectId[1]	IdMeasObject-f17		
reportConfigId[1]	IdReportConfig-B2- CDMA2000		
}			
quantityConfig SEQUENCE {			
quantityConfigEUTRA	Not present		
quantityConfigUTRA	Not present		
quantityConfigGERAN	Not present		
quantityConfigCDMA2000 SEQUENCE {			
measQuantityCDMA2000	pilotPnPhaseAndPilotStre ngth		
}			
}			
measGapConfig CHOICE {			
setup SEQUENCE {			
gapOffset CHOICE {			
gp1	30		
}			
}			
}			
}			
}			
}			
}			
}			

Table 8.4.7.6.3.3-5: MeasObjectCDMA2000-GENERIC (Step 4, Table 8.4.7.6.3.2-2)

Derivation Path: 36.508, Table 4.6.6-1C			
Information Element	Value/remark	Comment	Condition
MeasObjectCDMA2000-GENERIC ::= SEQUENCE {			
cdma2000-Type	Type1XRTT		
CarrierFreqCDMA2000 SEQUENCE {			
bandClass	Band Class of frequency under test		
arfcn	f17		
}			
SearchWindowSize	15		
offsetFreq	db0		
cellsToRemoveList	Not present		
cellsToAddModList CHOICE {}	Cell 19		
cellForWhichToReportCGI	Not present		
}			

Table 8.4.7.6.3.3-6: MeasurementReport (Step 6, Table 8.4.7.6.3.2-2)

Derivation Path: 36.508, Table 4.6.1-5			
Information Element	Value/remark	Comment	Condition
MeasurementReport ::= SEQUENCE {			
criticalExtensions CHOICE {			
c1 CHOICE{			
measurementReport-r8 SEQUENCE {			
measResults SEQUENCE {			
measId	1		
measResultServCell SEQUENCE {			
rsrpResult	(0..97)		
rsrqResult	(0..34)		
}			
measResultNeighCells CHOICE {			
measResultsCDMA2000 ::=SEQUENCE {			
preRegistrationStatusHRPD	FALSE		
measResultListCDMA2000 ::=SEQUENCE (SIZE (1..maxCellReport)) OF SEQUENCE {	1 entry		
physCellId[1]	PhysicalCellIdentity of Cell 19		
cgi-Info[1]	Not present		
measResult[1] SEQUENCE {			
pilotPnPhase	(0..32767)		
pilotStrength	(0..63)		
}			
}			
}			
}			
}			
}			
}			

Table 8.4.7.6.3.3-7: HandoverFromEUTRAPreparationRequest (Step 7, Table 8.4.7.6.3.2-2)

Derivation Path: 36.508 Table 4.6.1-4			
Information Element	Value/remark	Comment	Condition
HandoverFromEUTRAPreparationRequest ::= SEQUENCE {			
criticalExtensions CHOICE {			
c1 CHOICE {			
handoverFromEUTRAPreparationRequest-r8 SEQUENCE {			
cdma2000-Type	Type1XRTT		
Rand	Set by SS	Random Challenge Data as broadcast on Cell 19	
mobilityParameters	Set according to 36.508 Table 4.5.2C.4-6	CDMA2000Parameters	
}			
}			
}			

Table 8.4.7.6.3.3-8: ULHandoverPreparationTransfer (Step 8, Table 8.4.7.6.3.2-2)

Derivation Path: 36.508 Table 4.6.1-24			
Information Element	Value/remark	Comment	Condition
ULHandoverPreparationTransfer ::= SEQUENCE {			
criticalExtensions CHOICE {			
c1 CHOICE {			
ulHandoverPreparationTransfer-r8 SEQUENCE {			
cdma2000-Type	Type1XRTT		
Meid	UE's meid		
dedicatedInfo	Set according to Table 8.4.7.6.3.3-9	1xRTT GCSNA Encapsulated Origination message	
}			
}			
}			

Table 8.4.7.6.3.3-9: 1xRTT GCSNA Encapsulated Origination (Step 8, Table 8.4.7.6.3.2-2)

Information Element	Value/remark	Comment	Condition
MessageID	'0000001'B	GCSNA1xCircuitService message	
GCSNAOption	'0000001'B		
AlternativeGCSNAOption_INCL	'0'B		
IWSIDIncl	'0'B		
AckRequired	'0'B		
StopDupDetect	'0'B		
MessageSequence	Set by UE		
NumTLACEncapsulated1xL3PDU	'00'B		
Reserved	'0000'B		
1xLogicalChannel	'0'B		
1xProtocolRevision	'00000110'B		
MsgType	'00000100'B	Origination message	this value shall be verified by TTCN
NumTLACHeaderRecords	'0001'B		
TLACHeaderRecordType	'0000'B		
TLACHeaderRecordLength	4 bits, Set by UE		
MSID_TYPE	3 bits, Set by UE	Should be matched with PREF_MSID_TYPE	
MSID_LEN	4 bits, Set by UE		
MSID	Variable, Set by UE		
Reserved	'0000000'B		
1xL3PDULength	16 bits, Set by UE		
MOB_TERM	'1'B		
SLOT_CYCLE_INDEX	'010'B		
MOB_P_REV	8 bits, Set by UE		
SCM	8 bits, Set by UE		
REQUEST_MODE	'001'B		
SPECIAL_SERVICE	'1'B		
SERVICE_OPTION	16 bits, any value mapping to a voice service option		
PM	'0'B		
DIGIT_MODE	'0'B		
NUMBER_TYPE	3 bits, Set by UE		
NUMBER_PLAN	4 bits, Set by UE		
MORE_FIELDS	'0'B		
NUM_FIELDS	8 bits, Set by UE		
CHARi	Variable, Set by UE		
NAR_AN_CAP	'0'B		
PACA_REORIG	'0'B		
RETURN_CAUSE	'0000'B		
MORE_RECORDS	'0'B		
ENCRYPTION_SUPPORTED	'0000'B		
PACA_SUPPORTED	'0'B		
NUM_ALT_SO	'000'B		
DRS	'1'B		
UZID_INCL	'0'B		
CH_IND	'01'B		
SR_ID	3 bits, Set by UE		
OTD_SUPPORTED	'1'B		
QPCH_SUPPORTED	'1'B		
ENHANCED_RC	'1'B		
FOR_RC_PREF	'00011'B		
REV_RC_PREF	'00011'B		
FCH_SUPPORTED	'1'B		
FCH Capability Type-specific fields	Variable		
DCCH_SUPPORTED	'1'B		
RESERVED	'0'B		

REV_FCH_GATING_REQ	'0'B		
--------------------	------	--	--

Table 8.4.7.6.3.3-10: *MobilityFromEUTRACommand* (Step 9, Table 8.4.7.6.3.2-2)

Derivation Path: 36.508, Table 4.6.1-6			
Information Element	Value/remark	Comment	Condition
MobilityFromEUTRACommand ::= SEQUENCE {			
criticalExtensions CHOICE {			
c1 CHOICE{			
mobilityFromEUTRACommand-r9 SEQUENCE {			
csFallbackIndicator	False		
purpose CHOICE{			
e-CSFB-r9 SEQUENCE {			
messageContCDMA2000-1XRTT-r9	Set according to Table 8.4.7.6.3.3-11	1xRTT GCSNA Encapsulated Handoff Direction message	
}			
}			
}			
}			
}			

Table 8.4.7.6.3.3-11: 1xRTT GCSNA Encapsulated Handoff Direction (Step 9, Table 8.4.7.6.3.2-2)

Information Element	Value/remark	Comment	Condition
MessageID	'0000001'B		
GCSNAOption	'0000001'B		
AlternativeGCSNAOption_INCL	'0'B		
IWSIDIncl	'0'B		
AckRequired	'0'B		
StopDupDetect	'0'B		
MessageSequence	Set by SS		
NumTLACEncapsulated1xL3PDU	'00'B		
Reserved	'0000'B		
1xLogicalChannel	'1'B		
1xProtocolRevision	'0000110'B		
MsgType	'00100010'B	Universal Handoff Direction message	
NumTLACHeaderRecords	'0000'B		
Reserved	'000'B		
1xL3PDULength	16 bits, Set by SS		
USE_TIME	'0'B		
ACTION_TIME	'000000'B		
HDM_SEQ	2 bits, Set by SS		
PARMS_INCL	'1'B		
P_REV	'00000110'B		
SERV_NEG_TYPE	'1'B		
SEARCH_INCLUDED	'1'B		
SRCH_WIN_A	'1000'B		
SRCH_WIN_N	'1001'B		
SRCH_WIN_R	'1011'B		
T_ADD	'010100'B		
T_DROP	'011110'B		
T_COMP	'1010'B		
T_TDROP	'0100'B		
SOFT_SLOPE	'000000'B		
ADD_INTERCEPT	'000000'B		
DROP_INTERCEPT	'000000'B		
EXTRA_PARMS	'1'B		
PACKET_ZONE_ID	'00000000'B		
FRAME_OFFSET	4 bits, Set by SS		
PRIVATE_LCM	'0'B		
RESET_L2	'1'B		
RESET_FPC	'1'B		
ENCRYPT_MODE	'00'B		
NOM_PWR_EXT	'0'B		
NOM_PWR	'0000'B		
RLGAIN_TRAFFIC_PILOT	'000000'B		
DEFAULT_RLAG	'1'B		
NUM_PREAMBLE	'000'B		
BAND_CLASS	5 bits, Set by SS		
CDMA_FREQ	11 bits, Set by SS		
RETURN_IF_HANDOFF_FAIL	'0'B		
PERIODIC_SEARCH	'0'B		
SCR_INCLUDED	'1'B		
NNSCR_INCLUDED	'1'B		
USE_PWR_CNTL_STEP	'0'B		
CLEAR_RETRY_DELAY	'0'B		
SCH_INCL	'1'B		
FPC_SUBCHAN_GAIN	'01010'B		
USE_PC_TIME	'0'B		
CH_IND	'101'B		
ACTIVE_SET_REC_LEN	8 bits, Set by SS		
NUM_PILOTS	'001'B		
SRCH_OFFSET_INCL	'1'B		
PILOT_PN	'000000000'B		
SRCH_OFFSET	'010'B		

ADD_PILOT_REC_INCL	'0'B		
PWR_COMB_IND	'0'B		
CODE_CHAN_FCH	11 bits, Set by SS		
QOF_MASK_ID_FCH	'00'B		
RESERVED	0-7 bits		
REV_FCH_GATING_MODE	'0'B		

Table 8.4.7.6.3.3-12: 1xRTT Handoff Completion (Step 11, Table 8.4.7.6.3.2-2)

Information Element	Value/remark	Comment	Condition
MSG_ID	'00001010'		this value shall be verified by TTCN
ACK_SEQ	3 bits, Set by SS		
MSG_SEQ	3 bits, Set by SS		
ACK_REQ	'1'B		
ENCRYPTION	'00'B		
RESERVED	'0'B		
LAST_HDM_SEQ	Same value as HDM_SEQ in 1xRTT Handoff Direction message at Step 9		
PILOT_PN	Same value as PILOT_PN included in 1xRTT Handoff Direction message at Step 9		

8.4.7.7 Pre-registration at 1xRTT and inter-RAT handover / Enhanced CS fallback from E-UTRA RRC_CONNECTED to e1XCSFB ECAM-based 1xRTT / MO call

8.4.7.7.1 Test Purpose (TP)

(1)

```
with { UE in E-UTRA RRC_CONNECTED state and having completed the 1xRTT CS pre-registration procedure }
ensure that {
  when { UE originates a voice call }
  then { UE transmits an EXTENDED SERVICE REQUEST message with Service Type IE set to "mobile originating CS fallback or 1xCS fallback" }
}
```

(2)

```
with { UE having transmitted an ULInformationTransfer message containing an EXTENDED SERVICE REQUEST message with Service Type IE set to "mobile originating CS fallback or 1xCS fallback" }
ensure that {
  when { UE receives HandoverFromEUTRAPreparationRequest message with cdma2000-type set to 'type1XRTT' }
  then { UE transmits an ULHandoverPreparationTransfer message containing a tunnelled 1xRTT GCSNA Encapsulated Origination message }
}
```

(3)

```
with { UE in E-UTRA RRC_CONNECTED state }
ensure that {
  when { UE receives a MobilityFromEUTRACommand message containing a tunnelled 1xRTT GCSNA Encapsulated ECAM message }
  then { UE tunes to the 1X channel and pilots specified in the ECAM, and proceeds to send the ORM over the target 1xRTT cell }
}
```

8.4.7.7.2 Conformance requirements

References: The conformance requirements covered in the present TC are specified in: TS 23.272, clause B.2.3a.2.

[TS 23.272, clause B.2.3a.2]

The following figure describes the mobile originating call procedures for the enhanced CS Fallback to 1xRTT with concurrent non-optimised PS handover or optimised idle-mode PS handover, or without concurrent PS handover, in the normal case. Clause B.2.3b describes the procedure when the procedure is rejected by the MME.

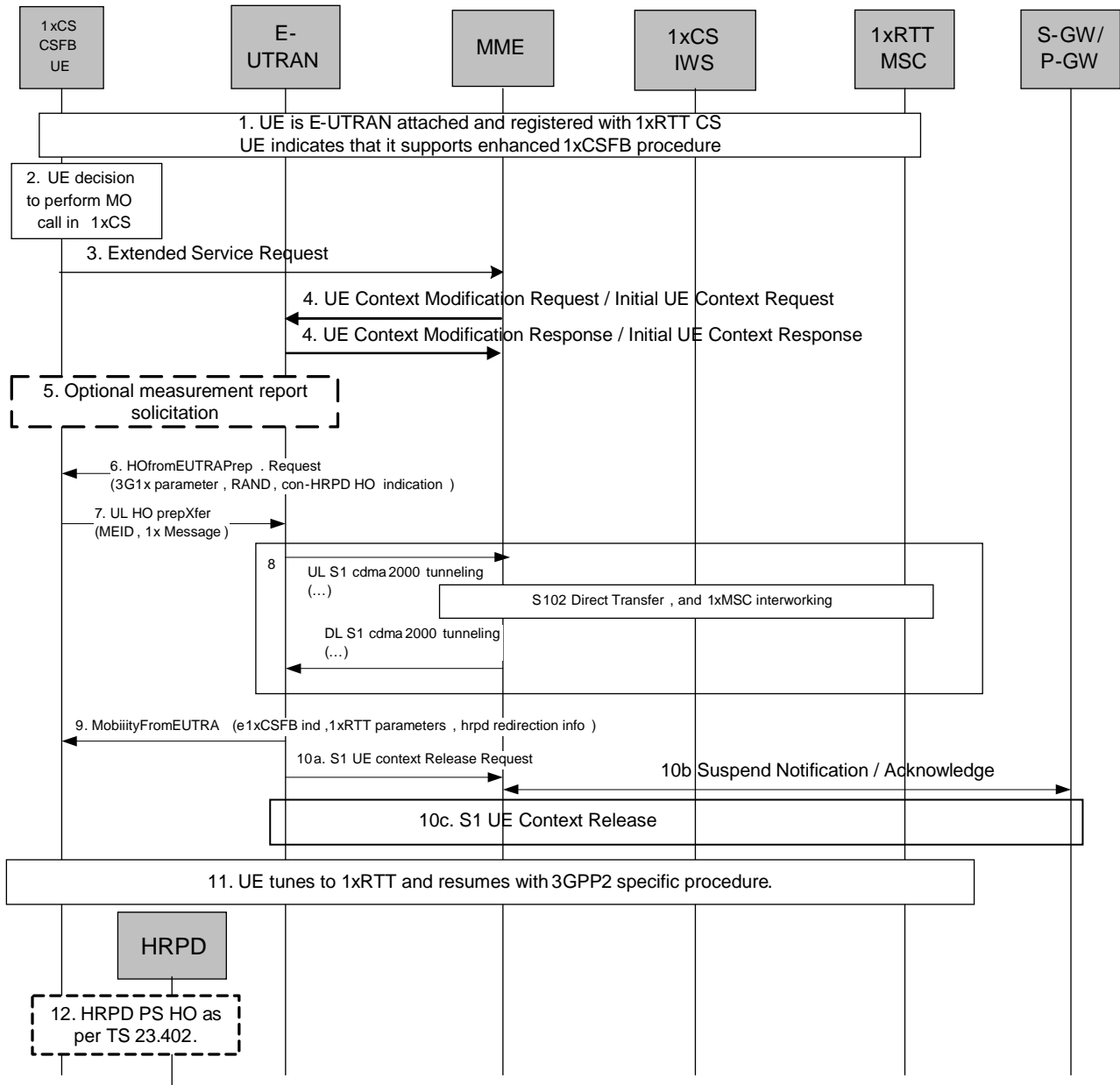

Figure B.2.3a.2-1: Enhanced CS fallback to 1xRTT MO Call with no PS handover, or with concurrent non-optimised PS handover or optimised idle-mode PS handover

1. UE is E UTRAN attached and registered with 1xRTT CS as defined in clause B.2.1.1 with enhanced CS fallback to 1xRTT capability indication to the network. The UE may also indicate that it supports concurrent 1xRTT and HRPD capability.. The UE may also be pre-registered with HRPD access using procedures defined in TS 23.402 [27], clause 9.3.1.
2. UE makes a decision to perform a mobile originated CS call.

3. UE sends an Extended Service Request (CS Fallback Indicator) to the MME.
4. For a UE in active mode, MME sends UE Context Modification Request (CS Fallback Indicator) to E-UTRAN. CS Fallback Indicator indicates to the E-UTRAN to move the UE to 1xRTT. E-UTRAN responds with UE Context Modification Response.

For a UE in idle mode, MME sends Initial UE Context Request (CS Fallback Indicator) to E-UTRAN. CS Fallback Indicator indicates to the E-UTRAN to move the UE to 1xRTT. E-UTRAN responds with Initial UE Context Response.

5. E-UTRAN may optionally solicit a 1xRTT measurement report from the UE to determine the target 1xRTT cell to which the CS Fallback will be performed.

If the network supports PS handover procedure to HRPD then E-UTRAN may optionally solicit an HRPD measurement report from the UE to determine whether the target HRPD candidates exist or not. If the network does not support PS handover procedure to HRPD or if no target HRPD candidates exist then E-UTRAN shall release the S1 UE context (see step 10a/b) after executing the enhanced CS fallback to 1xRTT procedure.

6. E-UTRAN sends a HandoverFromE-UTRANPreparation Request message to the UE to start the enhanced 1xCS fallback procedure. It includes 3G1x Overhead Parameters and RAND value. This message also includes an indication that concurrent HRPD handover preparation is not required.
7. The UE initiates signalling for establishment of the CS access leg by sending UL HandoverPreparation Transfer message which contains the 1xRTT Origination message with called party number.
8. Messages between MME and 1xIWS are tunnelled using the S102 interface. The 1xRTT MSC initiates the call with the called party number carried in the 1xRTT Origination message.
9. The E-UTRAN sends Mobility from EUTRA Command to the UE with indication that this is for enhanced 1xCS Fallback operation, 1xRTT related information, and optionally the HRPD redirection information. The 1xRTT information contains 1xRTT messages related to 1x channel assignment and cause the UE to tune to and acquire this 1x channel. This is perceived by the UE as a Handover Command message to 1xRTT. If 1xRTT CS network cannot support this CSFB request (for example due to resource availability), the DL information transfer message is sent instead, with an embedded 1x message that indicates failure to the UE.
 - For either concurrent non-optimised PS handover procedure or optimised idle-mode PS handover procedure along with enhanced CS fallback to 1xRTT, E-UTRAN may also redirect the UE to HRPD as part of this procedure. This is indicated by the HRPD redirection information in the Mobility from EUTRA Command.

10a/b/c. If PS handover procedure is not performed then E-UTRAN sends an S1 UE Context Release Request (Cause) message to the MME. Cause indicates that the S1 UE Context Release was caused by CS fallback to 1xRTT. The S1-U bearers are released and the MME starts the preservation and suspension of non-GBR bearers and the deactivation of GBR bearers towards S-GW and P-GW(s). The MME sets the UE context to suspended status.

11. UE returns to the 1xRTT radio access network and performs 1x channel acquisition with the 1xRTT CS access (e.g. 1xRTT BSS).
12. UE and Network follow the appropriate procedure for handling non-optimised PS handover procedure or optimised idle-mode PS handover as defined in TS 23.402 [27] if performed. S1 UE Context release procedure is as specified in TS 23.402 [27] for non-optimised PS handover (clause 8.2.2) or optimised idle-mode PS handover (clause 9.4). This step occurs in parallel with step 11.

8.4.7.7.3 Test description

8.4.7.7.3.1 Pre-test conditions

System Simulator:

- Cell 1 is serving cell and Cell 19 is off.
- System information combination 6 as defined in TS 36.508 [18] clause 4.4.3.1 is used in E-UTRA cells.

UE:

None.

Preamble:

- The UE is in state Generic RB Established, pre-registered on 1xRTT (state 3C) on Cell 1 according to [18].

8.4.7.7.3.2 Test procedure sequence

Table 8.4.7.7.3.2-1 illustrates the downlink power levels and other changing parameters to be applied for the cells at various time instants of the test execution. Row marked "T0" denotes the initial conditions, while row marked "T1" is to be applied subsequently. The exact instants on which these values shall be applied are described in the texts in this clause.

Table 8.4.7.7.3.2-1: Cell configuration changes over time

	Parameter	Unit	Cell 1	Cell 19	Remark
T0	Cell-specific RS EPRE	dBm/15kHz	-60	-	S _r xlev _{Cell 1} > 0 and Cell 19 is off such that camping on Cell 1 is guaranteed.
	I _{or} /I _{oc}	dB	-	-	
	Pilot Ec/I _{or}	dB	-	-	
	I _{oc}	dBm/1.23 MHz	-	-100	
	Pilot Ec/I _o (Note 1)	dB	-	-	
T1	Cell-specific RS EPRE	dBm/15kHz	-60	-	Cell 19 in on, with S _{ServingCell} > Thresh _{servi} ng, low and S _{nonServingCell, x} < Thresh _{x, low} .
	I _{or} /I _{oc}	dB	-	0	
	Pilot Ec/I _{or}	dB	-	-7	
	I _{oc}	dBm/1.23 MHz	-	-75	
	Pilot Ec/I _o (Note 1)	dB	-	-10	
Note 1: This parameter is not directly settable, but is derived by calculation from the other parameters set by the SS.					

Table 8.4.7.7.3.2-2: Main behaviour

St	Procedure	Message Sequence		TP	Verdict
		U - S	Message		
1	The outgoing CS call is originated at the UE through MMI or AT command.				
2	Check: Does the UE transmit an <i>ULInformationTransfer</i> containing an EXTENDED SERVICE REQUEST with Service Type IE set to "mobile originating CS fallback or 1xCS fallback" on Cell 1?	-->	<i>ULInformationTransfer</i>	1	P
3	SS adjusts cell levels according to row T1 of Table 8.4.7.7.3.2-1.	-	-	-	-
4	The SS transmits an <i>RRCCONNECTIONRECONFIGURATION</i> message on Cell 1 to setup inter RAT measurement on Cell 19.	<--	<i>RRCCONNECTIONRECONFIGURATION</i>		
5	The UE transmits an <i>RRCCONNECTIONRECONFIGURATIONCOMPLETE</i> message on Cell 1 to confirm the setup of inter RAT measurement.	-->	<i>RRCCONNECTIONRECONFIGURATIONCOMPLETE</i>		
6	The UE transmits a <i>MEASUREMENTREPORT</i> message on Cell 1 to report event B2 for Cell 19.	-->	<i>MEASUREMENTREPORT</i>		
7	The SS transmits a <i>HANDOVERFROMEUTRAPREPARATIONREQUEST</i> on Cell 1.	<--	<i>HANDOVERFROMEUTRAPREPARATIONREQUEST</i>		
8	Check: Does the UE transmit a tunnelled <i>1xRTT GCSNA Encapsulated Origination</i> message contained in an <i>ULHandoverPreparationTransfer</i> message on Cell 1?	-->	<i>ULHandoverPreparationTransfer</i>	2	P
-	The following messages are to be observed on Cell 19 unless explicitly stated otherwise.	-	-	-	-
9	The SS transmits a tunnelled <i>1xRTT GCSNA Encapsulated ECAM</i> message contained in a <i>MobilityFromEUTRACOMMAND</i> on Cell1 to order the UE to perform inter RAT to Cell 19.	<--	<i>MobilityFromEUTRACOMMAND</i>		
10	Check: Does UE tunes to the 1XRTT and pilots specified in the ECAM, and proceeds to send the ORM on Cell 19?	-->	<i>Origination</i>	3	P
11	The SS transmits an <i>Extended Channel Assignment</i> message on Cell 19.	<--	<i>Extended Channel Assignment</i>		
12	After the SS detects that Traffic Channel Initialization is successful, it transmits an <i>Acknowledgement Order</i> message on Cell 19.	<--	<i>Acknowledgement Order</i>		
13	The SS transmits a <i>Service Connect</i> message on Cell 19.	<--	<i>Service Connect</i>		
14	The UE transmits a <i>Service Connect Completion</i> message on Cell 19.	-->	<i>Service Connect Completion</i>		

8.4.7.7.3.3 Specific message contents

Table 8.4.7.7.3.3-1: *ULInformationTransfer* (Step 2, Table 8.4.7.7.3.2-2)

Derivation Path: 36.508 Table 4.6.1-25			
Information Element	Value/remark	Comment	Condition
ULInformationTransfer ::= SEQUENCE {			
criticalExtensions CHOICE {			
c1 CHOICE {			
ulInformationTransfer-r8 SEQUENCE {			
dedicatedInfoType CHOICE {			
dedicatedInfoNAS	Set according to Table 8.4.7.7.3.3-2	EXTENDED SERVICE REQUEST	
}			
}			
}			
}			
}			

Table 8.4.7.7.3.3-2: *EXTENDED SERVICE REQUEST* (Step 2, Table 8.4.7.7.3.2-2)

Derivation Path: 36.508 Table 4.7.2-14A			
Information Element	Value/remark	Comment	Condition
Protocol discriminator	EMM		
Service type	'0000'B	mobile originating CS fallback or 1xCS fallback	
CSFB response	Not present		

Table 8.4.7.7.3.3-3: *RRCConnectionReconfiguration* (Step 4, Table 8.4.7.7.3.2-2)

Derivation Path: 36.508, Table 4.6.1-8, condition MEAS
--

Table 8.4.7.7.3.3-6: MeasurementReport (Step 6, Table 8.4.7.7.3.2-2)

Derivation Path: 36.508, Table 4.6.1-5			
Information Element	Value/remark	Comment	Condition
MeasurementReport ::= SEQUENCE {			
criticalExtensions CHOICE {			
c1 CHOICE{			
measurementReport-r8 SEQUENCE {			
measResults SEQUENCE {			
measId	1		
measResultServCell SEQUENCE {			
rsrpResult	(0..97)		
rsrqResult	(0..34)		
}			
measResultNeighCells CHOICE {			
measResultsCDMA2000 ::=SEQUENCE {			
preRegistrationStatusHRPD	FALSE		
measResultListCDMA2000 ::=SEQUENCE	1 entry		
(SIZE (1..maxCellReport)) OF SEQUENCE {			
physCellId[1]	PhysicalCellIdentity of Cell 19		
cgi-Info[1]	Not present		
measResult[1] SEQUENCE {			
pilotPnPhase	(0..32767)		
pilotStrength	(0..63)		
}			
}			
}			
}			
}			
}			
}			
}			

Table 8.4.7.7.3.3-7: HandoverFromEUTRAPreparationRequest (Step 7, Table 8.4.7.7.3.2-2)

Derivation Path: 36.508 Table 4.6.1-4			
Information Element	Value/remark	Comment	Condition
HandoverFromEUTRAPreparationRequest ::= SEQUENCE {			
criticalExtensions CHOICE {			
c1 CHOICE {			
handoverFromEUTRAPreparationRequest-r8 SEQUENCE {			
cdma2000-Type	Type1XRTT		
Rand	Set by SS	Random Challenge Data as broadcast on Cell 19	
mobilityParameters	Set according to 36.508 Table 4.5.2C.4-6	CDMA2000Parameters	
}			
}			
}			
}			

Table 8.4.7.7.3.3-8: ULHandoverPreparationTransfer (Step 8, Table 8.4.7.7.3.2-2)

Derivation Path: 36.508 Table 4.6.1-24			
Information Element	Value/remark	Comment	Condition
ULHandoverPreparationTransfer ::= SEQUENCE {			
criticalExtensions CHOICE {			
c1 CHOICE {			
ulHandoverPreparationTransfer-r8 SEQUENCE {			
cdma2000-Type	Type1XRTT		
Meid	UE's meid		
dedicatedInfo	Set according to Table 8.4.7.7.3.3-9	1xRTT GCSNA Encapsulated Origination message	
}			
}			
}			
}			

Table 8.4.7.7.3.3-9: 1xRTT GCSNA Encapsulated Origination (Step 8, Table 8.4.7.7.3.2-2)

Information Element	Value/remark	Comment	Condition
MessageID	'00000001'B	GCSNA1xCircuitService message	
GCSNAOption	'00000001'B		
AlternativeGCSNAOption_INCL	'0'B		
IWSIDIncl	'0'B		
AckRequired	'0'B		
StopDupDetect	'0'B		
MessageSequence	Set by UE		
NumTLACEncapsulated1xL3PDU	'00'B		
Reserved	'0000'B		
1xLogicalChannel	'0'B		
1xProtocolRevision	'00000110'B		
MsgType	'00000100'B	Origination message	this value shall be verified by TTCN
NumTLACHeaderRecords	'0001'B		
TLACHeaderRecordType	'0000'B		
TLACHeaderRecordLength	4 bits, Set by UE		
MSID_TYPE	3 bits, Set by UE	Should be matched with PREF_MSID_TYPE	
MSID_LEN	4 bits, Set by UE		
MSID	Variable, Set by UE		
Reserved	'0000000'B		
1xL3PDULength	16 bits, Set by UE		
MOB_TERM	'1'B		
SLOT_CYCLE_INDEX	'010'B		
MOB_P_REV	8 bits, Set by UE		
SCM	8 bits, Set by UE		
REQUEST_MODE	'001'B		
SPECIAL_SERVICE	'1'B		
SERVICE_OPTION	16 bits, any value mapping to a voice service option		
PM	'0'B		
DIGIT_MODE	'0'B		
NUMBER_TYPE	3 bits, Set by UE		
NUMBER_PLAN	4 bits, Set by UE		
MORE_FIELDS	'0'B		
NUM_FIELDS	8 bits, Set by UE		
CHARi	Variable, Set by UE		
NAR_AN_CAP	'0'B		
PACA_REORIG	'0'B		
RETURN_CAUSE	'0000'B		
MORE_RECORDS	'0'B		
ENCRYPTION_SUPPORTED	'0000'B		
PACA_SUPPORTED	'0'B		
NUM_ALT_SO	'000'B		
DRS	'1'B		
UZID_INCL	'0'B		
CH_IND	'01'B		
SR_ID	3 bits, Set by UE		
OTD_SUPPORTED	'1'B		
QPCH_SUPPORTED	'1'B		
ENHANCED_RC	'1'B		
FOR_RC_PREF	'00011'B		
REV_RC_PREF	'00011'B		
FCH_SUPPORTED	'1'B		
FCH Capability Type-specific fields	Variable		
DCCH_SUPPORTED	'1'B		
RESERVED	'0'B		

REV_FCH_GATING_REQ	'0'B		
--------------------	------	--	--

Table 8.4.7.7.3.3-10: MobilityFromEUTRACommand (Step 9, Table 8.4.7.7.3.2-2)

Derivation Path: 36.508, Table 4.6.1-6			
Information Element	Value/remark	Comment	Condition
MobilityFromEUTRACommand ::= SEQUENCE {			
criticalExtensions CHOICE {			
c1 CHOICE{			
mobilityFromEUTRACommand-r9 SEQUENCE {			
csFallbackIndicator	False		
purpose CHOICE{			
e-CSFB-r9 SEQUENCE {			
messageContCDMA2000-1XRTT-r9	Set according to Table 8.4.7.7.3.3-11	1xRTT GCSNA Encapsulated ECAM message	
}			
}			
}			
}			
}			
}			

Table 8.4.7.7.3.3-11: 1xRTT GCSNA Encapsulated ECAM message (Step 9, Table 8.4.7.7.3.2-2)

Information Element	Value/remark	Comment	Condition
MessageID	'00000001'B		
GCSNAOption	'00000001'B		
AlternativeGCSNAOption_INCL	'0'B		
IWSIDIncl	'0'B		
AckRequired	'0'B		
StopDupDetect	'0'B		
MessageSequence	Set by SS		
NumTLACEncapsulated1xL3PDU	'00'B		
Reserved	'0000'B		
1xLogicalChannel	'0'B		
1xProtocolRevision	'00001001'B		
MsgType	'00010101'B	Extended Channel Assignment Message	
NumTLACHheaderRecords	'0000'B		
Reserved	'000'B		
1xL3PDULength	16 bits, Set by SS		
ASSIGN_MODE	'001'B		
RESPOND	'1'B		
FREQ_INCL	'1 'B		
BAND_CLASS	11 bits, Frequency under test		
CDMA_FREQ	'00000110'B		
NUM_PILOTS	6 bits, Set by SS		
PILOT_PN	9 bits, Set by SS		

Table 8.4.7.3.3-12: 1xRTT Origination (step 10, Table 8.4.7.3.2-2)

Field	Value/remark	Comment	Condition
PD	'00'B		
MSG_ID	'000100'B	Origination Message	this value shall be verified by TTCN
LAC Length Field	5 bits, Set by UE		
ACK_SEQ	3 bits, Set by UE		
MSG_SEQ	3 bits, Set by UE		
ACK_REQ	'1'B		
VALID_ACK	'0'B		
ACK_TYPE	'010'B		
MSID_TYPE	3 bits, Set by UE		
MSID_LEN	4 bits, Set by UE		
MSID	Variable, Set by UE		
LAC Padding Field	0 to 7, Set by UE		
ACTIVE_PILOT_STRENGTH	6 bits, set by UE		
FIRST_IS_ACTIVE	1 bit, set by UE		
FIRST_IS_PTA	1 bit, set by UE		
NUM_ADD_PILOTS	'0'B		
MOB_TERM	'1'B		
SLOT_CYCLE_INDEX	'010'B		
MOB_P_REV	8 bits, Set by UE		
SCM	8 bits, Set by UE		
REQUEST_MODE	'001'B		
SPECIAL_SERVICE	'1'B		
SERVICE_OPTION	16 bits, Any value mapping to a voice service option		
PM	'0'B		
DIGIT_MODE	'0'B		
NUMBER_TYPE	3 bits, Set by UE		
NUMBER_PLAN	4 bits, Set by UE		
MORE_FIELDS	'0'B		
NUM_FIELDS	8 bits, Set by UE		
CHARi	Variable, Set by UE		
NAR_AN_CAP	'0'B		
PACA_REORIG	'0'B		
RETURN_CAUSE	'0000'B		
MORE_RECORDS	'0'B		
ENCRYPTION_SUPPORTED	'0000'B		
PACA_SUPPORTED	'0'B		
NUM_ALT_SO	'000'B		
DRS	'1'B		
UZID_INCL	'0'B		
CH_IND	'01'B		
SR_ID	3 bits, Set by UE		
OTD_SUPPORTED	'1'B		
QPCH_SUPPORTED	'1'B		
ENHANCED_RC	'1'B		
FOR_RC_PREF	'00011'B		
REV_RC_PREF	'00011'B		
FCH_SUPPORTED	'1'B		
FCH_FRAME_SIZE	'0'B		
FOR_FCH_LEN	3 bits, Set by UE		
FOR_FCH_RC_MAP	Variable, Set by UE		
REV_FCH_LEN	3 bits, Set by UE		
REV_FCH_RC_MAP	Variable, Set by UE		
DCCH_SUPPORTED	'1'B		
RESERVED	'0'B		
REV_FCH_GATING_REQ	'0'B		

Table 8.4.7.7.3.3-13: Extended Channel Assignment (step 11, Table 8.4.7.7.3.2-2)

Field	Value/remark	Comment	Condition
MSG_TYPE	'010101'B	Extended Channel Assignment Message	
ACK_SEQ	3 bits, Set by UE		
MSG_SEQ	3 bits, Set by UE		
ACK_REQ	'0'B		
VALID_ACK	'1'B		
ADDR_TYPE	3 bits, Set by UE		
ADDR_LEN	4 bits, Set by UE		
ADDRESS	Variable, Set by UE		
RESERVED_1	'0'B		
ADD_RECORD_LEN	8 bits, Set by UE		
ASSIGN_MODE	'100'B	Traffic Channel Assignment	
RESERVED_2	'00000'B		
BAND_CLASS	5 bits, Set by SS		
CDMA_FREQ	11 bits, Set by SS		
BYPASS_ALERT_ANSWER	'1'B		
GRANTED_MODE	'10'B		
DEFAULT_CONFIG	'100'B		
FOR_RC	'00011'B		
REV_RC	'00011'B		
FRAME_OFFSET	4 bits, Set by SS		
ENCRYPT_MODE	'00'B		
FPC_SUBCHAN_GAIN	'00001'B		
RLGAIN_ADJ	0000'B		
NUM_PILOTS	'000'B		
CH_IND	'01'B		
CH_RECORD_LEN	5 bits, Set by SS		
CH_RECORD_FIELDS	Variable, Set by SS		
REV_FCH_GATING_MODE	'0'B		
RESERVED	0 – 7 bits, Set by UE		
PDU_PADDING	0 – 7 bits, Set by UE		

Table 8.4.7.7.3.3-14: Acknowledgment Order (Step 12, Table 8.4.7.7.3.2-2)

Field	Value/remark	Comment	Condition
MSG_TYPE	'00000001'B	Order Message	
ACK_SEQ	3 bits, Set by SS		
MSG_SEQ	3 bits, Set by SS		
ACK_REQ	'1'B		
ENCRYPTION	'00'B		
ORDER	'010000'B	Base Station Acknowledgment Order	
ORDQ	'00000000'B		

Table 8.4.7.7.3.3-15: Service Connect (Step 13, Table 8.4.7.7.3.2-2)

Field	Value/remark	Comment	Condition
MSG_TYPE	'00010100'B	Service Connect Message	
ACK_SEQ	3 bits, Set by SS		
MSG_SEQ	3 bits, Set by SS		
ACK_REQ	'1'B		
ENCRYPTION	'00'B		
USE_TIME	'0'B		
ACTION_TIME	'000000'B		
SERV_CON_SEQ	Set by SS		
RESERVED	'00000'B		
RECORD_TYPE	'00000111'B		
RECORD_LEN	8 bits, Set by SS		
Type-specific fields	Variable, Set by SS		
RECORD_TYPE	'00010011'B		
RECORD_LEN	8 bits, Set by SS		
Type-specific fields	Variable, Set by SS		
PDU_PADDING	0-7 bits, Set by SS		

Table 8.4.7.7.3.3-16: Service Connect Completion (step 14, Table 8.4.7.7.3.2-2)

Information Element	Value/remark	Comment	Condition
MSG_TYPE	'00001110'B	Service Connect Completion Message	this value shall be verified by TTCN
ACK_SEQ	3 bits, Set by UE		
MSG_SEQ	3 bits, Set by UE		
ACK_REQ	'1'B		
ENCRYPTION	'00'B		
RESERVED	'0'B		
SERV_CON_SEQ	Same value as SERV_CON_SEQ received in Service Connect Message (Table 8.4.7.7.3.3-15)		
PDU_PADDING	0-7 bits, Set by UE		

8.4.7.8 Pre-registration at 1xRTT and inter-RAT Handover / Enhanced CS fallback from E-UTRA RRC_CONNECTED to 1xRTT / ECAM-based MT call

8.4.7.8.1 Test Purpose (TP)

(1)

```
with { UE in E-UTRA RRC_CONNECTED state having completed the 1xRTT CS pre-registration procedure and having received a DLInformationTransfer message containing a 1xRTT GCSNA Encapsulated Paging message }
ensure that {
  when { UE accepts CS paging for the CS Fallback to 1xRTT }
  then { UE transmits an ULInformationTransfer message containing an EXTENDED SERVICE REQUEST message with Service Type IE set to "mobile terminating CS fallback or 1xCS fallback" }
}
```

(2)

```
with { UE having transmitted an ULInformationTransfer message containing an EXTENDED SERVICE REQUEST message with Service Type IE set to "mobile terminating CS fallback or 1xCS fallback" in response to a 1xRTT CS Paging message }
ensure that {
  when { UE receives HandoverFromEUTRAPreparationRequest message with cdma2000-type set to 'type1XRTT' }
  then { UE transmits an ULHandoverPreparationTransfer message containing a tunnelled 1xRTT GCSNA Encapsulated Page Response message }
}
```

}

(3)

```

with { UE in E-UTRA RRC_CONNECTED state }
ensure that {
  when { UE receives a MobilityFromEUTRACommand message containing a tunnelled 1xRTT GCSNA Encapsulated ECAM message }
  then { UE tunes to the 1X channel and pilots specified in the ECAM, and proceeds to send the Page Response message over the target 1xRTT cell }
}
    
```

8.4.7.8.2 Conformance requirements

References: The conformance requirements covered in the present TC are specified in: TS 23.272, clause B.2.3a.4.

[TS 23.272, clause B.2.3a.4]

The following figure describes the mobile originating call procedures for the enhanced CS Fallback to 1xRTT with concurrent non-optimised PS handover or optimised idle-mode PS handover, or without concurrent PS handover, in the normal case. Clause B.2.3b describes the procedure when the procedure is rejected by the MME.

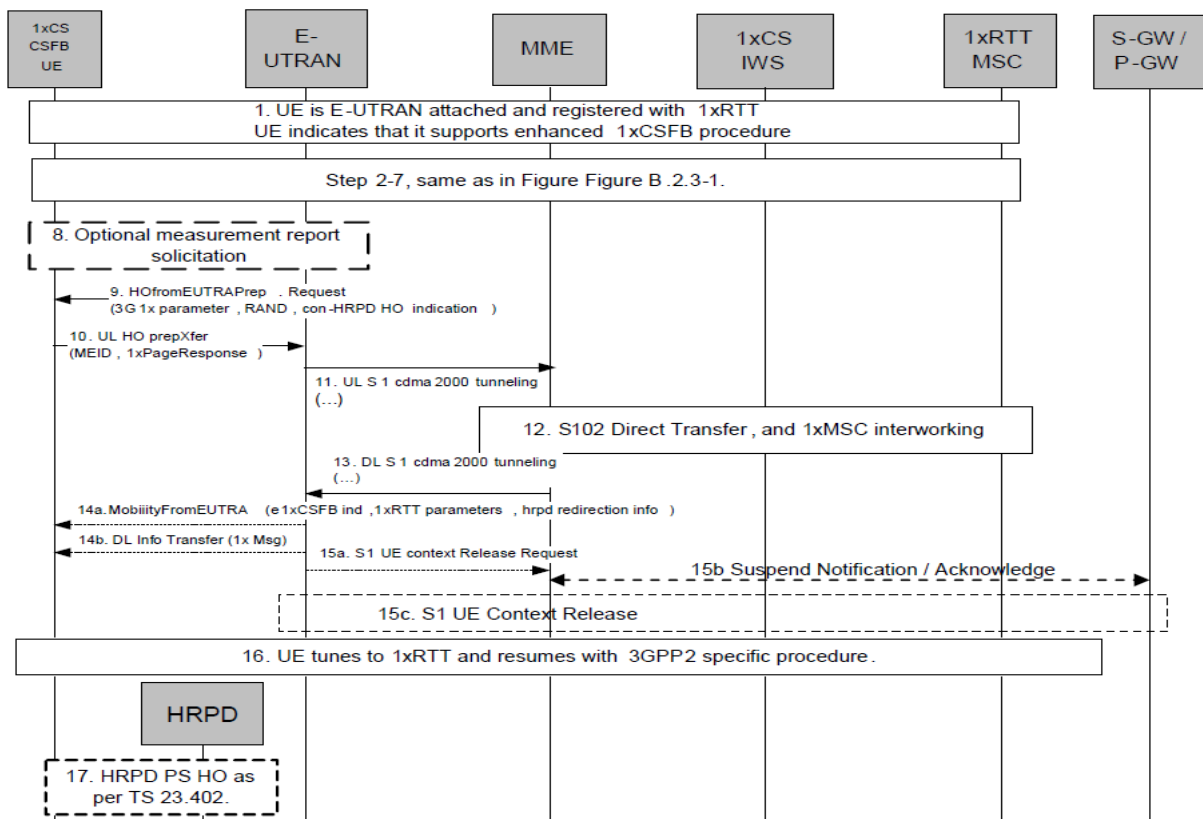

Figure B.2.3a.4-1: Enhanced CS fallback to 1xRTT MT Call with no PS handover, or with concurrent non-optimised PS handover or optimised idle-mode PS handover

UE is E-UTRAN attached and pre-registered with 1xRTT CS as defined in clause B.2.1.1 with enhanced CS fallback to 1xRTT capability indication to E-UTRAN. The UE may also indicate that it supports concurrent 1xRTT and HRPD capability. The UE may also be pre-registered with HRPD access using procedures defined in TS 23.402 [27], clause 9.3.1. The UE may also indicate support of enhanced CS fallback to 1xRTT for dual receiver/transmitter configuration to E-UTRAN.

2.-7. Same as step 2-7 in figure B.2.3-1.

If priority indication is included in the S1AP UE Context Setup or modification message from the MME to the E-UTRAN, the E-UTRAN shall not initiate enhanced 1xCSFB with concurrent optimized PS handover to HRPD access.

8.-17. Same as steps 5 – 12 of Figure B.2.3a.2-1, with the modifications that the 1x message in step 7 of Figure B.2.3a.2-1 provided by the UE to the E-UTRAN is a 1xPage Response message and 1x messages in step 9a of Figure B.2.3.a.2-1 (step 14a of Figure B.2.3a.4-1) provided by the E-UTRAN to UE may also contain Alert With Information message to provide caller line Identification and alerting trigger with 1x channel assignment message.

8.4.7.8.3 Test description

8.4.7.8.3.1 Pre-test conditions

System Simulator:

- Cell 1 is serving cell and Cell 19 is off.
- System information combination 6 as defined in TS 36.508 [18] clause 4.4.3.1 is used in E-UTRA cells.

UE:

None.

Preamble:

- The UE is in state Generic RB Established, pre-registered on 1xRTT (state 3C) on Cell 1 according to [18].

8.4.7.8.3.2 Test procedure sequence

Table 8.4.7.8.3.2-1 illustrates the downlink power levels and other changing parameters to be applied for the cells at various time instants of the test execution. Row marked "T0" denotes the initial conditions, while row marked "T1" is to be applied subsequently. The exact instants on which these values shall be applied are described in the texts in this clause.

Table 8.4.7.8.3.2-1: Cell configuration changes over time

	Parameter	Unit	Cell 1	Cell 19	Remark
T0	Cell-specific RS EPRE	dBm/15kHz	-60	-	Srxlev _{Cell 1} > 0 and Cell 19 is off such that camping on Cell 1 is guaranteed.
	I _{or} /I _{oc}	dB	-	-	
	Pilot Ec/I _{or}	dB	-	-	
	I _{oc}	dBm/1.23 MHz	-	-100	
	Pilot Ec/I _o (Note 1)	dB	-	-	
T1	Cell-specific RS EPRE	dBm/15kHz	-60	-	Cell 19 in on, with S _{ServingCell} > Thresh _{serv, low} and S _{nonServingCell, x} < Thresh _{x, low} .
	I _{or} /I _{oc}	dB	-	0	
	Pilot Ec/I _{or}	dB	-	-7	
	I _{oc}	dBm/1.23 MHz	-	-75	
	Pilot Ec/I _o (Note 1)	dB	-	-10	
Note 1: This parameter is not directly settable, but is derived by calculation from the other parameters set by the SS.					

Table 8.4.7.8.3.2-2: Main behaviour

St	Procedure	Message Sequence		TP	Verdict
		U - S	Message		
1	SS adjusts the cell power levels according to "T1" in Table 8.4.7.10.3.2-1.	-		-	-
2	Does the UE receive a tunnelled 1xRTT GCSNA Encapsulated General Page message on Cell 1?	<--	<i>DLInformationTransfer</i>	-	-
3	Check: Does the UE transmit an <i>ULInformationTransfer</i> containing an EXTENDED SERVICE REQUEST with Service Type IE set to "mobile terminating CS fallback or 1xCS fallback" on Cell 1?	-->	<i>ULInformationTransfer</i>	1	P
4	The SS transmits an <i>RRCCConnectionReconfiguration</i> message on Cell 1 to setup inter RAT measurement on Cell 19.	<--	<i>RRCCConnectionReconfiguration</i>	-	-
5	The UE transmits an <i>RRCCConnectionReconfigurationComplete</i> message on Cell 1 to confirm the setup of inter RAT measurement.	-->	<i>RRCCConnectionReconfigurationComplete</i>	-	-
6	The UE transmits a <i>MeasurementReport</i> message on Cell 1 to report event B2 for Cell 19.	-->	<i>MeasurementReport</i>	-	-
7	The SS transmits a <i>HandoverFromEUTRAPreparationRequest</i> on Cell 1.	<--	<i>HandoverFromEUTRAPreparationRequest</i>	-	-
8	Check: Does the UE transmit a tunnelled 1xRTT GCSNA Encapsulated Page Response message contained in an <i>ULHandoverPreparationTransfer</i> message on Cell 1?	-->	<i>ULHandoverPreparationTransfer</i>	2	P
9	The SS transmits a tunnelled 1xRTT GCSNA Encapsulated ECAM message contained in a <i>MobilityFromEUTRACommand</i> on Cell1 to order the UE to perform inter RAT to Cell 19.	<--	<i>MobilityFromEUTRACommand</i>	-	-
10	Check: Does UE send the <i>Page Response</i> on Cell 19?	-->	<i>Page Response</i>	3	P
11	The SS transmits an <i>Extended Channel Assignment</i> message on Cell 19.	<--	<i>Extended Channel Assignment</i>	-	-
12	After the SS detects that Traffic Channel Initialization is successful, it transmits an <i>Acknowledgement Order</i> message on Cell 19.	<--	<i>Acknowledgement Order</i>		
13	The SS transmits a <i>Service Connect</i> message on Cell 19.	<--	<i>Service Connect</i>		
14	The UE transmits a <i>Service Connect Completion</i> message on Cell 19.	-->	<i>Service Connect Completion</i>		

8.4.7.8.3.3 Specific message contents

Table 8.4.7.8.3.3-1: DLInformationTransfer (Step 2, Table 8.4.7.8.3.2-2)

Derivation Path: 36.508 Table 4.6.1-3			
Information Element	Value/remark	Comment	Condition
DLInformationTransfer ::= SEQUENCE {			
criticalExtensions CHOICE {			
c1 CHOICE {			
dlInformationTransfer-r8 SEQUENCE {			
dedicatedInfoType CHOICE {			
dedicatedInfoCDMA2000-1XRTT	Set according to Table 8.4.7.8.3.3-2	1xRTT GCSNA Encapsulated General Page	
}			
}			
}			
}			
}			

Table 8.4.7.8.3.3-2: 1xRTT GCSNA Encapsulated General Page (Step 2, Table 8.4.7.8.3.2-2)

Field	Value/remark	Comment	Condition
MessageID	'00000001'B	GCSNA1xCircuitService message	
GCSNAOption	'00000001'B		
AlternativeGCSNAOption_INCL	'0'B		
IWSIDIncl	'0'B		
AckRequired	'0'B		
StopDupDetect	'0'B		
MessageSequence	Set by SS		
NumTLACEncapsulated1xL3PDU	'00'B		
Reserved	'0000'B		
1xLogicalChannel	'0'B		
1xProtocolRevision	Set by UE		
MsgType	'00010001'B	General Page Message	
NumTLACHeaderRecords	'0000'B		
Reserved	'000'B		
1xL3PDULength	16 bits, Set by SS		
PDU		1x L3 PDU	
Service_Option	16 bits, Set by SS		

Table 8.4.7.8.3.3-3: ULInformationTransfer (Step 3, Table 8.4.7.8.3.2-2)

Derivation Path: 36.508 Table 4.6.1-25			
Information Element	Value/remark	Comment	Condition
ULInformationTransfer ::= SEQUENCE {			
criticalExtensions CHOICE {			
c1 CHOICE {			
ulInformationTransfer-r8 SEQUENCE {			
dedicatedInfoType CHOICE {			
dedicatedInfoNAS	Set according to Table 8.4.7.8.3.3-4	EXTENDED SERVICE REQUEST	
}			
}			
}			
}			
}			

Table 8.4.7.8.3.3-4: EXTENDED SERVICE REQUEST (Step 3, Table 8.4.7.8.3.2-2)

Derivation Path: 36.508 Table 4.7.2-14A			
Information Element	Value/remark	Comment	Condition
Protocol discriminator	EMM		
Service type	'0001'B	mobile terminating CS fallback or 1xCS fallback	
CSFB response	'001'B	CS fallback accepted by the UE	

Table 8.4.7.8.3.3-5: RRCConnectionReconfiguration (Step 4, Table 8.4.7.8.3.2-2)

Derivation Path: 36.508, Table 4.6.1-8, condition MEAS
--

Table 8.4.7.8.3.3-6: MeasConfig (Step 4, Table 8.4.7.8.3.2-2)

Derivation Path: 36.508, Table 4.6.6-1			
Information Element	Value/remark	Comment	Condition
MeasConfig ::= SEQUENCE {			
measObjectToAddModList SEQUENCE (SIZE (1..maxObjectId)) OF SEQUENCE {	2 entries		
measObjectId[1]	IdMeasObject-f17		
measObject[1]	MeasObjectCDMA2000-GENERIC		
measObjectId[2]	IdMeasObject-f1		
measObject[2]	MeasObjectEUTRA-GENERIC(f1)		
}			
reportConfigToAddModList SEQUENCE (SIZE (1..maxReportConfigId)) OF SEQUENCE {	1 entry		
reportConfigId[1]	IdReportConfig-B2-CDMA2000		
reportConfig[1]	ReportConfigInterRAT-B2-CDMA2000(-69, -18)		
}			
measIdToAddModList SEQUENCE (SIZE (1..maxMeasId)) OF SEQUENCE {	1 entry		
measId[1]	1		
measObjectId[1]	IdMeasObject-f17		
reportConfigId[1]	IdReportConfig-B2-CDMA2000		
}			
quantityConfig SEQUENCE {			
quantityConfigEUTRA	Not present		
quantityConfigUTRA	Not present		
quantityConfigGERAN	Not present		
quantityConfigCDMA2000 SEQUENCE {			
measQuantityCDMA2000	pilotPnPhaseAndPilotStrength		
}			
}			
measGapConfig CHOICE {			
setup SEQUENCE {			
gapOffset CHOICE {			
gp1	30		
}			
}			
}			
}			
}			
}			

Table 8.4.7.8.3-7: MeasObjectCDMA2000-GENERIC (Step 4, Table 8.4.7.8.3.2-2)

Derivation Path: 36.508, Table 4.6.6-1C			
Information Element	Value/remark	Comment	Condition
MeasObjectCDMA2000-GENERIC ::= SEQUENCE {			
cdma2000-Type	Type1XRTT		
CarrierFreqCDMA2000 SEQUENCE {			
bandClass	Band Class of frequency under test		
arfcn	f17		
}			
SearchWindowSize	15		
offsetFreq	db0		
cellsToRemoveList	Not present		
cellsToAddModList CHOICE {}	Cell 19		
cellForWhichToReportCGI	Not present		
}			

Table 8.4.7.8.3.3-8: MeasurementReport (Step 6, Table 8.4.7.8.3.2-2)

Derivation Path: 36.508, Table 4.6.1-5			
Information Element	Value/remark	Comment	Condition
MeasurementReport ::= SEQUENCE {			
criticalExtensions CHOICE {			
c1 CHOICE{			
measurementReport-r8 SEQUENCE {			
measResults SEQUENCE {			
measId	1		
measResultServCell SEQUENCE {			
rsrpResult	(0..97)		
rsrqResult	(0..34)		
}			
measResultNeighCells CHOICE {			
measResultsCDMA2000 ::=SEQUENCE {			
preRegistrationStatusHRPD	FALSE		
measResultListCDMA2000 ::=SEQUENCE (SIZE (1..maxCellReport)) OF SEQUENCE {	1 entry		
physCellId[1]	PhysicalCellIdentity of Cell 19		
cgi-Info[1]	Not present		
measResult[1] SEQUENCE {			
pilotPnPhase	(0..32767)		
pilotStrength	(0..63)		
}			
}			
}			
}			
}			

Table 8.4.7.8.3.3-9: HandoverFromEUTRAPreparationRequest (Step 7, Table 8.4.7.8.3.2-2)

Derivation Path: 36.508 Table 4.6.1-4			
Information Element	Value/remark	Comment	Condition
HandoverFromEUTRAPreparationRequest ::= SEQUENCE {			
criticalExtensions CHOICE {			
c1 CHOICE {			
handoverFromEUTRAPreparationRequest-r8 SEQUENCE {			
cdma2000-Type	Type1XRTT		
Rand	Set by SS	Random Challenge Data as broadcast on Cell 19	
mobilityParameters	Set according to 36.508 Table 4.5.2C.4-6	CDMA2000Parameters	
}			
}			
}			

Table 8.4.7.8.3.3-10: ULHandoverPreparationTransfer (Step 8, Table 8.4.7.8.3.2-2)

Derivation Path: 36.508 Table 4.6.1-24			
Information Element	Value/remark	Comment	Condition
ULHandoverPreparationTransfer ::= SEQUENCE {			
criticalExtensions CHOICE {			
c1 CHOICE {			
ulHandoverPreparationTransfer-r8 SEQUENCE {			
cdma2000-Type	Type1XRTT		
Meid	UE's meid		
dedicatedInfo	Set according to Table 8.4.7.8.3.3-11	1xRTT GCSNA Encapsulated Page Response message	
}			
}			
}			

Table 8.4.7.8.3.3-11: 1xRTT GCSNA Encapsulated Page Response (Step 8, Table 8.4.7.8.3.2-2)

Information Element	Value/remark	Comment	Condition
MessageID	'00000001'B	GCSNA1xCircuitService message	
GCSNAOption	'00000001'B		
AlternativeGCSNAOption_INCL	'0'B		
IWSIDIncl	'0'B		
AckRequired	'0'B		
StopDupDetect	'0'B		
MessageSequence	6 bits, Set by UE		
NumTLACEncapsulated1xL3PDU	'00'B		
Reserved	'0000'B		
1xLogicalChannel	'0'B		
1xProtocolRevision	'00000110'B		
MsgType	'00000101'B	Page Response message	this value shall be verified by TTCN
NumTLACHeaderRecords	'0001'B		
TLACHeaderRecordType	'0000'B		
TLACHeaderRecordLength	8 bits, Set by UE		
MSID_TYPE	3 bits, Set by UE	Should be matched with PREF_MSID_TYPE	
MSID_LEN	4 bits, Set by UE		
MSID	Variable, Set by UE		
Reserved	'0000000'B		
1xL3PDULength	16 bits, Set by UE		
MOB_TERM	'1'B		
SLOT_CYCLE_INDEX	'010'B		
MOB_P_REV	8 bits, Set by UE		
SCM	8 bits, Set by UE		
REQUEST_MODE	'001'B		
SERVICE_OPTION	16 bits, Set by UE		
PM	'0'B		
NAR_AN_CAP	'0'B		
ENCRYPTION_SUPPORTED	'0000'B		
NUM_ALT_SO	'000'B		
UZID_INCL	'0'B		
CH_IND	'0'B		
OTD_SUPPORTED	'0000'B		
QPCH_SUPPORTED	'0'B		
ENHANCED_RC	'0'B		
FOR_RC_PREF	'0000'B		
REV_RC_PREF	'0'B		
FCH_SUPPORTED	'0'B		
FCH Capability Type-specific fields	Variable		
DCCH_SUPPORTED	'1'B		
REV_FCH_GATING_REQ	'0'B		

Table 8.4.7.8.3.3-12: MobilityFromEUTRACommand (Step 9, Table 8.4.7.8.3.2-2)

Derivation Path: 36.508, Table 4.6.1-6			
Information Element	Value/remark	Comment	Condition
MobilityFromEUTRACommand ::= SEQUENCE {			
criticalExtensions CHOICE {			
c1 CHOICE{			
mobilityFromEUTRACommand-r9 SEQUENCE {			
csFallbackIndicator	False		
purpose CHOICE{			
e-CSFB-r9 SEQUENCE {			
messageContCDMA2000-1XRTT-r9	Set according to Table 8.4.7.8.3.3-13	1xRTT GCSNA Encapsulated ECAM message	
}			
}			
}			
}			
}			
}			

Table 8.4.7.8.3.3-13: 1xRTT GCSNA Encapsulated ECAM message (Step 9, Table 8.4.7.8.3.2-2)

Information Element	Value/remark	Comment	Condition
MessageID	'00000001'B		
GCSNAOption	'00000001'B		
AlternativeGCSNAOption_INCL	'0'B		
IWSIDIncl	'0'B		
AckRequired	'0'B		
StopDupDetect	'0'B		
MessageSequence	Set by SS		
NumTLACEncapsulated1xL3PDU	'00'B		
Reserved	'0000'B		
1xLogicalChannel	'0'B		
1xProtocolRevision	'00001001'B		
MsgType	'00010101'B	Extended Channel Assignment Message	
NumTLACHeaderRecords	'0000'B		
Reserved	'000'B		
1xL3PDULength	16 bits, Set by SS		
ASSIGN_MODE	'001'B		
RESPOND	'1'B		
FREQ_INCL	'1 'B		
BAND_CLASS	11 bits, Frequency under test		
CDMA_FREQ	'00000110'B		
NUM_PILOTS	6 bits, Set by SS		
PILOT_PN	9 bits, Set by SS		

Table 8.4.7.8.3.3-14: *Page Response* (step 10, Table 8.4.7.8.3.2-2)

Information Element	Value/remark	Comment	Condition
PD	'01'B		
MSG_ID	'000101'B	Page Response Message	this value shall be verified by TTCN
LAC Length Field	5 bits, Set by UE		
ACK_SEQ	3 bits, Set by UE		
MSG_SEQ	3 bits, Set by UE		
ACK_REQ	'1'B		
VALID_ACK	'1'B		
ACK_TYPE	'010'B		
MSID_TYPE	3 bits, Set by UE		
MSID_LEN	4 bits, Set by UE		
MSID	Variable, Set by UE		
LAC Padding Field	0 to 7, Set by UE		
ACTIVE_PILOT_STRENGTH	6 bits, set by UE		
FIRST_IS_ACTIVE	1 bit, set by UE		
FIRST_IS_PTA	1 bit, set by UE		
NUM_ADD_PILOTS	'0'B		
MOB_TERM	'1'B		
SLOT_CYCLE_INDEX	'010'B		
MOB_P_REV	8 bits, Set by UE		
SCM	8 bits, Set by UE		
REQUEST_MODE	'001'B		
SERVICE_OPTION	16 bits, Set by UE		
PM	'0'B		
NAAR_AN_CAP	'0'B		
NUM_ALT_SO	'000'B		
UZID_INCL	'0'B		
CH_IND	'01'B		
OTD_SUPPORTED	'1'B		
QPCH_SUPPORTED	'1'B		
ENHANCED_RC	'1'B		
FOR_RC_PREF	'00011'B		
REV_RC_PREF	'00011'B		
FCH_SUPPORTED	'1'B		
FCH_FRAME_SIZE	'0'B		
FOR_FCH_LEN	3 bits, Set by UE		
FOR_FCH_RC_MAP	Variable, Set by UE		
REV_FCH_LEN	3 bits, Set by UE		
REV_FCH_RC_MAP	Variable, Set by UE		
DCCH_SUPPORTED	'1'B		
REV_FCH_GATING_REQ	'0'B		

Table 8.4.7.8.3.3-15: Extended Channel Assignment (step 11, Table 8.4.7.8.3.2-2)

Field	Value/remark	Comment	Condition
MSG_TYPE	'00010101'B	Extended Channel Assignment Message	
ACK_SEQ	3 bits, Set by UE		
MSG_SEQ	3 bits, Set by UE		
ACK_REQ	'0'B		
VALID_ACK	'1'B		
ADDR_TYPE	3 bits, Set by UE		
ADDR_LEN	4 bits, Set by UE		
ADDRESS	Variable, Set by UE		
RESERVED_1	'0'B		
ADD_RECORD_LEN	8 bits, Set by UE		
ASSIGN_MODE	'100'B	Traffic Channel Assignment	
RESERVED_2	'00000'B		
BAND_CLASS	5 bits, Set by SS		
CDMA_FREQ	11 bits, Set by SS		
BYPASS_ALERT_ANSWER	'1'B		
GRANTED_MODE	'10'B		
DEFAULT_CONFIG	'100'B		
FOR_RC	'00011'B		
REV_RC	'00011'B		
FRAME_OFFSET	4 bits, Set by SS		
ENCRYPT_MODE	'00'B		
FPC_SUBCHAN_GAIN	'00001'B		
RLGAIN_ADJ	0000'B		
NUM_PILOTS	'000'B		
CH_IND	'01'B		
CH_RECORD_LEN	5 bits, Set by SS		
CH_RECORD_FIELDS	Variable, Set by SS		
REV_FCH_GATING_MODE	'0'B		
RESERVED	0 – 7 bits, Set by UE		
PDU_PADDING	0 – 7 bits, Set by UE		

Table 8.4.7.8.3.3-16: Acknowledgment Order (step 12, Table 8.4.7.8.3.2-2)

Field	Value/remark	Comment	Condition
MSG_TYPE	'00000001'B	Order Message	
ACK_SEQ	3 bits, Set by SS		
MSG_SEQ	3 bits, Set by SS		
ACK_REQ	'1'B		
ENCRYPTION	'00'B		
ORDER	'010000'B	Base Station Acknowledgment Order	
ORDQ	'00000000'B		

Table 8.4.7.8.3.3-17: Service Connect (step 13, Table 8.4.7.8.3.2-2)

Field	Value/remark	Comment	Condition
MSG_TYPE	'00010100'B	Service Connect Message	
ACK_SEQ	3 bits, Set by SS		
MSG_SEQ	3 bits, Set by SS		
ACK_REQ	'1'B		
ENCRYPTION	'00'B		
USE_TIME	'0'B		
ACTION_TIME	'000000'B		
SERV_CON_SEQ	Set by SS		
RESERVED	'00000'B		
RECORD_TYPE	'00000111'B		
RECORD_LEN	8 bits, Set by SS		
Type-specific fields	Variable, Set by SS		
RECORD_TYPE	'00010011'B		
RECORD_LEN	8 bits, Set by SS		
Type-specific fields	Variable, Set by SS		
PDU_PADDING	0-7 bits, Set by SS		

Table 8.4.7.8.3.3-18: Service Connect Completion (step 14, Table 8.4.7.8.3.2-2)

Field	Value/remark	Comment	Condition
MSG_TYPE	'00001110'B	Service Connect Completion Message	this value shall be verified by TTCN
ACK_SEQ	3 bits, Set by UE		
MSG_SEQ	3 bits, Set by UE		
ACK_REQ	'1'B		
ENCRYPTION	'00'B		
RESERVED	'0'B		
SERV_CON_SEQ	Same value as SERV_CON_SEQ received in Service Connect Message (Table 8.4.7.8.3.3-17)		
PDU_PADDING	0-7 bits, Set by UE		

8.4.7.9 Pre-registration at 1xRTT and inter-RAT Handover / Enhanced CS fallback from E-UTRA RRC_CONNECTED to 1xRTT / Extended Service Reject / MO call

8.4.7.9.1 Test Purpose (TP)

(1)

```
with { UE in E-UTRA RRC_CONNECTED state and having completed the 1xRTT CS pre-registration procedure }
ensure that {
  when { a voice call is originated at the UE }
  then { UE transmits an EXTENDED SERVICE REQUEST message with Service Type IE set to "mobile originating CS fallback or 1xCS fallback" }
}
```

(2)

```
with { UE having transmitted an ULInformationTransfer message containing an EXTENDED SERVICE REQUEST message with Service Type IE set to "mobile originating CS fallback or 1xCS fallback" }
ensure that {
  when { UE receives SERVICE REJECT message with cause_value = EMM cause #22 in a DLInformationTransfer message }
  then { UE tunes to 1xRTT cell, transmits a 1xRTT Origination message on the 1xRTT cell and establishes the call }
}
```

8.4.7.9.2 Conformance requirements

References: The conformance requirements covered in the present TC are specified in: TS 23.272, clause B.2.3b.2.

[TS 23.272, clause B.2.3b.2]

The following figure describes the mobile originating or mobile terminating call rejected by the MME procedures for the enhanced CS Fallback to 1xRTT.

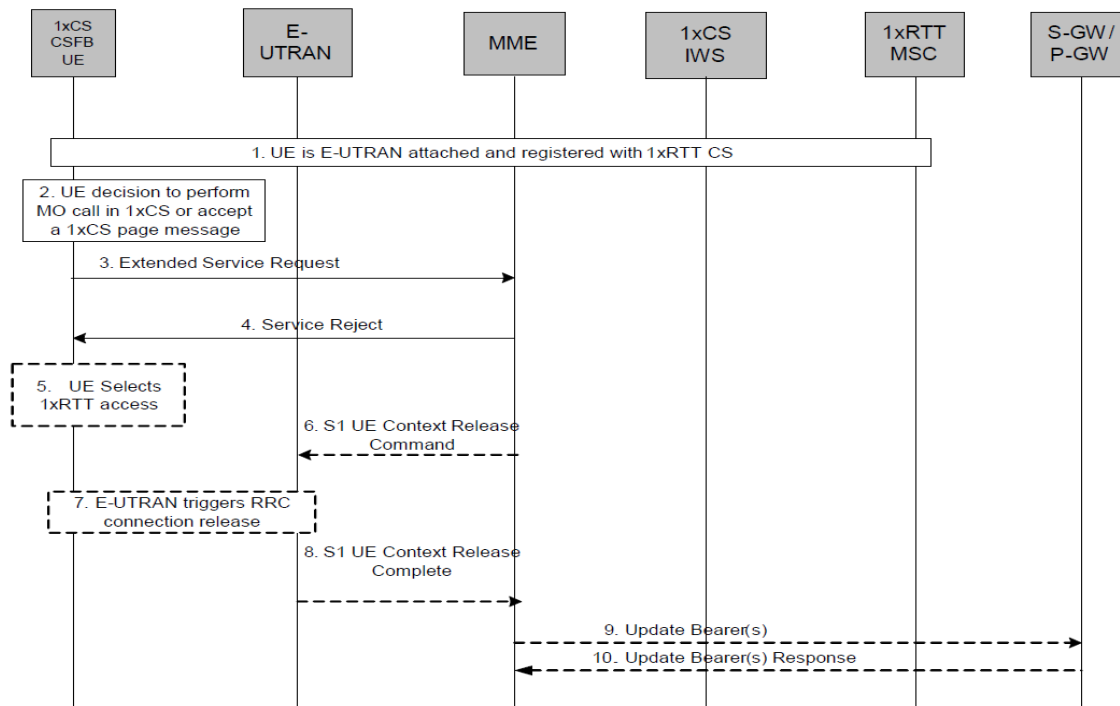

Figure B.2.3b-1: 1xCSFB MO or MT call, rejected by MME

1. UE is E-UTRAN attached and pre-registered with 1xRTT CS as defined in clause B.2.1.1.
2. UE makes a decision to perform a mobile originated CS call or accepts CS paging for the CS Fallback to 1xRTT (Step 6a, Clause 5.2.3).
3. UE sends an Extended Service Request for mobile originating/mobile terminating 1xCS fallback to the MME.
4. If the MME decides to reject the Extended Service Request, the MME sends a Service Reject message to the UE. Steps 5 – 10 are executed when Service Reject is sent with a reason code which results in the UE selecting 1xRTT access, as specified in TS 24.301 [34].
5. The UE selects 1xRTT access without waiting for RRC Release.
6. The MME releases S1 by sending the S1 UE Context Release Command (Cause) message to the eNodeB. Cause value indicates that the release is triggered by CS Fallback procedure.
7. If the RRC connection is not already released, the E-UTRAN sends a RRC Connection Release message to the UE.
8. The E-UTRAN confirms the S1 Release by returning an S1 UE Context Release Complete message to the MME.
9. Depending on the reason for rejection, MME may start Suspend Notification:
 - - Suspend Notification: The S1-U bearers are released and the MME starts the preservation and suspension of non-GBR bearers and the deactivation of GBR bearers towards S-GW and P-GW(s).

- S-GW and P-GW(s) acknowledges the bearer updates Suspend Notification and marks the UE as suspended. The P-GW discards downlink data if the UE is marked as suspended.

8.4.7.9.3 Test description

8.4.7.9.3.1 Pre-test conditions

System Simulator:

- Cell 1 is serving cell and Cell 19 is off.
- System information combination 6 as defined in TS 36.508 [18] clause 4.4.3.1 is used in E-UTRA cells.

UE:

None.

Preamble:

- The UE is in state Generic RB Established, pre-registered on 1xRTT (state 3C) on Cell 1 according to [18].

8.4.7.9.3.2 Test procedure sequence

Table 8.4.7.9.3.2-1 illustrates the downlink power levels and other changing parameters to be applied for the cells at various time instants of the test execution. Row marked "T0" denotes the initial conditions, while row marked "T1" is to be applied subsequently. The exact instants on which these values shall be applied are described in the texts in this clause.

Table 8.4.7.9.3.2-1: Cell configuration changes over time

	Parameter	Unit	Cell 1	Cell 19	Remark
T0	Cell-specific RS EPRE	dBm/15kHz	-60	-	Srxlev _{Cell 1} > 0 and Cell 19 is off such that camping on Cell 1 is guaranteed.
	I _{or} /I _{oc}	dB	-	-	
	Pilot Ec/I _{or}	dB	-	-	
	I _{oc}	dBm/1.23 MHz	-	-100	
	Pilot Ec/I _o (Note 1)	dB	-	-	
T1	Cell-specific RS EPRE	dBm/15kHz	-60	-	Cell 19 is on, with S _{ServingCell} > Thresh _{serv, low} and S _{nonServingCell, x} < Thresh _{x, low} .
	I _{or} /I _{oc}	dB	-	0	
	Pilot Ec/I _{or}	dB	-	-7	
	I _{oc}	dBm/1.23 MHz	-	-75	
	Pilot Ec/I _o (Note 1)	dB	-	-10	
Note 1: This parameter is not directly settable, but is derived by calculation from the other parameters set by the SS.					

Table 8.4.7.9.3.2-2: Main behaviour

St	Procedure	Message Sequence		TP	Verdict
		U – S	Message		
1	SS adjusts cell levels according to row T1 of table 8.4.7.9.3.2-1				
2	A voice call is originated at the UE	-	-	-	-
3	Check: Does the UE transmit an <i>ULInformationTransfer</i> message containing an EXTENDED SERVICE REQUEST with Service Type IE set to "mobile originating CS fallback or 1xCS fallback" on Cell 1?	-->	<i>ULInformationTransfer</i>	1	P
4	SS sends a SERVICE REJECT message with the cause_value = EMM cause #22 in a <i>DLInformationTransfer</i> message on Cell 1	<--	<i>DLInformationTransfer</i>	-	-
-	The following messages are to be observed on Cell 19 unless explicitly stated otherwise	-	-	-	-
5	Check: Does the UE transmit an <i>Origination</i> message?	-->	<i>Origination</i>	2	P
6	The SS transmits an <i>Extended Channel Assignment</i> message.	<--	<i>ExtendedChannelAssignment</i>	-	--
7	After the SS detects that Traffic Channel Initialization is successful, it transmits an <i>Acknowledgement Order</i> message.	<--	<i>Acknowledgement Order</i>	-	-
8	The SS transmits a <i>Service Connect</i> message.	<--	<i>Service Connect</i>	-	-
9	Check: Does the UE transmits a <i>Service Connect Completion</i> message on Cell 19?	-->	<i>Service Connect Completion</i>	2	P

8.4.7.9.3.3 Specific message contents

Table 8.4.7.9.3.3-1: *ULInformationTransfer* (Step 3, Table 8.4.7.9.3.2-2)

Derivation Path: 36.508 Table 4.6.1-25			
Information Element	Value/remark	Comment	Condition
<i>ULInformationTransfer</i> ::= SEQUENCE {			
criticalExtensions CHOICE {			
c1 CHOICE {			
ulInformationTransfer-r8 SEQUENCE {			
dedicatedInfoType CHOICE {			
dedicatedInfoNAS	Set according to Table 8.4.7.9.3.3-2	EXTENDED SERVICE REQUEST	
}			
}			
}			
}			
}			

Table 8.4.7.9.3.3-2: *Extended Service Request* (Step 3, Table 8.4.7.9.3.2-2)

Derivation Path: 36.508 Table 4.7.2-14A			
Information Element	Value/remark	Comment	Condition
Protocol discriminator	EMM		
Service type	'0000'B	mobile originating CS fallback or 1xCS fallback	
CSFB response	Not present		

Table 8.4.7.9.3.3-3: DLInformationTransfer (Step 4, Table 8.4.7.9.3.2-2)

Derivation Path: 36.331 clause 6.2.2			
Information Element	Value/remark	Comment	Condition
ULInformationTransfer ::= SEQUENCE {			
Rrc-TransactionIdentifier	RRC-TransactionIdentifier-DL		
criticalExtensions CHOICE {			
c1 CHOICE {			
ullInformationTransfer-r8 SEQUENCE {			
dedicatedInfoType CHOICE {			
dedicatedInfoNAS	Set according to Table 8.4.7.9.3.3-4	Service Reject	
}			
nonCriticalExntesion SEQUENCE {}	Not present		
}			
}			
}			
}			

Table 8.4.7.9.3.3-4: Service Reject (Step 4, Table 8.4.7.9.3.2-2)

Derivation Path: 24.301 clause 8.2.24			
Information Element	Value/remark	Comment	Condition
Protocol discriminator	EMM		
Security header type	'0000'B	Plain NAS message, not security protected	
Service reject message identity	'0100 1110'B	Service Reject	
EMM cause	EMM cause #22		
T3442 value	Not present		

Table 8.4.7.9.3.3-6: *Origination* (step 5, Table 8.4.7.9.2-2)

Field	Value/remark	Comment	Condition
PD	'00'B		
MSG_ID	'000100'B	Origination Message	this value shall be verified by TTCN
LAC Length Field	5 bits, Set by UE		
ACK_SEQ	3 bits, Set by UE		
MSG_SEQ	3 bits, Set by UE		
ACK_REQ	'1'B		
VALID_ACK	'0'B		
ACK_TYPE	'010'B		
MSID_TYPE	3 bits, Set by UE		
MSID_LEN	4 bits, Set by UE		
MSID	Variable, Set by UE		
LAC Padding Field	0 to 7, Set by UE		
ACTIVE_PILOT_STRENGTH	6 bits, set by UE		
FIRST_IS_ACTIVE	1 bit, set by UE		
FIRST_IS_PTA	1 bit, set by UE		
NUM_ADD_PILOTS	'0'B		
MOB_TERM	'1'B		
SLOT_CYCLE_INDEX	'010'B		
MOB_P_REV	8 bits, Set by UE		
SCM	8 bits, Set by UE		
REQUEST_MODE	'001'B		
SPECIAL_SERVICE	'1'B		
SERVICE_OPTION	16 bits, Any value mapping to a voice service option		
PM	'0'B		
DIGIT_MODE	'0'B		
NUMBER_TYPE	3 bits, Set by UE		
NUMBER_PLAN	4 bits, Set by UE		
MORE_FIELDS	'0'B		
NUM_FIELDS	8 bits, Set by UE		
CHAR _i	Variable, Set by UE		
NAR_AN_CAP	'0'B		
PACA_REORIG	'0'B		
RETURN_CAUSE	'0000'B		
MORE_RECORDS	'0'B		
ENCRYPTION_SUPPORTED	'0000'B		
PACA_SUPPORTED	'0'B		
NUM_ALT_SO	'000'B		
DRS	'1'B		
UZID_INCL	'0'B		
CH_IND	'01'B		
SR_ID	3 bits, Set by UE		
OTD_SUPPORTED	'1'B		
QPCH_SUPPORTED	'1'B		
ENHANCED_RC	'1'B		
FOR_RC_PREF	'00011'B		
REV_RC_PREF	'00011'B		
FCH_SUPPORTED	'1'B		
FCH_FRAME_SIZE	'0'B		
FOR_FCH_LEN	3 bits, Set by UE		
FOR_FCH_RC_MAP	Variable, Set by UE		
REV_FCH_LEN	3 bits, Set by UE		
REV_FCH_RC_MAP	Variable, Set by UE		
DCCH_SUPPORTED	'1'B		
RESERVED	'0'B		
REV_FCH_GATING_REQ	'0'B		

Table 8.4.7.9.3.3-7: Extended Channel Assignment (step 6, Table 8.4.7.9.2-2)

Field	Value/remark	Comment	Condition
MSG_TYPE	'010101'B	Extended Channel Assignment Message	
ACK_SEQ	3 bits, Set by UE		
MSG_SEQ	3 bits, Set by UE		
ACK_REQ	'0'B		
VALID_ACK	'1'B		
ADDR_TYPE	3 bits, Set by UE		
ADDR_LEN	4 bits, Set by UE		
ADDRESS	Variable, Set by UE		
RESERVED_1	'0'B		
ADD_RECORD_LEN	8 bits, Set by UE		
ASSIGN_MODE	'100'B	Traffic Channel Assignment	
RESERVED_2	'00000'B		
BAND_CLASS	5 bits, Set by SS		
CDMA_FREQ	11 bits, Set by SS		
BYPASS_ALERT_ANSWER	'1'B		
GRANTED_MODE	'10'B		
DEFAULT_CONFIG	'100'B		
FOR_RC	'00011'B		
REV_RC	'00011'B		
FRAME_OFFSET	4 bits, Set by SS		
ENCRYPT_MODE	'00'B		
FPC_SUBCHAN_GAIN	'00001'B		
RLGAIN_ADJ	0000'B		
NUM_PILOTS	'000'B		
CH_IND	'01'B		
CH_RECORD_LEN	5 bits, Set by SS		
CH_RECORD_FIELDS	Variable, Set by SS		
REV_FCH_GATING_MODE	'0'B		
RESERVED	0 – 7 bits, Set by UE		
PDU_PADDING	0 – 7 bits, Set by UE		

Table 8.4.7.9.3.3-8: Acknowledgment Order (step 7, Table 8.4.7.9.2-2)

Field	Value/remark	Comment	Condition
MSG_TYPE	'00000001'B	Order Message	
ACK_SEQ	3 bits, Set by SS		
MSG_SEQ	3 bits, Set by SS		
ACK_REQ	'1'B		
ENCRYPTION	'00'B		
ORDER	'010000'B	Base Station Acknowledgment Order	
ORDQ	'00000000'B		

Table 8.4.7.9.3.3-9: Service Connect (step 8, Table 8.4.7.9.2-2)

Field	Value/remark	Comment	Condition
MSG_TYPE	'00010100'B	Service Connect Message	
ACK_SEQ	3 bits, Set by SS		
MSG_SEQ	3 bits, Set by SS		
ACK_REQ	'1'B		
ENCRYPTION	'00'B		
USE_TIME	'0'B		
ACTION_TIME	'000000'B		
SERV_CON_SEQ	Set by SS		
RESERVED	'00000'B		
RECORD_TYPE	'00000111'B		
RECORD_LEN	8 bits, Set by SS		
Type-specific fields	Variable, Set by SS		
RECORD_TYPE	'00010011'B		
RECORD_LEN	8 bits, Set by SS		
Type-specific fields	Variable, Set by SS		
PDU_PADDING	0-7 bits, Set by SS		

Table 8.4.7.9.3.3-10: Service Connect Completion (step 9, Table 8.4.7.9.2-2)

Information Element	Value/remark	Comment	Condition
MSG_TYPE	'00001110'B	Service Connect Completion Message	this value shall be verified by TTCN
ACK_SEQ	3 bits, Set by UE		
MSG_SEQ	3 bits, Set by UE		
ACK_REQ	'1'B		
ENCRYPTION	'00'B		
RESERVED	'0'B		
SERV_CON_SEQ	Same value as SERV_CON_SEQ received in Service Connect Message (Table 8.4.7.9.3.3-9)		
PDU_PADDING	0-7 bits, Set by UE		

8.4.7.10 Pre-registration at 1xRTT and inter-RAT Handover / Enhanced CS fallback from E-UTRA call failure – GCSNA with Release Order

8.4.7.10.1 Test Purpose (TP)

(1)

```
with { UE in E-UTRA RRC_CONNECTED state and having completed the 1xRTT CS pre-registration procedure }
ensure that {
  when { a voice call is originated at the UE }
  then { UE transmits an EXTENDED SERVICE REQUEST message with Service Type IE set to "mobile originating CS fallback or 1xCS fallback" }
}
```

(2)

```
with { UE having transmitted an ULInformationTransfer message containing an EXTENDED SERVICE REQUEST message with Service Type IE set to "mobile originating CS fallback or 1xCS fallback" }
ensure that {
  when { SS transmits HandoverFromEUTRAPreparationRequest message with cdma2000-type set to 'type1XRTT' }
  then { UE transmits an ULHandoverPreparationTransfer message containing a tunnelled 1xRTT GCSNA Encapsulated Origination message }
}
```

(3)

```

with { UE in E-UTRA RRC_CONNECTED state }
ensure that {
  when { UE receives a DLInformationTransfer message containing a tunnelled 1xRTT GCSNA Encapsulated Release Order message }
  then { UE ends a voice call origination procedure }
}
    
```

8.4.7.10.2 Conformance requirements

References: The conformance requirements covered in the present TC are specified in: TS 23.272, clause B.2.3a.2.

[TS 23.272, clause B.2.3a.2]

The following figure describes the mobile originating call procedures for the enhanced CS Fallback to 1xRTT with concurrent non-optimised PS handover or optimised idle-mode PS handover, or without concurrent PS handover, in the normal case. Clause B.2.3b describes the procedure when the procedure is rejected by the MME.

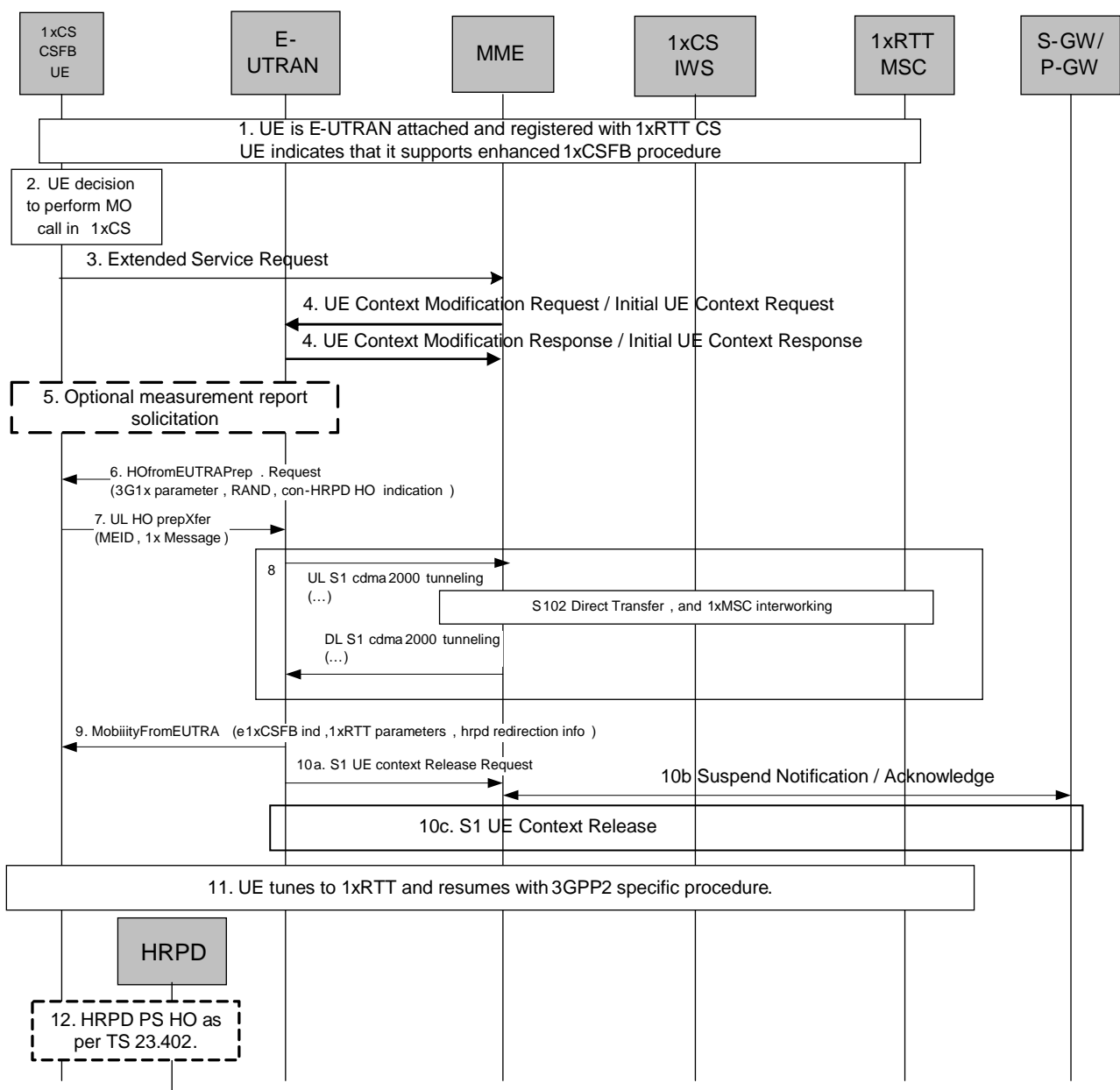

Figure B.2.3a.2-1: Enhanced CS fallback to 1xRTT MO Call with no PS handover, or with concurrent non-optimised PS handover or optimised idle-mode PS handover

1. UE is E-UTRAN attached and registered with 1xRTT CS as defined in clause B.2.1.1 with enhanced CS fallback to 1xRTT capability indication to the network. The UE may also indicate that it supports concurrent 1xRTT and HRPD capability. The UE may also be pre-registered with HRPD access using procedures defined in TS 23.402 [27], clause 9.3.1.
2. UE makes a decision to perform a mobile originated CS call.
3. UE sends an Extended Service Request (CS Fallback Indicator) to the MME.
4. For a UE in active mode, MME sends UE Context Modification Request (CS Fallback Indicator) to E-UTRAN. CS Fallback Indicator indicates to the E-UTRAN to move the UE to 1xRTT. E-UTRAN responds with UE Context Modification Response.

For a UE in idle mode, MME sends Initial UE Context Request (CS Fallback Indicator) to E-UTRAN. CS Fallback Indicator indicates to the E-UTRAN to move the UE to 1xRTT. E-UTRAN responds with Initial UE Context Response.

5. E-UTRAN may optionally solicit a 1xRTT measurement report from the UE to determine the target 1xRTT cell to which the CS Fallback will be performed.

If the network supports PS handover procedure to HRPD then E-UTRAN may optionally solicit an HRPD measurement report from the UE to determine whether the target HRPD candidates exist or not. If the network does not support PS handover procedure to HRPD or if no target HRPD candidates exist then E-UTRAN shall release the S1 UE context (see step 10a/b) after executing the enhanced CS fallback to 1xRTT procedure.

6. E-UTRAN sends a HandoverFromE-UTRANPreparation Request message to the UE to start the enhanced 1xCS fallback procedure. It includes 3G1x Overhead Parameters and RAND value. This message also includes an indication that concurrent HRPD handover preparation is not required.
7. The UE initiates signalling for establishment of the CS access leg by sending UL HandoverPreparation Transfer message which contains the 1xRTT Origination message with called party number.
8. Messages between MME and 1xIWS are tunnelled using the S102 interface. The 1xRTT MSC initiates the call with the called party number carried in the 1xRTT Origination message.
9. The E-UTRAN sends Mobility from EUTRA Command to the UE with indication that this is for enhanced 1x CS Fallback operation, 1xRTT related information, and optionally the HRPD redirection information. The 1xRTT information contains 1xRTT messages related to 1x channel assignment and cause the UE to tune to and acquire this 1x channel. This is perceived by the UE as a Handover Command message to 1xRTT. If 1xRTT CS network cannot support this CSFB request (for example due to resource availability), the DL information transfer message is sent instead, with an embedded 1x message that indicates failure to the UE.
 - For either concurrent non-optimised PS handover procedure or optimised idle-mode PS handover procedure along with enhanced CS fallback to 1xRTT, E-UTRAN may also redirect the UE to HRPD as part of this procedure. This is indicated by the HRPD redirection information in the Mobility from EUTRA Command.

10a/b/c. If PS handover procedure is not performed then E-UTRAN sends an S1 UE Context Release Request (Cause) message to the MME. Cause indicates that the S1 UE Context Release was caused by CS fallback to 1xRTT. The S1-U bearers are released and the MME starts the preservation and suspension of non-GBR bearers and the deactivation of GBR bearers towards S-GW and P-GW(s). The MME sets the UE context to suspended status.

11. UE retunes to the 1xRTT radio access network and performs 1x channel acquisition with the 1xRTT CS access (e.g. 1xRTT BSS).
12. UE and Network follow the appropriate procedure for handling non-optimised PS handover procedure or optimised idle-mode PS handover as defined in TS 23.402 [27] if performed. S1 UE Context release procedure is as specified in TS 23.402 [27] for non-optimised PS handover (clause 8.2.2) or optimised idle-mode PS handover (clause 9.4). This step occurs in parallel with step 11.

8.4.7.10.3 Test description

8.4.7.10.3.1 Pre-test conditions

System Simulator:

- Cell 1 and Cell 19.
- Cell 19 has a lower reselection priority than Cell 1.
- System information combination 6 as defined in TS 36.508 [18] clause 4.4.3.1 is used in E-UTRA cells.

UE:

None.

Preamble:

- The UE is in state Generic RB Established, pre-registered on 1xRTT (state 3C) on Cell 1 according to [18].

8.4.7.10.3.2 Test procedure sequence

Table 8.4.7.10.3.2-1 illustrates the downlink power levels and other changing parameters to be applied for the cells at various time instants of the test execution. Row marked "T0" denotes the initial conditions, while row marked "T1" is to be applied subsequently. The exact instants on which these values shall be applied are described in the texts in this clause.

Table 8.4.7.10.3.2-1: Cell configuration changes over time

	Parameter	Unit	Cell 1	Cell 19	Remark
T0	Cell-specific RS EPRE	dBm/15kHz	-60	-	S _r xlev _{Cell 1} > 0 and Cell 19 is off such that camping on Cell 1 is guaranteed.
	I _{or} /I _{oc}	dB	-	-	
	Pilot Ec/I _{or}	dB	-	-	
	I _{oc}	dBm/1.23 MHz	-	-	
	Pilot Ec/I _o (Note 1)	dB	-	-	
T1	Cell-specific RS EPRE	dBm/15kHz	-60	-	Cell 19 is on, with S _{ServingCell} > Thresh _{serv, low} and S _{nonServingCell, x} < Thresh _{x, low} .
	I _{or} /I _{oc}	dB	-	0	
	Pilot Ec/I _{or}	dB	-	-7	
	I _{oc}	dBm/1.23 MHz	-	-75	
	Pilot Ec/I _o (Note 1)	dB	-	-10	
Note 1: This parameter is not directly settable, but is derived by calculation from the other parameters set by the SS.					

Table 8.4.7.10.3.2-2: Main behaviour

St	Procedure	Message Sequence		TP	Verdict
		U - S	Message		
1	A voice call is originated at the UE	-	-	-	-
2	Check: Does the UE transmit an <i>ULInformationTransfer</i> containing an EXTENDED SERVICE REQUEST with Service Type IE set to "mobile originating CS fallback or 1xCS fallback" on Cell 1?	-->	<i>ULInformationTransfer</i>	1	P
3	The SS transmits an <i>RRCConnectionReconfiguration</i> message on Cell 1 to setup inter RAT measurement on Cell 19.	<--	<i>RRCConnectionReconfiguration</i>	-	-
4	The UE transmits an <i>RRCConnectionReconfigurationComplete</i> message on Cell 1 to confirm the setup of inter RAT measurement.	-->	<i>RRCConnectionReconfigurationComplete</i>	-	-
5	The UE transmits a <i>MeasurementReport</i> message on Cell 1 to report event B2 for Cell 19.	-->	<i>MeasurementReport</i>	-	-
6	The SS transmits a <i>HandoverFromEUTRAPreparationRequest</i> on Cell 1.	<--	<i>HandoverFromEUTRAPreparationRequest</i>	-	-
7	Check: Does the UE transmit a tunnelled <i>1xRTT GCSNA Encapsulated Origination</i> message contained in an <i>ULHandoverPreparationTransfer</i> message on Cell 1?	-->	<i>ULHandoverPreparationTransfer</i>	2	P
8	The SS transmits a tunnelled <i>1xRTT GCSNA Encapsulated Release Order</i> message contained in a <i>DLInformationTransfer</i> message on Cell1.	<--	<i>DLInformationTransfer</i>	-	-
9	The SS waits 5 seconds.			-	-
10-11	Check: Are the steps 1 to 2 of the Test procedure (TS 36.508 6.4.2.3) successfully executed?			3	P

8.4.7.10.3.3 Specific message contents

Table 8.4.7.10.3.3-1: *ULInformationTransfer* (Step 2, Table 8.4.7.10.3.2-2)

Derivation Path: 36.508 Table 4.6.1-25			
Information Element	Value/remark	Comment	Condition
<i>ULInformationTransfer</i> ::= SEQUENCE {			
criticalExtensions CHOICE {			
c1 CHOICE {			
ulInformationTransfer-r8 SEQUENCE {			
dedicatedInfoType CHOICE {			
dedicatedInfoNAS	Set according to Table 8.4.7.10.3.3-2	EXTENDED SERVICE REQUEST	
}			
}			
}			
}			
}			

Table 8.4.7.10.3.3-5: MeasObjectCDMA2000-GENERIC (Step 3, Table 8.4.7.10.3.2-2)

Derivation Path: 36.508, Table 4.6.6-1C			
Information Element	Value/remark	Comment	Condition
MeasObjectCDMA2000-GENERIC ::= SEQUENCE {			
cdma2000-Type	Type1XR TT		
CarrierFreqCDMA2000 SEQUENCE {			
bandClass	Band Class of frequency under test		
arfcn	f17		
}			
SearchWindowSize	15		
offsetFreq	db0		
cellsToRemoveList	Not present		
cellsToAddModList CHOICE {}	Cell 19		
cellForWhichToReportCGI	Not present		
}			

Table 8.4.7.10.3.3-6: MeasurementReport (Step 5, Table 8.4.7.10.3.2-2)

Derivation Path: 36.508, Table 4.6.1-5			
Information Element	Value/remark	Comment	Condition
MeasurementReport ::= SEQUENCE {			
criticalExtensions CHOICE {			
c1 CHOICE{			
measurementReport-r8 SEQUENCE {			
measResults SEQUENCE {			
measId	1		
measResultServCell SEQUENCE {			
rsrpResult	(0..97)		
rsrqResult	(0..34)		
}			
measResultNeighCells CHOICE {			
measResultsCDMA2000 ::=SEQUENCE {			
preRegistrationStatusHRPD	FALSE		
measResultListCDMA2000 ::=SEQUENCE (SIZE (1..maxCellReport)) OF SEQUENCE {	1 entry		
physCellId[1]	PhysicalCellIdentity of Cell 19		
cgi-Info[1]	Not present		
measResult[1] SEQUENCE {			
pilotPnPhase	(0..32767)		
pilotStrength	(0..63)		
}			
}			
}			
}			
}			
}			
}			
}			

Table 8.4.7.10.3.3-7: HandoverFromEUTRAPreparationRequest (Step 6, Table 8.4.7.10.3.2-2)

Derivation Path: 36.508 Table 4.6.1-4			
Information Element	Value/remark	Comment	Condition
HandoverFromEUTRAPreparationRequest ::= SEQUENCE {			
criticalExtensions CHOICE {			
c1 CHOICE {			
handoverFromEUTRAPreparationRequest-r8 SEQUENCE {			
cdma2000-Type	Type1XRTT		
Rand	Set by SS	Random Challenge Data as broadcast on Cell 19	
mobilityParameters	Set according to 36.508 Table 4.5.2C.4-6	CDMA2000Parameters	
}			
}			
}			

Table 8.4.7.10.3.3-8: ULHandoverPreparationTransfer (Step 7, Table 8.4.7.10.3.2-2)

Derivation Path: 36.508 Table 4.6.1-24			
Information Element	Value/remark	Comment	Condition
ULHandoverPreparationTransfer ::= SEQUENCE {			
criticalExtensions CHOICE {			
c1 CHOICE {			
ulHandoverPreparationTransfer-r8 SEQUENCE {			
cdma2000-Type	Type1XRTT		
Meid	UE's meid		
dedicatedInfo	Set according to Table 8.4.7.10.3.3-9	1xRTT GCSNA Encapsulated Origination message	
}			
}			
}			

Table 8.4.7.10.3.3-9: 1xRTT GCSNA Encapsulated Origination (Step 7, Table 8.4.7.10.3.2-2)

Information Element	Value/remark	Comment	Condition
MessageID	'00000001'B	GCSNA1xCircuitService message	
GCSNAOption	'00000001'B		
AlternativeGCSNAOption_INCL	'0'B		
IWSIDIncl	'0'B		
AckRequired	'0'B		
StopDupDetect	'0'B		
MessageSequence	Set by UE		
NumTLACEncapsulated1xL3PDU	'00'B		
Reserved	'0000'B		
1xLogicalChannel	'0'B		
1xProtocolRevision	'00000110'B		
MsgType	'00000100'B	Origination message	this value shall be verified by TTCN
NumTLACHeaderRecords	'0001'B		
TLACHeaderRecordType	'0000'B		
TLACHeaderRecordLength	4 bits, Set by UE		
MSID_TYPE	3 bits, Set by UE	Should be matched with PREF_MSID_TYPE	
MSID_LEN	4 bits, Set by UE		
MSID	Variable, Set by UE		
Reserved	'0000000'B		
1xL3PDULength	16 bits, Set by UE		
MOB_TERM	'1'B		
SLOT_CYCLE_INDEX	'010'B		
MOB_P_REV	8 bits, Set by UE		
SCM	8 bits, Set by UE		
REQUEST_MODE	'001'B		
SPECIAL_SERVICE	'1'B		
SERVICE_OPTION	16 bits, any value mapping to a voice service option		
PM	'0'B		
DIGIT_MODE	'0'B		
NUMBER_TYPE	3 bits, Set by UE		
NUMBER_PLAN	4 bits, Set by UE		
MORE_FIELDS	'0'B		
NUM_FIELDS	8 bits, Set by UE		
CHAR _i	Variable, Set by UE		
NAR_AN_CAP	'0'B		
PACA_REORIG	'0'B		
RETURN_CAUSE	'0000'B		
MORE_RECORDS	'0'B		
ENCRYPTION_SUPPORTED	'0000'B		
PACA_SUPPORTED	'0'B		
NUM_ALT_SO	'000'B		
DRS	'1'B		
UZID_INCL	'0'B		
CH_IND	'01'B		
SR_ID	3 bits, Set by UE		
OTD_SUPPORTED	'1'B		
QPCH_SUPPORTED	'1'B		
ENHANCED_RC	'1'B		
FOR_RC_PREF	'00011'B		
REV_RC_PREF	'00011'B		
FCH_SUPPORTED	'1'B		
FCH Capability Type-specific fields	Variable		
DCCH_SUPPORTED	'1'B		
RESERVED	'0'B		

REV_FCH_GATING_REQ	'0'B		
--------------------	------	--	--

Table 8.4.7.10.3.3-10: DLInformationTransfer (Step 8, Table 8.4.7.10.3.2-2)

Derivation Path: 36.508, Table 4.6.1-3			
Information Element	Value/remark	Comment	Condition
DLInformationTransfer ::= SEQUENCE {			
criticalExtensions CHOICE {			
c1 CHOICE {			
dlInformationTransfer-r8 SEQUENCE {			
dedicatedInfoType CHOICE {	False		
dedicatedInfoCDMA2000-1XRTT	Set according to Table 8.4.7.10.3.3-11	1xRTT GCSNA Encapsulated Release Order message	
}			
}			
}			
}			
}			

Table 8.4.7.10.3.3-11: 1xRTT GCSNA Encapsulated Release Order (Step 8, Table 8.4.7.10.3.2-2)

Information Element	Value/remark	Comment	Condition
MessageID	'00000001'B		
GCSNAOption	'00000001'B		
AlternativeGCSNAOption_INCL	'0'B		
IWSIDIncl	'0'B		
AckRequired	'0'B		
StopDupDetect	'0'B		
MessageSequence	Set by SS		
NumTLACEncapsulated1xL3PDU	'00'B		
Reserved	'0000'B		
1xLogicalChannel	'1'B		
1xProtocolRevision	'0000110'B		
MsgType	'0000111'B	Order message	
NumTLACHHeaderRecords	'0000'B		
Reserved	'000'B		
1xL3PDULength	8 bits, Set by SS		
ORDER	'010101'B		
ORDQ	'00000010'B	Release Order (with service inactive indication)	

8.5 RRC others

8.5.1 Radio link failure

8.5.1.1 Radio link failure / RRC connection re-establishment success

8.5.1.1.1 Test Purpose (TP)

(1)

```
with { UE in E-UTRA RRC_CONNECTED state }
ensure that {
  when { UE detecting physical layer problems }
  then { UE shall start timer T310 and UE does not initiate any RRC Connection re-establishment
procedure before expiring of timer T310 }
}
```

(2)

```
with { UE in E-UTRA RRC_CONNECTED state }
ensure that {
  when { UE detecting radio link failure on expiring of timer T310 }
  then { UE starts timer T311 and UE initiates the RRC Connection re-establishment procedure }
}
```

(3)

```
with { UE in E-UTRA RRC_CONNECTED state }
ensure that {
  when { UE successfully completes the RRC Connection re-establishment procedure }
  then { UE is in E-UTRA RRC_CONNECTED state }
}
```

8.5.1.1.2 Conformance requirements

References: The conformance requirements covered in the current TC are specified in TS 36.331, clauses 5.3.7.2, 5.3.10.1, 5.3.10.3 and 5.3.10.4.

[TS 36.331 clause 5.3.7.2]

The UE shall only initiate the procedure when AS security has been activated. The UE initiates the procedure when one of the following conditions is met:

- 1> upon detecting radio link failure, in accordance with 5.3.11; or
- 1> upon handover failure, in accordance with 5.3.5.6; or
- 1> upon mobility from E-UTRA failure, in accordance with 5.4.3.5; or
- 1> upon integrity check failure indication from lower layers; or
- 1> upon an RRC connection reconfiguration failure, in accordance with 5.3.5.5;

Upon initiation of the procedure, the UE shall:

- 1> stop timer T310, if running;
- 1> start timer T311;
- 1> suspend all RBs except SRB0;
- 1> reset MAC;
- 1> apply the default physical channel configuration as specified in 9.2.4;
- 1> apply the default semi-persistent scheduling configuration as specified in 9.2.3;
- 1> apply the default MAC main configuration as specified in 9.2.2;
- 1> perform cell selection in accordance with the cell selection process as specified in TS 36.304 [4];

[TS 36.331 clause 5.3.11.1]

The UE shall:

- 1> upon receiving N310 consecutive "out-of-sync" indications from lower layers while neither T300, T301, T304 nor T311 is running:
 - 2> start timer T310;

[TS 36.331 clause 5.3.11.3]

The UE shall:

- 1> upon T310 expiry; or

- 1> upon random access problem indication from MAC while neither T300, T301, T304 nor T311 is running; or
- 1> upon indication from RLC that the maximum number of retransmissions has been reached:
- 2> consider radio link failure to be detected;
- 2> if AS security has not been activated:
- 3> perform the actions upon leaving RRC_CONNECTED as specified in 5.3.12, with release cause ‘other’;
- 2> else:
- 3> initiate the connection re-establishment procedure as specified in 5.3.7;

8.5.1.1.3 Test description

8.5.1.1.3.1 Pre-test conditions

System Simulator:

- 2 cells on same E-UTRA frequency:
 - Cell 1 (default parameters) serving cell
 - Cell 2 intra-frequency cell

UE:

None.

Preamble:

- The UE is in state Generic RB Established (state 3) according to [18] on cell 1.

8.5.1.1.3.2 Test procedure sequence

Table 8.5.1.1.3.2-0: Time instances of cell power level and parameter changes

	Parameter	Unit	Cell 1	Cell 2
T1	Cell-specific RS EPRE	dBm/15k Hz	“Off”	-85
Power level “Off” is defined in TS36.508 Table 6.2.2.1-1.				

Table 8.5.1.1.3.2-1: Main behaviour

St	Procedure	Message Sequence		TP	Verdict
		U - S	Message		
1	The SS changes Cell 1 and Cell 2 parameters according to the row "T1" in table 8.5.1.1.3.2-0 in order that the radio link quality of Cell 1 is degraded and cell 2 is suitable for camping.	-	-	-	-
2	Check: Does the UE initiate an RRC connection re-establishment procedure on Cell 1 or Cell 2. This is checked during the time T=T310.	-	-	1	F
3	Check: Does the UE send <i>RRCCoRectionReestablishmentRequest</i> message on Cell 2?	-->	<i>RRCCoRectionReestablishmentRequest</i>	2	P
4	The SS transmits <i>RRCCoRectionReestablishment</i> message.	<--	<i>RRCCoRectionReestablishment</i>	-	-
5	The UE transmits <i>RRCCoRectionReestablishmentComplete</i> message.	-->	<i>RRCCoRectionReestablishmentComplete</i>	-	-
6	The SS transmits an <i>RRCCoRectionReconfiguration</i> message to resume existing radio bearer.	<--	<i>RRCCoRectionReconfiguration</i>	-	-
7	The UE transmits an <i>RRCCoRectionReconfigurationComplete</i> message.	-->	<i>RRCCoRectionReconfigurationComplete</i>	-	-
8	Check: Does the test result of generic test procedure in TS 36.508 subclause 6.4.2.3 indicate that the UE is in E-UTRA RRC_CONNECTED state on Cell 2?	-		3	P

8.5.1.1.3.3 Specific message contents

Table 8.5.1.1.3.3-1: *RRCCoRectionReestablishmentRequest* (step 3, Table 8.5.1.1.3.2-1)

Derivation Path: 36.508, Table 4.6.1-13			
Information Element	Value/remark	Comment	Condition
<i>RRCCoRectionReestablishmentRequest</i> ::= SEQUENCE {			
criticalExtensions CHOICE {			
<i>rrcCoRectionReestablishmentRequest-r8</i>			
SEQUENCE {			
ue-Identity SEQUENCE {			
c-RNTI	the value of the C-RNTI of the UE		
physCellId	PhysicalCellIdentity of Cell 1		
shortMAC-I	The same value as the 16 least significant bits of the XMAC-I value calculated by SS		
}			
reestablishmentCause	otherFailure		
}			
}			

Table 8.5.1.1.3.3-2: RRCConnectionReconfiguration (step 6, Table 8.5.1.1.3.2-1)

Derivation Path: 36.508, Table 4.6.1-8			
Information Element	Value/remark	Comment	Condition
RRCConnectionReconfiguration ::= SEQUENCE {			
criticalExtensions CHOICE {			
c1 CHOICE{			
rrcConnectionReconfiguration-r8 SEQUENCE {			
radioResourceConfigDedicated	RadioResourceConfigDe dicated-HO		
}			
}			
}			
}			

8.5.1.2 Radio link failure / T301 expiry

8.5.1.2.1 Test Purpose (TP)

(1)

```
with { UE in E-UTRA RRC_CONNECTED state }
ensure that {
  when { UE having sent an RRCConnectionReestablishmentRequest message on starting of timer T301 }
  then { UE goes to RRC_IDLE state after timer T301 is expired and trigger TAU procedure in order
to recover RRC connection}
}
```

8.5.1.2.2 Conformance requirements

References: The conformance requirements covered in the current TC are specified in TS 36.331, clauses 5.3.7.2, 5.3.7.3, 5.3.7.7, 5.3.11.1 and 5.3.11.3. The following represent an extraction of the requirements relevant to the test purpose.

[TS 36.331 clause 5.3.7.2]

The UE shall only initiate the procedure when AS security has been activated. The UE initiates the procedure when one of the following conditions is met:

- 1> upon detecting radio link failure, in accordance with 5.3.11; or
- 1> upon handover failure, in accordance with 5.3.5.6; or
- 1> upon mobility from E-UTRA failure, in accordance with 5.4.3.5; or
- 1> upon integrity check failure indication from lower layers; or
- 1> upon an RRC connection reconfiguration failure, in accordance with 5.3.5.5;

Upon initiation of the procedure, the UE shall:

- 1> stop timer T310, if running;
- 1> start timer T311;
- 1> suspend all RBs except SRB0;
- 1> reset MAC;
- 1> apply the default physical channel configuration as specified in 9.2.4;
- 1> apply the default semi-persistent scheduling configuration as specified in 9.2.3;
- 1> apply the default MAC main configuration as specified in 9.2.2;
- 1> perform cell selection in accordance with the cell selection process as specified in TS 36.304 [4];

[TS 36.331 clause 5.3.7.3]

Upon selecting a suitable E-UTRA cell, the UE shall:

- 1> stop timer T311;
- 1> start timer T301;
- 1> apply the *timeAlignmentTimerCommon* included in *SystemInformationBlockType2*;
- 1> initiate transmission of the *RRCConnectionReestablishmentRequest* message in accordance with 5.3.7.4;

NOTE: This procedure applies also if the UE returns to the source cell.

Upon selecting an inter-RAT cell, the UE shall:

- 1> perform the actions upon leaving RRC_CONNECTED as specified in 5.3.12, with release cause 'RRC connection failure';

[TS 36.331 clause 5.3.7.7]

The UE shall:

- 1> if timer T301 expires; or
- 1> if the selected cell becomes no longer suitable according to the cell selection criteria as specified in TS 36.304 [4];
- 2> perform the actions upon leaving RRC_CONNECTED as specified in 5.3.12, with release cause 'RRC connection failure';

[TS 36.331 clause 5.3.11.1]

The UE shall:

- 1> upon receiving N310 consecutive "out-of-sync" indications from lower layers while neither T300, T301, T304 nor T311 is running;
- 2> start timer T310;

[TS 36.331 clause 5.3.11.3]

The UE shall:

- 1> upon T310 expiry; or
- 1> upon random access problem indication from MAC while neither T300, T301, T304 nor T311 is running; or
- 1> upon indication from RLC that the maximum number of retransmissions has been reached:
 - 2> consider radio link failure to be detected;
 - 2> if AS security has not been activated:
 - 3> perform the actions upon leaving RRC_CONNECTED as specified in 5.3.12, with release cause 'other';
 - 2> else:
 - 3> initiate the connection re-establishment procedure as specified in 5.3.7;

8.5.1.2.3 Test description

8.5.1.2.3.1 Pre-test conditions

System Simulator:

- 2 cells on same E-UTRA frequency:
 - Cell 1 (default parameters) serving cell
 - Cell 2 intra-frequency cell

UE:

None.

Preamble:

- The UE is in state Generic RB Established (state 3) on Cell 1 according to [18].

8.5.1.2.3.2 Test procedure sequence

Table 8.5.1.2.3.2-1: Main behaviour

St	Procedure	Message Sequence		TP	Verdict
		U - S	Message		
1	The SS changes the power level of Cell 1 to non-suitable "Off" and changes the power level of Cell 2 to suitable according to TS 36.508 subclause 6.2.2.1 in order that the radio link quality of Cell 1 is degraded.	-	-	-	-
2	The UE sends <i>RRConnectionReestablishmentRequest</i> message on Cell 2.	-->	<i>RRConnectionReestablishmentRequest</i>	-	-
3	The SS does not respond to any <i>RRConnectionReestablishmentRequest</i> message for 2s (T301).	-	-	-	-
4-8	The UE will perform TAU procedure based on steps 1 to 5 of subclause 6.4.2.7 in TS 36.508 on Cell 2. NOTE: The UE performs a TAU procedure due to NAS signalling connection recovery.	-	-	-	-
9	Check: Does the test result of generic test procedure in TS 36.508 subclause 6.4.2.3 indicate that the UE is in E-UTRA RRC_CONNECTED state on Cell 2?	-	-	1	-
-	At the end of this test procedure sequence, the UE is in end state E-UTRA connected (E2_T3440) according to TS 36.508.	-	-	-	-

8.5.1.2.3.3 Specific message contents

Table 8.5.1.2.3.3-1: SystemInformationBlockType2 for Cell 2 (all steps)

Derivation path: 36.508 table 4.4.3.3-1			
Information Element	Value/Remark	Comment	Condition
SystemInformationBlockType2 ::= SEQUENCE {			
ue-TimersAndConstants SEQUENCE {			
t301	ms2000		
}			
}			

Table 8.5.1.2.3.3-2: *RRCConnectionReestablishmentRequest* (step 2, Table 8.5.1.2.3.2-1)

Derivation Path: 36.508, Table 4.6.1-13			
Information Element	Value/remark	Comment	Condition
RRCConnectionReestablishmentRequest ::= SEQUENCE {			
criticalExtensions CHOICE {			
rrcConnectionReestablishmentRequest-r8			
SEQUENCE {			
ue-Identity SEQUENCE {			
c-RNTI	the value of the C-RNTI of the UE		
physCellId	PhysicalCellIdentity of Cell 1		
shortMAC-I	The same value as the 16 least significant bits of the XMAC-I value calculated by SS		
}			
reestablishmentCause	otherFailure		
}			
}			

8.5.1.3 Radio link failure / T311 expiry

8.5.1.3.1 Test Purpose (TP)

(1)

```
with { UE in E-UTRA RRC_CONNECTED state with default bearer established and radio link failure was detected and UE attempts to select a suitable E-UTRA cell to re-establish the RRC connection }
ensure that {
  when { UE can not find a suitable cell within T311 }
  then { UE does not try to re-establish the RRC connection and goes to RRC_IDLE state after T311 expired }
}
```

8.5.1.3.2 Conformance requirements

The conformance requirements covered in the current test case are specified in TS 36.331 clause 5.3.7.2, 5.3.7.6 and 5.3.12.

[TS 36.331 clause 5.3.7.2]

...

Upon initiation of the procedure, the UE shall:

1> stop timer T310, if running;

1> start timer T311;

...

[TS 36.331 clause 5.3.7.6]

Upon T311 expiry, the UE shall:

1> perform the actions upon leaving RRC_CONNECTED as specified in 5.3.12, with release cause 'RRC connection failure'.

[TS 36.331 clause 5.3.12]

Upon leaving RRC_CONNECTED, the UE shall:

1> reset MAC;

- 1> stop all timers that are running except T320;
- 1> release all radio resources, including release of the RLC entity, the MAC configuration and the associated PDCP entity for all established RBs;
- 1> indicate the release of the RRC connection to upper layers with the release cause;
- 1> if leaving RRC_CONNECTED was not triggered by reception of the *MobilityFromEUTRACommand* message:
 - 2> enter RRC_IDLE by performing cell selection in accordance with the cell selection process, defined for the case of leaving RRC_CONNECTED, as specified in TS 36.304 [4].

8.5.1.3.3 Test description

8.5.1.3.3.1 Pre-test conditions

System simulator:

- 2 cells on same E-UTRA frequency:
 - Cell 1 (default parameters) serving cell
 - Cell 11 intra-frequency cell

UE:

None.

Preamble:

- The UE is in Generic RB Established (state 3) according to [18] on Cell 1.

8.5.1.3.3.2 Test procedure sequence

Table 8.5.1.3.3.2-1: Main behaviour

St	Procedure	Message Sequence		TP	Verdict
		U - S	Message		
1	The SS changes the power level of Cell 1 to non-suitable "Off" according to TS 36.508 subclause 6.2.2.1 in order that the radio link quality of Cell 1 is degraded.	-	-	-	-
2	Wait for 12s (T311 (10s) is transmitted in SIB2).	-	-	-	-
3	The SS changes the power level of Cell 11 to "Serving Cell" according to TS 36.508 subclause 6.2.2.1.	-	-	-	-
4	Check: Does the test result of generic test procedure in TS 36.508 subclause 6.4.2.7 indicate that the UE is camped on E-UTRAN Cell 11? NOTE: The UE performs a TAU procedure and the RRC connection is released.	-	-	1	-

8.5.1.3.3.3 Specific message contents

None.

8.5.1.4 Radio link failure / RRC connection re-establishment reject

8.5.1.4.1 Test Purpose (TP)

(1)

```
with { UE in E-UTRA RRC_CONNECTED state with default bearer established and radio link failure was detected and UE initiates the re-establishment procedure}
ensure that {
  when { the UE receives a RRCConnectionReestablishmentReject message }
```

```
    then { UE goes to RRC_IDLE and trigger TAU procedure in order to recover RRC connection }  
    }
```

8.5.1.4.2 Conformance requirements

The conformance requirements covered in the current test case are specified in TS 36.331 clause 5.3.7.8 and 5.3.12.

[TS 36.331 clause 5.3.7.8]

Upon receiving the *RRCConnectionReestablishmentReject* message, the UE shall:

- 1> perform the actions upon leaving RRC_CONNECTED as specified in 5.3.12, with release cause 'RRC connection failure'.

[TS 36.331 clause 5.3.12]

Upon leaving RRC_CONNECTED, the UE shall:

- 1> reset MAC;
- 1> stop all timers that are running except T320;
- 1> release all radio resources, including release of the RLC entity, the MAC configuration and the associated PDCP entity for all established RBs;
- 1> indicate the release of the RRC connection to upper layers together with the release cause;
- 1> if leaving RRC_CONNECTED was not triggered by reception of the *MobilityFromEUTRACommand* message:
 - 2> enter RRC_IDLE by performing cell selection in accordance with the cell selection process, defined for the case of leaving RRC_CONNECTED, as specified in TS 36.304 [4];

8.5.1.4.3 Test description

8.5.1.4.3.1 Pre-test conditions

System simulator:

- 2 cells on same E-UTRA frequency:
 - Cell 1(default parameters) serving cell
 - Cell 2 intra-frequency cell

UE:

None.

Preamble:

- The UE is in Generic RB Established (state 3) according to [18] on Cell 1.

8.5.1.4.3.2 Test procedure sequence

Table 8.5.1.4.3.2-1: Main behaviour

St	Procedure	Message Sequence		TP	Verdict
		U - S	Message		
1	The SS changes the power level of Cell 1 to non-suitable "Off" cell according to TS 36.508 subclause 6.2.2.1 in order that the radio link quality of Cell 1 is degraded and set the power level of Cell 2 to suitable cell.	-	-	-	-
2	The UE transmits an <i>RRConnectionReestablishmentRequest</i> message on Cell 2.	-->	<i>RRConnectionReestablishmentRequest</i>	-	-
3	The SS transmits a <i>RRConnectionReestablishmentReject</i> message	<--	<i>RRConnectionReestablishmentReject</i>	-	-
4-8	The UE will perform TAU procedure based on steps 1 to 5 of subclause 6.4.2.7 in TS 36.508 on Cell 2. NOTE: The UE performs a TAU procedure due to NAS signalling connection recovery.	-	-	-	-
9	Check: Does the test result of generic test procedure in TS 36.508 subclause 6.4.2.3 indicate that the UE is in E-UTRA RRC_CONNECTED state on Cell 2?	-	-	1	-
-	At the end of this test procedure sequence, the UE is in end state E-UTRA connected (E2_T3440) according to TS 36.508.	-	-	-	-

8.5.1.4.3.3 Specific message contents

None.

8.5.1.5 Radio link failure / Radio link recovery while T310 is running

8.5.1.5.1 Test Purpose (TP)

(1)

```
with { UE in E-UTRA RRC_CONNECTED state }
ensure that {
  when { UE detecting physical layer recovery while T310 was running }
  then { the UE resumes the RRC connection without explicit signalling }
}
```

8.5.1.5.2 Conformance requirements

References: The conformance requirements covered in the present TC are specified in: TS 36.331 clause 5.3.11.1 and 5.3.11.2.

[TS 36.331, clause 5.3.11.1]

The UE shall:

- 1> upon receiving N310 consecutive "out of sync" indications from lower layers while neither T300, T301, T304 nor T311 is running:
- 2> start timer T310.

[TS 36.331, clause 5.3.11.2]

Upon receiving N311 consecutive "in-sync" indications from lower layers while T310 is running, the UE shall:1>
stop timer T310.

NOTE 1: In this case, the UE resumes the RRC connection without explicit signalling, i.e. the UE resumes the entire radio resource configuration.

NOTE 2: Periods in time where neither "in-sync" nor "out-of-sync" is reported by layer 1 do not affect the evaluation of the number of consecutive "in-sync" or "out-of-sync" indications

8.5.1.5.3 Test description

8.5.1.5.3.1 Pre-test conditions

System Simulator:

- Cell 1

UE:

None.

Preamble:

- The UE is in state Generic RB Established (state 3) according to [18].

8.5.1.5.3.2 Test procedure sequence

Table 8.5.1.5.3.2-1 illustrates the downlink power level to be applied for the cell at various time instants of the test execution. Row marked "T0" denotes the initial condition, while column marked "T1" is applied according the procedure.

Table 8.5.1.5.3.2-1: Time instances of cell power level

	Parameter	Unit	Cell 1	Remark
T0	RS EPRE	dBm/ 15kHz Z	P_{default}	Power level from 36.508 clause 6.2.2.1. P_{default} as serving cell.
T1	RS EPRE	dBm/ 15kHz Z	P_{off}	P_{off} as non-suitable "Off" cell.

Table 8.5.1.5.3.2-2: Main behaviour

St	Procedure	Message Sequence		TP	Verdict
		U - S	Message		
	SS wait for the 660ms to ensure that DL Timing Advance is sent at least once and UE apply the value of <code>timeAlignmentTimerDedicated</code> which is updated during the preamble.	-	-	-	-
1	The SS changes Cell 1 level according to the row "T1" in table 8.5.1.5.3.2-1.	-	-	-	-
2	SS waits for 1.5s. The T310 is 2s.	-	-	-	-
3	The SS changes Cell 1 level according to the row "T0" in table 8.5.1.5.3.2-1.	-	-	-	-
4	SS waits for 5s. Check: Does the UE transmit any signalling message?	-	-	1	F
5	Check: Does the test result of generic test procedure in TS 36.508 subclause 6.4.2.3 indicate that the UE is in E-UTRA RRC_CONNECTED state on Cell 1?	-	-	1	-

8.5.1.5.3.3 Specific message contents

Table 8.5.1.5.3.3-1: SystemInformationBlockType2 (preamble and all steps, Table 8.5.1.5.3.2-2)

Derivation path: 36.508 table 4.4.3.3-1			
Information Element	Value/Remark	Comment	Condition
SystemInformationBlockType2 ::= SEQUENCE {			
ue-TimersAndConstants SEQUENCE {			
t310	ms2000		
}			
}			

Table 8.5.1.5.3.3-2: RRCConnectionReconfiguration (preamble: Table 4.5.3.3-1 [18], step 8)

Derivation path: 36.508 table 4.8.2.1.5-1			
Information Element	Value/Remark	Comment	Condition
RRCConnectionReconfiguration ::= SEQUENCE {			
criticalExtensions CHOICE {			
c1 CHOICE{			
rrcConnectionReconfiguration-r8 SEQUENCE {			
RadioResourceConfigDedicated SEQUENCE {			
mac-MainConfig CHOICE {			
timeAlignmentTimerDedicated	Infinity		
}			
}			
}			
}			
}			

NOTE: As per test model SS is not configured to transmit PDCCH orders and it expects UE to be PUCCH synchronized throughout the test sequence.

8.5.1.6 Radio link failure / T311 expiry / Dedicated RLF timer

8.5.1.6.1 Test Purpose (TP)

(1)

```
with { UE in E-UTRA RRC_CONNECTED state }
ensure that {
  when { UE receives an RRCConnectionReconfiguration message containing an rlf-TimersAndConstants-r9
set to setup }
  then { UE uses timer value received in the RRCConnectionReconfiguration message }
}
```

(2)

```
with { UE in E-UTRA RRC_CONNECTED state and having received an RRCConnectionReconfiguration message
containing an rlf-TimersAndConstants-r9 set to setup }
ensure that {
  when { UE receives SystemInformationBlockType2 containing different timer value from
RRCConnectionReconfiguration message }
  then { UE continues to use timer value received in the RRCConnectionReconfiguration message }
}
```

(3)

```
with { UE in E-UTRA RRC_CONNECTED state and having received an RRCConnectionReconfiguration message
containing an rlf-TimersAndConstants-r9 set to setup }
ensure that {
  when { UE receives an RRCConnectionReconfiguration message containing an rlf-TimersAndConstants-r9
set to release }
  then { UE does not use timer value received in the RRCConnectionReconfiguration message }
}
```

8.5.1.6.2 Conformance requirements

References: The conformance requirements covered in the present TC are specified in: TS 36.331 clause 5.2.2.9, 5.3.7.2, 5.3.7.6, 5.3.10.0, 5.3.10.7 and 5.3.12.

[TS 36.331 clause 5.2.2.9]

Upon receiving *SystemInformationBlockType2*, the UE shall:

...

- 1> if in RRC_CONNECTED and UE has previously received *rlf-TimersAndConstants*:
 - 2> The UE shall not update its values of the timers and constants in *UE-TimersAndConstants* except for the value of timer T300.

[TS 36.331 clause 5.3.7.2]

Upon initiation of the procedure, the UE shall:

- 1> stop timer T310, if running;
- 1> start timer T311;

[TS 36.331 clause 5.3.7.6]

Upon T311 expiry, the UE shall:

- 1> perform the actions upon leaving RRC_CONNECTED as specified in 5.3.12, with release cause 'RRC connection failure';

[TS 36.331 clause 5.3.10.0]

The UE shall:

...

- 1> if the received *radioResourceConfigDedicated* includes the *rlf-TimersAndConstants*:
 - 2> reconfigure the values of timers and constants as specified in 5.3.10.7;

[TS 36.331 clause 5.3.10.7]

The UE shall:

- 1> if the received *rlf-TimersAndConstants* is set to 'release':
 - 2> use values for timers T301, T310, T311 and constants N310, N311, as included in *ue-TimersAndConstants* received in *SystemInformationBlockType2*;
- 1> else:
 - 2> reconfigure the value of timers and constants in accordance with received *rlf-TimersAndConstants*;

[TS 36.331 clause 5.3.12]

Upon leaving RRC_CONNECTED, the UE shall:

- 1> reset MAC;
- 1> stop all timers that are running except T320;
- 1> release all radio resources, including release of the RLC entity, the MAC configuration and the associated PDCP entity for all established RBs;
- 1> indicate the release of the RRC connection to upper layers together with the release cause;
- 1> if leaving RRC_CONNECTED was not triggered by reception of the *MobilityFromEUTRACommand* message:

2> enter RRC_IDLE and perform procedures as specified in TS 36.304 [4, 5.2.7];

8.5.1.6.3 Test description

8.5.1.6.3.1 Pre-test conditions

System simulator:

- Cell 1 and Cell 2

UE:

None.

Preamble:

- The UE is in state Generic RB Established (state 3) on Cell 1 according to [18].

8.5.1.6.3.2 Test procedure sequence

Table 8.5.1.6.3.2-1 illustrates the downlink power levels to be applied for the cells at various time instants of the test execution. The exact instants on which these values shall be applied are described in the texts in this clause.

Table 8.5.1.6.3.2-1: Time instances of cell power level and parameter changes

	Parameter	Unit	Cell 1	Cell 2	Remark
T1	Cell-specific RS EPRE	dBm/15 kHz	"Off"	"Off"	No Cells are available. (NOTE 1).
T2	Cell-specific RS EPRE	dBm/15 kHz	"Off"	-85	Only Cell 2 is available. (NOTE 1).
T3	Cell-specific RS EPRE	dBm/15 kHz	-85	"Off"	Only Cell 1 is available. (NOTE 1).
NOTE 1: Power level "Off" is defined in TS 36.508 Table 6.2.2.1-1.					

Table 8.5.1.6.3.2-2: Main behaviour

St	Procedure	Message Sequence		TP	Verdict
		U - S	Message		
1	The SS changes Cell 1 levels according to row "T1" in Table 8.5.1.6.3.2-1.	-	-	-	-
2	Wait for 5s.	-	-	-	-
3	The SS changes Cell 2 levels according to row "T2" in Table 8.5.1.6.3.2-1.	-	-	-	-
4	Check: Does the UE transmit an <i>RRCCONNECTIONREQUEST</i> message on Cell 2?	-->	<i>RRCCONNECTIONREQUEST</i>	1	P
5-9	Steps 2 to 6 of the generic test procedure in TS 36.508 subclause 6.4.2.7 are performed on Cell 2. NOTE: The UE performs a TAU procedure and the RRC connection is released.	-	-	-	-
10	Wait for 5 s for the UE to enter E-UTRA RRC_IDLE state.	-	-	-	-
11-18	Steps 2 to 9 of the generic test procedure in TS 36.508 subclause 4.5.3.3 are performed on Cell 2. NOTE: The UE performs the establishment of the data radio bearer associated with the default EPS bearer context.	-	-	-	-
19	The SS transmits a <i>Paging</i> message including <i>systemInfoModification</i> on Cell 2.	<--	<i>Paging</i>	-	-
20	Wait for 2.1* modification period for the UE to receive system information.	-	-	-	-
21	The SS changes Cell 2 levels according to row "T1" in Table 8.5.1.6.3.2-1.	-	-	-	-
22	Wait for 5s.	-	-	-	-
23	The SS changes Cell 1 levels according to row "T3" in Table 8.5.1.6.3.2-1.	-	-	-	-
24	Check: Does the UE transmit an <i>RRCCONNECTIONREQUEST</i> message on Cell 1?	-->	<i>RRCCONNECTIONREQUEST</i>	2	P
25-29	Steps 2 to 6 of the generic test procedure in TS 36.508 subclause 6.4.2.7 are performed on Cell 1. NOTE: The UE performs a TAU procedure and the RRC connection is released.	-	-	-	-
30	Wait for 5 s for the UE to enter E-UTRA RRC_IDLE state.	-	-	-	-
31-38	Steps 2 to 9 of the generic test procedure in TS 36.508 subclause 4.5.3.3 are performed on Cell 1. NOTE: The UE performs the establishment of the data radio bearer associated with the default EPS bearer context.	-	-	-	-
39	The SS transmits an <i>RRCCONNECTIONRECONFIGURATION</i> message on Cell 1.	<--	<i>RRCCONNECTIONRECONFIGURATION</i>	-	-
40	The UE transmits an <i>RRCCONNECTIONRECONFIGURATIONCOMPLETE</i> message on Cell 1.	-->	<i>RRCCONNECTIONRECONFIGURATIONCOMPLETE</i>	-	-
41	The SS changes Cell 1 levels according to row "T1" in Table 8.5.1.6.3.2-1.	-	-	-	-
42	Wait for 5s.	-	-	-	-
43	The SS changes Cell 2 levels according to row "T2" in Table 8.5.1.6.3.2-1.	-	-	-	-
44	Check: Does the UE transmit an <i>RRCCONNECTIONREESTABLISHMENTREQUEST</i> message on Cell 2?	-->	<i>RRCCONNECTIONREESTABLISHMENTREQUEST</i>	3	P
45	The SS transmits an <i>RRCCONNECTIONREESTABLISHMENT</i> message on Cell 2.	<--	<i>RRCCONNECTIONREESTABLISHMENT</i>	-	-
46	The UE transmits an <i>RRCCONNECTIONREESTABLISHMENTCOMPLETE</i>	-->	<i>RRCCONNECTIONREESTABLISHMENTCOMPLETE</i>	-	-

	message on Cell 2.				
47	The SS transmits an <i>RRConnectionReconfiguration</i> message on Cell 2.	<--	<i>RRConnectionReconfiguration</i>	-	-
48	The UE transmits an <i>RRConnectionReconfigurationComplete</i> message on Cell 2.	-->	<i>RRConnectionReconfigurationComplete</i>	-	-
49	Check: Does the test result of generic test procedure in TS 36.508 subclause 6.4.2.3 indicate that the UE is in E-UTRA RRC_CONNECTED state on Cell 2?	-	-	3	-

8.5.1.6.3.3 Specific message contents

Table 8.5.1.6.3.3-1: SystemInformationBlockType2 for Cell 1 (preamble and all steps, Table 8.5.1.6.3.2-2)

Derivation Path: 36.508, Table 4.4.3.3-1			
Information Element	Value/remark	Comment	Condition
SystemInformationBlockType2 ::= SEQUENCE {			
ue-TimersAndConstants SEQUENCE {			
t311	ms30000		
}			
}			

Table 8.5.1.6.3.3-2: RRConnectionReconfiguration (preamble, step 17 and 37 Table 8.5.1.6.3.2-2)

Derivation Path: 36.508, Table 4.6.1-8, condition SRB2-DRB(1, 0)
--

Table 8.5.1.6.3.3-3: RadioResourceConfigDedicated (Table 8.5.1.6.3.2-2)

Derivation Path: 36.508, Table 4.6.3-16			
Information Element	Value/remark	Comment	Condition
RadioResourceConfigDedicated ::= SEQUENCE {			
rlf-TimersAndConstants-r9 CHOICE {			
setup SEQUENCE {			
t301-r9	ms1000		
t310-r9	ms1000		
n310-r9	n1		
t311-r9	ms1000		
n311-r9	n1		
}			
}			
}			

Table 8.5.1.6.3.3-4: Paging (step 19, Table 8.5.1.6.3.2-2)

Derivation Path: 36.508 Table 4.6.1-7			
Information Element	Value/remark	Comment	Condition
Paging ::= SEQUENCE {			
pagingRecordList	Not present		
systemInfoModification	true		
}			

Table 8.5.1.6.3.3-5: SystemInformationBlockType2 for Cell 2 (step 20, Table 8.5.1.6.3.2-2)

Derivation Path: 36.508, Table 4.4.3.3-1			
Information Element	Value/remark	Comment	Condition
SystemInformationBlockType2 ::= SEQUENCE {			
ue-TimersAndConstants SEQUENCE {			
t311	ms30000		
}			
}			

Table 8.5.1.6.3.3-6: RRCConnectionReconfiguration (step 39, Table 8.5.1.6.3.2-2)

Derivation Path: 36.508, Table 4.6.1-8			
Information Element	Value/remark	Comment	Condition
RRCConnectionReconfiguration ::= SEQUENCE {			
criticalExtensions CHOICE {			
c1 CHOICE {			
rrcConnectionReconfiguration-r8 SEQUENCE {			
radioResourceConfigDedicated SEQUENCE {	RadioResourceConfigDe		
}	dicated-NON-DEFAULT		
}			
}			
}			
}			

Table 8.5.1.6.3.3-7: RadioResourceConfigDedicated-NON-DEFAULT (Table 8.5.1.6.3.3-6)

Derivation Path: 36.508, Table 4.6.3-18A			
Information Element	Value/remark	Comment	Condition
RadioResourceConfigDedicated-NON-DEFAULT ::= SEQUENCE {			
srb-ToAddModList	Not present		
drb-ToAddModList	Not present		
drb-ToReleaseList	Not present		
mac-MainConfig	Not present		
sps-Config	Not present		
physicalConfigDedicated	Not present		
rlf-TimersAndConstants-r9 CHOICE {			
release	NULL		
}			
}			

8.5.1.7 CA / No Radio Link Failure on SCell / RRC Connection Continues on PCell

8.5.1.7.1 CA / No Radio Link Failure on SCell / RRC Connection Continues on PCell / Intra-band Contiguous CA

8.5.1.7.1.1 Test Purpose (TP)

(1)

```
with { UE in E-UTRA RRC_CONNECTED, security activated and SCell configured }
ensure that {
  when { UE drops out out service on SCell }
  then { UE does not consider radio link failure to be detected and stay in RRC_CONNECTED state }
}
```

8.5.1.7.1.2 Conformance requirements

References: The conformance requirements covered in the present TC are specified in: TS 36.331, clauses 5.3.10.7, 5.3.11.1 and 5.3.11.3.

[TS 36.331, clause 5.3.10.7]

The UE shall:

- 1> if the received *rlf-TimersAndConstants* is set to release:
 - 2> use values for timers T301, T310, T311 and constants N310, N311, as included in *ue-TimersAndConstants* received in *SystemInformationBlockType2*;
- 1> else:
 - 2> reconfigure the value of timers and constants in accordance with received *rlf-TimersAndConstants*;

[TS 36.331, clause 5.3.11.1]

The UE shall:

- 1> upon receiving N310 consecutive "out-of-sync" indications for the PCell from lower layers while neither T300, T301, T304 nor T311 is running:
 - 2> start timer T310;

NOTE: Physical layer monitoring and related autonomous actions do not apply to SCells.

[TS 36.331, clause 5.3.11.3]

The UE shall:

- 1> upon T310 expiry; or
- 1> upon random access problem indication from MAC while neither T300, T301, T304 nor T311 is running; or
- 1> upon indication from RLC that the maximum number of retransmissions has been reached:
 - 2> consider radio link failure to be detected;
 - 2> store the following radio link failure information in the *VarRLF-Report* by setting its fields as follows:
 - 3> clear the information included in *VarRLF-Report*, if any;
 - 3> set the *plmn-Identity* to the RPLMN;
 - 3> set the *measResultLastServCell* to include the RSRP and RSRQ, if available, of the PCell based on measurements collected up to the moment the UE detected radio link failure;
 - 3> set the *measResultNeighCells* to include the best measured cells, other than the PCell, ordered such that the best cell is listed first, and based on measurements collected up to the moment the UE detected radio link failure, and set its fields as follows:
 - 4> if the UE was configured to perform measurements for one or more EUTRA frequencies, include the *measResultListEUTRA*;
 - 4> if the UE was configured to perform measurement reporting for one or more neighbouring UTRA frequencies, include the *measResultListUTRA*;
 - 4> if the UE was configured to perform measurement reporting for one or more neighbouring GERAN frequencies, include the *measResultListGERAN*;
 - 4> if the UE was configured to perform measurement reporting for one or more neighbouring CDMA2000 frequencies, include the *measResultsCDMA2000*;

NOTE: The measured quantities are filtered by the L3 filter as configured in the mobility measurement configuration. The measurements are based on the time domain measurement resource restriction, if configured. Blacklisted cells are not required to be reported.

- 3> if detailed location information is available, set the content of the *locationInfo* as follows:
 - 4> include the *locationCoordinates*;

- 4> include the *horizontalVelocity*, if available;
- 3> set the *failedPCellId* to the global cell identity, if available, and otherwise to the physical cell identity and carrier frequency of the PCell where radio link failure is detected;
- 3> if an *RRCCongestionReconfiguration* message including the *mobilityControlInfo* was received before the connection failure:
 - 4> include *previousPCellId* and set it to the global cell identity of the PCell where the last *RRCCongestionReconfiguration* including the *mobilityControlInfo* message was received;
 - 4> set the *timeConnFailure* to the elapsed time since reception of the last *RRCCongestionReconfiguration* message including the *mobilityControlInfo*;
- 3> set the *connectionFailureType* to *rlf*;
- 2> if AS security has not been activated:
 - 3> perform the actions upon leaving RRC_CONNECTED as specified in 5.3.12, with release cause 'other';
- 2> else:
 - 3> initiate the connection re-establishment procedure as specified in 5.3.7;

The UE may discard the radio link failure information, i.e. release the UE variable *VarRLF-Report* 48, hours after the radio link failure is detected, upon power off or upon detach.

8.5.1.7.1.3 Test description

8.5.1.7.1.3.1 Pre-test conditions

System Simulator:

- Cell 1, and Cell 3
- Cell 1 is PCell
- Cell 3 is SCell
- Cell 3 is an Inactive SCell according to [18] cl. 6.3.4
- System information combination 3 as defined in TS 36.508 [18] clause 4.4.3.1 is used in E-UTRA cells.

UE:

None.

Preamble:

- The UE is in state Generic RB Established (state 3) on Cell 1 according to [18].

8.5.1.7.1.3.2 Test procedure sequence

Table 8.5.1.7.3.2-1 illustrates the downlink power levels and other changing parameters to be applied for the cells at various time instants of the test execution. Row marked "T0" denotes the initial conditions after preamble, while columns marked "T1" is to be applied subsequently. The exact instants on which these values shall be applied are described in the texts in this clause.

Table 8.5.1.7.1.3.2-1: Time instances of cell power level and parameter changes

	Parameter	Unit	Cell 1	Cell 3	Remark
T0	Cell-specific RS EPRE	dBm/15k Hz	-85	-85	Cell1 and Cell 3 are available
T1	Cell-specific RS EPRE	dBm/15k Hz	-85	"Off"	Only Cell 1 is available.

Table 8.5.1.7.1.3.2-2: Main behaviour

St	Procedure	Message Sequence		TP	Verdict
		U - S	Message		
1	The SS transmits an <i>RRConnectionReconfiguration</i> message on Cell 1 to configure SCell.	<--	<i>RRConnectionReconfiguration</i>	-	-
2	The UE transmits an <i>RRConnectionReconfigurationComplete</i> message on Cell 1.	-->	<i>RRConnectionReconfigurationComplete</i>	-	-
2A	Wait for 1s.	-	-	-	-
3	The SS changes power levels according to row "T1" in Table 8.5.1.7.1.3.2-1.	-	-	-	-
4	Wait for 1s.	-	-	-	-
5	Check: Does the UE transmit an <i>RRConnectionReestablishmentRequest</i> message on Cell 1?	-->	<i>RRConnectionReestablishmentRequest</i>	1	F
6	Check: Does the test result of CALL generic test procedure in 36.508 subclause 6.4.2.3 indicate that the UE is in E-UTRA RRC_CONNECTED state on Cell 1?	-	-	1	-

8.5.1.7.1.3.3 Specific message contents

Table 8.5.1.7.1.3.3-1: *RRConnectionReconfiguration* (step 1, Table 8.5.1.7.1.3.2-2)

Derivation Path: 36.508 Table 4.6.1-8, condition SCell_AddMod

Table 8.5.1.7.1.3.3-2: *SCellToAddMod-r10* (Table 8.5.1.7.1.3.3-1)

Derivation Path: 36.508, Table 4.6.3-19D

Information Element	Value/remark	Comment	Condition
<i>SCellToAddMod-r10</i> ::= SEQUENCE {			
<i>sCellIndex-r10</i>	1		
cellIdentification-r10 SEQUENCE {			
<i>physCellId-r10</i>	PhysicalCellIdentity of Cell 3		
<i>dl-CarrierFreq-r10</i>	Same downlink EARFCN as used for Cell 3		
}			
}			

Table 8.5.1.7.1.3.3-3: *RadioResourceConfigCommonSCell-r10* (Table 8.5.1.7.1.3.3-2)

Derivation Path: 36.508, Table 4.6.3-13A

Information Element	Value/remark	Comment	Condition
<i>RadioResourceConfigCommonSCell-r10</i> ::= SEQUENCE {			
nonUL-Configuration-r10 SEQUENCE {			
<i>dl-Bandwidth-r10</i>	Same downlink system bandwidth as used for Cell 3		
}			
}			

Condition	Explanation
FDD	FDD cell environment
TDD	TDD cell environment

8.5.1.7.2 CA / No Radio Link Failure on SCell / RRC Connection Continues on PCell / Inter-band CA

The scope and description of the present TC is the same as test case 8.5.1.7.1 with the following differences:

- CA configuration: Inter-band CA replaces Intra-band Contiguous CA
- Cells configuration: Cell 10 replaces Cell 3
- Cell 10 is an Inactive SCell according to [18] cl. 6.3.4

8.5.2 Redirection to E-UTRAN

8.5.2.1 Redirection to E-UTRAN / From UTRAN upon reception of RRC CONNECTION REJECT

8.5.2.1.1 Test Purpose (TP)

(1)

```
with { UE in UTRA Idle state }
ensure that {
  when { UE is requested to make an outgoing PS call }
  then { UE includes in the RRC CONNECTION REQUEST the IE Pre-Redirection info }
```

(2)

```
with { UE in UTRA CELL_DCH state }
ensure that {
  when { UE receives an RRC CONNECTION REJECT message including an IE Redirection info with E-UTRA target info E-UTRA frequency }
  then { UE enters RRC_IDLE state on E-UTRAN Carrier included in IE Redirection info }
```

8.5.2.1.2 Conformance requirements

References: The conformance requirements covered in the current TC are specified in: TS 25.331, clause 8.1.3.3, 8.1.4.3 and clause 8.5.2.

[TS 25.331, clause 8.1.3.3]

The UE shall, in the transmitted RRC CONNECTION REQUEST message:

...

- 1> if the UE supports E-UTRA:
 - 2> if the variable EUTRA_FREQUENCY_INFO_LIST contains no E-UTRA frequencies:
 - 3> include the IE "Pre-Redirection info";
 - 3> if the UE supports E-UTRA FDD:
 - 4> set the IE "Support of E-UTRA FDD" to TRUE.
 - 3> if the UE supports E-UTRA TDD:
 - 4> set the IE "Support of E-UTRA TDD" to TRUE.
 - 2> if the UE supports any of the bands that the E-UTRA frequencies included in the variable EUTRA_FREQUENCY_INFO_LIST belong to:
 - 3> include the IE "Pre-Redirection info";
 - 3> if the UE supports any of the bands that the E-UTRA FDD frequencies included in the variable EUTRA_FREQUENCY_INFO_LIST belong to:
 - 4> set the IE "Support of E-UTRA FDD" to TRUE.

- 3> if the UE supports any of the bands that the E-UTRA TDD frequencies included in the variable EUTRA_FREQUENCY_INFO_LIST belong to:
 - 4> set the IE "Support of E-UTRA TDD" to TRUE.

[TS 25.331, clause 8.1.3.9]

When the UE receives an RRC CONNECTION REJECT message on the downlink CCCH, it shall compare the value of the IE "Initial UE identity" in the received RRC CONNECTION REJECT message with the value of the variable INITIAL_UE_IDENTITY:

...

- 1> if the IE "inter-RAT info" is present:
 - 2> if the IE "wait time" = '0':
 - 3> the UE behaviour is not specified.
 - 2> if V300 is equal to or smaller than N300:
 - 3> if the IE "GSM target cell info" is present:
 - 4> attempt to camp on a suitable cell of the list of cells indicated for that RAT;
 - 4> if the UE selects and camps on one of the cells indicated for that RAT:
 - 5> disable cell reselection to the original RAT until the time stated in the IE "wait time" has elapsed.
 - 4> if the UE cannot find any suitable cell from the indicated ones within 10s, the UE is allowed to camp on any suitable cell on that RAT.
 - 5> after having selected and camped on a suitable cell on the designated RAT:
 - 6> the UE may disable cell reselection to the original RAT until the time stated in the IE "wait time" has elapsed.
 - 3> if the IE "E-UTRA target info" is present:
 - 4> attempt to camp on a suitable cell on one of the frequencies indicated for that RAT, excluding any cell indicated in the list of not allowed cells for that RAT (e.g. the "E-UTRA Target Cell Blacklist" for E-UTRA), if present;
 - 4> if the UE selects and camps on one such cell:
 - 5> disable cell reselection to the original RAT until the time stated in the IE "wait time" has elapsed.
 - 4> if the UE cannot find any suitable cell on the indicated frequencies within 10s, the UE is allowed to camp on any suitable cell on that RAT:
 - 5> after having selected and camped on a suitable cell on the designated RAT:
 - 6> disable cell reselection to the original RAT until the time stated in the IE "wait time" has elapsed.

8.5.2.1.3 Test description

8.5.2.1.3.1 Pre-test conditions

System Simulator:

- 2 cells, one UTRA and one E-UTRA cell:
 - Cell 5 UTRA serving cell (priority 4 default)
 - Cell 1 suitable neighbour E-UTRA cell (priority 3)

UE:

UTRAN Idle state

Preamble:

State 3 or state 7 as specified in clause 7.4 of TS 34.108, depending on the CN domain(s) supported by the UE.

8.5.2.1.3.2 Test procedure sequence

Table 8.5.2.1.3.2-1: Main behaviour

St	Procedure	Message Sequence		TP	Verdict
		U - S	Message		
1	Make the UE initiate an outgoing PS call.	-	-	-	-
2	Check: does the UE include the IE Pre-redirection info with Support of E-UTRA set to TRUE?	-->	RRC CONNECTION REQUEST	1	P
3	The SS transmit a RRC CONNECTION REJECT	<--	RRC CONNECTION REJECT	-	-
4	Check: Does the test result of generic test procedure in TS 36.508 Table 6.4.2.7A-2 indicate that the UE is camped on E-UTRAN Cell 1?	-	-	2	-

8.5.2.1.3.3 Specific message or IE contents

Table 8.5.2.1.3.3-1 System Information Block type 19 for cell 5 (preamble and all steps, Table 8.5.2.1.3.2-1)

Derivation Path: 36.508 Table 4.4.4.1-1			
Information Element	Value/remark	Comment	Condition
SysInfoType19 ::= SEQUENCE {			
utra-PriorityInfoList SEQUENCE {			
utra-ServingCell SEQUENCE {			
priority	4		
}			
utra-FrequencyAndPriorityInfoList SEQUENCE (SIZE (1..maxNumEUTRAFreqs)) OF SEQUENCE	1 entry		
earfcn[1]	Downlink EARFCN of Cell 1		
priority[1]	3		
}			
}			

Table 8.5.2.1.3.3-2: RRC CONNECTION REQUEST (UTRA Rel-8)

Derivation path: 34.108 default RRC CONNECTION REQUEST in section 9.1.1 for UTRA FDD or 9.1.2 for UTRA TDD			
Information Element	Value/Remark	Comment	Condition
Pre-redirection info		The presence of this IE indicates the UE support of radio access technologies that the UE could be directed to	
Support of E-UTRA FDD	TRUE		E-UTRA-FDD
Support of E-UTRA TDD	TRUE		E-UTRA-TDD
Domain indicator	PS domain		

Table 8.5.2.1.3.3-2: RRC CONNECTION REJECT (UTRA Rel-8)

Derivation path: 34.108 default RRC CONNECTION REJECT in section 9.1.1 for UTRA FDD or 9.1.2 for UTRA TDD			
Information Element	Value/Remark	Comment	Condition
Wait Time	15		
Redirection info			
Inter-RAT info	E-UTRA		
E-UTRA target info			
E-UTRA Target Frequency Info List	1 Entry		
DL Carrier frequency	EARFCN of the downlink Cell 1 carrier frequency		

8.5.3 Void

8.5.4 UE capability transfer

8.5.4.1 UE capability transfer / Success

8.5.4.1.1 Test Purpose (TP)

(1)

```
with { UE in RRC_CONNECTED state }
ensure that {
  when { UE receives an UECapabilityEnquiry message before AS security is activated }
  then { UE transmits an UECapabilityInformation message including UE radio access capability
information corresponding to the ue-CapabilityRequest variable }
}
```

(2)

```
with { UE in RRC_CONNECTED state }
ensure that {
  when { UE receives an UECapabilityEnquiry message after AS security is activated }
  then { UE transmits an UECapabilityInformation message including UE radio access capability
information corresponding to the ue-CapabilityRequest variable }
}
```

8.5.4.1.2 Conformance requirements

References: The conformance requirements covered in the present TC are specified in: TS 36.331, clause 5.6.3.3 and TS 25.331, clause 8.1.16.3.

[TS 36.331, clause 5.6.3.3]

The UE shall:

- 1> set the contents of *UECapabilityInformation* message as follows:
 - 2> if the *ue-CapabilityRequest* includes 'utra':
 - 3> include the *UE-EUTRA-Capability* within a *ue-CapabilityRAT-Container* and with the *rat-Type* set to 'utra';
 - 2> if the *ue-CapabilityRequest* includes 'geran-cs' and if the UE supports GERAN CS domain:
 - 3> include the UE radio access capabilities for GERAN CS within a *ue-CapabilityRAT-Container* and with the *rat-Type* set to 'geran-cs';
 - 2> if the *ue-CapabilityRequest* includes 'geran-ps' and if the UE supports GERAN PS domain:
 - 3> include the UE radio access capabilities for GERAN PS within a *ue-CapabilityRAT-Container* and with the *rat-Type* set to 'geran-ps';
 - 2> if the *ue-CapabilityRequest* includes 'utra' and if the UE supports UTRA:

- 3> include the UE radio access capabilities for UTRA within a *ueCapabilityRAT-Container* and with the *rat-Type* set to 'utra';
- 2> if the *ue-CapabilityRequest* includes 'cdma2000-1XRTT' and if the UE supports CDMA2000-1XRTT:
 - 3> include the UE radio access capabilities for CDMA 2000 within a *ueCapabilityRAT-Container* and with the *rat-Type* set to 'cdma2000-1XRTT';
- 1> submit the *UECapabilityInformation* message to lower layers for transmission, upon which the procedure ends.

[TS 25.331, clause 8.1.16.3]

The UE shall:

- 1> include the IE "UE security information", and the IE "UE security information2" if inter-RAT PS handover is supported by the UE; and
- 1> not include the IE "UE Specific Behaviour Information 1 interRAT";
- 1> in case support for the compressed version of the inter RAT handover info is indicated via the other radio access technology:
 - 2> if the other radio access technology is not E-UTRA:
 - 3> include of the following IEs the IE that after encoding has the smallest size: IE "Predefined configuration status information compressed" or the IE "Predefined configuration status information".
 - 2> else:
 - 3> exclude the IE "Predefined configuration status information" and "Predefined configuration status information compressed".
 - 2> include the IE "UE radio access capability compressed".
- 1> else:
 - 2> if the other radio access technology is not E-UTRA:
 - 3> include the IE "Predefined configuration status information".
 - 2> else:
 - 3> exclude the IE "Predefined configuration status information".
 - 2> include the IE "UE capability container", containing the IE "UE radio access capability" and the IE "UE radio access capability extension", in accordance with the following:
 - 3> if the UE supports multiple UTRA FDD Frequency Bands; or
 - 3> if the UE supports a single UTRA FDD Frequency Band different from Band I [21]; or
 - 3> if the UE supports E-UTRA:
 - 4> include the IE "UE radio access capability", excluding IEs "RF capability FDD" and "Measurement capability" for FDD and including the IE "Measurement capability TDD" for TDD;
 - 4> include the IE "UE radio access capability extension", including the IEs "RF capability FDD extension", the "Measurement capability extension", the "Additional Secondary Cells" and the "Non-contiguous multi-cell" associated with each supported UTRA FDD frequency band indicated in the IE "Frequency band", but may omit all or part of these IEs for supported inter-RAT bands.
 - 3> else:
 - 4> include the IE "UE radio access capability", including the IEs "RF capability FDD" and "Measurement capability" associated with the Band I [21] for FDD and excluding the IE "Measurement capability TDD" for TDD;

4> include the IE "UE radio access capability extension", including the IEs "RF capability FDD extension", the "Measurement capability extension", the "Additional Secondary Cells" and the "Non-contiguous multi-cell" associated with each supported UTRA FDD frequency band indicated in the IE "Frequency band".

1> For FDD, include the IE "UE radio access capability comp 2";

1> For 1.28 Mcps TDD, include the IE "UE radio access capability comp for 1.28 Mcps TDD";

1> initiate the transfer of the INTER RAT HANDOVER INFO message via the other radio access technology, using radio access technology-specific procedures;

1> store the following in the variable INTER_RAT_HANDOVER_INFO_TRANSFERRED if they were included in the INTER RAT HANDOVER INFO message:

2> the IE "Predefined configuration status information";

2> the IE "Predefined configuration status information compressed";

2> the IE "UE security information";

2> the IE "UE security information2";

2> the IE "UE radio access capability";

2> the IE "UE radio access capability extension"; and

2> the IE "UE radio access capability compressed";

2> if the IE "UE radio access capability compressed" were included in the INTER RAT HANDOVER INFO message:

3> set the IE "Security Capability" to the mandatory R99 algorithms.

1> and the procedure ends.

8.5.4.1.3 Test description

8.5.4.1.3.1 Pre-test conditions

System Simulator:

- Cell 1

UE:

None.

Preamble:

- The UE is in state Switched OFF (state 1) according to [18].

8.5.4.1.3.2 Test procedure sequence

Table 8.5.4.1.3.2-1: Main behaviour

St	Procedure	Message Sequence		TP	Verdict
		U - S	Message		
1	The UE is switched on.	-	-	-	-
2	The UE transmits an <i>RRCCONNECTIONREQUEST</i> message.	-->	<i>RRCCONNECTIONREQUEST</i>	-	-
3	The SS transmits an <i>RRCCONNECTIONSETUP</i> message.	<--	<i>RRCCONNECTIONSETUP</i>	-	-
4	The UE transmits an <i>RRCCONNECTIONSETUPCOMPLETE</i> . This message includes an ATTACH REQUEST and a PDN CONNECTIVITY REQUEST message.	-->	<i>RRCCONNECTIONSETUPCOMPLETE</i>	-	-
5	The SS transmits a <i>DLINFORMATIONTRANSFER</i> message. This message includes an AUTHENTICATION REQUEST message.	<--	<i>DLINFORMATIONTRANSFER</i>	-	-
6	The UE transmits a <i>ULINFORMATIONTRANSFER</i> message. This message includes an AUTHENTICATION RESPONSE message.	-->	<i>ULINFORMATIONTRANSFER</i>	-	-
7	The SS transmits a <i>DLINFORMATIONTRANSFER</i> message. This message includes a SECURITY MODE COMMAND message.	<--	<i>DLINFORMATIONTRANSFER</i>	-	-
8	The UE transmits a <i>ULINFORMATIONTRANSFER</i> message. This message includes a SECURITY MODE COMPLETE message.	-->	<i>ULINFORMATIONTRANSFER</i>	-	-
9	The SS transmits a <i>UECAPABILITYENQUIRY</i> message to request UE radio access capability information for E UTRA only.	<--	<i>UECAPABILITYENQUIRY</i>	-	-
10	Check: Does the UE transmit a <i>UECAPABILITYINFORMATION</i> message?	-->	<i>UECAPABILITYINFORMATION</i>	1	P
11	The SS transmits a <i>SECURITYMODECOMMAND</i> message to activate AS security.	<--	<i>SECURITYMODECOMMAND</i>	-	-
12	The UE transmits a <i>SECURITYMODECOMPLETE</i> message and establishes the initial security configuration.	-->	<i>SECURITYMODECOMPLETE</i>	-	-
-	EXCEPTION: Steps 13a1 to 13a2 describe behaviour that depends on UE configuration; the "lower case letter" identifies a step sequence that take place if the UE has ESM information which needs to be transferred after SECURITY MODE COMPLETE message.	-	-	-	-
13a 1	IF the UE sets the ESM information transfer flag in the last PDN CONNECTIVITY REQUEST message THEN the SS transmits a <i>DLINFORMATIONTRANSFER</i> message. This message includes an ESM INFORMATION REQUEST message.	<--	<i>DLINFORMATIONTRANSFER</i>	-	-
13a 2	The UE transmits a <i>ULINFORMATIONTRANSFER</i> message. This message includes an ESM INFORMATION RESPONSE message.	-->	<i>ULINFORMATIONTRANSFER</i>	-	-
14	The SS transmits an <i>RRCCONNECTIONRECONFIGURATION</i> message to establish a data radio bearer.	<--	<i>RRCCONNECTIONRECONFIGURATION</i>	-	-
15	The UE transmits an <i>RRCCONNECTIONRECONFIGURATIONCOMPLETE</i> .	-->	<i>RRCCONNECTIONRECONFIGURATIONCOMPLETE</i>	-	-
16	The UE transmits a <i>ULINFORMATIONTRANSFER</i> message. This message includes an ATTACH COMPLETE message.	-->	<i>ULINFORMATIONTRANSFER</i>	-	-
17	The SS transmits a <i>UECAPABILITYENQUIRY</i>	<--	<i>UECAPABILITYENQUIRY</i>	-	-

	message to request UE radio access capability information for E UTRA only.				
18	Check: Does the UE transmit a <i>UECapabilityInformation</i> message?	-->	<i>UECapabilityInformation</i>	2	P
-	EXCEPTION: Steps 19a1 to 19a2 describe behaviour that depends on the UE capability.	-	-	-	-
19a 1	IF pc_FDD, pc_TDD_HCR, pc_TDD_LCR, pc_TDD_VHCR, pc_GERAN, pc_1xRTT or pc_HRPD THEN the SS transmits a <i>UECapabilityEnquiry</i> message to request UE radio access capability information for every other supported RATs.	<--	<i>UECapabilityEnquiry</i>	-	-
19a 2	Check: Does the UE transmit a <i>UECapabilityInformation</i> message?	-->	<i>UECapabilityInformation</i>	2	P

8.5.4.1.3.3 Specific message contents

Table 8.5.4.1.3.3-1: UECapabilityEnquiry (step 9 and 17, Table 8.5.4.1.3.2-1)

Derivation path: 36.508 clause 4.6.1 table 4.6.1-22			
Information Element	Value/Remark	Comment	Condition
<i>UECapabilityEnquiry</i> ::= SEQUENCE {			
criticalExtensions CHOICE {			
c1 CHOICE {			
ueCapabilityEnquiry-r8 SEQUENCE {			
ue-CapabilityRequest SEQUENCE (SIZE (1..maxRAT-Capabilities)) OF SEQUENCE {	1 entry	E-UTRA only	
RAT-Type[1]	eutra		
}			
}			
}			
}			
}			

Table 8.5.4.1.3.3-2: UECapabilityInformation (step 10 and 18, Table 8.5.4.1.3.2-1)

Derivation path: 36.508 clause 4.6.1 table 4.6.1-23			
Information Element	Value/Remark	Comment	Condition
UECapabilityInformation ::= SEQUENCE {			
criticalExtensions CHOICE {			
c1 CHOICE{			
ueCapabilityInformation-r8 SEQUENCE { SIZE (1..maxRAT-Capabilities)) OF SEQUENCE {	1 entry only		
rat-Type[1]	eutra	E-UTRA only	
ueCapabilitiesRAT-Container[1] OCTET STRING {			
UE-EUTRA-Capability SEQUENCE {			
accessStratumRelease	Not checked	Value should be based on Rel of Access stratum supported	
ue-Category	Checked against UE Category indications in the PICS		Rel-8 or Rel-9
pdcp-Parameters	Not checked		Rel-8
pdcp-Parameters SEQUENCE {			> Rel-8
supportedROHC-Profiles SEQUENCE {			
profile0x0001	Not checked		
profile0x0001	true		ROHC
profile0x0002	Not checked		
profile0x0002	true		ROHC
profile0x0003	Not checked		
profile0x0004	Not checked		
profile0x0006	Not checked		
profile0x0101	Not checked		
profile0x0102	Not checked		
profile0x0103	Not checked		
profile0x0104	Not checked		
}			
maxNumberROHC-ContextSessions	Not checked		
}			
phyLayerParameters SEQUENCE {			
ul-AntennaSelectionSupported	Not checked		
ue-SpecificRefSigsSupported	Not checked		
}			
rf-Parameters SEQUENCE {			
supportedBandListEUTRA (SIZE (1..maxBands)) OF SEQUENCE {	n entries where n is the sum of pc_eBand α _Supp for $\alpha= 1$ to 64	n is the number of supported EUTRA bands	
BandListEUTRA SEQUENCE {			
bandEUTRA [$\alpha = 1..n$]	Any value β such that pc_eBand β _Supp is TRUE and different from all eutra-Band[k] where k = 1 to $\alpha - 1$		
halfDuplex[$\alpha = 1..n$]	Not checked		
}			
}			
}			
measurementParameters SEQUENCE {			
BandListEUTRA(SIZE (1..maxBands)) OF SEQUENCE {	same number of entries like in SupportedBandListEUTRA		
BandInfoEUTRA SEQUENCE {			
InterFreqBandList (SIZE (1..maxBands)) OF SEQUENCE {	m entries (contents not checked, but m shall be equal to the number of bands listed in each IE present in <i>interRAT-</i>		

	<i>Parameters)</i>		
InterFreqBandInfo			
}			
InterRAT-BandList (SIZE (1..maxBands))			
OF SEQUENCE {			
InterRAT-BandInfo	Not checked		
}			
}			
}			
featureGroupIndicators	shall be set according to the corresponding PICS items		
-- FGI 1	Checked		
-- FGI 2	Checked		
-- FGI 3	Checked		
-- FGI 4	Checked		
-- FGI 5	Checked		
-- FGI 6	Checked		
-- FGI 7	Checked		
-- FGI 8	Checked		
-- FGI 9	Checked		
-- FGI 10	Checked		
-- FGI 11	Checked		
-- FGI 12	Checked		
-- FGI 13	Checked		
-- FGI 14	Checked		
-- FGI 15	Checked		
-- FGI 16	Checked		
-- FGI 17	Checked		
-- FGI 18	Checked		
-- FGI 19	Checked		
-- FGI 20	Checked		
-- FGI 21	Checked		
-- FGI 22	Checked		
-- FGI 23	Checked		
-- FGI 24	Checked		
-- FGI 25	Checked		
-- FGI 26	Checked		
-- FGI 27	Checked		
-- FGI 28	Checked		
-- FGI 29	Checked		
-- FGI 30	Checked		
-- FGI 31	Checked		
-- FGI 32	'0'B (Undefined)		
interRAT-Parameters SEQUENCE {	m elements are present		
utraFDD	Present but value not checked		pc_FDD
utraTDD128	Present but value not checked		pc_TDD_LCR
utraTDD384	Present but value not checked		pc_TDD_HCR
utraTDD768	Present but value not checked		pc_TDD_VHCR
geran	Present but value not checked		pc_GERAN
cdma2000-HRPD	Present but value not checked		pc_HRPD
cdma2000-1xRTT	Present but value not checked		pc_1xRTT
}			
nonCriticalExtension SEQUENCE {			
phyLayerParameters-v920	Not checked		
interRAT-ParametersGERAN-v920	Not checked		
interRAT-ParametersUTRA-v920	Not checked		
interRAT-ParametersCDMA2000-v920	Not checked		

deviceType-r9	Not checked		
csg-ProximityIndicationParameters-r9	Not checked		
neighCellSI-AcquisitionParameters-r9	Not checked		
son-Parameters-r9	Not checked		
nonCriticalExtension SEQUENCE {			
lateNonCriticalExtension SEQUENCE {			
featureGroupIndRel9Add-r9	If present, shall be set according to the corresponding PICS items		
-- FGI 33	Checked		
-- FGI 34	Checked		
-- FGI 35	Checked		
-- FGI 36	Checked		
-- FGI 37	Checked		
-- FGI 38	Checked		
-- FGI 39	Checked		
-- FGI 40	Checked		
-- FGI 41	Checked		
-- FGI 42-64	'0'B (Undefined)		
fdd-Add-UE-EUTRA-Capabilities-r9 SEQUENCE {			
phyLayerParameters-r9	Not checked		
featureGroupIndicators-r9	Shall be set according to the corresponding PICS items. Checked. See Note 1.	BITSTRING 32	
-- FGI 1_F	Checked		
-- FGI 2_F	Checked		
-- FGI 3_F	Checked		FDD = TDD
-- FGI 4_F	Checked		
-- FGI 5_F	Checked		FDD = TDD
-- FGI 6_F	Checked		FDD = TDD
-- FGI 7_F	Checked		FDD = TDD
-- FGI 8_F	Checked		
-- FGI 9_F	Checked		
-- FGI 10_F	Checked		
-- FGI 11_F	Checked		
-- FGI 12_F	Checked		
-- FGI 13_F	Checked		FDD = TDD
-- FGI 14_F	Checked		FDD = TDD
-- FGI 15_F	Checked		
-- FGI 16_F	Checked		
-- FGI 17_F	Checked		FDD = TDD
-- FGI 18_F	Checked		FDD = TDD
-- FGI 19_F	Checked		
-- FGI 20_F	Checked		FDD = TDD
-- FGI 21_F	Checked		FDD = TDD
-- FGI 22_F	Checked		
-- FGI 23_F	Checked		
-- FGI 24_F	Checked		
-- FGI 25_F	Checked		FDD = TDD
-- FGI 26_F	Checked		
-- FGI 27_F	Checked		
-- FGI 28_F	Checked		

-- FGI 29_F	Checked		
-- FGI 30_F	Checked		FDD = TDD
-- FGI 31_F	Checked		
-- FGI 32_F	'0'B (Undefined)		
featureGroupIndRel9Add-r9	Shall be set according to the corresponding PICS items. Checked. See Note 1.	BITSTRING 32	
-- FGI 33_F	Checked		
-- FGI 34_F	Checked		
-- FGI 35_F	Checked		
-- FGI 36_F	Checked		
-- FGI 37_F	Checked		
-- FGI 38_F	Checked		
-- FGI 39_F	Checked		
-- FGI 40_F	Checked		
-- FGI 41_F	Checked		
-- FGI 42-64_F	'0'B (Undefined)		
interRAT-ParametersGERAN-r9	Not checked		
interRAT-ParametersUTRA-r9	Not checked		
interRAT-ParametersGERAN-r9	Not checked		
interRAT-ParametersCDMA2000-r9	Not checked		
neighCellSI-AcquisitionParameters-r9	Not checked		
}			
td-Add-UE-EUTRA-Capabilities-r9			
SEQUENCE {			
phyLayerParameters-r9	Not checked		
featureGroupIndicators-r9	Shall be set according to the corresponding PICS items. Checked. See Note 1.	BITSTRING 32	
-- FGI 1_T	Checked		
-- FGI 2_T	Checked		
-- FGI 3_T	Checked		FDD = TDD
-- FGI 4_T	Checked		
-- FGI 5_T	Checked		FDD = TDD
-- FGI 6_T	Checked		FDD = TDD
-- FGI 7_T	Checked		FDD = TDD
-- FGI 8_T	Checked		
-- FGI 9_T	Checked		
-- FGI 10_T	Checked		
-- FGI 11_T	Checked		
-- FGI 12_T	Checked		
-- FGI 13_T	Checked		FDD = TDD
-- FGI 14_T	Checked		FDD = TDD
-- FGI 15_T	Checked		
-- FGI 16_T	Checked		
-- FGI 17_T	Checked		FDD = TDD
-- FGI 18_T	Checked		FDD = TDD
-- FGI 19_T	Checked		
-- FGI 20_T	Checked		FDD = TDD
-- FGI 21_T	Checked		FDD = TDD
-- FGI 22_T	Checked		
-- FGI 23_T	Checked		
-- FGI 24_T	Checked		

-- FGI 25_T	Checked		FDD = TDD
-- FGI 26_T	Checked		
-- FGI 27_T	Checked		
-- FGI 28_T	Checked		
-- FGI 29_T	Checked		
-- FGI 30_T	Checked		FDD = TDD
-- FGI 31_T	Checked		
-- FGI 32_T	'0'B (Undefined)		
featureGroupIndRel9Add-r9	Shall be set according to the corresponding PICS items. Checked. See Note 1	BITSTRING 32	
-- FGI 33_T	Checked		
-- FGI 34_T	Checked		
-- FGI 35_T	Checked		
-- FGI 36_T	Checked		
-- FGI 37_T	Checked		
-- FGI 38_T	Checked		
-- FGI 39_T	Checked		
-- FGI 40_T	Checked		
-- FGI 41_T	Checked		
-- FGI 42-64_T	'0'B (Undefined)		
interRAT-ParametersGERAN-r9	Not checked		
interRAT-ParametersUTRA-r9	Not checked		
interRAT-ParametersGERAN-r9	Not checked		
interRAT-ParametersCDMA2000-r9	Not checked		
neighCellSI-AcquisitionParameters-r9	Not checked		
}			
nonCriticalExtension SEQUENCE {			
interRAT-ParametersUTRA-v9c0	Not checked		
nonCriticalExtension SEQUENCE {			
phyLayerParameters-v9d0	Not checked		
nonCriticalExtension SEQUENCE {			
rf-Parameters-v9e0	Not checked		
nonCriticalExtension SEQUENCE {}	Not checked		
}	Not checked		
}	Not checked		
}	Not checked		
}	Not checked		
nonCriticalExtension SEQUENCE {			
ue-Category-v1020	Checked against UE Category indications in the PICS and requirements from 36.306 cl. 4.1		
phyLayerParameters-v1020	Not checked		
rf-Parameters-v1020{	Not checked		
supportedBandCombination-r10 {	For as many band combinations as supported		
BandCombinationParameters-r10 {			
BandParameters-r10 {			
bandEUTRA-r10 {	Not checked		
}			
BandParameterUL-r10 {			
CA-MIMO-ParametersUL-r10 {	For as many bandwidth classes as supported		
ca-BandwidthClassUL-r10	Not checked		
supportedMIMO-CapabilityUL-r10	Not checked		
}			
}			
BandParameterDL-r10 {	For as many bandwidth classes as supported		
CA-MIMO-ParametersDL-r10 {			

ca-BandwidthClassDL-r10	Not checked		
supportedMIMO-CapabilityDL-r10	Not checked		
}			
}			
}			
measParameters-v1020 {	Not checked		
bandCombinationListEUTRA-r10 {	For as many band combinations as supported		
BandInfoEUTRA {			
interFreqBandList {			
InterFreqBandInfo {			
interFreqNeedForGaps	Not checked		
}			
}			
interRAT-BandList {			
InterRAT-BandInfo {			
interRAT-NeedForGaps	Not checked		
}			
}			
}			
}			
}			
featureGroupIndRel10-r10	Shall be set according to the corresponding PICS items. Checked.	BITSTRING 32	
-- FGI 101	Checked		
-- FGI 102	Checked		
-- FGI 103	Checked		
-- FGI 104	Checked		
-- FGI 105	Checked		
-- FGI 106	Checked		
-- FGI 107	Checked		
-- FGI 108	Checked		
-- FGI 109	Checked		
-- FGI 110	Checked		
-- FGI 111	Checked		
-- FGI 112	Checked		
-- FGI 113	Checked		
-- FGI 114	Checked		
-- FGI 115	Checked		
-- FGI 116	Checked		
-- FGI 117-132	'0'B (Undefined)		
interRAT-ParametersCDMA2000-v1020	Not checked		
ue-BasedNetwPerfMeasParameters-r10	Not checked		
interRAT-ParametersUTRA-TDD-v1020	Not checked		
nonCriticalExtension SEQUENCE {			
fdd-Add-UE-EUTRA-Capabilities-v1060	Not checked		
tdd-Add-UE-EUTRA-Capabilities-v1060	Not checked		
rf-Parameters-v1060	Not checked		
nonCriticalExtension SEQUENCE {			
rf-Parameters-v1090	Not checked		
nonCriticalExtension SEQUENCE {			
pdcp-Parameters-v1130	Not checked		
phyLayerParameters-v1130	Not checked		
rf-Parameters-v1130	Not checked		
measParameters-v1130	Not checked		
interRAT-ParametersCDMA2000-	Not checked		
v1130			
otherParameters-r11	Not checked		
fdd-Add-UE-EUTRA-Capabilities-v1130	Not checked		
tdd-Add-UE-EUTRA-Capabilities-v1130	Not checked		
nonCriticalExtension SEQUENCE {}	Not checked		

Table 8.5.4.1.3.3-4: UECapabilityInformation (step 19a2, Table 8.5.4.1.3.2-1)

Derivation path: 36.508 clause 4.6.1 table 4.6.1-23			
Information Element	Value/Remark	Comment	Condition
UECapabilityInformation ::= SEQUENCE {			
criticalExtensions CHOICE {			
c1 CHOICE{			
ueCapabilityInformation-r8 SEQUENCE { SIZE (1..maxRAT-Capabilities)) OF SEQUENCE {		Stated capability shall be compatible with 3GPP TS 36.523-2 (ICS statements) and the user settings	
rat-Type[i1]	utran		pc_FDD, pc_TDD_HCR, pc_TDD_LCR, pc_TDD_VHCR
ueCapabilitiesRAT-Container[i1] OCTET STRING {}	ueCapabilitiesRAT-Container-UTRAN	Encoded as an INTER RAT HANDOVER INFO messages as defined in 3GPP TS 25.331 [17].	pc_FDD, pc_TDD_HCR, pc_TDD_LCR, pc_TDD_VHCR
rat-Type[i2]	geran-cs		pc_GERAN and pc_CS
ueCapabilitiesRAT-Container [i2] OCTET STRING {}	ueCapabilitiesRAT-Container-GERAN-CS	Encoded as the concatenation of IEs MS classmark 2 and MS classmark 3 as defined in 3GPP TS 24.008 [32].	pc_GERAN and pc_CS
rat-Type[i3]	geran-ps		pc_GERAN and pc_PS
ueCapabilitiesRAT-Container [i3] OCTET STRING {}	ueCapabilitiesRAT-Container-GERAN-PS	Encoded as MS radio access capability IE as defined in 3GPP TS 24.008 [32].	pc_GERAN and pc_PS
rat-Type[i4]	cdma2000-1XRTT		pc_1xRTT, pc_HRPD
ueCapabilitiesRAT-Container [i4] OCTET STRING {}	Not checked	Encoded as A21 Mobile Subscription Information as defined in 3GPP2 A.S0008-C v4.0 [33].	pc_1xRTT, pc_HRPD
nonCriticalExtension SEQUENCE {}	Not present		
}			
}			
}			
}			

Table 8.5.4.1.3.3-5: ueCapabilitiesRAT-Container-UTRAN

Derivation path: 25.331 clause 11.2			
Information Element	Value/Remark	Comment	Condition
ueCapabilitiesRAT-Container-UTRAN ::= SEQUENCE {			
predefinedConfigStatusList CHOICE {			
absent	NULL		
}			
uE-SecurityInformation	Not checked	The value of start CS is not used for LTE to UMTS handover in Rel-8	
ue-CapabilityContainer CHOICE {			
present	Not checked	Container including UE radio access capability	
}			
v390NonCriticalExtensions CHOICE {			
present SEQUENCE {			
interRATHandoverInfo-v390ext	Not checked	Positioning capability and dummy field	
}			
v3a0NonCriticalExtensions SEQUENCE {			
interRATHandoverInfo-v3a0ext	Not checked	Positioning capability	
}			
laterNonCriticalExtensions SEQUENCE {			
interRATHandoverInfo-v3d0ext	Not checked	Deprecated information	
}			
interRATHandoverInfo-r3-add-ext	Not checked if present	UE radio access capability for bands VIII to XIV, UE radio access capability extension, support of 2 DRX schemes in CELL_PCH, support of E-DPDCH power interpolation	
}			
v3g0NonCriticalExtensions SEQUENCE {			
interRATHandoverInfo-v3g0ext	Not checked	Positioning capability extension	
}			
v4b0NonCriticalExtensions SEQUENCE {			
interRATHandoverInfo-v4b0ext	Checked	Access Stratum Release indicator	
}			
v4d0NonCriticalExtensions SEQUENCE {			
interRATHandoverInfo-v4d0ext	Not checked if present	LCR TDD UE capability	
}			
v590NonCriticalExtensions SEQUENCE {			
interRATHandoverInfo-v590ext	Not checked if present	Predefined configuration status information compressed, UE radio access capability compressed	
}			
v690NonCriticalExtensions SEQUENCE {			
interRATHandoverInfo-v690ext			
}			
ue-SecurityInformation2	Present but value not checked	START PS	pc_Featr Grp_8
ue-SecurityInformation2	Not present		NOT pc_FeatrGrp_8

ue-RadioAccessCapabilityComp	Not checked	RF capability for bands VIII to XIV	
ue-RadioAccessCapabilityComp2	Present but value not checked	UE radio access capability comp 2	pc_FDD
ue-RadioAccessCapabilityComp2	Not checked if present	UE radio access capability comp 2	NOT pc_FDD
}			
v6b0NonCriticalExtensions SEQUENCE {			
interRATHandoverInfo-v6b0ext	Not checked if present	Support for SIB11bis	
v6e0NonCriticalExtensions SEQUENCE {			
interRATHandoverInfo-v6e0ext	Not checked if present	Support of FDPCH	
v770NonCriticalExtensions SEQUENCE {			
interRATHandoverInfo-v770ext	Not checked if present	TDD RF and physical channel capability extensions in Rel-7, support of GANSS, support of MAC-ehs, LCR TDD UE specific capability information	
v790nonCriticalExtensions SEQUENCE {			
interRATHandoverInfo-v790ext	Not checked if present	Support of E-DPCCH power boosting	
v860NonCriticalExtensions0 SEQUENCE {			
interRATHandoverInfo-v860ext	Not checked if present	UE radio access capability for additional bands, Rel-8 HS-DSCH physical layer category, support of MAC-iis	
v880NonCriticalExtensions SEQUENCE {	Present but value not checked		pc_TDD_L CR
v880NonCriticalExtensions SEQUENCE {	Not checked if present		NOT pc_TDD_L CR
v920NonCritical ExtensionsinterRATHandoverInfo-v880ext	Not checked	Support for priority reselection in UTRAN, Rel-8 radio access capability extensions for LCR TDD (e.g. multi-carrier operation)	
SEQUENCE {	Not checked if present		
interRATHandoverInfo-v920ext	Not checked if present		
v8b0NonCritical Extensions SEQUENCE {	Present but value not checked		pc_TDD_L CR
v8b0NonCritical Extensions SEQUENCE {	Not checked if present		NOT pc_TDD_L CR
interRATHandoverInfo-v8b0ext	Not checked if present		
v950NonCritical Extensions SEQUENCE {			
interRATHandoverInfo-v950ext	Not checked if present		

8.6 Minimization of Drive Test Specific Procedures

8.6.1 Immediate MDT

8.6.1.1 Immediate MDT / Reporting / Location information

8.6.1.1.1 Test Purpose (TP)

(1)

```
with { UE in E-UTRA RRC_CONNECTED state and measurement with event A2 configured with
includeLocationInfo included in the reportConfig }
ensure that {
  when { Entry condition for event A2 is met and detailed location information that has not been
reported is available }
  then { UE sends MeasurementReport message with locationInfo included }
}
```

(2)

```
with { UE in E-UTRA RRC_CONNECTED state and measurement configured for event A2 }
ensure that {
  when { Exit condition for event A2 is met }
  then { UE stops sending MeasurementReport message }
}
```

8.6.1.1.2 Conformance requirements

References: The conformance requirements covered in the current TC are specified in: TS 36.331, clauses 5.3.5.3, 5.5.4.1, 5.5.4.3 and 5.5.5.

[TS 36.331, clause 5.3.5.3]

If the *RRCConnectionReconfiguration* message does not include the *mobilityControlInfo* and the UE is able to comply with the configuration included in this message, the UE shall:

...

- 1> if the *RRCConnectionReconfiguration* message includes the *measConfig*:
- 2> perform the measurement configuration procedure as specified in 5.5.2;

...

[TS 36.331, clause 5.5.4.1]

The UE shall:

- 1> for each *measId* included in the *measIdList* within *VarMeasConfig*:
 - ...
 - 2> else:
 - 3> if the corresponding *measObject* concerns EUTRA:
 - 4> consider any neighbouring cell detected on the associated frequency to be applicable when the concerned cell is not included in the *blackCellsToAddModList* defined within the *VarMeasConfig* for this *measId*;

...

- 2> if the *triggerType* is set to 'event' and if the entry condition applicable for this event, i.e. the event corresponding with the *eventId* of the corresponding *reportConfig* within *VarMeasConfig*, is fulfilled for one or more applicable cells for all measurements after layer 3 filtering taken during *timeToTrigger* defined for this event within the *VarMeasConfig* while the *VarMeasReportList* does not include a measurement reporting entry for this *measId* (a first cell triggers the event):

- 3> include a measurement reporting entry within the *VarMeasReportList* for this *measId*;
- 3> set the *numberOfReportsSent* defined within the *VarMeasReportList* for this *measId* to 0;
- 3> include the concerned cell(s) in the *cellsTriggeredList* defined within the *VarMeasReportList* for this *measId*;
- 3> initiate the measurement reporting procedure, as specified in 5.5.5;
- 2> if the *triggerType* is set to 'event' and if the entry condition applicable for this event, i.e. the event corresponding with the *eventId* of the corresponding *reportConfig* within *VarMeasConfig*, is fulfilled for one or more applicable cells not included in the *cellsTriggeredList* for all measurements after layer 3 filtering taken during *timeToTrigger* defined for this event within the *VarMeasConfig* (a subsequent cell triggers the event):
 - 3> set the *numberOfReportsSent* defined within the *VarMeasReportList* for this *measId* to 0;
 - 3> include the concerned cell(s) in the *cellsTriggeredList* defined within the *VarMeasReportList* for this *measId*;
 - 3> initiate the measurement reporting procedure, as specified in 5.5.5;
- 2> if the *triggerType* is set to 'event' and if the leaving condition applicable for this event is fulfilled for one or more of the cells included in the *cellsTriggeredList* defined within the *VarMeasReportList* for this *measId* for all measurements after layer 3 filtering taken during *timeToTrigger* defined within the *VarMeasConfig* for this event:
 - 3> remove the concerned cell(s) in the *cellsTriggeredList* defined within the *VarMeasReportList* for this *measId*;
 - 3> if *reportOnLeave* is set to *TRUE* for the corresponding reporting configuration:
 - 4> initiate the measurement reporting procedure, as specified in 5.5.5;
 - 3> if the *cellsTriggeredList* defined within the *VarMeasReportList* for this *measId* is empty:
- 4> remove the measurement reporting entry within the *VarMeasReportList* for this *measId*;
- 4> stop the periodical reporting timer for this *measId*, if running;
- ...
- 2> upon expiry of the periodical reporting timer for this *measId*:
 - 3> initiate the measurement reporting procedure, as specified in 5.5.5;
- ...

NOTE 2: The UE does not stop the periodical reporting with *triggerType* set to 'event' or to 'periodical' while the corresponding measurement is not performed due to the serving cell RSRP being equal to or better than *s-Measure* or due to the measurement gap not being setup.

...

[TS 36.331, clause 5.5.4.3]

The UE shall:

- 1> consider the entering condition for this event to be satisfied when condition A2-1, as specified below, is fulfilled;
- 1> consider the leaving condition for this event to be satisfied when condition A2-2, as specified below, is fulfilled;

InequalityA2-1 (Entering condition)

$$Ms + Hys < Thresh$$

InequalityA2-2 (Leaving condition)

$$M_s - H_{ys} > Thresh$$

The variables in the formula are defined as follows:

M_s is the measurement result of the serving cell, not taking into account any offsets.

H_{ys} is the hysteresis parameter for this event (i.e. *hysteresis* as defined within the *reportConfigEUTRA* for this event).

Thresh is the threshold parameter for this event (i.e. *a2-Threshold* as defined within the *reportConfigEUTRA* for this event).

M_s is expressed in dBm in case of RSRP, or in dB in case of RSRQ.

H_{ys} is expressed in dB.

Thresh is expressed in the same unit as ***M_s***.

[TS 36.331, clause 5.5.5]

...

For the *measId* for which the measurement reporting procedure was triggered, the UE shall set the *measResults* within the *MeasurementReport* message as follows:

1> set the *measId* to the measurement identity that triggered the measurement reporting;

1> set the *measResultServCell* to include the quantities of serving cell;

1> if there is at least one applicable neighbouring cell to report:

...

1> if the *includeLocationInfo* is configured in the corresponding *reportConfig* for this *measId* and detailed location information that has not been reported is available, set the content of the *locationInfo* as follows:

2> include the *locationCoordinates*;

2> if available, include the *gnss-TOD-msec*;

1> increment the *numberOfReportsSent* as defined within the *VarMeasReportList* for this *measId* by 1;

1> stop the periodical reporting timer, if running;

1> if the *numberOfReportsSent* as defined within the *VarMeasReportList* for this *measId* is less than the *reportAmount* as defined within the corresponding *reportConfig* for this *measId* :

2> start the periodical reporting timer with the value of *reportInterval* as defined within the corresponding *reportConfig* for this *measId*;

...

1> submit the *MeasurementReport* message to lower layers for transmission, upon which the procedure ends.

8.6.1.1.3 Test description

8.6.1.1.3.1 Pre-test conditions

System Simulator:

- Cell 1

Preamble:

- The UE's positioning engine (e.g. standalone GNSS receiver) should be provided with any necessary stimulus to allow it to provide the position. This shall be done by use of the test function Update UE Location Information defined in TS 36.509 [25] , if supported by the UE according to *pc_UpdateUE_LocationInformation*. Otherwise, or in addition any other suitable method may also be used.

- The UE is in state Generic RB Established (state 3) according to [18].

8.6.1.1.3.2 Test procedure sequence

Table 8.6.1.1.3.2-1 illustrates the downlink power levels to be applied for Cell 1 at various time instants of the test execution. Row marked "T0" denotes the conditions after the preamble, while rows marked "T1" and "T2" are to be applied subsequently. The exact instants on which these values shall be applied are described in the texts in this clause.

Table 8.6.1.1.3.2-1: Power levels

	Parameter	Unit	Cell 1	Remark
T0	Cell-specific RS EPRE	dBm/15 kHz	-70	Power level is such that $M_s > Thresh + Hys$
T1			-96	Power level is such that entry condition for event A2 is satisfied $M_s + Hys < Thresh$
T2			-70	Power level is such that exit condition for event A2 is satisfied $M_s > Thresh + Hys$
Note:	The total tolerance used is the sum of downlink signal level uncertainty (TS 36.508 clause 6.2.2.1) and absolute UE measurement accuracy (TS 36.133 clause 9).			

Table 8.6.1.1.3.2-2: Main behaviour

St	Procedure	Message Sequence		TP	Verdict
		U - S	Message		
1	The SS transmits an <i>RRCCONNECTIONRECONFIGURATION</i> message including <i>measConfig</i> to setup intra LTE measurement and reporting for event A2 with <i>includeLocationInfo</i> configured.	<--	<i>RRCCONNECTIONRECONFIGURATION</i>	-	-
2	The UE transmits an <i>RRCCONNECTIONRECONFIGURATIONCOMPLETE</i> message.	-->	<i>RRCCONNECTIONRECONFIGURATIONCOMPLETE</i>	-	-
3	The SS re-adjusts the cell-specific reference signal level according to row "T1" in table 8.6.1.1.3.2-1.	-	-	-	-
4	Check: Does the UE transmit a <i>MEASUREMENTREPORT</i> message to report event A2 with the UE <i>locationInfo</i> included?	-->	<i>MEASUREMENTREPORT</i>	1	P
5	The SS re-adjusts the cell-specific reference signal level according to row "T2" in table 8.6.1.1.3.2-1.	-	-	-	-
6	Wait and ignore <i>MEASUREMENTREPORT</i> messages for 5 s to allow change of power levels for Cell 1.	-	-	-	-
7	Check: Does the UE attempt to transmit an uplink message within the next 10s?	-	-	2	F

8.6.1.1.3.3 Specific message contents

Table 8.6.1.1.3.3-1: *RRCCONNECTIONRECONFIGURATION* (step 1, Table 8.6.1.1.3.2-2)

Derivation Path: 36.508 clause 4.6.1 table 4.6.1-8 with condition MEAS
--

Table 8.6.1.1.3.3-2: *MeasConfig* (step 1, Table 8.6.1.1.3.2-2)

Derivation path: 36.508 clause 4.6.6 table 4.6.6-1			
Information Element	Value/Remark	Comment	Condition
measConfig ::= SEQUENCE {			
measObjectToAddModList SEQUENCE (SIZE (1..maxObjectId)) OF SEQUENCE {	1 entry		
measObjectId[1]	IdMeasObject-f1		
measObject[1]	MeasObjectEUTRA-GENERIC(f1)		
}			
reportConfigToAddModList SEQUENCE (SIZE (1..maxReportConfigId)) OF SEQUENCE {	1 entry		
reportConfigId[1]	IdReportConfig-A2		
reportConfig[1]	ReportConfig-A2-H		
}			
measIdToAddModList SEQUENCE (SIZE (1..maxMeasId)) OF SEQUENCE {	1 entry		
measId[1]	1		
measObjectId[1]	IdMeasObject-f1		
reportConfigId[1]	IdReportConfig-A2		
}			
}			

Table 8.6.1.1.3.3-3: *ReportConfig-A2-H* (step 1, Table 8.6.1.1.3.2-2)

Derivation path: 36.508 clause 4.6.6 table 4.6.6-5 ReportConfigEUTRA-A2(-83)			
Information Element	Value/Remark	Comment	Condition
ReportConfigEUTRA ::= SEQUENCE {			
triggerType CHOICE {			
event SEQUENCE {			
hysteresis	6	3 dB	
}			
}			
reportAmount	r1		
includeLocationInfo-r10	true		
}			

Table 8.6.1.1.3.3-4: *MeasurementReport* (step 4, Table 8.6.1.1.3.2-2)

Derivation path: 36.508 table clause 4.6.1 table 4.6.1-5			
Information Element	Value/Remark	Comment	Condition
MeasurementReport ::= SEQUENCE {			
criticalExtensions CHOICE {			
c1 CHOICE {			
measurementReport-r8 SEQUENCE {			
measResults ::= SEQUENCE {			
measId	1		
measResultPCell ::= SEQUENCE {		Report Cell 1	
rsrpResult	(0..97)		
rsrqResult	(0..34)		
}			
measResultNeighCells CHOICE {}	Not present		
measResultForECID-r9	Not present		
locationInfo-r10 SEQUENCE {			
locationCoordinates-r10 CHOICE {			
ellipsoid-Point-r10	Any allowed value		
ellipsoidPointWithAltitude-r10	Any allowed value		
}			
measResultServFreqList-r10	Not present		
}			
}			
}			
}			

8.6.1.2 Immediate MDT / Reporting / Location information / Request from eNB / Event A2

8.6.1.2.1 Test Purpose (TP)

(1)

```
with { UE in E-UTRA RRC_CONNECTED state and measurement configured for event A2 with the
includeLocationInfo set to true and the obtainLocation set to setup }
ensure that {
  when { Serving cell becomes worse than absolute threshold minus hysteresis }
  then { UE sends MeasurementReport message with the locationInfo obtained after receiving
RRCConnectionReconfiguration message }
}
```

8.6.1.2.2 Conformance requirements

References: The conformance requirements covered in the present TC are specified in: TS 36.331, clauses 5.3.10.9 and 5.5.5.

[TS 36.331, clause 5.3.10.9]

The UE shall:

...

1> if the received *otherConfig* includes the *obtainLocation*:

2> attempt to have detailed location information available for any subsequent measurement report;

NOTE: The UE is requested to attempt to have valid detailed location information available whenever sending a measurement report for which it is configured to include available detailed location information. The UE may not succeed e.g. because the user manually disabled the GPS hardware, due to no/poor satellite coverage. Further details, e.g. regarding when to activate GNSS, are up to UE implementation.

[TS 36.331, clause 5.5.5]

The purpose of this procedure is to transfer measurement results from the UE to E-UTRAN.

For the *measId* for which the measurement reporting procedure was triggered, the UE shall set the *measResults* within the *MeasurementReport* message as follows:

...

- 1> if the *includeLocationInfo* is configured in the corresponding *reportConfig* for this *measId* and detailed location information that has not been reported is available, set the content of the *locationInfo* as follows:
 - 2> include the *locationCoordinates*;
 - 2> if available, include the *gnss-TOD-msec*;

8.6.1.2.3 Test description

8.6.1.2.3.1 Pre-test conditions

System Simulator:

- Cell 1.

UE:

None.

Preamble:

- The UE's positioning engine (e.g. standalone GNSS receiver) should be provided with any necessary stimulus to allow it to provide the position. This shall be done by use of the test function Update UE Location Information defined in TS 36.509 [25] , if supported by the UE according to *pc_UpdateUE_LocationInformation*. Otherwise, or in addition any other suitable method may also be used.
- The UE is in state Generic RB Established (state 3) on Cell 1 according to [18].

8.6.1.2.3.2 Test procedure sequence

Table 8.6.1.2.3.2-1 illustrates the downlink power levels to be applied for the cell at various time instants of the test execution. Row marked "T0" denotes the initial conditions after preamble, while columns marked "T1" is to be applied subsequently. The exact instants on which these values shall be applied are described in the texts in this clause.

Table 8.6.1.2.3.2-1: Time instances of cell power level and parameter changes

	Parameter	Unit	Cell 1	Remark
T0	Cell-specific RS EPRE	dBm/15k Hz	-70	The power level value is such that measurement result for Cell 1 satisfies leaving condition for event A2 ($M_s - H_{ys} > Thresh$).
T1	Cell-specific RS EPRE	dBm/15k Hz	-96	The power level value is such that measurement result for Cell 1 satisfies entering condition for event A2 ($M_s + H_{ys} < Thresh$).

Table 8.6.1.2.3.2-2: Main behaviour

St	Procedure	Message Sequence		TP	Verdict
		U - S	Message		
1	The SS transmits an <i>RRCCONNECTIONRECONFIGURATION</i> message to setup intra-frequency measurement for event A2 with <i>includeLocationInfo</i> set to <i>true</i> .	<--	<i>RRCCONNECTIONRECONFIGURATION</i>	-	-
2	The UE transmits an <i>RRCCONNECTIONRECONFIGURATIONCOMPLETE</i> message.	-->	<i>RRCCONNECTIONRECONFIGURATIONCOMPLETE</i>	-	-
3	The SS changes Cell 1 power level according to the row "T1" in table 8.6.1.2.3.2-1.	-	-	-	-
4	The UE transmits a <i>MEASUREMENTREPORT</i> message to report event A2 with <i>locationInfo</i> . (Note 1)	-->	<i>MEASUREMENTREPORT</i>	-	-
5	The SS changes Cell 1 power level according to the row "T0" in table 8.6.1.2.3.2-1.	-	-	-	-
6	The SS waits 10s.	-	-	-	-
7	The SS transmits an <i>RRCCONNECTIONRECONFIGURATION</i> message to modify intra-frequency measurement for event A2 with <i>includeLocationInfo</i> set to <i>true</i> and <i>obtainLocation</i> set to <i>setup</i> .	<--	<i>RRCCONNECTIONRECONFIGURATION</i>	-	-
8	The UE transmits an <i>RRCCONNECTIONRECONFIGURATIONCOMPLETE</i> message.	-->	<i>RRCCONNECTIONRECONFIGURATIONCOMPLETE</i>	-	-
9	The SS waits [60s] to ensure that the UE has detailed location information available. (NOTE 2)	-	-	-	-
10	The SS changes Cell 1 power level according to the row "T1" in table 8.6.1.2.3.2-1.	-	-	-	-
11	Check: Does the UE transmit a <i>MEASUREMENTREPORT</i> message to report event A2 with <i>locationInfo</i> ?	-->	<i>MEASUREMENTREPORT</i>	1	P
NOTE 1: The UE reports the detailed location information available stored in the UE. This intends to check that detailed location information reported in step 11 is obtained after receiving the <i>RRCCONNECTIONRECONFIGURATION</i> message in step 7.					
NOTE 2: Depending on UE's positioning engine used in this test case, any suitable method (e.g. test function Update UE Location Information defined in TS 36.509 [25]) may be used in this step to provide the position to the UE.					

8.6.1.2.3.3 Specific message contents

Table 8.6.1.2.3.3-1: *RRCCONNECTIONRECONFIGURATION* (step 1, Table 8.6.1.2.3.2-2)

Derivation Path: 36.508, Table 4.6.1-8 with condition MEAS
--

Table 8.6.1.2.3.3-2: MeasConfig (Table 8.6.1.2.3.3-1)

Derivation Path: 36.508, Table 4.6.6-1			
Information Element	Value/remark	Comment	Condition
MeasConfig ::= SEQUENCE {			
measObjectToAddModList SEQUENCE (SIZE (1..maxObjectId)) OF SEQUENCE{	1 entry		
measObjectId[1]	IdMeasObject-f1		
measObject[1]	MeasObjectEUTRA-GENERIC(f1)		
}			
reportConfigToAddModList SEQUENCE (SIZE (1..maxReportConfigId)) OF SEQUENCE {	1 entry		
reportConfigId[1]	IdReportConfig-A2		
reportConfig[1]	ReportConfigEUTRA-A2-RECONF		
}			
measIdToAddModList SEQUENCE (SIZE (1..maxMeasId)) OF SEQUENCE {	1 entry		
measId[1]	1		
measObjectId[1]	IdMeasObject-f1		
reportConfigId[1]	IdReportConfig-A2		
}			
}			

Table 8.6.1.2.3.3-3: ReportConfigEUTRA-A2-RECONF (Table 8.6.1.2.3.3-2)

Derivation Path: 36.508, Table 4.6.6-5 ReportConfigEUTRA-A2(-83)			
Information Element	Value/remark	Comment	Condition
ReportConfigEUTRA ::= SEQUENCE {			
triggerType CHOICE {			
event SEQUENCE {			
hysteresis	6	3dB	
}			
}			
si-RequestForHO-r9	Not present		
ue-RxTxTimeDiffPeriodical-r9	Not present		
includeLocationInfo-r10	true		
reportAddNeighMeas-r10	Not present		
}			

Table 8.6.1.2.3.3-4: MeasurementReport (steps 4 and 11, Table 8.6.1.2.3.2-2)

Derivation Path: 36.508, Table 4.6.1-5			
Information Element	Value/remark	Comment	Condition
MeasurementReport ::= SEQUENCE {			
criticalExtensions CHOICE {			
c1 CHOICE{			
measurementReport-r8 SEQUENCE {			
measResults SEQUENCE {			
measId	1		
measResultPCell SEQUENCE {			
rsrpResult	(0..97)		
rsrqResult	(0..34)		
}			
measResultNeighCells	Not present		
measResultForECID-r9	Not present		
locationInfo-r10	Any allowed value		
measResultServFreqList-r10	Not present		
}			
}			
}			
}			

Table 8.6.1.2.3.3-5: RRCConnectionReconfiguration (step 7, Table 8.6.1.2.3.2-2)

Derivation Path: 36.508, Table 4.6.1-8 with condition MEAS			
Information Element	Value/remark	Comment	Condition
RRCConnectionReconfiguration ::= SEQUENCE {			
criticalExtensions CHOICE {			
c1 CHOICE{			
rrcConnectionReconfiguration-r8 SEQUENCE {			
nonCriticalExtension SEQUENCE {			
lateNonCriticalExtension	Not present		
nonCriticalExtension SEQUENCE {			
otherConfig-r9 SEQUENCE {			
reportProximityConfig-r9	Not present		
idc-Config-r11	Not present		
powerPrefIndicationConfig-r11	Not present		
obtainLocationConfig-r11 SEQUENCE {			
obtainLocation-r11	setup		
}			
}			
fullConfig-r9	Not present		
nonCriticalExtension	Not present		
}			
}			
}			
}			

Table 8.6.1.2.3.3-6: *MeasConfig* (Table 8.6.1.2.3.3-5)

Derivation Path: 36.508, Table 4.6.6-1			
Information Element	Value/remark	Comment	Condition
MeasConfig ::= SEQUENCE {			
reportConfigToAddModList SEQUENCE (SIZE (1..maxReportConfigId)) OF SEQUENCE {	1 entry		
reportConfigId[1]	IdReportConfig-A2		
reportConfig[1]	ReportConfigEUTRA-A2-RECONF2		
}			
}			

Table 8.6.1.2.3.3-7: *ReportConfigEUTRA-A2-RECONF2* (Table 8.6.1.2.3.3-6)

Derivation Path: 36.508, Table 4.6.6-5 ReportConfigEUTRA-A2(-83)			
Information Element	Value/remark	Comment	Condition
ReportConfigEUTRA ::= SEQUENCE {			
triggerType CHOICE {			
event SEQUENCE {			
hysteresis	4	2dB	
}			
}			
si-RequestForHO-r9	Not present		
ue-RxTxTimeDiffPeriodical-r9	Not present		
includeLocationInfo-r10	true		
reportAddNeighMeas-r10	Not present		
}			

8.6.2 Logged MDT

8.6.2.1 Logged MDT / Intra-frequency measurement, logging and reporting

8.6.2.1.1 Test Purpose (TP)

(1)

```
with { UE in E-UTRA RRC_IDLE state camping normally on an E-UTRA cell where logged measurement is
configured without areaConfiguration and the UE is able to detect an E-UTRA intra-frequency cell }
ensure that {
  when { T330 is running }
  then { UE is logging serving cell idle mode measurements and Intra-frequency neighbouring cell
measurements }
}
```

(2)

```
with { UE in E-UTRA RRC_CONNECTED state and UE has one or more logged Intra-frequency neighbouring
cell measurement entries stored in VarLogMeasReport stored and the plmn-Identity stored in
VarLogMeasReport is equal to the RPLMN }
ensure that {
  when { receiving RRCConnectionSetup message }
  then { UE includes the logMeasAvailable IE in the RRCConnectionSetupComplete message }
}
```

(3)

```
with { UE in E-UTRA RRC_CONNECTED state and UE has logged Intra-frequency neighbouring cell
measurements available for E-UTRA and plmn-Identity stored in VarLogMeasReport is equal to the RPLMN
}
ensure that {
  when { receiving UEInformationRequest message }
  then { UE transmits UEInformationResponse messages with a logMeasReport with Intra-frequency
neighbouring cell measurements }
}
```

(4)

```

with { UE in E-UTRA RRC_CONNECTED state and UE has logged measurements available for E-UTRA and
plmn-Identity stored in VarLogMeasReport is equal to the RPLMN }
ensure that {
  when { receiving UEInformationRequest message }
  then { UE transmits UEInformationResponse messages with absoluteTimeStamp set equal to the value
configured when the logged measurement configuration was received and a relativeTimeStamp for each
logged measurement indicating the elapsed time since the logged measurement configuration was
received }
}

```

(5)

```

with { UE in E-UTRA RRC_CONNECTED state and UE has logged measurements available for E-UTRA and
plmn-Identity stored in VarLogMeasReport is equal to the RPLMN }
ensure that {
  when { receiving UEInformationRequest message }
  then { UE transmits UEInformationResponse messages with traceReference, traceRecordingSessionRef
and tce-Id being set to same values as configured when the logged measurement configuration was
received }
}

```

8.6.2.1.2 Conformance requirements

References: The conformance requirements covered in the current TC are specified in: TS 34.304, clause 8; TS 36.331, clauses 5.3.5.3, 5.5.4.1, 5.5.4.2 and 5.5.5.

[TS 36.304, clause 8 (TP1)]

The UE may be configured to perform logging of measurement results in RRC_IDLE mode with the *LoggedMeasurementsConfiguration* message as specified in TS 36.331 [3]. This configuration is valid while the logging duration timer is running.

If the configuration of logged measurements is valid, the UE shall perform logging of measurement results if all of the following conditions are met:

- The UE is in *camped normally* state in RRC_IDLE mode;
- RPLMN of the UE is the same as the RPLMN at the point of time of *LoggedMeasurementConfiguration* message reception;
- The UE is camped on a cell belonging to the *areaConfiguration* (see TS 36.331 [3]), if configured;
- The UE is camped on the RAT where the logged measurement configuration was received.

Otherwise, the logging of measurement results shall be suspended.

NOTE: Even if logging of measurement results is suspended, the logging duration timer and time stamp will continue, and the logged measurement configuration and corresponding log are kept.

[TS 36.331, clause 5.3.3.4 (TP2)]

The UE shall:

...

1> set the content of *RRCCConnectionSetupComplete* message as follows:

...

2> if the UE has logged measurements available for E-UTRA and *plmn-Identity* stored in *VarLogMeasReport* is equal to the RPLMN:

3> include *logMeasAvailable*;

2> submit the *RRCCConnectionSetupComplete* message to lower layers for transmission, upon which the procedure ends;

[TS 36.331, clause 5.6.5.3 (TP3, TP4, TP5)]

Upon receiving the *UEInformationRequest* message, the UE shall

...

- 1> if the *logMeasReportReq* is present and the *plmn-Identity* stored in *VarLogMeasReport* is equal to the RPLMN:
 - 2> if *VarLogMeasReport* includes one or more logged measurement entries, set the contents of the *logMeasReport* in the *UEInformationResponse* message as follows:
 - 3> include the *absoluteTimeStamp* and set it to the value of *absoluteTimeInfo* in the *VarLogMeasReport*;
 - 3> include the *traceReference* and set it to the value of *traceReference* in the *VarLogMeasReport*;
 - 3> include the *traceRecordingSessionRef* and set it to the value of *traceRecordingSessionRef* in the *VarLogMeasReport*;
 - 3> include the *tce-Id* and set it to the value of *tce-Id* in the *VarLogMeasReport*;
 - 3> include the *logMeasInfoList* and set it to include one or more entries from *VarLogMeasReport* starting from the entries logged first;
 - 3> if the *VarLogMeasReport* includes one or more additional logged measurement entries that are not included in the *logMeasInfoList* within the *UEInformationResponse* message:
 - 4> include the *logMeasAvailable*;
 - 1> if the *logMeasReport* is included in the *UEInformationResponse*:
 - 2> submit the *UEInformationResponse* message to lower layers for transmission via SRB2;
 - 2> discard the logged measurement entries included in the *logMeasInfoList* from *VarLogMeasReport* upon successful delivery of the *UEInformationResponse* message confirmed by lower layers;
 - 1> else:
 - 2> submit the *UEInformationResponse* message to lower layers for transmission via SRB1;

[TS 36.331, clause 5.6.6.3 (TP1, TP4, TP5)]

Upon receiving the *LoggedMeasurementConfiguration* message the UE shall:

- 1> discard the logged measurement configuration as well as the logged measurement information as specified in 5.6.7;
- 1> store the received *loggingDuration*, *loggingInterval* and *areaConfiguration*, if included, in *VarLogMeasConfig*;
- 1> store the RPLMN as *plmn-Identity* in *VarLogMeasReport*;
- 1> store the received *absoluteTimeInfo*, *traceReference*, *traceRecordingSessionRef* and *tce-Id* in *VarLogMeasReport*;
- 1> start timer T330 with the timer value set to the *loggingDuration*;

[TS 36.331, clause 5.6.8.2 (TP1, TP4)]

While T330 is running, the UE shall:

- 1> perform the logging in accordance with the following:
 - 2> if the UE is camping normally on an E-UTRA cell and the RPLMN of the UE is the same as the *plmn-Identity* stored in *VarLogMeasReport* and, if the cell is part of the area indicated by *areaConfiguration* if configured in *VarLogMeasConfig*:
 - 3> perform the logging at regular time intervals, as defined by the *loggingInterval* in *VarLogMeasConfig*;

- 2> when adding a logged measurement entry in *VarLogMeasReport*, include the fields in accordance with the following:
- 3> set the *relativeTimeStamp* to indicate the elapsed time since the moment at which the logged measurement configuration was received;
 - 3> if detailed location information became available during the last logging interval, set the content of the *locationInfo* as follows:
 - 4> include the *locationCoordinates*;
 - 3> set the *servCellIdentity* to indicate global cell identity of the cell the UE is camping on;
 - 3> set the *measResultServCell* to include the quantities of the cell the UE is camping on;
 - 3> if available, set the *measResultNeighCells*, in order of decreasing ranking-criterion as used for cell reselection, to include neighbouring cell measurements that became available during the last logging interval for at most the following number of neighbouring cells; 6 intra-frequency and 3 inter-frequency neighbours per frequency as well as 3 inter-RAT neighbours, per frequency/ set of frequencies (GERAN) per RAT;

NOTE: The UE includes the latest results of the available measurements as used for cell reselection evaluation, which are performed in accordance with the performance requirements as specified in TS 36.133 [16].

- 2> when the memory reserved for the logged measurement information becomes full, stop timer T330 and perform the same actions as performed upon expiry of T330, as specified in 5.6.6.4;

[TS 36.331, clause 6.2.2 (TP1)]

– LoggedMeasurementConfiguration

The *LoggedMeasurementConfiguration* message is used by E-UTRAN to configure the UE to perform logging of measurement results while in RRC_IDLE. It is used to transfer the logged measurement configuration for network performance optimisation, see TS 37.320 [60].

Signalling radio bearer: SRB1

RLC-SAP: AM

Logical channel: DCCH

Direction: E-UTRAN to UE

LoggedMeasurementConfiguration message

```
-- ASN1START
LoggedMeasurementConfiguration-r10 ::= SEQUENCE {
    criticalExtensions          CHOICE {
        c1                     CHOICE {
            loggedMeasurementConfiguration-r10    LoggedMeasurementConfiguration-r10-IEs,
            spare3 NULL, spare2 NULL, spare1 NULL
        },
        criticalExtensionsFuture          SEQUENCE {}
    }
}

LoggedMeasurementConfiguration-r10-IEs ::= SEQUENCE {
    traceReference-r10          TraceReference-r10,
    traceRecordingSessionRef-r10  OCTET STRING (SIZE (2)),
    tce-Id-r10                  OCTET STRING (SIZE (1)),
    absoluteTimeInfo-r10        AbsoluteTimeInfo-r10,
    areaConfiguration-r10        AreaConfiguration-r10          OPTIONAL, -- Need OR
    loggingDuration-r10          LoggingDuration-r10,
    loggingInterval-r10          LoggingInterval-r10,
    nonCriticalExtension          SEQUENCE {}                  OPTIONAL -- Need OP
}
-- ASN1STOP
```

<i>LoggedMeasurementConfiguration</i> field descriptions
<i>absoluteTimeInfo</i> Indicates the absolute time in the current cell.
<i>tce-Id</i> Parameter Trace Collection Entity Id: See TS 32.422 [58].
<i>traceRecordingSessionRef</i> Parameter Trace Recording Session Reference: See TS 32.422 [58]

8.6.2.1.3 Test description

8.6.2.1.3.1 Pre-test conditions

System Simulator:

- Two intra-frequency cells belonging to the same PLMN, but to different tracking areas: Cell 1, Cell 11
- Cell power levels are selected according to [18] so that camping on Cell 1 is guaranteed
- System information combination 2 as defined in TS 36.508 [18] clause 4.4.3.1 is used in E-UTRA cells with content of intra-frequency neighbouring cell list in SIB4 set as defined in TS 36.508 [18] table 6.3.1.1-1.

Preamble:

- The UE is in state Generic RB Established (state 3) according to [18] on Cell 1.

8.6.2.1.3.2 Test procedure sequence

Table 8.6.2.1.3.2-1 illustrates the downlink power levels and other changing parameters to be applied for the cells at various time instants of the test execution. The configuration marked "T1" is applied at the point indicated in the Main behaviour description in Table 8.6.2.1.3.2-2.

Table 8.6.2.1.3.2-1: Time instances of cell power level and parameter changes

	Parameter	Unit	Cell 1	Cell 11	Remark
T1	Cell-specific RS EPRE	dBm/ 15kHz z	-85	-79	The power level values are assigned to satisfy $R_{\text{Cell 1}} < R_{\text{Cell 11}}$.

Table 8.6.2.1.3.2-2: Main behaviour

St	Procedure	Message Sequence		TP	Verdict
		U - S	Message		
1	SS transmits a <i>LoggedMeasurementConfiguration</i> message including to configure the UE to perform logging of measurement results while in RRC_IDLE.	<--	<i>LoggedMeasurementConfiguration</i>	-	-
2	The SS transmits an <i>RRCConnectionRelease</i> message.	<--	<i>RRCConnectionRelease</i>	-	-
3	Wait 5s to allow UE to activate logging	-	-	-	-
4	The SS changes Cell 1 and Cell 11 levels according to the row "T1" in table 8.6.2.1.3.2-1. (Note 1)	-	-	-	-
5	The UE transmits an <i>RRCConnectionRequest</i> message on Cell 11 to initiate a tracking area update procedure. (Note 1)	-->	<i>RRCConnectionRequest</i>	-	-
6	SS transmit an <i>RRCConnectionSetup</i> message.	<--	RRC: <i>RRCConnectionSetup</i>	-	-
7	Check: Does the UE include the IE <i>logMeasAvailable</i> in the <i>RRCConnectionSetupComplete</i> message?	-->	RRC: <i>RRCConnectionSetupComplete</i> NAS: TRACKING AREA UPDATE REQUEST	2	P
8-10	Steps 4 to 6 of the generic test procedure in TS 36.508 subclause 6.4.2.7 are performed on Cell 11. NOTE: The UE performs a TAU procedure and the RRC connection is released.	-	-	-	-
11-19	Steps 1 to 9 of the generic radio bearer establishment procedure in TS 36.508 subclause 4.5.3.3 are executed to successfully complete the service request procedure on Cell 11.	-	-	-	-
20	The SS transmits a <i>UEInformationRequest</i> message on Cell 11.	<--	<i>UEInformationRequest</i>	-	-
21	Check: Does the UE transmit a <i>UEInformationResponse</i> message with the IEs <i>absoluteTimeStamp</i> , <i>traceReference-r10</i> , <i>traceRecordingSessionRef</i> and <i>tce-Id</i> set to same value as received in the <i>LoggedMeasurementConfiguration</i> message in step 1; and a <i>LogMeasInfoList</i> with at least two entries with serving cell idle mode measurements and where in at least one of the entries the IE <i>measResultListEUTRA</i> include a neighbouring cell measurement of Cell 11; and where the <i>relativeTimeStamp</i> is increased between the subsequent <i>LogMeasInfoList</i> entries by at least the value of configured <i>loggingInterval</i> in the received <i>LoggedMeasurementConfiguration</i> message in step 1.	-->	<i>UEInformationResponse</i>	1,3, 4,5	P
Note 1: The change of power levels is to trigger a cell re-selection procedure to make sure that the UE is logging neighbouring cell measurements (logging interval=2.56 seconds) of Cell 11 while t-Reselection timer is running (7 seconds).					

8.6.2.1.3.3 Specific message contents

Table 8.6.2.1.3.3-1: SystemInformationBlockType3 for cell 1 (preamble)

Derivation Path: 36.508 table 4.4.3.3-2		
Information Element	Value/remark	Comment
SystemInformationBlockType3 ::= SEQUENCE {		
intraFreqCellReselectionInfo SEQUENCE {		
t-ReselectionEUTRA	7	seconds
}		
}		

Table 8.6.2.1.3.3-2: LoggedMeasurementConfiguration (step 1, Table 8.6.2.1.3.2-2)

Derivation path: 36.508 clause 4.6.1 table 4.6.1-4.0A LoggedMeasurementConfiguration			
Information Element	Value/remark	Comment	Condition
LoggedMeasurementConfiguration-r10 ::= SEQUENCE {			
criticalExtensions CHOICE {			
C1 CHOICE {			
loggedMeasurementConfiguration-r10 SEQUENCE {			
loggingInterval-r10	ms2560	2.56 seconds	
}			
}			
}			
}			

Table 8.6.2.1.3.3-3: RRCConnectionSetupComplete (step 7, Table 8.6.2.1.3.2-2)

Derivation path: 36.508 clause 4.6.1 table 4.6.1-18 RRCConnectionSetupComplete			
Information Element	Value/remark	Comment	Condition
RRCConnectionSetupComplete ::= SEQUENCE {			
criticalExtensions CHOICE {			
c1 CHOICE {			
rrcConnectionSetupComplete-r8 SEQUENCE {			
lateNonCriticalExtension	Not checked		
gummei-Type-r10	Not checked		
rlf-InfoAvailable-r10	Not checked		
logMeasAvailable-r10	TRUE		
rn-SubframeConfigReq-r10	Not checked		
nonCriticalExtension SEQUENCE {}	Not checked		
}			
}			
}			
}			

Table 8.6.2.1.3.4: UEInformationRequest (step 20, Table 8.6.2.1.3.2-2)

Derivation Path: 36.508 clause 4.6.1 table 4.6.1-23A UEInformationRequest, condition "Logged MDT"

Table 8.6.2.1.3.3-5: *UEInformationResponse* (step 21, Table 8.6.2.1.3.2-2)

Derivation Path: 36.508 clause 4.6.1 table 4.6.1-23B <i>UEInformationResponse</i>			
Information Element	Value/remark	Comment	Condition
<i>UEInformationResponse</i> -r9 ::= SEQUENCE {			
<i>criticalExtensions</i> CHOICE {			
c1 CHOICE{			
<i>ueInformationResponse</i> -r9 SEQUENCE {			
<i>nonCriticalExtension</i> SEQUENCE {			
<i>lateNonCriticalExtension</i>	Not checked		
<i>nonCriticalExtension</i> SEQUENCE {			
<i>logMeasReport</i> -r10 SEQUENCE {			
<i>absoluteTimeStamp</i> -r10	Same value as sent by SS in <i>LoggedMeasurementCon- figuration</i> in step 1		

traceReference-r10SEQUENCE {			
plmn-Identity-r10 SEQUENCE {			
mcc SEQUENCE (SIZE (3)) OF MCC-NMC-Digit	Same value as sent by SS in <i>LoggedMeasurementConfiguration</i> in step 1		
mnc SEQUENCE (SIZE (2..3)) OF MCC-NMC-Digit	Same value as sent by SS in <i>LoggedMeasurementConfiguration</i> in step 1		
}			
traceRecordingSessionRef-r10	Same value as sent by SS in <i>LoggedMeasurementConfiguration</i> in step 1		
tce-Id-r10	Same value as sent by SS in <i>LoggedMeasurementConfiguration</i> in step 1		
logMeasInfoList-r10 SEQUENCE (SIZE (1..maxLogMeasReport-r10)) OF SEQUENCE {	At least 2 entries where at least one entry complies to entry with index 'x' below. SS records the relativeTimeStamp value for each entry		
locationInfo-r10[x]	Not checked		
relativeTimeStamp-r10 [x]	SS record the value		
servCellIdentity-r10 [x]	Same as Cell 1		
measResultServCell-r10 [x] SEQUENCE {			
rsrpResult-r10	(0..97)		
rsrqResult-r10	(0..34)		
}			
measResultNeighCells-r10 [x] SEQUENCE {			
measResultListEUTRA-r10 SEQUENCE (SIZE (1..maxFreq)) OF SEQUENCE {	1 entry		
carrierFreq-r9[1]	Same as Cell 11		
measResultList-r9[1] SEQUENCE (SIZE (1..maxCellReport)) OF SEQUENCE {	1 entry		
physCellId [1]	Same as Cell 11		
cgi-Info [1]	Not checked		
measResult [1] SEQUENCE {			
rsrpResult-r10	(0..97)		
rsrqResult-r10	(0..34)		
}			
}			
measResultListUTRA-r10	Not present		
measResultListGERAN-r10	Not present		
measResultListCDMA2000-r10	Not present		
}			
logMeasAvailable-r10	Not present		
nonCriticalExtension SEQUENCE {	Not checked		
}			
}			
}			
}			
}			

8.6.2.2 Logged MDT / Inter-frequency measurement, logging and reporting

8.6.2.2.1 Test Purpose (TP)

(1)

```
with { UE in E-UTRA RRC_IDLE state camping normally on an E-UTRA cell where logged
measurement is configured without areaConfiguration and the UE is able to detect an E-UTRA inter-
frequency cell }
ensure that {
  when { T330 is running }
  then { UE is logging Inter-frequency neighbouring cell measurements }
}
```

(2)

```
with { UE in E-UTRA RRC_CONNECTED state and UE has one or more logged Inter-frequency neighbouring
cell measurement entries stored in VarLogMeasReport stored and the plmn-Identity stored in
VarLogMeasReport is equal to the RPLMN }
ensure that {
  when { receiving UEInformationRequest message }
  then { UE transmits UEInformationResponse messages with a logMeasReport with Inter-frequency
neighbouring cell measurements }
}
```

8.6.2.2.2 Conformance requirements

References: The conformance requirements covered in the current TC are specified in: TS 34.304, clause 8; TS 36.331, clauses 5.6.5.3, 5.6.6.3 and 5.6.8.2.

[TS 36.304, clause 8 (TP1)]

The UE may be configured to perform logging of measurement results in RRC_IDLE mode with the *LoggedMeasurementsConfiguration* message as specified in TS 36.331 [3]. This configuration is valid while the logging duration timer is running.

If the configuration of logged measurements is valid, the UE shall perform logging of measurement results if all of the following conditions are met:

- The UE is in *camped normally* state in RRC_IDLE mode;
- RPLMN of the UE is the same as the RPLMN at the point of time of *LoggedMeasurementConfiguration* message reception;
- The UE is camped on a cell belonging to the *areaConfiguration* (see TS 36.331 [3]), if configured;
- The UE is camped on the RAT where the logged measurement configuration was received.

Otherwise, the logging of measurement results shall be suspended.

NOTE: Even if logging of measurement results is suspended, the logging duration timer and time stamp will continue, and the logged measurement configuration and corresponding log are kept.

[TS36.331, clause 5.6.5.3 (TP2)]

[TS 36.331, clause 5.6.5.3 (TP3, TP4, TP5)]

Upon receiving the *UEInformationRequest* message, the UE shall

...

1> if the *logMeasReportReq* is present and the *plmn-Identity* stored in *VarLogMeasReport* is equal to the RPLMN:

2> if *VarLogMeasReport* includes one or more logged measurement entries, set the contents of the *logMeasReport* in the *UEInformationResponse* message as follows:

....

- 3> include the *logMeasInfoList* and set it to include one or more entries from *VarLogMeasReport* starting from the entries logged first;
- 3> if the *VarLogMeasReport* includes one or more additional logged measurement entries that are not included in the *logMeasInfoList* within the *UEInformationResponse* message:
 - 4> include the *logMeasAvailable*;
- 1> if the *logMeasReport* is included in the *UEInformationResponse*:
 - 2> submit the *UEInformationResponse* message to lower layers for transmission via SRB2;
 - 2> discard the logged measurement entries included in the *logMeasInfoList* from *VarLogMeasReport* upon successful delivery of the *UEInformationResponse* message confirmed by lower layers;
- 1> else:
 - 2> submit the *UEInformationResponse* message to lower layers for transmission via SRB1;

[TS36.331, clause 5.6.6.3 (TP1)]

Upon receiving the *LoggedMeasurementConfiguration* message the UE shall:

- 1> discard the logged measurement configuration as well as the logged measurement information as specified in 5.6.7;
- 1> store the received *loggingDuration*, *loggingInterval* and *areaConfiguration*, if included, in *VarLogMeasConfig*;
- 1> store the RPLMN as *plmn-Identity* in *VarLogMeasReport*;
- 1> store the received *absoluteTimeInfo*, *traceReference*, *traceRecordingSessionRef* and *tce-Id* in *VarLogMeasReport*;
- 1> start timer T330 with the timer value set to the *loggingDuration*;

[TS36.331, clause 5.6.8.2 (TP1)]

While T330 is running, the UE shall:

- 1> perform the logging in accordance with the following:
 - 2> if the UE is camping normally on an E-UTRA cell and the RPLMN of the UE is the same as the *plmn-Identity* stored in *VarLogMeasReport* and, if the cell is part of the area indicated by *areaConfiguration* if configured in *VarLogMeasConfig*:
 - 3> perform the logging at regular time intervals, as defined by the *loggingInterval* in *VarLogMeasConfig*;
 - 2> when adding a logged measurement entry in *VarLogMeasReport*, include the fields in accordance with the following:
 - 3> set the *relativeTimeStamp* to indicate the elapsed time since the moment at which the logged measurement configuration was received;
 - 3> if detailed location information became available during the last logging interval, set the content of the *locationInfo* as follows:
 - 4> include the *locationCoordinates*;
 - 3> set the *servCellIdentity* to indicate global cell identity of the cell the UE is camping on;
 - 3> set the *measResultServCell* to include the quantities of the cell the UE is camping on;
 - 3> if available, set the *measResultNeighCells*, in order of decreasing ranking-criterion as used for cell re-selection, to include neighbouring cell measurements that became available during the last logging interval for at most the following number of neighbouring cells; 6 intra-frequency and 3 inter-frequency neighbours per frequency as well as 3 inter-RAT neighbours, per frequency/ set of frequencies (GERAN) per RAT;

NOTE: The UE includes the latest results of the available measurements as used for cell reselection evaluation, which are performed in accordance with the performance requirements as specified in TS 36.133 [16].

- 2> when the memory reserved for the logged measurement information becomes full, stop timer T330 and perform the same actions as performed upon expiry of T330, as specified in 5.6.6.4;

[TS36.331, clause 6.2.2 (TP1)]

– LoggedMeasurementConfiguration

The *LoggedMeasurementConfiguration* message is used by E-UTRAN to configure the UE to perform logging of measurement results while in RRC_IDLE. It is used to transfer the logged measurement configuration for network performance optimisation, see TS 37.320 [60].

Signalling radio bearer: SRB1

RLC-SAP: AM

Logical channel: DCCH

Direction: E-UTRAN to UE

LoggedMeasurementConfiguration message

```
-- ASN1START
LoggedMeasurementConfiguration-r10 ::= SEQUENCE {
    criticalExtensions          CHOICE {
        c1                      CHOICE {
            loggedMeasurementConfiguration-r10          LoggedMeasurementConfiguration-r10-IEs,
            spare3 NULL, spare2 NULL, spare1 NULL
        },
        criticalExtensionsFuture          SEQUENCE {}
    }
}

LoggedMeasurementConfiguration-r10-IEs ::= SEQUENCE {
    traceReference-r10          TraceReference-r10,
    traceRecordingSessionRef-r10  OCTET STRING (SIZE (2)),
    tce-Id-r10                  OCTET STRING (SIZE (1)),
    absoluteTimeInfo-r10       AbsoluteTimeInfo-r10,
    areaConfiguration-r10      AreaConfiguration-r10          OPTIONAL, -- Need OR
    loggingDuration-r10        LoggingDuration-r10,
    loggingInterval-r10        LoggingInterval-r10,
    nonCriticalExtension        SEQUENCE {}                  OPTIONAL -- Need OP
}
-- ASN1STOP
```

LoggedMeasurementConfiguration field descriptions

<i>absoluteTimeInfo</i>	Indicates the absolute time in the current cell.
<i>tce-Id</i>	Parameter Trace Collection Entity Id: See TS 32.422 [58].
<i>traceRecordingSessionRef</i>	Parameter Trace Recording Session Reference: See TS 32.422 [58]

8.6.2.2.3 Test description

8.6.2.2.3.1 Pre-test conditions

System Simulator:

- Two inter-frequency cells belonging to the same PLMN, but to different tracking areas: Cell 1 and Cell 23
- Cell power levels are selected according to [18] so that camping on Cell 1 is guaranteed

- System information combination 3 as defined in TS 36.508 [18] clause 4.4.3.1 is used in E-UTRA cells with content of inter-frequency neighbouring cell list in SIB5 set as defined in TS 36.508 [18] table 6.3.1.2-1.

Preamble:

- The UE is in state Generic RB Established (state 3) according to [18] on Cell 1.

8.6.2.2.3.2 Test procedure sequence

Table 8.6.2.2.3.2-1 illustrates the downlink power levels and other changing parameters to be applied for the cells at various time instants of the test execution. The configuration marked "T1" is applied at the point indicated in the Main behaviour description in Table 8.6.2.2.3.2-2.

Table 8.6.2.2.3.2-1: Time instances of cell power level and parameter changes

	Parameter	Unit	Cell 1	Cell 23	Remark
T1	Cell-specific RS EPRE	dBm/ 15kHz z	-85	-79	The power level values are assigned to satisfy $R_{\text{Cell 1}} < R_{\text{Cell 23}}$.

Table 8.6.2.2.3.2-2: Main behaviour

St	Procedure	Message Sequence		TP	Verdict
		U – S	Message		
1	SS transmits a <i>LoggedMeasurementConfiguration</i> message including to configure the UE to perform logging of measurement results while in RRC_IDLE.	<--	<i>LoggedMeasurementConfiguration</i>	-	-
2	The SS transmits an <i>RRCCONNECTIONRELEASE</i> message.	<--	<i>RRCCONNECTIONRELEASE</i>	-	-
3	Wait 5s to allow UE to activate logging	-	-	-	-
4	The SS changes Cell 1 and Cell 23 levels according to the row "T1" in table 8.6.2.2.3.2-1. (Note 1)	-	-	-	-
5-10	Steps 1 to 6 of the generic test procedure in TS 36.508 subclause 6.4.2.7 are performed on Cell 23. NOTE: The UE performs a TAU procedure and the RRC connection is released.	-	-	-	-
11-19	Steps 1 to 9 of the generic radio bearer establishment procedure in TS 36.508 subclause 4.5.3.3 are executed to successfully complete the service request procedure.	-	-	-	-
20	SS transmits a <i>UEINFORMATIONREQUEST</i> message.	<--	<i>UEINFORMATIONREQUEST</i>	-	-
21	Check: Does the UE transmit a <i>UEINFORMATIONRESPONSE</i> message with a <i>LogMeasInfoList</i> with at least one neighbouring cell measurement of Cell 23.	-->	<i>UEINFORMATIONRESPONSE</i>	1,2	P
Note 1: The change of power levels is to trigger the cell re-selection procedure to make sure that the UE is logging neighbouring cell measurements (logging interval=2.56 seconds) of Cell 23 while t-Reselection timer is running (7 seconds).					

8.6.2.2.3.3 Specific message contents

Table 8.6.2.1.3.3-1: SystemInformationBlockType5 for cell 1 (preamble)

Derivation Path: 36.508 table 4.4.3.3-4		
Information Element	Value/remark	Comment
SystemInformationBlockType5 ::= SEQUENCE {		
interFreqCarrierFreqList SEQUENCE (SIZE (1..maxFreq)) OF SEQUENCE {	1 entry	
t-ReselectionEUTRA[1]	7	Seconds
}		
}		

Table 8.6.2.2.3.3-2: LoggedMeasurementConfiguration (step 1, Table 8.6.2.2.3.2-2)

Derivation path: 36.508 clause 4.6.1 table 4.6.1-4.0A LoggedMeasurementConfiguration			
Information Element	Value/remark	Comment	Condition
LoggedMeasurementConfiguration-r10 ::= SEQUENCE {			
criticalExtensions CHOICE {			
c1 CHOICE {			
loggedMeasurementConfiguration-r10 SEQUENCE {			
loggingInterval-r10	Ms2560	2.56 seconds	
}			
}			
}			
}			

Table 8.6.2.2.3.3-3: UEInformationRequest (step 20, Table 8.6.2.2.3.2-2)

Derivation Path: 36.508 clause 4.6.1 table 4.6.1-23A UEInformationRequest, condition "Logged MDT"

Table 8.6.2.2.3.3-4: UEInformationResponse (step 21, Table 8.6.2.2.3.2-2)

Derivation Path: 36.508 clause 4.6.1 table 4.6.1-23B UEInformationResponse			
Information Element	Value/remark	Comment	Condition
UEInformationResponse-r9 ::= SEQUENCE {			
criticalExtensions CHOICE {			
c1 CHOICE{			
ueInformationResponse-r9 SEQUENCE {			
nonCriticalExtension SEQUENCE {			
lateNonCriticalExtension	Not checked		
nonCriticalExtension SEQUENCE {			
logMeasReport-r10 SEQUENCE {			
absoluteTimeStamp-r10	Note checked		
traceReference-r10SEQUENCE {}	Note checked		
traceRecordingSessionRef-r10	Note checked		
tce-Id-r10	Note checked		
logMeasInfoList-r10 SEQUENCE (SIZE (1..maxLogMeasReport-r10)) OF SEQUENCE {	At least 1 entries where at least one entry complies to entry with index 'x' below.		
locationInfo-r10[x]	Not checked		
relativeTimeStamp-r10 [x]	Not checked		
servCellIdentity-r10 [x]	Same as Cell 1		
measResultServCell-r10 [x] SEQUENCE {			
rsrpResult-r10	(0..97)		
rsrqResult-r10	(0..34)		
}			
measResultNeighCells-r10 [x] SEQUENCE			
{			
measResultListEUTRA-r10 SEQUENCE (SIZE (1..maxFreq)) OF SEQUENCE {	1 entry		
carrierFreq-r9[1]	Same as Cell 23		
measResultList-r9[1] SEQUENCE (SIZE (1..maxCellReport)) OF SEQUENCE {	1 entry		
physCellId [1]	Same as Cell 23		
cgi-Info [1]	Not checked		
measResult [1] SEQUENCE {			
rsrpResult-r10	(0..97)		
rsrqResult-r10	(0..34)		
}			
}			
measResultListUTRA-r10	Not present		
measResultListGERAN-r10	Not present		
measResultListCDMA2000-r10	Not present		
}			
}			
logMeasAvailable-r10	Not present		
}			
nonCriticalExtension SEQUENCE {	Not checked		
}			
}			
}			
}			

8.6.2.3 Logged MDT / Logging and reporting / Limiting area scope

8.6.2.3.1 Test Purpose (TP)

(1)

with { UE received *LoggedMeasurementConfiguration* message with a *cellGlobalIdList* on a LTE cell}
 ensure that {

```

when { UE camps on a LTE cell in the cellGlobalIdList}
then { UE performs logged measurements}
}

```

(2)

```

with { UE received LoggedMeasurementConfiguration message with a cellGlobalIdList on a LTE cell}
ensure that {
when { UE camps on a LTE cell not in the cellGlobalIdList}
then { UE does not perform logged measurements}
}

```

(3)

```

with { UE received LoggedMeasurementConfiguration message with a trackingAreaCodeList on a LTE cell}
ensure that {
when { UE camps on a LTE cell in the trackingAreaCodeList}
then { UE performs logged measurements }
}

```

(4)

```

with { UE received LoggedMeasurementConfiguration message with a trackingAreaCodeList on a LTE cell}
ensure that {
when { UE camps on a LTE cell not in the trackingAreaCodeList}
then { UE does not perform logged measurements }
}

```

8.6.2.3.2 Conformance requirements

References: The conformance requirements covered in the present TC are specified in: TS 36.304, clause 8; TS 36.331 clauses 5.6.6.3, 5.6.8.2, 6.3.4 and 6.3.6.

[TS 36.304, clause 8 (TP1,TP2,TP3,TP4)]

The UE may be configured to perform logging of measurement results in RRC_IDLE mode with the *LoggedMeasurementsConfiguration* message as specified in TS 36.331 [3]. This configuration is valid while the logging duration timer is running.

If the configuration of logged measurements is valid, the UE shall perform logging of measurement results if all of the following conditions are met:

- The UE is in *camped normally* state in RRC_IDLE mode;
- RPLMN of the UE is the same as the RPLMN at the point of time of *LoggedMeasurementConfiguration* message reception;
- The UE is camped on a cell belonging to the *areaConfiguration* (see TS 36.331 [3]), if configured;
- The UE is camped on the RAT where the logged measurement configuration was received.

Otherwise, the logging of measurement results shall be suspended.

NOTE 1: Even if logging of measurement results is suspended, the logging duration timer and time stamp will continue, and the logged measurement configuration and corresponding log are kept.

[TS 36.331, clause 5.6.6.3 (TP1,TP2,TP3,TP4)]

Upon receiving the *LoggedMeasurementConfiguration* message the UE shall:

- 1> discard the logged measurement configuration as well as the logged measurement information as specified in 5.6.7;
- 1> store the received *loggingDuration*, *loggingInterval* and *areaConfiguration*, if included, in *VarLogMeasConfig*;
- 1> store the RPLMN as *plmn-Identity* in *VarLogMeasReport*;

1> store the received *absoluteTimeInfo*, *traceReference*, *traceRecordingSessionRef* and *tce-Id* in *VarLogMeasReport*;

1> start timer T330 with the timer value set to the *loggingDuration*;

[TS 36.331, clause 5.6.8.2 (TP1,TP2,TP3,TP4)]

While T330 is running, the UE shall:

1> perform the logging in accordance with the following:

2> if the UE is camping normally on an E-UTRA cell and the RPLMN of the UE is the same as the *plmn-Identity* stored in *VarLogMeasReport* and, if the cell is part of the area indicated by *areaConfiguration* if configured in *VarLogMeasConfig*:

3> perform the logging at regular time intervals, as defined by the *loggingInterval* in *VarLogMeasConfig*;

2> when adding a logged measurement entry in *VarLogMeasReport*, include the fields in accordance with the following:

3> set the *relativeTimeStamp* to indicate the elapsed time since the moment at which the logged measurement configuration was received;

3> if detailed location information became available during the last logging interval, set the content of the *locationInfo* as follows:

4> include the *locationCoordinates*;

3> set the *servCellIdentity* to indicate global cell identity of the cell the UE is camping on;

3> set the *measResultServCell* to include the quantities of the cell the UE is camping on;

3> if available, set the *measResultNeighCells*, in order of decreasing ranking-criterion as used for cell reselection, to include neighbouring cell measurements that became available during the last logging interval for at most the following number of neighbouring cells; 6 intra-frequency and 3 inter-frequency neighbours per frequency as well as 3 inter-RAT neighbours, per frequency/ set of frequencies (GERAN) per RAT;

NOTE 2: The UE includes the latest results of the available measurements as used for cell reselection evaluation, which are performed in accordance with the performance requirements as specified in TS 36.133 [16].

2> when the memory reserved for the logged measurement information becomes full, stop timer T330 and perform the same actions as performed upon expiry of T330, as specified in 5.6.6.4;

[TS 36.331, clause 6.3.6 (TP1, TP2, TP3, TP4)]

The *AreaConfiguration* indicates area for which UE is requested to perform measurement logging. If not configured, measurement logging applies in the entire RPLMN of the UE at the point of receiving the configuration

AreaConfiguration information element

```
-- ASN1START
AreaConfiguration-r10 ::= CHOICE {
    cellGlobalIdList-r10      CellGlobalIdList-r10,
    trackingAreaCodeList-r10 TrackingAreaCodeList-r10
}
CellGlobalIdList-r10 ::= SEQUENCE (SIZE (1..32)) OF CellGlobalIdEUTRA
TrackingAreaCodeList-r10 ::= SEQUENCE (SIZE (1..8)) OF TrackingAreaCode
-- ASN1STOP
```

[TS 36.331, clause 6.3.4 (TP1,TP2)]

The IE *CellGlobalIdEUTRA* specifies the Evolved Cell Global Identifier (ECGI), the globally unique identity of a cell in E-UTRA.

CellGlobalIdEUTRA information element

```

-- ASN1START
CellGlobalIdEUTRA ::=
    plmn-Identity
    cellIdentity
}
SEQUENCE {
    PLMN-Identity,
    CellIdentity
}
-- ASN1STOP

```

[TS 36.331, clause 6.3.4 (TP3,TP4)]

The IE *TrackingAreaCode* is used to identify a tracking area within the scope of a PLMN, see TS 24.301 [35].

TrackingAreaCode information element

```

-- ASN1START
TrackingAreaCode ::=
    BIT STRING (SIZE (16))
-- ASN1STOP

```

8.6.2.3.3 Test description**8.6.2.3.3.1 Pre-test conditions**

System Simulator:

- Cell 1, Cell 2 and Cell 11.
- System information combination 2 as defined in TS 36.508 [18] clause 4.4.3.1 is used in E-UTRA cells.

UE:

None

Preamble:

- The UE is in state Generic RB Established (state 3) on Cell 1 according to [18]

8.6.2.3.3.2 Test procedure sequence

Table 8.6.2.3.3.2-1 shows the cell configurations used during the test. The configuration T0 indicates the initial conditions. Subsequent configurations marked "T1", "T2", "T3" and "T4" are applied at the points indicated in the Main behaviour description in Table 8.6.2.3.3.2-2.

Table 8.6.2.3.3.2-1: Cell configuration changes over time

	Parameter	Unit	Cell 1	Cell 2	Cell 11	Comments
T0	RS EPRE	dBm/15kHz	-85	-91	-91	Configure logged measurement with limiting area scope using <i>cellGlobalIdList</i>
T1	RS EPRE	dBm/15kHz	-91	-91	-85	Verify that UE is perform logging of Cell 11 (TP1, Cell 11 is not configured in <i>cellGlobalIdList</i>)
T2	RS EPRE	dBm/15kHz	-91	-85	-91	Verify that UE is not logging Cell 2 (TP2, Cell 2 is not configured in <i>cellGlobalIdList</i>) and then re-configure logged measurement with limiting area scope using <i>trackingAreaCodeList</i>
T3	RS EPRE	dBm/15kHz	-91	-91	-85	Verify that UE is not perform logging of Cell 11 (TP4, Cell 11 not in configured <i>trackingAreaCodeList</i>)
T4	RS EPRE	dBm/15kHz	-85	-91	-91	Verify that UE is logging Cell 1 (TP3, Cell 2 is in configured <i>trackingAreaCodeList</i>)

Table 8.6.2.3.3.2-2: Main behaviour

St	Procedure	Message Sequence		TP	Verdict
		U - S	Message		
1	The SS transmits a <i>LoggedMeasurementConfiguration</i> message with a <i>cellGlobalIdList</i> on Cell 1.	<--	<i>LoggedMeasurementConfiguration</i>	-	-
2	SS transmits a <i>RRCCConnectionRelease</i> message to release the RRC connection.	<--	<i>RRCCConnectionRelease</i>	-	-
3	The SS changes Cell 1, Cell 2 and Cell 11 level according to the row "T1" in Table 8.6.2.3.3.2-1.	-	-	-	-
4-9	Steps 1 to 6 of generic test procedure in TS 36.508 subclause 6.4.2.7. And the UE move to idle mode on Cell 11.	-	-	-	-
10	Wait 30 seconds for UE logging interval timer to expire at least once	-	-	-	-
11-18	Steps 2 to 9 of the generic radio bearer establishment procedure in TS 36.508 subclause 4.5.3.3 are executed to successfully complete the service request procedure on Cell 11.	-	-	-	-
19	The SS send a <i>UEInformationRequest</i> message to get <i>logMeasReport</i> .	<--	<i>UEInformationRequest</i>		
20	Check: Does the UE send an <i>UEInformationResponse</i> message including at least one <i>logMeasReport</i> with serving cell measurements for Cell 11?	-->	<i>UEInformationResponse</i>	1	P
21	SS transmits a <i>RRCCConnectionRelease</i> message to release the RRC connection.	<--	<i>RRCCConnectionRelease</i>	-	-
22	The SS changes Cell 1, Cell 2 and Cell 11 level according to the row "T2" in Table 8.6.2.3.3.2-1.	-	-	-	-
23-28	Steps 1 to 6 of generic test procedure in TS 36.508 subclause 6.4.2.7. And the UE move to idle mode on Cell 2.	-	-	-	-
29	Wait 30 seconds for UE logging interval timer to expire at least once	-	-	-	-
30	The SS transmits a <i>Paging</i> message.	<--	<i>Paging</i>	-	-
31	The UE transmits an <i>RRCCConnectionRequest</i> message.	-->	<i>RRCCConnectionRequest</i>	-	-
32	SS transmit an <i>RRCCConnectionSetup</i> message.	<--	<i>RRCCConnectionSetup</i>	-	-
-	EXCEPTION: In case the UE had performed a logging before the cell re-selection to Cell 2 then the steps 33a1-33a7 are executed.				
33a1	The UE transmit an <i>RRCCConnectionSetupComplete</i> message including <i>logMeasAvailable</i> IE set it to <i>true</i> .	-->	<i>RRCCConnectionSetupComplete</i>	-	-
33a2 - 33a5	Steps 6 to 9 of the generic radio bearer establishment procedure in TS 36.508 subclause 4.5.3.3 are executed to successfully complete the service request procedure on Cell 2.	-	-	-	-
33a6	The SS send an <i>UEInformationRequest</i> message to get <i>logMeasReport</i> .	<--	<i>UEInformationRequest</i>		
33a7	Check: Does the UE send an <i>UEInformationResponse</i> message with <i>logged serving cell measurements of Cell 2</i> ?	-->	<i>UEInformationResponse</i>	2	F
-	EXCEPTION: In case the UE had not performed any logging before the cell re-selection to Cell 2 then the step 33b1 is executed.	-	-	-	-
33b1	Check: Does UE transmit an <i>RRCCConnectionSetupComplete</i> message with <i>logMeasAvailable</i> IE not present?	-->	<i>RRCCConnectionSetupComplete</i>	2	P
34	The SS transmits a	<--	<i>LoggedMeasurementConfiguration</i>	-	-

	<i>LoggedMeasurementConfiguration</i> message with a <i>trackingAreaCodeList</i> on Cell 2.		<i>n</i>		
35	The SS transmits a <i>RRCCConnectionRelease</i> message to release RRC connection and move to RRC_IDLE on Cell 2.	<--	<i>RRCCConnectionRelease</i>	-	-
36	The SS changes Cell 1, Cell 2 and Cell 11 level according to the row "T3" in Table 8.6.2.3.3.2-1.	-	-	-	-
37-42	Steps 1 to 6 of generic test procedure in TS 36.508 subclause 6.4.2.7. And the UE move to idle mode on Cell 11.	-	-	-	-
43	The SS transmits a <i>Paging</i> message on Cell 11.	<--	<i>Paging</i>	-	-
44	The UE transmits an <i>RRCCConnectionRequest</i> message on Cell 11.	-->	<i>RRCCConnectionRequest</i>	-	-
45	The SS transmit an <i>RRCCConnectionSetup</i> message on Cell 11.	<--	<i>RRCCConnectionSetup</i>	-	-
-	EXCEPTION: In case the UE had performed a logging before the cell re-selection to Cell 11 then the steps 46a1-46a7 are executed.				
46a1	The UE transmit an <i>RRCCConnectionSetupComplete</i> message including <i>logMeasAvailable</i> IE set it to <i>true</i> .	-->	<i>RRCCConnectionSetupComplete</i>	-	-
46a2-46a5	Steps 6 to 9 of the generic radio bearer establishment procedure in TS 36.508 subclause 4.5.3.3 are executed to successfully complete the service request procedure on Cell 11.	-	-	-	-
46a6	The SS send a <i>UEInformationRequest</i> message to get <i>logMeasReport</i> .	<--	<i>UEInformationRequest</i>		
46a7	Check: Does the UE send an <i>UEInformationResponse</i> message with logged serving cell measurements of Cell 11?	-->	<i>UEInformationResponse</i>	4	F
-	EXCEPTION: In case the UE had not performed any logging before the cell re-selection to Cell 11 then the step 46b1 is executed.	-	-	-	-
46b1	Check: Does UE transmit an <i>RRCCConnectionSetupComplete</i> message with <i>logMeasAvailable</i> IE not present?	-->	<i>RRCCConnectionSetupComplete</i>	4	P
47	The SS transmits an <i>RRCCConnectionRelease</i> message to release the RRC connection.	<--	<i>RRCCConnectionRelease</i>	-	-
48	The SS changes Cell 1, Cell 2 and Cell 11 level according to the row "T4" in Table 8.6.2.3.3.2-1.	-	-	-	-
49-54	Steps 1 to 6 of generic test procedure in TS 36.508 subclause 6.4.2.7. And the UE move to idle mode on Cell 1.	-	-	-	-
55	Wait 30 seconds for UE logging interval timer to expire at least once	-	-	-	-
56-63	Steps 2 to 9 of the generic radio bearer establishment procedure in TS 36.508 subclause 4.5.3.3 are executed to successfully complete the service request procedure on Cell 1.	-	-	-	-
64	The SS send an <i>UEInformationRequest</i> message to get <i>logMeasReport</i> .	<--	<i>UEInformationRequest</i>		
65	Check: Does the UE send an <i>UEInformationResponse</i> include <i>logMeasReport</i> with logged serving cell measurements of Cell 1?	-->	<i>UEInformationResponse</i>	3	P

8.6.2.3.3.3 Specific message contents

Table 8.6.2.3.3.3-1: SystemInformationBlockType3 for cell 1 (preamble)

Derivation Path: 36.508 table 4.4.3.3-2			
Information Element	Value/remark	Comment	Condition
SystemInformationBlockType3 ::= SEQUENCE {			
intraFreqCellReselectionInfo SEQUENCE {			
t-ReselectionEUTRA	7	seconds	
}			
}			

Table 8.6.2.3.3.3-2: LoggedMeasurementConfiguration (step 1, Table 8.6.2.3.3.2-2)

Derivation path: 36.508 clause 4.6.1 table 4.6.1-4.0A LoggedMeasurementConfiguration			
Information Element	Value/remark	Comment	Condition
LoggedMeasurementConfiguration-r10 ::= SEQUENCE {			
criticalExtensions CHOICE {			
c1 CHOICE {			
loggedMeasurementConfiguration-r10 SEQUENCE {			
areaConfiguration-r10 CHOICE {			
cellGlobalIdList-r10 SEQUENCE {	1 entry		
plmn-Identity[1]	plmn-Identity of Cell 11		
cellIdentity[1]	cellIdentity of Cell 11		
}			
loggingInterval-r10	ms2560	2.56 seconds	
}			
}			
}			
}			

Table 8.6.2.3.3.3-3: UEInformationRequest (step 19, 33a6, 46a6 and 64, Table 8.6.2.3.3.2-2)

Derivation Path: 36.508 clause 4.6.1 table 4.6.1-23A UEInformationRequest, condition "Logged MDT"

Table 8.6.2.3.3.3-4: UEInformationResponse (step 20 and 33a7, Table 8.6.2.3.3.2-2)

Derivation Path: 36.508 clause 4.6.1 table 4.6.1-23B UEInformationResponse			
Information Element	Value/remark	Comment	Condition
UEInformationResponse-r9 ::= SEQUENCE {			
criticalExtensions CHOICE {			
c1 CHOICE {			
ueInformationResponse-r9 SEQUENCE {			
nonCriticalExtension SEQUENCE {			
lateNonCriticalExtension	Not checked		
nonCriticalExtension SEQUENCE {			
logMeasReport-r10 SEQUENCE {			
absoluteTimeStamp-r10	Same value as sent by SS in LoggedMeasurementConfiguration in step 1		

traceReference-r10SEQUENCE {			
plmn-Identity-r10 SEQUENCE {			
mcc SEQUENCE (SIZE (3)) OF MCC-NMC-Digit	Same value as sent by SS in <i>LoggedMeasurementConfiguration</i> in step 1		
mnc SEQUENCE (SIZE (2..3)) OF MCC-NMC-Digit	Same value as sent by SS in <i>LoggedMeasurementConfiguration</i> in step 1		
}			
traceId-r10	Same value as sent by SS in <i>LoggedMeasurementConfiguration</i> in step 1		
}			
traceRecordingSessionRef-r10	Same value as sent by SS in <i>LoggedMeasurementConfiguration</i> in step 1		
tce-Id-r10	Same value as sent by SS in <i>LoggedMeasurementConfiguration</i> in step 1		
logMeasInfoList-r10 SEQUENCE (SIZE (1..maxLogMeasReport-r10)) OF SEQUENCE {	At least one entry complies to entry with index 'x' below. SS records the relativeTimeStamp value for each entry		
locationInfo-r10[x]	Not checked		
relativeTimeStamp-r10 [x]	SS record the value		
servCellIdentity-r10 [x]	Same as Cell 11		
measResultServCell-r10 [x] SEQUENCE {			
rsrpResult-r10	(0..97)		
rsrqResult-r10	(0..34)		
}			
measResultNeighCells-r10{}	Not checked		
}			
logMeasAvailable-r10	Not present		
}			
nonCriticalExtension SEQUENCE {	Not checked		
}			
}			
}			
}			
}			
}			
}			
}			

Table 8.6.2.3.3-5: RRCConnectionSetupComplete (step 33a1 and 46a1, Table 8.6.2.3.3.2-2)

Derivation path: 36.508 clause 4.6.1 table 4.6.1-18 RRCConnectionSetupComplete			
Information Element	Value/remark	Comment	Condition
RRCConnectionSetupComplete ::= SEQUENCE {			
criticalExtensions CHOICE {			
c1 CHOICE {			
rrcConnectionSetupComplete-r8 SEQUENCE {			
nonCriticalExtension SEQUENCE {			
nonCriticalExtension SEQUENCE {			
lateNonCriticalExtension	Not checked		
gummei-Type-r10	Not checked		
rlf-InfoAvailable-r10	Not checked		
logMeasAvailable-r10	TRUE		
rn-SubframeConfigReq-r10	Not checked		
nonCriticalExtension SEQUENCE {}	Not checked		
}			
}			
}			
}			
}			

Table 8.6.2.3.3-6: RRCConnectionSetupComplete (step 33b1 and 46b1, Table 8.6.2.3.3.2-2)

Derivation path: 36.508 clause 4.6.1 table 4.6.1-18 RRCConnectionSetupComplete			
Information Element	Value/remark	Comment	Condition
RRCConnectionSetupComplete ::= SEQUENCE {			
criticalExtensions CHOICE {			
c1 CHOICE {			
rrcConnectionSetupComplete-r8 SEQUENCE {			
nonCriticalExtension SEQUENCE {			
nonCriticalExtension SEQUENCE {			
lateNonCriticalExtension	Not checked		
gummei-Type-r10	Not checked		
rlf-InfoAvailable-r10	Not checked		
logMeasAvailable-r10	Not present		
rn-SubframeConfigReq-r10	Not checked		
nonCriticalExtension SEQUENCE {}	Not checked		
}			
}			
}			
}			
}			

Table 8.6.2.3.3.3-7: *LoggedMeasurementConfiguration* (step 34, Table 8.6.2.3.3.2-2)

Derivation path: 36.508 clause 4.6.1 table 4.6.1-4.0A <i>LoggedMeasurementConfiguration</i>			
Information Element	Value/remark	Comment	Condition
LoggedMeasurementConfiguration-r10 ::= SEQUENCE {			
criticalExtensions CHOICE {			
c1 CHOICE {			
loggedMeasurementConfiguration-r10			
SEQUENCE {			
areaConfiguration-r10 CHOICE {			
trackingAreaCodeList -r10 SEQUENCE {	1 entry		
trackingAreaCode [1]	TAI-1		
}			
}			
loggingInterval-r10	ms2560	2.56 seconds	
}			
}			
}			

Table 8.6.2.3.3.3-8: *UEInformationResponse* (step 46a7, Table 8.6.2.3.3.2-2)

Derivation Path: 36.508 clause 4.6.1 table 4.6.1-23B <i>UEInformationResponse</i>			
Information Element	Value/remark	Comment	Condition
UEInformationResponse-r9 ::= SEQUENCE {			
criticalExtensions CHOICE {			
c1 CHOICE{			
ueInformationResponse-r9 SEQUENCE {			
nonCriticalExtension SEQUENCE {			
lateNonCriticalExtension	Not checked		
nonCriticalExtension SEQUENCE {			
logMeasReport-r10 SEQUENCE {			
absoluteTimeStamp-r10	Same value as sent by SS in <i>LoggedMeasurementConfiguration</i> in step 34		

traceReference-r10SEQUENCE {			
plmn-Identity-r10 SEQUENCE {			
mcc SEQUENCE (SIZE (3)) OF MCC-NMC-Digit	Same value as sent by SS in <i>LoggedMeasurementConfiguration</i> in step 34		
mnc SEQUENCE (SIZE (2..3)) OF MCC-NMC-Digit	Same value as sent by SS in <i>LoggedMeasurementConfiguration</i> in step 34		
}			
traceId-r10	Same value as sent by SS in <i>LoggedMeasurementConfiguration</i> in step 34		
}			
traceRecordingSessionRef-r10	Same value as sent by SS in <i>LoggedMeasurementConfiguration</i> in step 34		
tce-Id-r10	Same value as sent by SS in <i>LoggedMeasurementConfiguration</i> in step 34		
logMeasInfoList-r10 SEQUENCE (SIZE (1..maxLogMeasReport-r10)) OF SEQUENCE {	At least one entry complies to entry with index 'x' below. SS records the relativeTimeStamp value for each entry		
locationInfo-r10[x]	Not checked		
relativeTimeStamp-r10 [x]	SS record the value		
servCellIdentity-r10 [x]	Same as Cell 2		
measResultServCell-r10 [x] SEQUENCE {			
rsrpResult-r10	(0..97)		
rsrqResult-r10	(0..34)		
}			
measResultNeighCells-r10{}	Not checked		
}			
logMeasAvailable-r10	Not present		
}			
nonCriticalExtension SEQUENCE {	Not checked		
}			
}			
}			
}			
}			
}			

Table 8.6.2.3.3.3-9: UEInformationResponse (step 65, Table 8.6.2.3.3.2-2)

Derivation Path: 36.508 clause 4.6.1 table 4.6.1-23B <i>UEInformationResponse</i>			
Information Element	Value/remark	Comment	Condition
UEInformationResponse-r9 ::= SEQUENCE {			
criticalExtensions CHOICE {			
c1 CHOICE{			
ueInformationResponse-r9 SEQUENCE {			
nonCriticalExtension SEQUENCE {			
lateNonCriticalExtension	Not checked		
nonCriticalExtension SEQUENCE {			
logMeasReport-r10 SEQUENCE {			
absoluteTimeStamp-r10	Same value as sent by SS in <i>LoggedMeasurementConfiguration</i> in step 34		

8.6.2.3a.2 Conformance requirements

References: The conformance requirements covered in the present TC are specified in: TS 36.304, clause 8; TS 36.331, clauses 5.3.3.4, 5.6.5.3 and 5.6.8.2.

[TS 36.304, clause 8]

The UE may be configured to perform logging of measurement results in RRC_IDLE mode with the *LoggedMeasurementsConfiguration* message as specified in TS 36.331 [3]. This configuration is valid while the logging duration timer is running.

If the configuration of logged measurements is valid, the UE shall perform logging of measurement results if all of the following conditions are met:

- The UE is in *camped normally* state in RRC_IDLE mode;
- The RPLMN of the UE is the same as the RPLMN at the point of time of *LoggedMeasurementConfiguration* message reception, or is present in the *plmn-IdentityList* (see TS 36.331 [3]) if configured;
- The UE is camped on a cell belonging to the *areaConfiguration* (see TS 36.331 [3]), if configured;
- The UE is camped on the RAT where the logged measurement configuration was received.

Otherwise, the logging of measurement results shall be suspended.

NOTE: Even if logging of measurement results is suspended, the logging duration timer and time stamp will continue, and the logged measurement configuration and corresponding log are kept.

[TS 36.331, clause 5.3.3.4]

The UE shall:

...

1> set the content of *RRConnectionSetupComplete* message as follows:

...

2> if the UE has logged measurements available for E-UTRA and if the RPLMN is included in *plmn-IdentityList* stored in *VarLogMeasReport*:

3> include *logMeasAvailable*;

[TS 36.331, clause 5.6.5.3]

Upon receiving the *UEInformationRequest* message, the UE shall:

...

1> if the *logMeasReportReq* is present and if the RPLMN is included in *plmn-IdentityList* stored in *VarLogMeasReport*:

2> if *VarLogMeasReport* includes one or more logged measurement entries, set the contents of the *logMeasReport* in the *UEInformationResponse* message as follows:

3> include the *absoluteTimeStamp* and set it to the value of *absoluteTimeInfo* in the *VarLogMeasReport*;

3> include the *traceReference* and set it to the value of *traceReference* in the *VarLogMeasReport*;

3> include the *traceRecordingSessionRef* and set it to the value of *traceRecordingSessionRef* in the *VarLogMeasReport*;

3> include the *tce-Id* and set it to the value of *tce-Id* in the *VarLogMeasReport*;

3> include the *logMeasInfoList* and set it to include one or more entries from *VarLogMeasReport* starting from the entries logged first;

3> if the *VarLogMeasReport* includes one or more additional logged measurement entries that are not included in the *logMeasInfoList* within the *UEInformationResponse* message:

4> include the *logMeasAvailable*;

1> if the *logMeasReport* is included in the *UEInformationResponse*:

2> submit the *UEInformationResponse* message to lower layers for transmission via SRB2;

2> discard the logged measurement entries included in the *logMeasInfoList* from *VarLogMeasReport* upon successful delivery of the *UEInformationResponse* message confirmed by lower layers;

1> else:

2> submit the *UEInformationResponse* message to lower layers for transmission via SRB1;

[TS 36.331, clause 5.6.8.2]

While T330 is running, the UE shall:

1> perform the logging in accordance with the following:

2> if the UE is camping normally on an E-UTRA cell and if the RPLMN is included in *plmn-IdentityList* stored in *VarLogMeasReport* and, if the cell is part of the area indicated by *areaConfiguration* if configured in *VarLogMeasConfig*:

3> perform the logging at regular time intervals, as defined by the *loggingInterval* in *VarLogMeasConfig*;

8.6.2.3a.3 Test description

8.6.2.3a.3.1 Pre-test conditions

System Simulator:

- Cell 1 and Cell 12
- System information combination 3 as defined in TS 36.508 [18] clause 4.4.3.1 is used in E-UTRA cells.
- The PLMNs are identified in the test by the identifiers in Table 8.6.2.3a.3.1-1.

Table 8.6.2.3a.3.1-1: PLMN identifiers

Cell	PLMN name
1	PLMN1
12	PLMN2

UE:

None.

Preamble:

- The UE is registered on PLMN1 (Cell 1) using the procedure described in TS 36.508[18] clause 4.5.2.3 except that the ATTACH ACCEPT message indicates PLMN2 in the Equivalent PLMN list as described in Table 8.6.2.3a.3.3-5
- The UE is in state Generic RB Established (state 3) on Cell 1 according to [18].

8.6.2.3a.3.2 Test procedure sequence

Table 8.6.2.3a.3.2-1 illustrates the downlink power levels to be applied for the cell at various time instants of the test execution. Row marked "T0" denotes the initial conditions after preamble, while columns marked "T1" is to be applied subsequently. The exact instants on which these values shall be applied are described in the texts in this clause.

Table 8.6.2.3a.3.2-1: Time instances of cell power level and parameter changes

	Parameter	Unit	Cell 1	Cell 12	Remark
T0	Cell-specific RS EPRE	dBm/15kHz	-85	"Off"	Only Cell 1 is available. (NOTE 1)
T1	Cell-specific RS EPRE	dBm/15kHz	-85	-79	The power level values are assigned to satisfy $R_{Cell\ 1} < R_{Cell\ 12}$.

NOTE 1: Power level "Off" for E-UTRA cell is defined in TS 36.508 Table 6.2.2.1-1.

Table 8.6.2.3a.3.2-2: Main behaviour

St	Procedure	Message Sequence		TP	Verdict
		U - S	Message		
1	SS transmits a <i>LoggedMeasurementConfiguration</i> message including on Cell 1 to configure the UE to perform logging of measurement results while in RRC_IDLE.	<--	<i>LoggedMeasurementConfiguration</i>	-	-
2	The SS transmits an <i>RRCConnectionRelease</i> message on Cell 1.	<--	<i>RRCConnectionRelease</i>	-	-
3	The SS changes Cell 1 and Cell 12 levels according to the row "T1" in table 8.6.2.3a.3.2-1.	-	-	-	-
4	The generic test procedure in TS 36.508 subclause 6.4.2.7 is performed on Cell 12. NOTE: The UE performs a TAU procedure and the RRC connection is released.	-	-	-	-
5	Wait [5s] to allow UE to activate logging.	-	-	-	-
6-13	Steps 2 to 9 of the generic radio bearer establishment procedure in TS 36.508 subclause 4.5.3.3 are executed to successfully complete the service request procedure on Cell 12.	-	-	-	-
14	The SS transmits a <i>UEInformationRequest</i> message on Cell 12.	<--	<i>UEInformationRequest</i>	-	-
15	Check: Does the UE transmit a <i>UEInformationResponse</i> message with <i>LogMeasInfoList</i> on Cell 12?	-->	<i>UEInformationResponse</i>	1	P

8.6.2.3a.3.3 Specific message contents

Table 8.6.2.3a.3.3-1: LoggedMeasurementConfiguration (step 1, Table 8.6.2.3a.3.2-2)

Derivation Path: 36.508, Table 4.6.1-4.0A			
Information Element	Value/remark	Comment	Condition
LoggedMeasurementConfiguration-r10 ::= SEQUENCE {			
criticalExtensions CHOICE {			
c1 CHOICE {			
loggedMeasurementConfiguration-r10 SEQUENCE {			
areaConfiguration-r10 CHOICE {			
trackingAreaCodeList-r10 SEQUENCE (SIZE (1..8)) OF {	1 entry		
TrackingAreaCode [1]	TAI-1		
}			
}			
nonCriticalExtension SEQUENCE {			
lateNonCriticalExtension-r10	Not present		
nonCriticalExtension SEQUENCE {			
plmn-IdentityList-r11 SEQUENCE (SIZE (1..16)) OF {	1 entry		
PLMN-Identity [1]	PLMN2		
}			
areaConfiguration-v1130 SEQUENCE {			
trackingAreaCodeList-v1130 SEQUENCE {			
plmn-Identity-perTAC-List-r11 SEQUENCE (SIZE (1..8)) OF {	1 entry		
PLMN-Identity [1]	PLMN2		
}			
}			
}			
nonCriticalExtension	Not present		
}			
}			
}			
}			

Table 8.6.2.3a.3.3-2: RRCConnectionSetupComplete (steps 4 and 9, Table 8.6.2.3a.3.2-2)

Derivation Path: 36.508, Table 4.6.1-18			
Information Element	Value/remark	Comment	Condition
RRCConnectionSetupComplete ::= SEQUENCE {			
criticalExtensions CHOICE {			
c1 CHOICE{			
rrcConnectionSetupComplete-r8 SEQUENCE {			
nonCriticalExtension SEQUENCE {			
nonCriticalExtension SEQUENCE {			
gummei-Type-r10	Not present or any allowed value		
rlf-InfoAvailable-r10	Not present or any allowed value		
logMeasAvailable-r10	true		
rn-SubframeConfigReq-r10	Not present or any allowed value		
nonCriticalExtension	Not present		
}			
}			
}			
}			
}			
}			

Table 8.6.2.3a.3.3-3: UEInformationRequest (step 14, Table 8.6.2.3a.3.2-2)

Derivation Path: 36.508, Table 4.6.1-23A condition Logged MDT

Table 8.6.2.3a.3.3-4: *UEInformationResponse* (step 15, Table 8.6.2.3a.3.2-2)

Derivation Path: 36.508, Table 4.6.1-23B			
Information Element	Value/remark	Comment	Condition
UEInformationResponse-r9 ::=SEQUENCE {			
criticalExtensions CHOICE {			
c1 CHOICE {			
ueInformationResponse-r9 SEQUENCE {			
nonCriticalExtension SEQUENCE {			
nonCriticalExtension SEQUENCE {			
logMeasReport-r10 SEQUENCE {			
absoluteTimeStamp-r10	Same value as sent by SS in <i>LoggedMeasurementConfiguration</i> in step 1		
traceReference-r10 SEQUENCE {			
plmn-Identity-r10 SEQUENCE {			
mcc SEQUENCE (SIZE (3)) OF MCC-MNC-Digit	Same value as sent by SS in <i>LoggedMeasurementConfiguration</i> in step 1		
mnc SEQUENCE (SIZE (2..3)) OF MCC-MNC-Digit	Same value as sent by SS in <i>LoggedMeasurementConfiguration</i> in step 1		
}			
traceId-r10	Same value as sent by SS in <i>LoggedMeasurementConfiguration</i> in step 1		
}			
traceRecordingSessionRef-r10	Same value as sent by SS in <i>LoggedMeasurementConfiguration</i> in step 1		
tce-Id-r10	Same value as sent by SS in <i>LoggedMeasurementConfiguration</i> in step 1		
logMeasInfoList-r10 SEQUENCE {	All entries comply to entry with index 'x' below.		
locationInfo-r10 [x]	Not present or any allowed value		
relativeTimeStamp-r10 [x]	Any allowed value		
servCellIdentity-r10 [x] SEQUENCE {			
plmn-Identity [x]	<i>plmn-Identity</i> within <i>SystemInformationBlockType1</i> broadcasted in Cell 12		
cellIdentity [x]	<i>cellIdentity</i> within <i>SystemInformationBlockType1</i> broadcasted in Cell 12		
}			
measResultServCell-r10 [x] SEQUENCE {			
rsrpResult-r10 [x]	(0..97)		
rsrqResult-r10 [x]	(0..34)		
}			
measResultNeighCells-r10 SEQUENCE {			
measResultListEUTRA-r10 SEQUENCE {	1 entry		
carrierFreq-r9 [1]	Same downlink EARFCN as used for Cell 1		
measResultList-r9 [1] SEQUENCE {			
physCellId [1]	PhysicalCellId of Cell 1		
cgi-Info [1]	Not present		
measResult [1] SEQUENCE {			

rsrpResult [1]	Not present or (0..97)		
rsrqResult [1]	Not present or (0..34)		
additionalSI-Info-r9	Not present		
}			
}			
measResultListUTRA-r10	Not present		
measResultListGERAN-r10	Not present		
measResultListCDMA2000-r10	Not present		
}			
}			
logMeasAvailable-r10	Not present		
}			
nonCriticalExtension	Not present		
}			
}			
}			
}			
}			
}			

Table 8.6.2.3a.3.3-5: ATTACH ACCEPT for Cell 1 (preamble)

Derivation path: 36.508 Table 4.7.2-1			
Information Element	Value/Remark	Comment	Condition
Equivalent PLMNs	PLMN2		

8.6.2.4 Logged MDT / logging and reporting / Indication of logged measurements at E-UTRA handover

8.6.2.4.1 Test Purpose (TP)

(1)

```
with { UE received LoggedMeasurementConfiguration message and has stored logMeasReport in
VarLogMeasReport }
ensure that {
  when { UE receives an RRCCConnectionReconfiguration message including a mobilityControlInfo }
  then { UE transmits an RRCCConnectionReconfigurationComplete message with logMeasAvailable is
true }
}
```

(2)

```
with { UE having indicated availability of logged measurements in RRCCConnectionReconfiguration
message }
ensure that {
  when { UE has completed the E-UTRA handover procedure and receives a UEInformationRequest message
with logMeasReportReq present }
  then { UE transmits an UEInformationResponse message including logMeasReport }
```

8.6.2.4.2 Conformance requirements

References: The conformance requirements covered in the present TC are specified in: TS 36.331, clauses 5.3.5.4 and 5.6.5.3.

[TS 36.331, clause 5.3.5.4 (TP1)]

If the *RRCCConnectionReconfiguration* message includes the *mobilityControlInfo* and the UE is able to comply with the configuration included in this message, the UE shall:

....

1> set the content of *RRCCConnectionReconfigurationComplete* message as follows:

- 2> if the UE has radio link failure or handover failure information available in *VarRLF-Report* and *plmn-Identity* stored in *VarRLF-Report* is equal to the RPLMN:
 - 3> include *rlf-InfoAvailable*;
- 2> if the UE has logged measurements available for E-UTRA and *plmn-Identity* stored in *VarLogMeasReport* is equal to the RPLMN:
 - 3> include the *logMeasAvailable*;
- 1> submit the *RRCCONNECTIONRECONFIGURATIONCOMPLETE* message to lower layers for transmission;
- 1> if MAC successfully completes the random access procedure:
 - 2> stop timer T304;
 - 2> apply the parts of the CQI reporting configuration, the scheduling request configuration and the sounding RS configuration that do not require the UE to know the SFN of the target PCell, if any;
 - 2> apply the parts of the measurement and the radio resource configuration that require the UE to know the SFN of the target PCell (e.g. measurement gaps, periodic CQI reporting, scheduling request configuration, sounding RS configuration), if any, upon acquiring the SFN of the target PCell;

NOTE 3: Whenever the UE shall setup or reconfigure a configuration in accordance with a field that is received it applies the new configuration, except for the cases addressed by the above statements.

- 2> the procedure ends;

NOTE 4: The UE is not required to determine the SFN of the target PCell by acquiring system information from that cell before performing RACH access in the target PCell.

[TS 36.331, clause 5.6.5.3 (TP2)]

Upon receiving the *UEInformationRequest* message, the UE shall:

...

- 1> if the *logMeasReportReq* is present and the *plmn-Identity* stored in *VarLogMeasReport* is equal to the RPLMN:
 - 2> if *VarLogMeasReport* includes one or more logged measurement entries, set the contents of the *logMeasReport* in the *UEInformationResponse* message as follows:
 - 3> include the *absoluteTimeStamp* and set it to the value of *absoluteTimeInfo* in the *VarLogMeasReport*;
 - 3> include the *traceReference* and set it to the value of *traceReference* in the *VarLogMeasReport*;
 - 3> include the *traceRecordingSessionRef* and set it to the value of *traceRecordingSessionRef* in the *VarLogMeasReport*;
 - 3> include the *tce-Id* and set it to the value of *tce-Id* in the *VarLogMeasReport*;
 - 3> include the *logMeasInfoList* and set it to include one or more entries from *VarLogMeasReport* starting from the entries logged first;
 - 3> if the *VarLogMeasReport* includes one or more additional logged measurement entries that are not included in the *logMeasInfoList* within the *UEInformationResponse* message:
 - 4> include the *logMeasAvailable*;
 - 1> if the *logMeasReport* is included in the *UEInformationResponse*:
 - 2> submit the *UEInformationResponse* message to lower layers for transmission via SRB2;
 - 2> discard the logged measurement entries included in the *logMeasInfoList* from *VarLogMeasReport* upon successful delivery of the *UEInformationResponse* message confirmed by lower layers;
 - 1> else:

2> submit the *UEInformationResponse* message to lower layers for transmission via SRB1;

8.6.2.4.3 Test description

8.6.2.4.3.1 Pre-test conditions

System Simulator:

- Cell 1 and Cell 4.
- System information combination 2 as defined in TS 36.508 [18] clause 4.4.3.1 is used in E-UTRA cells with content of intra-frequency neighbouring cell list in SIB4 set as defined in TS 36.508 [18] table 6.3.1.1-1.

UE:

None

Preamble:

- The UE is in state Generic RB Established (state 3) on Cell 1 according to [18].

8.6.2.4.3.2 Test procedure sequence

Table 8.6.2.4.3.2-1 shows the cell configurations used during the test. The configuration T0 indicates the initial conditions. Subsequent configurations marked "T1" are applied at the points indicated in the Main behaviour description in Table 8.6.2.4.3.2-2.

Table 8.6.2.4.3.2-1: Cell configuration changes over time

	Parameter	Unit	Cell 1	Cell 4	Remark
T0	RS EPRE	dBm/15kHz	-85	-91	The power level values are such that measurement results for Cell 1 (M1) and Cell 4 (M4) satisfy exit condition for event A3 ($M4 < M1$).
T1	RS EPRE	dBm/15kHz	-85	-79	The power level values are such that measurement results for Cell 1 (M1) and Cell 4 (M4) satisfy entry condition for event A3 ($M4 > M1$).

Table 8.6.2.4.3.2-2: Main behaviour

St	Procedure	Message Sequence		TP	Verdict
		U - S	Message		
1	The SS transmits a <i>LoggedMeasurementConfiguration</i> message on Cell 1.	<--	<i>LoggedMeasurementConfiguration</i>	-	-
2	The SS transmits a <i>RRCConnectionRelease</i> message to release the RRC connection.	<--	<i>RRCConnectionRelease</i>	-	-
3	Wait 30 seconds for UE performing the logging at regular time intervals	-	-	-	-
4-11	Steps 2 to 9 of the generic radio bearer establishment procedure in TS 36.508 subclause 4.5.3.3 are executed to successfully complete the service request procedure.	-	-	-	-
12	The SS changes Cell 1 and Cell 4 parameters according to the row "T1" in table 8.6.2.4.3.2-1.	-	-	-	-
13	The SS transmits an <i>RRCConnectionReconfiguration</i> message on Cell 1 to order the UE to perform intra frequency handover to Cell 4.	<--	<i>RRCConnectionReconfiguration</i>	-	-
14	Check: Does the UE transmit an <i>RRCConnectionReconfigurationComplete</i> message on Cell 4 with <i>logMeasAvailable</i> is true confirm the successful completion of the intra frequency handover?	-->	<i>RRCConnectionReconfigurationComplete</i>	1	P
15	The SS send an <i>UEInformationRequest</i> message to get <i>logMeasReport</i> .	<--	<i>UEInformationRequest</i>		
16	Check: Does the UE send an <i>UEInformationResponse</i> message include <i>logMeasReport</i> .	-->	<i>UEInformationResponse</i>	2	P

8.6.2.4.3.3 Specific message contents

Table 8.6.2.4.3.3-1: *SystemInformationBlockType3* for cell 1 (preamble)

Derivation Path: 36.508 table 4.4.3.3-2			
Information Element	Value/remark	Comment	Condition
<i>SystemInformationBlockType3</i> ::= SEQUENCE {			
<i>intraFreqCellReselectionInfo</i> SEQUENCE {			
<i>t-ReselectionEUTRA</i>	7	seconds	
}			
}			

Table 8.6.2.4.3.3-2: *LoggedMeasurementConfiguration* (step 1, Table 8.6.2.4.3.2-2)

Derivation path: 36.508 clause 4.6.1 table 4.6.1-4.0A <i>LoggedMeasurementConfiguration</i>			
Information Element	Value/remark	Comment	Condition
<i>LoggedMeasurementConfiguration-r10</i> ::= SEQUENCE {			
<i>criticalExtensions</i> CHOICE {			
<i>c1</i> CHOICE {			
<i>loggedMeasurementConfiguration-r10</i>			
SEQUENCE {			
<i>loggingInterval-r10</i>	ms2560	2.56 seconds	
}			
}			
}			
}			

Table 8.6.2.4.3.3-3: RRCConnectionReconfigurationComplete (step 14, Table 8.6.2.4.3.2-2)

Derivation path: 36.508 clause 4.6.1 table 4.6.1-9 RRCConnectionReconfigurationComplete			
Information Element	Value/remark	Comment	Condition
RRCConnectionReconfigurationComplete ::= SEQUENCE {			
criticalExtensions CHOICE {			
rrcConnectionReconfigurationComplete-r8			
SEQUENCE {			
nonCriticalExtension SEQUENCE {			
nonCriticalExtension SEQUENCE {			
rif-InfoAvailable-r10	Not checked		
logMeasAvailable-r10	TRUE		
nonCriticalExtension SEQUENCE {}	Not checked		
}			
}			
}			
}			
}			

Table 8.6.2.4.3.3-4: UEInformationRequest (step 15, Table 8.6.2.4.3.2-2)

Derivation Path: 36.508 clause 4.6.1 table 4.6.1-23A UEInformationRequest, condition "Logged MDT"

Table 8.6.2.4.3.3-5: UEInformationResponse (step 16, Table 8.6.2.4.3.2-2)

Derivation Path: 36.508 clause 4.6.1 table 4.6.1-23B UEInformationResponse			
Information Element	Value/remark	Comment	Condition
UEInformationResponse-r9 ::= SEQUENCE {			
criticalExtensions CHOICE {			
c1 CHOICE{			
ueInformationResponse-r9 SEQUENCE {			
nonCriticalExtension SEQUENCE {			
lateNonCriticalExtension	Not checked		
nonCriticalExtension SEQUENCE {			
logMeasReport-r10 SEQUENCE {			
absoluteTimeStamp-r10	Same value as sent by SS in <i>LoggedMeasurementConfiguration</i> in step 1		
traceReference-r10 SEQUENCE {			
plmn-Identity-r10 SEQUENCE {			
mcc SEQUENCE (SIZE (3)) OF MCC-NMC-Digit	Same value as sent by SS in <i>LoggedMeasurementConfiguration</i> in step 1		
mnc SEQUENCE (SIZE (2..3)) OF MCC-NMC-Digit	Same value as sent by SS in <i>LoggedMeasurementConfiguration</i> in step 1		

}			
traceId-r10	Same value as sent by SS in <i>LoggedMeasurementConfiguration</i> in step 1		
}			
traceRecordingSessionRef-r10	Same value as sent by SS in <i>LoggedMeasurementConfiguration</i> in step 1		
tce-Id-r10	Same value as sent by SS in <i>LoggedMeasurementConfiguration</i> in step 1		
logMeasInfoList-r10 SEQUENCE (SIZE (1..maxLogMeasReport-r10)) OF SEQUENCE {	At least one entry complies to entry with index 'x' below. SS records the <i>relativeTimeStamp</i> value for each entry		
locationInfo-r10[x]	Not checked		
relativeTimeStamp-r10 [x]	SS record the value		
servCellIdentity-r10 [x]	Same as Cell 1		
measResultServCell-r10 [x] SEQUENCE {			
rsrpResult-r10	(0..97)		
rsrqResult-r10	(0..34)		
}			
measResultNeighCells-r10{}	Not checked		
}			
logMeasAvailable-r10	Not present		
}			
nonCriticalExtension SEQUENCE {	Not checked		
}			
}			
}			
}			
}			
}			

8.6.2.5 Logged MDT / Logging and reporting / Indication of logged measurements at E-UTRA re-establishment

8.6.2.5.1 Test Purpose (TP)

(1)

```
with { UE received LoggedMeasurementConfiguration message and has stored logMeasReport in VarLogMeasReport }
ensure that {
  when { UE has initiated a re-establishment procedure and receives an RRConnectionReestablishment message }
  then { UE transmits an RRConnectionReestablishmentComplete message with logMeasAvailable is true }
}
```

(2)

```
with { UE indicated availability of logged measurements in RRConnectionReestablishmentComplete message }
ensure that {
  when { UE has successfully completes the re-establishment procedure and resume the existing radio bearer; and has receive a UEInformationRequest message with logMeasReportReq present }
  then { UE transmits an UEInformationResponse message including logMeasReport }
```

8.6.2.5.2 Conformance requirements

References: The conformance requirements covered in the present TC are specified in: TS 36.331, clauses 5.3.7.5 and 5.6.5.3.

[TS 36.331, clause 5.3.7.5 (TP1)]

The UE shall:

- 1> stop timer T301;
- ...
- 1> set the content of *RRCConnectionReestablishmentComplete* message as follows:
 - 2> if the UE has radio link failure or handover failure information available in *VarRLF-Report* and *plmn-Identity* stored in *VarRLF-Report* is equal to the RPLMN:
 - 3> include the *rlf-InfoAvailable*;
 - 2> if the UE has logged measurements available for E-UTRA and *plmn-Identity* stored in *VarLogMeasReport* is equal to the RPLMN:
 - 3> include the *logMeasAvailable*;
- 1> perform the measurement related actions as specified in 5.5.6.1;
- 1> perform the measurement identity autonomous removal as specified in 5.5.2.2a;
- 1> submit the *RRCConnectionReestablishmentComplete* message to lower layers for transmission, upon which the procedure ends;

[TS 36.331, clause 5.6.5.3 (TP2)]

Upon receiving the *UEInformationRequest* message, the UE shall:

- ...
- 1> if the *logMeasReportReq* is present and the *plmn-Identity* stored in *VarLogMeasReport* is equal to the RPLMN:
 - 2> if *VarLogMeasReport* includes one or more logged measurement entries, set the contents of the *logMeasReport* in the *UEInformationResponse* message as follows:
 - 3> include the *absoluteTimeStamp* and set it to the value of *absoluteTimeInfo* in the *VarLogMeasReport*;
 - 3> include the *traceReference* and set it to the value of *traceReference* in the *VarLogMeasReport*;
 - 3> include the *traceRecordingSessionRef* and set it to the value of *traceRecordingSessionRef* in the *VarLogMeasReport*;
 - 3> include the *tce-Id* and set it to the value of *tce-Id* in the *VarLogMeasReport*;
 - 3> include the *logMeasInfoList* and set it to include one or more entries from *VarLogMeasReport* starting from the entries logged first;
 - 3> if the *VarLogMeasReport* includes one or more additional logged measurement entries that are not included in the *logMeasInfoList* within the *UEInformationResponse* message:
 - 4> include the *logMeasAvailable*;
 - 1> if the *logMeasReport* is included in the *UEInformationResponse*:
 - 2> submit the *UEInformationResponse* message to lower layers for transmission via SRB2;
 - 2> discard the logged measurement entries included in the *logMeasInfoList* from *VarLogMeasReport* upon successful delivery of the *UEInformationResponse* message confirmed by lower layers;
 - 1> else:

- 2> submit the *UEInformationResponse* message to lower layers for transmission via SRB1;

8.6.2.5.3 Test description

8.6.2.5.3.1 Pre-test conditions

System Simulator:

- Cell 1 and Cell 2.
- System information combination 2 as defined in TS 36.508 [18] clause 4.4.3.1 is used in E-UTRA cells with content of intra-frequency neighbouring cell list in SIB4 set as defined in TS 36.508 [18] table 6.3.1.1-1.

UE:

None

Preamble:

- The UE is in state Generic RB Established (state 3) on Cell 1 according to [18]

8.6.2.5.3.2 Test procedure sequence

Table 8.6.2.5.3.2-1 shows the cell configurations used during the test. The configuration T0 indicates the initial conditions. Subsequent configurations marked "T1" are applied at the points indicated in the Main behaviour description in Table 8.6.2.5.3.2-2.

Table 8.6.2.5.3.2-1: Cell configuration changes over time

	Parameter	Unit	Cell 1	Cell 2
T0	Cell-specific RS EPRE	dBm/15kHz	-85	-91
T1	Cell-specific RS EPRE	dBm/15kHz	Off	-85

Table 8.6.2.5.3.2-2: Main behaviour

St	Procedure	Message Sequence		TP	Verdict
		U - S	Message		
1	The SS transmits a <i>LoggedMeasurementConfiguration</i> message on Cell 1.	<--	<i>LoggedMeasurementConfiguration</i>	-	-
2	The SS transmits a <i>RRCConnectionRelease</i> message to release the RRC connection.	<--	<i>RRCConnectionRelease</i>	-	-
3	Wait 30 seconds for UE performing the logging at regular time intervals	-	-	-	-
4-12	Steps 1 to 9 of the generic radio bearer establishment procedure in TS 36.508 subclause 4.5.3.3 are executed to successfully complete the service request procedure on Cell 1.	-	-	-	-
13	The SS changes Cell 1 and Cell 2 parameters according to the row "T1" in table 8.6.2.5.3.2-1 in order that the radio link quality of Cell 1 is degraded and Cell 2 is suitable for camping.	-	-	-	-
14	The UE send <i>RRCConnectionReestablishmentRequest</i> message on Cell 2.	-->	<i>RRCConnectionReestablishmentRequest</i>	-	-
15	The SS transmits <i>RRCConnectionReestablishment</i> message.	<--	<i>RRCConnectionReestablishment</i>	-	-
16	Check: Does the UE transmit <i>RRCConnectionReestablishmentComplete</i> message with <i>logMeasAvailable</i> set as <i>true</i> ?	-->	<i>RRCConnectionReestablishmentComplete</i>	1	P
17	The SS transmits an <i>RRCConnectionReconfiguration</i> message to resume the existing radio bearer.	<--	<i>RRCConnectionReconfiguration</i>	-	-
18	The UE transmits an <i>RRCConnectionReconfigurationComplete</i> message.	-->	<i>RRCConnectionReconfigurationComplete</i>	-	-
19	The SS send an <i>UEInformationRequest</i> message to get <i>logMeasReport</i> .	<--	<i>UEInformationRequest</i>	-	-
20	Check: Does the UE send an <i>UEInformationResponse</i> message include <i>logMeasReport</i> .	-->	<i>UEInformationResponse</i>	2	P

8.6.2.5.3.3 Specific message contents

Table 8.6.2.5.3.3-1: *SystemInformationBlockType3* for cell 1 (preamble)

Derivation Path: 36.508 table 4.4.3.3-2			
Information Element	Value/remark	Comment	Condition
<i>SystemInformationBlockType3</i> ::= SEQUENCE {			
<i>intraFreqCellReselectionInfo</i> SEQUENCE {			
<i>t-ReselectionEUTRA</i>	7	seconds	
}			
}			

Table 8.6.2.5.3.3-2: LoggedMeasurementConfiguration (step 1, Table 8.6.2.5.3.2-2)

Derivation path: 36.508 clause 4.6.1 table 4.6.1-4.0A LoggedMeasurementConfiguration			
Information Element	Value/remark	Comment	Condition
LoggedMeasurementConfiguration-r10 ::= SEQUENCE {			
criticalExtensions CHOICE {			
c1 CHOICE {			
loggedMeasurementConfiguration-r10 SEQUENCE {			
loggingInterval-r10	ms2560	2.56 seconds	
}			
}			
}			
}			

Table 8.6.2.5.3.3-3: RRCConnectionReestablishmentComplete (step 16, Table 8.6.2.5.3.2-2)

Derivation path: 36.508 clause 4.6.1 table 4.6.1-11 RRCConnectionReestablishmentComplete			
Information Element	Value/remark	Comment	Condition
RRCConnectionReestablishmentComplete ::= SEQUENCE {			
criticalExtensions CHOICE {			
rrcConnectionReestablishmentComplete-r8 SEQUENCE {			
nonCriticalExtension SEQUENCE {			
nonCriticalExtension SEQUENCE {			
nonCriticalExtension SEQUENCE {			
logMeasAvailable-r10	true		
nonCriticalExtension SEQUENCE {	Not checked		
}			
}			
}			
}			
}			

Table 8.6.2.5.3.3-4: UEInformationRequest (step 19, Table 8.6.2.5.3.2-2)

Derivation Path: 36.508 clause 4.6.1 table 4.6.1-23A UEInformationRequest, condition "Logged MDT"

Table 8.6.2.5.3.3-5: UEInformationResponse (step 20, Table 8.6.2.5.3.2-2)

Derivation Path: 36.508 clause 4.6.1 table 4.6.1-23B UEInformationResponse			
Information Element	Value/remark	Comment	Condition
UEInformationResponse-r9 ::= SEQUENCE {			
criticalExtensions CHOICE {			
c1 CHOICE {			
ueInformationResponse-r9 SEQUENCE {			
nonCriticalExtension SEQUENCE {			
lateNonCriticalExtension	Not checked		
nonCriticalExtension SEQUENCE {			
logMeasReport-r10 SEQUENCE {			
absoluteTimeStamp-r10	Same value as sent by SS in LoggedMeasurementConfiguration in step 1		
traceReference-r10 SEQUENCE {			
plmn-Identity-r10 SEQUENCE {			
mcc SEQUENCE (SIZE (3)) OF MCC-NMC-Digit	Same value as sent by SS in LoggedMeasurementConfiguration in step 1		

mnc SEQUENCE (SIZE (2..3)) OF MCC-NMC-Digit	Same value as sent by SS in <i>LoggedMeasurementConfiguration</i> in step 1		
}			
traceId-r10	Same value as sent by SS in <i>LoggedMeasurementConfiguration</i> in step 1		
}			
traceRecordingSessionRef-r10	Same value as sent by SS in <i>LoggedMeasurementConfiguration</i> in step 1		
tce-Id-r10	Same value as sent by SS in <i>LoggedMeasurementConfiguration</i> in step 1		
logMeasInfoList-r10 SEQUENCE (SIZE (1..maxLogMeasReport-r10)) OF SEQUENCE {	At least one entry complies to entry with index 'x' below. SS records the relativeTimeStamp value for each entry		
locationInfo-r10[x]	Not checked		
relativeTimeStamp-r10 [x]	SS record the value		
servCellIdentity-r10 [x]	Same as Cell 1		
measResultServCell-r10 [x] SEQUENCE {			
rsrpResult-r10	(0..97)		
rsrqResult-r10	(0..34)		
}			
measResultNeighCells-r10{}	Not checked		
}			
logMeasAvailable-r10	Not present		
}			
nonCriticalExtension SEQUENCE {	Not checked		
}			
}			
}			
}			
}			
}			

8.6.2.6 Logged MDT / Release of logged MDT measurement configuration / Expire of duration timer

8.6.2.6.1 Test Purpose (TP)

(1)

```
with { UE received LoggedMeasurementConfiguration message and has stored logMeasReport in VarLogMeasReport }
ensure that {
  when { The logging duration timer T330 expires }
  then { UE release VarLogMeasConfig and will not perform logged measurements }
}
```

(2)

```
with { UE received LoggedMeasurementConfiguration message and has stored logMeasReport in VarLogMeasReport }
ensure that {
  when { UE has released VarlogMeasConfig due to timer T330 has expired and UE receives UEInformationRequest message with logMeasReportReq present }
  then { UE transmits an UEInformationResponse message including logMeasReport }
}
```

(3)

```

with { UE received LoggedMeasurementConfiguration message and has stored logMeasReport in
VarLogMeasReport }
ensure that {
  when { UE has transmitted all the stored logMeasReport and UE receives UEInformationRequest
message with logMeasReportReq present }
then { UE transmits an UEInformationResponse message without logMeasReport}

```

8.6.2.6.2 Conformance requirements

References: The conformance requirements covered in the present TC are specified in: TS 36.331, clauses 5.6.5.3, 5.6.6.3 and 5.6.6.4.

[TS 36.331, clause 5.6.5.3 (TP2, TP3)]

Upon receiving the *UEInformationRequest* message, the UE shall:

...

- 1> if the *logMeasReportReq* is present and the *plmn-Identity* stored in *VarLogMeasReport* is equal to the RPLMN:
 - 2> if *VarLogMeasReport* includes one or more logged measurement entries, set the contents of the *logMeasReport* in the *UEInformationResponse* message as follows:
 - 3> include the *absoluteTimeStamp* and set it to the value of *absoluteTimeInfo* in the *VarLogMeasReport*;
 - 3> include the *traceReference* and set it to the value of *traceReference* in the *VarLogMeasReport*;
 - 3> include the *traceRecordingSessionRef* and set it to the value of *traceRecordingSessionRef* in the *VarLogMeasReport*;
 - 3> include the *tce-Id* and set it to the value of *tce-Id* in the *VarLogMeasReport*;
 - 3> include the *logMeasInfoList* and set it to include one or more entries from *VarLogMeasReport* starting from the entries logged first;
 - 3> if the *VarLogMeasReport* includes one or more additional logged measurement entries that are not included in the *logMeasInfoList* within the *UEInformationResponse* message:
 - 4> include the *logMeasAvailable*;
 - 1> if the *logMeasReport* is included in the *UEInformationResponse*:
 - 2> submit the *UEInformationResponse* message to lower layers for transmission via SRB2;
 - 2> discard the logged measurement entries included in the *logMeasInfoList* from *VarLogMeasReport* upon successful delivery of the *UEInformationResponse* message confirmed by lower layers;
 - 1> else:
 - 2> submit the *UEInformationResponse* message to lower layers for transmission via SRB1;

[TS 36.331, clause 5.6.6.4 (TP1)]

Upon expiry of T330 the UE shall:

- 1> release *VarLogMeasConfig*;

The UE is allowed to discard stored logged measurements, i.e. to release *VarLogMeasReport* 48 hours after T330 expiry.

8.6.2.6.3 Test description

8.6.2.6.3.1 Pre-test conditions

System Simulator:

- Cell 1

UE:

None

Preamble:

- - The UE is in state Generic RB Established (state 3) on Cell 1 according to [18]

8.6.2.6.3.2 Test procedure sequence

Table 8.6.2.6.3.2-1: Main behaviour

St	Procedure	Message Sequence		TP	Verdict
		U - S	Message		
1	The SS transmits a <i>LoggedMeasurementConfiguration</i> message on Cell 1.	<--	<i>LoggedMeasurementConfiguration</i>	-	-
2	The SS transmits a <i>RRCCConnectionRelease</i> message to release the RRC connection.	<--	<i>RRCCConnectionRelease</i>	-	-
3	Wait 30 seconds for UE performing the logging at regular time intervals	-	-	-	-
4-12	Steps 1 to 9 of the generic radio bearer establishment procedure in TS 36.508 subclause 4.5.3.3 are executed to successfully complete the service request procedure.	-	-	-	-
13	The SS send an <i>UEInformationRequest</i> message to get <i>logMeasReport</i> .	<--	<i>UEInformationRequest</i>	-	-
14	The UE send an <i>UEInformationResponse</i> message include <i>logMeasReport-r10</i> .	-->	<i>UEInformationResponse</i>	-	-
-	EXCEPTION: In case the <i>logMeasAvailable-r10</i> in <i>logMeasReport-r10</i> is True, steps 14a1 and 14a2 will be executed.	-	-	-	-
14a1	The SS send an <i>UEInformationRequest</i> message to get <i>logMeasReport</i> .	<--	<i>UEInformationRequest</i>	-	-
14a2	The UE sends an <i>UEInformationResponse</i> message include <i>logMeasReport-r10</i> .	-->	<i>UEInformationResponse</i>	-	-
-	EXCEPTION: In case the <i>logMeasAvailable-r10</i> in <i>logMeasReport-r10</i> is True, steps 14a1 and 14a2 will be executed.	-	-	-	-
15	The SS send an <i>UEInformationRequest</i> message to get <i>logMeasReport</i> .	<--	<i>UEInformationRequest</i>	-	-
16	Check: Does the UE send an <i>UEInformationResponse</i> message not include <i>logMeasReport</i> ?	-->	<i>UEInformationResponse</i>	3	P
17	The SS transmits a <i>RRCCConnectionRelease</i> message to release the RRC connection.	<--	<i>RRCCConnectionRelease</i>	-	-
18	Wait 10 minutes for UE performing the logging at regular time intervals as to ensure timer T330 has expired.	-	-	-	-
19-27	Steps 1 to 9 of the generic radio bearer establishment procedure in TS 36.508 subclause 4.5.3.3 are executed to successfully complete the service request procedure.	-	-	-	-
28	The SS send an <i>UEInformationRequest</i> message to get <i>logMeasReport</i> .	<--	<i>UEInformationRequest</i>		
29	Check: Does the UE send an <i>UEInformationResponse</i> message include <i>logMeasReport</i> ?	-->	<i>UEInformationResponse</i>	2	P
-	EXCEPTION: In case the <i>logMeasAvailable-r10</i> in <i>logMeasReport-r10</i> is True, steps 29a1 and 29a2 will be executed.	-	-	-	-
29a1	The SS send an <i>UEInformationRequest</i> message to get <i>logMeasReport</i> .	<--	<i>UEInformationRequest</i>	-	-
29a2	UE sends an <i>UEInformationResponse</i> message include <i>logMeasReport</i> .	-->	<i>UEInformationResponse</i>	-	-
-	EXCEPTION: In case the <i>logMeasAvailable-r10</i> in <i>logMeasReport-r10</i> is True, steps 29a1 and 29a2 will be executed.	-	-	-	-
30	The SS transmits a <i>RRCCConnectionRelease</i> message to release the RRC connection.	<--	<i>RRCCConnectionRelease</i>	-	-
31	Wait 30 seconds.				
32	The SS transmits a <i>Paging</i> message on Cell 1.	<--	<i>Paging</i>	-	-
33	The UE transmits an <i>RRCCConnectionRequest</i> message on Cell 1.	-->	<i>RRCCConnectionRequest</i>	-	-
34	The SS transmit an <i>RRCCConnectionSetup</i> message on Cell 1.	<--	<i>RRCCConnectionSetup</i>	-	-
35	Check: Does UE transmit an	-->	<i>RRCCConnectionSetupComplete</i>	1	P

	<i>RRCConnectionSetupComplete</i> message with <i>logMeasAvailable</i> IE not present?			
--	--	--	--	--

8.6.2.6.3.3 Specific message contents

Table 8.6.2.6.3.3-1: *LoggedMeasurementConfiguration* (step 1, Table 8.6.2.6.3.2-1)

Derivation path: 36.508 clause 4.6.1 table 4.6.1-4.0A <i>LoggedMeasurementConfiguration</i>			
Information Element	Value/remark	Comment	Condition
<i>LoggedMeasurementConfiguration-r10</i> ::= SEQUENCE {			
<i>criticalExtensions</i> CHOICE {			
C1 CHOICE {			
<i>loggedMeasurementConfiguration-r10</i>			
SEQUENCE {			
<i>loggingDuration-r10</i>	min10	10 minutes	
<i>loggingInterval-r10</i>	ms2560	2.56 seconds	
}			
}			
}			

Table 8.6.2.6.3.3-2: *RRCConnectionSetupComplete* (step 8 and step 23, Table 8.6.2.6.3.2-1)

Derivation path: 36.508 clause 4.6.1 table 4.6.1-18 <i>RRCConnectionSetupComplete</i>			
Information Element	Value/remark	Comment	Condition
<i>RRCConnectionSetupComplete</i> ::= SEQUENCE {			
<i>criticalExtensions</i> CHOICE {			
c1 CHOICE {			
<i>rrcConnectionSetupComplete-r8</i> SEQUENCE {			
<i>nonCriticalExtension</i> SEQUENCE {			
<i>nonCriticalExtension</i> SEQUENCE {			
<i>gummei-Type-r10</i>	Not checked		
<i>r1f-InfoAvailable-r10</i>	Not checked		
<i>logMeasAvailable-r10</i>	TRUE		
<i>rn-SubframeConfigReq-r10</i>	Not checked		
}	Not checked		
}			
}			
}			
}			
}			

Table 8.6.2.6.3.3-3: *UEInformationRequest* (step 13, step 14a1, step 15, step 28 and step 29a1, Table 8.6.2.6.3.2-1)

Derivation Path: 36.508 clause 4.6.1 table 4.6.1-23A <i>UEInformationRequest</i> , condition "Logged MDT"

Table 8.6.2.6.3.3-4: UEInformationResponse (step 14, step 14a2, step 29 and step 29a2, Table 8.6.2.6.3.2-1)

Derivation Path: 36.508 clause 4.6.1 table 4.6.1-23B UEInformationResponse			
Information Element	Value/remark	Comment	Condition
UEInformationResponse-r9 ::= SEQUENCE {			
criticalExtensions CHOICE {			
c1 CHOICE {			
ueInformationResponse-r9 SEQUENCE {			
nonCriticalExtension SEQUENCE {			
lateNonCriticalExtension	Not checked		
nonCriticalExtension SEQUENCE {			
logMeasReport-r10 SEQUENCE {			
absoluteTimeStamp-r10	Same value as sent by SS in <i>LoggedMeasurementConfiguration</i> in step 1		
traceReference-r10 SEQUENCE {			
plmn-identity-r10 SEQUENCE {			
mcc SEQUENCE (SIZE (3)) OF MCC-NMC-Digit	Same value as sent by SS in <i>LoggedMeasurementConfiguration</i> in step 1		
mnc SEQUENCE (SIZE (2..3)) OF MCC-NMC-Digit	Same value as sent by SS in <i>LoggedMeasurementConfiguration</i> in step 1		
}			
traceId-r10	Same value as sent by SS in <i>LoggedMeasurementConfiguration</i> in step 1		
}			
traceRecordingSessionRef-r10	Same value as sent by SS in <i>LoggedMeasurementConfiguration</i> in step 1		
tce-Id-r10	Same value as sent by SS in <i>LoggedMeasurementConfiguration</i> in step 1		
logMeasInfoList-r10 SEQUENCE (SIZE (1..maxLogMeasReport-r10)) OF SEQUENCE {	A least one entry complies to entry with index 'x' below. SS records the relativeTimeStamp value for each entry		
locationInfo-r10[x]	Not checked		
relativeTimeStamp-r10 [x]	SS record the value		
servCellIdentity-r10 [x]	Same as Cell 1		
measResultServCell-r10 [x] SEQUENCE {			
rsrpResult-r10	(0..97)		
rsrqResult-r10	(0..34)		
}			
measResultNeighCells-r10{}	Not present		
}			
logMeasAvailable-r10	Not present or True		
}			
nonCriticalExtension SEQUENCE {	Not checked		
}			
}			
}			
}			
}			
}			
}			

Table 8.6.2.6.3.3-5: *UEInformationResponse* (step 16, Table 8.6.2.6.3.2-1)

Derivation Path: 36.508 clause 4.6.1 table 4.6.1-23B <i>UEInformationResponse</i>			
Information Element	Value/remark	Comment	Condition
<i>UEInformationResponse-r9</i> ::= SEQUENCE {			
<i>criticalExtensions</i> CHOICE {			
c1 CHOICE {			
<i>ueInformationResponse-r9</i> SEQUENCE {			
<i>nonCriticalExtension</i> SEQUENCE {			
<i>nonCriticalExtension</i> SEQUENCE {			
<i>logMeasReportReq-r10</i> SEQUENCE {}	Not present		
<i>nonCriticalExtension</i> SEQUENCE {}	Not present		
}			
}			
}			
}			
}			
}			

Table 8.6.2.6.3.3-6: *RRCConnectionSetupComplete* (step 35, Table 8.6.2.6.3.2-1)

Derivation path: 36.508 clause 4.6.1 table 4.6.1-18 <i>RRCConnectionSetupComplete</i>			
Information Element	Value/remark	Comment	Condition
<i>RRCConnectionSetupComplete</i> ::= SEQUENCE {			
<i>criticalExtensions</i> CHOICE {			
c1 CHOICE {			
<i>rrcConnectionSetupComplete-r8</i> SEQUENCE {			
<i>nonCriticalExtension</i> SEQUENCE {			
<i>nonCriticalExtension</i> SEQUENCE {			
<i>gummei-Type-r10</i>	Not checked		
<i>rlf-InfoAvailable-r10</i>	Not checked		
<i>logMeasAvailable-r10</i>	Not present		
<i>rn-SubframeConfigReq-r10</i>	Not checked		
<i>nonCriticalExtension</i> SEQUENCE {}	Not checked		
}			
}			
}			
}			
}			
}			

8.6.2.7 Logged MDT / Release of logged MDT measurement configuration / Reception of new logged measurement configuration, Detach or UE power off

8.6.2.7.1 Test Purpose (TP)

(1)

```
with { UE received LoggedMeasurementConfiguration message and has stored logMeasReport in VarLogMeasReport }
ensure that {
  when { UE receive a new LoggedMeasurementConfiguration message }
  then { UE discards the stored logMeasReport }
}
```

(2)

```
with { UE received LoggedMeasurementConfiguration message and has stored logMeasReport in VarLogMeasReport }
ensure that {
  when { UE receive a new LoggedMeasurementConfiguration message }
  then { UE discards the old logged measurement configuration }
}
```

}

(3)

```

with { UE received LoggedMeasurementConfiguration message and has stored logMeasReport in
VarLogMeasReport}
ensure that {
  when { UE is switched off or detaches from the EPS service }
  then { UE discards the stored logMeasReport }
}

```

(4)

```

with { UE received LoggedMeasurementConfiguration message and has stored logMeasReport in
VarLogMeasReport}
ensure that {
  when { UE is switched off or detaches from the EPS service }
  then { UE discards the logged measurement configuration }
}

```

8.6.2.7.2 Conformance requirements

References: The conformance requirements covered in the present TC are specified in: TS 36.331, clauses 5.6.5.3, and 5.6.7.2.

[TS 36.331, clause 5.6.5.3 (TP1, TP2)]

Upon receiving the *UEInformationRequest* message, the UE shall:

- 1> if *rach-ReportReq* is set to *true*, set the contents of the *rach-Report* in the *UEInformationResponse* message as follows:
 - 2> set the *numberOfPreamblesSent* to indicate the number of preambles sent by MAC for the last successfully completed random access procedure;
 - 2> if contention resolution was not successful as specified in TS 36.321 [6] for at least one of the transmitted preambles for the last successfully completed random access procedure:
 - 3> set the *contentionDetected* to *true*;
 - 2> else:
 - 3> set the *contentionDetected* to *false*;
- 1> if *rlf-ReportReq* is set to *true* and the UE has radio link failure information or handover failure information available in *VarRLF-Report* and *plmn-Identity* stored in *VarRLF-Report* is equal to the RPLMN, set the *rlf-Report* in the *UEInformationResponse* message to the value of *rlf-Report* in *VarRLF-Report*;
- 1> if the *rlf-Report* is included in *UEInformationResponse*:
 - 2> discard the *rlf-Report* from *VarRLF-Report* upon successful delivery of the *UEInformationResponse* message confirmed by lower layers.
- 1> if the *logMeasReportReq* is present and the *plmn-Identity* stored in *VarLogMeasReport* is equal to the RPLMN:
 - 2> if *VarLogMeasReport* includes one or more logged measurement entries, set the contents of the *logMeasReport* in the *UEInformationResponse* message as follows:
 - 3> include the *absoluteTimeStamp* and set it to the value of *absoluteTimeInfo* in the *VarLogMeasReport*;
 - 3> include the *traceReference* and set it to the value of *traceReference* in the *VarLogMeasReport*;
 - 3> include the *traceRecordingSessionRef* and set it to the value of *traceRecordingSessionRef* in the *VarLogMeasReport*;
 - 3> include the *tce-Id* and set it to the value of *tce-Id* in the *VarLogMeasReport*;

- 3> include the *logMeasInfoList* and set it to include one or more entries from *VarLogMeasReport* starting from the entries logged first;
- 3> if the *VarLogMeasReport* includes one or more additional logged measurement entries that are not included in the *logMeasInfoList* within the *UEInformationResponse* message:
 - 4> include the *logMeasAvailable*;
- 1> if the *logMeasReport* is included in the *UEInformationResponse*:
 - 2> submit the *UEInformationResponse* message to lower layers for transmission via SRB2;
 - 2> discard the logged measurement entries included in the *logMeasInfoList* from *VarLogMeasReport* upon successful delivery of the *UEInformationResponse* message confirmed by lower layers;
- 1> else:
 - 2> submit the *UEInformationResponse* message to lower layers for transmission via SRB1;

[TS 36.331, clause 5.6.7.2 (TP1, TP2, TP3, TP4)]

The UE shall initiate the procedure upon receiving a logged measurement configuration in another RAT. The UE shall also initiate the procedure upon power off or detach.

The UE shall:

- 1> stop timer T330, if running;
- 1> if stored, discard the logged measurement configuration as well as the logged measurement information, i.e. release the UE variables *VarLogMeasConfig* and *VarLogMeasReport*;

8.6.2.7.3 Test description

8.6.2.7.3.1 Pre-test conditions

System Simulator:

- Cell 1

UE:

None

Preamble:

- - The UE is in state Generic RB Established (state 3) on Cell 1 according to [18]

8.6.2.7.3.2 Test procedure sequence

Table 8.6.2.7.3.2-1: Main behaviour

St	Procedure	Message Sequence		TP	Verdict
		U - S	Message		
1	The SS transmits a <i>LoggedMeasurementConfiguration</i> message on Cell 1.	<--	<i>LoggedMeasurementConfiguration</i>	-	-
2	The SS transmits a <i>RRCCConnectionRelease</i> message to release the RRC connection.	<--	<i>RRCCConnectionRelease</i>	-	-
3	Wait 30 seconds for UE performing the logging at regular time intervals	-	-	-	-
4-12	Steps 1 to 9 of the generic radio bearer establishment procedure in TS 36.508 subclause 4.5.3.3 are executed to successfully complete the service request procedure.	-	-	-	-
13	The SS transmits a <i>LoggedMeasurementConfiguration</i> message on Cell 1.	<--	<i>LoggedMeasurementConfiguration</i>	-	-
14	The SS send an <i>UEInformationRequest</i> message to get <i>logMeasReport</i> .	<--	<i>UEInformationRequest</i>		
15	Check: Does the UE send an <i>UEInformationResponse</i> message include <i>logMeasReport</i> ?	-->	<i>UEInformationResponse</i>	1	F
16	The SS transmits a <i>RRCCConnectionRelease</i> message to release the RRC connection.	<--	<i>RRCCConnectionRelease</i>	-	-
17	Wait 30 seconds for UE performing the logging at regular time intervals				
18-26	Steps 1 to 9 of the generic radio bearer establishment procedure in TS 36.508 subclause 4.5.3.3 are executed to successfully complete the service request procedure.	-	-	-	-
27	The SS send an <i>UEInformationRequest</i> message to get <i>logMeasReport</i> .	<--	<i>UEInformationRequest</i>		
28	Check: Does the UE send an <i>UEInformationResponse</i> message include <i>logMeasReport</i> based on the <i>LoggedMeasurementConfiguration</i> as in step 1?	-->	<i>UEInformationResponse</i>	2	F
29	The SS transmits a <i>RRCCConnectionRelease</i> message to release the RRC connection.	<--	<i>RRCCConnectionRelease</i>	-	-
30	The UE is switched off, or detaches from the network.	-	-	-	-
31	The UE is switched on, or attaches to the network.	-	-	-	-
32-47	The UE performs steps 2-17 of the registration procedure described in TS 36.508 table 4.5.2.3-1.	-	-	-	-
48	Wait 30 seconds for UE performing the logging at regular time intervals	-	-	-	-
49	The SS transmits a <i>Paging</i> message.	<--	<i>Paging</i>	-	-
50	The UE transmits an <i>RRCCConnectionRequest</i> message.	-->	<i>RRCCConnectionRequest</i>	-	-
51	The SS transmit an <i>RRCCConnectionSetup</i> message.	<--	<i>RRCCConnectionSetup</i>	-	-
52	Check: Does UE transmit an <i>RRCCConnectionSetupComplete</i> message with <i>logMeasAvailable</i> IE not present?	-->	<i>RRCCConnectionSetupComplete</i>	3,4	P

Table 8.6.2.7.3.3-5: UEInformationResponse (step 15, Table 8.6.2.7.3.2-1)

Derivation Path: 36.508 clause 4.6.1 table 4.6.1-23B UEInformationResponse			
Information Element	Value/remark	Comment	Condition
UEInformationResponse-r9 ::= SEQUENCE {			
criticalExtensions CHOICE {			
c1 CHOICE{			
ueInformationResponse-r9 SEQUENCE {			
nonCriticalExtension SEQUENCE {			
lateNonCriticalExtension	Not checked		
nonCriticalExtension SEQUENCE {			
logMeasReport-r10 SEQUENCE {	Not present		
nonCriticalExtension SEQUENCE {	Not checked		
}			
}			
}			
}			
}			

Table 8.6.2.7.3.3-6: UEInformationResponse (step 28, Table 8.6.2.7.3.2-1)

Derivation Path: 36.508 clause 4.6.1 table 4.6.1-23B UEInformationResponse			
Information Element	Value/remark	Comment	Condition
UEInformationResponse-r9 ::= SEQUENCE {			
criticalExtensions CHOICE {			
c1 CHOICE{			
ueInformationResponse-r9 SEQUENCE {			
nonCriticalExtension SEQUENCE {			
lateNonCriticalExtension	Not checked		
nonCriticalExtension SEQUENCE {			
logMeasReport-r10 SEQUENCE {			
absoluteTimeStamp-r10	Same value as sent by SS in <i>LoggedMeasurementConfiguration</i> in step 13		
traceReference-r10SEQUENCE {			
plmn-Identity-r10 SEQUENCE {			
mcc SEQUENCE (SIZE (3)) OF MCC-NMC-Digit	Same value as sent by SS in <i>LoggedMeasurementConfiguration</i> in step 13		
mnc SEQUENCE (SIZE (2..3)) OF MCC-NMC-Digit	Same value as sent by SS in <i>LoggedMeasurementConfiguration</i> in step 13		

}			
traceId-r10	Same value as sent by SS in <i>LoggedMeasurementConfiguration</i> in step 13		
}			
traceRecordingSessionRef-r10	Same value as sent by SS in <i>LoggedMeasurementConfiguration</i> in step 13		
tce-Id-r10	Same value as sent by SS in <i>LoggedMeasurementConfiguration</i> in step 13		
logMeasInfoList-r10 SEQUENCE (SIZE (1..maxLogMeasReport-r10)) OF SEQUENCE {	At least one entry complies to entry with index 'x' below. SS records the relativeTimeStamp value for each entry		
locationInfo-r10[x]	Not checked		
relativeTimeStamp-r10 [x]	SS record the value		
servCellIdentity-r10 [x]	Same as Cell 1		
measResultServCell-r10 [x] SEQUENCE {			
rsrpResult-r10	(0..97)		
rsrqResult-r10	(0..34)		
}			
measResultNeighCells-r10{}	Not present		
}			
logMeasAvailable-r10	Not present		
}			
nonCriticalExtension SEQUENCE {	Not checked		
}			
}			
}			
}			
}			
}			

Table 8.6.2.7.3.3-7: RRCConnectionSetupComplete (step 52, Table 8.6.2.7.3.2-1)

Derivation path: 36.508 clause 4.6.1 table 4.6.1-18 <i>RRCConnectionSetupComplete</i>			
Information Element	Value/remark	Comment	Condition
RRCConnectionSetupComplete ::= SEQUENCE {			
criticalExtensions CHOICE {			
c1 CHOICE {			
rrcConnectionSetupComplete-r8 SEQUENCE {			
nonCriticalExtension SEQUENCE {			
nonCriticalExtension SEQUENCE {			
gummei-Type-r10	Not checked		
rf-InfoAvailable-r10	Not checked		
logMeasAvailable-r10	Not present		
rn-SubframeConfigReq-r10	Not checked		
nonCriticalExtension SEQUENCE {}	Not checked		
}			
}			
}			
}			
}			
}			

8.6.2.8 Logged MDT / Maintaining logged measurement configuration / UE state transitions and mobility

8.6.2.8.1 Test Purpose (TP)

(1)

```
with { UE received LoggedMeasurementConfiguration message and has stored logMeasReport in
VarLogMeasReport}
ensure that {
  when { UE reselected to a cell belong to non MDT PLMN}
  then { UE does not indicate availability of Logged MDT measurements}
}
```

(2)

```
with { UE received LoggedMeasurementConfiguration message and has stored logMeasReport in
VarLogMeasReport}
ensure that {
  when { UE reselects to a cell belong to non MDT PLMN}
  then { UE suspends Logged MDT measurements}
}
```

(3)

```
with { UE received LoggedMeasurementConfiguration message and has reselected to a cell belong to non
MDT PLMN }
ensure that {
  when { UE returns to a cell belong to MDT PLMN}
  then { UE indicate availability of Logged MDT measurements }
}
```

(4)

```
with { UE received LoggedMeasurementConfiguration message and has reselected to a cell belong to non
MDT PLMN }
ensure that {
  when { UE returns to a cell belong to MDT PLMN}
  then { UE resumes Logged MDT measurements }
}
```

(5)

```
with { UE received LoggedMeasurementConfiguration message and has stored logMeasReport in
VarLogMeasReport}
ensure that {
  when { UE moves to RRC_CONNECTED state }
  then { UE maintains the Logged measurement configurations and logged measurement reports}
}
```

(6)

```
with { UE received LoggedMeasurementConfiguration message}
ensure that {
  when { UE moves to "any cell selection" or "camp on any cell" states }
  then { UE stop performing logged measurements and T330 keep running}
}
```

(7)

```
with { UE received LoggedMeasurementConfiguration message and had moved to "any cell selection" or
"camp on any cell" states }
ensure that {
  when { UE returns to "camp normally" state }
  then { UE resumes logged MDT measurements }
}
```

8.6.2.8.2 Conformance requirements

References: The conformance requirements covered in the present TC are specified in: TS 36.331, clauses 5.6.5.3, 5.6.6.3 and 5.6.6.4.

[TS 36.304, clause 8 (TP1, TP2, TP5, TP6)]

The UE may be configured to perform logging of measurement results in RRC_IDLE mode with the *LoggedMeasurementsConfiguration* message as specified in TS 36.331 [3]. This configuration is valid while the logging duration timer is running.

If the configuration of logged measurements is valid, the UE shall perform logging of measurement results if all of the following conditions are met:

- The UE is in *camped normally* state in RRC_IDLE mode;
- RPLMN of the UE is the same as the RPLMN at the point of time of *LoggedMeasurementConfiguration* message reception;
- The UE is camped on a cell belonging to the *areaConfiguration* (see TS 36.331 [3]), if configured;
- The UE is camped on the RAT where the logged measurement configuration was received.

Otherwise, the logging of measurement results shall be suspended.

NOTE 1: Even if logging of measurement results is suspended, the logging duration timer and time stamp will continue, and the logged measurement configuration and corresponding log are kept.

[TS 36.331, clause 5.3.3.4 (TP1, TP3)]

The UE shall:

- 1> perform the radio resource configuration procedure in accordance with the received *radioResourceConfigDedicated* and as specified in 5.3.10;
- 1> if stored, discard the cell reselection priority information provided by the *idleModeMobilityControlInfo* or inherited from another RAT;
- 1> stop timer T300;
- 1> stop timer T302, if running;
- 1> stop timer T303, if running;
- 1> stop timer T305, if running;
- 1> stop timer T306, if running;
- 1> perform the actions as specified in 5.3.3.7;
- 1> stop timer T320, if running;
- 1> enter RRC_CONNECTED;
- 1> stop the cell re-selection procedure;
- 1> consider the current cell to be the PCell;
- 1> set the content of *RRCCConnectionSetupComplete* message as follows:
 - 2> set the *selectedPLMN-Identity* to the PLMN selected by upper layers (see TS 23.122 [11], TS 24.301 [35]) from the PLMN(s) included in the *plmn-IdentityList* in *SystemInformationBlockType1*;
 - 2> if upper layers provide the 'Registered MME', include and set the *registeredMME* as follows:
 - 3> if the PLMN identity of the 'Registered MME' is different from the PLMN selected by the upper layers:

- 4> include the *plmnIdentity* in the *registeredMME* and set it to the value of the PLMN identity in the 'Registered MME' received from upper layers;
- 3> set the *mmegi* and the *mmec* to the value received from upper layers;
- 2> if upper layers provided the 'Registered MME':
 - 3> include and set the *gummei-Type* to the value provided by the upper layers;
- 2> if connecting as an RN:
 - 3> include the *rn-SubframeConfigReq*;
- 2> set the *dedicatedInfoNAS* to include the information received from upper layers;
- 2> if the UE has radio link failure or handover failure information available in *VarRLF-Report* and *plmn-Identity* stored in *VarRLF-Report* is equal to the RPLMN:
 - 3> include *rlf-InfoAvailable*;
- 2> if the UE has logged measurements available for E-UTRA and *plmn-Identity* stored in *VarLogMeasReport* is equal to the RPLMN:
 - 3> include *logMeasAvailable*;
- 2> submit the *RRCConnectionSetupComplete* message to lower layers for transmission, upon which the procedure ends;

[TS 36.331, clause 5.6.8.2 (TP4, TP5, TP7)]

While T330 is running, the UE shall:

- 1> perform the logging in accordance with the following:
 - 2> if the UE is camping normally on an E-UTRA cell and the RPLMN of the UE is the same as the *plmn-Identity* stored in *VarLogMeasReport* and, if the cell is part of the area indicated by *areaConfiguration* if configured in *VarLogMeasConfig*:
 - 3> perform the logging at regular time intervals, as defined by the *loggingInterval* in *VarLogMeasConfig*;
 - 2> when adding a logged measurement entry in *VarLogMeasReport*, include the fields in accordance with the following:
 - 3> set the *relativeTimeStamp* to indicate the elapsed time since the moment at which the logged measurement configuration was received;
 - 3> if detailed location information became available during the last logging interval, set the content of the *locationInfo* as follows:
 - 4> include the *locationCoordinates*;
 - 3> set the *servCellIdentity* to indicate global cell identity of the cell the UE is camping on;
 - 3> set the *measResultServCell* to include the quantities of the cell the UE is camping on;
 - 3> if available, set the *measResultNeighCells*, in order of decreasing ranking-criterion as used for cell reselection, to include neighbouring cell measurements that became available during the last logging interval for at most the following number of neighbouring cells; 6 intra-frequency and 3 inter-frequency neighbours per frequency as well as 3 inter-RAT neighbours, per frequency/ set of frequencies (GERAN) per RAT;

NOTE 2: The UE includes the latest results of the available measurements as used for cell reselection evaluation, which are performed in accordance with the performance requirements as specified in TS 36.133 [16].

8.6.2.8.3 Test description

8.6.2.8.3.1 Pre-test conditions

System Simulator:

- Cell 1, Cell2, Cell 12
- System information combination 3 as defined in TS 36.508 [18] clause 4.4.3.1 is used in E-UTRA cells.

UE:

None

Preamble:

- The UE is in state Generic RB Established (state 3) on Cell 1 according to [18]

8.6.2.8.3.2 Test procedure sequence

Table 8.6.2.8.3.2-1 shows the cell configurations used during the test. The configuration T0 indicates the initial conditions. Subsequent configurations marked "T1", "T2", "T3" and "T4" are applied at the points indicated in the Main behaviour description in Table 8.6.2.8.3.2-2.

Table 8.6.2.8.3.2-1: Cell configuration changes over time

	Parameter	Unit	Cell 1	Cell 2	Cell 12
T0	RS EPRE	dBm/15kHz	-85	Off	Off
T1	RS EPRE	dBm/15kHz	-91	Off	-85
T2	RS EPRE	dBm/15kHz	Off	-85	-91
T3	RS EPRE	dBm/15kHz	Off	Off	Off
T4	RS EPRE	dBm/15kHz	-85	Off	Off

Table 8.6.2.8.3.2-2: Main behaviour

St	Procedure	Message Sequence		TP	Verdict
		U - S	Message		
1	The SS transmits a LoggedMeasurementConfiguration message on Cell 1.	<--	LoggedMeasurementConfiguration	-	-
2	The SS transmits a RRCConnectionRelease message to release the RRC connection.	<--	RRCConnectionRelease	-	-
3	Wait 10 seconds for UE performing the logging at regular time intervals	-	-	-	-
4	The SS changes Cell 1 and Cell 12 level according to the row "T1" in Table 8.6.2.8.3.2-1.	-	-	-	-
5-10	Steps 1 to 6 of generic test procedure in TS 36.508 subclause 6.4.2.7 are performed on Cell 12.	-	-	-	-
11	Wait 10 seconds for UE to perform the logging at regular time intervals.	-	-	-	-
12	The SS transmits a Paging message.	<--	Paging	-	-
13	The UE transmits an RRCConnectionRequest message.	-->	RRCConnectionRequest	-	-
14	The SS transmit an RRCConnectionSetup message.	<--	RRCConnectionSetup	-	-
15	Check: Does UE transmit an RRCConnectionSetupComplete message with logMeasAvailable IE not present?	-->	RRCConnectionSetupComplete	1	P
16	The SS transmits a RRCConnectionRelease message to release RRC connection and move to RRC_IDLE on Cell 12.	<--	RRCConnectionRelease	-	-
17	The SS changes Cell 1, Cell 2 and Cell 12 level according to the row "T2" in Table 8.6.2.8.3.2-1.	-	-	-	-
18-23	Steps 1 to 6 of generic test procedure in TS 36.508 subclause 6.4.2.7 are performed on Cell 2.	-	-	-	-
24	Wait 10 seconds for UE performing the logging at regular time intervals	-	-	-	-
25	The SS transmits a Paging message.	<--	Paging	-	-
26	The UE transmits an RRCConnectionRequest message.	-->	RRCConnectionRequest	-	-
27	The SS transmit an RRCConnectionSetup message.	<--	RRCConnectionSetup	-	-
28	Check: Does UE transmit an RRCConnectionSetupComplete message with logMeasAvailable set as true?	-->	RRCConnectionSetupComplete	3	P
29-32	Steps 6 to 9 of the generic radio bearer establishment procedure in TS 36.508 subclause 4.5.3.3 are executed to successfully complete the service request procedure.	-	-	-	-
33	The SS send a UEInformationRequest message to get logMeasReport.	<--	UEInformationRequest	-	-
34	Check: Does the UE send an UEInformationResponse message including at least one logMeasReport with serving cell measurements for Cell 1 and Cell 2 and without serving cell measurements for Cell 12?	-->	UEInformationResponse	2, 4, 5	P
35	The SS transmits an RRCConnectionRelease message to release RRC connection and move to RRC_IDLE on Cell 2.	<--	RRCConnectionRelease	-	-
36	Wait 10 seconds for UE performing the logging at regular time intervals	-	-	-	-
37	The SS changes Cell 2 and Cell 12 level according to the row "T3" in Table 8.6.2.8.3.2-1.	-	-	-	-
38	Wait 5 minutes.	-	-	-	-
39	The SS changes Cell 1 level according to the	-	-	-	-

	row "T4" in Table 8.6.2.8.3.2-1.				
40	Wait 10 seconds for UE performing the logging at regular time intervals	-	-	-	-
41-48	Steps 2 to 9 of the generic radio bearer establishment procedure in TS 36.508 subclause 4.5.3.3 are executed to successfully complete the service request procedure.	-	-	-	-
49	The SS send a <i>UEInformationRequest</i> message to get logMeasReport.	<--	<i>UEInformationRequest</i>		
50	Check: Does the UE send a <i>UEInformationResponse</i> message including <i>logMeasReport-r10</i> with serving cell measurements for Cell 1 and Cell 2? Note: The number of entries in <i>logMeasInfoList</i> should not be more than the expected logged measurement result entries within 30 seconds of logging periods.	-->	<i>UEInformationResponse</i>	5,6,7	P

8.6.2.8.3.3 Specific message contents

Table 8.6.2.8.3.3-1: SystemInformationBlockType3 for cell 1 (preamble)

Derivation Path: 36.508 table 4.4.3.3-2			
Information Element	Value/remark	Comment	Condition
SystemInformationBlockType3 ::= SEQUENCE {			
intraFreqCellReselectionInfo SEQUENCE {			
t-ReselectionEUTRA	7	seconds	
}			
}			

Table 8.6.2.8.3.3-2: LoggedMeasurementConfiguration (step 1, Table 8.6.2.8.3.2-2)

Derivation path: 36.508 clause 4.6.1 table 4.6.1-4.0A <i>LoggedMeasurementConfiguration</i>			
Information Element	Value/remark	Comment	Condition
LoggedMeasurementConfiguration-r10 ::= SEQUENCE {			
criticalExtensions CHOICE {			
C1 CHOICE {			
loggedMeasurementConfiguration-r10 SEQUENCE {			
loggingDuration-r10	min10	10 minutes	
loggingInterval-r10	ms2560	2.56 seconds	
}			
}			
}			
}			

Table 8.6.2.8.3.3-3: RRCConnectionSetupComplete (step 15, Table 8.6.2.8.3.2-2)

Derivation path: 36.508 clause 4.6.1 table 4.6.1-18 RRCConnectionSetupComplete			
Information Element	Value/remark	Comment	Condition
RRCConnectionSetupComplete ::= SEQUENCE {			
criticalExtensions CHOICE {			
c1 CHOICE {			
rrcConnectionSetupComplete-r8 SEQUENCE {			
nonCriticalExtension SEQUENCE {			
nonCriticalExtension SEQUENCE {			
gummei-Type-r10	Not checked		
rlf-InfoAvailable-r10	Not checked		
logMeasAvailable-r10	Not present		
rn-SubframeConfigReq-r10	Not checked		
nonCriticalExtension SEQUENCE {}	Not checked		
}			
}			
}			
}			
}			
}			

Table 8.6.2.8.3.3-4: RRCConnectionSetupComplete (step 28, Table 8.6.2.8.3.2-2)

Derivation path: 36.508 clause 4.6.1 table 4.6.1-18 RRCConnectionSetupComplete			
Information Element	Value/remark	Comment	Condition
RRCConnectionSetupComplete ::= SEQUENCE {			
criticalExtensions CHOICE {			
c1 CHOICE {			
rrcConnectionSetupComplete-r8 SEQUENCE {			
nonCriticalExtension SEQUENCE {			
nonCriticalExtension SEQUENCE {			
gummei-Type-r10	Not checked		
rlf-InfoAvailable-r10	Not checked		
logMeasAvailable-r10	TRUE		
rn-SubframeConfigReq-r10	Not checked		
nonCriticalExtension SEQUENCE {}	Not checked		
}			
}			
}			
}			
}			
}			

Table 8.6.2.8.3.3-5: UEInformationRequest (step 33 and 49, Table 8.6.2.8.3.2-2)

Derivation Path: 36.508 clause 4.6.1 table 4.6.1-23A UEInformationRequest, condition "Logged MDT"

Table 8.6.2.8.3.3-6: UEInformationResponse (step 34, Table 8.6.2.8.3.2-2)

Derivation Path: 36.508 clause 4.6.1 table 4.6.1-23B UEInformationResponse			
Information Element	Value/remark	Comment	Condition
UEInformationResponse-r9 ::= SEQUENCE {			
criticalExtensions CHOICE {			
c1 CHOICE {			
ueInformationResponse-r9 SEQUENCE {			
nonCriticalExtension SEQUENCE {			
lateNonCriticalExtension	Not checked		
nonCriticalExtension SEQUENCE {			
logMeasReport-r10 SEQUENCE {			
absoluteTimeStamp-r10	Same value as sent by SS in LoggedMeasurementCon		

	<i>figuration</i> in step 1		
traceReference-r10 SEQUENCE {			
plmn-Identity-r10 SEQUENCE {			
mcc SEQUENCE (SIZE (3)) OF MCC-NMC-Digit	Same value as sent by SS in <i>LoggedMeasurementConfiguration</i> in step 1		
mnc SEQUENCE (SIZE (2..3)) OF MCC-NMC-Digit	Same value as sent by SS in <i>LoggedMeasurementConfiguration</i> in step 1		
}			
traceId-r10	Same value as sent by SS in <i>LoggedMeasurementConfiguration</i> in step 1		
}			
traceRecordingSessionRef-r10	Same value as sent by SS in <i>LoggedMeasurementConfiguration</i> in step 1		
tce-Id-r10	Same value as sent by SS in <i>LoggedMeasurementConfiguration</i> in step 1		
logMeasInfoList-r10 SEQUENCE (SIZE (1..maxLogMeasReport-r10)) OF SEQUENCE {	At least 1 entry complies to entry with index 'x' below. SS records the relativeTimeStamp value for each entry		
locationInfo-r10[x]	Not checked		
relativeTimeStamp-r10 [x]	SS record the value		
servCellIdentity-r10 [x]	Same as Cell 1		
measResultServCell-r10 [x] SEQUENCE {			
rsrpResult-r10	(0..97)		
rsrqResult-r10	(0..34)		
}			
measResultNeighCells-r10{}	Not checked		
locationInfo-r10[x]	Not checked		
relativeTimeStamp-r10 [x]	SS record the value		
servCellIdentity-r10 [x]	Same as Cell 2		
measResultServCell-r10 [x] SEQUENCE {			
rsrpResult-r10	(0..97)		
rsrqResult-r10	(0..34)		
}			
measResultNeighCells-r10{}	Not checked		
}			
logMeasAvailable-r10	Not present		
}			
nonCriticalExtension SEQUENCE {	Not checked		
}			
}			
}			
}			
}			
}			

Table 8.6.2.8.3.3-7: *UEInformationResponse* (step 50, Table 8.6.2.8.3.2-2)

Derivation Path: 36.508 clause 4.6.1 table 4.6.1-23B <i>UEInformationResponse</i>			
Information Element	Value/remark	Comment	Condition
<i>UEInformationResponse</i> -r9 ::= SEQUENCE {			
<i>criticalExtensions</i> CHOICE {			
c1 CHOICE{			
<i>ueInformationResponse</i> -r9 SEQUENCE {			
<i>nonCriticalExtension</i> SEQUENCE {			
<i>lateNonCriticalExtension</i>	Not checked		
<i>nonCriticalExtension</i> SEQUENCE {			
<i>logMeasReport</i> -r10 SEQUENCE {			
<i>absoluteTimeStamp</i> -r10	Same value as sent by SS in <i>LoggedMeasurementCon- figuration</i> in step 1		

traceReference-r10SEQUENCE {			
plmn-Identity-r10 SEQUENCE {			
mcc SEQUENCE (SIZE (3)) OF MCC-NMC-Digit	Same value as sent by SS in <i>LoggedMeasurementConfiguration</i> in step 1		
mnc SEQUENCE (SIZE (2..3)) OF MCC-NMC-Digit	Same value as sent by SS in <i>LoggedMeasurementConfiguration</i> in step 1		
}			
traceId-r10	Same value as sent by SS in <i>LoggedMeasurementConfiguration</i> in step 1		
}			
traceRecordingSessionRef-r10	Same value as sent by SS in <i>LoggedMeasurementConfiguration</i> in step 1		
tce-Id-r10	Same value as sent by SS in <i>LoggedMeasurementConfiguration</i> in step 1		
logMeasInfoList-r10 SEQUENCE (SIZE (1..maxLogMeasReport-r10)) OF SEQUENCE {	At least 1 entry complies to entry with index 'x' below. SS records the relativeTimeStamp value for each entry.		
locationInfo-r10[x]	Not checked		
relativeTimeStamp-r10 [x]	SS record the value		
servCellIdentity-r10 [x]	Same as Cell 2		
measResultServCell-r10 [x] SEQUENCE {			
rsrpResult-r10	(0..97)		
rsrqResult-r10	(0..34)		
}			
measResultNeighCells-r10{}	Not checked		
locationInfo-r10[x]	Not checked		
relativeTimeStamp-r10 [x]	SS record the value		
servCellIdentity-r10 [x]	Same as Cell 1		
measResultServCell-r10 [x] SEQUENCE {			
rsrpResult-r10	(0..97)		
rsrqResult-r10	(0..34)		
}			
measResultNeighCells-r10{}	Not checked		
}			
logMeasAvailable-r10	Not present		
}			
nonCriticalExtension SEQUENCE {	Not checked		
}			
}			
}			
}			
}			
}			

8.6.2.9 Logged MDT / Location information

8.6.2.9.1 Test Purpose (TP)

(1)

with { UE in E-UTRA RRC_CONNECTED state and UE has logged measurements with detailed location information available for E-UTRA and plmn-Identity stored in VarLogMeasReport is equal to the RPLMN }
ensure that {

```

when { receiving UEInformationRequest message }
  then { UE transmits UEInformationResponse messages with a logMeasReport with locationCoordinates
in the locationInfo in the logged measurement entries }
}

```

8.6.2.9.2 Conformance requirements

References: The conformance requirements covered in the current TC are specified in: TS 34.306, clause 4.3.13.2; TS 36.331, clause 5.6.8.2.

[TS 36.306, clause 4.3.13.2 (TP1)]

standaloneGNSS-Location

This parameter defines whether the UE is equipped with a standalone GNSS receiver that may be used to provide detailed location information in RRC measurement report and logged measurements in RRC_IDLE.

[TS 36.331, clause 5.6.8.2 (TP1)]

While T330 is running, the UE shall:

- 1> perform the logging in accordance with the following:
 - 2> if the UE is camping normally on an E-UTRA cell and the RPLMN of the UE is the same as the *plmn-Identity* stored in *VarLogMeasReport* and, if the cell is part of the area indicated by *areaConfiguration* if configured in *VarLogMeasConfig*:
 - 3> perform the logging at regular time intervals, as defined by the *loggingInterval* in *VarLogMeasConfig*;
 - 2> when adding a logged measurement entry in *VarLogMeasReport*, include the fields in accordance with the following:
 - 3> set the *relativeTimeStamp* to indicate the elapsed time since the moment at which the logged measurement configuration was received;
 - 3> if detailed location information became available during the last logging interval, set the content of the *locationInfo* as follows:
 - 4> include the *locationCoordinates*;
 - 3> set the *servCellIdentity* to indicate global cell identity of the cell the UE is camping on;
 - 3> set the *measResultServCell* to include the quantities of the cell the UE is camping on;
 - 3> if available, set the *measResultNeighCells*, in order of decreasing ranking-criterion as used for cell reselection, to include neighbouring cell measurements that became available during the last logging interval for at most the following number of neighbouring cells; 6 intra-frequency and 3 inter-frequency neighbours per frequency as well as 3 inter-RAT neighbours, per frequency/ set of frequencies (GERAN) per RAT;
- NOTE: The UE includes the latest results of the available measurements as used for cell reselection evaluation, which are performed in accordance with the performance requirements as specified in TS 36.133 [16].
- 2> when the memory reserved for the logged measurement information becomes full, stop timer T330 and perform the same actions as performed upon expiry of T330, as specified in 5.6.6.4;

8.6.2.9.3 Test description

8.6.2.9.3.1 Pre-test conditions

System Simulator:

- Two intra-frequency cells belonging to the same PLMN, but to different tracking areas: Cell 1, Cell 11
- Cell power levels are selected according to [18] so that camping on Cell 1 is guaranteed

- System information combination 2 as defined in TS 36.508 [18] clause 4.4.3.1 is used in E-UTRA cells with content of SIB4 set as defined in TS 36.508 [18] table 6.3.1.1-1.

Preamble:

- The UE's positioning engine (e.g. standalone GNSS receiver) should be provided with any necessary stimulus to allow it to provide the position. This shall be done by use of the test function Update UE Location Information defined in TS 36.509 [25] , if supported by the UE according to pc_UpdateUE_LocationInformation. Otherwise, or in addition any other suitable method may also be used.
- The UE is in state Generic RB Established (state 3) according to [18] on Cell 1.

8.6.2.9.3.2 Test procedure sequence

Table 8.6.2.9.3.2-1 illustrates the downlink power levels and other changing parameters to be applied for the cells at various time instants of the test execution. The configuration marked "T1" is applied at the point indicated in the Main behaviour description in Table 8.6.2.9.3.2-2.

Table 8.6.2.9.3.2-1: Time instances of cell power level and parameter changes

	Parameter	Unit	Cell 1	Cell 11	Remark
T1	Cell-specific RS EPRE	dBm/ 15kHz	-85	-79	The power level values are assigned to satisfy $R_{\text{Cell 1}} < R_{\text{Cell 11}}$.

Table 8.6.2.9.3.2-2: Main behaviour

St	Procedure	Message Sequence		TP	Verdict
		U - S	Message		
1	SS transmits a <i>LoggedMeasurementConfiguration</i> message including to configure the UE to perform logging of measurement results while in RRC_IDLE.	<--	<i>LoggedMeasurementConfiguration</i>	-	-
2	The SS transmits an <i>RRCConnectionRelease</i> message.	<--	<i>RRCConnectionRelease</i>	-	-
3	Wait 5s to allow UE to activate logging	-	-	-	-
4	The SS changes Cell 1 and Cell 11 levels according to the row "T1" in table 8.6.2.9.3.2-1. (Note 1)	-	-	-	-
5	The UE transmits an <i>RRCConnectionRequest</i> message on Cell 11 to initiate a tracking area update procedure. (Note 1)	-->	<i>RRCConnectionRequest</i>	-	-
6	SS transmit an <i>RRCConnectionSetup</i> message.	<--	RRC: <i>RRCConnectionSetup</i>	-	-
7	Check: Does the UE include the IE <i>logMeasAvailable</i> in the <i>RRCConnectionSetupComplete</i> message?	-->	RRC: <i>RRCConnectionSetupComplete</i> NAS: TRACKING AREA UPDATE REQUEST	1	P
8-10	Steps 4 to 6 of the generic test procedure in TS 36.508 subclause 6.4.2.7 are performed on Cell 11. NOTE: The UE performs a TAU procedure and the RRC connection is released.	-	-	-	-
11-19	Steps 1 to 9 of the generic radio bearer establishment procedure in TS 36.508 subclause 4.5.3.3 are executed to successfully complete the service request procedure on Cell 11.	-	-	-	-
20	The SS transmits a <i>UEInformationRequest</i> message on Cell 11.	<--	<i>UEInformationRequest</i>	-	-
21	Check: Does the UE transmit a <i>UEInformationResponse</i> message with a <i>LogMeasInfoList</i> with at least two entries with serving cell idle mode measurements and where in at least one of the entries the IE <i>locationCoordinates-r10</i> is present.	-->	<i>UEInformationResponse</i>	1	P
Note 1: The change of power levels is to trigger a cell re-selection procedure to make sure that the UE is logging neighbouring cell measurements (logging interval=2.56 seconds) of Cell 11 while t-Reselection timer is running (7 seconds).					

8.6.2.9.3.3 Specific message contents

Table 8.6.2.9.3.3-1: *SystemInformationBlockType3* for cell 1 (preamble)

Derivation Path: 36.508 table 4.4.3.3-2		
Information Element	Value/remark	Comment
<i>SystemInformationBlockType3</i> ::= SEQUENCE {		
<i>intraFreqCellReselectionInfo</i> SEQUENCE {		
<i>t-ReselectionEUTRA</i>	7	seconds
}		
}		

Table 8.6.2.9.3.3-2: *LoggedMeasurementConfiguration* (step 1, Table 8.6.2.9.3.2-2)

Derivation path: 36.508 clause 4.6.1 table 4.6.1-4.0A <i>LoggedMeasurementConfiguration</i>			
Information Element	Value/remark	Comment	Condition
LoggedMeasurementConfiguration-r10 ::= SEQUENCE {			
criticalExtensions CHOICE {			
C1 CHOICE {			
loggedMeasurementConfiguration-r10			
SEQUENCE {			
loggingInterval-r10	ms2560	2.56 seconds	
}			
}			
}			
}			

Table 8.6.2.9.3.3-3: *RRCConnectionSetupComplete* (step 7, Table 8.6.2.9.3.2-2)

Derivation path: 36.508 clause 4.6.1 table 4.6.1-18 <i>RRCConnectionSetupComplete</i>			
Information Element	Value/remark	Comment	Condition
RRCConnectionSetupComplete ::= SEQUENCE {			
criticalExtensions CHOICE {			
c1 CHOICE {			
rrcConnectionSetupComplete-r8 SEQUENCE {			
lateNonCriticalExtension	Not checked		
gummei-Type-r10	Not checked		
rfl-InfoAvailable-r10	Not checked		
logMeasAvailable-r10	TRUE		
rn-SubframeConfigReq-r10	Not checked		
nonCriticalExtension SEQUENCE {}	Not checked		
}			
}			
}			
}			

Table 8.6.2.9.3.4: *UEInformationRequest* (step 20, Table 8.6.2.9.3.2-2)

Derivation Path: 36.508 clause 4.6.1 table 4.6.1-23A <i>UEInformationRequest</i> , condition "Logged MDT"

Table 8.6.2.9.3.3-5: *UEInformationResponse* (step 21, Table 8.6.2.9.3.2-2)

Derivation Path: 36.508 clause 4.6.1 table 4.6.1-23B <i>UEInformationResponse</i>			
Information Element	Value/remark	Comment	Condition
<i>UEInformationResponse</i> -r9 ::= SEQUENCE {			
criticalExtensions CHOICE {			
c1 CHOICE{			
<i>ueInformationResponse</i> -r9 SEQUENCE {			
nonCriticalExtension SEQUENCE {			
lateNonCriticalExtension	Not checked		
nonCriticalExtension SEQUENCE {			
logMeasReport-r10 SEQUENCE {			
absoluteTimeStamp-r10	Not checked		
traceReference-r10 SEQUENCE {			
plmn-Identity-r10 SEQUENCE {			
mcc SEQUENCE (SIZE (3)) OF MCC-NMC-Digit	Same value as sent by SS in <i>LoggedMeasurementConfiguration</i> in step 1		
mnc SEQUENCE (SIZE (2..3)) OF MCC-NMC-Digit	Same value as sent by SS in <i>LoggedMeasurementConfiguration</i> in step 1		
}			
}			
traceRecordingSessionRef-r10	Not checked		
tce-Id-r10	Not checked		
logMeasInfoList-r10 SEQUENCE (SIZE (1..maxLogMeasReport-r10)) OF SEQUENCE {	At least 2 entries where at least one entry complies to entry with index 'x' below. SS records the relativeTimeStamp value for each entry		
locationInfo-r10[x] SEQUENCE {			
locationCoordinates-r10 CHOICE {			
ellipsoid-Point-r10	Any allowed value		
ellipsoidPointWithAltitude-r10	Any allowed value		
}			
relativeTimeStamp-r10 [x]	Not checked		
servCellIdentity-r10 [x]	Same as Cell 1		
measResultServCell-r10 [x]	Not checked		
measResultNeighCells-r10 [x] SEQUENCE {			
measResultListEUTRA-r10 SEQUENCE (SIZE (1..maxFreq)) OF SEQUENCE {	1 entry		
carrierFreq-r9[1]	Same as Cell 11		
measResultList-r9[1] SEQUENCE (SIZE (1..maxCellReport)) OF SEQUENCE {	1 entry		
physCellId [1]	Same as Cell 11		
cgi-Info [1]	Not checked		
measResult [1]	Not checked		
}			
}			
measResultListUTRA-r10	Not present		
measResultListGERAN-r10	Not present		
measResultListCDMA2000-r10	Not present		
}			
logMeasAvailable-r10	Not present		
}			
nonCriticalExtension SEQUENCE {	Not checked		
}			
}			

}			
}			
}			
}			

8.6.2.10 Logged MDT / Logging and reporting / Reporting at RRC connection establishment / PLMN list

8.6.2.10.1 Test Purpose (TP)

(1)

```
with { UE is in E-UTRA RRC_IDLE state, UE has logged measurements available and the RPLMN is
included in plmn-IdentityList received in LoggedMeasurementConfiguration message }
ensure that {
  when { UE performs an RRC Connection establishment procedure }
  then { UE sends an RRCConnectionSetupComplete message with logMeasAvailable }
}
```

(2)

```
with { UE is in E-UTRA RRC_CONNECTED state, UE has logged measurements available and the RPLMN is
included in plmn-IdentityList received in LoggedMeasurementConfiguration message }
ensure that {
  when { UE receives UEInformationRequest message with logMeasReportReq set to true }
  then { UE transmits UEInformationResponse messages with a logMeasReport }
}
```

8.6.2.10.2 Conformance requirements

References: The conformance requirements covered in the present TC are specified in: TS 36.304, clause 8; TS 36.331, clauses 5.3.3.4, 5.6.5.3 and 5.6.8.2.

[TS 36.304, clause 8]

The UE may be configured to perform logging of measurement results in RRC_IDLE mode with the *LoggedMeasurementsConfiguration* message as specified in TS 36.331 [3]. This configuration is valid while the logging duration timer is running.

If the configuration of logged measurements is valid, the UE shall perform logging of measurement results if all of the following conditions are met:

- The UE is in *camped normally* state in RRC_IDLE mode;
- The RPLMN of the UE is the same as the RPLMN at the point of time of *LoggedMeasurementConfiguration* message reception, or is present in the *plmn-IdentityList* (see TS 36.331 [3]) if configured;
- The UE is camped on a cell belonging to the *areaConfiguration* (see TS 36.331 [3]), if configured;
- The UE is camped on the RAT where the logged measurement configuration was received.

Otherwise, the logging of measurement results shall be suspended.

NOTE: Even if logging of measurement results is suspended, the logging duration timer and time stamp will continue, and the logged measurement configuration and corresponding log are kept.

[TS 36.331, clause 5.3.3.4]

The UE shall:

...

1> set the content of *RRCConnectionSetupComplete* message as follows:

...

- 2> if the UE has logged measurements available for E-UTRA and if the RPLMN is included in *plmn-IdentityList* stored in *VarLogMeasReport*:
- 3> include *logMeasAvailable*;

[TS 36.331, clause 5.6.5.3]

Upon receiving the *UEInformationRequest* message, the UE shall:

...

- 1> if the *logMeasReportReq* is present and if the RPLMN is included in *plmn-IdentityList* stored in *VarLogMeasReport*:
 - 2> if *VarLogMeasReport* includes one or more logged measurement entries, set the contents of the *logMeasReport* in the *UEInformationResponse* message as follows:
 - 3> include the *absoluteTimeStamp* and set it to the value of *absoluteTimeInfo* in the *VarLogMeasReport*;
 - 3> include the *traceReference* and set it to the value of *traceReference* in the *VarLogMeasReport*;
 - 3> include the *traceRecordingSessionRef* and set it to the value of *traceRecordingSessionRef* in the *VarLogMeasReport*;
 - 3> include the *tce-Id* and set it to the value of *tce-Id* in the *VarLogMeasReport*;
 - 3> include the *logMeasInfoList* and set it to include one or more entries from *VarLogMeasReport* starting from the entries logged first;
 - 3> if the *VarLogMeasReport* includes one or more additional logged measurement entries that are not included in the *logMeasInfoList* within the *UEInformationResponse* message:
 - 4> include the *logMeasAvailable*;
 - 1> if the *logMeasReport* is included in the *UEInformationResponse*:
 - 2> submit the *UEInformationResponse* message to lower layers for transmission via SRB2;
 - 2> discard the logged measurement entries included in the *logMeasInfoList* from *VarLogMeasReport* upon successful delivery of the *UEInformationResponse* message confirmed by lower layers;
 - 1> else:
 - 2> submit the *UEInformationResponse* message to lower layers for transmission via SRB1;

[TS 36.331, clause 5.6.8.2]

While T330 is running, the UE shall:

- 1> perform the logging in accordance with the following:
 - 2> if the UE is camping normally on an E-UTRA cell and if the RPLMN is included in *plmn-IdentityList* stored in *VarLogMeasReport* and, if the cell is part of the area indicated by *areaConfiguration* if configured in *VarLogMeasConfig*:
 - 3> perform the logging at regular time intervals, as defined by the *loggingInterval* in *VarLogMeasConfig*;

8.6.2.10.3 Test description

8.6.2.10.3.1 Pre-test conditions

System Simulator:

- Cell 1 and Cell 12
- System information combination 3 as defined in TS 36.508 [18] clause 4.4.3.1 is used in E-UTRA cells.
- The PLMNs are identified in the test by the identifiers in Table 8.6.2.10.3.1-1.

Table 8.6.2.10.3.1-1: PLMN identifiers

Cell	PLMN name
1	PLMN1
12	PLMN2

UE:

None.

Preamble:

- The UE is registered on PLMN1 (Cell 1) using the procedure described in TS 36.508[18] clause 4.5.2.3 except that the ATTACH ACCEPT message indicates PLMN2 in the Equivalent PLMN list as described in Table 8.6.2.10.3.3-5
- The UE is in state Generic RB Established (state 3) on Cell 1 according to [18].

8.6.2.10.3.2 Test procedure sequence

Table 8.6.2.10.3.2-1 illustrates the downlink power levels to be applied for the cell at various time instants of the test execution. Row marked "T0" denotes the initial conditions after preamble, while columns marked "T1" is to be applied subsequently. The exact instants on which these values shall be applied are described in the texts in this clause.

Table 8.6.2.10.3.2-1: Time instances of cell power level and parameter changes

	Parameter	Unit	Cell 1	Cell 12	Remark
T0	Cell-specific RS EPRE	dBm/15kHz	-85	"Off"	Only Cell 1 is available. (NOTE 1)
T1	Cell-specific RS EPRE	dBm/15kHz	-85	-79	The power level values are assigned to satisfy $R_{Cell\ 1} < R_{Cell\ 12}$.
NOTE 1: Power level "Off" for E-UTRA cell is defined in TS 36.508 Table 6.2.2.1-1.					

Table 8.6.2.10.3.2-2: Main behaviour

St	Procedure	Message Sequence		TP	Verdict
		U - S	Message		
1	SS transmits a <i>LoggedMeasurementConfiguration</i> message on Cell 1 to configure the UE to perform logging of measurement results while in RRC_IDLE.	<--	<i>LoggedMeasurementConfiguration</i>	-	-
2	The SS transmits an <i>RRCConnectionRelease</i> message on Cell 1.	<--	<i>RRCConnectionRelease</i>	-	-
3	The SS changes Cell 1 and Cell 12 levels according to the row "T1" in table 8.6.2.10.3.2-1.	-	-	-	-
4	The generic test procedure in TS 36.508 subclause 6.4.2.7 is performed on Cell 12. NOTE: The UE performs a TAU procedure and the RRC connection is released.	-	-	-	-
5	Wait [5s] to allow UE to activate logging.	-	-	-	-
6	The SS transmits a <i>Paging</i> message on Cell 12.	<--	<i>Paging</i>	-	-
7	The UE transmits an <i>RRCConnectionRequest</i> message on Cell 12.	-->	<i>RRCConnectionRequest</i>	-	-
8	The SS transmits an <i>RRCConnectionSetup</i> message on Cell 12.	<--	<i>RRCConnectionSetup</i>	-	-
9	Check: Does the UE transmit an <i>RRCConnectionSetupComplete</i> message with <i>logMeasAvailable</i> on Cell 12?	-->	<i>RRCConnectionSetupComplete</i>	1	P
10-13	Steps 6 to 9 of the generic radio bearer establishment procedure in TS 36.508 subclause 4.5.3.3 are executed to successfully complete the service request procedure on Cell 12.	-	-	-	-
14	The SS transmits a <i>UEInformationRequest</i> message on Cell 12.	<--	<i>UEInformationRequest</i>	-	-
15	Check: Does the UE transmit a <i>UEInformationResponse</i> message with <i>LogMeasInfoList</i> on Cell 12?	-->	<i>UEInformationResponse</i>	2	P

8.6.2.10.3.3 Specific message contents

Table 8.6.2.10.3.3-1: LoggedMeasurementConfiguration (step 1, Table 8.6.2.10.3.2-2)

Derivation Path: 36.508, Table 4.6.1-4.0A			
Information Element	Value/remark	Comment	Condition
LoggedMeasurementConfiguration-r10 ::= SEQUENCE {			
criticalExtensions CHOICE {			
c1 CHOICE {			
loggedMeasurementConfiguration-r10 SEQUENCE {			
loggingInterval-r10	ms1280	1.28 seconds	
nonCriticalExtension SEQUENCE {			
lateNonCriticalExtension-r10	Not present		
nonCriticalExtension SEQUENCE {			
plmn-IdentityList-r11 SEQUENCE (SIZE (1..16)) OF SEQUENCE {	1 entry		
PLMN-Identity [1]	PLMN2		
}			
areaConfiguration-v1130	Not present		
nonCriticalExtension SEQUENCE {	Not present		
}			
}			
}			
}			
}			
}			
}			

Table 8.6.2.10.3.3-2: RRCConnectionSetupComplete (steps 4 and 9, Table 8.6.2.10.3.2-2)

Derivation Path: 36.508, Table 4.6.1-18			
Information Element	Value/remark	Comment	Condition
RRCConnectionSetupComplete ::= SEQUENCE {			
criticalExtensions CHOICE {			
c1 CHOICE{			
rrcConnectionSetupComplete-r8 SEQUENCE {			
nonCriticalExtension SEQUENCE {			
nonCriticalExtension SEQUENCE {			
gummei-Type-r10	Not present or any allowed value		
rlf-InfoAvailable-r10	Not present or any allowed value		
logMeasAvailable-r10	true		
rn-SubframeConfigReq-r10	Not present or any allowed value		
nonCriticalExtension	Not present		
}			
}			
}			
}			
}			
}			

Table 8.6.2.10.3.3-3: UEInformationRequest (step 14, Table 8.6.2.10.3.2-2)

Derivation Path: 36.508, Table 4.6.1-23A condition Logged MDT

Table 8.6.2.10.3.3-4: *UEInformationResponse* (step 15, Table 8.6.2.10.3.2-2)

Derivation Path: 36.508, Table 4.6.1-23B			
Information Element	Value/remark	Comment	Condition
UEInformationResponse-r9 ::=SEQUENCE {			
criticalExtensions CHOICE {			
c1 CHOICE {			
ueInformationResponse-r9 SEQUENCE {			
nonCriticalExtension SEQUENCE {			
nonCriticalExtension SEQUENCE {			
logMeasReport-r10 SEQUENCE {			
absoluteTimeStamp-r10	Same value as sent by SS in <i>LoggedMeasurementConfiguration</i> in step 1		
traceReference-r10 SEQUENCE {			
plmn-Identity-r10 SEQUENCE {			
mcc SEQUENCE (SIZE (3)) OF MCC-MNC-Digit	Same value as sent by SS in <i>LoggedMeasurementConfiguration</i> in step 1		
mnc SEQUENCE (SIZE (2..3)) OF MCC-MNC-Digit	Same value as sent by SS in <i>LoggedMeasurementConfiguration</i> in step 1		
}			
traceId-r10	Same value as sent by SS in <i>LoggedMeasurementConfiguration</i> in step 1		
}			
traceRecordingSessionRef-r10	Same value as sent by SS in <i>LoggedMeasurementConfiguration</i> in step 1		
tce-Id-r10	Same value as sent by SS in <i>LoggedMeasurementConfiguration</i> in step 1		
logMeasInfoList-r10 SEQUENCE {	One or more entries where at least one entry complies to entry with index 'x' below.		
locationInfo-r10 [x]	Not present or any allowed value		
relativeTimeStamp-r10 [x]	Any allowed value		
servCellIdentity-r10 [x] SEQUENCE {			
plmn-Identity [x]	<i>plmn-Identity</i> within <i>SystemInformationBlockType1</i> broadcasted in Cell 12		
cellIdentity [x]	<i>cellIdentity</i> within <i>SystemInformationBlockType1</i> broadcasted in Cell 12		
}			
measResultServCell-r10 [x] SEQUENCE {			
rsrpResult-r10 [x]	(0..97)		
rsrqResult-r10 [x]	(0..34)		
}			
measResultNeighCells-r10 SEQUENCE {			
measResultListEUTRA-r10 SEQUENCE {	1 entry		
carrierFreq-r9 [1]	Same downlink EARFCN as used for Cell 1		
measResultList-r9 [1] SEQUENCE {			
physCellId [1]	PhysicalCellIdentity of Cell 1		

- 1> set the content of *RRCCONNECTIONRECONFIGURATIONCOMPLETE* message as follows:
 - 2> if the UE has radio link failure or handover failure information available in *VarRLF-Report* and if the RPLMN is included in *plmn-IdentityList* stored in *VarRLF-Report*:
 - 3> include *rlf-InfoAvailable*;
 - 2> if the UE has logged measurements available for E-UTRA and if the RPLMN is included in *plmn-IdentityList* stored in *VarLogMeasReport*:
 - 3> include the *logMeasAvailable*;
 - 2> if the UE has connection establishment failure information available in *VarConnEstFail-Report* and if the RPLMN is equal to *plmn-Identity* stored in *VarConnEstFail-Report*:
 - 3> include *connEstFailInfoAvailable*;
- 1> submit the *RRCCONNECTIONRECONFIGURATIONCOMPLETE* message to lower layers for transmission;
- 1> if MAC successfully completes the random access procedure:
 - 2> stop timer T304;
 - 2> apply the parts of the CQI reporting configuration, the scheduling request configuration and the sounding RS configuration that do not require the UE to know the SFN of the target PCell, if any;
 - 2> apply the parts of the measurement and the radio resource configuration that require the UE to know the SFN of the target PCell (e.g. measurement gaps, periodic CQI reporting, scheduling request configuration, sounding RS configuration), if any, upon acquiring the SFN of the target PCell;

NOTE 3: Whenever the UE shall setup or reconfigure a configuration in accordance with a field that is received it applies the new configuration, except for the cases addressed by the above statements.

- 2> the procedure ends;

NOTE 4: The UE is not required to determine the SFN of the target PCell by acquiring system information from that cell before performing RACH access in the target PCell.

[TS 36.331, clause 5.6.5.3 (TP2)]

Upon receiving the *UEINFORMATIONREQUEST* message, the UE shall:

...

- 1> if the *logMeasReportReq* is present and if the RPLMN is included in *plmn-IdentityList* stored in *VarLogMeasReport*:
 - 2> if *VarLogMeasReport* includes one or more logged measurement entries, set the contents of the *logMeasReport* in the *UEINFORMATIONRESPONSE* message as follows:
 - 3> include the *absoluteTimeStamp* and set it to the value of *absoluteTimeInfo* in the *VarLogMeasReport*;
 - 3> include the *traceReference* and set it to the value of *traceReference* in the *VarLogMeasReport*;
 - 3> include the *traceRecordingSessionRef* and set it to the value of *traceRecordingSessionRef* in the *VarLogMeasReport*;
 - 3> include the *tce-Id* and set it to the value of *tce-Id* in the *VarLogMeasReport*;
 - 3> include the *logMeasInfoList* and set it to include one or more entries from *VarLogMeasReport* starting from the entries logged first;
 - 3> if the *VarLogMeasReport* includes one or more additional logged measurement entries that are not included in the *logMeasInfoList* within the *UEINFORMATIONRESPONSE* message:
 - 4> include the *logMeasAvailable*;
- 1> if the *logMeasReport* is included in the *UEINFORMATIONRESPONSE*:

- 2> submit the *UEInformationResponse* message to lower layers for transmission via SRB2;
- 2> discard the logged measurement entries included in the *logMeasInfoList* from *VarLogMeasReport* upon successful delivery of the *UEInformationResponse* message confirmed by lower layers;

1> else:

- 2> submit the *UEInformationResponse* message to lower layers for transmission via SRB1;

8.6.2.11.3 Test description

8.6.2.11.3.1 Pre-test conditions

System Simulator:

- Cell 1, Cell 2 and Cell 12.
- System information combination 3 as defined in TS 36.508 [18] clause 4.4.3.1 is used in E-UTRA cells.
- The PLMNs are identified in the test by the identifiers in Table 8.6.2.11.3.1-1.

Table 8.6.2.11.3.1-1: PLMN identifiers

Cell	PLMN name
1, 2	PLMN1
12	PLMN2

UE:

None

Preamble:

- The UE is registered on PLMN2 (Cell 12) using the procedure described in TS 36.508[18] clause 4.5.2.3 except that the ATTACH ACCEPT message indicates PLMN1 in the Equivalent PLMN list as described in Table 8.6.2.11.3.3-5
- The UE is in state Generic RB Established (state 3) on Cell 12 according to [18].

8.6.2.11.3.2 Test procedure sequence

Table 8.6.2.11.3.2-1 shows the cell configurations used during the test. The configuration T0 indicates the initial conditions. Subsequent configurations marked "T1" and "T2" are applied at the points indicated in the Main behaviour description in Table 8.6.2.11.3.2-2.

Table 8.6.2.11.3.2-1: Cell configuration changes over time

	Parameter	Unit	Cell 12	Cell 1	Cell 2	Remark
T0	RS EPRE	dBm/15kHz	-85	-91	"Off"	
T1	RS EPRE	dBm/15kHz	-85	-79	"Off"	
T2	RS EPRE	dBm/15kHz	-85	-91	-79	

Table 8.6.2.11.3.2-2: Main behaviour

St	Procedure	Message Sequence		TP	Verdict
		U - S	Message		
1	The SS transmits a <i>LoggedMeasurementConfiguration</i> message on Cell 12.	<--	<i>LoggedMeasurementConfiguration</i>	-	-
2	The SS transmits an <i>RRCConnectionRelease</i> message to release the RRC connection.	<--	<i>RRCConnectionRelease</i>	-	-
3	Wait 30 seconds for UE performing the logging at regular time intervals on Cell 12.	-	-	-	-
4	The SS changes Cell 1 and Cell 12 levels according to the row "T1" in table 8.6.2.11.3.2-1.	-	-	-	-
5	The generic test procedure in TS 36.508 subclause 6.4.2.7 is performed on Cell 1. NOTE: The UE performs a TAU procedure and the RRC connection is released.	-	-	-	-
6	Wait 30 seconds for UE performing the logging at regular time intervals on Cell 1	-	-	-	-
7-14	Steps 2 to 9 of the generic radio bearer establishment procedure in TS 36.508 subclause 4.5.3.3 are executed to successfully complete the service request procedure on Cell 1.	-	-	-	-
15	The SS changes Cell 1 and Cell 2 parameters according to the row "T2" in table 8.6.2.11.3.2-1.	-	-	-	-
16	The SS transmits an <i>RRCConnectionReconfiguration</i> message on Cell 1 to order the UE to perform intra frequency handover to Cell 2.	<--	<i>RRCConnectionReconfiguration</i>	-	-
17	Check: Does the UE transmit an <i>RRCConnectionReconfigurationComplete</i> message on Cell 2 with <i>logMeasAvailable</i> set true to confirm the successful completion of the intra frequency handover?	-->	<i>RRCConnectionReconfigurationComplete</i>	1	P
18	The SS sends a <i>UEInformationRequest</i> message with <i>logMeasReportReq</i> present.	<--	<i>UEInformationRequest</i>		
19	Check: Does the UE send a <i>UEInformationResponse</i> message with <i>logMeasReport</i> including logged measurements did on Cell 1 and Cell 12?	-->	<i>UEInformationResponse</i>	2	P

8.6.2.11.3.3 Specific message contents

Table 8.6.2.11.3.3-1: LoggedMeasurementConfiguration (step 1, Table 8.6.2.11.3.2-2)

Derivation Path: 36.508, Table 4.6.1-4.0A			
Information Element	Value/remark	Comment	Condition
LoggedMeasurementConfiguration-r10 ::= SEQUENCE {			
criticalExtensions CHOICE {			
c1 CHOICE {			
loggedMeasurementConfiguration-r10 SEQUENCE {			
nonCriticalExtension SEQUENCE {			
lateNonCriticalExtension	Not present		
nonCriticalExtension SEQUENCE {			
plmn-IdentityList-r11 SEQUENCE (SIZE (1..16)) OF {	1 entry		
PLMN-Identity [1]	PLMN1		
PLMN-Identity [2]	PLMN2		
}			
nonCriticalExtension	Not present		
}			
}			
}			
}			
}			
}			
}			

Table 8.6.2.11.3.3-2: RRCConnectionReconfigurationComplete (step 17, Table 8.6.2.11.3.2-2)

Derivation path: 36.508 clause 4.6.1 table 4.6.1-9 RRCConnectionReconfigurationComplete			
Information Element	Value/remark	Comment	Condition
RRCConnectionReconfigurationComplete ::= SEQUENCE {			
criticalExtensions CHOICE {			
rrcConnectionReconfigurationComplete-r8 SEQUENCE {			
nonCriticalExtension SEQUENCE {			
nonCriticalExtension SEQUENCE {			
rlf-InfoAvailable-r10	Not checked		
logMeasAvailable-r10	true		
nonCriticalExtension SEQUENCE {}	Not checked		
}			
}			
}			
}			
}			

Table 8.6.2.11.3.3-3: UEInformationRequest (step 18, Table 8.6.2.11.3.2-2)

Derivation Path: 36.508 clause 4.6.1 table 4.6.1-23A UEInformationRequest, condition "Logged MDT"

Table 8.6.2.11.3.3-4: *UEInformationResponse* (step 19, Table 8.6.2.11.3.2-2)

Derivation Path: 36.508 clause 4.6.1 table 4.6.1-23B <i>UEInformationResponse</i>			
Information Element	Value/remark	Comment	Condition
<i>UEInformationResponse</i> -r9 ::= SEQUENCE {			
<i>criticalExtensions</i> CHOICE {			
c1 CHOICE{			
<i>ueInformationResponse</i> -r9 SEQUENCE {			
<i>nonCriticalExtension</i> SEQUENCE {			
<i>lateNonCriticalExtension</i>	Not checked		
<i>nonCriticalExtension</i> SEQUENCE {			
<i>logMeasReport</i> -r10 SEQUENCE {			
<i>absoluteTimeStamp</i> -r10	Same value as <i>absoluteTimeInfo</i> sent by SS in <i>LoggedMeasurementConfiguration</i> in step 1		
<i>traceReference</i> -r10 SEQUENCE {			
<i>plmn-identity</i> -r10 SEQUENCE {			
mcc SEQUENCE (SIZE (3)) OF MCC-NMC-Digit	Same value as sent by SS in <i>LoggedMeasurementConfiguration</i> in step 1		
mnc SEQUENCE (SIZE (2..3)) OF MCC-NMC-Digit	Same value as sent by SS in <i>LoggedMeasurementConfiguration</i> in step 1		

}			
traceld-r10	Same value as sent by SS in <i>LoggedMeasurementConfiguration</i> in step 1		
}			
traceRecordingSessionRef-r10	Same value as sent by SS in <i>LoggedMeasurementConfiguration</i> in step 1		
tce-ld-r10	Same value as sent by SS in <i>LoggedMeasurementConfiguration</i> in step 1		
logMeasInfoList-r10 SEQUENCE (SIZE (1..maxLogMeasReport-r10)) OF SEQUENCE {	SS records the relativeTimeStamp value for each entry		
locationInfo-r10[1]	Not checked		
relativeTimeStamp-r10 [1]	SS record the value		
servCellIdentity-r10 [1]	Cell 12		
measResultServCell-r10 [1] SEQUENCE {			
rsrpResult-r10	(0..97)		
rsrqResult-r10	(0..34)		
}			
measResultNeighCells-r10[1] SEQUENCE {	Not checked		
measResultListEUTRA-r10 SEQUENCE (SIZE (1..maxFreq)) OF {			
carrierFreq-r9[1]	Same downlink EARFCN as used for Cell 1		
measResultList-r9[1] SEQUENCE (SIZE (1..maxCellReport)) OF {			
physCellId	Cell 1		
cgi-Info	Not present		
measResult SEQUENCE {			
rsrpResult	(0..97)		
rsrqResult	(0..34)		
}			
}			
}			
}			
locationInfo-r10[2]	Not checked		
relativeTimeStamp-r10 [2]	SS record the value		
servCellIdentity-r10 [2]	Cell 1		
measResultServCell-r10 [2] SEQUENCE {			
rsrpResult-r10	(0..97)		
rsrqResult-r10	(0..34)		
}			
measResultNeighCells-r10[2] SEQUENCE {	Not checked		
measResultListEUTRA-r10 SEQUENCE (SIZE (1..maxFreq)) OF {			
carrierFreq-r9[1]	Same downlink EARFCN as used for Cell 12		
measResultList-r9[1] SEQUENCE (SIZE (1..maxCellReport)) OF {			
physCellId	Cell 12		
cgi-Info	Not present		
measResult SEQUENCE {			
rsrpResult	(0..97)		
rsrqResult	(0..34)		
}			
}			
}			
}			
logMeasAvailable-r10	Not present		

}			
nonCriticalExtension SEQUENCE {	Not checked		
}			
}			
}			
}			
}			
}			

Table 8.6.2.11.3.3-5: ATTACH ACCEPT for Cell 12 (preamble)

Derivation path: 36.508 Table 4.7.2-1			
Information Element	Value/Remark	Comment	Condition
Equivalent PLMNs	PLMN1		

8.6.2.12 Logged MDT / Logging and reporting / Reporting at RRC connection re-establishment / PLMN list

8.6.2.12.1 Test Purpose (TP)

(1)

```
with { UE received LoggedMeasurementConfiguration message with plmn-IdentityList-r11 configured and
UE has logged measurements available with the RPLMN included in plmn-IdentityList stored in
VarLogMeasReport }
ensure that {
  when { UE has initiated a re-establishment procedure and receives an RRCConnectionReestablishment
message }
  then { UE transmits an RRCConnectionReestablishmentComplete message with logMeasAvailable is
true }
}
```

(2)

```
with { UE indicated the availability of logged measurements in RRCConnectionReestablishmentComplete
message }
ensure that {
  when { UE has successfully completed the re-establishment procedure and resume the existing radio
bearer; and has received a UEInformationRequest message with logMeasReportReq present }
  then { UE transmits a UEInformationResponse message including logMeasReport }
}
```

8.6.2.12.2 Conformance requirements

References: The conformance requirements covered in the present TC are specified in: TS 36.331, clauses 5.3.7.5 and 5.6.5.3. Unless otherwise stated these are Rel-11 requirements.

[TS 36.331, clause 5.3.7.5 (TP1)]

The UE shall:

1> stop timer T301;

...

1> set the content of *RRCConnectionReestablishmentComplete* message as follows:

2> if the UE has radio link failure or handover failure information available in *VarRLF-Report* and if the RPLMN is included in *plmn-IdentityList* stored in *VarRLF-Report*:

3> include the *rlf-InfoAvailable*;

2> if the UE has logged measurements available for E-UTRA and if the RPLMN is included in *plmn-IdentityList* stored in *VarLogMeasReport*:

3> include the *logMeasAvailable*;

2> if the UE has connection establishment failure information available in *VarConnEstFailReport* and if the RPLMN is equal to *plmn-Identity* stored in *VarConnEstFailReport*:

3> include the *connEstFailInfoAvailable*;

1> perform the measurement related actions as specified in 5.5.6.1;

1> perform the measurement identity autonomous removal as specified in 5.5.2.2a;

1> submit the *RRCConnectionReestablishmentComplete* message to lower layers for transmission, upon which the procedure ends;

[TS 36.331, clause 5.6.5.3 (TP2)]

Upon receiving the *UEInformationRequest* message, the UE shall:

...

1> if the *logMeasReportReq* is present and if the RPLMN is included in *plmn-IdentityList* stored in *VarLogMeasReport*:

2> if *VarLogMeasReport* includes one or more logged measurement entries, set the contents of the *logMeasReport* in the *UEInformationResponse* message as follows:

3> include the *absoluteTimeStamp* and set it to the value of *absoluteTimeInfo* in the *VarLogMeasReport*;

3> include the *traceReference* and set it to the value of *traceReference* in the *VarLogMeasReport*;

3> include the *traceRecordingSessionRef* and set it to the value of *traceRecordingSessionRef* in the *VarLogMeasReport*;

3> include the *tce-Id* and set it to the value of *tce-Id* in the *VarLogMeasReport*;

3> include the *logMeasInfoList* and set it to include one or more entries from *VarLogMeasReport* starting from the entries logged first;

3> if the *VarLogMeasReport* includes one or more additional logged measurement entries that are not included in the *logMeasInfoList* within the *UEInformationResponse* message:

4> include the *logMeasAvailable*;

1> if the *logMeasReport* is included in the *UEInformationResponse*:

2> submit the *UEInformationResponse* message to lower layers for transmission via SRB2;

2> discard the logged measurement entries included in the *logMeasInfoList* from *VarLogMeasReport* upon successful delivery of the *UEInformationResponse* message confirmed by lower layers;

1> else:

2> submit the *UEInformationResponse* message to lower layers for transmission via SRB1;

8.6.2.12.3 Test description

8.6.2.12.3.1 Pre-test conditions

System Simulator:

- Cell 1 and Cell 12.
- System information combination 3 as defined in TS 36.508 [18] clause 4.4.3.1 is used in E-UTRA cells.
- The PLMNs are identified in the test by the identifiers in Table 8.6.2.12.3.1-1.

Table 8.6.2.12.3.1-1: PLMN identifiers

Cell	PLMN name
1	PLMN1
12	PLMN2

UE:

None

Preamble:

- The UE is registered on PLMN1 (Cell 1) using the procedure described in TS 36.508[18] clause 4.5.2.3 except that the ATTACH ACCEPT message indicates PLMN2 in the Equivalent PLMN list as described in Table 8.6.2.12.3.3-6.
- The UE is in state Generic RB Established (state 3) on Cell 1 according to [18].

8.6.2.12.3.2 Test procedure sequence

Table 8.6.2.12.3.2-1 shows the cell configurations used during the test. The configuration T0 indicates the initial conditions. Subsequent configurations marked "T1" are applied at the points indicated in the Main behaviour description in Table 8.6.2.12.3.2-2.

Table 8.6.2.12.3.2-1: Cell configuration changes over time

	Parameter	Unit	Cell 1	Cell 12
T0	Cell-specific RS EPRE	dBm/15kHz	-85	-91
T1	Cell-specific RS EPRE	dBm/15kHz	Off	-85

Table 8.6.2.12.3.2-2: Main behaviour

St	Procedure	Message Sequence		TP	Verdict
		U - S	Message		
1	The SS transmits a <i>LoggedMeasurementConfiguration</i> message on Cell 1.	<--	<i>LoggedMeasurementConfiguration</i>	-	-
2	The SS transmits an <i>RRCConnectionRelease</i> message to release the RRC connection.	<--	<i>RRCConnectionRelease</i>	-	-
3	Wait 30 seconds for UE performing the logging at regular time intervals	-	-	-	-
4-12	Steps 1 to 9 of the generic radio bearer establishment procedure in TS 36.508 subclause 4.5.3.3 are executed to successfully complete the service request procedure on Cell 1.	-	-	-	-
13	The SS changes Cell 1 and Cell 12 parameters according to the row "T1" in table 8.6.2.12.3.2-1 in order that the radio link quality of Cell 1 is degraded and Cell 12 is suitable for camping.	-	-	-	-
14	The UE sends <i>RRCConnectionReestablishmentRequest</i> message on Cell 12.	-->	<i>RRCConnectionReestablishmentRequest</i>	-	-
15	The SS transmits <i>RRCConnectionReestablishment</i> message.	<--	<i>RRCConnectionReestablishment</i>	-	-
16	Check: Does the UE transmit <i>RRCConnectionReestablishmentComplete</i> message with <i>logMeasAvailable</i> set to true?	-->	<i>RRCConnectionReestablishmentComplete</i>	1	P
17	The SS transmits an <i>RRCConnectionReconfiguration</i> message to resume the existing radio bearer.	<--	<i>RRCConnectionReconfiguration</i>	-	-
18	The UE transmits an <i>RRCConnectionReconfigurationComplete</i> message.	-->	<i>RRCConnectionReconfigurationComplete</i>	-	-
19	The SS sends a <i>UEInformationRequest</i> message with <i>logMeasReportReq</i> present.	<--	<i>UEInformationRequest</i>	-	-
20	Check: Does the UE send a <i>UEInformationResponse</i> message including <i>logMeasReport</i> ?	-->	<i>UEInformationResponse</i>	2	P

8.6.2.12.3.3 Specific message contents

Table 8.6.2.12.3.3-1: LoggedMeasurementConfiguration (step 1, Table 8.6.2.12.3.2-2)

Derivation Path: 36.508, Table 4.6.1-4.0A			
Information Element	Value/remark	Comment	Condition
LoggedMeasurementConfiguration-r10 ::= SEQUENCE {			
criticalExtensions CHOICE {			
c1 CHOICE {			
loggedMeasurementConfiguration-r10 SEQUENCE {			
nonCriticalExtension SEQUENCE {			
lateNonCriticalExtension	Not present		
nonCriticalExtension SEQUENCE {			
plmn-IdentityList-r11 SEQUENCE (SIZE (1..16)) OF {			
PLMN-Identity [1]	PLMN1		
PLMN-Identity [2]	PLMN2		
}			
nonCriticalExtension	Not present		
}			
}			
}			
}			
}			

Table 8.6.2.12.3.3-2: RRCConnectionReestablishmentComplete (step 16, Table 8.6.2.12.3.2-2)

Derivation path: 36.508 clause 4.6.1 table 4.6.1-11 RRCConnectionReestablishmentComplete			
Information Element	Value/remark	Comment	Condition
RRCConnectionReestablishmentComplete ::= SEQUENCE {			
criticalExtensions CHOICE {			
rrcConnectionReestablishmentComplete-r8 SEQUENCE {			
nonCriticalExtension SEQUENCE {			
rf-InfoAvailable-r9	true		
nonCriticalExtension SEQUENCE {			
lateNonCriticalExtension	Not present		
nonCriticalExtension SEQUENCE {			
logMeasAvailable-r10	true		
nonCriticalExtension SEQUENCE {	Not checked		
}			
}			
}			
}			
}			
}			

Table 8.6.2.12.3.3-3: RRCConnectionReconfiguration (step 17, Table 8.6.2.12.3.2-2)

Derivation Path: 36.508, Table 4.6.1-8			
Information Element	Value/remark	Comment	Condition
RRCConnectionReconfiguration ::= SEQUENCE {			
criticalExtensions CHOICE {			
c1 CHOICE{			
rrcConnectionReconfiguration-r8 SEQUENCE {			
radioResourceConfigDedicated	RadioResourceConfigDe dicated-HO		
}			
}			
}			
}			

Table 8.6.2.12.3.3-4: UEInformationRequest (step 19, Table 8.6.2.12.3.2-2)

Derivation Path: 36.508 clause 4.6.1 table 4.6.1-23A *UEInformationRequest*, condition "Logged MDT"

Table 8.6.2.12.3.3-5: UEInformationResponse (step 20, Table 8.6.2.12.3.2-2)

Derivation Path: 36.508 clause 4.6.1 table 4.6.1-23B <i>UEInformationResponse</i>			
Information Element	Value/remark	Comment	Condition
UEInformationResponse-r9 ::= SEQUENCE {			
criticalExtensions CHOICE {			
c1 CHOICE{			
ueInformationResponse-r9 SEQUENCE {			
nonCriticalExtension SEQUENCE {			
lateNonCriticalExtension	Not checked		
nonCriticalExtension SEQUENCE {			
logMeasReport-r10 SEQUENCE {			
absoluteTimeStamp-r10	Same value as <i>absoluteTimeInfo</i> sent by SS in <i>LoggedMeasurementCon figuration</i> in step 1		
traceReference-r10 SEQUENCE {			
plmn-Identity-r10 SEQUENCE {			
mcc SEQUENCE (SIZE (3)) OF MCC- NMC-Digit	Same value as sent by SS in <i>LoggedMeasurementCon figuration</i> in step 1		
mnc SEQUENCE (SIZE (2..3)) OF MCC- NMC-Digit	Same value as sent by SS in <i>LoggedMeasurementCon figuration</i> in step 1		

}			
traceld-r10	Same value as sent by SS in <i>LoggedMeasurementConfiguration</i> in step 1		
}			
traceRecordingSessionRef-r10	Same value as sent by SS in <i>LoggedMeasurementConfiguration</i> in step 1		
tce-ld-r10	Same value as sent by SS in <i>LoggedMeasurementConfiguration</i> in step 1		
logMeasInfoList-r10 SEQUENCE (SIZE (1..maxLogMeasReport-r10)) OF SEQUENCE {	SS records the relativeTimeStamp value for each entry		
locationInfo-r10[1]	Not checked		
relativeTimeStamp-r10 [1]	SS record the value		
servCellIdentity-r10 [1]	Cell 1		
measResultServCell-r10 [1] SEQUENCE {			
rsrpResult-r10	(0..97)		
rsrqResult-r10	(0..34)		
}			
measResultNeighCells-r10[1] SEQUENCE {			
measResultListEUTRA-r10 SEQUENCE (SIZE (1..maxFreq)) OF {			
carrierFreq-r9[1]	Same downlink EARFCN as used for Cell 12		
measResultList-r9[1] SEQUENCE (SIZE (1..maxCellReport)) OF {			
physCellId	Cell 12		
cgi-Info	Not present		
measResult SEQUENCE {			
rsrpResult	(0..97)		
rsrqResult	(0..34)		
}			
}			
}			
}			
logMeasAvailable-r10	Not present		
}			
nonCriticalExtension SEQUENCE {	Not checked		
}			
}			
}			
}			
}			
}			

Table 8.6.2.12.3.3-6: ATTACH ACCEPT for Cell 1 (preamble)

Derivation path: 36.508 Table 4.7.2-1			
Information Element	Value/Remark	Comment	Condition
Equivalent PLMNs	PLMN2		

8.6.2.13 Logged MDT / Logging and reporting / PLMN list / PLMN change

8.6.2.13.1 Test Purpose (TP)

(1)

```
with { UE is in E-UTRA RRC_IDLE state, UE has logged measurements available and the RPLMN is not the
PLMN where the UE received LoggedMeasurementConfiguration message and is not included in plmn-
IdentityList received in LoggedMeasurementConfiguration message }
ensure that {
  when { UE performs an RRC Connection establishment procedure }
  then { UE sends an RRCConnectionSetupComplete message not including logMeasAvailable }
}
```

(2)

```
with { UE is in E-UTRA RRC_IDLE state, UE has logged measurements available and the RPLMN is not the
PLMN where the UE received LoggedMeasurementConfiguration message and is not included in plmn-
IdentityList received in LoggedMeasurementConfiguration message }
ensure that {
  when { UE selects the cell which belongs to the PLMN included in plmn-IdentityList and then
performs an RRC Connection establishment procedure }
  then { UE sends an RRCConnectionSetupComplete message with logMeasAvailable }
}
```

8.6.2.13.2 Conformance requirements

References: The conformance requirements covered in the present TC are specified in: TS 36.304, clause 8; TS 36.331, clauses 5.3.3.4, and 5.6.8.2.

[TS 36.304, clause 8]

The UE may be configured to perform logging of measurement results in RRC_IDLE mode with the *LoggedMeasurementsConfiguration* message as specified in TS 36.331 [3]. This configuration is valid while the logging duration timer is running.

If the configuration of logged measurements is valid, the UE shall perform logging of measurement results if all of the following conditions are met:

- The UE is in *camped normally* state in RRC_IDLE mode;
- The RPLMN of the UE is the same as the RPLMN at the point of time of *LoggedMeasurementConfiguration* message reception, or is present in the *plmn-IdentityList* (see TS 36.331 [3]) if configured;
- The UE is camped on a cell belonging to the *areaConfiguration* (see TS 36.331 [3]), if configured;
- The UE is camped on the RAT where the logged measurement configuration was received.

Otherwise, the logging of measurement results shall be suspended.

NOTE: Even if logging of measurement results is suspended, the logging duration timer and time stamp will continue, and the logged measurement configuration and corresponding log are kept.

[TS 36.331, clause 5.3.3.4]

The UE shall:

...

1> set the content of *RRCConnectionSetupComplete* message as follows:

...

2> if the UE has logged measurements available for E-UTRA and if the RPLMN is included in *plmn-IdentityList* stored in *VarLogMeasReport*:

3> include *logMeasAvailable*;

[TS 36.331, clause 5.6.8.2]

While T330 is running, the UE shall:

- 1> perform the logging in accordance with the following:
 - 2> if the UE is camping normally on an E-UTRA cell and if the RPLMN is included in *plmn-IdentityList* stored in *VarLogMeasReport* and, if the cell is part of the area indicated by *areaConfiguration* if configured in *VarLogMeasConfig*:
 - 3> perform the logging at regular time intervals, as defined by the *loggingInterval* in *VarLogMeasConfig*;

8.6.2.13.3 Test description

8.6.2.13.3.1 Pre-test conditions

System Simulator:

- Cell 1, Cell 12 and Cell 13
- System information combination 3 as defined in TS 36.508 [18] clause 4.4.3.1 is used in E-UTRA cells.
- The PLMNs are identified in the test by the identifiers in Table 8.6.2.13.3.1-1.

Table 8.6.2.13.3.1-1: PLMN identifiers

Cell	PLMN name
1	PLMN1
12	PLMN2
13	PLMN3

UE:

None.

Preamble:

- The UE is registered on PLMN1 (Cell 1) using the procedure described in TS 36.508[18] clause 4.5.2.3 except that the ATTACH ACCEPT message indicates PLMN2 in the Equivalent PLMN list as described in Table 8.6.2.13.3.3-4
- The UE is in state Generic RB Established (state 3) on Cell 1 according to [18].

8.6.2.13.3.2 Test procedure sequence

Table 8.6.2.13.3.2-1 illustrates the downlink power levels to be applied for the cell at various time instants of the test execution. Row marked "T0" denotes the initial conditions after preamble, while columns marked "T1" is to be applied subsequently. The exact instants on which these values shall be applied are described in the texts in this clause.

Table 8.6.2.13.3.2-1: Time instances of cell power level and parameter changes

	Parameter	Unit	Cell 1	Cell 12	Cell 13	Remark
T0	Cell-specific RS EPRE	dBm/15 kHz	-85	"Off"	"Off"	Only Cell 1 is available. (NOTE 1)
T1	Cell-specific RS EPRE	dBm/15 kHz	-85	"Off"	-79	The power level values are assigned to satisfy $R_{Cell\ 1} < R_{Cell\ 13}$. (NOTE 1)
T2	Cell-specific RS EPRE	dBm/15 kHz	"Off"	-79	-85	The power level values are assigned to satisfy $R_{Cell\ 13} < R_{Cell\ 12}$. (NOTE 1)
NOTE 1: Power level "Off" for E-UTRA cell is defined in TS 36.508 Table 6.2.2.1-1.						

Table 8.6.2.13.3.2-2: Main behaviour

St	Procedure	Message Sequence		TP	Verdict
		U - S	Message		
1	SS transmits a <i>LoggedMeasurementConfiguration</i> message on Cell 1 to configure the UE to perform logging of measurement results while in RRC_IDLE.	<--	<i>LoggedMeasurementConfiguration</i>	-	-
2	The SS transmits an <i>RRCConnectionRelease</i> message on Cell 1.	<--	<i>RRCConnectionRelease</i>	-	-
3	Wait 5s to allow UE to activate logging.	-	-	-	-
4	The SS changes Cell 1 and Cell 13 levels according to the row "T1" in table 8.6.2.13.3.2-1.	-	-	-	-
5	The UE transmits an <i>RRCConnectionRequest</i> message on Cell 13.	-->	<i>RRCConnectionRequest</i>	-	-
6	The SS transmit an <i>RRCConnectionSetup</i> message on Cell 13.	<--	<i>RRCConnectionSetup</i>	-	-
7	Check: Does the UE transmit an <i>RRCConnectionSetupComplete</i> message with no <i>logMeasAvailable</i> on Cell 13?	-->	<i>RRCConnectionSetupComplete</i>	1	P
8-10	Steps 4 to 6 of the generic radio bearer establishment procedure in TS 36.508 subclause 6.4.2.7 are executed to successfully complete the service request procedure.	-	-	-	-
11	The SS changes Cell 1, Cell 12 and Cell 13 levels according to the row "T2" in table 8.6.2.13.3.2-1.	-	-	-	-
12	The UE transmits an <i>RRCConnectionRequest</i> message on Cell 12.	-->	<i>RRCConnectionRequest</i>	-	-
13	The SS transmit an <i>RRCConnectionSetup</i> message on Cell 12.	<--	<i>RRCConnectionSetup</i>	-	-
14	Check: Does the UE transmit an <i>RRCConnectionSetupComplete</i> message with <i>logMeasAvailable</i> on Cell 12?	-->	<i>RRCConnectionSetupComplete</i>	2	P
15-17	Steps 4 to 6 of the generic radio bearer establishment procedure in TS 36.508 subclause 6.4.2.7 are executed to successfully complete the service request procedure.	-	-	-	-

8.6.2.13.3.3 Specific message contents

Table 8.6.2.13.3.3-1: LoggedMeasurementConfiguration (step 1, Table 8.6.2.13.3.2-2)

Derivation Path: 36.508, Table 4.6.1-4.0A			
Information Element	Value/remark	Comment	Condition
LoggedMeasurementConfiguration-r10 ::= SEQUENCE {			
criticalExtensions CHOICE {			
c1 CHOICE {			
loggedMeasurementConfiguration-r10 SEQUENCE {			
loggingInterval-r10	ms1280	1.28 seconds	
nonCriticalExtension SEQUENCE {			
lateNonCriticalExtension-r10	Not present		
nonCriticalExtension SEQUENCE {			
plmn-IdentityList-r11 SEQUENCE (SIZE (1..16)) OF SEQUENCE {	1 entry		
PLMN-Identity [1]	PLMN2		
}			
areaConfiguration-v1130	Not present		
nonCriticalExtension SEQUENCE {	Not present		
}			
}			
}			
}			
}			
}			
}			

Table 8.6.2.13.3.3-2: RRCConnectionSetupComplete (step 7, Table 8.6.2.13.3.2-2)

Derivation Path: 36.508, Table 4.6.1-18			
Information Element	Value/remark	Comment	Condition
RRCConnectionSetupComplete ::= SEQUENCE {			
criticalExtensions CHOICE {			
c1 CHOICE{			
rrcConnectionSetupComplete-r8 SEQUENCE {			
nonCriticalExtension SEQUENCE {			
nonCriticalExtension SEQUENCE {			
gummei-Type-r10	Not present or any allowed value		
rlf-InfoAvailable-r10	Not present or any allowed value		
logMeasAvailable-r10	Not present		
rn-SubframeConfigReq-r10	Not present or any allowed value		
nonCriticalExtension	Not present		
}			
}			
}			
}			
}			
}			

Table 8.6.2.13.3.3-3: RRCConnectionSetupComplete (step 14, Table 8.6.2.13.3.2-2)

Derivation Path: 36.508, Table 4.6.1-18			
Information Element	Value/remark	Comment	Condition
RRCConnectionSetupComplete ::= SEQUENCE {			
criticalExtensions CHOICE {			
c1 CHOICE{			
rrcConnectionSetupComplete-r8 SEQUENCE {			
nonCriticalExtension SEQUENCE {			
nonCriticalExtension SEQUENCE {			
gummei-Type-r10	Not present or any allowed value		
rif-InfoAvailable-r10	Not present or any allowed value		
logMeasAvailable-r10	true		
rn-SubframeConfigReq-r10	Not present or any allowed value		
nonCriticalExtension	Not present		
}			
}			
}			
}			
}			
}			

Table 8.6.2.13.3.3-4: ATTACH ACCEPT for Cell 1 (preamble)

Derivation path: 36.508 Table 4.7.2-1			
Information Element	Value/Remark	Comment	Condition
Equivalent PLMNs	PLMN2		

8.6.3 Inter-RAT Logged MDT

8.6.3.1 Logged MDT / UTRAN Inter-RAT measurement, logging and reporting

8.6.3.1.1 Test Purpose (TP)

(1)

```
with { UE in E-UTRA RRC_IDLE state camping normally on an E-UTRA cell where logged measurement is
configured without areaConfiguration and the UE is able to detect a UTRA cell }
ensure that {
  when { T330 is running }
  then { UE is logging serving cell idle mode measurements and UTRA neighbouring cell measurements
}
}
```

(2)

```
with { UE in UTRA RRC_CONNECTED state and UE has logged UTRA neighbouring cell measurements
available from earlier measurements performed while in E-UTRA and plmn-Identity stored in
VarLogMeasReport is equal to the RPLMN }
ensure that {
  when { handover from UTRA to E-UTRA cell successfully and T330 is running}
  then { UE includes the logMeasAvailable IE in the RRCConnectionReconfigurationComplete message }
}
```

(3)

```
with { UE in E-UTRA RRC_CONNECTED state and UE has logged UTRA neighbouring cell measurements
available for E-UTRA and plmn-Identity stored in VarLogMeasReport is equal to the RPLMN }
ensure that {
  when { receiving UEInformationRequest message }
  then { UE transmits UEInformationResponse messages with a logMeasReport with UTRA neighbouring
cell measurements }
}
```

8.6.3.1.2 Conformance requirements

References: The conformance requirements covered in the current TC are specified in: TS 34.304, clause 8; TS 36.331, clauses 5.4.2.3, 5.6.5.3, 5.6.6.3, 5.6.8.2, 6.2.2.

[TS 36.304, clause 8 (TP1,TP2)]

The UE may be configured to perform logging of measurement results in RRC_IDLE mode with the *LoggedMeasurementsConfiguration* message as specified in TS 36.331 [3]. This configuration is valid while the logging duration timer is running.

If the configuration of logged measurements is valid, the UE shall perform logging of measurement results if all of the following conditions are met:

- The UE is in *camped normally* state in RRC_IDLE mode;
- RPLMN of the UE is the same as the RPLMN at the point of time of *LoggedMeasurementConfiguration* message reception;
- The UE is camped on a cell belonging to the *areaConfiguration* (see TS 36.331 [3]), if configured;
- The UE is camped on the RAT where the logged measurement configuration was received.

Otherwise, the logging of measurement results shall be suspended.

NOTE 1: Even if logging of measurement results is suspended, the logging duration timer and time stamp will continue, and the logged measurement configuration and corresponding log are kept.

[TS 36.331, clause 5.4.2.3 (TP2)]

The UE shall:

...

1> set the content of *RRCCONNECTIONRECONFIGURATIONCOMPLETE* message as follows:

...

2> if the UE has logged measurements available for E-UTRA and *plmn-Identity* stored in *VarLogMeasReport* is equal to the RPLMN:

3> include *logMeasAvailable*;

1> submit the *RRCCONNECTIONRECONFIGURATIONCOMPLETE* message to lower layers for transmission using the new configuration;

...

2> enter E-UTRA RRC_CONNECTED, upon which the procedure ends;

NOTE 2: The UE is not required to determine the SFN of the target PCell by acquiring system information from that cell before performing RACH access in the target PCell.

[TS 36.331, clause 5.6.5.3 (TP3)]

Upon receiving the *UEINFORMATIONREQUEST* message, the UE shall

...

1> if the *logMeasReportReq* is present and the *plmn-Identity* stored in *VarLogMeasReport* is equal to the RPLMN:

2> if *VarLogMeasReport* includes one or more logged measurement entries, set the contents of the *logMeasReport* in the *UEINFORMATIONRESPONSE* message as follows:

3> include the *absoluteTimeStamp* and set it to the value of *absoluteTimeInfo* in the *VarLogMeasReport*;

3> include the *traceReference* and set it to the value of *traceReference* in the *VarLogMeasReport*;

- 3> include the *traceRecordingSessionRef* and set it to the value of *traceRecordingSessionRef* in the *VarLogMeasReport*;
- 3> include the *tce-Id* and set it to the value of *tce-Id* in the *VarLogMeasReport*;
- 3> include the *logMeasInfoList* and set it to include one or more entries from *VarLogMeasReport* starting from the entries logged first;
- 3> if the *VarLogMeasReport* includes one or more additional logged measurement entries that are not included in the *logMeasInfoList* within the *UEInformationResponse* message:
 - 4> include the *logMeasAvailable*;
- 1> if the *logMeasReport* is included in the *UEInformationResponse*:
 - 2> submit the *UEInformationResponse* message to lower layers for transmission via SRB2;
 - 2> discard the logged measurement entries included in the *logMeasInfoList* from *VarLogMeasReport* upon successful delivery of the *UEInformationResponse* message confirmed by lower layers;
- 1> else:
 - 2> submit the *UEInformationResponse* message to lower layers for transmission via SRB1;

[TS 36.331, clause 5.6.6.3 (TP1)]

Upon receiving the *LoggedMeasurementConfiguration* message the UE shall:

- 1> discard the logged measurement configuration as well as the logged measurement information as specified in 5.6.7;
- 1> store the received *loggingDuration*, *loggingInterval* and *areaConfiguration*, if included, in *VarLogMeasConfig*;
- 1> store the RPLMN as *plmn-Identity* in *VarLogMeasReport*;
- 1> store the received *absoluteTimeInfo*, *traceReference*, *traceRecordingSessionRef* and *tce-Id* in *VarLogMeasReport*;
- 1> start timer T330 with the timer value set to the *loggingDuration*;

[TS 36.331, clause 5.6.8.2 (TP1)]

While T330 is running, the UE shall:

- 1> perform the logging in accordance with the following:
 - 2> if the UE is camping normally on an E-UTRA cell and the RPLMN of the UE is the same as the *plmn-Identity* stored in *VarLogMeasReport* and, if the cell is part of the area indicated by *areaConfiguration* if configured in *VarLogMeasConfig*:
 - 3> perform the logging at regular time intervals, as defined by the *loggingInterval* in *VarLogMeasConfig*;
 - 2> when adding a logged measurement entry in *VarLogMeasReport*, include the fields in accordance with the following:
 - 3> set the *relativeTimeStamp* to indicate the elapsed time since the moment at which the logged measurement configuration was received;
 - 3> if detailed location information became available during the last logging interval, set the content of the *locationInfo* as follows:
 - 4> include the *locationCoordinates*;
 - 3> set the *servCellIdentity* to indicate global cell identity of the cell the UE is camping on;
 - 3> set the *measResultServCell* to include the quantities of the cell the UE is camping on;

- 3> if available, set the *measResultNeighCells*, in order of decreasing ranking-criterion as used for cell reselection, to include neighbouring cell measurements that became available during the last logging interval for at most the following number of neighbouring cells; 6 intra-frequency and 3 inter-frequency neighbours per frequency as well as 3 inter-RAT neighbours, per frequency/ set of frequencies (GERAN) per RAT;

NOTE 3: The UE includes the latest results of the available measurements as used for cell reselection evaluation, which are performed in accordance with the performance requirements as specified in TS 36.133 [16].

- 2> when the memory reserved for the logged measurement information becomes full, stop timer T330 and perform the same actions as performed upon expiry of T330, as specified in 5.6.6.4;

[TS 36.331, clause 6.2.2 (TP1)]

- LoggedMeasurementConfiguration

The *LoggedMeasurementConfiguration* message is used by E-UTRAN to configure the UE to perform logging of measurement results while in RRC_IDLE. It is used to transfer the logged measurement configuration for network performance optimisation, see TS 37.320 [60].

Signalling radio bearer: SRB1

RLC-SAP: AM

Logical channel: DCCH

Direction: E-UTRAN to UE

Table 8.6.3.1.2-1: LoggedMeasurementConfiguration message

```
-- ASN1START
LoggedMeasurementConfiguration-r10 ::= SEQUENCE {
    criticalExtensions      CHOICE {
        c1                  CHOICE {
            loggedMeasurementConfiguration-r10    LoggedMeasurementConfiguration-r10-IEs,
            spare3 NULL, spare2 NULL, spare1 NULL
        },
        criticalExtensionsFuture      SEQUENCE {}
    }
}

LoggedMeasurementConfiguration-r10-IEs ::= SEQUENCE {
    traceReference-r10          TraceReference-r10,
    traceRecordingSessionRef-r10 OCTET STRING (SIZE (2)),
    tce-Id-r10                  OCTET STRING (SIZE (1)),
    absoluteTimeInfo-r10       AbsoluteTimeInfo-r10,
    areaConfiguration-r10      AreaConfiguration-r10          OPTIONAL, -- Need OR
    loggingDuration-r10        LoggingDuration-r10,
    loggingInterval-r10        LoggingInterval-r10,
    nonCriticalExtension        SEQUENCE {}                  OPTIONAL  -- Need OP
}
-- ASN1STOP
```

LoggedMeasurementConfiguration field descriptions

absoluteTimeInfo	Indicates the absolute time in the current cell.
tce-Id	Parameter Trace Collection Entity Id: See TS 32.422 [58].
traceRecordingSessionRef	Parameter Trace Recording Session Reference: See TS 32.422 [58]

8.6.3.1.3 Test description

8.6.3.1.3.1 Pre-test conditions

System Simulator:

- Cell 1, Cell 5 - Cell 1 is E-UTRAN cell, Cell 5 is a UTRA cell.
- Cell power levels are selected according to [18] so that camping on Cell 1 is guaranteed
- System information combination 4 as defined in TS 36.508 [18] clause 4.4.3.1 is used in E-UTRAN cells with content of UTRA carrier frequency list in SIB6 set as defined in TS 36.508 [18] table 6.3.1.3-1.

Preamble:

- The UE is in state Generic RB Established (state 3) according to [18] on Cell 1.

8.6.3.1.3.2 Test procedure sequence

Table 8.6.3.1.3.2-1 illustrates the downlink power levels and other changing parameters to be applied for the cells at various time instants of the test execution. The configuration marked "T1" and "T2" are applied at the point indicated in the Main behaviour description in Table 8.6.3.1.3.2-2.

Table 8.6.3.1.3.2-1: Time instances of cell power level and parameter changes

	Parameter	Unit	Cell 1	Cell 5	Remark
T1	Cell-specific RS EPRE	dBm/15 kHz	-97	-	
	CPICH_Ec	dBm/3.84 MHz	-	-60	$S_{\text{nonServingCell, Cell1}} > \text{Thresh}_{\text{Cell1,high}}$
T2	Cell-specific RS EPRE	dBm/15 kHz	-80	-	The power level values are such that entering conditions for event 3a are satisfied.
	CPICH_Ec	dBm/3.84 MHz	-	-100	

Table 8.6.3.1.3.2-2: Main behaviour

St	Procedure	Message Sequence		TP	Verdict
		U - S	Message		
1	The SS transmits a <i>LoggedMeasurementConfiguration</i> message including to configure the UE to perform logging of measurement results while in RRC_IDLE.	<--	<i>LoggedMeasurementConfiguration</i>	-	-
2	The SS transmits an <i>RRCConnectionRelease</i> message.	<--	<i>RRCConnectionRelease</i>	-	-
3	Wait 5s to allow UE to activate logging	-	-	-	-
4	The SS changes Cell 1 and Cell 5 levels according to the row "T1" in table 8.6.3.1.3.2-1. (Note 1)	-	-	-	-
5	The UE transmits an RRC CONNECTION REQUEST message on Cell 5 to initiate a routing area update procedure. (Note 1)	-->	RRC CONNECTION REQUEST	-	-
6	The SS transmit an RRC CONNECTION SETUP message.	<--	RRC CONNECTION SETUP	-	-
7	The UE transmit an RRC CONNECTION SETUP COMPLETE message.	-->	RRC CONNECTION SETUP COMPLETE	-	-
8-14	Steps 4 to 10 of the generic test procedure in TS 36.508 subclause 6.4.2.8 are performed on Cell 5. NOTE: The UE performs a RAU procedure and the RRC connection is released.	-	-	-	-
15-19	Step 7 to 11 of test procedure in TS 34.123-1 subclause 12.9.14.4 is performed on Cell 5 using the UTRA reference radio bearer parameters and combination "UTRA PS RB" according to TS 36.508 subclause 4.8.3 and Table 4.8.3-1. NOTE: The UE performs Network initiated RAB re-establishment in a UTRAN cell.	-	-	-	-
-	For UTRAN FDD, EXCEPTION: Steps 20a1 to 20a2 describe behaviour that depends on the UE capability; the "lower case letter" identifies a step sequence that takes place if a capability is supported. For UTRAN TDD, goto step 21.	-	-	-	-
20a1	IF <i>pc_UTRA_CompressedModeRequired</i> THEN the SS transmits a PHYSICAL CHANNEL RECONFIGURATION message on Cell 5 including the DPCH compressed mode info.	<--	PHYSICAL CHANNEL RECONFIGURATION	-	-
20a2	The UE transmits a PHYSICAL CHANNEL RECONFIGURATION COMPLETE message on Cell 5.	-->	PHYSICAL CHANNEL RECONFIGURATION COMPLETE	-	-
21	The SS transmits a MEASUREMENT CONTROL message to setup inter-RAT measurement on Cell 5.	<--	MEASUREMENT CONTROL	-	-
22	The SS changes Cell 1 and Cell 5 level according to the row "T2" in table 8.6.3.1.3.2-1.	-	-	-	-
23	The UE transmits a MEASUREMENT REPORT message on Cell 5 including the E-UTRA event results.	-->	MEASUREMENT REPORT	-	-
24	The SS transmits a HANDOVER FROM UTRAN COMMAND message on Cell 5.	<--	HANDOVER FROM UTRAN COMMAND	-	-
25	Check: Does the UE include the IE <i>logMeasAvailable</i> in the <i>RRCConnectionReconfigurationComplete</i> message on Cell 1?	-->	<i>RRCConnectionReconfigurationComplete</i>	2	P
26	The SS transmits a <i>UEInformationRequest</i> message on Cell 1.	<--	<i>UEInformationRequest</i>	-	-

27	Check: Does the UE transmit a <i>UEInformationResponse</i> message with a <i>LogMeasInfoList</i> with at least one inter-RAT neighbouring cell measurement of Cell 1.	-->	<i>UEInformationResponse</i>	1, 3	P
Note 1: The change of power levels is to trigger an inter-RAT cell re-selection procedure to make sure that the UE is logging inter-RAT neighbouring cell measurements (logging interval=2.56 seconds) of Cell 5 while t-ReselectionUTRA timer is running (7 seconds).					

8.6.3.1.3.3 Specific message contents

Table 8.6.3.1.3.3-1: SystemInformationBlockType6 for Cell 1 (preamble, 8.6.3.1.3.2-2)

Derivation Path: 36.508 table 4.4.3.3-5			
Information Element	Value/remark	Comment	Condition
SystemInformationBlockType6 ::= SEQUENCE {			
carrierFreqListUTRA-FDD SEQUENCE (SIZE (1..maxUTRA-FDD-Carrier)) OF SEQUENCE {			UTRA-FDD
carrierFreq[n]	Downlink UARFCN of Cell 5		
cellReselectionPriority[n]	5		
threshX-High[n]	5 (10dB)		
threshX-Low[n]	5 (10dB)		
t-ReselectionUTRA	7		
}			
carrierFreqListUTRA-TDD SEQUENCE (SIZE (1..maxUTRA-TDD-Carrier)) OF SEQUENCE {			UTRA-TDD
carrierFreq[n]	Downlink UARFCN of Cell 5		
cellReselectionPriority[n]	5		
threshX-High[n]	5 (10dB)		
threshX-Low[n]	5 (10dB)		
t-ReselectionUTRA	7		
}			
}			

Condition	Explanation
UTRA-FDD	UTRA FDD cell environment
UTRA-TDD	UTRA TDD cell environment

Table 8.6.3.1.3.3-2: System Information Block type 19 for Cell 5 (preamble, Table 8.6.3.1.3.2-2)

Derivation Path: 36.508 table 4.4.4.1-1			
Information Element	Value/remark	Comment	Condition
SysInfoType19 ::= SEQUENCE {			
utra-PriorityInfoList ::= SEQUENCE {			
utra-ServingCell ::= SEQUENCE {			
priority	5		
}			
}			
}			

Table 8.6.3.1.3.3-3: *LoggedMeasurementConfiguration* (step 1, Table 8.6.3.1.3.2-2)

Derivation path: 36.508 clause 4.6.1 table 4.6.1-4.0A <i>LoggedMeasurementConfiguration</i>			
Information Element	Value/remark	Comment	Condition
LoggedMeasurementConfiguration-r10 ::= SEQUENCE {			
criticalExtensions CHOICE {			
C1 CHOICE {			
loggedMeasurementConfiguration-r10 SEQUENCE {			
loggingInterval-r10	ms2560	2.56 seconds	
}			
}			
}			
}			

Table 8.6.3.1.3.3-4: *RRCConnectionReconfigurationComplete* (step 25, Table 8.6.3.1.3.2-2)

Derivation path: 36.508 clause 4.6.1 table 4.6.1-9 <i>RRCConnectionReconfigurationComplete</i>			
Information Element	Value/remark	Comment	Condition
RRCConnectionReconfigurationComplete ::= SEQUENCE {			
criticalExtensions CHOICE {			
c1 CHOICE {			
rrcConnectionReconfigurationComplete-r8 SEQUENCE {			
nonCriticalExtension SEQUENCE {	Not checked		
nonCriticalExtension SEQUENCE {	Not checked		
rlf-InfoAvailable-r10	Not checked		
logMeasAvailable-r10	TRUE		
nonCriticalExtension SEQUENCE {	Not checked		
}			
}			
}			
}			
}			

Table 8.6.3.1.3.3-5: *UEInformationRequest* (step 26, Table 8.6.3.1.3.2-2)

Derivation Path: 36.508 clause 4.6.1 table 4.6.1-23A *UEInformationRequest*, condition "Logged MDT"

Table 8.6.3.1.3.3-6: *UEInformationResponse* (step 27, Table 8.6.3.1.3.2-2)

Derivation Path: 36.508 clause 4.6.1 table 4.6.1-23B <i>UEInformationResponse</i>			
Information Element	Value/remark	Comment	Condition
UEInformationResponse-r9 ::= SEQUENCE {			
criticalExtensions CHOICE {			
c1 CHOICE {			
ueInformationResponse-r9 SEQUENCE {			
nonCriticalExtension SEQUENCE {			
lateNonCriticalExtension	Not checked		
nonCriticalExtension SEQUENCE {			
logMeasReport-r10 SEQUENCE {			
absoluteTimeStamp-r10	Same value as sent by SS in <i>LoggedMeasurementConfiguration</i> in step 1		

traceReference-r10SEQUENCE {			
plmn-identity-r10 SEQUENCE {			
mcc SEQUENCE (SIZE (3)) OF MCC-NMC-Digit	Same value as sent by SS in <i>LoggedMeasurementConfiguration</i> in step 1		
mnc SEQUENCE (SIZE (2..3)) OF MCC-NMC-Digit	Same value as sent by SS in <i>LoggedMeasurementConfiguration</i> in step 1		
}			
traceId-r10	Same value as sent by SS in <i>LoggedMeasurementConfiguration</i> in step 1		
}			
traceRecordingSessionRef-r10	Same value as sent by SS in <i>LoggedMeasurementConfiguration</i> in step 1		
tce-Id-r10	Same value as sent by SS in <i>LoggedMeasurementConfiguration</i> in step 1		
logMeasInfoList-r10 SEQUENCE (SIZE (1..maxLogMeasReport-r10)) OF SEQUENCE {			
locationInfo-r10[x]	Not checked		
relativeTimeStamp-r10 [x]	SS record the value		
servCellIdentity-r10 [x]	Same as Cell 1		
measResultServCell-r10 [x] SEQUENCE {			
rsrpResult-r10	(0..97)		
rsrqResult-r10	(0..34)		
}			
measResultNeighCells-r10 [x] SEQUENCE {			
measResultListEUTRA-r10	Not present		
measResultListUTRA-r10 SEQUENCE (SIZE (1..maxFreq)) OF SEQUENCE {	1 entry		
carrierFreq-r9[1]	Same as Cell 5		
measResultList-r9[1] SEQUENCE (SIZE (1..maxCellReport)) OF SEQUENCE {	1 entry		
physCellId [1]	Same as Cell 5		
cgi-Info [1]	Not checked		
measResult [1] SEQUENCE {			
utra-RSCP	(-5..91)		
utra-EcN0	(0..49)		
additionalSI-Info-r9	Not present		
}			
}			
measResultListGERAN-r10	Not present		
measResultListCDMA2000-r10	Not present		
}			
}			
logMeasAvailable-r10	Not present		
}			
nonCriticalExtension SEQUENCE {	Not checked		
}			
}			
}			
}			
}			

8.6.3.2 Logged MDT / GERAN Inter-RAT measurement, logging and reporting

8.6.3.2.1 Test Purpose (TP)

(1)

```
with { UE in E-UTRA RRC_IDLE state camping normally on an E-UTRA cell where logged measurement is
configured without areaConfiguration and the UE is able to detect a GERAN cell }
ensure that {
  when { T330 is running }
    then { UE is logging serving cell idle mode measurements and GERAN neighbouring cell measurements
  }
}
```

(2)

```
with { UE in GPRS Registered state with active packet data transfer in NC2 mode and UE has logged
GERAN neighbouring cell measurements available from earlier measurements performed while in E-UTRA
and plmn-Identity stored in VarLogMeasReport is equal to the RPLMN }
ensure that {
  when { UE handover from GERAN to E-UTRA cell successfully and T330 is running }
    then { UE includes the logMeasAvailable IE in the RRCConnectionReconfigurationComplete message }
}
```

(3)

```
with { UE in E-UTRA RRC_CONNECTED state and UE has logged GERAN neighbouring cell measurements
available for E-UTRA and plmn-Identity stored in VarLogMeasReport is equal to the RPLMN }
ensure that {
  when { receiving UEInformationRequest message }
    then { UE transmits UEInformationResponse messages with a logMeasReport with GERAN neighbouring
cell measurements }
}
```

8.6.3.2.2 Conformance requirements

References: The conformance requirements covered in the current TC are specified in: TS 34.304, clause 8; TS 36.331, clauses 5.4.2.3, 5.6.5.3, 5.6.6.3, 5.6.8.2, 6.2.2.

[TS 36.304, clause 8 (TP1)]

The UE may be configured to perform logging of measurement results in RRC_IDLE mode with the *LoggedMeasurementsConfiguration* message as specified in TS 36.331 [3]. This configuration is valid while the logging duration timer is running.

If the configuration of logged measurements is valid, the UE shall perform logging of measurement results if all of the following conditions are met:

- The UE is in *camped normally* state in RRC_IDLE mode;
- RPLMN of the UE is the same as the RPLMN at the point of time of *LoggedMeasurementConfiguration* message reception;
- The UE is camped on a cell belonging to the *areaConfiguration* (see TS 36.331 [3]), if configured;
- The UE is camped on the RAT where the logged measurement configuration was received.

Otherwise, the logging of measurement results shall be suspended.

NOTE 1: Even if logging of measurement results is suspended, the logging duration timer and time stamp will continue, and the logged measurement configuration and corresponding log are kept.

[TS 36.331, clause 5.4.2.3 (TP2)]

The UE shall:

...

1> set the content of *RRCConnectionReconfigurationComplete* message as follows:

...

2> if the UE has logged measurements available for E-UTRA and *plmn-Identity* stored in *VarLogMeasReport* is equal to the RPLMN:

3> include *logMeasAvailable*;

2> submit the *RRCConnectionReconfigurationComplete* message to lower layers for transmission using the new configuration;

...

2> enter E-UTRA RRC_CONNECTED, upon which the procedure ends;

NOTE 2: The UE is not required to determine the SFN of the target PCell by acquiring system information from that cell before performing RACH access in the target PCell.

[TS 36.331, clause 5.6.5.3 (TP3)]

Upon receiving the *UEInformationRequest* message, the UE shall

...

1> if the *logMeasReportReq* is present and the *plmn-Identity* stored in *VarLogMeasReport* is equal to the RPLMN:

2> if *VarLogMeasReport* includes one or more logged measurement entries, set the contents of the *logMeasReport* in the *UEInformationResponse* message as follows:

3> include the *absoluteTimeStamp* and set it to the value of *absoluteTimeInfo* in the *VarLogMeasReport*;

3> include the *traceReference* and set it to the value of *traceReference* in the *VarLogMeasReport*;

3> include the *traceRecordingSessionRef* and set it to the value of *traceRecordingSessionRef* in the *VarLogMeasReport*;

3> include the *tce-Id* and set it to the value of *tce-Id* in the *VarLogMeasReport*;

3> include the *logMeasInfoList* and set it to include one or more entries from *VarLogMeasReport* starting from the entries logged first;

3> if the *VarLogMeasReport* includes one or more additional logged measurement entries that are not included in the *logMeasInfoList* within the *UEInformationResponse* message:

4> include the *logMeasAvailable*;

1> if the *logMeasReport* is included in the *UEInformationResponse*:

2> submit the *UEInformationResponse* message to lower layers for transmission via SRB2;

2> discard the logged measurement entries included in the *logMeasInfoList* from *VarLogMeasReport* upon successful delivery of the *UEInformationResponse* message confirmed by lower layers;

1> else:

2> submit the *UEInformationResponse* message to lower layers for transmission via SRB1;

[TS 36.331, clause 5.6.6.3 (TP1)]

Upon receiving the *LoggedMeasurementConfiguration* message the UE shall:

1> discard the logged measurement configuration as well as the logged measurement information as specified in 5.6.7;

1> store the received *loggingDuration*, *loggingInterval* and *areaConfiguration*, if included, in *VarLogMeasConfig*;

1> store the RPLMN as *plmn-Identity* in *VarLogMeasReport*;

1> store the received *absoluteTimeInfo*, *traceReference*, *traceRecordingSessionRef* and *tce-Id* in *VarLogMeasReport*;

1> start timer T330 with the timer value set to the *loggingDuration*;

[TS 36.331, clause 5.6.8.2 (TP1)]

While T330 is running, the UE shall:

1> perform the logging in accordance with the following:

2> if the UE is camping normally on an E-UTRA cell and the RPLMN of the UE is the same as the *plmn-Identity* stored in *VarLogMeasReport* and, if the cell is part of the area indicated by *areaConfiguration* if configured in *VarLogMeasConfig*:

3> perform the logging at regular time intervals, as defined by the *loggingInterval* in *VarLogMeasConfig*;

2> when adding a logged measurement entry in *VarLogMeasReport*, include the fields in accordance with the following:

3> set the *relativeTimeStamp* to indicate the elapsed time since the moment at which the logged measurement configuration was received;

3> if detailed location information became available during the last logging interval, set the content of the *locationInfo* as follows:

4> include the *locationCoordinates*;

3> set the *servCellIdentity* to indicate global cell identity of the cell the UE is camping on;

3> set the *measResultServCell* to include the quantities of the cell the UE is camping on;

3> if available, set the *measResultNeighCells*, in order of decreasing ranking-criterion as used for cell reselection, to include neighbouring cell measurements that became available during the last logging interval for at most the following number of neighbouring cells; 6 intra-frequency and 3 inter-frequency neighbours per frequency as well as 3 inter-RAT neighbours, per frequency/ set of frequencies (GERAN) per RAT;

NOTE 3: The UE includes the latest results of the available measurements as used for cell reselection evaluation, which are performed in accordance with the performance requirements as specified in TS 36.133 [16].

2> when the memory reserved for the logged measurement information becomes full, stop timer T330 and perform the same actions as performed upon expiry of T330, as specified in 5.6.6.4;

[TS 36.331, clause 6.2.2 (TP1)]

- LoggedMeasurementConfiguration

The *LoggedMeasurementConfiguration* message is used by E-UTRAN to configure the UE to perform logging of measurement results while in RRC_IDLE. It is used to transfer the logged measurement configuration for network performance optimisation, see TS 37.320 [60].

Signalling radio bearer: SRB1

RLC-SAP: AM

Logical channel: DCCH

Direction: E-UTRAN to UE

LoggedMeasurementConfiguration message

```
-- ASN1START
LoggedMeasurementConfiguration-r10 ::= SEQUENCE {
    criticalExtensions      CHOICE {
        c1                  CHOICE {
            loggedMeasurementConfiguration-r10
            LoggedMeasurementConfiguration-r10-IEs,
```

```

        spare3 NULL, spare2 NULL, spare1 NULL
    },
    criticalExtensionsFuture          SEQUENCE {}
}

LoggedMeasurementConfiguration-r10-IEs ::= SEQUENCE {
    traceReference-r10                TraceReference-r10,
    traceRecordingSessionRef-r10      OCTET STRING (SIZE (2)),
    tce-Id-r10                        OCTET STRING (SIZE (1)),
    absoluteTimeInfo-r10              AbsoluteTimeInfo-r10,
    areaConfiguration-r10             AreaConfiguration-r10      OPTIONAL, -- Need OR
    loggingDuration-r10               LoggingDuration-r10,
    loggingInterval-r10               LoggingInterval-r10,
    nonCriticalExtension               SEQUENCE {}                OPTIONAL -- Need OP
}
-- ASN1STOP

```

LoggedMeasurementConfiguration field descriptions	
absoluteTimeInfo	Indicates the absolute time in the current cell.
tce-Id	Parameter Trace Collection Entity Id: See TS 32.422 [58].
traceRecordingSessionRef	Parameter Trace Recording Session Reference: See TS 32.422 [58]

8.6.3.2.3 Test description

8.6.3.2.3.1 Pre-test conditions

System Simulator:

- Cell 1, Cell 24 - Cell 1 is E-UTRAN cell, Cell 24 is a GERAN cell.
- Cell power levels are selected according to [18] so that camping on Cell 1 is guaranteed
- System information combination 5 as defined in TS 36.508 [18] clause 4.4.3.1 is used in E-UTRA cells with content of GERAN carrier frequency group list in SIB7 set as defined in TS 36.508 [18] table 6.3.1.4-1.

Preamble:

- The UE is in state Generic RB Established (state 3) according to [18] on Cell 1.

8.6.3.2.3.2 Test procedure sequence

Table 8.6.3.2.3.2-1 illustrates the downlink power levels and other changing parameters to be applied for the cells at various time instants of the test execution. Row marked "T0" denotes the initial conditions after preamble, while columns marked "T1" is to be applied subsequently.

Table 8.6.3.2.3.2-1: Time instances of cell power level and parameter changes

	Parameter	Unit	Cell 1	Cell 24	Remark
T0	Cell-specific RS EPRE	dBm/15k Hz	-80	-	
	RSSI	dBm	-	[-85]	
T1	Cell-specific RS EPRE	dBm/15k Hz	-100	-	
	RSSI	dBm	-	[-60]	
T2	Cell-specific RS EPRE	dBm/15k Hz	-80	-	
	RSSI	dBm	-	[-85]	

Table 8.6.3.2.3.2-2: Main behaviour

St	Procedure	Message Sequence		TP	Verdict
		U - S	Message		
1	The SS transmits a <i>LoggedMeasurementConfiguration</i> message including to configure the UE to perform logging of measurement results while in RRC_IDLE.	<--	<i>LoggedMeasurementConfiguration</i>	-	-
2	The SS transmits an <i>RRCConnectionRelease</i> message.	<--	<i>RRCConnectionRelease</i>	-	-
3	Wait 5s to allow UE to activate logging	-	-	-	-
4	The SS changes Cell 1 and Cell 24 levels according to the row "T1" in table 8.6.3.2.3.2-1. (Note 1)	-	-	-	-
5	Generic test procedure in TS 36.508 Table 6.4.2.9 is performed and the UE will camp on GERAN Cell 24.				
6	UE is brought into downlink packet transfer mode according to TS 51.010 clause 40.4.3.14				
7	The SS changes Cell 1 and Cell 24 levels according to the row "T2" in table 8.6.3.2.3.2-1.	-	-	-	-
8	The SS transmits PS HANDOVER COMMAND on Cell24	<--	PS HANDOVER COMMAND	-	-
9	Check: Does the UE include the IE <i>logMeasAvailable</i> in the <i>RRCConnectionReconfigurationComplete</i> message on Cell 1?	-->	<i>RRCConnectionReconfigurationComplete</i>	2	P
10	The SS transmits a <i>UEInformationRequest</i> message on Cell 1.	<--	<i>UEInformationRequest</i>	-	-
11	Check: Does the UE transmit a <i>UEInformationResponse</i> message with a <i>LogMeasInfoList</i> with at least one inter-RAT neighbouring cell measurement of Cell 24.	-->	<i>UEInformationResponse</i>	1,3	P
Note 1: The change of power levels is to trigger an inter-RAT cell re-selection procedure to make sure that the UE is logging GERAN neighbouring cell measurements (logging interval=2.56 seconds) of Cell 5 while t-ReselectionGERAN timer is running (7 seconds).					

8.6.3.2.3.3 Specific message contents

Table 8.6.3.2.3.3-1: SystemInformationBlockType7 for cell 1 (preamble and all steps, Table 8.6.3.2.3.2-2)

Derivation Path: 36.508 table 4.4.3.3-6			
Information Element	Value/remark	Comment	Condition
SystemInformationBlockType7 ::= SEQUENCE {			
t-ReselectionGERAN	7		
carrierFreqsInfoListcarrierFreqsInfoListSEQUENCE (SIZE (1..maxGNFG)) OF SEQUENCE {			
carrierFreqs carrierFreqs[n] SEQUENCE {			
startingARFCN[n]	Same starting ARFCN used for cell 24		
bandIndicator[n]	same band used for GERAN cell24		
followingARFCNs[n] CHOICE {			
explicitListOfARFCNs[n]	Same ARFCN used for cell24		
}			
}			
commonInfo[n] SEQUENCE {			
cellReselectionPriority[n]	3		
}			
}			

Table 8.6.3.2.3.3-2: LoggedMeasurementConfiguration (step 1, Table 8.6.3.2.3.2-2)

Derivation path: 36.508 clause 4.6.1 table 4.6.1-4.0A LoggedMeasurementConfiguration			
Information Element	Value/remark	Comment	Condition
LoggedMeasurementConfiguration-r10 ::= SEQUENCE {			
criticalExtensions CHOICE {			
C1 CHOICE {			
loggedMeasurementConfiguration-r10 SEQUENCE {			
loggingInterval-r10	ms2560	2.56 seconds	
}			
}			
}			
}			

Table 8.6.3.2.3.3-3: RRCConnectionReconfigurationComplete (step 9, Table 8.6.3.2.3.2-2)

Derivation path: 36.508 clause 4.6.1 table 4.6.1-9 RRCConnectionReconfigurationComplete			
Information Element	Value/remark	Comment	Condition
RRCConnectionReconfigurationComplete ::= SEQUENCE {			
criticalExtensions CHOICE {			
c1 CHOICE {			
rrcConnectionReconfigurationComplete-r8 SEQUENCE {			
nonCriticalExtension SEQUENCE {	Not checked		
nonCritriticalExtension SEQUENCE {	Not checked		
rlf-InfoAvailable-r10	Not checked		
logMeasAvailable-r10	TRUE		
nonCriticalExtension SEQUENCE {	Not checked		
}			
}			
}			
}			
}			
}			
}			
}			

Table 8.6.3.2.3.3-4: UEInformationRequest (step 10, Table 8.6.3.2.3.2-2)

Derivation Path: 36.508 clause 4.6.1 table 4.6.1-23A UEInformationRequest, condition "Logged MDT"

Table 8.6.3.2.3.3-5: UEInformationResponse (step 11, Table 8.6.3.2.3.2-2)

Derivation Path: 36.508 clause 4.6.1 table 4.6.1-23B UEInformationResponse			
Information Element	Value/remark	Comment	Condition
UEInformationResponse-r9 ::= SEQUENCE {			
criticalExtensions CHOICE {			
c1 CHOICE{			
ueInformationResponse-r9 SEQUENCE {			
nonCriticalExtension SEQUENCE {			
lateNonCriticalExtension	Not checked		
nonCriticalExtension SEQUENCE {			
logMeasReport-r10 SEQUENCE {			
absoluteTimeStamp-r10	Same value as sent by SS in LoggedMeasurementConfiguration in step 1		

traceReference-r10SEQUENCE {			
plmn-identity-r10 SEQUENCE {			
mcc SEQUENCE (SIZE (3)) OF MCC-NMC-Digit	Same value as sent by SS in <i>LoggedMeasurementConfiguration</i> in step 1		
mnc SEQUENCE (SIZE (2..3)) OF MCC-NMC-Digit	Same value as sent by SS in <i>LoggedMeasurementConfiguration</i> in step 1		
}			
traceId-r10	Same value as sent by SS in <i>LoggedMeasurementConfiguration</i> in step 1		
}			
traceRecordingSessionRef-r10	Same value as sent by SS in <i>LoggedMeasurementConfiguration</i> in step 1		
tce-Id-r10	Same value as sent by SS in <i>LoggedMeasurementConfiguration</i> in step 1		
logMeasInfoList-r10 SEQUENCE (SIZE (1..maxLogMeasReport-r10)) OF SEQUENCE {			
locationInfo-r10[x]	Not checked		
relativeTimeStamp-r10 [x]	SS record the value		
servCellIdentity-r10 [x]	Same as Cell 1		
measResultServCell-r10 [x] SEQUENCE {			
rsrpResult-r10	(0..97)		
rsrqResult-r10	(0..34)		
}			
measResultNeighCells-r10 [x] SEQUENCE {			
measResultListEUTRAN-r10	Not present		
measResultListUTRAN-r10	Not present		
measResultListGERAN-r10 SEQUENCE (SIZE (1..maxFreq)) OF SEQUENCE {	1 entry		
carrierFreq-r9[1]	Same as Cell 24		
physCellId [1]	Same as Cell 24		
cgi-Info [1]	Not checked		
measResult [1] SEQUENCE {			
rsi	(0..63)		
}			
}			
measResultListCDMA2000-r10	Not present		
}			
logMeasAvailable-r10	Not present		
}			
nonCriticalExtension SEQUENCE {	Not checked		
}			
}			
}			
}			
}			
}			

8.6.3.3 Logged MDT / CDMA2000 Inter-RAT measurement, logging and reporting

8.6.3.3.1 Test Purpose (TP)

(1)

```
with { UE in E-UTRA RRC_IDLE state camping normally on an E-UTRA cell where logged measurement is
configured without areaConfiguration and the UE is able to detect a CDMA2000 cell }
ensure that {
  when { T330 is running }
  then { UE is logging serving cell idle mode measurements and CDMA2000 neighbouring cell
measurements }
}
```

(2)

```
with { UE in E-UTRA RRC_CONNECTED state and UE has logged CDMA2000 neighbouring cell measurements
available for E-UTRA and plmn-Identity stored in VarLogMeasReport is equal to the RPLMN }
ensure that {
  when { receiving UEInformationRequest message }
  then { UE transmits UEInformationResponse messages with a logMeasReport with Inter-RAT
neighbouring cell measurements }
}
```

8.6.3.3.2 Conformance requirements

References: The conformance requirements covered in the current TC are specified in: TS 34.304, clause 8; TS 36.331, clauses 5.6.6.3, 5.6.8.2, 5.6.5.3 and 6.2.2.

[TS 36.304, clause 8 (TP1)]

The UE may be configured to perform logging of measurement results in RRC_IDLE mode with the *LoggedMeasurementsConfiguration* message as specified in TS 36.331 [3]. This configuration is valid while the logging duration timer is running.

If the configuration of logged measurements is valid, the UE shall perform logging of measurement results if all of the following conditions are met:

- The UE is in *camped normally* state in RRC_IDLE mode;
- RPLMN of the UE is the same as the RPLMN at the point of time of *LoggedMeasurementConfiguration* message reception;
- The UE is camped on a cell belonging to the *areaConfiguration* (see TS 36.331 [3]), if configured;
- The UE is camped on the RAT where the logged measurement configuration was received.

Otherwise, the logging of measurement results shall be suspended.

NOTE 1: Even if logging of measurement results is suspended, the logging duration timer and time stamp will continue, and the logged measurement configuration and corresponding log are kept.

[TS 36.331, clause 5.6.5.3 (TP2)]

Upon receiving the *UEInformationRequest* message, the UE shall

...

- 1> if the *logMeasReportReq* is present and the *plmn-Identity* stored in *VarLogMeasReport* is equal to the RPLMN:
- 2> if *VarLogMeasReport* includes one or more logged measurement entries, set the contents of the *logMeasReport* in the *UEInformationResponse* message as follows:
 - 3> include the *absoluteTimeStamp* and set it to the value of *absoluteTimeInfo* in the *VarLogMeasReport*;
 - 3> include the *traceReference* and set it to the value of *traceReference* in the *VarLogMeasReport*;
 - 3> include the *traceRecordingSessionRef* and set it to the value of *traceRecordingSessionRef* in the *VarLogMeasReport*;

- 3> include the *tce-Id* and set it to the value of *tce-Id* in the *VarLogMeasReport*;
- 3> include the *logMeasInfoList* and set it to include one or more entries from *VarLogMeasReport* starting from the entries logged first;
- 3> if the *VarLogMeasReport* includes one or more additional logged measurement entries that are not included in the *logMeasInfoList* within the *UEInformationResponse* message:
 - 4> include the *logMeasAvailable*;
- 1> if the *logMeasReport* is included in the *UEInformationResponse*:
 - 2> submit the *UEInformationResponse* message to lower layers for transmission via SRB2;
 - 2> discard the logged measurement entries included in the *logMeasInfoList* from *VarLogMeasReport* upon successful delivery of the *UEInformationResponse* message confirmed by lower layers;
- 1> else:
 - 2> submit the *UEInformationResponse* message to lower layers for transmission via SRB1;

[TS 36.331, clause 5.6.6.3 (TP1)]

Upon receiving the *LoggedMeasurementConfiguration* message the UE shall:

- 1> discard the logged measurement configuration as well as the logged measurement information as specified in 5.6.7;
- 1> store the received *loggingDuration*, *loggingInterval* and *areaConfiguration*, if included, in *VarLogMeasConfig*;
- 1> store the RPLMN as *plmn-Identity* in *VarLogMeasReport*;
- 1> store the received *absoluteTimeInfo*, *traceReference*, *traceRecordingSessionRef* and *tce-Id* in *VarLogMeasReport*;
- 1> start timer T330 with the timer value set to the *loggingDuration*;

[TS 36.331, clause 5.6.8.2 (TP1)]

While T330 is running, the UE shall:

- 1> perform the logging in accordance with the following:
 - 2> if the UE is camping normally on an E-UTRA cell and the RPLMN of the UE is the same as the *plmn-Identity* stored in *VarLogMeasReport* and, if the cell is part of the area indicated by *areaConfiguration* if configured in *VarLogMeasConfig*:
 - 3> perform the logging at regular time intervals, as defined by the *loggingInterval* in *VarLogMeasConfig*;
 - 2> when adding a logged measurement entry in *VarLogMeasReport*, include the fields in accordance with the following:
 - 3> set the *relativeTimeStamp* to indicate the elapsed time since the moment at which the logged measurement configuration was received;
 - 3> if detailed location information became available during the last logging interval, set the content of the *locationInfo* as follows:
 - 4> include the *locationCoordinates*;
 - 3> set the *servCellIdentity* to indicate global cell identity of the cell the UE is camping on;
 - 3> set the *measResultServCell* to include the quantities of the cell the UE is camping on;
 - 3> if available, set the *measResultNeighCells*, in order of decreasing ranking-criterion as used for cell re-selection, to include neighbouring cell measurements that became available during the last logging interval for at most the following number of neighbouring cells; 6 intra-frequency and 3 inter-frequency

neighbours per frequency as well as 3 inter-RAT neighbours, per frequency/ set of frequencies (GERAN) per RAT;

NOTE 3: The UE includes the latest results of the available measurements as used for cell reselection evaluation, which are performed in accordance with the performance requirements as specified in TS 36.133 [16].

- 2> when the memory reserved for the logged measurement information becomes full, stop timer T330 and perform the same actions as performed upon expiry of T330, as specified in 5.6.6.4;

[TS 36.331, clause 6.2.2 (TP1)]

- LoggedMeasurementConfiguration

The *LoggedMeasurementConfiguration* message is used by E-UTRAN to configure the UE to perform logging of measurement results while in RRC_IDLE. It is used to transfer the logged measurement configuration for network performance optimisation, see TS 37.320 [60].

Signalling radio bearer: SRB1

RLC-SAP: AM

Logical channel: DCCH

Direction: E-UTRAN to UE

Table 8.6.3.3.2-1: LoggedMeasurementConfiguration message

```
-- ASN1START
LoggedMeasurementConfiguration-r10 ::= SEQUENCE {
    criticalExtensions          CHOICE {
        c1                     CHOICE {
            loggedMeasurementConfiguration-r10 LoggedMeasurementConfiguration-r10-IEs,
            spare3 NULL, spare2 NULL, spare1 NULL
        },
        criticalExtensionsFuture SEQUENCE {}
    }
}

LoggedMeasurementConfiguration-r10-IEs ::= SEQUENCE {
    traceReference-r10          TraceReference-r10,
    traceRecordingSessionRef-r10 OCTET STRING (SIZE (2)),
    tce-Id-r10                  OCTET STRING (SIZE (1)),
    absoluteTimeInfo-r10       AbsoluteTimeInfo-r10,
    areaConfiguration-r10      AreaConfiguration-r10          OPTIONAL, -- Need OR
    loggingDuration-r10        LoggingDuration-r10,
    loggingInterval-r10        LoggingInterval-r10,
    nonCriticalExtension        SEQUENCE {}                  OPTIONAL -- Need OP
}
-- ASN1STOP
```

LoggedMeasurementConfiguration field descriptions	
<i>absoluteTimeInfo</i>	Indicates the absolute time in the current cell.
<i>tce-Id</i>	Parameter Trace Collection Entity Id: See TS 32.422 [58].
<i>traceRecordingSessionRef</i>	Parameter Trace Recording Session Reference: See TS 32.422 [58]

And the procedure ends.

8.6.3.3.3 Test description

8.6.3.3.3.1 Pre-test conditions

System Simulator:

- Cell 1, Cell 15
- Cell power levels are selected according to [18] so that camping on Cell 1 is guaranteed
- System information combination 6 as defined in TS 36.508 [18] clause 4.4.3.1 is used in E-UTRA cells with content of CDMA2000 HRPD carrier frequency list in SIB8 set as defined in TS 36.508 [18] table 6.3.1.5-1.

Preamble:

- The UE is in state Generic RB Established (state 3) according to [18] on Cell 1.

8.6.3.3.3.2 Test procedure sequence

Table 8.6.3.3.3.2-1 illustrates the downlink power levels and other changing parameters to be applied for the cells at various time instants of the test execution. The configuration marked "T1" is applied at the point indicated in the Main behaviour description in Table 8.6.3.3.3.2-2.

Table 8.6.3.3.3.2-1: Time instances of cell power level and parameter changes

	Parameter	Unit	Cell 1	Cell 15	Remark
T1	Cell-specific RS EPRE	dBm/15kHz	-60	-	The power level values are such that entering conditions for event B2 are not satisfied: Inequality B2-1 (Entering condition 1) $Ms + Hys > Thresh1$ Inequality B2-2 (Entering condition 2) $Mn + Ofn - Hys < Thresh2$
	$\bar{I}_{or/loc}$	dB	-	-20	
	\bar{I}_{oc}	dBm/1.23MHz	-	-55	
	Pilot_Ec/Io (Note 1)	dB	-	-20	
	$\bar{I}_{or/loc}$	dB	-	-5	
	\bar{I}_{oc}	dBm/1.23MHz	-	-55	
	Pilot_Ec/Io (Note 1)	dB	-	-6	
Note 1: This parameter is not directly settable, but is derived by calculation from the other parameters set by the SS					

Table 8.6.3.3.3.2-2: Main behaviour

St	Procedure	Message Sequence		TP	Verdict
		U - S	Message		
1	The SS transmits a <i>LoggedMeasurementConfiguration</i> message including to configure the UE how to perform logging of measurement results while in RRC_IDLE.	<--	<i>LoggedMeasurementConfiguration</i>	-	-
2	The SS transmits an <i>RRCConnectionRelease</i> message.	<--	<i>RRCConnectionRelease</i>	-	-
3	Wait 5s to allow UE to activate logging	-	-	-	-
4	The SS changes Cell 1 and Cell 15 levels according to the row "T1" in table 8.6.3.3.3.2-1.	-	-	-	-
5	The SS transmits a RRC CONNECTION SETUP message.	<--	RRC CONNECTION SETUP	-	-
6	The UE include the IE "Logged Meas Available" in the RRC CONNECTION SETUP COMPLETE message.	-->	RRC CONNECTION SETUP COMPLETE	-	-
7	The SS transmits a <i>UEInformationRequest</i> message on Cell 1.	<--	<i>UEInformationRequest</i>	-	-
8	Check: Does the UE transmit a <i>UEInformationResponse</i> message with a <i>LogMeasInfoList</i> with at least one inter-RAT neighbouring cell measurement of Cell 1.	-->	<i>UEInformationResponse</i>	1,2	P

8.6.3.3.3.3 Specific message contents

Table 8.6.3.3.3.3-3: LoggedMeasurementConfiguration (step 1, Table 8.6.3.3.3.2-2)

Derivation path: 36.508 clause 4.6.1 table 4.6.1-4.0A <i>LoggedMeasurementConfiguration</i>			
Information Element	Value/remark	Comment	Condition
LoggedMeasurementConfiguration-r10 ::= SEQUENCE {			
criticalExtensions CHOICE {			
C1 CHOICE {			
loggedMeasurementConfiguration-r10			
SEQUENCE {			
loggingInterval-r10	ms2560	2.56 seconds	
}			
}			
}			
}			

Table 8.6.3.3.3.3-4: UEInformationRequest (step 7, Table 8.6.3.3.3.2-2)

Derivation Path: 36.508 clause 4.6.1 table 4.6.1-23A <i>UEInformationRequest</i> , condition "Logged MDT"

Table 8.6.3.3.3.3-5: UEInformationResponse (step 8, Table 8.6.3.3.3.2-2)

Derivation Path: 36.508 clause 4.6.1 table 4.6.1-23B <i>UEInformationResponse</i>			
Information Element	Value/remark	Comment	Condition
UEInformationResponse-r9 ::= SEQUENCE {			
criticalExtensions CHOICE {			
c1 CHOICE {			
ueInformationResponse-r9 SEQUENCE {			
nonCriticalExtension SEQUENCE {			
lateNonCriticalExtension	Not checked		
nonCriticalExtension SEQUENCE {			
logMeasReport-r10 SEQUENCE {			
absoluteTimeStamp-r10	Same value as sent by SS in <i>LoggedMeasurementConfiguration</i> in step 1		

traceReference-r10SEQUENCE {			
plmn-identity-r10 SEQUENCE {			
mcc SEQUENCE (SIZE (3)) OF MCC-NMC-Digit	Same value as sent by SS in <i>LoggedMeasurementConfiguration</i> in step 1		
mnc SEQUENCE (SIZE (2..3)) OF MCC-NMC-Digit	Same value as sent by SS in <i>LoggedMeasurementConfiguration</i> in step 1		
}			
traceld-r10	Same value as sent by SS in <i>LoggedMeasurementConfiguration</i> in step 1		
}			
traceRecordingSessionRef-r10	Same value as sent by SS in <i>LoggedMeasurementConfiguration</i> in step 1		
tce-ld-r10	Same value as sent by SS in <i>LoggedMeasurementConfiguration</i> in step 1		
logMeasInfoList-r10 SEQUENCE (SIZE (1..maxLogMeasReport-r10)) OF SEQUENCE {			
locationInfo-r10[x]	Not checked		
relativeTimeStamp-r10 [x]	SS record the value		
servCellIdentity-r10 [x]	Same as Cell 1		
measResultServCell-r10 [x] SEQUENCE {			
rsrpResult-r10	(0..97)		
rsrqResult-r10	(0..34)		
}			
measResultNeighCells-r10 [x] SEQUENCE {			
measResultListEUTRA-r10	Not present		
measResultListUTRA-r10	Not present		
measResultListGERAN-r10	Not present		
measResultListCDMA2000 SEQUENCE (SIZE (1..maxCellReport)) OF SEQUENCE {	1 entry if available		
physCellId[1]	PhysicalCellIdentity of Cell 15 if available		
cgi-Info[1] CHOICE {			
cellGlobalIdHRPD	cellGlobalId of Cell 15 if available		
}			
measResult[1] SEQUENCE {			
pilotStrength	(0..63) if available		
}			
}			
logMeasAvailable-r10	Not present		
}			
nonCriticalExtension SEQUENCE {	Not checked		
}			
}			
}			
}			
physCellId	PhysicalCellIdentity of Cell 1		
shortMAC-I	The same value as the 16 least significant bits of the XMAC-I value		

	calculated by SS		
}			
reestablishmentCause	otherFailure		
}			
}			
}			

8.6.3.4 Logged MDT / Logging and reporting / Reporting at UTRAN Inter-RAT handover / PLMN list

8.6.3.4.1 Test Purpose (TP)

(1)

```
with { UE in E-UTRA RRC_IDLE state camping normally on an E-UTRA cell where logged measurement is
configured with the RPLMN included in plmn-IdentityList and the UE is able to detect a UTRA cell }
ensure that {
  when { T330 is running }
  then { UE is logging serving cell idle mode measurements and UTRA neighbouring cell measurements
}
}
```

(2)

```
with { UE in UTRA RRC_CONNECTED state and UE has logged E-UTRA measurements and UTRA neighbouring
cell measurements available from earlier measurements performed while in E-UTRA }
ensure that {
  when { UE handovers from UTRA to E-UTRA cell successfully and T330 is running and the current
RPLMN is included in plmn-IdentityList stored in VarLogMeasReport }
  then { UE sends the RRCConnectionReconfigurationComplete message with logMeasAvailable IE set to
true }
}
```

(3)

```
with { UE in E-UTRA RRC_CONNECTED state and has logged measurements available for E-UTRA and the
RPLMN is included in plmn-IdentityList stored in VarLogMeasReport }
ensure that {
  when { UE receives UEInformationRequest message with logMeasReportReq present }
  then { UE transmits UEInformationResponse messages with logMeasReport included }
}
```

8.6.3.4.2 Conformance requirements

References: The conformance requirements covered in the current TC are specified in: TS 34.304, clause 8; TS 36.331, clauses 5.4.2.3, 5.6.5.3, 5.6.6.3, 5.6.8.2, 6.2.2. Unless otherwise stated these are Rel-11 requirements.

[TS 36.304, clause 8 (TP1, TP2)]

The UE may be configured to perform logging of measurement results in RRC_IDLE mode with the *LoggedMeasurementsConfiguration* message as specified in TS 36.331 [3]. This configuration is valid while the logging duration timer is running.

If the configuration of logged measurements is valid, the UE shall perform logging of measurement results if all of the following conditions are met:

- The UE is in *camped normally* state in RRC_IDLE mode;
- RPLMN of the UE is the same as the RPLMN at the point of time of *LoggedMeasurementConfiguration* message reception, or is present in the *plmn-IdentityList* (see TS 36.331 [3]) if configured;
- The UE is camped on a cell belonging to the *areaConfiguration* (see TS 36.331 [3]), if configured;
- The UE is camped on the RAT where the logged measurement configuration was received.

Otherwise, the logging of measurement results shall be suspended.

NOTE 1: Even if logging of measurement results is suspended, the logging duration timer and time stamp will continue, and the logged measurement configuration and corresponding log are kept.

[TS 36.331, clause 5.4.2.3 (TP2)]

The UE shall:

...

1> set the content of *RRCCONNECTIONRECONFIGURATIONCOMPLETE* message as follows:

...

2> if the UE has radio link failure or handover failure information available in *VarRLF-Report* and if the RPLMN is included in *plmn-IdentityList* stored in *VarRLF-Report*:

3> include *rlf-InfoAvailable*;

2> if the UE has logged measurements available for E-UTRA and if the RPLMN is included in *plmn-IdentityList* stored in *VarLogMeasReport*:

3> include the *logMeasAvailable*;

2> if the UE has connection establishment failure information available in *VarConnEstFailReport* and if the RPLMN is equal to *plmn-Identity* stored in *VarConnEstFailReport*:

3> include *connEstFailInfoAvailable*;

1> submit the *RRCCONNECTIONRECONFIGURATIONCOMPLETE* message to lower layers for transmission using the new configuration;

...

2> enter E-UTRA RRC_CONNECTED, upon which the procedure ends;

NOTE 2: The UE is not required to determine the SFN of the target PCell by acquiring system information from that cell before performing RACH access in the target PCell.

[TS 36.331, clause 5.6.6.3 (TP1)]

Upon receiving the *LOGGEDMEASUREMENTCONFIGURATION* message the UE shall:

1> discard the logged measurement configuration as well as the logged measurement information as specified in 5.6.7;

1> store the received *loggingDuration*, *loggingInterval* and *areaConfiguration*, if included, in *VarLogMeasConfig*;

1> if the *LOGGEDMEASUREMENTCONFIGURATION* message includes *plmn-IdentityList*:

2> set *plmn-IdentityList* in *VarLogMeasReport* to include the RPLMN as well as the PLMNs included in *plmn-IdentityList*;

1> else:

2> set *plmn-IdentityList* in *VarLogMeasReport* to include the RPLMN;

1> store the received *absoluteTimeInfo*, *traceReference*, *traceRecordingSessionRef* and *tce-Id* in *VarLogMeasReport*;

1> start timer T330 with the timer value set to the *loggingDuration*;

[TS 36.331, clause 5.6.8.2 (TP1)]

While T330 is running, the UE shall:

1> perform the logging in accordance with the following:

- 2> if the UE is camping normally on an E-UTRA cell and if the RPLMN is included in *plmn-IdentityList* stored in *VarLogMeasReport* and, if the cell is part of the area indicated by *areaConfiguration* if configured in *VarLogMeasConfig*:
 - 3> perform the logging at regular time intervals, as defined by the *loggingInterval* in *VarLogMeasConfig*;
- 2> when adding a logged measurement entry in *VarLogMeasReport*, include the fields in accordance with the following:
 - 3> set the *relativeTimeStamp* to indicate the elapsed time since the moment at which the logged measurement configuration was received;
 - 3> if detailed location information became available during the last logging interval, set the content of the *locationInfo* as follows:
 - 4> include the *locationCoordinates*;
 - 3> set the *servCellIdentity* to indicate global cell identity of the cell the UE is camping on;
 - 3> set the *measResultServCell* to include the quantities of the cell the UE is camping on;
 - 3> if available, set the *measResultNeighCells*, in order of decreasing ranking-criterion as used for cell reselection, to include neighbouring cell measurements that became available during the last logging interval for at most the following number of neighbouring cells; 6 intra-frequency and 3 inter-frequency neighbours per frequency as well as 3 inter-RAT neighbours, per frequency/ set of frequencies (GERAN) per RAT and according to the following:
 - 4> for each neighbour cell included, include the optional fields that are available;

NOTE: The UE includes the latest results of the available measurements as used for cell reselection evaluation, which are performed in accordance with the performance requirements as specified in TS 36.133 [16].

- 2> when the memory reserved for the logged measurement information becomes full, stop timer T330 and perform the same actions as performed upon expiry of T330, as specified in 5.6.6.4;

[TS 36.331, clause 5.6.5.3 (TP3)]

Upon receiving the *UEInformationRequest* message, the UE shall

...

- 1> if the *logMeasReportReq* is present and if the RPLMN is included in *plmn-IdentityList* stored in *VarLogMeasReport*:
 - 2> if *VarLogMeasReport* includes one or more logged measurement entries, set the contents of the *logMeasReport* in the *UEInformationResponse* message as follows:
 - 3> include the *absoluteTimeStamp* and set it to the value of *absoluteTimeInfo* in the *VarLogMeasReport*;
 - 3> include the *traceReference* and set it to the value of *traceReference* in the *VarLogMeasReport*;
 - 3> include the *traceRecordingSessionRef* and set it to the value of *traceRecordingSessionRef* in the *VarLogMeasReport*;
 - 3> include the *tce-Id* and set it to the value of *tce-Id* in the *VarLogMeasReport*;
 - 3> include the *logMeasInfoList* and set it to include one or more entries from *VarLogMeasReport* starting from the entries logged first;
 - 3> if the *VarLogMeasReport* includes one or more additional logged measurement entries that are not included in the *logMeasInfoList* within the *UEInformationResponse* message:
 - 4> include the *logMeasAvailable*;
- 1> if the *logMeasReport* is included in the *UEInformationResponse*:
 - 2> submit the *UEInformationResponse* message to lower layers for transmission via SRB2;

2> discard the logged measurement entries included in the *logMeasInfoList* from *VarLogMeasReport* upon successful delivery of the *UEInformationResponse* message confirmed by lower layers;

1> else:

2> submit the *UEInformationResponse* message to lower layers for transmission via SRB1;

[TS 36.331, clause 6.2.2 (TP1)]

- LoggedMeasurementConfiguration

The *LoggedMeasurementConfiguration* message is used by E-UTRAN to configure the UE to perform logging of measurement results while in RRC_IDLE. It is used to transfer the logged measurement configuration for network performance optimisation, see TS 37.320 [60].

Signalling radio bearer: SRB1

RLC-SAP: AM

Logical channel: DCCH

Direction: E-UTRAN to UE

LoggedMeasurementConfiguration message

```
-- ASN1START
LoggedMeasurementConfiguration-r10 ::= SEQUENCE {
    criticalExtensions          CHOICE {
        c1                      CHOICE {
            loggedMeasurementConfiguration-r10
            spare3 NULL, spare2 NULL, spare1 NULL
        },
        criticalExtensionsFuture SEQUENCE {}
    }
}

LoggedMeasurementConfiguration-r10-IEs ::= SEQUENCE {
    traceReference-r10          TraceReference-r10,
    traceRecordingSessionRef-r10 OCTET STRING (SIZE (2)),
    tce-Id-r10                  OCTET STRING (SIZE (1)),
    absoluteTimeInfo-r10       AbsoluteTimeInfo-r10,
    areaConfiguration-r10      AreaConfiguration-r10          OPTIONAL,    -- Need OR
    loggingDuration-r10        LoggingDuration-r10,
    loggingInterval-r10        LoggingInterval-r10,
    nonCriticalExtension        LoggedMeasurementConfiguration-v1080-IEs OPTIONAL -- Need
OP
}

LoggedMeasurementConfiguration-v1080-IEs ::= SEQUENCE {
    lateNonCriticalExtension-r10 OCTET STRING          OPTIONAL,    -- Need OP
    nonCriticalExtension         LoggedMeasurementConfiguration-v1130-IEs OPTIONAL -- Need
OP
}

LoggedMeasurementConfiguration-v1130-IEs ::= SEQUENCE {
    plmn-IdentityList-r11       PLMN-IdentityList3-r11    OPTIONAL,    -- Need OR
    areaConfiguration-v1130     AreaConfiguration-v1130    OPTIONAL,    -- Need OR
    nonCriticalExtension         SEQUENCE {}                OPTIONAL    -- Need OP
}
-- ASN1STOP
```

LoggedMeasurementConfiguration field descriptions
absoluteTimeInfo Indicates the absolute time in the current cell.
areaConfiguration Used to restrict the area in which the UE performs measurement logging to cells broadcasting either one of the included cell identities or one of the included tracking area codes/ identities.
plmn-IdentityList Indicates a set of PLMNs defining when the UE performs measurement logging as well as the associated status indication and information retrieval i.e. the UE performs these actions when the RPLMN is part of this set of PLMNs.
tce-Id Parameter Trace Collection Entity Id: See TS 32.422 [58].
traceRecordingSessionRef Parameter Trace Recording Session Reference: See TS 32.422 [58]

8.6.3.4.3 Test description

8.6.3.4.3.1 Pre-test conditions

System Simulator:

- Cell 1, Cell 5 and Cell 12 - Cell 1 and Cell 12 are E-UTRAN cell, Cell 5 is a UTRA cell.
- Cell power levels are selected according to [18] so that camping on Cell 1 is guaranteed
- System information combination 4 as defined in TS 36.508 [18] clause 4.4.3.1 is used in E-UTRA cells with content of UTRA carrier frequency list in SIB6 set as defined in TS 36.508 [18] table 6.3.1.3-1.
- The PLMNs are identified in the test by the identifiers in Table 8.6.3.4.3.1-1.

Table 8.6.3.4.3.1-1: PLMN identifiers

Cell	PLMN name
1	PLMN1
12	PLMN2

Preamble:

- The UE is registered on PLMN1 (Cell 1) using the procedure described in TS 36.508[18] clause 4.5.2.3 except that the ATTACH ACCEPT message indicates PLMN2 in the Equivalent PLMN list as described in Table 8.6.3.4.3.3-7
- The UE is in state Generic RB Established (state 3) according to [18] on Cell 1.

8.6.3.4.3.2 Test procedure sequence

Table 8.6.3.4.3.2-1 illustrates the downlink power levels and other changing parameters to be applied for the cells at various time instants of the test execution. The configuration marked "T1" and "T2" are applied at the point indicated in the Main behaviour description in Table 8.6.3.4.3.2-2.

Table 8.6.3.4.3.2-1: Time instances of cell power level and parameter changes

	Parameter	Unit	Cell 1	Cell 12	Cell 5	Remark
T1	Cell-specific RS EPRE	dBm/15kHz	-85	"Off"	-	S _{nonServingCell, Cell5} > Thresh Cell5 _{high}
	CPICH Ec (UTRA FDD)	dBm/3.84MHz	-	-	-65	
	PCCPCH Ec (UTRA LCR TDD)	dBm/1.28 MHz	-	-	-67	
T2	Cell-specific RS EPRE	dBm/15kHz	-85	-70	-	The power level values are such that entering conditions for event 3a are satisfied.
	CPICH Ec (UTRA FDD)	dBm/3.84MHz	-	-	-100	
	PCCPCH Ec (UTRA LCR TDD)	dBm/1.28 MHz	-	-	-100	
NOTE 1: Power level "Off" for E-UTRA cell is defined in TS 36.508 Table 6.2.2.1-1.						

Table 8.6.3.4.3.2-2: Main behaviour

St	Procedure	Message Sequence		TP	Verdict
		U - S	Message		
1	The SS transmits a <i>LoggedMeasurementConfiguration</i> message to configure the UE to perform logging of measurement results while in E-UTRA RRC_IDLE.	<--	<i>LoggedMeasurementConfiguration</i>	-	-
2	The SS transmits an <i>RRCConnectionRelease</i> message.	<--	<i>RRCConnectionRelease</i>	-	-
3	Wait 5s to allow UE to activate logging	-	-	-	-
4	The SS changes Cell 1 and Cell 5 levels according to the row "T1" in table 8.6.3.4.3.2-1. (Note 1)	-	-	-	-
5	Generic test procedure in TS 36.508 subclause 6.4.2.8 is performed on Cell 5. NOTE: The UE performs an RAU procedure and the RRC connection is released.	-	-	-	-
6-10	Step 7 to 11 of test procedure in TS 34.123-1 subclause 12.9.14.4 is performed on Cell 5 using the UTRA reference radio bearer parameters and combination "UTRA PS RB" according to TS 36.508 subclause 4.8.3 and Table 4.8.3-1. NOTE: The UE performs Network initiated RAB re-establishment in a UTRAN cell.	-	-	-	-
-	For UTRAN FDD, EXCEPTION: Steps 11a1 to 11a2 describe behaviour that depends on the UE capability; the "lower case letter" identifies a step sequence that takes place if a capability is supported. For UTRAN TDD, goto step 12.	-	-	-	-
11a1	IF <i>pc_UTRA_CompressedModeRequired</i> THEN the SS transmits a PHYSICAL CHANNEL RECONFIGURATION message on Cell 5 including the DPCH compressed mode info.	<--	PHYSICAL CHANNEL RECONFIGURATION	-	-
11a2	The UE transmits a PHYSICAL CHANNEL RECONFIGURATION COMPLETE message on Cell 5.	-->	PHYSICAL CHANNEL RECONFIGURATION COMPLETE	-	-
12	The SS transmits a MEASUREMENT CONTROL message to setup inter-RAT measurement on Cell 5.	<--	MEASUREMENT CONTROL	-	-
13	The SS changes Cell 12 and Cell 5 levels according to the row "T2" in table 8.6.3.4.3.2-1.	-	-	-	-
14	The UE transmits a MEASUREMENT REPORT message on Cell 5 including the E-UTRA event results.	-->	MEASUREMENT REPORT	-	-
15	The SS transmits a HANDOVER FROM UTRAN COMMAND message on Cell 5.	<--	HANDOVER FROM UTRAN COMMAND	-	-
16	Check: Does the UE transmit an <i>RRCConnectionReconfigurationComplete</i> message with the IE <i>logMeasAvailable</i> set to true on Cell 12?	-->	<i>RRCConnectionReconfigurationComplete</i>	2	P
17	The UE transmits a TRACKING AREA UPDATE REQUEST message on Cell 12.	-	-	-	-
18	SS responds with a TRACKING AREA UPDATE ACCEPT message. NOTE: The TAU is accepted with PLMN1 listed as an Equivalent PLMN	-	-	-	-
19	The UE transmits a TRACKING AREA UPDATE COMPLETE message.	-	-	-	-
20	The SS transmits a <i>UEInformationRequest</i> message on Cell 12 with <i>logMeasReportReq</i> present.	<--	<i>UEInformationRequest</i>	-	-

21	Check: Does the UE transmit a <i>UEInformationResponse</i> message with <i>logMeasReport</i> included?	-->	<i>UEInformationResponse</i>	1, 3	P
----	--	-----	------------------------------	------	---

Note 1: The change of power levels is to trigger an inter-RAT cell re-selection procedure to make sure that the UE is logging inter-RAT neighbouring cell measurements (logging interval=2.56 seconds) of Cell 5 while t-ReselectionUTRA timer is running (7 seconds).

8.6.3.4.3.3 Specific message contents

Table 8.6.3.4.3.3-1: SystemInformationBlockType6 for Cell 1 (preamble, 8.6.3.4.3.2-2)

Derivation Path: 36.508 table 4.4.3.3-5			
Information Element	Value/remark	Comment	Condition
SystemInformationBlockType6 ::= SEQUENCE {			
carrierFreqListUTRA-FDD SEQUENCE (SIZE (1..maxUTRA-FDD-Carrier)) OF SEQUENCE {			UTRA-FDD
carrierFreq[n]	Downlink UARFCN of Cell 5		
cellReselectionPriority[n]	5		
t-ReselectionUTRA	7		
}			
carrierFreqListUTRA-TDD SEQUENCE (SIZE (1..maxUTRA-TDD-Carrier)) OF SEQUENCE {			UTRA-TDD
carrierFreq[n]	Downlink UARFCN of Cell 5		
cellReselectionPriority[n]	5		
t-ReselectionUTRA	7		
}			
}			

Condition	Explanation
UTRA-FDD	UTRA FDD cell environment
UTRA-TDD	UTRA TDD cell environment

Table 8.6.3.4.3.3-2: System Information Block type 19 for Cell 5 (preamble, Table 8.6.3.4.3.2-2)

Derivation Path: 36.508 table 4.4.4.1-1			
Information Element	Value/remark	Comment	Condition
SysInfoType19 ::= SEQUENCE {			
utra-PriorityInfoList ::= SEQUENCE {			
utra-ServingCell ::= SEQUENCE {			
priority	5		
}			
}			
}			

Table 8.6.3.4.3.3-3: *LoggedMeasurementConfiguration* (step 1, Table 8.6.3.4.3.2-2)

Derivation Path: 36.508, Table 4.6.1-4.0A			
Information Element	Value/remark	Comment	Condition
LoggedMeasurementConfiguration-r10 ::= SEQUENCE {			
criticalExtensions CHOICE {			
c1 CHOICE {			
loggedMeasurementConfiguration-r10 SEQUENCE {			
loggingInterval-r10			
nonCriticalExtension SEQUENCE {	ms2560	2.56 seconds	
lateNonCriticalExtension	Not present		
nonCriticalExtension SEQUENCE {			
plmn-IdentityList-r11 SEQUENCE (SIZE (1..16)) OF {			
PLMN-Identity [1]	PLMN1		
PLMN-Identity [2]	PLMN2		
}			
nonCriticalExtension	Not present		
}			
}			
}			
}			

Table 8.6.3.4.3.3-4: *RRCConnectionReconfigurationComplete* (step 16, Table 8.6.3.4.3.2-2)

Derivation path: 36.508 clause 4.6.1 table 4.6.1-9 <i>RRCConnectionReconfigurationComplete</i>			
Information Element	Value/remark	Comment	Condition
RRCConnectionReconfigurationComplete ::= SEQUENCE {			
criticalExtensions CHOICE {			
c1 CHOICE {			
rrcConnectionReconfigurationComplete-r8 SEQUENCE {			
nonCriticalExtension SEQUENCE {	Not checked		
nonCritriticalExtension SEQUENCE {	Not checked		
rlf-InfoAvailable-r10	Not checked		
logMeasAvailable-r10	true		
nonCriticalExtension SEQUENCE {}	Not checked		
}			
}			
}			
}			

Table 8.6.3.4.3.3-5: *UEInformationRequest* (step 20, Table 8.6.3.4.3.2-2)

Derivation Path: 36.508 clause 4.6.1 table 4.6.1-23A <i>UEInformationRequest</i> , condition "Logged MDT"

Table 8.6.3.4.3-6: *UEInformationResponse* (step 21, Table 8.6.3.4.3.2-2)

Derivation Path: 36.508 clause 4.6.1 table 4.6.1-23B <i>UEInformationResponse</i>			
Information Element	Value/remark	Comment	Condition
<i>UEInformationResponse</i> -r9 ::= SEQUENCE {			
<i>criticalExtensions</i> CHOICE {			
c1 CHOICE{			
<i>ueInformationResponse</i> -r9 SEQUENCE {			
<i>nonCriticalExtension</i> SEQUENCE {			
<i>lateNonCriticalExtension</i>	Not checked		
<i>nonCriticalExtension</i> SEQUENCE {			
<i>logMeasReport</i> -r10 SEQUENCE {			
<i>absoluteTimeStamp</i> -r10	Same value as sent by SS in <i>LoggedMeasurementCon- figuration</i> in step 1		

traceReference-r10SEQUENCE {			
plmn-identity-r10 SEQUENCE {			
mcc SEQUENCE (SIZE (3)) OF MCC-NMC-Digit	Same value as sent by SS in <i>LoggedMeasurementConfiguration</i> in step 1		
mnc SEQUENCE (SIZE (2..3)) OF MCC-NMC-Digit	Same value as sent by SS in <i>LoggedMeasurementConfiguration</i> in step 1		
}			
traceId-r10	Same value as sent by SS in <i>LoggedMeasurementConfiguration</i> in step 1		
}			
traceRecordingSessionRef-r10	Same value as sent by SS in <i>LoggedMeasurementConfiguration</i> in step 1		
tce-Id-r10	Same value as sent by SS in <i>LoggedMeasurementConfiguration</i> in step 1		
logMeasInfoList-r10 SEQUENCE (SIZE (1..maxLogMeasReport-r10)) OF SEQUENCE {			
locationInfo-r10[x]	Not checked		
relativeTimeStamp-r10 [x]	SS record the value		
servCellIdentity-r10 [x]	Same as Cell 1		
measResultServCell-r10 [x] SEQUENCE {			
rsrpResult-r10	(0..97)		
rsrqResult-r10	(0..34)		
}			
measResultNeighCells-r10 [x] SEQUENCE {			
measResultListEUTRA-r10	Not present		
measResultListUTRA-r10 SEQUENCE (SIZE (1..maxFreq)) OF SEQUENCE {	1 entry		
carrierFreq-r9[1]	Same as Cell 5		
measResultList-r9[1] SEQUENCE (SIZE (1..maxCellReport)) OF SEQUENCE {	1 entry		
physCellId [1]	Same as Cell 5		
cgi-Info [1]	Not checked		
measResult [1] SEQUENCE {			
utra-RSCP	(-5..91)		
utra-EcN0	(0..49)		
additionalSI-Info-r9	Not present		
}			
}			
measResultListGERAN-r10	Not present		
measResultListCDMA2000-r10	Not present		
}			
logMeasAvailable-r10	Not present		
}			
nonCriticalExtension SEQUENCE {	Not checked		
}			
}			
}			
}			
}			

Table 8.6.3.4.3.3-7: ATTACH ACCEPT for Cell 1 (preamble)

Derivation path: 36.508 Table 4.7.2-1			
Information Element	Value/Remark	Comment	Condition
Equivalent PLMNs	PLMN2		

Table 8.6.3.4.3.3-8: TRACKING AREA UPDATE ACCEPT for Cell 12 (step 18, Table 8.6.3.4.3.2-2)

Derivation path: 36.508 Table 4.7.2-24			
Information Element	Value/Remark	Comment	Condition
Equivalent PLMNs	PLMN1		Cell 28

8.6.4 Logged Radio Link Failure

8.6.4.1 Radio Link Failure logging / Reporting of Intra-frequency measurements

8.6.4.1.1 Test Purpose (TP)

(1)

```
with { UE in RRC_CONNECTED having performed the intra-frequency measurement and reported that the UE
has radio link failure information available }
ensure that {
  when { UE receives the UEInformationRequest message containing rlf-ReportReq }
  then { UE sends the UEInformationResponse message containing the measurement result for intra-
frequency neighbour cell }
}
```

8.6.4.1.2 Conformance requirements

References: The conformance requirements covered in the present TC are specified in: TS 36.331, clause 5.3.7.4, 5.3.7.5, 5.3.11.3 and 5.6.5.3.

[TS 36.331, clause 5.3.7.4]

If the procedure was initiated due to radio link failure or handover failure, the UE shall:

- 1> set the *reestablishmentCellId* in the *VarRLF-Report* to the global cell identity of the selected cell;

[TS 36.331, clause 5.3.7.5]

The UE shall:

...

- 1> set the content of *RRCCConnectionReestablishmentComplete* message as follows:

- 2> if the UE has radio link failure or handover failure information available in *VarRLF-Report* and *plmn-Identity* stored in *VarRLF-Report* is equal to the RPLMN:

- 3> include the *rlf-InfoAvailable*;

...

- 1> submit the *RRCCConnectionReestablishmentComplete* message to lower layers for transmission, upon which the procedure ends;

[TS 36.331, clause 5.3.11.3]

The UE shall:

- 1> upon T310 expiry; or

- 1> upon random access problem indication from MAC while neither T300, T301, T304 nor T311 is running; or

- 1> upon indication from RLC that the maximum number of retransmissions has been reached;

- 2> consider radio link failure to be detected;
- 2> store the following radio link failure information in the *VarRLF-Report* by setting its fields as follows:
 - 3> clear the information included in *VarRLF-Report*, if any;
 - 3> set the *plmn-Identity* to the RPLMN;
 - 3> set the *measResultLastServCell* to include the RSRP and RSRQ, if available, of the PCell based on measurements collected up to the moment the UE detected radio link failure;
 - 3> set the *measResultNeighCells* to include the best measured cells, other than the PCell, ordered such that the best cell is listed first, and based on measurements collected up to the moment the UE detected radio link failure, and set its fields as follows:
 - 4> if the UE was configured to perform measurements for one or more EUTRA frequencies, include the *measResultListEUTRA*;
 - 4> if the UE was configured to perform measurement reporting for one or more neighbouring UTRA frequencies, include the *measResultListUTRA*;
 - 4> if the UE was configured to perform measurement reporting for one or more neighbouring GERAN frequencies, include the *measResultListGERAN*;
 - 4> if the UE was configured to perform measurement reporting for one or more neighbouring CDMA2000 frequencies, include the *measResultsCDMA2000*;

NOTE: The measured quantities are filtered by the L3 filter as configured in the mobility measurement configuration. The measurements are based on the time domain measurement resource restriction, if configured. Blacklisted cells are not required to be reported.

- 3> if detailed location information is available, set the content of the *locationInfo* as follows:
 - 4> include the *locationCoordinates*;
 - 4> include the *horizontalVelocity*, if available;
- 3> set the *failedPCellId* to the global cell identity, if available, and otherwise to the physical cell identity and carrier frequency of the PCell where radio link failure is detected;
- 3> if an *RRCCONNECTIONRECONFIGURATION* message including the *mobilityControlInfo* was received before the connection failure:
 - 4> include *previousPCellId* and set it to the global cell identity of the PCell where the last *RRCCONNECTIONRECONFIGURATION* including the *mobilityControlInfo* message was received;
 - 4> set the *timeConnFailure* to the elapsed time since reception of the last *RRCCONNECTIONRECONFIGURATION* message including the *mobilityControlInfo*;
- 3> set the *connectionFailureType* to *rlf*;
- 2> if AS security has not been activated:
 - 3> perform the actions upon leaving RRC_CONNECTED as specified in 5.3.12, with release cause 'other';
- 2> else:
 - 3> initiate the connection re-establishment procedure as specified in 5.3.7;

The UE may discard the radio link failure information, i.e. release the UE variable *VarRLF-Report* 48 hours after the radio link failure is detected.

[TS 36.331, clause 5.6.5.3]

Upon receiving the *UEInformationRequest* message, the UE shall:

...

1> if *rlf-ReportReq* is set to *true* and the UE has radio link failure information or handover failure information available in *VarRLF-Report* and *plmn-Identity* stored in *VarRLF-Report* is equal to the RPLMN, set the *rlf-Report* in the *UEInformationResponse* message to the value of *rlf-Report* in *VarRLF-Report*;

1> if the *rlf-Report* is included in *UEInformationResponse*:

2> discard the *rlf-Report* from *VarRLF-Report* upon successful delivery of the *UEInformationResponse* message confirmed by lower layers.

...

1> if the *logMeasReport* is included in the *UEInformationResponse*:

...

1> else:

2> submit the *UEInformationResponse* message to lower layers for transmission via SRB1;

8.6.4.1.3 Test description

8.6.4.1.3.1 Pre-test conditions

System Simulator:

- Cell 1 and Cell 2

UE:

None.

Preamble:

- The UE is in state Generic RB Established (state 3) on Cell 1 according to [18].

8.6.4.1.3.2 Test procedure sequence

Table 8.6.4. 1.3.2-1 illustrates the downlink power levels and other changing parameters to be applied for the cells at various time instants of the test execution. Row marked "T0" denotes the initial conditions after preamble, while columns marked "T1" and "T2" are to be applied subsequently. The exact instants on which these values shall be applied are described in the texts in this clause.

Table 8.6.4.1.3.2-1: Time instances of cell power level and parameter changes

	Parameter	Unit	Cell 1	Cell 2	Remark
T0	Cell-specific RS EPRE	dBm/15k Hz	-85	-91	The power level values are such that measurement results for Cell 1 (M1) and Cell 2 (M2) satisfy exit condition for event A3 (M2 < M1).
T1	Cell-specific RS EPRE	dBm/15k Hz	-85	-79	The power level values are such that measurement results for Cell 1 (M1) and Cell 2 (M2) satisfy entry condition for event A3 (M2 > M1).
T2	Cell-specific RS EPRE	dBm/15k Hz	"Off"	-79	Only Cell 2 is available. (NOTE 1)

NOTE 1: Power level "Off" is defined in TS 36.508 Table 6.2.2.1-1.

Table 8.6.4.1.3.2-2: Main behaviour

St	Procedure	Message Sequence		TP	Verdict
		U - S	Message		
1	The SS transmits an <i>RRConnectionReconfiguration</i> message to setup intra frequency measurement on Cell 1.	<--	<i>RRConnectionReconfiguration</i>	-	-
2	The UE transmits an <i>RRConnectionReconfigurationComplete</i> message on Cell 1.	-->	<i>RRConnectionReconfigurationComplete</i>	-	-
3	The SS changes Cell 2 parameters according to the row "T1" in Table 8.6.4.1.3.2-1.	-	-	-	-
4	The UE transmits a <i>MeasurementReport</i> message on Cell 1.	-->	<i>MeasurementReport</i>	-	-
5	The SS changes Cell 1 parameter according to the row "T2" in Table 8.6.4.1.3.2-1.	-	-	-	-
6	The UE transmits an <i>RRConnectionReestablishmentRequest</i> message on Cell 2.	-->	<i>RRConnectionReestablishmentRequest</i>	-	-
7	The SS transmits an <i>RRConnectionReestablishment</i> message on Cell 2.	<--	<i>RRConnectionReestablishment</i>	-	-
8	The UE transmits an <i>RRConnectionReestablishmentComplete</i> message on Cell 2.	-->	<i>RRConnectionReestablishmentComplete</i>	-	-
9	The SS transmits an <i>RRConnectionReconfiguration</i> message on Cell 2.	<--	<i>RRConnectionReconfiguration</i>	-	-
10	The UE transmits an <i>RRConnectionReconfigurationComplete</i> message on Cell 2.	-->	<i>RRConnectionReconfigurationComplete</i>	-	-
11	The SS transmits a <i>UEInformationRequest</i> message on Cell 2.	<--	<i>UEInformationRequest</i>	-	-
12	Check: Does the UE transmit a <i>UEInformationResponse</i> message on Cell 2?	-->	<i>UEInformationResponse</i>	1	P
13	Check: Does the test result of generic test procedure in TS 36.508 subclause 6.4.2.3 indicate that the UE is in E-UTRA RRC_CONNECTED state on Cell 2?	-	-	1	-

8.6.4.1.3.3 Specific message contents

Table 8.6.4.1.3.3-1: *RRConnectionReconfiguration* (step 1, Table 8.6.4.1.3.2-2)

Derivation Path: 36.508, Table 4.6.1-8, condition MEAS
--

Table 8.6.4.1.3.3-2: MeasConfig (Table 8.6.4.1.3.3-1)

Derivation Path: 36.508, Table 4.6.6-1			
Information Element	Value/remark	Comment	Condition
MeasConfig ::= SEQUENCE {			
measObjectToAddModList SEQUENCE (SIZE (1..maxObjectId)) OF SEQUENCE {	1 entry		
measObjectId[1]	IdMeasObject-f1		
measObject[1]	MeasObjectEUTRA-GENERIC(f1)		
}			
reportConfigToAddModList SEQUENCE (SIZE (1..maxReportConfigId)) OF SEQUENCE {	1 entry		
reportConfigId[1]	IdReportConfig-A3		
reportConfig[1]	ReportConfigEUTRA-A3		
}			
measIdToAddModList SEQUENCE (SIZE (1..maxMeasId)) OF SEQUENCE {			
measId[1]	1		
measObjectId[1]	IdMeasObject-f1		
reportConfigId[1]	IdReportConfig-A3		
}			
}			

Table 8.6.4.1.3.3-3: MeasurementReport (step 4, Table 8.6.4.1.3.2-2)

Derivation Path: 36.508, Table 4.6.1-5			
Information Element	Value/remark	Comment	Condition
MeasurementReport ::= SEQUENCE {			
criticalExtensions CHOICE {			
c1 CHOICE {			
measurementReport-r8 SEQUENCE {			
measResults SEQUENCE {			
measId	1		
measResultServCell SEQUENCE {			
rsrpResult	(0..97)		
rsrqResult	(0..34)		
}			
measResultNeighCells CHOICE {			
measResultListEUTRA SEQUENCE (SIZE (1..maxCellReport)) OF SEQUENCE {	1 entry		
physCellId	PhysicalCellIdentity of Cell 2		
cgi-Info	Not present		
measResult SEQUENCE {			
rsrpResult	(0..97)		
rsrqResult	(0..34)		
additionalSI-Info-r9	Not present		
}			
}			
}			
measResultForECID-r9	Not present		
}			
}			
}			

Table 8.6.4.1.3.3-4: RRCConnectionReestablishmentRequest (step 6, Table 8.6.4.1.3.2-2)

Derivation Path: 36.508, Table 4.6.1-13			
Information Element	Value/remark	Comment	Condition
RRCConnectionReestablishmentRequest ::= SEQUENCE {			
criticalExtensions CHOICE {			
rrcConnectionReestablishmentRequest-r8			
SEQUENCE {			
ue-Identity SEQUENCE {			
c-RNTI	the value of the C-RNTI of the UE		
physCellId	PhysicalCellIdentity of Cell 1		
shortMAC-I	The same value as the 16 least significant bits of the XMAC-I value calculated by SS		
}			
reestablishmentCause	otherFailure		
}			
}			
}			

Table 8.6.4.1.3.3-5: RRCConnectionReestablishmentComplete (step 8, Table 8.6.4.1.3.2-2)

Derivation Path: 36.508, Table 4.6.1-11			
Information Element	Value/remark	Comment	Condition
RRCConnectionReestablishmentComplete ::= SEQUENCE {			
criticalExtensions CHOICE {			
rrcConnectionReestablishmentComplete-r8 =			
SEQUENCE {			
nonCriticalExtension SEQUENCE {			
rfl-InfoAvailable-r9	true		
nonCriticalExtension	Not present or any allowed value		
}			
}			
}			
}			

Table 8.6.4.1.3.3-6: RRCConnectionReconfiguration (step 9, Table 8.6.4.1.3.2-2)

Derivation Path: 36.508, Table 4.6.1-8			
Information Element	Value/remark	Comment	Condition
RRCConnectionReconfiguration ::= SEQUENCE {			
criticalExtensions CHOICE {			
c1 CHOICE{			
rrcConnectionReconfiguration-r8 SEQUENCE {			
radioResourceConfigDedicated	RadioResourceConfigDedicated-HO		
}			
}			
}			
}			

Table 8.6.4.1.3.3-7: UEInformationRequest (step 11, Table 8.6.4.1.3.2-2)

Derivation Path: 36.508, Table 4.6.1-23A			
Information Element	Value/remark	Comment	Condition
UEInformationRequest-r9 ::=SEQUENCE {			
criticalExtensions CHOICE {			
c1 CHOICE {			
ueInformationRequest-r9 SEQUENCE {			
rf-ReportReq-r9	TRUE		
}			
}			
}			
}			

Table 8.6.4.1.3.3-8: *UEInformationResponse* (step 12, Table 8.6.4.1.3.2-2)

Derivation Path: 36.508, Table 4.6.1-23B			
Information Element	Value/remark	Comment	Condition
<i>UEInformationResponse</i> -r9 ::=SEQUENCE {			
criticalExtensions CHOICE {			
c1 CHOICE {			
<i>ueInformationResponse</i> -r9 SEQUENCE {			
rfl-Report-r9 SEQUENCE {			
measResultLastServCell-r9 SEQUENCE {			
rsrpResult-r9	(0..97)		
rsrqResult-r9	Not present or (0..34)		
}			
measResultNeighCells-r9 SEQUENCE {			
measResultListEUTRA-r9 SEQUENCE (SIZE (1..maxFreq)) OF SEQUENCE {	1 entry		
carrierFreq-r9[1]	Same downlink EARFCN as used for Cell 2		
measResultList-r9[1] SEQUENCE (SIZE (1..maxCellReport)) OF SEQUENCE {	1 entry		
physCellId[1]	Physical cell Identity of Cell 2		
cgi-Info[1]	Not present		
measResult[1] SEQUENCE {			
rsrpResult	(0..97)		
rsrqResult	(0..34)		
additionalSI-Info-r9	Not present		
}			
}			
}			
measResultListUTRA-r9	Not present		
measResultListGERAN-r9	Not present		
measResultsCDMA2000-r9	Not present		
}			
locationInfo-r10	Not present or any allowed value		
failedPCellId-r10 CHOICE {	cellGlobalId-r10 or pci-arfcn-r10	If the UE has the global cell identity depending on UE implementation, the UE sets the global cell identity, otherwise the UE sets the physical cell identity and the carrier frequency.	
cellGlobalId-r10 SEQUENCE {			
plmn-Identity	<i>plmn-Identity</i> within <i>SystemInformationBlockType1</i> broadcasted in Cell 1		
cellIdentity	<i>cellIdentity</i> within <i>SystemInformationBlockType1</i> broadcasted in Cell 1		
}			
pci-arfcn-r10 SEQUENCE {			
physCellId-r10	Physical cell Identity of Cell 1		
carrierFreq-r10	Same downlink EARFCN as used for Cell 1		
}			
}			
reestablishmentCellId-r10 SEQUENCE {			
plmn-Identity	<i>plmn-Identity</i> within <i>SystemInformationBlockT</i>		

	<i>ype1</i> broadcasted in Cell 2		
<i>cellIdentity</i>	<i>cellIdentity</i> within <i>SystemInformationBlockType1</i> broadcasted in Cell 2		
}			
<i>timeConnFailure-r10</i>	Not present		
<i>connectionFailureType-r10</i>	<i>rlf</i>		
<i>previousPCellId-r10</i>	Not present		
}			
}			
}			
}			
}			

8.6.4.2 Radio Link Failure logging / Reporting of Inter-frequency measurements

8.6.4.2.1 Test Purpose (TP)

(1)

```

with { UE in RRC_CONNECTED having performed the inter-frequency measurement and reported that the UE
has radio link failure information available }
ensure that {
  when { UE receives the UEInformationRequest message containing rlf-ReportReq }
  then { UE sends the UEInformationResponse message containing the measurement result for inter-
frequency neighbour cell }
}

```

8.6.4.2.2 Conformance requirements

References: The conformance requirements covered in the present TC are specified in: TS 36.331, clause 5.3.7.4, 5.3.7.5, 5.3.11.3 and 5.6.5.3.

[TS 36.331, clause 5.3.7.4]

If the procedure was initiated due to radio link failure or handover failure, the UE shall:

- 1> set the *reestablishmentCellId* in the *VarRLF-Report* to the global cell identity of the selected cell;

[TS 36.331, clause 5.3.7.5]

The UE shall:

...

- 1> set the content of *RRCConnectionReestablishmentComplete* message as follows:

- 2> if the UE has radio link failure or handover failure information available in *VarRLF-Report* and *plmn-Identity* stored in *VarRLF-Report* is equal to the RPLMN:
- 3> include the *rlf-InfoAvailable*;

...

- 1> submit the *RRCConnectionReestablishmentComplete* message to lower layers for transmission, upon which the procedure ends;

[TS 36.331, clause 5.3.11.3]

The UE shall:

- 1> upon T310 expiry; or

- 1> upon random access problem indication from MAC while neither T300, T301, T304 nor T311 is running; or

- 1> upon indication from RLC that the maximum number of retransmissions has been reached:
 - 2> consider radio link failure to be detected;
 - 2> store the following radio link failure information in the *VarRLF-Report* by setting its fields as follows:
 - 3> clear the information included in *VarRLF-Report*, if any;
 - 3> set the *plmn-Identity* to the RPLMN;
 - 3> set the *measResultLastServCell* to include the RSRP and RSRQ, if available, of the PCell based on measurements collected up to the moment the UE detected radio link failure;
 - 3> set the *measResultNeighCells* to include the best measured cells, other than the PCell, ordered such that the best cell is listed first, and based on measurements collected up to the moment the UE detected radio link failure, and set its fields as follows:
 - 4> if the UE was configured to perform measurements for one or more EUTRA frequencies, include the *measResultListEUTRA*;
 - 4> if the UE was configured to perform measurement reporting for one or more neighbouring UTRA frequencies, include the *measResultListUTRA*;
 - 4> if the UE was configured to perform measurement reporting for one or more neighbouring GERAN frequencies, include the *measResultListGERAN*;
 - 4> if the UE was configured to perform measurement reporting for one or more neighbouring CDMA2000 frequencies, include the *measResultsCDMA2000*;

NOTE: The measured quantities are filtered by the L3 filter as configured in the mobility measurement configuration. The measurements are based on the time domain measurement resource restriction, if configured. Blacklisted cells are not required to be reported.

- 3> if detailed location information is available, set the content of the *locationInfo* as follows:
 - 4> include the *locationCoordinates*;
 - 4> include the *horizontalVelocity*, if available;
- 3> set the *failedPCellId* to the global cell identity, if available, and otherwise to the physical cell identity and carrier frequency of the PCell where radio link failure is detected;
- 3> if an *RRCCONNECTIONRECONFIGURATION* message including the *mobilityControlInfo* was received before the connection failure:
 - 4> include *previousPCellId* and set it to the global cell identity of the PCell where the last *RRCCONNECTIONRECONFIGURATION* including the *mobilityControlInfo* message was received;
 - 4> set the *timeConnFailure* to the elapsed time since reception of the last *RRCCONNECTIONRECONFIGURATION* message including the *mobilityControlInfo*;
- 3> set the *connectionFailureType* to *rlf*;
- 2> if AS security has not been activated:
 - 3> perform the actions upon leaving RRC_CONNECTED as specified in 5.3.12, with release cause 'other';
- 2> else:
 - 3> initiate the connection re-establishment procedure as specified in 5.3.7;

The UE may discard the radio link failure information, i.e. release the UE variable *VarRLF-Report* 48 hours after the radio link failure is detected.

[TS 36.331, clause 5.6.5.3]

Upon receiving the *UEInformationRequest* message, the UE shall:

...

1> if *rlf-ReportReq* is set to *true* and the UE has radio link failure information or handover failure information available in *VarRLF-Report* and *plmn-Identity* stored in *VarRLF-Report* is equal to the RPLMN, set the *rlf-Report* in the *UEInformationResponse* message to the value of *rlf-Report* in *VarRLF-Report*;

1> if the *rlf-Report* is included in *UEInformationResponse*:

2> discard the *rlf-Report* from *VarRLF-Report* upon successful delivery of the *UEInformationResponse* message confirmed by lower layers.

...

1> if the *logMeasReport* is included in the *UEInformationResponse*:

...

1> else:

2> submit the *UEInformationResponse* message to lower layers for transmission via SRB1;

8.6.4.2.3 Test description

8.6.4.2.3.1 Pre-test conditions

System Simulator:

- Cell 1 and Cell 3
- System information combination 3 as defined in TS 36.508 [18] clause 4.4.3.1 is used in E-UTRA cells.

UE:

None.

Preamble:

- The UE is in state Generic RB Established (state 3) on Cell 1 according to [18].

8.6.4.2.3.2 Test procedure sequence

Table 8.6.4.2.3.2-1 illustrates the downlink power levels and other changing parameters to be applied for the cells at various time instants of the test execution. Row marked "T0" denotes the initial conditions after preamble, while columns marked "T1" and "T2" are to be applied subsequently. The exact instants on which these values shall be applied are described in the texts in this clause.

Table 8.6.4.2.3.2-1: Time instances of cell power level and parameter changes

	Parameter	Unit	Cell 1	Cell 3	Remark
T0	Cell-specific RS EPRE	dBm/15k Hz	-85	-97	The power level values are such that measurement results for Cell 1 (M1) and Cell 3 (M3) satisfy exit condition for event A3 (M3 < M1).
T1	Cell-specific RS EPRE	dBm/15k Hz	-85	-73	The power level values are such that measurement results for Cell 1 (M1) and Cell 3 (M3) satisfy entry condition for event A3 (M3 > M1).
T2	Cell-specific RS EPRE	dBm/15k Hz	"Off"	-73	Only Cell 3 is available. (NOTE 1)
NOTE 1: Power level "Off" is defined in TS 36.508 Table 6.2.2.1-1.					

Table 8.6.4.2.3.2-2: Main behaviour

St	Procedure	Message Sequence		TP	Verdict
		U - S	Message		
1	The SS transmits an <i>RRCCONNECTIONRECONFIGURATION</i> message to setup inter-frequency measurement on Cell 1.	<--	<i>RRCCONNECTIONRECONFIGURATION</i>	-	-
2	The UE transmits an <i>RRCCONNECTIONRECONFIGURATIONCOMPLETE</i> message on Cell 1.	-->	<i>RRCCONNECTIONRECONFIGURATIONCOMPLETE</i>	-	-
3	The SS changes Cell 3 parameters according to the row "T1" in Table 8.6.4.2.3.2-1.	-	-	-	-
4	The UE transmits a <i>MEASUREMENTREPORT</i> message on Cell 1.	-->	<i>MEASUREMENTREPORT</i>	-	-
5	The SS changes Cell 1 parameter according to the row "T2" in Table 8.6.4.2.3.2-1.	-	-	-	-
6	The UE transmits an <i>RRCCONNECTIONREESTABLISHMENTREQUEST</i> message on Cell 3.	-->	<i>RRCCONNECTIONREESTABLISHMENTREQUEST</i>	-	-
7	The SS transmits an <i>RRCCONNECTIONREESTABLISHMENT</i> message on Cell 3.	<--	<i>RRCCONNECTIONREESTABLISHMENT</i>	-	-
8	The UE transmits an <i>RRCCONNECTIONREESTABLISHMENTCOMPLETE</i> message on Cell 3.	-->	<i>RRCCONNECTIONREESTABLISHMENTCOMPLETE</i>	-	-
9	The SS transmits an <i>RRCCONNECTIONRECONFIGURATION</i> message on Cell 3.	<--	<i>RRCCONNECTIONRECONFIGURATION</i>	-	-
10	The UE transmits an <i>RRCCONNECTIONRECONFIGURATIONCOMPLETE</i> message on Cell 3.	-->	<i>RRCCONNECTIONRECONFIGURATIONCOMPLETE</i>	-	-
11	The SS transmits a <i>UEINFORMATIONREQUEST</i> message on Cell 3.	<--	<i>UEINFORMATIONREQUEST</i>	-	-
12	Check: Does the UE transmit a <i>UEINFORMATIONRESPONSE</i> message on Cell 3?	-->	<i>UEINFORMATIONRESPONSE</i>	1	P
13	Check: Does the test result of generic test procedure in TS 36.508 subclause 6.4.2.3 indicate that the UE is in E-UTRA RRC_CONNECTED state on Cell 3?	-	-	1	-

8.6.4.2.3.3 Specific message contents

Table 8.6.4.2.3.3-1: *RRCCONNECTIONRECONFIGURATION* (step 1, Table 8.6.4.2.3.2-2)

Derivation Path: 36.508, Table 4.6.1-8, condition MEAS
--

Table 8.6.4.2.3.3-2: MeasConfig (Table 8.6.4.2.3.3-1)

Derivation Path: 36.508, Table 4.6.6-1, condition INTER-FREQ			
Information Element	Value/remark	Comment	Condition
MeasConfig ::= SEQUENCE {			
measObjectToAddModList SEQUENCE (SIZE (1..maxObjectId)) OF SEQUENCE {	2 entries		
measObjectId[1]	IdMeasObject-f1		
measObject[1]	MeasObjectEUTRA-GENERIC(f1)		
measObjectId[2]	IdMeasObject-f2		
measObject[2]	MeasObjectEUTRA-GENERIC(f2)		
}			
reportConfigToAddModList SEQUENCE (SIZE (1..maxReportConfigId)) OF SEQUENCE {	1 entry		
reportConfigId[1]	IdReportConfig-A3		
reportConfig[1]	ReportConfigEUTRA-A3		
}			
measIdToAddModList SEQUENCE (SIZE (1..maxMeasId)) OF SEQUENCE {			
measId[1]	1		
measObjectId[1]	IdMeasObject-f2		
reportConfigId[1]	IdReportConfig-A3		
}			
}			

Table 8.6.4.2.3.3-3: MeasurementReport (step 4, Table 8.6.4.2.3.2-2)

Derivation Path: 36.508, Table 4.6.1-5			
Information Element	Value/remark	Comment	Condition
MeasurementReport ::= SEQUENCE {			
criticalExtensions CHOICE {			
c1 CHOICE{			
measurementReport-r8 SEQUENCE {			
measResults SEQUENCE {			
measId	1		
measResultServCell SEQUENCE {			
rsrpResult	(0..97)		
rsrqResult	(0..34)		
}			
measResultNeighCells CHOICE {			
measResultListEUTRA SEQUENCE (SIZE (1..maxCellReport)) OF SEQUENCE {	1 entry		
physCellId	PhysicalCellIdentity of Cell 3		
cgi-Info	Not present		
measResult SEQUENCE {			
rsrpResult	(0..97)		
rsrqResult	(0..34)		
additionalSI-Info-r9	Not present		
}			
}			
}			
measResultForECID-r9	Not present		
}			
}			
}			

Table 8.6.4.2.3.3-4: RRCConnectionReestablishmentRequest (step 6, Table 8.6.4.2.3.2-2)

Derivation Path: 36.508, Table 4.6.1-13			
Information Element	Value/remark	Comment	Condition
RRCConnectionReestablishmentRequest ::= SEQUENCE {			
criticalExtensions CHOICE {			
rrcConnectionReestablishmentRequest-r8			
SEQUENCE {			
ue-Identity SEQUENCE {			
c-RNTI	the value of the C-RNTI of the UE		
physCellId	PhysicalCellIdentity of Cell 1		
shortMAC-I	The same value as the 16 least significant bits of the XMAC-I value calculated by SS		
}			
reestablishmentCause	otherFailure		
}			
}			
}			

Table 8.6.4.2.3.3-5: RRCConnectionReestablishmentComplete (step 8, Table 8.6.4.2.3.2-2)

Derivation Path: 36.508, Table 4.6.1-11			
Information Element	Value/remark	Comment	Condition
RRCConnectionReestablishmentComplete ::= SEQUENCE {			
criticalExtensions CHOICE {			
rrcConnectionReestablishmentComplete-r8 =			
SEQUENCE {			
nonCriticalExtension SEQUENCE {			
rfl-InfoAvailable-r9	true		
nonCriticalExtension	Not present or any allowed value		
}			
}			
}			
}			

Table 8.6.4.2.3.3-6: RRCConnectionReconfiguration (step 9, Table 8.6.4.2.3.2-2)

Derivation Path: 36.508, Table 4.6.1-8			
Information Element	Value/remark	Comment	Condition
RRCConnectionReconfiguration ::= SEQUENCE {			
criticalExtensions CHOICE {			
c1 CHOICE{			
rrcConnectionReconfiguration-r8 SEQUENCE {			
radioResourceConfigDedicated	RadioResourceConfigDedicated-HO		
}			
}			
}			
}			

Table 8.6.4.2.3.3-7: UEInformationRequest (step 11, Table 8.6.4.2.3.2-2)

Derivation Path: 36.508, Table 4.6.1-23A			
Information Element	Value/remark	Comment	Condition
UEInformationRequest-r9 ::=SEQUENCE {			
criticalExtensions CHOICE {			
c1 CHOICE {			
ueInformationRequest-r9 SEQUENCE {			
rf-ReportReq-r9	TRUE		
}			
}			
}			
}			

Table 8.6.4.2.3.3-8: *UEInformationResponse* (step 12, Table 8.6.4.2.3.2-2)

Derivation Path: 36.508, Table 4.6.1-23B			
Information Element	Value/remark	Comment	Condition
<i>UEInformationResponse</i> -r9 ::=SEQUENCE {			
criticalExtensions CHOICE {			
c1 CHOICE {			
<i>ueInformationResponse</i> -r9 SEQUENCE {			
r1f-Report-r9 SEQUENCE {			
measResultLastServCell-r9 SEQUENCE {			
rsrpResult-r9	(0..97)		
rsrqResult-r9	Not present or (0..34)		
}			
measResultNeighCells-r9 SEQUENCE {			
measResultListEUTRA-r9 SEQUENCE (SIZE (1..maxFreq)) OF SEQUENCE {	1 entry		
carrierFreq-r9[1]	Same downlink EARFCN as used for Cell 3		
measResultList-r9[1] SEQUENCE (SIZE (1..maxCellReport)) OF SEQUENCE {	1 entry		
physCellId[1]	PhysicalCellId of Cell 3		
cgi-Info[1]	Not present		
measResult[1] SEQUENCE {			
rsrpResult	(0..97)		
rsrqResult	(0..34)		
additionalSI-Info-r9	Not present		
}			
}			
}			
measResultListUTRA-r9	Not present		
measResultListGERAN-r9	Not present		
measResultsCDMA2000-r9	Not present		
}			
locationInfo-r10	Not present or any allowed value		
failedPCellId-r10 CHOICE {	cellGlobalId-r10 or pci-arfcn-r10	If the UE has the global cell identity depending on UE implementation, the UE sets the global cell identity, otherwise the UE sets the physical cell identity and the carrier frequency.	
cellGlobalId-r10 SEQUENCE {			
plmn-Identity	<i>plmn-Identity</i> within <i>SystemInformationBlockType1</i> broadcasted in Cell 1		
cellIdentity	<i>cellIdentity</i> within <i>SystemInformationBlockType1</i> broadcasted in Cell 1		
}			
pci-arfcn-r10 SEQUENCE {			
physCellId-r10	PhysicalCellId of Cell 1		
carrierFreq-r10	Same downlink EARFCN as used for Cell 1		
}			
}			
reestablishmentCellId-r10 SEQUENCE {			
plmn-Identity	<i>plmn-Identity</i> within <i>SystemInformationBlockT</i>		

	<i>ype1</i> broadcasted in Cell 3		
<i>cellIdentity</i>	<i>cellIdentity</i> within <i>SystemInformationBlockType1</i> broadcasted in Cell 3		
}			
<i>timeConnFailure-r10</i>	Not present		
<i>connectionFailureType-r10</i>	<i>rlf</i>		
<i>previousPCellId-r10</i>	Not present		
}			
}			
}			
}			
}			
}			

8.6.4.3 Radio Link Failure logging / Reporting at RRC connection establishment and reestablishment

8.6.4.3.1 Test Purpose (TP)

(1)

```
with { UE in RRC_CONNECTED state detecting radio link failure }
ensure that {
  when { T301 expires after UE having sent an RRCConnectionReestablishmentRequest message, the UE has radio link failure information available in VarRLF-Report and plmn-Identity stored in VarRLF-Report is equal to the RPLMN }
  then { UE sends the RRCConnectionSetupComplete message with rlf-InfoAvailable included when UE performs TAU procedure }
}
```

(2)

```
with { UE in RRC_CONNECTED state detecting radio link failure }
ensure that {
  when { UE has radio link failure information available in VarRLF-Report and plmn-Identity stored in VarRLF-Report is equal to the RPLMN }
  then { UE sends the RRCConnectionReestablishmentComplete message with rlf-InfoAvailable included }
}
```

(3)

```
with { UE in RRC_CONNECTED state with the radio link failure information available and plmn-Identity stored in VarRLF-Report is equal to the RPLMN }
ensure that {
  when { UE receives the UEInformationRequest message with rlf-ReportReq set to true }
  then { UE sends the UEInformationResponse message with rlf-Report included }
}
```

(4)

```
with { UE in RRC_CONNECTED state with the radio link failure information available and plmn-Identity stored in VarRLF-Report is equal to the RPLMN }
ensure that {
  when { UE receives the UEInformationRequest message containing rlf-ReportReq }
  then { UE sends the UEInformationResponse message with eestablishmentCellId set to the global cell identity of the selected cell }
}
```

(5)

```
with { UE in RRC_CONNECTED state with successful delivery of the UEInformationResponse message confirmed by lower layer }
ensure that {
  when { UE receives the UEInformationRequest message containing rlf-ReportReq }
  then { UE sends the UEInformationResponse message without rlf-Report included }
}
```

8.6.4.3.2 Conformance requirements

References: The conformance requirements covered in the present TC are specified in: TS 36.331, clause 5.3.3.4, 5.3.7.5, 5.3.11.3, 5.3.7.4 and 5.6.5.3.

[TS 36.331, clause 5.3.3.4 (TP1)]

The UE shall:

...

1> set the content of *RRCCConnectionSetupComplete* message as follows:

...

2> set the *dedicatedInfoNAS* to include the information received from upper layers;

2> if the UE has radio link failure or handover failure information available in *VarRLF-Report* and *plmn-Identity* stored in *VarRLF-Report* is equal to the RPLMN:

3> include *rlf-InfoAvailable*;

...

2> submit the *RRCCConnectionSetupComplete* message to lower layers for transmission, upon which the procedure ends;

[TS 36.331, clause 5.3.7.5 (TP2)]

The UE shall:

...

1> set the content of *RRCCConnectionReestablishmentComplete* message as follows:

2> if the UE has radio link failure or handover failure information available in *VarRLF-Report* and *plmn-Identity* stored in *VarRLF-Report* is equal to the RPLMN:

3> include the *rlf-InfoAvailable*;

...

1> submit the *RRCCConnectionReestablishmentComplete* message to lower layers for transmission, upon which the procedure ends;

[TS 36.331, clause 5.3.11.3 (TP1, TP2)]

The UE shall:

1> upon T310 expiry; or

1> upon random access problem indication from MAC while neither T300, T301, T304 nor T311 is running; or

1> upon indication from RLC that the maximum number of retransmissions has been reached:

2> consider radio link failure to be detected;

2> store the following radio link failure information in the *VarRLF-Report* by setting its fields as follows:

3> clear the information included in *VarRLF-Report*, if any;

3> set the *plmn-Identity* to the RPLMN;

3> set the *measResultLastServCell* to include the RSRP and RSRQ, if available, of the PCell based on measurements collected up to the moment the UE detected radio link failure;

- 3> set the *measResultNeighCells* to include the best measured cells, other than the PCell, ordered such that the best cell is listed first, and based on measurements collected up to the moment the UE detected radio link failure, and set its fields as follows;
 - 4> if the UE was configured to perform measurements for one or more EUTRA frequencies, include the *measResultListEUTRA*;
 - 4> if the UE was configured to perform measurement reporting for one or more neighbouring UTRA frequencies, include the *measResultListUTRA*;
 - 4> if the UE was configured to perform measurement reporting for one or more neighbouring GERAN frequencies, include the *measResultListGERAN*;
 - 4> if the UE was configured to perform measurement reporting for one or more neighbouring CDMA2000 frequencies, include the *measResultsCDMA2000*;

NOTE: The measured quantities are filtered by the L3 filter as configured in the mobility measurement configuration. The measurements are based on the time domain measurement resource restriction, if configured. Blacklisted cells are not required to be reported.

- 3> if detailed location information is available, set the content of the *locationInfo* as follows:
 - 4> include the *locationCoordinates*;
 - 4> include the *horizontalVelocity*, if available;
- 3> set the *failedPCellId* to the global cell identity, if available, and otherwise to the physical cell identity and carrier frequency of the PCell where radio link failure is detected;
- 3> if an *RRCCONNECTIONRECONFIGURATION* message including the *mobilityControlInfo* was received before the connection failure:
 - 4> include *previousPCellId* and set it to the global cell identity of the PCell where the last *RRCCONNECTIONRECONFIGURATION* including the *mobilityControlInfo* message was received;
 - 4> set the *timeConnFailure* to the elapsed time since reception of the last *RRCCONNECTIONRECONFIGURATION* message including the *mobilityControlInfo*;
- 3> set the *connectionFailureType* to *rlf*;
- 2> if AS security has not been activated:
 - 3> perform the actions upon leaving RRC_CONNECTED as specified in 5.3.12, with release cause 'other';
- 2> else:
 - 3> initiate the connection re-establishment procedure as specified in 5.3.7;

The UE may discard the radio link failure information, i.e. release the UE variable *VarRLF-Report* 48 hours after the radio link failure is detected.

[TS 36.331, clause 5.3.7.4 (TP4)]

If the procedure was initiated due to radio link failure or handover failure, the UE shall:

- 1> set the *reestablishmentCellId* in the *VarRLF-Report* to the global cell identity of the selected cell;

[TS 36.331, clause 5.6.5.3 (TP4,TP5)]

Upon receiving the *UEInformationRequest* message, the UE shall:

...

- 1> if *rlf-ReportReq* is set to *true* and the UE has radio link failure information or handover failure information available in *VarRLF-Report* and *plmn-Identity* stored in *VarRLF-Report* is equal to the RPLMN, set the *rlf-Report* in the *UEInformationResponse* message to the value of *rlf-Report* in *VarRLF-Report*;

1> if the *rlf-Report* is included in *UEInformationResponse*:

2> discard the *rlf-Report* from *VarRLF-Report* upon successful delivery of the *UEInformationResponse* message confirmed by lower layers.

...

1> if the *logMeasReport* is included in the *UEInformationResponse*:

...

1> else:

2> submit the *UEInformationResponse* message to lower layers for transmission via SRB1;

8.6.4.3.3 Test description

8.6.4.3.3.1 Pre-test conditions

System Simulator:

- Cell 1, Cell 3 and Cell 6
- System information combination 3 as defined in TS 36.508 [18] clause 4.4.3.1 is used in E-UTRA cells.

UE:

None.

Preamble:

- The UE is in state Generic RB Established (state 3) on Cell 1 according to [18].

8.6.4.3.3.2 Test procedure sequence

Table 8.6.4.3.3.2-1 illustrates the downlink power levels and other changing parameters to be applied for the cells at various time instants of the test execution. Row marked "T0" denotes the initial conditions after preamble, while columns marked "T1" and "T2" are to be applied subsequently. The exact instants on which these values shall be applied are described in the texts in this clause.

Table 8.6.4.3.3.2-1: Time instances of cell power level and parameter changes

	Parameter	Unit	Cell 1	Cell 3	Cell 6	Remark
T0	Cell-specific RS EPRE	dBm/15k Hz	-85	"Off"	"Off"	
T1	Cell-specific RS EPRE	dBm/15k Hz	"Off"	-85	"Off"	
T2	Cell-specific RS EPRE	dBm/15k Hz	"Off"	"Off"	-85	
NOTE 1: Power level "Off" is defined in TS 36.508 Table 6.2.2.1-1.						

Table 8.6.4.3.3.2-2: Main behaviour

St	Procedure	Message Sequence		TP	Verdict
		U - S	Message		
1	The SS changes Cell 1 and Cell 3 parameters according to the row "T1" in Table 8.6.4.3.3.2-1 in order that the radio link quality of Cell 1 is degraded and Cell 3 is suitable for camping.	-	-	-	-
2	The UE transmits an <i>RRCCONNECTIONREESTABLISHMENTREQUEST</i> message on Cell 3.	-->	<i>RRCCONNECTIONREESTABLISHMENTREQUEST</i>	-	-
3	The SS does not respond to any <i>RRCCONNECTIONREESTABLISHMENTREQUEST</i> message and waits for 1s to ensure that T301 expires and the UE goes to RRC_IDLE state on Cell 3.				
4	The UE transmits an <i>RRCCONNECTIONREQUEST</i> message on Cell 3	-->	RRC: <i>RRCCONNECTIONREQUEST</i>	-	-
5	The SS transmit an <i>RRCCONNECTIONSETUP</i> message.	<--	RRC: <i>RRCCONNECTIONSETUP</i>	-	-
6	Check: Does the UE transmit an <i>RRCCONNECTIONSETUPCOMPLETE</i> message to confirm the successful completion of the connection establishment with <i>rlf-InfoAvailable</i> included?	-->	RRC: <i>RRCCONNECTIONSETUPCOMPLETE</i> NAS: TRACKING AREA UPDATE REQUEST	1	P
7	The SS responds with TRACKING AREA UPDATE ACCEPT message.	<--	RRC: <i>DLINFORMATIONTRANSFER</i> NAS: TRACKING AREA UPDATE ACCEPT	-	-
8	The UE sends a TRACKING AREA UPDATE COMPLETE on Cell 3 to finish the TAU procedure	-->	RRC: <i>ULINFORMATIONTRANSFER</i> NAS: TRACKING AREA UPDATE COMPLETE	-	-
9	The SS changes Cell 3 and Cell 6 parameters according to the row "T2" in Table 8.6.4.3.3.2-1 in order that the radio link quality of Cell 3 is degraded and Cell 6 is suitable for camping.	-	-	-	-
10	The UE transmits an <i>RRCCONNECTIONREESTABLISHMENTREQUEST</i> message on Cell 6.	-->	<i>RRCCONNECTIONREESTABLISHMENTREQUEST</i>	-	-
11	The SS transmits an <i>RRCCONNECTIONREESTABLISHMENT</i> message on Cell 6.	<--	<i>RRCCONNECTIONREESTABLISHMENT</i>	-	-
12	Check: Does the UE transmit an <i>RRCCONNECTIONREESTABLISHMENTCOMPLETE</i> message on Cell 6 with <i>rlf-InfoAvailable</i> included?	-->	<i>RRCCONNECTIONREESTABLISHMENTCOMPLETE</i>	2	P
13	The SS transmits an <i>RRCCONNECTIONRECONFIGURATION</i> message to resume existing radio bearer on Cell 6.	<--	<i>RRCCONNECTIONRECONFIGURATION</i>	-	-
14	The UE transmits an <i>RRCCONNECTIONRECONFIGURATIONCOMPLETE</i> message on Cell 6.	-->	<i>RRCCONNECTIONRECONFIGURATIONCOMPLETE</i>	-	-
15	The SS transmits a <i>UEINFORMATIONREQUEST</i> message with <i>rlf-ReportReq</i> set to <i>true</i> on Cell 6.	<--	<i>UEINFORMATIONREQUEST</i>	-	-
16	Check: Does the UE transmit a <i>UEINFORMATIONRESPONSE</i> message on Cell 6 with <i>rlf-Report</i> included? Check: Does the <i>reestablishmentCellId</i> included in the <i>UEINFORMATIONRESPONSE</i> message equal to the global cell identity of Cell 6?	-->	<i>UEINFORMATIONRESPONSE</i>	3, 4	P
17	The SS transmits a <i>UEINFORMATIONREQUEST</i> message with <i>rlf-ReportReq</i> set to <i>true</i> on Cell 6.	<--	<i>UEINFORMATIONREQUEST</i>	-	-
18	Check: Does the UE transmit a <i>UEINFORMATIONRESPONSE</i> message on Cell 6 without <i>rlf-Report</i> included?	-->	<i>UEINFORMATIONRESPONSE</i>	5	P
19	Check: Does the test result of generic test	-	-	1	-

	procedure in TS 36.508 subclause 6.4.2.3 indicate that the UE is in E-UTRA RRC_CONNECTED state on Cell 6?				
--	---	--	--	--	--

8.6.4.3.3.3 Specific message contents

Table 8.6.4.3.3.3-1: RRCConnectionReestablishmentRequest (step 2, Table 8.6.4.3.3.2-2)

Derivation Path: 36.508, Table 4.6.1-13			
Information Element	Value/remark	Comment	Condition
RRCConnectionReestablishmentRequest ::= SEQUENCE {			
criticalExtensions CHOICE {			
rrcConnectionReestablishmentRequest-r8 SEQUENCE {			
ue-Identity SEQUENCE {			
c-RNTI	the value of the C-RNTI of the UE		
physCellId	PhysicalCellIdentity of Cell 1		
shortMAC-I	The same value as the 16 least significant bits of the XMAC-I value calculated by SS		
}			
reestablishmentCause	otherFailure		
}			
}			
}			

Table 8.6.4.3.3.3-2: RRCConnectionSetupComplete (step 6, Table 8.6.4.3.3.2-2)

Derivation Path: 36.508, Table 4.6.1-18			
Information Element	Value/remark	Comment	Condition
RRCConnectionSetupComplete ::= SEQUENCE {			
rrc-TransactionIdentifier	RRC-TransactionIdentifier-UL		
criticalExtensions CHOICE {			
c1 CHOICE {			
rrcConnectionSetupComplete-r8 SEQUENCE {			
nonCriticalExtension SEQUENCE {			
lateNonCriticalExtension			
nonCriticalExtension SEQUENCE {			
rlf-InfoAvailable-r10	true		
}			
}			
}			
}			
}			

Table 8.6.4.3.3.3-3: RRCConnectionReestablishmentRequest (step 10, Table 8.6.4.3.3.2-2)

Derivation Path: 36.508, Table 4.6.1-13			
Information Element	Value/remark	Comment	Condition
RRCConnectionReestablishmentRequest ::= SEQUENCE {			
criticalExtensions CHOICE {			
rrcConnectionReestablishmentRequest-r8			
SEQUENCE {			
ue-Identity SEQUENCE {			
c-RNTI	the value of the C-RNTI of the UE		
physCellId	PhysicalCellIdentity of Cell 3		
shortMAC-I	The same value as the 16 least significant bits of the XMAC-I value calculated by SS		
}			
reestablishmentCause	otherFailure		
}			
}			

Table 8.6.4.3.3.3-4: RRCConnectionReestablishmentComplete (step 12, Table 8.6.4.3.3.2-2)

Derivation Path: 36.508, Table 4.6.1-11			
Information Element	Value/remark	Comment	Condition
RRCConnectionReestablishmentComplete ::= SEQUENCE {			
criticalExtensions CHOICE {			
rrcConnectionReestablishmentComplete-r8 =			
SEQUENCE {			
nonCriticalExtension SEQUENCE {			
rfl-InfoAvailable-r9	true		
nonCriticalExtension	Not present or any allowed value		
}			
}			
}			

Table 8.6.4.3.3.3-5: RRCConnectionReconfiguration (step 13, Table 8.6.4.3.3.2-2)

Derivation Path: 36.508, Table 4.6.1-8			
Information Element	Value/remark	Comment	Condition
RRCConnectionReconfiguration ::= SEQUENCE {			
criticalExtensions CHOICE {			
c1 CHOICE{			
rrcConnectionReconfiguration-r8 SEQUENCE {			
radioResourceConfigDedicated	RadioResourceConfigDedicated-HO		
}			
}			
}			

Table 8.6.4.3.3-6: UEInformationRequest (steps 15 and 17, Table 8.6.4.3.3-2)

Derivation Path: 36.508, Table 4.6.1-23A			
Information Element	Value/remark	Comment	Condition
UEInformationRequest-r9 ::=SEQUENCE {			
criticalExtensions CHOICE {			
c1 CHOICE {			
ueInformationRequest-r9 SEQUENCE {			
r1f-ReportReq-r9	TRUE		
}			
}			
}			
}			

Table 8.6.4.3.3-8: *UEInformationResponse* (step 18, Table 8.6.4.3.3.2-2)

Derivation Path: 36.508, Table 4.6.1-23B			
Information Element	Value/remark	Comment	Condition
<i>UEInformationResponse-r9</i> ::=SEQUENCE {			
criticalExtensions CHOICE {			
c1 CHOICE {			
<i>ueInformationResponse-r9</i> SEQUENCE {			
<i>rlf-Report-r9</i>	Not present		
}			
}			
}			
}			

8.6.4.4 Radio Link Failure logging / Reporting at E-UTRA handover

8.6.4.4.1 Test Purpose (TP)

(1)

```
with { UE in RRC_CONNECTED state with T304 expiry and handover failure information available in
VarRLF-Report and plmn-Identity stored in VarRLF-Report is equal to the RPLMN }
ensure that {
  when { UE receives the RRCConnectionReestablishment message and completes the RRC Connection
Reestablishment successfully }
  then { UE sends the RRCConnectionReestablishmentComplete message including rlf-InfoAvailable }
```

(2)

```
with { UE in RRC_CONNECTED state with handover failure information available in VarRLF-Report and
plmn-Identity stored in VarRLF-Report is equal to the RPLMN }
ensure that {
  when { UE receives RRCConnectionReconfiguration message includes the mobilityControlInfo and the
UE is able to comply with the configuration included in this message }
  then { UE sends the RRCConnectionReconfigurationComplete message with rlf-InfoAvailable included
}
}
```

(3)

```
with { UE in RRC_CONNECTED state with the handover failure information available in VarRLF-Report
and plmn-Identity stored in VarRLF-Report is equal to the RPLMN }
ensure that {
  when { UE receives the UEInformationRequest message with rlf-ReportReq set to true }
  then { UE sends the UEInformationResponse message with rlf-Report included }
}
```

(4)

```
with { UE in RRC_CONNECTED state with the handover failure information available in VarRLF-Report
and plmn-Identity stored in VarRLF-Report is equal to the RPLMN }
ensure that {
  when { UE receives the UEInformationRequest message with rlf-ReportReq set to true }
  then { UE sends the UEInformationResponse message with eestablishmentCellId set to the global
cell identity of the selected cell }
}
```

(5)

```
with { UE in RRC_CONNECTED state with the handover failure information available in VarRLF-Report
and plmn-Identity stored in VarRLF-Report is not equal to the RPLMN }
ensure that {
  when { UE receives the UEInformationRequest message with rlf-ReportReq set to true }
  then { UE sends the UEInformationResponse message without rlf-Report included }
}
```

8.6.4.4.2 Conformance requirements

References: The conformance requirements covered in the present TC are specified in: TS 36.331, clause 5.3.5.4, 5.3.5.6, 5.3.7.4 and 5.6.5.3.

[TS 36.331, clause 5.3.5.4 (TP2)]

If the *RRConnectionReconfiguration* message includes the *mobilityControlInfo* and the UE is able to comply with the configuration included in this message, the UE shall:

...

- 1> set the content of *RRConnectionReconfigurationComplete* message as follows:
 - 2> if the UE has radio link failure or handover failure information available in *VarRLF-Report* and *plmn-Identity* stored in *VarRLF-Report* is equal to the RPLMN:
 - 3> include *rlf-InfoAvailable*;
 - 2> if the UE has logged measurements available for E-UTRA and *plmn-Identity* stored in *VarLogMeasReport* is equal to the RPLMN:
 - 3> include the *logMeasAvailable*;
- 1> submit the *RRConnectionReconfigurationComplete* message to lower layers for transmission;

[TS 36.331, clause 5.3.5.6 (TP1)]

The UE shall:

- 1> if T304 expires (handover failure):

NOTE 1: Following T304 expiry any dedicated preamble, if provided within the *rach-ConfigDedicated*, is not available for use by the UE anymore.

- 2> revert back to the configuration used in the source PCell, excluding the configuration configured by the *physicalConfigDedicated*, the *mac-MainConfig* and the *sps-Config*;
- 2> store the following handover failure information in *VarRLF-Report* by setting its fields as follows:
 - 3> clear the information included in *VarRLF-Report*, if any;
 - 3> set the *plmn-Identity* to the RPLMN;
 - 3> set the *measResultLastServCell* to include the RSRP and RSRQ, if available, of the PCell based on measurements collected up to the moment the UE detected handover failure;
 - 3> set the *measResultNeighCells* to include the best measured cells, other than the PCell, ordered such that the best cell is listed first, and based on measurements collected up to the moment the UE detected handover failure, and set its fields as follows:
 - 4> if the UE was configured to perform measurements for one or more EUTRA frequencies, include the *measResultListEUTRA*;
 - 4> if the UE was configured to perform measurement reporting for one or more neighbouring UTRA frequencies, include the *measResultListUTRA*;
 - 4> if the UE was configured to perform measurement reporting for one or more neighbouring GERAN frequencies, include the *measResultListGERAN*;
 - 4> if the UE was configured to perform measurement reporting for one or more neighbouring CDMA2000 frequencies, include the *measResultsCDMA2000*;

NOTE 2: The measured quantities are filtered by the L3 filter as configured in the mobility measurement configuration. The measurements are based on the time domain measurement resource restriction, if configured. Blacklisted cells are not required to be reported.

- 3> if detailed location information is available, set the content of the *locationInfo* as follows:
 - 4> include the *locationCoordinates*;
 - 4> include the *horizontalVelocity*, if available;
- 3> set the *failedPCellId* to the global cell identity, if available, and otherwise to the physical cell identity and carrier frequency of the target PCell of the failed handover;
- 3> include *previousPCellId* and set it to the global cell identity of the PCell where the last *RRCConnectionReconfiguration* message including *mobilityControlInfo* was received;
- 3> set the *timeConnFailure* to the elapsed time since reception of the last *RRCConnectionReconfiguration* message including the *mobilityControlInfo*;
- 3> set the *connectionFailureType* to 'hof';
- 2> initiate the connection re-establishment procedure as specified in 5.3.7, upon which the RRC connection reconfiguration procedure ends;

The UE may discard the handover failure information, i.e. release the UE variable *VarRLF-Report*, 48 hours after the failure is detected, upon power off or upon detach.

NOTE 3: E-UTRAN may retrieve the handover failure information using the UE information procedure with *rlf-ReportReq* set to *true*, as specified in 5.6.5.3.

[TS 36.331, clause 5.3.7.4 (TP4)]

If the procedure was initiated due to radio link failure or handover failure, the UE shall:

- 1> set the *reestablishmentCellId* in the *VarRLF-Report* to the global cell identity of the selected cell;

The UE shall set the contents of *RRCConnectionReestablishmentRequest* message as follows:

...

- 1> set the *reestablishmentCause* as follows:

...

- 2> else if the re-establishment procedure was initiated due to handover failure as specified in 5.3.5.6 (intra-LTE handover failure) or 5.4.3.5 (inter-RAT mobility from EUTRA failure):
 - 3> set the *reestablishmentCause* to the value *handoverFailure*;
- 2> else:
 - 3> set the *reestablishmentCause* to the value *otherFailure*;

The UE shall submit the *RRCConnectionReestablishmentRequest* message to lower layers for transmission.

[TS 36.331, clause 5.6.5.3 (TP3, TP5)]

Upon receiving the *UEInformationRequest* message, the UE shall:

...

- 1> if *rlf-ReportReq* is set to *true* and the UE has radio link failure information or handover failure information available in *VarRLF-Report* and *plmn-Identity* stored in *VarRLF-Report* is equal to the RPLMN, set the *rlf-Report* in the *UEInformationResponse* message to the value of *rlf-Report* in *VarRLF-Report*;
- 1> if the *rlf-Report* is included in *UEInformationResponse*:
 - 2> discard the *rlf-Report* from *VarRLF-Report* upon successful delivery of the *UEInformationResponse* message confirmed by lower layers.

...

1> if the *logMeasReport* is included in the *UEInformationResponse*:

...

1> else:

2> submit the *UEInformationResponse* message to lower layers for transmission via SRB1;

8.6.4.4.3 Test description

8.6.4.4.3.1 Pre-test conditions

System Simulator:

- Cell 1, Cell 4 and Cell 28
- Each cell has only a single PLMN identity. The PLMNs are identified in the test by the identifiers in Table 8.6.4.4.3.1-1.

Table 8.6.4.4.3.1-1: PLMN identifiers

Cell	PLMN name
1,4	PLMN1
28	PLMN2

UE:

None.

Preamble:

- The UE is registered on PLMN1 (Cell 1) using the procedure described in TS 36.508[18] clause 4.5.2.3 except that the ATTACH ACCEPT message indicates PLMN2 in the Equivalent PLMN list as described in Table 8.6.4.4.3.3-19
- The UE is in state Generic RB Established (state 3) on Cell 1 according to [18].

8.6.4.4.3.2 Test procedure sequence

Table 8.6.4.4.3.2-1 illustrates the downlink power levels and other changing parameters to be applied for the cells at various time instants of the test execution. Row marked "T0" denotes the initial conditions after preamble, while columns marked "T1", "T2", "T3", "T4" and "T5" are to be applied subsequently. The exact instants on which these values shall be applied are described in the texts in this clause.

Table 8.6.4.4.3.2-1: Time instances of cell power level and parameter changes

	Parameter	Unit	Cell 1	Cell 4	Cell 28	Remark
T0	Cell-specific RS EPRE	dBm/15kHz	-85	Off	-97	The power level values are such that measurement results for Cell 1 (M1) and Cell 28 (M28) satisfy exit condition for event A3 ($M28 < M1$).
T1	Cell-specific RS EPRE	dBm/15kHz	-85	Off	-73	The power level values are such that measurement results for Cell 1 (M1) and Cell 28 (M28) satisfy entry condition for event A3 ($M28 > M1$).
T2	Cell-specific RS EPRE	dBm/15kHz	-85	Off	Off	The power level values are assigned to satisfy $Srxlev_{Cell\ 28} < 0$ such that selecting Cell 1 is guaranteed (NOTE 1).
T3	Cell-specific RS EPRE	dBm/15kHz	-85	-79	Off	The power level values are such that measurement results for Cell 1 (M1) and Cell 4 (M4) satisfy entry condition for event A3 ($M4 > M1$).
T4	Cell-specific RS EPRE	dBm/15kHz	Off	-85	-73	The power level values are such that measurement results for Cell 4 (M4) and Cell 28 (M28) satisfy entry condition for event A3 ($M28 > M4$). (NOTE 1).
T5	Cell-specific RS EPRE	dBm/15kHz	Off	Off	-73	The power level values are assigned to satisfy $Srxlev_{Cell\ 4} < 0$ such that selecting Cell 28 is guaranteed (NOTE 1).
NOTE 1: Power level "Off" is defined in TS36.508 Table 6.2.2.1-1.						

Table 8.6.4.4.3.2-2: Main behaviour

St	Procedure	Message Sequence		TP	Verdict
		U - S	Message		
1	The SS transmits an <i>RRCCONNECTIONRECONFIGURATION</i> message to setup intra and inter frequency measurement on Cell 1.	<--	<i>RRCCONNECTIONRECONFIGURATION</i>	-	-
2	The UE transmits an <i>RRCCONNECTIONRECONFIGURATIONCOMPLETE</i> message on Cell 1.	-->	<i>RRCCONNECTIONRECONFIGURATIONCOMPLETE</i>	-	-
3	The SS changes Cell 28 parameter according to the row "T1" in table 8.6.4.4.3.2-1.	-	-	-	-
4	The UE transmits a <i>MEASUREMENTREPORT</i> message on Cell 1 to report event A3 with the measured RSRP, RSRQ value for Cell 28.	-->	<i>MEASUREMENTREPORT</i>	-	-
5	The SS transmits an <i>RRCCONNECTIONRECONFIGURATION</i> message on Cell 1 to order the UE to perform inter frequency handover to Cell 28.	<--	<i>RRCCONNECTIONRECONFIGURATION</i>	-	-
-	EXCEPTION: In parallel to the event described in step 6 the steps specified in Table 8.6.4.4.3.2-3 should take place.	-	-	-	-
6	Wait for 1 s to ensure that T304 expires. The SS changes Cell 28 parameter according to the row "T2" in table 8.6.4.4.3.2-1.	-	-	-	-
7	The UE transmits an <i>RRCCONNECTIONREESTABLISHMENTREQUEST</i> message on Cell 1	-->	<i>RRCCONNECTIONREESTABLISHMENTREQUEST</i>	-	-
8	The SS transmits an <i>RRCCONNECTIONREESTABLISHMENT</i> message to resume SRB1 operation and re-activate security on Cell 1.	<--	<i>RRCCONNECTIONREESTABLISHMENT</i>	-	-
9	Check: Does the UE transmit an <i>RRCCONNECTIONREESTABLISHMENTCOMPLETE</i> message with <i>rf-InfoAvailable</i> included?	-->	<i>RRCCONNECTIONREESTABLISHMENTCOMPLETE</i>	1	P
10	The SS transmits an <i>RRCCONNECTIONRECONFIGURATION</i> message to resume existing radio bearer on Cell 1.	<--	<i>RRCCONNECTIONRECONFIGURATION</i>	-	-
11	The UE transmits an <i>RRCCONNECTIONRECONFIGURATIONCOMPLETE</i> message on Cell 1.	-->	<i>RRCCONNECTIONRECONFIGURATIONCOMPLETE</i>	-	-
12	The SS changes Cell 4 parameter according to the row "T3" in table 8.6.4.4.3.2-1.	-	-	-	-
13	The UE transmits a <i>MEASUREMENTREPORT</i> message on Cell 1 to report event A3 with the measured RSRP, RSRQ value for Cell 4.	-->	<i>MEASUREMENTREPORT</i>	-	-
14	The SS transmits an <i>RRCCONNECTIONRECONFIGURATION</i> message on Cell 1 to order the UE to perform intra frequency handover to Cell 4.	<--	<i>RRCCONNECTIONRECONFIGURATION</i>	-	-
15	Check: Does the UE transmit an <i>RRCCONNECTIONRECONFIGURATIONCOMPLETE</i> message on Cell 4 with <i>rf-InfoAvailable</i> included?	-->	<i>RRCCONNECTIONRECONFIGURATIONCOMPLETE</i>	2	P
16	The SS transmits a <i>UEINFORMATIONREQUEST</i> message with <i>rf-ReportReq</i> set to <i>true</i> on Cell 4.	<--	<i>UEINFORMATIONREQUEST</i>	-	-
17	Check: Does the UE transmit a <i>UEINFORMATIONRESPONSE</i> message on Cell 4 with <i>rf-Report</i> included? Check: Does the <i>reestablishmentCellId</i> included in the <i>UEINFORMATIONRESPONSE</i> message equal to the global cell identity of Cell 1?	-->	<i>UEINFORMATIONRESPONSE</i>	3,4	P
18	The SS transmits an <i>RRCCONNECTIONRECONFIGURATION</i> message to	<--	<i>RRCCONNECTIONRECONFIGURATION</i>	-	-

	activate the measurement gaps on Cell 4				
19	The UE transmits an <i>RRCCONNECTIONRECONFIGURATIONCOMPLETE</i> message to confirm the activation of the measurement gaps on Cell 4.	-->	<i>RRCCONNECTIONRECONFIGURATIONCOMPLETE</i>	-	-
20	The SS changes Cell 1, Cell 4 and Cell 28 parameters according to the row "T4" in table 8.6.4.4.3.2-1.	-	-	-	-
21	The UE transmits a <i>MEASUREMENTREPORT</i> message on Cell 4 to report event A3 with the measured RSRP, RSRQ value for Cell 28.	-->	<i>MEASUREMENTREPORT</i>	-	-
22	The SS transmits an <i>RRCCONNECTIONRECONFIGURATION</i> message on Cell 4 to order the UE to perform inter frequency handover to Cell 28.	<--	<i>RRCCONNECTIONRECONFIGURATION</i>	-	-
-	EXCEPTION: In parallel to the events described in step 21 the steps specified in Table 8.6.4.4.3.2-3 should take place.	-	-	-	-
23	The SS changes Cell 4 power level according to the row "T5" in table 8.6.4.4.3.2-1.	-	-	-	-
24	The UE transmits an <i>RRCCONNECTIONREESTABLISHMENTREQUEST</i> message on Cell 28	-->	<i>RRCCONNECTIONREESTABLISHMENTREQUEST</i>	-	-
25	The SS transmits an <i>RRCCONNECTIONREESTABLISHMENT</i> message to resume SRB1 operation and re-activate security on Cell 28.	<--	<i>RRCCONNECTIONREESTABLISHMENT</i>	-	-
26	Check: Does the UE transmit an <i>RRCCONNECTIONREESTABLISHMENTCOMPLETE</i> message with <i>rlf-InfoAvailable</i> included?	-->	<i>RRCCONNECTIONREESTABLISHMENTCOMPLETE</i>	1	P
27	The SS transmits an <i>RRCCONNECTIONRECONFIGURATION</i> message to resume existing radio bearer on Cell 28.	<--	<i>RRCCONNECTIONRECONFIGURATION</i>	-	-
28	The UE transmits an <i>RRCCONNECTIONRECONFIGURATIONCOMPLETE</i> message on Cell 28.	-->	<i>RRCCONNECTIONRECONFIGURATIONCOMPLETE</i>	-	-
29	The UE transmits a TRACKING AREA UPDATE REQUEST message on Cell 28.	-	-	-	-
30	SS responds with a TRACKING AREA UPDATE ACCEPT message. NOTE: The TAU is accepted with PLMN1 listed as an Equivalent PLMN	-	-	-	-
31	The UE transmits a TRACKING AREA UPDATE COMPLETE message.	-	-	-	-
32	The SS transmits a <i>UEINFORMATIONREQUEST</i> message with <i>rlf-ReportReq</i> set to <i>true</i> on Cell 28.	<--	<i>UEINFORMATIONREQUEST</i>	-	-
33	Check: Does the UE transmit a <i>UEINFORMATIONRESPONSE</i> message on Cell 28 without <i>rlf-Report</i> included?	-->	<i>UEINFORMATIONRESPONSE</i>	5	P
34	Check: Does the test result of generic test procedure in TS 36.508 subclause 6.4.2.3 indicate that the UE is in E-UTRA RRC_CONNECTED state on Cell 28?	-	-	1	-

Table 8.6.4.4.3.2-3: Parallel behaviour

St	Procedure	Message Sequence		TP	Verdict
		U - S	Message		
-	EXCEPTION: The steps 1 and 2 below are repeated for the duration of T304.	-	-	-	-
1	The UE attempts to perform the inter frequency handover using MAC Random Access Preamble on Cell 28.	-	-	-	-
2	The SS does not respond.	-	-	-	-

8.6.4.4.3.3 Specific message contents

Table 8.6.4.4.3.3-0: SystemInformationBlockType2 for Cell 1, Cell 4 and Cell 28 (preamble and all the steps in Table 8.6.4.4.3.2-2)

Derivation Path: 36.508, Table 4.6.3-12			
Information Element	Value/remark	Comment	Condition
ra-SupervisionInfo SEQUENCE {			
preambleTransMax	n50		
}			

Table 8.6.4.4.3.3-1: RRCConnectionReconfiguration (step 1, Table 8.6.4.4.3.2-2)

Derivation Path: 36.508, Table 4.6.1-8, condition MEAS
--

Table 8.6.4.4.3.3-2: MeasConfig (Table 8.6.4.4.3.3-1)

Derivation Path: 36.508, Table 4.6.6-1, condition INTER-FREQ			
Information Element	Value/remark	Comment	Condition
MeasConfig SEQUENCE {			
measObjectToAddModList SEQUENCE (SIZE (1..maxObjectId)) OF SEQUENCE {	2 entries		
measObjectId[1]	IdMeasObject-f1		
measObject[1]	MeasObjectEUTRA-GENERIC(f1)		
measObjectId[2]	IdMeasObject-f6		
measObject[2]	MeasObjectEUTRA-GENERIC(f6)		
}			
reportConfigToAddModList SEQUENCE (SIZE (1..maxReportConfigId)) OF SEQUENCE {	1 entry		
reportConfigId[1]	IdReportConfig-A3		
reportConfig[1]	ReportConfigEUTRA-A3		
}			
measIdToAddModList SEQUENCE (SIZE (1..maxMeasId)) OF SEQUENCE {	2 entries		
measId[1]	1		
measObjectId[1]	IdMeasObject-f1		
reportConfigId[1]	IdReportConfig-A3		
measId[2]	2		
measObjectId[2]	IdMeasObject-f6		
reportConfigId[2]	IdReportConfig-A3		
}			
}			

Table 8.6.4.4.3.3-3: MeasurementReport (step 4, Table 8.6.4.4.3.2-2)

Derivation Path: 36.508, Table 4.6.1-5			
Information Element	Value/remark	Comment	Condition
MeasurementReport ::= SEQUENCE {			
criticalExtensions CHOICE {			
c1 CHOICE{			
measurementReport-r8 SEQUENCE {			
measResults SEQUENCE {			
measId	2		
measResultServCell SEQUENCE {		Cell 1	
rsrpResult	(0..97)		
rsrqResult	(0..34)		
}			
measResultNeighCells CHOICE {			
measResultListEUTRA SEQUENCE (SIZE (1..maxCellReport)) OF SEQUENCE {	1 entry		
physCellId[1]	PhysicalCellIdentity of Cell 28		
cgi-Info[1]	Not present		
measResult[1] SEQUENCE {			
rsrpResult	(0..97)		
rsrqResult	(0..34)		
}			
}			
}			
}			
}			
}			
}			

Table 8.6.4.4.3.3-4: RRCConnectionReconfiguration (step 5, step 14 and step 22, Table 8.6.4.4.3.2-2)

Derivation Path: 36.508, Table 4.6.1-8, condition HO
--

Table 8.6.4.4.3.3-5: MobilityControlInfo (step 5, Table 8.6.4.4.3.3-4)

Derivation Path: 36.308, Table 4.6.5-1			
Information Element	Value/remark	Comment	Condition
MobilityControlInfo ::= SEQUENCE {			
targetPhysCellId	PhysicalCellIdentity of Cell 28		
carrierFreq SEQUENCE {			
dl-CarrierFreq	Same downlink EARFCN as used for Cell 28		
ul-CarrierFreq	Not present		
}			
rach-ConfigDedicated SEQUENCE {			
ra-PreambleIndex	63		
ra-PRACH-MaskIndex	0		
}			
}			

Table 8.6.4.4.3.3-6: RRCConnectionReestablishmentRequest (step 7, Table 8.6.4.4.3.2-2)

Derivation Path: 36.508, Table 4.6.1-13			
Information Element	Value/remark	Comment	Condition
RRCConnectionReestablishmentRequest ::= SEQUENCE {			
criticalExtensions CHOICE {			
rrcConnectionReestablishmentRequest-r8			
SEQUENCE {			
ue-Identity SEQUENCE {			
c-RNTI	the value of the C-RNTI of the UE		
physCellId	PhysicalCellIdentity of Cell 1		
shortMAC-I	The same value as the 16 least significant bits of the XMAC-I value calculated by SS.		
}			
reestablishmentCause	handoverFailure		
}			
}			

Table 8.6.4.4.3.3-7: RRCConnectionReestablishment (step 8, Table 8.6.4.4.3.2-2)

Derivation Path: 36.508, Table 4.6.1-10			
Information Element	Value/remark	Comment	Condition
RRCConnectionReestablishment ::= SEQUENCE {			
criticalExtensions CHOICE {			
c1 CHOICE{			
rrcConnectionReestablishment-r8 SEQUENCE {			
nextHopChainingCount	0		
}			
}			
}			
}			

Table 8.6.4.4.3.3-8: RRCConnectionReestablishmentComplete (step 9 and step 26, Table 8.6.4.4.3.2-2)

Derivation Path: 36.508, Table 4.6.1-11			
Information Element	Value/remark	Comment	Condition
RRCConnectionReestablishmentComplete ::= SEQUENCE {			
criticalExtensions CHOICE {			
rrcConnectionReestablishmentComplete-r8 =			
SEQUENCE {			
nonCriticalExtension SEQUENCE {			
rf-InfoAvailable-r9	true		
}			
}			
}			

Table 8.6.4.4.3.3-9: RRCConnectionReconfiguration (step 10, Table 8.6.4.4.3.2-2)

Derivation Path: 36.508, Table 4.6.1-8			
Information Element	Value/remark	Comment	Condition
RRCConnectionReconfiguration ::= SEQUENCE {			
criticalExtensions CHOICE {			
c1 CHOICE{			
rrcConnectionReconfiguration-r8 SEQUENCE {			
radioResourceConfigDedicated	RadioResourceConfigDe dicated-HO		
}			
}			
}			
}			

Table 8.6.4.4.3.3-10: MeasurementReport (step 13, Table 8.6.4.4.3.2-2)

Derivation Path: 36.508, Table 4.6.1-5			
Information Element	Value/remark	Comment	Condition
MeasurementReport ::= SEQUENCE {			
criticalExtensions CHOICE {			
c1 CHOICE{			
measurementReport-r8 SEQUENCE {			
measResults SEQUENCE {			
measId	1		
measResultServCell SEQUENCE {		Cell 1	
rsrpResult	(0..97)		
rsrqResult	(0..34)		
}			
measResultNeighCells CHOICE {			
measResultListEUTRA SEQUENCE (SIZE (1..maxCellReport)) OF SEQUENCE {	1 entry		
physCellId[1]	PhysicalCellIdentity of Cell 4		
cgi-Info[1]	Not present		
measResult[1] SEQUENCE {			
rsrpResult	(0..97)		
rsrqResult	(0..34)		
}			
}			
}			
}			
}			
}			
}			

Table 8.6.4.4.3.3-11: MobilityControlInfo (step 14, Table 8.6.4.4.3.3-4)

Derivation Path: 36.308, Table 4.6.5-1			
Information Element	Value/remark	Comment	Condition
MobilityControlInfo ::= SEQUENCE {			
targetPhysCellId	PhysicalCellIdentity of Cell 4		
carrierFreq	Not present		
rach-ConfigDedicated SEQUENCE {			
ra-PreambleIndex	63		
ra-PRACH-MaskIndex	0		
}			
}			

Table 8.6.4.4.3-12: RRCConnectionReconfigurationComplete (step 15, Table 8.6.4.4.3.2-2)

Derivation Path: 36.508, Table 4.6.1-9			
Information Element	Value/remark	Comment	Condition
RRCConnectionReconfigurationComplete ::= SEQUENCE {			
rrc-TransactionIdentifier	RRC-TransactionIdentifier-UL		
criticalExtensions CHOICE {			
rrcConnectionReconfigurationComplete-r8			
SEQUENCE {			
nonCriticalExtension SEQUENCE {			
nonCriticalExtension SEQUENCE {			
rlf-InfoAvailable-r10	true		
}			
}			
}			
}			

Table 8.6.4.4.3-13: UEInformationRequest (step 16 and step 32, Table 8.6.4.4.3.2-2)

Derivation Path: 36.508, Table 4.6.1-23A			
Information Element	Value/remark	Comment	Condition
UEInformationRequest-r9 ::= SEQUENCE {			
criticalExtensions CHOICE {			
c1 CHOICE {			
ueInformationRequest-r9 SEQUENCE {			
rlf-ReportReq-r9	TRUE		
}			
}			
}			
}			

Table 8.6.4.4.3.3-14: *UEInformationResponse* (step 17, Table 8.6.4.4.3.2-2)

Derivation Path: 36.508, Table 4.6.1-23B			
Information Element	Value/remark	Comment	Condition
UEInformationResponse-r9 ::=SEQUENCE {			
criticalExtensions CHOICE {			
c1 CHOICE {			
ueInformationResponse-r9 SEQUENCE {			
r1f-Report-r9 SEQUENCE {			
measResultLastServCell-r9 SEQUENCE {		Cell 1	
rsrpResult-r9	(0..97)		
rsrqResult-r9	Not present or (0..34)		
}			
measResultNeighCells-r9 SEQUENCE {			
measResultListEUTRA-r9	1 entry		
SEQUENCE(SIZE(1..maxFreq)) OF SEQUENCE {			
carrierFreq-r9	The ARFCN of Cell 28		
measResultList-r9 SEQUENCE (SIZE			
(1..maxCellReport)) OF SEQUENCE {			
physCellId	Phys cell id of cell 28		
cgi-Info	Not present		
measResult SEQUENCE {			
rsrpResult	(0..97)		
rsrqResult	Not present or (0..34)		
}			
}			
}			
}			
}			
locationInfo-r10	Not present or any allowed value		
failedPCellId-r10 CHOICE {	cellGlobalId-r10 or pci-arfcn-r10	If the UE has the global cell identity depending on UE implementation, the UE sets the global cell identity, otherwise the UE sets the physical cell identity and the carrier frequency.	Target PCell
cellGlobalId-r10 SEQUENCE {			
plmn-Identity	<i>plmn-Identity</i> within <i>SystemInformationBlockType1</i> broadcasted in Cell 28		
cellIdentity	<i>cellIdentity</i> within <i>SystemInformationBlockType1</i> broadcasted in Cell 28		
}			
pci-arfcn-r10 SEQUENCE {			
physCellId-r10	PhysicalCellIdentity of Cell 28		
carrierFreq-r10	Same downlink EARFCN as used for Cell 28		
}			
reestablishmentCellId-r10 SEQUENCE {			
plmn-Identity	<i>plmn-Identity</i> within <i>SystemInformationBlockType1</i> broadcasted in Cell 1	"Verify setting of reestablishment CellId in the VarRLF-Report to the global cell identity of the selected cell at	

		RRC connection re-establishment due to handover failure”	
cellIdentity	<i>cellIdentity</i> within <i>SystemInformationBlockType1</i> broadcasted in Cell 1		
}			
timeConnFailure-r10	Not Checked/Present		
connectionFailureType-r10	hof		
previousPCellId-r10 SEQUENCE {			Source PCell
plmn-Identity	<i>plmn-Identity</i> within <i>SystemInformationBlockType1</i> broadcasted in Cell 1		plmn-Identity
cellIdentity	<i>cellIdentity</i> of Cell 1		cellIdentity
}			
}			
}			
}			
}			
}			

Table 8.6.4.4.3.3-15: RRCConnectionReconfiguration (step 18, Table 8.6.4.4.3.2-2)

Derivation Path: 36.508, Table 4.6.1-8, condition MEAS

Table 8.6.4.4.3.3-16: MeasConfig (Table 8.6.4.4.3.3-15)

Derivation Path: 36.508, Table 4.6.6-1, condition INTER-FREQ

Table 8.6.4.4.3.3-17: *MeasurementReport* (step 19, Table 8.6.4.4.3.2-2)

Derivation Path: 36.508, Table 4.6.1-5			
Information Element	Value/remark	Comment	Condition
MeasurementReport ::= SEQUENCE {			
criticalExtensions CHOICE {			
c1 CHOICE{			
measurementReport-r8 SEQUENCE {			
measResults SEQUENCE {			
measId	1		
measResultServCell SEQUENCE {		Cell 4	
rsrpResult	(0..97)		
rsrqResult	(0..34)		
}			
measResultNeighCells CHOICE {			
measResultListEUTRA SEQUENCE (SIZE (1..maxCellReport)) OF SEQUENCE {	1 entry		
physCellId[1]	PhysicalCellIdentity of Cell 28		
cgi-Info[1]	Not present		
measResult[1] SEQUENCE {			
rsrpResult	(0..97)		
rsrqResult	(0..34)		
}			
}			
}			
}			
}			
}			
}			

Table 8.6.4.4.3.3-18: *MobilityControlInfo* (step 22, Table 8.6.4.4.3.3-4)

Derivation Path: 36.308, Table 4.6.5-1			
Information Element	Value/remark	Comment	Condition
MobilityControlInfo ::= SEQUENCE {			
targetPhysCellId	PhysicalCellIdentity of Cell 28		
carrierFreq SEQUENCE {			
dl-CarrierFreq	Same downlink EARFCN as used for Cell 28		
ul-CarrierFreq	Not present		
}			
rach-ConfigDedicated SEQUENCE {			
ra-PreambleIndex	63		
ra-PRACH-MaskIndex	0		
}			
}			

Table 8.6.4.4.3.3-19: RRCConnectionReestablishmentRequest (step 24, Table 8.6.4.4.3.2-2)

Derivation Path: 36.508, Table 4.6.1-13			
Information Element	Value/remark	Comment	Condition
RRCConnectionReestablishmentRequest ::= SEQUENCE {			
criticalExtensions CHOICE {			
rrcConnectionReestablishmentRequest-r8			
SEQUENCE {			
ue-Identity SEQUENCE {			
c-RNTI	the value of the C-RNTI of the UE		
physCellId	PhysicalCellIdentity of Cell 4		
shortMAC-I	The same value as the 16 least significant bits of the XMAC-I value calculated by SS.		
}			
reestablishmentCause	handoverFailure		
}			
}			

Table 8.6.4.4.3.3-20: UEInformationResponse (step 33, Table 8.6.4.4.3.2-2)

Derivation Path: 36.508, Table 4.6.1-23B			
Information Element	Value/remark	Comment	Condition
UEInformationResponse-r9 ::= SEQUENCE {			
rrc-TransactionIdentifier	RRC-TransactionIdentifier-UL		
criticalExtensions CHOICE {			
c1 CHOICE{			
ueInformationResponse-r9 SEQUENCE {			
rlf-Report-r9 SEQUENCE {}	Not present		
}			
}			
}			
}			

Table 8.6.4.4.3.3-21: ATTACH ACCEPT for Cell 1 (preamble)

Derivation path: 36.508 Table 4.7.2-1			
Information Element	Value/Remark	Comment	Condition
Equivalent PLMNs	PLMN2		

Table 8.6.4.4.3.3-22: TRACKING AREA UPDATE ACCEPT for Cell 28 (step 30, Table 8.6.4.4.3.2-2)

Derivation path: 36.508 Table 4.7.2-24			
Information Element	Value/Remark	Comment	Condition
Equivalent PLMNs	PLMN1		

8.6.4.5 Radio Link Failure logging / Reporting of ECGI of the PCell

8.6.4.5.1 Test Purpose (TP)

(1)

```

with { UE in RRC_CONNECTED having performed intra-frequency handover and reported that the UE has
radio link failure information available }
ensure that {
  when { UE receives the UEInformationRequest message containing rlf-ReportReq }
  then { UE sends the UEInformationResponse message containing previousPCellId }
}

```

8.6.4.5.2 Conformance requirements

References: The conformance requirements covered in the present TC are specified in: TS 36.331, clause 5.3.7.4, 5.3.7.5, 5.3.11.3 and 5.6.5.3.

[TS 36.331, clause 5.3.7.4]

If the procedure was initiated due to radio link failure or handover failure, the UE shall:

- 1> set the *reestablishmentCellId* in the *VarRLF-Report* to the global cell identity of the selected cell;

[TS 36.331, clause 5.3.7.5]

The UE shall:

...

- 1> set the content of *RRCCConnectionReestablishmentComplete* message as follows:

- 2> if the UE has radio link failure or handover failure information available in *VarRLF-Report* and *plmn-Identity* stored in *VarRLF-Report* is equal to the RPLMN:

- 3> include the *rlf-InfoAvailable*;

...

- 1> submit the *RRCCConnectionReestablishmentComplete* message to lower layers for transmission, upon which the procedure ends;

[TS 36.331, clause 5.3.11.3]

The UE shall:

- 1> upon T310 expiry; or

- 1> upon random access problem indication from MAC while neither T300, T301, T304 nor T311 is running; or

- 1> upon indication from RLC that the maximum number of retransmissions has been reached:

- 2> consider radio link failure to be detected;

- 2> store the following radio link failure information in the *VarRLF-Report* by setting its fields as follows:

- 3> clear the information included in *VarRLF-Report*, if any;

- 3> set the *plmn-Identity* to the RPLMN;

- 3> set the *measResultLastServCell* to include the RSRP and RSRQ, if available, of the PCell based on measurements collected up to the moment the UE detected radio link failure;

- 3> set the *measResultNeighCells* to include the best measured cells, other than the PCell, ordered such that the best cell is listed first, and based on measurements collected up to the moment the UE detected radio link failure, and set its fields as follows;

- 4> if the UE was configured to perform measurements for one or more EUTRA frequencies, include the *measResultListEUTRA*;

- 4> if the UE was configured to perform measurement reporting for one or more neighbouring UTRA frequencies, include the *measResultListUTRA*;

- 4> if the UE was configured to perform measurement reporting for one or more neighbouring GERAN frequencies, include the *measResultListGERAN*;

- 4> if the UE was configured to perform measurement reporting for one or more neighbouring CDMA2000 frequencies, include the *measResultsCDMA2000*;

NOTE: The measured quantities are filtered by the L3 filter as configured in the mobility measurement configuration. The measurements are based on the time domain measurement resource restriction, if configured. Blacklisted cells are not required to be reported.

- 3> if detailed location information is available, set the content of the *locationInfo* as follows:
 - 4> include the *locationCoordinates*;
 - 4> include the *horizontalVelocity*, if available;
- 3> set the *failedPCellId* to the global cell identity, if available, and otherwise to the physical cell identity and carrier frequency of the PCell where radio link failure is detected;
- 3> if an *RRCConnectionReconfiguration* message including the *mobilityControlInfo* was received before the connection failure:
 - 4> include *previousPCellId* and set it to the global cell identity of the PCell where the last *RRCConnectionReconfiguration* including the *mobilityControlInfo* message was received;
 - 4> set the *timeConnFailure* to the elapsed time since reception of the last *RRCConnectionReconfiguration* message including the *mobilityControlInfo*;
- 3> set the *connectionFailureType* to *rlf*;
- 2> if AS security has not been activated:
 - 3> perform the actions upon leaving RRC_CONNECTED as specified in 5.3.12, with release cause 'other';
- 2> else:
 - 3> initiate the connection re-establishment procedure as specified in 5.3.7;

The UE may discard the radio link failure information, i.e. release the UE variable *VarRLF-Report* 48, hours after the radio link failure is detected, upon power off or upon detach.

[TS 36.331, clause 5.6.5.3]

Upon receiving the *UEInformationRequest* message, the UE shall:

...

1> if *rlf-ReportReq* is set to *true* and the UE has radio link failure information or handover failure information available in *VarRLF-Report* and *plmn-Identity* stored in *VarRLF-Report* is equal to the RPLMN, set the *rlf-Report* in the *UEInformationResponse* message to the value of *rlf-Report* in *VarRLF-Report*;

1> if the *rlf-Report* is included in *UEInformationResponse*:

2> discard the *rlf-Report* from *VarRLF-Report* upon successful delivery of the *UEInformationResponse* message confirmed by lower layers.

...

1> if the *logMeasReport* is included in the *UEInformationResponse*:

...

1> else:

2> submit the *UEInformationResponse* message to lower layers for transmission via SRB1;

8.6.4.5.3 Test description

8.6.4.5.3.1 Pre-test conditions

System Simulator:

- Cell 1 and Cell 2

UE:

None.

Preamble:

- The UE is in state Generic RB Established (state 3) on Cell 1 according to [18].

8.6.4.5.3.2 Test procedure sequence

Table 8.6.4.5.3.2-1 illustrates the downlink power levels and other changing parameters to be applied for the cells at various time instants of the test execution. Row marked "T0" denotes the initial conditions after preamble, while columns marked "T1", "T2" and "T3" are to be applied subsequently. The exact instants on which these values shall be applied are described in the texts in this clause.

Table 8.6.4.5.3.2-1: Time instances of cell power level and parameter changes

	Parameter	Unit	Cell 1	Cell 2	Remark
T0	Cell-specific RS EPRE	dBm/15k Hz	-85	-91	The power level values are such that measurement results for Cell 1 (M1) and Cell 2 (M2) satisfy exit condition for event A3 ($M2 < M1$).
T1	Cell-specific RS EPRE	dBm/15k Hz	-85	-79	The power level values are such that measurement results for Cell 1 (M1) and Cell 2 (M2) satisfy entry condition for event A3 ($M2 > M1$).
T2	Cell-specific RS EPRE	dBm/15k Hz	"Off"	"Off"	No Cells are available. (NOTE 1).
T3	Cell-specific RS EPRE	dBm/15k Hz	"Off"	-85	Only Cell 2 is available. (NOTE 1)
NOTE 1: Power level "Off" is defined in TS 36.508 Table 6.2.2.1-1.					

Table 8.6.4.5.3.2-2: Main behaviour

St	Procedure	Message Sequence		TP	Verdict
		U - S	Message		
1	The SS transmits an <i>RRConnectionReconfiguration</i> message to setup intra-frequency measurement on Cell 1.	<--	<i>RRConnectionReconfiguration</i>	-	-
2	The UE transmits an <i>RRConnectionReconfigurationComplete</i> message on Cell 1.	-->	<i>RRConnectionReconfigurationComplete</i>	-	-
3	The SS changes Cell 2 parameter according to the row "T1" in Table 8.6.4.5.3.2-1.	-	-	-	-
4	The UE transmits a <i>MeasurementReport</i> message on Cell 1.	-->	<i>MeasurementReport</i>	-	-
5	The SS transmits an <i>RRConnectionReconfiguration</i> message on Cell 1 to order the UE to perform intra-frequency handover to Cell 2.	<--	<i>RRConnectionReconfiguration</i>	-	-
6	The UE transmits an <i>RRConnectionReconfigurationComplete</i> message on Cell 2.	-->	<i>RRConnectionReconfigurationComplete</i>	-	-
7	The SS changes Cell 1 and Cell 2 parameter according to the row "T2" in Table 8.6.4.5.3.2-1.	-	-	-	-
8	Wait for 5s to ensure that the UE detects T310 expiry.	-	-	-	-
9	The SS changes Cell 2 parameter according to the row "T3" in Table 8.6.4.5.3.2-1.	-	-	-	-
10	The UE transmits an <i>RRConnectionReestablishmentRequest</i> message on Cell 2.	-->	<i>RRConnectionReestablishmentRequest</i>	-	-
11	The SS transmits an <i>RRConnectionReestablishment</i> message on Cell 2.	<--	<i>RRConnectionReestablishment</i>	-	-
12	The UE transmits an <i>RRConnectionReestablishmentComplete</i> message with radio link failure information on Cell 2.	-->	<i>RRConnectionReestablishmentComplete</i>	-	-
13	The SS transmits an <i>RRConnectionReconfiguration</i> message on Cell 2.	<--	<i>RRConnectionReconfiguration</i>	-	-
14	The UE transmits an <i>RRConnectionReconfigurationComplete</i> message on Cell 2.	-->	<i>RRConnectionReconfigurationComplete</i>	-	-
15	The SS transmits a <i>UEInformationRequest</i> message on Cell 2.	<--	<i>UEInformationRequest</i>	-	-
16	Check: Does the UE transmit a <i>UEInformationResponse</i> message on Cell 2?	-->	<i>UEInformationResponse</i>	1	P
17	Check: Does the test result of generic test procedure in TS 36.508 subclause 6.4.2.3 indicate that the UE is in E-UTRA RRC_CONNECTED state on Cell 2?	-	-	1	-

8.6.4.5.3.3 Specific message contents

Table 8.6.4.5.3.3-1: *RRConnectionReconfiguration* (step 1, Table 8.6.4.5.3.2-2)

Derivation Path: 36.508, Table 4.6.1-8, condition MEAS
--

Table 8.6.4.5.3.3-2: MeasConfig (Table 8.6.4.5.3.3-1)

Derivation Path: 36.508, Table 4.6.6-1			
Information Element	Value/remark	Comment	Condition
MeasConfig ::= SEQUENCE {			
measObjectToAddModList SEQUENCE (SIZE (1..maxObjectId)) OF SEQUENCE {	1 entry		
measObjectId[1]	IdMeasObject-f1		
measObject[1]	MeasObjectEUTRA-GENERIC(f1)		
}			
reportConfigToAddModList SEQUENCE (SIZE (1..maxReportConfigId)) OF SEQUENCE {	1 entry		
reportConfigId[1]	IdReportConfig-A3		
reportConfig[1]	ReportConfigEUTRA-A3		
}			
measIdToAddModListSEQUENCE (SIZE (1..maxMeasId)) OF SEQUENCE {			
measId[1]	1		
measObjectId[1]	IdMeasObject-f1		
reportConfigId[1]	IdReportConfig-A3		
}			
}			

Table 8.6.4.5.3.3-3: MeasurementReport (step 4, Table 8.6.4.5.3.2-2)

Derivation Path: 36.508, Table 4.6.1-5			
Information Element	Value/remark	Comment	Condition
MeasurementReport ::= SEQUENCE {			
criticalExtensions CHOICE {			
c1 CHOICE{			
measurementReport-r8 SEQUENCE {			
measResults SEQUENCE {			
measId	1		
measResultPCell SEQUENCE {			
rsrpResult	(0..97)		
rsrqResult	(0..34)		
}			
measResultNeighCells CHOICE {			
measResultListEUTRA SEQUENCE (SIZE (1..maxCellReport)) OF SEQUENCE {	1 entry		
physCellId	PhysicalCellIdentity of Cell 2		
cgi-Info	Not present		
measResult SEQUENCE {			
rsrpResult	(0..97)		
rsrqResult	(0..34)		
additionalSI-Info-r9	Not present		
}			
}			
measResultForECID-r9	Not present		
locationInfo-r10	Not present		
measResultServFreqList-r10	Not present		
}			
}			
}			
}			
}			

Table 8.6.4.5.3.3-4: RRCConnectionReconfiguration (step 5, Table 8.6.4.5.3.2-2)

Derivation Path: 36.508, Table 4.6.1-8, condition HO
--

Table 8.6.4.5.3.3-5: *MobilityControlInfo* (Table 8.6.4.5.3.3-4)

Derivation Path: 36.508, Table 4.6.5-1			
Information Element	Value/remark	Comment	Condition
MobilityControlInfo ::= SEQUENCE {			
targetPhysCellId	PhysicalCellId of Cell 2		
carrierFreq	Not present		
}			

Table 8.6.4.5.3.3-6: *RRCConnectionReestablishmentRequest* (step 10, Table 8.6.4.5.3.2-2)

Derivation Path: 36.508, Table 4.6.1-13			
Information Element	Value/remark	Comment	Condition
RRCConnectionReestablishmentRequest ::= SEQUENCE {			
criticalExtensions CHOICE {			
rrcConnectionReestablishmentRequest-r8			
} SEQUENCE {			
ue-Identity SEQUENCE {			
c-RNTI	the value of the C-RNTI of the UE		
physCellId	PhysicalCellId of Cell 2		
shortMAC-I	The same value as the 16 least significant bits of the XMAC-I value calculated by SS		
}			
reestablishmentCause	otherFailure		
}			

Table 8.6.4.5.3.3-7: *RRCConnectionReestablishmentComplete* (step 12, Table 8.6.4.5.3.2-2)

Derivation Path: 36.508, Table 4.6.1-11			
Information Element	Value/remark	Comment	Condition
RRCConnectionReestablishmentComplete ::= SEQUENCE {			
criticalExtensions CHOICE {			
rrcConnectionReestablishmentComplete-r8 =			
} SEQUENCE {			
nonCriticalExtension SEQUENCE {			
rf-InfoAvailable-r9	true		
nonCriticalExtension	Not present or any allowed value		
}			
}			
}			

Table 8.6.4.5.3.3-8: RRCConnectionReconfiguration (step 13, Table 8.6.4.5.3.2-2)

Derivation Path: 36.508, Table 4.6.1-8			
Information Element	Value/remark	Comment	Condition
RRCConnectionReconfiguration ::= SEQUENCE {			
criticalExtensions CHOICE {			
c1 CHOICE {			
rrcConnectionReconfiguration-r8 SEQUENCE {			
radioResourceConfigDedicated	RadioResourceConfigDe dicated-HO		
}			
}			
}			
}			

Table 8.6.4.5.3.3-9: UEInformationRequest (step 15, Table 8.6.4.5.3.2-2)

Derivation Path: 36.508, Table 4.6.1-23A			
Information Element	Value/remark	Comment	Condition
UEInformationRequest-r9 ::= SEQUENCE {			
criticalExtensions CHOICE {			
c1 CHOICE {			
ueInformationRequest-r9 SEQUENCE {			
rf-ReportReq-r9	TRUE		
}			
}			
}			
}			

Table 8.6.4.5.3.3-10: *UEInformationResponse* (step 16, Table 8.6.4.5.3.2-2)

Derivation Path: 36.508, Table 4.6.1-23B			
Information Element	Value/remark	Comment	Condition
<i>UEInformationResponse</i> -r9 ::=SEQUENCE {			
criticalExtensions CHOICE {			
c1 CHOICE {			
<i>ueInformationResponse</i> -r9 SEQUENCE {			
r1f-Report-r9 SEQUENCE {			
measResultLastServCell-r9 SEQUENCE {			
rsrpResult-r9	(0..97)		
rsrqResult-r9	Not present or (0..34)		
}			
measResultNeighCells-r9	Not present		
locationInfo-r10	Not present or any allowed value		
failedPCellId-r10 CHOICE {	cellGlobalId-r10 or pci-arfcn-r10	If the UE has the global cell identity depending on UE implementation, the UE sets the global cell identity, otherwise the UE sets the physical cell identity and the carrier frequency.	
}			
cellGlobalId-r10 SEQUENCE {			
plmn-Identity	<i>plmn-Identity</i> within <i>SystemInformationBlockType1</i> broadcasted in Cell 2		
cellIdentity	<i>cellIdentity</i> within <i>SystemInformationBlockType1</i> broadcasted in Cell 2		
}			
pci-arfcn-r10 SEQUENCE {			
physCellId-r10	Physical cell Identity of Cell 2		
carrierFreq-r10	Same downlink EARFCN as used for Cell 2		
}			
}			
reestablishmentCellId-r10 SEQUENCE {			
plmn-Identity	<i>plmn-Identity</i> within <i>SystemInformationBlockType1</i> broadcasted in Cell 2		
cellIdentity	<i>cellIdentity</i> within <i>SystemInformationBlockType1</i> broadcasted in Cell 2		
}			
timeConnFailure-r10	Any allowed value		
connectionFailureType-r10	r1f		
previousPCellId-r10 SEQUENCE {			
plmn-Identity	<i>plmn-Identity</i> within <i>SystemInformationBlockType1</i> broadcasted in Cell 1		
cellIdentity	<i>cellIdentity</i> within <i>SystemInformationBlockType1</i> broadcasted in Cell 1		
}			
}			

}			
}			
}			
}			

8.6.4.6 Radio Link Failure logging / Reporting of RLF report availability / PLMN change

8.6.4.6.1 Test Purpose (TP)

(1)

```
with { UE in RRC_CONNECTED having detected radio link failure }
ensure that {
  when { UE moves to the cell that belongs to the PLMN different from the PLMN where the radio link
failure was detected }
  then { UE does not indicate IE rlf-InfoAvailable }
}
```

(2)

```
with { UE in RRC_CONNECTED having detected radio link failure }
ensure that {
  when { UE returns to the cell that belongs to the PLMN where the radio link failure was detected }
  then { UE indicates IE rlf-InfoAvailable }
}
```

8.6.4.6.2 Conformance requirements

References: The conformance requirements covered in the present TC are specified in: TS 36.331, clause 5.3.3.4 and 5.3.11.3.

[TS 36.331, clause 5.3.3.4 (TP1, TP2)]

The UE shall:

...

1> set the content of *RRCConnectionSetupComplete* message as follows:

...

2> if the UE has radio link failure or handover failure information available in *VarRLF-Report* and *plmn-Identity* stored in *VarRLF-Report* is equal to the RPLMN:

3> include *rlf-InfoAvailable*;

...

2> submit the *RRCConnectionSetupComplete* message to lower layers for transmission, upon which the procedure ends;

[TS 36.331, clause 5.3.11.3 (TP1, TP2)]

The UE shall:

1> upon T310 expiry; or

1> upon random access problem indication from MAC while neither T300, T301, T304 nor T311 is running; or

1> upon indication from RLC that the maximum number of retransmissions has been reached:

2> consider radio link failure to be detected;

2> store the following radio link failure information in the *VarRLF-Report* by setting its fields as follows:

3> clear the information included in *VarRLF-Report*, if any;

- 3> set the *plmn-Identity* to the RPLMN;
- 3> set the *measResultLastServCell* to include the RSRP and RSRQ, if available, of the PCell based on measurements collected up to the moment the UE detected radio link failure;
- 3> set the *measResultNeighCells* to include the best measured cells, other than the PCell, ordered such that the best cell is listed first, and based on measurements collected up to the moment the UE detected radio link failure, and set its fields as follows:
 - 4> if the UE was configured to perform measurements for one or more EUTRA frequencies, include the *measResultListEUTRA*;
 - 4> if the UE was configured to perform measurement reporting for one or more neighbouring UTRA frequencies, include the *measResultListUTRA*;
 - 4> if the UE was configured to perform measurement reporting for one or more neighbouring GERAN frequencies, include the *measResultListGERAN*;
 - 4> if the UE was configured to perform measurement reporting for one or more neighbouring CDMA2000 frequencies, include the *measResultsCDMA2000*;

NOTE: The measured quantities are filtered by the L3 filter as configured in the mobility measurement configuration. The measurements are based on the time domain measurement resource restriction, if configured. Blacklisted cells are not required to be reported.

- 3> if detailed location information is available, set the content of the *locationInfo* as follows:
 - 4> include the *locationCoordinates*;
 - 4> include the *horizontalVelocity*, if available;
- 3> set the *failedPCellId* to the global cell identity, if available, and otherwise to the physical cell identity and carrier frequency of the PCell where radio link failure is detected;
- 3> if an *RRCConnectionReconfiguration* message including the *mobilityControlInfo* was received before the connection failure:
 - 4> include *previousPCellId* and set it to the global cell identity of the PCell where the last *RRCConnectionReconfiguration* including the *mobilityControlInfo* message was received;
 - 4> set the *timeConnFailure* to the elapsed time since reception of the last *RRCConnectionReconfiguration* message including the *mobilityControlInfo*;
- 3> set the *connectionFailureType* to *rlf*;
- 2> if AS security has not been activated:
 - 3> perform the actions upon leaving RRC_CONNECTED as specified in 5.3.12, with release cause 'other';
- 2> else:
 - 3> initiate the connection re-establishment procedure as specified in 5.3.7;

The UE may discard the radio link failure information, i.e. release the UE variable *VarRLF-Report* 48, hours after the radio link failure is detected, upon power off or upon detach.

8.6.4.6.3 Test description

8.6.4.6.3.1 Pre-test conditions

System Simulator:

- Cell 1 and Cell 12
- System information combination 3 as defined in TS 36.508 [18] clause 4.4.3.1 is used in E-UTRA cells.

UE:

None.

Preamble:

- The UE is in state Generic RB Established (state 3) on Cell 1 according to [18].

8.6.4.6.3.2 Test procedure sequence

Table 8.6.4.6.3.2-1 illustrates the downlink power levels and other changing parameters to be applied for the cells at various time instants of the test execution. Configurations marked "T1", "T2" and "T3" are applied at the points indicated in the Main behaviour description in Table 8.6.4.6.3.2-2. The exact instants on which these values shall be applied are described in the texts in this clause.

Table 8.6.4.6.3.2-1: Time instances of cell power level and parameter changes

	Parameter	Unit	Cell 1	Cell 12	Remark
T1	Cell-specific RS EPRE	dBm/15k Hz	"Off"	"Off"	No Cells are available. (NOTE 1).
T2	Cell-specific RS EPRE	dBm/15k Hz	"Off"	-85	Only Cell 12 is available. (NOTE 1).
T3	Cell-specific RS EPRE	dBm/15k Hz	-85	"Off"	Only Cell 1 is available. (NOTE 1).
NOTE 1: Power level "Off" is defined in TS36.508 Table 6.2.2.1-1.					

Table 8.6.4.6.3.2-2: Main behaviour

St	Procedure	Message Sequence		TP	Verdict
		U - S	Message		
1	The SS changes Cell 1 parameter according to the row "T1" in Table 8.6.4.6.3.2-1.	-	-	-	-
2	Wait for 15s.	-	-	-	-
3	The SS changes Cell 12 parameter according to the row "T2" in Table 8.6.4.6.3.2-1.	-	-	-	-
4-5	Steps 1 to 2 of the generic test procedure in TS 36.508 [18] subclause 6.4.2.7 are performed on Cell 12.	-	-	-	-
6	Check: Does the UE transmit an <i>RRConnectionSetupComplete</i> message without radio link failure information on Cell 12? This message includes a TRACKING AREA UPDATE REQUEST message.	-->	<i>RRConnectionSetupComplete</i>	1	P
7-9	Steps 4 to 6 of the generic test procedure in TS 36.508 [18] subclause 6.4.2.7 are performed on Cell 12. Note: The UE performs a TAU procedure and the RRC connection is released.	-	-	-	-
10	Wait for 5 s for the UE to enter E-UTRA RRC_IDLE state.	-	-	-	-
11	The SS changes Cell 1 and Cell 12 parameters according to the row "T3" in Table 8.6.4.6.3.2-1.	-	-	-	-
12-13	Steps 1 to 2 of the generic test procedure in TS 36.508 [18] subclause 6.4.2.7 are performed on Cell 1.	-	-	-	-
14	Check: Does the UE transmit an <i>RRConnectionSetupComplete</i> message with radio link failure information on Cell 1? This message includes a TRACKING AREA UPDATE REQUEST message.	-->	<i>RRConnectionSetupComplete</i>	2	P
15-17	Steps 4 to 6 of the generic test procedure in TS 36.508 [18] subclause 6.4.2.7 are performed on Cell 1. Note: The UE performs a TAU procedure and the RRC connection is released.	-	-	-	-
18	Wait for 5 s for the UE to enter E-UTRA RRC_IDLE state.	-	-	-	-
19	Check: Does the test result of generic test procedure in TS 36.508 subclause 6.4.2.2 indicate that the UE is in E-UTRA RRC_IDLE state on Cell 1?	-	-	2	-

8.6.4.6.3.3 Specific message contents

Table 8.6.4.6.3.3-1: RRCConnectionSetupComplete (step 14, Table 8.6.4.6.3.2-2)

Derivation Path: 36.508, Table 4.6.1-18			
Information Element	Value/remark	Comment	Condition
RRCConnectionSetupComplete ::= SEQUENCE {			
criticalExtensions CHOICE {			
c1 CHOICE{			
rrcConnectionSetupComplete-r8 SEQUENCE {			
nonCriticalExtension SEQUENCE {			
nonCriticalExtension SEQUENCE {			
gummei-Type-r10	native		
rlf-InfoAvailable-r10	true		
logMeasAvailable-r10	Not present		
rn-SubframeConfigReq-r10	Not present		
nonCriticalExtension	Not present		
}			
}			
}			
}			
}			
}			
}			

8.6.4.7 Radio Link Failure logging / Location information

8.6.4.7.1 Test Purpose (TP)

(1)

```

with { UE in RRC_CONNECTED having performed the intra-frequency measurement and reported that the UE
has radio link failure information with location information available }
ensure that {
  when { UE receives the UEInformationRequest message containing rlf-ReportReq }
  then { UE sends the UEInformationResponse message containing the measurement result for intra-
frequency neighbour cell including locationCoordinates }
}

```

8.6.4.7.2 Conformance requirements

References: The conformance requirements covered in the present TC are specified in: TS 34.306, clause 4.3.13.2; TS 36.331, clause 5.3.11.3 and 5.6.5.3.

[TS 36.306, clause 4.3.13.2 (TP1)]

standaloneGNSS-Location

This parameter defines whether the UE is equipped with a standalone GNSS receiver that may be used to provide detailed location information in RRC measurement report and logged measurements in RRC_IDLE.

[TS 36.331, clause 5.3.11.3]

The UE shall:

- 1> upon T310 expiry; or
- 1> upon random access problem indication from MAC while neither T300, T301, T304 nor T311 is running; or
- 1> upon indication from RLC that the maximum number of retransmissions has been reached:
 - 2> consider radio link failure to be detected;
 - 2> store the following radio link failure information in the *VarRLF-Report* by setting its fields as follows:
 - 3> clear the information included in *VarRLF-Report*, if any;
 - 3> set the *plmn-Identity* to the RPLMN;

- 3> set the *measResultLastServCell* to include the RSRP and RSRQ, if available, of the PCell based on measurements collected up to the moment the UE detected radio link failure;
- 3> set the *measResultNeighCells* to include the best measured cells, other than the PCell, ordered such that the best cell is listed first, and based on measurements collected up to the moment the UE detected radio link failure, and set its fields as follows:
 - 4> if the UE was configured to perform measurements for one or more EUTRA frequencies, include the *measResultListEUTRA*;
 - 4> if the UE was configured to perform measurement reporting for one or more neighbouring UTRA frequencies, include the *measResultListUTRA*;
 - 4> if the UE was configured to perform measurement reporting for one or more neighbouring GERAN frequencies, include the *measResultListGERAN*;
 - 4> if the UE was configured to perform measurement reporting for one or more neighbouring CDMA2000 frequencies, include the *measResultsCDMA2000*;

NOTE: The measured quantities are filtered by the L3 filter as configured in the mobility measurement configuration. The measurements are based on the time domain measurement resource restriction, if configured. Blacklisted cells are not required to be reported.

- 3> if detailed location information is available, set the content of the *locationInfo* as follows:
 - 4> include the *locationCoordinates*;
 - 4> include the *horizontalVelocity*, if available;
- 3> set the *failedPCellId* to the global cell identity, if available, and otherwise to the physical cell identity and carrier frequency of the PCell where radio link failure is detected;
- 3> if an *RRCConnectionReconfiguration* message including the *mobilityControlInfo* was received before the connection failure:
 - 4> include *previousPCellId* and set it to the global cell identity of the PCell where the last *RRCConnectionReconfiguration* including the *mobilityControlInfo* message was received;
 - 4> set the *timeConnFailure* to the elapsed time since reception of the last *RRCConnectionReconfiguration* message including the *mobilityControlInfo*;
- 3> set the *connectionFailureType* to *rlf*;
- 2> if AS security has not been activated:
 - 3> perform the actions upon leaving RRC_CONNECTED as specified in 5.3.12, with release cause 'other';
- 2> else:
 - 3> initiate the connection re-establishment procedure as specified in 5.3.7;

The UE may discard the radio link failure information, i.e. release the UE variable *VarRLF-Report* 48 hours after the radio link failure is detected.

[TS 36.331, clause 5.6.5.3]

Upon receiving the *UEInformationRequest* message, the UE shall:

...

- 1> if *rlf-ReportReq* is set to *true* and the UE has radio link failure information or handover failure information available in *VarRLF-Report* and *plmn-Identity* stored in *VarRLF-Report* is equal to the RPLMN, set the *rlf-Report* in the *UEInformationResponse* message to the value of *rlf-Report* in *VarRLF-Report*;
- 1> if the *rlf-Report* is included in *UEInformationResponse*:

- 2> discard the *rlf-Report* from *VarRLF-Report* upon successful delivery of the *UEInformationResponse* message confirmed by lower layers.

...

- 1> if the *logMeasReport* is included in the *UEInformationResponse*:

...

- 1> else:

- 2> submit the *UEInformationResponse* message to lower layers for transmission via SRB1;

8.6.4.7.3 Test description

8.6.4.7.3.1 Pre-test conditions

System Simulator:

- Cell 1 and Cell 2

UE: None.

Preamble:

- The UE's positioning engine (e.g. standalone GNSS receiver) should be provided with any necessary stimulus to allow it to provide the position. This shall be done by use of the test function Update UE Location Information defined in TS 36.509 [25], if supported by the UE according to *pc_UpdateUE_LocationInformation*. Otherwise, or in addition any other suitable method may also be used.
- The UE is in state Generic RB Established (state 3) on Cell 1 according to [18].

8.6.4.7.3.2 Test procedure sequence

Same test procedure as specified in 8.6.4.1.3.2 with the following exception:

- The specific message content for the *UEInformationResponse* message in Table 8.6.4.1.3.3-8 is replaced by the specific message content in Table 8.6.4.7.3.3-1.

8.6.4.7.3.3 Specific message contents

Table 8.6.4.7.3.3-1: UEInformationResponse (step 12, Table 8.6.4.1.3.2-2)

Derivation Path: 36.508, Table 4.6.1-23B			
Information Element	Value/remark	Comment	Condition
UEInformationResponse-r9 ::=SEQUENCE {			
criticalExtensions CHOICE {			
c1 CHOICE {			
ueInformationResponse-r9 SEQUENCE {			
rf-Report-r9 SEQUENCE {			
measResultLastServCell-r9 SEQUENCE {			
rsrpResult-r9	(0..97)		
rsrqResult-r9	Not present or (0..34)		
}			
measResultNeighCells-r9 SEQUENCE {			
measResultListEUTRA-r9 SEQUENCE (SIZE (1..maxFreq)) OF SEQUENCE {	1 entry		
carrierFreq-r9[1]	Same downlink EARFCN as used for Cell 2		
measResultList-r9[1] SEQUENCE (SIZE (1..maxCellReport)) OF SEQUENCE {	1 entry		
physCellId[1]	Physical cell Identity of Cell 2		
cgi-Info[1]	Not present		
measResult[1] SEQUENCE {			
rsrpResult	(0..97)		
rsrqResult	(0..34)		
additionalSI-Info-r9	Not present		
}			
}			
measResultListUTRA-r9	Not present		
measResultListGERAN-r9	Not present		
measResultsCDMA2000-r9	Not present		
}			
locationInfo-r10 SEQUENCE {			
locationCoordinates-r10 CHOICE {			
ellipsoid-Point-r10	Any allowed value		
ellipsoidPointWithAltitude-r10	Any allowed value		
}			
failedPCellId-r10 CHOICE {	cellGlobalId-r10 or pci-arfcn-r10	If the UE has the global cell identity depending on UE implementation, the UE sets the global cell identity, otherwise the UE sets the physical cell identity and the carrier frequency.	
cellGlobalId-r10 SEQUENCE {			
plmn-Identity	<i>plmn-Identity</i> within <i>SystemInformationBlockType1</i> broadcasted in Cell 1		
cellIdentity	<i>cellIdentity</i> within <i>SystemInformationBlockType1</i> broadcasted in Cell 1		
}			
pci-arfcn-r10 SEQUENCE {			
physCellId-r10	Physical cell Identity of Cell 1		
carrierFreq-r10	Same downlink EARFCN		

	as used for Cell 1		
}			
}			
reestablishmentCellId-r10 SEQUENCE {			
plmn-Identity	<i>plmn-Identity</i> within <i>SystemInformationBlockType1</i> broadcasted in Cell 2		
cellIdentity	<i>cellIdentity</i> within <i>SystemInformationBlockType1</i> broadcasted in Cell 2		
}			
timeConnFailure-r10	Not present		
connectionFailureType-r10	<i>rlf</i>		
previousPCellId-r10	Not present		
}			
}			
}			
}			
}			

8.6.4.8 Radio Link Failure logging / Logging and reporting / Reporting at RRC connection establishment / PLMN list

8.6.4.8.1 Test Purpose (TP)

(1)

```
with { UE having completed the radio bearer establishment and initial security activation procedure
}
ensure that {
  when { UE detects radio link failure and T311 is expired and camp on a cell belonging to
equivalent PLMN }
  then { UE performs RRC Connection Establishment procedure and sends an
RRCConnectionSetupComplete message with rlf-InfoAvailable }
}
```

(2)

```
with { UE having sent an RRCConnectionSetupComplete message with rlf-InfoAvailable }
ensure that {
  when { UE receives a UEInformationRequest message with rlf-ReportReq set to true }
  then { UE sends a UEInformationResponse message with rlf-Report }
}
```

8.6.4.8.2 Conformance requirements

References: The conformance requirements covered in the present TC are specified in: TS 36.331, clause 5.3.3.4, 5.3.11.3 and 5.6.5.3.

[TS 36.331, clause 5.3.3.4]

The UE shall:

...

1> set the content of *RRCConnectionSetupComplete* message as follows:

...

2> if the UE has radio link failure or handover failure information available in *VarRLF-Report* and if the RPLMN is included in *plmn-IdentityList* stored in *VarRLF-Report*:

3> include *rlf-InfoAvailable*;

[TS 36.331, clause 5.3.11.3]

The UE shall:

- 1> upon T310 expiry; or
- 1> upon random access problem indication from MAC while neither T300, T301, T304 nor T311 is running; or
- 1> upon indication from RLC that the maximum number of retransmissions has been reached:
 - 2> consider radio link failure to be detected;
 - 2> store the following radio link failure information in the *VarRLF-Report* by setting its fields as follows:
 - 3> clear the information included in *VarRLF-Report*, if any;
 - 3> set the *plmn-IdentityList* to include the list of EPLMNs stored by the UE (i.e. includes the RPLMN);
 - 3> set the *measResultLastServCell* to include the RSRP and RSRQ, if available, of the PCell based on measurements collected up to the moment the UE detected radio link failure;
 - 3> set the *measResultNeighCells* to include the best measured cells, other than the PCell, ordered such that the best cell is listed first, and based on measurements collected up to the moment the UE detected radio link failure, and set its fields as follows:
 - 4> if the UE was configured to perform measurements for one or more EUTRA frequencies, include the *measResultListEUTRA*;
 - 4> if the UE was configured to perform measurement reporting for one or more neighbouring UTRA frequencies, include the *measResultListUTRA*;
 - 4> if the UE was configured to perform measurement reporting for one or more neighbouring GERAN frequencies, include the *measResultListGERAN*;
 - 4> if the UE was configured to perform measurement reporting for one or more neighbouring CDMA2000 frequencies, include the *measResultsCDMA2000*;
 - 4> for each neighbour cell included, include the optional fields that are available;
- ...
- 3> if detailed location information is available, set the content of the *locationInfo* as follows:
 - 4> include the *locationCoordinates*;
 - 4> include the *horizontalVelocity*, if available;
- 3> set the *failedPCellId* to the global cell identity, if available, and otherwise to the physical cell identity and carrier frequency of the PCell where radio link failure is detected;
- 3> if an *RRCCONNECTIONRECONFIGURATION* message including the *mobilityControlInfo* was received before the connection failure:
 - 4> if the last *RRCCONNECTIONRECONFIGURATION* message including the *mobilityControlInfo* concerned an intra E-UTRA handover:
 - 5> include the *previousPCellId* and set it to the global cell identity of the PCell where the last *RRCCONNECTIONRECONFIGURATION* message including *mobilityControlInfo* was received;
 - 5> set the *timeConnFailure* to the elapsed time since reception of the last *RRCCONNECTIONRECONFIGURATION* message including the *mobilityControlInfo*;
 - 4> if the last *RRCCONNECTIONRECONFIGURATION* message including the *mobilityControlInfo* concerned a handover to E-UTRA from UTRA and if the UE supports Radio Link Failure Report for Inter-RAT MRO:

- 5> include the *previousUTRA-CellId* and set it to the physical cell identity, the carrier frequency and the global cell identity, if available, of the UTRA Cell in which the last *RRCConnectionReconfiguration* message including *mobilityControlInfo* was received;
- 5> set the *timeConnFailure* to the elapsed time since reception of the last *RRCConnectionReconfiguration* message including the *mobilityControlInfo*;
- 3> set the *connectionFailureType* to *rlf*;
- 3> set the *c-RNTI* to the C-RNTI used in the PCell;
- 3> set the *rlf-Cause* to the trigger for detecting radio link failure;
- 2> if AS security has not been activated:
 - 3> perform the actions upon leaving RRC_CONNECTED as specified in 5.3.12, with release cause 'other';
- 2> else:
 - 3> initiate the connection re-establishment procedure as specified in 5.3.7;

The UE may discard the radio link failure information, i.e. release the UE variable *VarRLF-Report*, 48 hours after the radio link failure is detected, upon power off or upon detach.

[TS 36.331, clause 5.6.5.3]

Upon receiving the *UEInformationRequest* message, the UE shall:

...

- 1> if *rlf-ReportReq* is set to *true* and the UE has radio link failure information or handover failure information available in *VarRLF-Report* and if the RPLMN is included in *plmn-IdentityList* stored in *VarRLF-Report*:
 - 2> set *timeSinceFailure* in *VarRLF-Report* to the time that elapsed since the last radio link or handover failure in E-UTRA;
 - 2> set the *rlf-Report* in the *UEInformationResponse* message to the value of *rlf-Report* in *VarRLF-Report*;
 - 2> discard the *rlf-Report* from *VarRLF-Report* upon successful delivery of the *UEInformationResponse* message confirmed by lower layers;

...

- 1> if the *logMeasReport* is included in the *UEInformationResponse*:

...

- 1> else:
 - 2> submit the *UEInformationResponse* message to lower layers for transmission via SRB1;

8.6.4.8.3 Test description

8.6.4.8.3.1 Pre-test conditions

System Simulator:

- Cell 1 and 12
- System information combination 3 as defined in TS 36.508 [18] clause 4.4.3.1 is used in E-UTRA cells.
- The PLMNs are identified in the test by the identifiers in Table 8.6.4.8.3.1-1.

Table 8.6.4.8.3.1-1: PLMN identifiers

Cell	PLMN name
1	PLMN1
12	PLMN2

UE:

None.

Preamble:

- The UE is registered on PLMN1 (Cell 1) using the procedure described in TS 36.508[18] clause 4.5.2.3 except that the ATTACH ACCEPT message indicates PLMN2 in the Equivalent PLMN list as described in Table 8.6.4.8.3.3-4
- The UE is in state Generic RB Established (State 3) on Cell 1 according to [18].

8.6.4.8.3.2 Test procedure sequence

Table 8.6.4.8.3.2-1 illustrates the downlink power levels and other changing parameters to be applied for the cells at various time instants of the test execution. Row marked "T1" and "T2" are to be applied. The exact instants on which these values shall be applied are described in the texts in this clause.

Table 8.6.4.8.3.2-1: Time instances of cell power level

	Parameter	Unit	Cell 1	Cell 12	Remark
T1	RS EPRE	dBm/15k Hz	"Off"	"Off"	No cell is available (NOTE 1)
T2	RS EPRE	dBm/15k Hz	"Off"	-85	(NOTE 1)

NOTE 1: Power level "Off" is defined in TS 36.508 Table 6.2.2.1-1.

Table 8.6.4.8.3.2-2: Main behaviour

St	Procedure	Message Sequence		TP	Verdict
		U - S	Message		
1	The SS changes Cell 1 parameter according to the row "T1" in Table 8.6.4.8.3.2-1.	-	-	-	-
2	The SS waits for 12s to ensure that the UE detects T311 expiry.	-	-	-	-
3	The SS changes Cell 12 parameter according to the row "T2" in Table 8.6.4.8.3.2-1.	-	-	-	-
4	The UE transmits an <i>RRCCoNNECTIONRequest</i> message on cell 12 to initiate a tracking area update procedure.	-->	<i>RRCCoNNECTIONRequest</i>	-	-
5	The SS transmit an <i>RRCCoNNECTIONSetup</i> message.	<--	<i>RRCCoNNECTIONSetup</i>	-	-
6	The UE transmits an <i>RRCCoNNECTIONSetupComplete</i> message to confirm the successful completion of the connection establishment and a TRACKING AREA UPDATE REQUEST message is sent to update the registration of the actual tracking area. Check: Does the UE send an <i>RRCCoNNECTIONSetupComplete</i> message with <i>rI-f-InfoAvailable</i> on Cell 12?	-->	<i>RRCCoNNECTIONSetupComplete</i> NAS: TRACKING AREA UPDATE REQUEST	1	P
7-9	Steps 4 to 6 of the generic test procedure in TS 36.508 subclause 6.4.2.7 are performed on Cell 12. NOTE: The UE performs a TAU procedure and the RRC connection is released.	-	-	-	-
10-18	Steps 1 to 9 of the generic radio bearer establishment procedure in TS 36.508 subclause 4.5.3.3 are executed to successfully complete the service request procedure on Cell 12.	-	-	-	-
19	The SS sends a <i>UEInformationRequest</i> message to get <i>rI-f-ReportReq</i> on Cell 12.	<--	<i>UEInformationRequest</i>	-	-
20	Check: Does the UE send a <i>UEInformationResponse</i> message with <i>rI-f-Report</i> on Cell 12?	-->	<i>UEInformationResponse</i>	2	P

8.6.4.8.3.3 Specific message contents

Table 8.6.4.8.3.3-1: *RRCCoNNECTIONSetupComplete* (step 6, Table 8.6.4.8.3.2-2)

Derivation Path: 36.508, Table 4.6.1-18			
Information Element	Value/remark	Comment	Condition
<i>RRCCoNNECTIONSetupComplete</i> ::= SEQUENCE {			
criticalExtensions CHOICE {			
c1 CHOICE{			
rrcCoNNECTIONSetupComplete-r8 SEQUENCE {			
nonCriticalExtension SEQUENCE {			
nonCriticalExtension SEQUENCE {			
rI-f-InfoAvailable-r10	true		
nonCriticalExtension SEQUENCE {}	Not present		
}			
}			
}			
}			
}			
}			

Table 8.6.4.8.3.3-2: UEInformationRequest (step 19, Table 8.6.4.8.3.2-2)

Derivation Path: 36.508, Table 4.6.1-23A, condition RLF Report

Table 8.6.4.8.3.3-3: UEInformationResponse (step 20, Table 8.6.4.8.3.2-2)

Derivation Path: 36.508, Table 4.6.1-23B			
Information Element	Value/remark	Comment	Condition
RLF-Report-r9 ::= SEQUENCE {			
measResultLastServCell-r9 SEQUENCE {			
rsrpResult-r9	(0..97)		
rsrqResult-r9	Not present or (0..34)		
}			
measResultNeighCells-r9 SEQUENCE {			
measResultListEUTRA-r9	Not present		
measResultListUTRA-r9	Not present		
measResultListGERAN-r9	Not present		
measResultsCDMA2000-r9	Not present		
}			
locationInfo-r10	Not Present or any allowed value		
failedPCellId-r10 CHOICE {	cellGlobalId-r10 or pci-arfcn-r10	If the UE has the global cell identity depending on UE implementation, the UE sets the global cell identity; otherwise the UE sets the physical cell identity and the carrier frequency.	
cellGlobalId-r10 SEQUENCE {			
plmn-Identity	<i>plmn-Identity</i> within <i>SystemInformationBlockType1</i> broadcasted in Cell 1		
cellIdentity	<i>cellIdentity</i> within <i>SystemInformationBlockType1</i> broadcasted in Cell 1		
}			
pci-arfcn-r10 SEQUENCE {			
physCellId-r10	Physical cell Identity of Cell 1		
carrierFreq-r10	Same downlink EARFCN as used for Cell 1		
}			
timeSinceFailure-r11	Any allowed value		
}			
previousUTRA-CellId-r11	Not present		
selectedUTRA-CellId-r11	Not present		
}			

Table 8.6.4.8.3.3-4: ATTACH ACCEPT for Cell 1 (preamble)

Derivation path: 36.508 Table 4.7.2-1			
Information Element	Value/Remark	Comment	Condition
Equivalent PLMNs	PLMN2		

8.6.4.9 Radio Link Failure logging / Logging and reporting / Reporting at intra LTE handover / PLMN list

8.6.4.9.1 Test Purpose (TP)

(1)

```
with { UE having completed the radio bearer establishment and initial security activation procedure }
ensure that {
  when { UE performs RRC connection re-establishment procedure and intra-LTE handover procedure }
  then { UE sends an RRCCONNECTIONRECONFIGURATIONCOMPLETE message with rlf-InfoAvailable }
}
```

(2)

```
with { UE having sent an RRCCONNECTIONRECONFIGURATIONCOMPLETE message with rlf-InfoAvailable }
ensure that {
  when { UE receives a UEINFORMATIONREQUEST message with rlf-ReportReq set to true }
  then { UE sends a UEINFORMATIONRESPONSE message with rlf-Report and PLMN list }
}
```

8.6.4.9.2 Conformance requirements

References: The conformance requirements covered in the present TC are specified in: TS 36.331, clause 5.3.5.4, 5.3.11.3 and 5.6.5.3.

[TS 36.331, clause 5.3.5.4]

If the *RRCCONNECTIONRECONFIGURATION* message includes the *mobilityControlInfo* and the UE is able to comply with the configuration included in this message, the UE shall:

...

- 1> set the content of *RRCCONNECTIONRECONFIGURATIONCOMPLETE* message as follows:
 - 2> if the UE has radio link failure or handover failure information available in *VarRLF-Report* and if the RPLMN is included in *plmn-IdentityList* stored in *VarRLF-Report*:
 - 3> include *rlf-InfoAvailable*;

[TS 36.331, clause 5.3.11.3]

The UE shall:

- 1> upon T310 expiry; or
- 1> upon random access problem indication from MAC while neither T300, T301, T304 nor T311 is running; or
- 1> upon indication from RLC that the maximum number of retransmissions has been reached:
 - 2> consider radio link failure to be detected;
 - 2> store the following radio link failure information in the *VarRLF-Report* by setting its fields as follows:
 - 3> clear the information included in *VarRLF-Report*, if any;
 - 3> set the *plmn-IdentityList* to include the list of EPLMNs stored by the UE (i.e. includes the RPLMN);
 - 3> set the *measResultLastServCell* to include the RSRP and RSRQ, if available, of the PCell based on measurements collected up to the moment the UE detected radio link failure;
 - 3> set the *measResultNeighCells* to include the best measured cells, other than the PCell, ordered such that the best cell is listed first, and based on measurements collected up to the moment the UE detected radio link failure, and set its fields as follows;
 - 4> if the UE was configured to perform measurements for one or more EUTRA frequencies, include the *measResultListEUTRA*;

- 4> if the UE was configured to perform measurement reporting for one or more neighbouring UTRA frequencies, include the *measResultListUTRA*;
- 4> if the UE was configured to perform measurement reporting for one or more neighbouring GERAN frequencies, include the *measResultListGERAN*;
- 4> if the UE was configured to perform measurement reporting for one or more neighbouring CDMA2000 frequencies, include the *measResultsCDMA2000*;
- 4> for each neighbour cell included, include the optional fields that are available;

...

- 3> if detailed location information is available, set the content of the *locationInfo* as follows:
 - 4> include the *locationCoordinates*;
 - 4> include the *horizontalVelocity*, if available;
- 3> set the *failedPCellId* to the global cell identity, if available, and otherwise to the physical cell identity and carrier frequency of the PCell where radio link failure is detected;
- 3> if an *RRCConnectionReconfiguration* message including the *mobilityControlInfo* was received before the connection failure:
 - 4> if the last *RRCConnectionReconfiguration* message including the *mobilityControlInfo* concerned an intra E-UTRA handover:
 - 5> include the *previousPCellId* and set it to the global cell identity of the PCell where the last *RRCConnectionReconfiguration* message including *mobilityControlInfo* was received;
 - 5> set the *timeConnFailure* to the elapsed time since reception of the last *RRCConnectionReconfiguration* message including the *mobilityControlInfo*;
 - 4> if the last *RRCConnectionReconfiguration* message including the *mobilityControlInfo* concerned a handover to E-UTRA from UTRA and if the UE supports Radio Link Failure Report for Inter-RAT MRO:
 - 5> include the *previousUTRA-CellId* and set it to the physical cell identity, the carrier frequency and the global cell identity, if available, of the UTRA Cell in which the last *RRCConnectionReconfiguration* message including *mobilityControlInfo* was received;
 - 5> set the *timeConnFailure* to the elapsed time since reception of the last *RRCConnectionReconfiguration* message including the *mobilityControlInfo*;
- 3> set the *connectionFailureType* to *rlf*;
- 3> set the *c-RNTI* to the C-RNTI used in the PCell;
- 3> set the *rlf-Cause* to the trigger for detecting radio link failure;
- 2> if AS security has not been activated:
 - 3> perform the actions upon leaving RRC_CONNECTED as specified in 5.3.12, with release cause 'other';
- 2> else:
 - 3> initiate the connection re-establishment procedure as specified in 5.3.7;

The UE may discard the radio link failure information, i.e. release the UE variable *VarRLF-Report*, 48 hours after the radio link failure is detected, upon power off or upon detach.

[TS 36.331, clause 5.6.5.3]

Upon receiving the *UEInformationRequest* message, the UE shall:

...

- 1> if *rlf-ReportReq* is set to *true* and the UE has radio link failure information or handover failure information available in *VarRLF-Report* and if the RPLMN is included in *plmn-IdentityList* stored in *VarRLF-Report*:
- 2> set *timeSinceFailure* in *VarRLF-Report* to the time that elapsed since the last radio link or handover failure in E-UTRA;
- 2> set the *rlf-Report* in the *UEInformationResponse* message to the value of *rlf-Report* in *VarRLF-Report*;
- 2> discard the *rlf-Report* from *VarRLF-Report* upon successful delivery of the *UEInformationResponse* message confirmed by lower layers;

...

- 1> if the *logMeasReport* is included in the *UEInformationResponse*:

...

- 1> else:

- 2> submit the *UEInformationResponse* message to lower layers for transmission via SRB1;

8.6.4.9.3 Test description

8.6.4.9.3.1 Pre-test conditions

System Simulator:

- Cell 1 and 12
- System information combination 3 as defined in TS 36.508 [18] clause 4.4.3.1 is used in E-UTRA cells.
- The PLMNs are identified in the test by the identifiers in Table 8.6.4.9.3.1-1.

Table 8.6.4.9.3.1-1: PLMN identifiers

Cell	PLMN name
1	PLMN1
12	PLMN2

UE:

None.

Preamble:

- The UE is registered on PLMN1 (Cell 1) using the procedure described in TS 36.508[18] clause 4.5.2.3 except that the ATTACH ACCEPT message indicates PLMN2 in the Equivalent PLMN list as described in Table 8.6.4.9.3.3-8.
- The UE is in state Generic RB Established (state 3) on Cell 1 according to [18].

8.6.4.9.3.2 Test procedure sequence

Table 8.6.4.9.3.2-1 illustrates the downlink power levels and other changing parameters to be applied for the cells at various time instants of the test execution. Row marked "T1", "T2" and "T3" are to be applied. The exact instants on which these values shall be applied are described in the texts in this clause.

Table 8.6.4.9.3.2-1: Time instances of cell power level

	Parameter	Unit	Cell 1	Cell 12	Remark
T1	RS EPRE	dBm/15k Hz	"Off"	"Off"	No cell is available (NOTE 1)
T2	RS EPRE	dBm/15k Hz	-85	"Off"	(NOTE 1)
T3	RS EPRE	dBm/15k Hz	-85	-73	The power level values are such that measurement results for Cell 1 (M1) and Cell 12 (M12) satisfy entry condition for event A3 (M12 > M1).
NOTE 1: Power level "Off" is defined in TS 36.508 Table 6.2.2.1-1.					

Table 8.6.4.9.3.2-2: Main behaviour

St	Procedure	Message Sequence		TP	Verdict
		U - S	Message		
1	The SS changes Cell 1 parameter according to the row "T1" in Table 8.6.4.9.3.2-1.	-	-	-	-
2	The SS waits for 3s to ensure that the UE detects T310 expiry.	-	-	-	-
3	The SS changes Cell 1 parameter according to the row "T2" in Table 8.6.4.9.3.2-1.	-	-	-	-
4	The UE transmits an <i>RRCCONNECTIONREESTABLISHMENTREQUEST</i> message on Cell 1.	-->	<i>RRCCONNECTIONREESTABLISHMENTREQUEST</i>	-	-
5	The SS transmits an <i>RRCCONNECTIONREESTABLISHMENT</i> message.	<--	<i>RRCCONNECTIONREESTABLISHMENT</i>	-	-
6	The UE transmits an <i>RRCCONNECTIONREESTABLISHMENTCOMPLETE</i> message on Cell 1.	-->	<i>RRCCONNECTIONREESTABLISHMENTCOMPLETE</i>	-	-
7	The SS transmits an <i>RRCCONNECTIONRECONFIGURATION</i> message to resume existing radio bearer on Cell 1	<--	<i>RRCCONNECTIONRECONFIGURATION</i>	-	-
8	The UE transmits an <i>RRCCONNECTIONRECONFIGURATIONCOMPLETE</i> message on Cell 1.	-->	<i>RRCCONNECTIONRECONFIGURATIONCOMPLETE</i>	-	-
9	The SS changes Cell 1 and Cell 12 parameter according to the row "T3" in Table 8.6.4.9.3.2-1.	-	-	-	-
10	The UE transmits a <i>MEASUREMENTREPORT</i> message on Cell 1 to report event A3 with the measured RSRP, RSRQ value for Cell 12.	-->	<i>MEASUREMENTREPORT</i>	-	-
11	The SS transmits an <i>RRCCONNECTIONRECONFIGURATION</i> message on Cell 1 to order the UE to perform inter frequency handover to Cell 12.	<--	<i>RRCCONNECTIONRECONFIGURATION</i>	-	-
12	Check: Does the UE send an <i>RRCCONNECTIONSETUPCOMPLETE</i> message with <i>rfl-InfoAvailable</i> on Cell 12?	-->	<i>RRCCONNECTIONSETUPCOMPLETE</i>	1	P
13-14	Steps 4 to 5 of the generic test procedure in TS 36.508 subclause 6.4.2.7 are performed on Cell 12. NOTE: The UE performs a TAU procedure.	-	-	-	-
15	The SS sends a <i>UEINFORMATIONREQUEST</i> message to get <i>rfl-ReportReq</i> on Cell 12.	<--	<i>UEINFORMATIONREQUEST</i>	-	-
16	Check: Does the UE send a <i>UEINFORMATIONRESPONSE</i> message with <i>rfl-Report</i> on Cell 12?	-->	<i>UEINFORMATIONRESPONSE</i>	2	P

8.6.4.9.3.3 Specific message contents

Table 8.6.4.9.3.3-1: RRCConnectionReestablishmentRequest (step 4, Table 8.6.4.9.3.2-2)

Derivation Path: 36.508, Table 4.6.1-13			
Information Element	Value/remark	Comment	Condition
RRCConnectionReestablishmentRequest ::= SEQUENCE {			
criticalExtensions CHOICE {			
rrcConnectionReestablishmentRequest-r8 SEQUENCE {			
ue-Identity SEQUENCE {			
c-RNTI	the value of the C-RNTI of the UE		
physCellId	PhysicalCellIdentity of Cell 1		
shortMAC-I	The same value as the 16 least significant bits of the XMAC-I value calculated by SS		
}			
reestablishmentCause	otherFailure		
}			
}			

Table 8.6.4.9.3.3-2: RRCConnectionReconfiguration (step 7, Table 8.6.4.9.3.2-2)

Derivation Path: 36.508, Table 4.6.1-8, condition MEAS			
Information Element	Value/remark	Comment	Condition
RRCConnectionReconfiguration ::= SEQUENCE {			
criticalExtensions CHOICE {			
c1 CHOICE{			
rrcConnectionReconfiguration-r8 SEQUENCE {			
radioResourceConfigDedicated	RadioResourceConfigDedicated-HO		
}			
}			
}			
}			

Table 8.6.4.9.3.3-3: MeasConfig (step 7, Table 8.6.4.9.3.2-2)

Derivation Path: 36.508, Table 4.6.6-1, condition INTER-FREQ			
Information Element	Value/remark	Comment	Condition
MeasConfig ::= SEQUENCE {			
measObjectToAddModList SEQUENCE (SIZE (1..maxObjectId)) OF SEQUENCE {	2 entries		
measObjectId[1]	IdMeasObject-f1		
measObject[1]	MeasObjectEUTRA-GENERIC(f1)		
measObjectId[2]	IdMeasObject-f2		
measObject[2]	MeasObjectEUTRA-GENERIC(f2)		
}			
reportConfigToAddModList SEQUENCE (SIZE (1..maxReportConfigId)) OF SEQUENCE {	1 entry		
reportConfigId[1]	IdReportConfig-A3		
reportConfig[1]	ReportConfigEUTRA-A3		
}			
measIdToAddModListSEQUENCE (SIZE (1..maxMeasId)) OF SEQUENCE {			
measId[1]	1		
measObjectId[1]	IdMeasObject-f2		
reportConfigId[1]	IdReportConfig-A3		
}			
}			

Table 8.6.4.9.3.3-4: MeasurementReport (step 10, Table 8.6.4.9.3.2-2)

Derivation Path: 36.508, Table 4.6.1-5			
Information Element	Value/remark	Comment	Condition
MeasurementReport ::= SEQUENCE {			
criticalExtensions CHOICE {			
c1 CHOICE{			
measurementReport-r8 SEQUENCE {			
measResults SEQUENCE {			
measId	1		
measResultServCell SEQUENCE {			
rsrpResult	(0..97)		
rsrqResult	(0..34)		
}			
measResultNeighCells CHOICE {			
measResultListEUTRA SEQUENCE (SIZE (1..maxCellReport)) OF SEQUENCE {	1 entry		
physCellId[1]	PhysicalCellIdentity of Cell 12		
cgi-Info[1]	Not present		
measResult[1] SEQUENCE {			
rsrpResult	(0..97)		
rsrqResult	(0..34)		
}			
}			
}			
}			
}			
}			

Table 8.6.4.9.3.3-5: RRCConnectionReconfigurationComplete (step 12, Table 8.6.4.9.3.2-2)

Derivation Path: 36.508, Table 4.6.1-9			
Information Element	Value/remark	Comment	Condition
RRCConnectionReconfigurationComplete ::= SEQUENCE {			
criticalExtensions SEQUENCE{			
rrcConnectionReconfigurationComplete-r8 SEQUENCE {			
nonCriticalExtension SEQUENCE {			
nonCriticalExtension SEQUENCE {			
rlf-InfoAvailable-r10	true		
nonCriticalExtension SEQUENCE {}	Not present		
}			
}			
}			
}			
}			

Table 8.6.4.9.3.3-6: UEInformationRequest (step 15, Table 8.6.4.9.3.2-2)

Derivation Path: 36.508, Table 4.6.1-23A, condition RLF Report
--

Table 8.6.4.9.3.3-7: *UEInformationResponse* (step 16, Table 8.6.4.9.3.2-2)

Derivation Path: 36.508, Table 4.6.1-23B			
Information Element	Value/remark	Comment	Condition
<i>UEInformationResponse</i> -r9 ::=SEQUENCE {			
criticalExtensions CHOICE {			
c1 CHOICE {			
<i>ueInformationResponse</i> -r9 SEQUENCE {			
r1f-Report-r9 SEQUENCE {			
measResultLastServCell-r9 SEQUENCE {			
rsrpResult-r9	(0..97)		
rsrqResult-r9	Not present or (0..34)		
}			
measResultNeighCells-r9 SEQUENCE {			
measResultListEUTRA-r9	Not present		
measResultListUTRA-r9	Not present		
measResultListGERAN-r9	Not present		
measResultsCDMA2000-r9	Not present		
}			
locationInfo-r10	Not Present or any allowed value		
failedPCellId-r10 CHOICE {	cellGlobalId-r10 or pci-arfcn-r10	If the UE has the global cell identity depending on UE implementation, the UE sets the global cell identity; otherwise the UE sets the physical cell identity and the carrier frequency.	
cellGlobalId-r10 SEQUENCE {			
plmn-Identity	<i>plmn-Identity</i> within <i>SystemInformationBlockType1</i> broadcasted in Cell 1		
cellIdentity	<i>cellIdentity</i> within <i>SystemInformationBlockType1</i> broadcasted in Cell 1		
}			
pci-arfcn-r10 SEQUENCE {			
physCellId-r10	Physical cell Identity of Cell 1		
carrierFreq-r10	Same downlink EARFCN as used for Cell 1		
}			
reestablishmentCellId-r10 SEQUENCE {			
plmn-Identity	<i>plmn-Identity</i> within <i>SystemInformationBlockType1</i> broadcasted in Cell 1		
cellIdentity	<i>cellIdentity</i> within <i>SystemInformationBlockType1</i> broadcasted in Cell 1		
}			
timeConnFailure-r10	Any allowed value		
connectionFailureType-r10	r1f		
previousPCellId-r10	Not present		
failedPCellId-v1090	Not present or any allowed value		
basicFields-r11SEQUENCE {			

c-RNTI-r11	Any allowed value		
rlf-Cause-r11	t310-Expiry		
timeSinceFailure-r11	Any allowed value		
}			
previousUTRA-CellId-r11	Not present		
selectedUTRA-CellId-r11	Not present		
}			
}			
}			

Table 8.6.4.9.3.3-8: ATTACH ACCEPT for Cell 1 (preamble)

Derivation path: 36.508 Table 4.7.2-1			
Information Element	Value/Remark	Comment	Condition
Equivalent PLMNs	PLMN2		

8.6.4.10 Radio Link Failure logging / Logging and reporting / Reporting at RRC connection re-establishment / PLMN list

8.6.4.10.1 Test Purpose (TP)

(1)

```
with { UE having completed the radio bearer establishment and initial security activation procedure }
ensure that {
  when { UE detects T310 is expired and performs RRC Connection re-establishment procedure on a cell
    belonging to equivalent PLMN }
    then { UE sends an RRCConnectionReestablishmentComplete message with rlf-InfoAvailable }
}
```

(2)

```
with { UE having sent an RRCConnectionReestablishmentComplete message with rlf-InfoAvailable }
ensure that {
  when { UE receives a UEInformationRequest message with rlf-ReportReq set to true }
    then { UE sends a UEInformationResponse message with rlf-Report and PLMN list }
}
```

8.6.4.10.2 Conformance requirements

References: The conformance requirements covered in the present TC are specified in: TS 36.331, clause 5.3.7.5, 5.3.11.3 and 5.6.5.3.

[TS 36.331, clause 5.3.7.5]

The UE shall:

...

- 1> set the content of *RRCConnectionReestablishmentComplete* message as follows:
 - 2> if the UE has radio link failure or handover failure information available in *VarRLF-Report* and if the RPLMN is included in *plmn-IdentityList* stored in *VarRLF-Report*:
 - 3> include the *rlf-InfoAvailable*;

[TS 36.331, clause 5.3.11.3]

The UE shall:

- 1> upon T310 expiry; or
- 1> upon random access problem indication from MAC while neither T300, T301, T304 nor T311 is running; or
- 1> upon indication from RLC that the maximum number of retransmissions has been reached:

- 2> consider radio link failure to be detected;
- 2> store the following radio link failure information in the *VarRLF-Report* by setting its fields as follows:
 - 3> clear the information included in *VarRLF-Report*, if any;
 - 3> set the *plmn-IdentityList* to include the list of EPLMNs stored by the UE (i.e. includes the RPLMN);
 - 3> set the *measResultLastServCell* to include the RSRP and RSRQ, if available, of the PCell based on measurements collected up to the moment the UE detected radio link failure;
 - 3> set the *measResultNeighCells* to include the best measured cells, other than the PCell, ordered such that the best cell is listed first, and based on measurements collected up to the moment the UE detected radio link failure, and set its fields as follows:
 - 4> if the UE was configured to perform measurements for one or more EUTRA frequencies, include the *measResultListEUTRA*;
 - 4> if the UE was configured to perform measurement reporting for one or more neighbouring UTRA frequencies, include the *measResultListUTRA*;
 - 4> if the UE was configured to perform measurement reporting for one or more neighbouring GERAN frequencies, include the *measResultListGERAN*;
 - 4> if the UE was configured to perform measurement reporting for one or more neighbouring CDMA2000 frequencies, include the *measResultsCDMA2000*;
 - 4> for each neighbour cell included, include the optional fields that are available;
- ...
- 3> if detailed location information is available, set the content of the *locationInfo* as follows:
 - 4> include the *locationCoordinates*;
 - 4> include the *horizontalVelocity*, if available;
- 3> set the *failedPCellId* to the global cell identity, if available, and otherwise to the physical cell identity and carrier frequency of the PCell where radio link failure is detected;
- 3> if an *RRCCONNECTIONRECONFIGURATION* message including the *mobilityControlInfo* was received before the connection failure:
 - 4> if the last *RRCCONNECTIONRECONFIGURATION* message including the *mobilityControlInfo* concerned an intra E-UTRA handover:
 - 5> include the *previousPCellId* and set it to the global cell identity of the PCell where the last *RRCCONNECTIONRECONFIGURATION* message including *mobilityControlInfo* was received;
 - 5> set the *timeConnFailure* to the elapsed time since reception of the last *RRCCONNECTIONRECONFIGURATION* message including the *mobilityControlInfo*;
 - 4> if the last *RRCCONNECTIONRECONFIGURATION* message including the *mobilityControlInfo* concerned a handover to E-UTRA from UTRA and if the UE supports Radio Link Failure Report for Inter-RAT MRO:
 - 5> include the *previousUTRA-CellId* and set it to the physical cell identity, the carrier frequency and the global cell identity, if available, of the UTRA Cell in which the last *RRCCONNECTIONRECONFIGURATION* message including *mobilityControlInfo* was received;
 - 5> set the *timeConnFailure* to the elapsed time since reception of the last *RRCCONNECTIONRECONFIGURATION* message including the *mobilityControlInfo*;
- 3> set the *connectionFailureType* to *rlf*;
- 3> set the *c-RNTI* to the C-RNTI used in the PCell;

- 3> set the *rlf-Cause* to the trigger for detecting radio link failure;
- 2> if AS security has not been activated:
 - 3> perform the actions upon leaving RRC_CONNECTED as specified in 5.3.12, with release cause 'other';
- 2> else:
 - 3> initiate the connection re-establishment procedure as specified in 5.3.7;

The UE may discard the radio link failure information, i.e. release the UE variable *VarRLF-Report*, 48 hours after the radio link failure is detected, upon power off or upon detach.

[TS 36.331, clause 5.6.5.3]

Upon receiving the *UEInformationRequest* message, the UE shall:

...

- 1> if *rlf-ReportReq* is set to *true* and the UE has radio link failure information or handover failure information available in *VarRLF-Report* and if the RPLMN is included in *plmn-IdentityList* stored in *VarRLF-Report*:
 - 2> set *timeSinceFailure* in *VarRLF-Report* to the time that elapsed since the last radio link or handover failure in E-UTRA;
 - 2> set the *rlf-Report* in the *UEInformationResponse* message to the value of *rlf-Report* in *VarRLF-Report*;
 - 2> discard the *rlf-Report* from *VarRLF-Report* upon successful delivery of the *UEInformationResponse* message confirmed by lower layers;

...

- 1> if the *logMeasReport* is included in the *UEInformationResponse*:

...

- 1> else:
 - 2> submit the *UEInformationResponse* message to lower layers for transmission via SRB1;

8.6.4.10.3 Test description

8.6.4.10.3.1 Pre-test conditions

System Simulator:

- Cell 1 and 12
- System information combination 3 as defined in TS 36.508 [18] clause 4.4.3.1 is used in E-UTRA cells.
- The PLMNs are identified in the test by the identifiers in Table 8.6.4.8.3.1-1.

Table 8.6.4.10.3.1-1: PLMN identifiers

Cell	PLMN name
1	PLMN1
12	PLMN2

UE:

None.

Preamble:

- The UE is registered on PLMN1 (Cell 1) using the procedure described in TS 36.508[18] clause 4.5.2.3 except that the ATTACH ACCEPT message indicates PLMN2 in the Equivalent PLMN list as described in Table 8.6.4.10.3.3-4
- The UE is in state Generic RB Established (state 3) on Cell 1 according to [18].

8.6.4.10.3.2 Test procedure sequence

Table 8.6.4.8.3.2-1 illustrates the downlink power levels and other changing parameters to be applied for the cells at various time instants of the test execution. Row marked "T1" and "T2" are to be applied. The exact instants on which these values shall be applied are described in the texts in this clause.

Table 8.6.4.10.3.2-1: Time instances of cell power level

	Parameter	Unit	Cell 1	Cell 12	Remark
T1	RS EPRE	dBm/15k Hz	"Off"	"Off"	No cell is available (NOTE 1)
T2	RS EPRE	dBm/15k Hz	"Off"	-85	(NOTE 1)
NOTE 1: Power level "Off" is defined in TS 36.508 Table 6.2.2.1-1.					

Table 8.6.4.10.3.2-2: Main behaviour

St	Procedure	Message Sequence		TP	Verdict
		U - S	Message		
1	The SS changes Cell 1 parameter according to the row "T1" in Table 8.6.4.10.3.2-1.	-	-	-	-
2	The SS waits for 3s to ensure that the UE detects T310 expiry.	-	-	-	-
3	The SS changes Cell 1 parameter according to the row "T2" in Table 8.6.4.10.3.2-1.	-	-	-	-
4	The UE transmits an <i>RRCCONNECTIONREESTABLISHMENTREQUEST</i> message on Cell 12.	-->	<i>RRCCONNECTIONREESTABLISHMENTREQUEST</i>	-	-
5	The SS transmits an <i>RRCCONNECTIONREESTABLISHMENT</i> message.	<--	<i>RRCCONNECTIONREESTABLISHMENT</i>	-	-
6	Check: Does the UE send an <i>RRCCONNECTIONREESTABLISHMENTCOMPLETE</i> message with <i>rlf-InfoAvailable</i> on Cell 12?	-->	<i>RRCCONNECTIONREESTABLISHMENTCOMPLETE</i>	1	P
7	The SS transmits an <i>RRCCONNECTIONRECONFIGURATION</i> message to resume existing radio bearer on Cell 12	<--	<i>RRCCONNECTIONRECONFIGURATION</i>	-	-
8	The UE transmits an <i>RRCCONNECTIONRECONFIGURATIONCOMPLETE</i> message on Cell 12.	-->	<i>RRCCONNECTIONRECONFIGURATIONCOMPLETE</i>	-	-
7	The SS sends a <i>UEINFORMATIONREQUEST</i> message to get <i>rlf-ReportReq</i> on Cell 12.	<--	<i>UEINFORMATIONREQUEST</i>	-	-
8	Check: Does the UE send a <i>UEINFORMATIONRESPONSE</i> message with <i>rlf-Report</i> on Cell 12?	-->	<i>UEINFORMATIONRESPONSE</i>	2	P

8.6.4.10.3.3 Specific message contents

Table 8.6.4.10.3.3-1: RRCConnectionReestablishmentComplete (step 6, Table 8.6.4.10.3.2-2)

Derivation Path: 36.508, Table 4.6.1-11			
Information Element	Value/remark	Comment	Condition
RRCConnectionReestablishmentComplete ::= SEQUENCE {			
criticalExtensions CHOICE {			
c1 CHOICE{			
rrcConnectionReestablishmentComplete-r8			
SEQUENCE {			
nonCriticalExtension SEQUENCE {			
rif-InfoAvailable-r9	true		
nonCriticalExtension SEQUENCE {}	Not present		
}			
}			
}			
}			

Table 8.6.4.10.3.3-2: UEInformationRequest (step 7, Table 8.6.4.10.3.2-2)

Derivation Path: 36.508, Table 4.6.1-23A, condition RLF

Table 8.6.4.10.3.3-3: *UEInformationResponse* (step 8, Table 8.6.4.10.3.2-2)

Derivation Path: 36.508, Table 4.6.1-23B			
Information Element	Value/remark	Comment	Condition
<i>UEInformationResponse</i> -r9 ::=SEQUENCE {			
criticalExtensions CHOICE {			
c1 CHOICE {			
<i>ueInformationResponse</i> -r9 SEQUENCE {			
RLF-Report-r9 ::= SEQUENCE {			
measResultLastServCell-r9 SEQUENCE {			
rsrpResult-r9	(0..97)		
rsrqResult-r9	Not present or (0..34)		
}			
measResultNeighCells-r9 SEQUENCE {			
measResultListEUTRA-r9	Not present		
measResultListUTRA-r9	Not present		
measResultListGERAN-r9	Not present		
measResultsCDMA2000-r9	Not present		
}			
locationInfo-r10	Not Present or any allowed value		
failedPCellId-r10 CHOICE {	cellGlobalId-r10 or pci-arfcn-r10	If the UE has the global cell identity depending on UE implementation, the UE sets the global cell identity; otherwise the UE sets the physical cell identity and the carrier frequency.	
cellGlobalId-r10 SEQUENCE {			
plmn-Identity	<i>plmn-Identity</i> within <i>SystemInformationBlockType1</i> broadcasted in Cell 1		
cellIdentity	<i>cellIdentity</i> within <i>SystemInformationBlockType1</i> broadcasted in Cell 1		
}			
pci-arfcn-r10 SEQUENCE {			
physCellId-r10	Physical cell Identity of Cell 1		
carrierFreq-r10	Same downlink EARFCN as used for Cell 1		
}			
reestablishmentCellId-r10 SEQUENCE {			
plmn-Identity	<i>plmn-Identity</i> within <i>SystemInformationBlockType1</i> broadcasted in Cell 12		
cellIdentity	<i>cellIdentity</i> within <i>SystemInformationBlockType1</i> broadcasted in Cell 12		
}			
connectionFailureType-r10	rlf		
previousPCellId-r10	Not present or any allowed value		
failedPCellId-v1090	Not present or any allowed value		
basicFields-r11SEQUENCE {			

c-RNTI-r11	Any allowed value		
rlf-Cause-r11	t310-Expiry		
timeSinceFailure-r11	Any allowed value		
}			
previousUTRA-CellId-r11	Not present		
selectedUTRA-CellId-r11	Not present		
}			
}			
}			
}			

Table 8.6.4.10.3.3-4: ATTACH ACCEPT for Cell 1 (preamble)

Derivation path: 36.508 Table 4.7.2-1			
Information Element	Value/Remark	Comment	Condition
Equivalent PLMNs	PLMN2		

8.6.5 Inter-RAT Logged Radio Link Failure

8.6.5.1 Radio Link Failure logging / Reporting at UTRAN Inter-RAT handover

8.6.5.1.1 Test Purpose (TP)

(1)

```
with { UE selects the UTRAN cell and enters UTRA CELL_DCH(PS-DCCH+DTCH_DCH) after detection of radio link failure in an E-UTRAN cell }
ensure that {
  when { UE receives a HANDOVER FROM UTRAN COMMAND message including the eutra-Message }
  then { UE transmits an RRCConnectionReconfigurationComplete message containing rlf-InfoAvailable and enters E-UTRA RRC_CONNECTED state }
}
```

(2)

```
with { UE in RRC_CONNECTED having reported that the UE has radio link failure information available }
ensure that {
  when { UE receives the UEInformationRequest message containing rlf-ReportReq }
  then { UE sends the UEInformationResponse message containing the measurement result for UTRA neighbour cell }
}
```

8.6.5.1.2 Conformance requirements

References: The conformance requirements covered in the present TC are specified in: TS 36.331, clause 5.3.11.3, 5.4.2.3 and 5.6.5.3.

[TS 36.331, clause 5.3.11.3 (TP1, TP2)]

The UE shall:

- 1> upon T310 expiry; or
- 1> upon random access problem indication from MAC while neither T300, T301, T304 nor T311 is running; or
- 1> upon indication from RLC that the maximum number of retransmissions has been reached:
 - 2> consider radio link failure to be detected;
 - 2> store the following radio link failure information in the *VarRLF-Report* by setting its fields as follows:
 - 3> clear the information included in *VarRLF-Report*, if any;
 - 3> set the *plmn-Identity* to the RPLMN;

- 3> set the *measResultLastServCell* to include the RSRP and RSRQ, if available, of the PCell based on measurements collected up to the moment the UE detected radio link failure;
- 3> set the *measResultNeighCells* to include the best measured cells, other than the PCell, ordered such that the best cell is listed first, and based on measurements collected up to the moment the UE detected radio link failure, and set its fields as follows:
 - 4> if the UE was configured to perform measurements for one or more EUTRA frequencies, include the *measResultListEUTRA*;
 - 4> if the UE was configured to perform measurement reporting for one or more neighbouring UTRA frequencies, include the *measResultListUTRA*;
 - 4> if the UE was configured to perform measurement reporting for one or more neighbouring GERAN frequencies, include the *measResultListGERAN*;
 - 4> if the UE was configured to perform measurement reporting for one or more neighbouring CDMA2000 frequencies, include the *measResultsCDMA2000*;

NOTE: The measured quantities are filtered by the L3 filter as configured in the mobility measurement configuration. The measurements are based on the time domain measurement resource restriction, if configured. Blacklisted cells are not required to be reported.

- 3> if detailed location information is available, set the content of the *locationInfo* as follows:
 - 4> include the *locationCoordinates*;
 - 4> include the *horizontalVelocity*, if available;
- 3> set the *failedPCellId* to the global cell identity, if available, and otherwise to the physical cell identity and carrier frequency of the PCell where radio link failure is detected;
- 3> if an *RRCCONNECTIONRECONFIGURATION* message including the *mobilityControlInfo* was received before the connection failure:
 - 4> include *previousPCellId* and set it to the global cell identity of the PCell where the last *RRCCONNECTIONRECONFIGURATION* including the *mobilityControlInfo* message was received;
 - 4> set the *timeConnFailure* to the elapsed time since reception of the last *RRCCONNECTIONRECONFIGURATION* message including the *mobilityControlInfo*;
- 3> set the *connectionFailureType* to *rlf*;
- 2> if AS security has not been activated:
 - 3> perform the actions upon leaving RRC_CONNECTED as specified in 5.3.12, with release cause 'other';
- 2> else:
 - 3> initiate the connection re-establishment procedure as specified in 5.3.7;

The UE may discard the radio link failure information, i.e. release the UE variable *VarRLF-Report* 48, hours after the radio link failure is detected, upon power off or upon detach.

[TS 36.331, clause 5.4.2.3 (TP1)]

If the UE is able to comply with the configuration included in the *RRCCONNECTIONRECONFIGURATION* message, the UE shall:

...

- 1> set the content of *RRCCONNECTIONRECONFIGURATIONCOMPLETE* message as follows:
 - 2> if the UE has radio link failure or handover failure information available in *VarRLF-Report* and *plmn-Identity* stored in *VarRLF-Report* is equal to the RPLMN:
 - 3> include *rlf-InfoAvailable*;

[TS 36.331, clause 5.6.5.3 (TP2)]

Upon receiving the *UEInformationRequest* message, the UE shall:

...

1> if *rlf-ReportReq* is set to *true* and the UE has radio link failure information or handover failure information available in *VarRLF-Report* and *plmn-Identity* stored in *VarRLF-Report* is equal to the RPLMN, set the *rlf-Report* in the *UEInformationResponse* message to the value of *rlf-Report* in *VarRLF-Report*;

1> if the *rlf-Report* is included in *UEInformationResponse*:

2> discard the *rlf-Report* from *VarRLF-Report* upon successful delivery of the *UEInformationResponse* message confirmed by lower layers.

...

1> if the *logMeasReport* is included in the *UEInformationResponse*:

...

1> else:

2> submit the *UEInformationResponse* message to lower layers for transmission via SRB1;

8.6.5.1.3 Test description

8.6.5.1.3.1 Pre-test conditions

System Simulator:

- Cell 1 and Cell 5
- System information combination 4 as defined in TS 36.508 [18] clause 4.4.3.1 is used in E-UTRA cell.

UE:

None.

Preamble:

- The UE is in state Generic RB Established (state 3) on Cell 1 according to [18].

8.6.5.1.3.2 Test procedure sequence

Table 8.6.5.1.3.2-1 illustrates the downlink power levels and other changing parameters to be applied for the cells at various time instants of the test execution. Configurations marked "T1", "T2" and "T3" are applied at the points indicated in the Main behaviour description in Table 8.6.5.1.3.2-2. The exact instants on which these values shall be applied are described in the texts in this clause.

Table 8.6.5.1.3.2-1: Time instances of cell power level and parameter changes

	Parameter	Unit	Cell 1	Cell 5	Remark
T1	Cell-specific RS EPRE	dBm/15kHz	-80	-	The power level values are such that entering conditions for event B2 are satisfied.
	CPICH Ec (UTRA FDD)	dBm/3.84MHz	-	-70	
	PCCPCH Ec (UTRA LCR TDD)	dBm/1.28 MHz	-	-70	
T2	Cell-specific RS EPRE	dBm/15kHz	"Off"	-	Only Cell 5 is available. (NOTE 1)
	CPICH Ec (UTRA FDD)	dBm/3.84MHz	-	-70	
	PCCPCH Ec (UTRA LCR TDD)	dBm/1.28 MHz	-	-70	
T3	Cell-specific RS EPRE	dBm/15kHz	-70	-	The power level values are such that entering conditions for event 3a are satisfied.
	CPICH Ec (UTRA FDD)	dBm/3.84MHz	-	-100	
	PCCPCH Ec (UTRA LCR TDD)	dBm/1.28 MHz	-	-100	
NOTE 1: Power level "Off" for E-UTRA cell is defined in TS 36.508 Table 6.2.2.1-1.					

Table 8.6.5.1.3.2-2: Main behaviour

St	Procedure	Message Sequence		TP	Verdict
		U - S	Message		
1	The SS transmits an <i>RRConnectionReconfiguration</i> message to setup inter-RAT measurement on Cell 1.	<--	<i>RRConnectionReconfiguration</i>	-	-
2	The UE transmits an <i>RRConnectionReconfigurationComplete</i> message on Cell 1.	-->	<i>RRConnectionReconfigurationComplete</i>	-	-
3	The SS changes Cell 1 and Cell 5 parameters according to the row "T1" in Table 8.6.5.1.3.2-1.	-	-	-	-
4	The UE transmits a <i>MeasurementReport</i> message on Cell 1.	-->	<i>MeasurementReport</i>	-	-
5	The SS changes Cell 1 parameter according to the row "T2" in Table 8.6.5.1.3.2-1.	-	-	-	-
6	Generic test procedure in TS 36.508 subclause 6.4.2.8 is performed on Cell 5. NOTE: The UE performs an RAU procedure and the RRC connection is released.	-	-	-	-
7-11	Step 7 to 11 of test procedure in TS 34.123-1 subclause 12.9.14.4 is performed on Cell 5 using the UTRA reference radio bearer parameters and combination "UTRA PS RB" according to TS 36.508 subclause 4.8.3 and Table 4.8.3-1. NOTE: The UE performs NW initiated RAB re-establishment in a UTRAN cell.	-	-	-	-
-	For UTRAN FDD, EXCEPTION: Steps 12a1 to 12a2 describe behaviour that depends on the UE capability; the "lower case letter" identifies a step sequence that takes place if a capability is supported. For UTRAN TDD, goto Step 13.	-	-	-	-
12a1	IF <i>pc_UTRA_CompressedModeRequired</i> THEN the SS transmits a PHYSICAL CHANNEL RECONFIGURATION message on Cell 5 including the DPCH compressed mode info.	<--	PHYSICAL CHANNEL RECONFIGURATION	-	-
12a2	The UE transmits a PHYSICAL CHANNEL RECONFIGURATION COMPLETE message on Cell 5.	-->	PHYSICAL CHANNEL RECONFIGURATION COMPLETE	-	-
13	The SS transmits a MEASUREMENT CONTROL message to setup inter-RAT measurement on Cell 5.	<--	MEASUREMENT CONTROL	-	-
14	The SS changes Cell 1 and Cell 5 parameters according to the row "T3" in Table 8.6.5.1.3.2-1.	-	-	-	-
15	The UE transmits a MEASUREMENT REPORT message on Cell 5 including the E-UTRA event results.	-->	MEASUREMENT REPORT	-	-
16	The SS transmits a HANDOVER FROM UTRAN COMMAND message on Cell 5.	<--	HANDOVER FROM UTRAN COMMAND	-	-
17	Check: Does the UE transmit an <i>RRConnectionReconfigurationComplete</i> message with radio link failure information on Cell 1?	-->	<i>RRConnectionReconfigurationComplete</i>	1	P
18	Generic test procedure in TS 36.508 subclause 6.4.2.10 is performed on Cell 1. NOTE: The UE performs tracking area updating procedure without ISR and security reconfiguration after successful completion of handover from UTRA.	-	-	-	-
19	The SS transmits a <i>UEInformationRequest</i> message on Cell 1.	<--	<i>UEInformationRequest</i>	-	-
20	Check: Does the UE transmit a	-->	<i>UEInformationResponse</i>	2	P

	<i>UEInformationResponse</i> message on Cell 1?				
21	Check: Does the test result of generic test procedure in TS 36.508 subclause 6.4.2.3 indicate that the UE is in E-UTRA RRC_CONNECTED state on Cell 1?	-	-	2	-

8.6.5.1.3.3 Specific message contents

Table 8.6.5.1.3.3-1: *RRCConnectionReconfiguration* (step 1, Table 8.6.5.1.3.2-2)

Derivation Path: 36.508, Table 4.6.1-8, condition MEAS

Table 8.6.5.1.3.3-2: *MeasConfig* (Table 8.6.5.1.3.3-1)

Derivation Path: 36.508, Table 4.6.6-1, condition UTRAN			
Information Element	Value/remark	Comment	Condition
<i>MeasConfig</i> ::= SEQUENCE {			
<i>measObjectToAddModList</i> SEQUENCE (SIZE (1..maxObjectld)) OF SEQUENCE {	2 entries		
<i>measObjectld</i> [1]	IdMeasObject-f1		
<i>measObject</i> [1]	MeasObjectEUTRA-GENERIC(f1)		
<i>measObjectld</i> [2]	IdMeasObject-f8		
<i>measObject</i> [2]	MeasObjectUTRA-f8		
}			
<i>reportConfigToAddModList</i> SEQUENCE (SIZE (1..maxReportConfigld)) OF SEQUENCE {	1 entry		
<i>reportConfigld</i> [1]	IdReportConfig-B2-UTRA		
<i>reportConfig</i> [1]	ReportConfigInterRAT-B2-UTRA(-92, -82)		
}			
<i>measIdToAddModList</i> SEQUENCE (SIZE (1..maxMeasld)) OF SEQUENCE {	1 entry		
<i>measld</i> [1]	1		
<i>measObjectld</i> [1]	IdMeasObject-f8		
<i>reportConfigld</i> [1]	IdReportConfig-B2-UTRA		
}			
}			

Condition	Explanation
UTRA-FDD	UTRA FDD cell environment
UTRA-TDD	UTRA TDD cell environment

Table 8.6.5.1.3.3-3: *QuantityConfig* (Table 8.6.5.1.3.3-2)

Derivation Path: 36.508, Table 4.6.6-3A, condition UTRAN			
Information Element	Value/remark	Comment	Condition
<i>QuantityConfig</i> ::= SEQUENCE {			
<i>quantityConfigUTRA</i> SEQUENCE {			
<i>measQuantityUTRA-FDD</i>	cpich-RSCP		UTRA-FDD
<i>measQuantityUTRA-TDD</i>	pccpch-RSCP		UTRA-TDD
<i>filterCoefficient</i>	fc0		
}			
<i>quantityConfigUTRA-v1020</i>	Not present		
}			

Condition	Explanation
UTRA-FDD	UTRA FDD cell environment
UTRA-TDD	UTRA TDD cell environment

Table 8.6.5.1.3.3-4: MeasObjectUTRA-f8 (Table 8.6.5.1.3.3-2)

Derivation Path: 36.508, Table 4.6.6-3			
Information Element	Value/remark	Comment	Condition
MeasObjectUTRA ::= SEQUENCE {			
carrierFreq	Same downlink ARFCN as used for Cell 5		
cellsToAddModList CHOICE {			
cellsToAddModListUTRA-FDD SEQUENCE (SIZE (1..maxCellMeas)) OF SEQUENCE {			UTRA-FDD
cellIndex[1]	1		
physCellId[1]	PhysicalCellIdentity of Cell 5		
}			
cellsToAddModListUTRA-TDD SEQUENCE (SIZE (1..maxCellMeas)) OF SEQUENCE {			UTRA-TDD
cellIndex[1]	1		
physCellId[1]	PhysicalCellIdentity of Cell 5		
}			
}			
csg-allowedReportingCells-v930	Not present		
}			

Condition	Explanation
UTRA-FDD	UTRA FDD cell environment
UTRA-TDD	UTRA TDD cell environment

Table 8.6.5.1.3.3-8: *MobilityControlInfo* (Table 8.6.5.1.3.3-7)

Derivation Path: 36.508, Table 4.6.5-1			
Information Element	Value/remark	Comment	Condition
MobilityControlInfo ::= SEQUENCE {			
targetPhysCellId	PhysicalCellIdentity of Cell 1.		
carrierFreq SEQUENCE {			
dl-CarrierFreq	Same downlink EARFCN as used for Cell 1.		
ul-CarrierFreq	Not present		
}			
carrierBandwidth SEQUENCE {			
dl-Bandwidth	Same downlink system bandwidth as used for Cell 1		
ul-Bandwidth	Same uplink system bandwidth as used for Cell 1		FDD
ul-Bandwidth	Not present		TDD
}			
additionalSpectrumEmission	1		
}			

Condition	Explanation
FDD	FDD cell environment
TDD	TDD cell environment

Table 8.6.5.1.3.3-9: SecurityConfigHO (Table 8.6.5.1.3.3-7)

Derivation Path: 36.508, Table 4.6.4-1			
Information Element	Value/remark	Comment	Condition
SecurityConfigHO ::= SEQUENCE {			
handoverType CHOICE {			
interRAT SEQUENCE {			
securityAlgorithmConfig SEQUENCE {			
cipheringAlgorithm	Set according to PIXIT parameter for default ciphering protection algorithm		
integrityProtAlgorithm	Set according to PIXIT parameter for default integrity algorithm		
}			
nas-SecurityParamToEUTRA	<p>Octets 1 to 4 are arbitrarily selected.</p> <p>Bits 1 to 3 of octet 5 are set according to PIXIT parameter for default integrity protection algorithm.</p> <p>Bits 5 to 7 of octet 5 are set according to PIXIT parameter for default ciphering algorithm.</p> <p>Bits 1 to 3 of octet 6 are arbitrarily selected between '000'B and '110'B, different from the valid NAS key set identifier of the UE if such a value exists.</p> <p>Bit 4 of octet 6 is set to 1.</p>	<p>Octets 1 to 4 include the NonceMME value.</p> <p>Bits 1 to 3 of octet 5 include the Type of integrity protection algorithm</p> <p>Bits 5 to 7 of octet 5 include the Type of ciphering algorithm.</p> <p>Bits 1 to 4 of octet 6 include the NAS key set identifier.</p>	
}			
}			
}			
}			

Table 8.6.5.1.3.3-10: RRCConnectionReconfigurationComplete (step 17, Table 8.6.5.1.3.2-2)

Derivation Path: 36.508, Table 4.6.1-9			
Information Element	Value/remark	Comment	Condition
RRCConnectionReconfigurationComplete ::= SEQUENCE {			
criticalExtensions CHOICE {			
nonCriticalExtension SEQUENCE {			
lateNonCriticalExtension	Not present or any allowed value		
nonCriticalExtension SEQUENCE {			
rf-InfoAvailable-r10	true		
logMeasAvailable-r10	Not present		
nonCriticalExtension	Not present or any allowed value		
}			
}			
}			
}			

Table 8.6.5.1.3.3-11: UEInformationRequest (step 19, Table 8.6.5.1.3.2-2)

Derivation Path: 36.508, Table 4.6.1-23A			
Information Element	Value/remark	Comment	Condition
UEInformationRequest-r9 ::=SEQUENCE {			
criticalExtensions CHOICE {			
c1 CHOICE {			
ueInformationRequest-r9 SEQUENCE {			
rf-ReportReq-r9	TRUE		
}			
}			
}			
}			

Table 8.6.5.1.3.3-12: *UEInformationResponse* (step 20, Table 8.6.5.1.3.2-2)

Derivation Path: 36.508, Table 4.6.1-23B			
Information Element	Value/remark	Comment	Condition
UEInformationResponse-r9 ::=SEQUENCE {			
criticalExtensions CHOICE {			
c1 CHOICE {			
ueInformationResponse-r9 SEQUENCE {			
r1f-Report-r9 SEQUENCE {			
measResultLastServCell-r9 SEQUENCE {			
rsrpResult-r9	(0..97)		
rsrqResult-r9	Not present or (0..34)		
}			
measResultNeighCells-r9 SEQUENCE {			
measResultListEUTRA-r9	Not present		
measResultListUTRA-r9 SEQUENCE (SIZE (1..maxFreq)) OF SEQUENCE {	1 entry		
carrierFreq-r9	Same downlink ARFCN as used for Cell 5		
measResultList-r9 SEQUENCE (SIZE (1..maxCellReport)) OF SEQUENCE {	1 entry		
physCellId CHOICE {			
fdd	PhysicalCellIdentity of Cell 5		UTRA-FDD
tdd	PhysicalCellIdentity of Cell 5		UTRA-TDD
}			
cgi-Info	Not present		
measResult SEQUENCE {			
utra-RSCP	Not present or (-5..91)		
utra-EcN0	Not present		
additionalSI-Info-r9	Not present		
}			
}			
measResultListGERAN-r9	Not present		
measResultsCDMA2000-r9	Not present		
}			
locationInfo-r10	Not present or any allowed value		
failedPCellId-r10 CHOICE {	cellGlobalId-r10 or pci-arfcn-r10	If the UE has the global cell identity depending on UE implementation, the UE sets the global cell identity, otherwise the UE sets the physical cell identity and the carrier frequency.	
cellGlobalId-r10 SEQUENCE {			
plmn-Identity	<i>plmn-Identity</i> within <i>SystemInformationBlockType1</i> broadcasted in Cell 1		
cellIdentity	<i>cellIdentity</i> within <i>SystemInformationBlockType1</i> broadcasted in Cell 1		
}			
pci-arfcn-r10 SEQUENCE {			
physCellId-r10	Physical cell Identity of Cell 1		
carrierFreq-r10	Same downlink EARFCN as used for Cell 1		
}			

}			
reestablishmentCellId-r10	Not present		
timeConnFailure-r10	Not present		
connectionFailureType-r10	rlf		
previousPCellId-r10	Not present		
}			
}			
}			
}			
}			

Condition	Explanation
UTRA-FDD	UTRA FDD cell environment
UTRA-TDD	UTRA TDD cell environment

8.6.5.2 Radio Link Failure logging / Reporting at GERAN Inter-RAT handover

8.6.5.2.1 Test Purpose (TP)

(1)

```
with { UE in E-UTRAN RRC_CONNECTED state with radio link failure information available in VarRLF-Report }
ensure that {
  when { UE handovers back to E-UTRAN from GERAN with the RPLMN equalling to the plmn-Identity stored in VarRLF-Report }
  then { UE sends the RRCConnectionReconfigurationComplete message with rlf-InfoAvailable included }
}
```

(2)

```
with { UE in E-UTRAN RRC_CONNECTED state with the Inter-RAT GERAN neighbour cell measurement information configured and the radio link failure information available in VarRLF-Report }
ensure that {
  when { UE receives the UEInformationRequest message with rlf-ReportReq set to true and plmn-Identity stored in VarRLF-Report is equal to the RPLMN }
  then { UE sends the UEInformationResponse message with GERAN neighbour cell information (measResultListGERAN) included in measResultNeighCells }
}
```

8.6.5.2.2 Conformance requirements

References: The conformance requirements covered in the present TC are specified in: TS 36.331, clause 5.3.11.3, 5.4.2.3 and 5.6.5.3.

[TS 36.331, clause 5.3.11.3 (TP1, TP2)]

The UE shall:

- 1> upon T310 expiry; or
- 1> upon random access problem indication from MAC while neither T300, T301, T304 nor T311 is running; or
- 1> upon indication from RLC that the maximum number of retransmissions has been reached:
 - 2> consider radio link failure to be detected;
 - 2> store the following radio link failure information in the *VarRLF-Report* by setting its fields as follows:
 - 3> clear the information included in *VarRLF-Report*, if any;
 - 3> set the *plmn-Identity* to the RPLMN;
 - 3> set the *measResultLastServCell* to include the RSRP and RSRQ, if available, of the PCell based on measurements collected up to the moment the UE detected radio link failure;

- 3> set the *measResultNeighCells* to include the best measured cells, other than the PCell, ordered such that the best cell is listed first, and based on measurements collected up to the moment the UE detected radio link failure, and set its fields as follows;
 - 4> if the UE was configured to perform measurements for one or more EUTRA frequencies, include the *measResultListEUTRA*;
 - 4> if the UE was configured to perform measurement reporting for one or more neighbouring UTRA frequencies, include the *measResultListUTRA*;
 - 4> if the UE was configured to perform measurement reporting for one or more neighbouring GERAN frequencies, include the *measResultListGERAN*;
 - 4> if the UE was configured to perform measurement reporting for one or more neighbouring CDMA2000 frequencies, include the *measResultsCDMA2000*;

NOTE: The measured quantities are filtered by the L3 filter as configured in the mobility measurement configuration. The measurements are based on the time domain measurement resource restriction, if configured. Blacklisted cells are not required to be reported.

- 3> if detailed location information is available, set the content of the *locationInfo* as follows:
 - 4> include the *locationCoordinates*;
 - 4> include the *horizontalVelocity*, if available;
- 3> set the *failedPCellId* to the global cell identity, if available, and otherwise to the physical cell identity and carrier frequency of the PCell where radio link failure is detected;
- 3> if an *RRCConnectionReconfiguration* message including the *mobilityControlInfo* was received before the connection failure:
 - 4> include *previousPCellId* and set it to the global cell identity of the PCell where the last *RRCConnectionReconfiguration* including the *mobilityControlInfo* message was received;
 - 4> set the *timeConnFailure* to the elapsed time since reception of the last *RRCConnectionReconfiguration* message including the *mobilityControlInfo*;
- 3> set the *connectionFailureType* to *rlf*;
- 2> if AS security has not been activated:
 - 3> perform the actions upon leaving RRC_CONNECTED as specified in 5.3.12, with release cause 'other';
- 2> else:
 - 3> initiate the connection re-establishment procedure as specified in 5.3.7;

The UE may discard the radio link failure information, i.e. release the UE variable *VarRLF-Report* 48 hours after the radio link failure is detected.

[TS 36.331, clause 5.4.2.3 (TP1)]

If the UE is able to comply with the configuration included in the *RRCConnectionReconfiguration* message, the UE shall:

...

- 1> set the content of *RRCConnectionReconfigurationComplete* message as follows:
 - 2> if the UE has radio link failure or handover failure information available in *VarRLF-Report* and *plmn-Identity* stored in *VarRLF-Report* is equal to the RPLMN:
 - 3> include *rlf-InfoAvailable*;
 - 2> if the UE has logged measurements available for E-UTRA and *plmn-Identity* stored in *VarLogMeasReport* is equal to the RPLMN:

3> include the *logMeasAvailable*;

1> submit the *RRCCConnectionReconfigurationComplete* message to lower layers for transmission using the new configuration;

[TS 36.331, clause 5.6.5.3 (TP2)]

Upon receiving the *UEInformationRequest* message, the UE shall:

...

1> if *rlf-ReportReq* is set to *true* and the UE has radio link failure information or handover failure information available in *VarRLF-Report* and *plmn-Identity* stored in *VarRLF-Report* is equal to the RPLMN, set the *rlf-Report* in the *UEInformationResponse* message to the value of *rlf-Report* in *VarRLF-Report*;

1> if the *rlf-Report* is included in *UEInformationResponse*:

2> discard the *rlf-Report* from *VarRLF-Report* upon successful delivery of the *UEInformationResponse* message confirmed by lower layers.

...

1> if the *logMeasReport* is included in the *UEInformationResponse*:

...

1> else:

2> submit the *UEInformationResponse* message to lower layers for transmission via SRB1;

8.6.5.2.3 Test description

8.6.5.2.3.1 Pre-test conditions

System Simulator:

- Cell 1, Cell 2 and Cell 24 - Cell 1 and Cell 2 are E-UTRAN cell, Cell 24 is a GERAN cell.
- All cells belong to the same PLMN.
- System information combination 5 as defined in TS 36.508 [18] clause 4.4.3.1 is used in E-UTRA cells.

UE:

None.

Preamble:

- The UE is in state Generic RB Established (state 3) on Cell 1 according to [18].

8.6.5.2.3.2 Test procedure sequence

Table 8.6.5.2.3.2-1 illustrates the downlink power levels and other changing parameters to be applied for the cells at various time instants of the test execution. Row marked "T0" denotes the initial conditions after preamble, while columns marked "T1", "T2" and "T3" are to be applied subsequently. The exact instants on which these values shall be applied are described in the texts in this clause.

Table 8.6.5.2.3.2-1: Time instances of cell power level and parameter changes

	Parameter	Unit	Cell 1	Cell 24	Remark
T1	Cell-specific RS EPRE	dBm/15k Hz	-80	-	
	RSSI	dBm	-	[-65]	
T2	Cell-specific RS EPRE	dBm/15k Hz	"Off"	-	
	RSSI	dBm	-	[-65]	
T3	Cell-specific RS EPRE	dBm/15k Hz	-60	-	
	RSSI	dBm	-	[-85]	

Table 8.6.5.2.3.2-2: Main behaviour

St	Procedure	Message Sequence		TP	Verdict
		U - S	Message		
1	The SS changes Cell 1 and Cell 24 parameters according to the row "T1" in table 8.6.5.2.3.2-1.	-	-	-	-
2	The SS transmits an <i>RRCCONNECTIONRECONFIGURATION</i> message to setup inter-RAT measurement on Cell 1.	<--	<i>RRCCONNECTIONRECONFIGURATION</i>	-	-
3	The UE transmits an <i>RRCCONNECTIONRECONFIGURATIONCOMPLETE</i> message on Cell 1.	-->	<i>RRCCONNECTIONRECONFIGURATIONCOMPLETE</i>	-	-
4	The UE transmits a <i>MEASUREMENTREPORT</i> message on Cell 1 to report event B2 with the measured rssi value for Cell 24.	-->	<i>MEASUREMENTREPORT</i>	-	-
5	The SS changes Cell 1 and Cell 24 parameters according to the row "T2" in Table 8.6.5.2.3.2-1 in order that the radio link quality of Cell 1 is degraded and Cell 24 is suitable for camping.	-	-	-	-
6	The UE executes the generic test procedure in TS 36.508 subclause 6.4.2.9 to make sure that the UE is camped on GERAN Cell 24	-	-	-	-
7	The SS changes Cell 1 and Cell 24 parameters according to the row "T3" in table 8.6.5.2.3.2-1.	-	-	-	-
8	The SS transmits PS HANDOVER COMMAND message on Cell 24 to order the UE to perform inter-RAT handover to Cell 1.	<--	PS HANDOVER COMMAND	-	-
9	Check: Does the UE transmit an <i>RRCCONNECTIONRECONFIGURATIONCOMPLETE</i> message on Cell 1 with <i>rfl-InfoAvailable</i> included?	-->	<i>RRCCONNECTIONRECONFIGURATIONCOMPLETE</i>	1	P
10	The UE transmits a TRACKING AREA UPDATE REQUEST message on Cell 1.	-	-	-	-
11	The SS transmits a NAS SECURITY MODE COMMAND message to activate NAS security (mapped security context)	<--	RRC: <i>DLInformationTransfer</i> NAS: SECURITY MODE COMMAND	-	-
12	The UE transmits a NAS SECURITY MODE COMPLETE message and establishes the initial security configuration.	-->	RRC: <i>ULInformationTransfer</i> NAS: SECURITY MODE COMPLETE	-	-
13	SS responds with a TRACKING AREA UPDATE ACCEPT message.	-	RRC: <i>DLInformationTransfer</i> NAS: TRACKING AREA UPDATE ACCEPT	-	-
14	The UE transmits a TRACKING AREA UPDATE COMPLETE message.	-	RRC: <i>ULInformationTransfer</i> NAS: TRACKING AREA UPDATE COMPLETE	-	-
15	The SS transmits a <i>UEINFORMATIONREQUEST</i> message with <i>rfl-ReportReq</i> set to <i>true</i> on Cell 1.	<--	<i>UEINFORMATIONREQUEST</i>	-	-
16	Check: Does the UE transmit a <i>UEINFORMATIONRESPONSE</i> message on Cell 1	-->	<i>UEINFORMATIONRESPONSE</i>	2	P

	with the GERAN neighbour Cell 24 measurement information (<i>measResultListGERAN</i>) included in <i>rf-Report</i> ?				
17	Check: Does the test result of generic test procedure in TS 36.508 subclause 6.4.2.3 indicate that the UE is in E-UTRA RRC_CONNECTED state on Cell 1?	-	-	1	-

8.6.5.2.3.3 Specific message contents

Table 8.6.5.2.3.3-1: RRCConnectionReconfiguration (step 2, Table 8.6.5.2.3.2-2)

Derivation Path: 36.508, Table 4.6.1-8, condition MEAS

Table 8.6.5.2.3.3-2: MeasConfig (Table 8.6.5.2.3.3-1)

Derivation Path: 36.508, Table 4.6.6-1, condition GERAN			
Information Element	Value/remark	Comment	Condition
MeasConfig ::= SEQUENCE {			
measObjectToAddModList SEQUENCE (SIZE (1..maxObjectId)) OF SEQUENCE {	2 entries		
measObjectId[1]	IdMeasObject-f1		
measObject[1]	MeasObjectEUTRA- GENERIC(f1)		
measObjectId[2]	IdMeasObject-f11		
measObject[2]	MeasObjectGERAN- GENERIC(f11)		
}			
reportConfigToAddModList SEQUENCE (SIZE (1..maxReportConfigId)) OF SEQUENCE {	1 entry		
reportConfigId[1]	IdReportConfig-B2- GERAN		
reportConfig[1]	ReportConfigInterRAT- B2-GERAN(-69, [-79])		
}			
measIdToAddModList SEQUENCE (SIZE (1..maxMeasId)) OF SEQUENCE {	1 entry		
measId[1]	1		
measObjectId[1]	IdMeasObject-f11		
reportConfigId[1]	IdReportConfig-B2- GERAN		
}			
quantityConfig SEQUENCE {			
quantityConfigGERAN SEQUENCE {			
measQuantityGERAN	rssi		
filterCoefficient	fc0		
}			
}			
}			

Table 8.6.5.2.3.3-3: MeasurementReport (step 4, Table 8.6.5.2.3.2-2)

Derivation Path: 36.508, Table 4.6.1-5			
Information Element	Value/remark	Comment	Condition
MeasurementReport ::= SEQUENCE {			
criticalExtensions CHOICE {			
c1 CHOICE{			
measurementReport-r8 SEQUENCE {			
measResults SEQUENCE {			
measId	1		
measResultServCell SEQUENCE {			
rsrpResult	(0..97)		
rsrqResult	(0..34)		
}			
measResultsNeighCells CHOICE {			
measResultListGERAN SEQUENCE (SIZE (1..maxCellReport)) OF SEQUENCE {	1 entry		
carrierFreq[1] SEQUENCE {			
arfcn	Not checked		
bandIndicator	Not checked		
}			
physCellId[1]	PhysicalCellIdentity of Cell 24		
cgi-info[1]	Not present		
measResult[1] SEQUENCE {			
rssi	(0..63)		
}			
}			
}			
}			
}			
}			
}			

Table 8.6.5.2.3.3-4: PS HANDOVER COMMAND (step 8, Table 8.6.5.2.3.3-2)

Derivation Path: 44.060, Table 11.2.43.1			
Information Element	Value/remark	Comment	Condition
PAGE MODE	'00'B	Normal Paging	
Global TFI	TFI of the downlink TBF		
CONTAINER_ID	0		
PS Handover to E-UTRAN Payload	'10'B		
RRC Container IE			
RRC_CONTAINER_LENGTH	Length of the container data		
RRC_CONTAINER_DATA			
RRCConnectionReconfiguration message			HO-TO-EUTRA
RRCConnectionReconfiguration ::= SEQUENCE {			Derivation Path: 36.331 clause 6.2.2
rrc-TransactionIdentifier	RRC-TransactionIdentifier-DL		
criticalExtensions CHOICE {			
c1 CHOICE{			
rrcConnectionReconfiguration-r8 SEQUENCE {			
measConfig	Not present		
mobilityControlInfo	MobilityControlInfo		HO-TO-EUTRA Ref Table 8.6.5.2.3.3-5
dedicatedInfoNASList	Not present		
radioResourceConfigDedicated	RadioResourceConfigDedicated-HO-TO-EUTRA(n, m)		HO-TO-EUTRA(n, m)
securityConfigHO	SecurityConfigHO		HO-TO-EUTRA Ref Table 8.6.5.2.3.3-6
nonCriticalExtension SEQUENCE {}	Not present		
}			
}			
}			
}			

Table 8.6.5.2.3.3-5: MobilityControllInfo (Table 8.6.5.2.3.3-4)

Derivation Path: 36.508, Table 4.6.5-1			
Information Element	Value/remark	Comment	Condition
MobilityControllInfo ::= SEQUENCE {			
targetPhysCellId	PhysicalCellIdentity of Cell 1.		
carrierFreq SEQUENCE {			
dl-CarrierFreq	Same downlink EARFCN as used for Cell 1.		
ul-CarrierFreq	Not present		
}			
carrierBandwidth SEQUENCE {			
dl-Bandwidth	Downlink system bandwidth under test.		
ul-Bandwidth	Uplink Bandwidth under test.		FDD
	Not present		TDD
}			
additionalSpectrumEmission	1		
}			

Condition	Explanation
FDD	FDD cell environment
TDD	TDD cell environment

Table 8.6.5.2.3.3-6: SecurityConfigHO (Table 8.6.5.2.3.3-4)

Derivation Path: 36.508, Table 4.6.4-1			
Information Element	Value/remark	Comment	Condition
SecurityConfigHO SEQUENCE {			
handoverType CHOICE {			
interRAT SEQUENCE {			
securityAlgorithmConfig SEQUENCE {			
cipheringAlgorithm	Set according to PIXIT parameter for default ciphering protection algorithm		
integrityProtAlgorithm	Set according to PIXIT parameter for default integrity algorithm		
}			
nas-SecurityParamToEUTRA	<p>Octets 1 to 4 are arbitrarily selected.</p> <p>Bits 1 to 3 of octet 5 are set according to PIXIT parameter for default integrity protection algorithm.</p> <p>Bits 5 to 7 of octet 5 are set according to PIXIT parameter for default ciphering algorithm.</p> <p>Bits 1 to 3 of octet 6 are arbitrarily selected between '000'B and '110'B, different from the valid NAS key set identifier of the UE if such a value exists.</p> <p>Bit 4 of octet 6 is set to 1.</p>	<p>Octets 1 to 4 include the NonceMME value.</p> <p>Bits 1 to 3 of octet 5 include the Type of integrity protection algorithm</p> <p>Bits 5 to 7 of octet 5 include the Type of ciphering algorithm.</p> <p>Bits 1 to 4 of octet 6 include the NAS key set identifier.</p>	
}			
}			
}			
}			

Table 8.6.5.2.3.3-7: RRCConnectionReconfigurationComplete (step 9, Table 8.6.5.2.3.2-2)

Derivation Path: 36.508, Table 4.6.1-9			
Information Element	Value/remark	Comment	Condition
RRCConnectionReconfigurationComplete ::= SEQUENCE {			
rrc-TransactionIdentifier	RRC-TransactionIdentifier-UL		
criticalExtensions CHOICE {			
rrcConnectionReconfigurationComplete-r8 SEQUENCE {			
nonCriticalExtension SEQUENCE {			
nonCriticalExtension SEQUENCE {			
rif-InfoAvailable-r10	true		
}			
}			
}			
}			

Table 8.6.5.2.3.3-8: UEInformationRequest (step 15, Table 8.6.5.2.3.2-2)

Derivation Path: 36.508, Table 4.6.1-23A			
Information Element	Value/remark	Comment	Condition
UEInformationRequest-r9 ::=SEQUENCE {			
criticalExtensions CHOICE {			
c1 CHOICE {			
ueInformationRequest-r9 SEQUENCE {			
rf-ReportReq-r9	TRUE		
}			
}			
}			
}			

Table 8.6.5.2.3.3-9: UEInformationResponse (step 16, Table 8.6.5.2.3.2-2)

Derivation Path: 36.508, Table 4.6.1-23B			
Information Element	Value/remark	Comment	Condition
UEInformationResponse-r9 ::=SEQUENCE {			
criticalExtensions CHOICE {			
c1 CHOICE {			
ueInformationResponse-r9 SEQUENCE {			
r1f-Report-r9 SEQUENCE {			
measResultLastServCell-r9 SEQUENCE {		Cell 1	
rsrpResult-r9	(0..97)		
rsrqResult-r9	Not present or (0..34)		
}			
measResultNeighCells-r9 SEQUENCE {			
measResultListGERAN-r9	1 entry		
SEQUENCE(SIZE(1.. maxCellReport)) OF SEQUENCE {			
carrierFreq-r9 SEQUENCE {			
arfcn	Downlink ARFCN of Cell 24		
bandIndicator	The same band indicator of the Cell 24		
}			
physCellId	0001H		
cgi-Info	Not present		
measResult SEQUENCE {			
rssi	(0..63)		
}			
}			
}			
locationInfo-r10	Not present or any allowed value		
failedPCellId-r10 CHOICE {	cellGlobalId-r10 or pci-arfcn-r10	If the UE has the global cell identity depending on UE implementation, the UE sets the global cell identity, otherwise the UE sets the physical cell identity and the carrier frequency.	
cellGlobalId-r10 SEQUENCE {			
plmn-Identity	<i>plmn-Identity</i> within <i>SystemInformationBlockType1</i> broadcasted in Cell 1		
cellIdentity	<i>cellIdentity</i> within <i>SystemInformationBlockType1</i> broadcasted in Cell 1		
}			
pci-arfcn-r10 SEQUENCE {			
physCellId-r10	PhysicalCellIdentity of Cell 1		
carrierFreq-r10	Same downlink EARFCN as used for Cell 1		
}			
}			
timeConnFailure-r10	Not Present		
connectionFailureType-r10	r1f		
previousPCellId-r10	Not Present		
}			
}			

}			
}			

8.6.5.3 Radio Link Failure logging / Reporting CDMA2000 neighbour cell information

8.6.5.3.1 Test Purpose (TP)

(1)

```

with { UE in E-UTRAN RRC_CONNECTED state with the Inter-RAT cdma2000 neighbour cell measurement
information configured and the radio link failure information available in VarRLF-Report }
ensure that {
  when { UE receives the UEInformationRequest message with rlf-ReportReq set to true and plmn-Identity
stored in VarRLF-Report is equal to the RPLMN }
  then { UE sends the UEInformationResponse message with CDMA2000 neighbour cell information
(measResultsCDMA2000) included }
}

```

8.6.5.3.2 Conformance requirements

References: The conformance requirements covered in the present TC are specified in: TS 36.331, clause 5.3.7.4, 5.3.11.3 and 5.6.5.3.

[TS 36.331, clause 5.3.7.4]

If the procedure was initiated due to radio link failure or handover failure, the UE shall:

- 1> set the *reestablishmentCellId* in the *VarRLF-Report* to the global cell identity of the selected cell;

The UE shall set the contents of *RRCCConnectionReestablishmentRequest* message as follows:

...

- 1> set the *reestablishmentCause* as follows:

...

- 2> else if the re-establishment procedure was initiated due to handover failure as specified in 5.3.5.6 (intra-LTE handover failure) or 5.4.3.5 (inter-RAT mobility from EUTRA failure):

- 3> set the *reestablishmentCause* to the value *handoverFailure*;

- 2> else:

- 3> set the *reestablishmentCause* to the value *otherFailure*;

The UE shall submit the *RRCCConnectionReestablishmentRequest* message to lower layers for transmission.

[TS 36.331, clause 5.3.11.3]

The UE shall:

- 1> upon T310 expiry; or

- 1> upon random access problem indication from MAC while neither T300, T301, T304 nor T311 is running; or

- 1> upon indication from RLC that the maximum number of retransmissions has been reached:

- 2> consider radio link failure to be detected;

- 2> store the following radio link failure information in the *VarRLF-Report* by setting its fields as follows:

- 3> clear the information included in *VarRLF-Report*, if any;

- 3> set the *plmn-Identity* to the RPLMN;

- 3> set the *measResultLastServCell* to include the RSRP and RSRQ, if available, of the PCell based on measurements collected up to the moment the UE detected radio link failure;

- 3> set the *measResultNeighCells* to include the best measured cells, other than the PCell, ordered such that the best cell is listed first, and based on measurements collected up to the moment the UE detected radio link failure, and set its fields as follows;

...

- 4> if the UE was configured to perform measurement reporting for one or more neighbouring CDMA2000 frequencies, include the *measResultsCDMA2000*;

NOTE: The measured quantities are filtered by the L3 filter as configured in the mobility measurement configuration. The measurements are based on the time domain measurement resource restriction, if configured. Blacklisted cells are not required to be reported.

- 3> if detailed location information is available, set the content of the *locationInfo* as follows:
 - 4> include the *locationCoordinates*;
 - 4> include the *horizontalVelocity*, if available;
- 3> set the *failedPCellId* to the global cell identity, if available, and otherwise to the physical cell identity and carrier frequency of the PCell where radio link failure is detected;
- 3> if an *RRCConnectionReconfiguration* message including the *mobilityControlInfo* was received before the connection failure:
 - 4> include *previousPCellId* and set it to the global cell identity of the PCell where the last *RRCConnectionReconfiguration* including the *mobilityControlInfo* message was received;
 - 4> set the *timeConnFailure* to the elapsed time since reception of the last *RRCConnectionReconfiguration* message including the *mobilityControlInfo*;
- 3> set the *connectionFailureType* to *rlf*;
- 2> if AS security has not been activated:
 - 3> perform the actions upon leaving RRC_CONNECTED as specified in 5.3.12, with release cause 'other';
- 2> else:
 - 3> initiate the connection re-establishment procedure as specified in 5.3.7;

The UE may discard the radio link failure information, i.e. release the UE variable *VarRLF-Report* 48 hours after the radio link failure is detected.

[TS 36.331, clause 5.6.5.3]

Upon receiving the *UEInformationRequest* message, the UE shall:

...

- 1> if *rlf-ReportReq* is set to *true* and the UE has radio link failure information or handover failure information available in *VarRLF-Report* and *plmn-Identity* stored in *VarRLF-Report* is equal to the RPLMN, set the *rlf-Report* in the *UEInformationResponse* message to the value of *rlf-Report* in *VarRLF-Report*;
- 1> if the *rlf-Report* is included in *UEInformationResponse*:
 - 2> discard the *rlf-Report* from *VarRLF-Report* upon successful delivery of the *UEInformationResponse* message confirmed by lower layers.

...

- 1> if the *logMeasReport* is included in the *UEInformationResponse*:

...

- 1> else:

- 2> submit the *UEInformationResponse* message to lower layers for transmission via SRB1;

8.6.5.3.3 Test description

8.6.5.3.3.1 Pre-test conditions

System Simulator:

- Cell 1, Cell 2 and Cell 15 - Cell 1 and Cell 2 are E-UTRAN cell, Cell 15 is a CDMA2000 cell.
- All cells belong to the same PLMN.
- System information combination 6 as defined in TS 36.508 [18] clause 4.4.3.1 is used in E-UTRA cells.

UE:

None.

Preamble:

- The UE is in state Generic RB Established (state 3B) on Cell 1 according to [18].
- The UE has performed HRPD pre-registration on Cell 15.

8.6.5.3.3.2 Test procedure sequence

Table 8.6.5.3.3.2-1 illustrates the downlink power levels and other changing parameters to be applied for the cells at various time instants of the test execution. Row marked "T0" denotes the initial conditions after preamble, while columns marked "T1", "T2" and "T3" are to be applied subsequently. The exact instants on which these values shall be applied are described in the texts in this clause.

Table 8.6.5.3.3.2-1: Time instances of cell power level and parameter changes

	Parameter	Unit	Cell 1	Cell 2	Cell 15	
T0	Cell-specific RS EPRE	dBm/15k Hz	-75	"Off"	-	The power level values are such that camping on Cell 1 is guaranteed
	$\hat{I}_{or/loc}$	dB	-		-20	
	loc	dBm/1.23 MHz	-		-55	
	Pilot Ec/Io (Note 1)	dB	-		-20	
T1	Cell-specific RS EPRE	dBm/15k Hz	"Off"	-75	-	Radio link failure occurred in Cell 1 and UE re-establish on Cell 2
	$\hat{I}_{or/loc}$	dB	-		-20	
	loc	dBm/1.23 MHz	-		-55	
	Pilot Ec/Io (Note 1)	dB	-		-20	
T2	Cell-specific RS EPRE	dBm/15k Hz		-80	-	The power level values are such that entering conditions for event B2 on Cell 15 are satisfied
	$\hat{I}_{or/loc}$	dB	-		-5	
	loc	dBm/1.23 MHz	-		-55	
	Pilot Ec/Io (Note 1)	dB	-		-6	
Note 1: This parameter is not directly settable, but is derived by calculation from the other parameters set by the SS.						

Table 8.6.5.3.3.2-2: Main behaviour

St	Procedure	Message Sequence		TP	Verdict
		U - S	Message		
1	The SS transmits an <i>RRCCONNECTIONRECONFIGURATION</i> message to setup inter-RAT measurement on Cell 1.	<--	<i>RRCCONNECTIONRECONFIGURATION</i>	-	-
2	The UE transmits an <i>RRCCONNECTIONRECONFIGURATIONCOMPLETE</i> message on Cell 1.	-->	<i>RRCCONNECTIONRECONFIGURATIONCOMPLETE</i>	-	-
3	The SS changes Cell 1 and Cell 2 parameters according to the row "T1" in Table 8.6.5.3.3.2-1 in order that the radio link quality of Cell 1 is degraded and Cell 2 is suitable for camping.	-	-	-	-
4	The UE transmits an <i>RRCCONNECTIONREESTABLISHMENTREQUEST</i> message on Cell 2	-->	<i>RRCCONNECTIONREESTABLISHMENTREQUEST</i>	-	-
5	The SS transmits an <i>RRCCONNECTIONREESTABLISHMENT</i> message to resume SRB1 operation and re-activate security on Cell 2.	<--	<i>RRCCONNECTIONREESTABLISHMENT</i>	-	-
6	The UE transmits an <i>RRCCONNECTIONREESTABLISHMENTCOMPLETE</i> message with <i>rlf-InfoAvailable</i> included	-->	<i>RRCCONNECTIONREESTABLISHMENTCOMPLETE</i>	-	-
7	The SS transmits an <i>RRCCONNECTIONRECONFIGURATION</i> message to resume existing radio bearer on Cell 2.	<--	<i>RRCCONNECTIONRECONFIGURATION</i>	-	-
8	The UE transmits an <i>RRCCONNECTIONRECONFIGURATIONCOMPLETE</i> message on Cell 2.	-->	<i>RRCCONNECTIONRECONFIGURATIONCOMPLETE</i>	-	-
9	The SS changes Cell 2 and Cell 15 parameter according to the row "T2" in table 8.6.5.3.3.2-1.	-	-	-	-
10	The UE transmits a <i>MEASUREMENTREPORT</i> message on Cell 2 to report event B2 with the measured pilotStrength value for Cell 15.	-->	<i>MEASUREMENTREPORT</i>	-	-
11	The SS transmits a <i>UEINFORMATIONREQUEST</i> message with <i>rlf-ReportReq</i> set to <i>true</i> on Cell 2.	<--	<i>UEINFORMATIONREQUEST</i>	-	-
12	Check: Does the UE transmit a <i>UEINFORMATIONRESPONSE</i> message on Cell 2 with the CDMA2000 neighbour Cell 15 measurement information (<i>measResultsCDMA2000</i>) included in <i>rlf-Report</i> ?	-->	<i>UEINFORMATIONRESPONSE</i>	1	P

8.6.5.3.3.3 Specific message contents

Table 8.6.5.3.3.3-1: *RRCCONNECTIONRECONFIGURATION* (step 1, Table 8.6.5.3.3.2-2)

Derivation Path: 36.508, Table 4.6.1-8, condition MEAS
--

Table 8.6.5.3.3.3-3: MeasObjectCDMA2000-GENERIC (Table 8.6.5.3.3.3-2)

Derivation Path: 36.508, Table 4.6.6-1C			
Information Element	Value/remark	Comment	Condition
MeasObjectCDMA2000-GENERIC ::= SEQUENCE {			
cdma2000-Type	TypeHRPD		
CarrierFreqCDMA2000 SEQUENCE {			
bandClass	Band Class of frequency under test		
arfcn	f14		
}			
SearchWindowSize	15		
offsetFreq	db0		
cellsToRemoveList	Not present		
cellsToAddModList CHOICE {}	Cell 15	Listed cell parameters to be reported	
cellForWhichToReportCGI	Not present		
}			

Table 8.6.5.3.3.3-4: RRCConnectionReestablishmentRequest (step 4, Table 8.6.5.3.3.2-2)

Derivation Path: 36.508, Table 4.6.1-13			
Information Element	Value/remark	Comment	Condition
RRCConnectionReestablishmentRequest ::= SEQUENCE {			
criticalExtensions CHOICE {			
rrcConnectionReestablishmentRequest-r8 SEQUENCE {			
ue-Identity SEQUENCE {			
c-RNTI	the value of the C-RNTI of the UE		
physCellId	PhysicalCellIdentity of Cell 1		
shortMAC-I	The same value as the 16 least significant bits of the XMAC-I value calculated by SS.		
}			
reestablishmentCause	otherFailure		
}			
}			
}			

Table 8.6.5.3.3.3-5: RRCConnectionReestablishment (step 5, Table 8.6.5.3.3.2-2)

Derivation Path: 36.508, Table 4.6.1-10			
Information Element	Value/remark	Comment	Condition
RRCConnectionReestablishment ::= SEQUENCE {			
criticalExtensions CHOICE {			
c1 CHOICE {			
rrcConnectionReestablishment-r8 SEQUENCE {			
nextHopChainingCount	0		
}			
}			
}			
}			

Table 8.6.5.3.3.3-6: RRCConnectionReestablishmentComplete (step 6, Table 8.6.5.3.3.2-2)

Derivation Path: 36.508, Table 4.6.1-11			
Information Element	Value/remark	Comment	Condition
RRCConnectionReestablishmentComplete ::= SEQUENCE {			
criticalExtensions CHOICE {			
rrcConnectionReestablishmentComplete-r8 = SEQUENCE {			
nonCriticalExtension SEQUENCE {			
rf-InfoAvailable-r9	true		
}			
}			
}			
}			

Table 8.6.5.3.3.3-7: RRCConnectionReconfiguration (step 7, Table 8.6.5.3.3.2-2)

Derivation Path: 36.508, Table 4.6.1-8			
Information Element	Value/remark	Comment	Condition
RRCConnectionReconfiguration ::= SEQUENCE {			
criticalExtensions CHOICE {			
c1 CHOICE{			
rrcConnectionReconfiguration-r8 SEQUENCE {			
radioResourceConfigDedicated	RadioResourceConfigDe dedicated-HO		
}			
}			
}			
}			

Table 8.6.5.3.3-8: MeasurementReport (step 10, Table 8.6.5.3.3.2-2)

Derivation Path: 36.508, Table 4.6.1-5			
Information Element	Value/remark	Comment	Condition
MeasurementReport ::= SEQUENCE {			
criticalExtensions CHOICE {			
c1 CHOICE{			
measurementReport-r8 SEQUENCE {			
measResults SEQUENCE {			
measId	1		
measResultServCell SEQUENCE {			
rsrpResult	(0..97)		
rsrqResult	(0..34)		
}			
measResultNeighCells CHOICE {			
measResultsCDMA2000 ::=SEQUENCE {			
preRegistrationStatusHRPD	TRUE		
measResultListCDMA2000 ::=SEQUENCE	1 entry	Note 1	
(SIZE (1..maxCellReport)) OF SEQUENCE {			
physCellId[1]	PhysicalCellId of Cell 15		
cgi-Info[1]	Not present		
measResult[1] SEQUENCE {			
pilotStrength	(0..63)		
}			
}			
}			
}			
}			
}			
}			
}			

Table 8.6.5.3.3-9: UEInformationRequest (step 11, Table 8.6.5.3.3.2-2)

Derivation Path: 36.508, Table 4.6.1-23A			
Information Element	Value/remark	Comment	Condition
UEInformationRequest-r9 ::=SEQUENCE {			
criticalExtensions CHOICE {			
c1 CHOICE {			
ueInformationRequest-r9 SEQUENCE {			
rfl-ReportReq-r9	TRUE		
}			
}			
}			
}			

Table 8.6.5.3.3-10: *UEInformationResponse* (step 12, Table 8.6.5.3.3.2-2)

Derivation Path: 36.508, Table 4.6.1-23B			
Information Element	Value/remark	Comment	Condition
UEInformationResponse-r9 ::=SEQUENCE {			
criticalExtensions CHOICE {			
c1 CHOICE {			
ueInformationResponse-r9 SEQUENCE {			
rfl-Report-r9 SEQUENCE {			
measResultLastServCell-r9 SEQUENCE {		Cell 1	
rsrpResult-r9	(0..97)		
rsrqResult-r9	Not present or (0..34)		
}			
measResultNeighCells-r9 SEQUENCE {			
measResultsCDMA2000-r9	1 entry		
SEQUENCE(SIZE(1..maxFreq)) OF SEQUENCE {			
carrierFreq-r9 SEQUENCE {			
bandClass			
arfcn	The ARFCN of Cell 15		
}			
measResultList-r9 SEQUENCE (SIZE (1..maxCellReport)) OF SEQUENCE {			
preRegistrationStatusHRPD	true		
measResultListCDMA2000 SEQUENCE (SIZE (1..maxCellReport)) OF SEQUENCE {			
physCellId	Phys cell id of cell 15		
cgi-Info	Not present		
measResult SEQUENCE {			
pilotStrength	(0..63)		
}			
}			
}			
}			
locationInfo-r10	Not present or any allowed value		
failedPCellId-r10 CHOICE {	cellGlobalId-r10 or pci-arfcn-r10	If the UE has the global cell identity depending on UE implementation, the UE sets the global cell identity; otherwise the UE sets the physical cell identity and the carrier frequency.	
cellGlobalId-r10 SEQUENCE {			
plmn-Identity	<i>plmn-Identity</i> within <i>SystemInformationBlockType1</i> broadcasted in Cell 1		
cellIdentity	<i>cellIdentity</i> within <i>SystemInformationBlockType1</i> broadcasted in Cell 1		
}			
pci-arfcn-r10 SEQUENCE {			
physCellId-r10	PhysicalCellIdentity of Cell 1		
carrierFreq-r10	Same downlink EARFCN as used for Cell 1		
}			
}			
reestablishmentCellId-r10 SEQUENCE {			
plmn-Identity	<i>plmn-Identity</i> within	"Verify setting of	

	<i>SystemInformationBlockType1</i> broadcasted in Cell 2	reestablishment CellId in the VarRLF-Report to the global cell identity of the selected cell at RRC connection re-establishment due to handover failure"	
cellIdentity	<i>cellIdentity</i> within <i>SystemInformationBlockType1</i> broadcasted in Cell 2		
}			
timeConnFailure-r10	Not Present		
connectionFailureType-r10	rlf		
previousPCellId-r10	Not Present		
}			
}			
}			
}			
}			

8.6.6 Logged Handover Failure

8.6.6.1 Handover Failure logging / Reporting of Intra-frequency measurements

8.6.6.1.1 Test Purpose (TP)

(1)

```

with { UE in RRC_CONNECTED having performed the intra-frequency measurement and reported that the UE
has handover failure information available }
ensure that {
  when { UE receives the UEInformationRequest message containing rlf-ReportReq }
  then { UE sends the UEInformationResponse message containing the measurement result for intra-
frequency neighbour cell }
}

```

8.6.6.1.2 Conformance requirements

References: The conformance requirements covered in the present TC are specified in: TS 36.331, clause 5.3.5.6, 5.3.7.4, 5.3.7.5 and 5.6.5.3.

[TS 36.331, clause 5.3.5.6]

The UE shall:

1> if T304 expires (handover failure):

NOTE 1: Following T304 expiry any dedicated preamble, if provided within the *rach-ConfigDedicated*, is not available for use by the UE anymore.

2> revert back to the configuration used in the source PCell, excluding the configuration configured by the *physicalConfigDedicated*, the *mac-MainConfig* and the *sps-Config*;

2> store the following handover failure information in *VarRLF-Report* by setting its fields as follows:

3> clear the information included in *VarRLF-Report*, if any;

3> set the *plmn-Identity* to the RPLMN;

3> set the *measResultLastServCell* to include the RSRP and RSRQ, if available, of the PCell based on measurements collected up to the moment the UE detected handover failure;

- 3> set the *measResultNeighCells* to include the best measured cells, other than the PCell, ordered such that the best cell is listed first, and based on measurements collected up to the moment the UE detected handover failure, and set its fields as follows;
 - 4> if the UE was configured to perform measurements for one or more EUTRA frequencies, include the *measResultListEUTRA*;
 - 4> if the UE was configured to perform measurement reporting for one or more neighbouring UTRA frequencies, include the *measResultListUTRA*;
 - 4> if the UE was configured to perform measurement reporting for one or more neighbouring GERAN frequencies, include the *measResultListGERAN*;
 - 4> if the UE was configured to perform measurement reporting for one or more neighbouring CDMA2000 frequencies, include the *measResultsCDMA2000*;

NOTE 2: The measured quantities are filtered by the L3 filter as configured in the mobility measurement configuration. The measurements are based on the time domain measurement resource restriction, if configured. Blacklisted cells are not required to be reported.

- 3> if detailed location information is available, set the content of the *locationInfo* as follows:
 - 4> include the *locationCoordinates*;
 - 4> include the *horizontalVelocity*, if available;
- 3> set the *failedPCellId* to the global cell identity, if available, and otherwise to the physical cell identity and carrier frequency of the target PCell of the failed handover;
- 3> include *previousPCellId* and set it to the global cell identity of the PCell where the last *RRCCONNECTIONRECONFIGURATION* message including *mobilityControlInfo* was received;
- 3> set the *timeConnFailure* to the elapsed time since reception of the last *RRCCONNECTIONRECONFIGURATION* message including the *mobilityControlInfo*;
- 3> set the *connectionFailureType* to 'hof';
- 2> initiate the connection re-establishment procedure as specified in 5.3.7, upon which the RRC connection reconfiguration procedure ends;

The UE may discard the handover failure information, i.e. release the UE variable *VarRLF-Report* 48 hours after the failure is detected.

NOTE 3: E-UTRAN may retrieve the handover failure information using the UE information procedure with *rlf-ReportReq* set to *true*, as specified in 5.6.5.3.

[TS 36.331, clause 5.3.7.4]

If the procedure was initiated due to radio link failure or handover failure, the UE shall:

- 1> set the *reestablishmentCellId* in the *VarRLF-Report* to the global cell identity of the selected cell;

[TS 36.331, clause 5.3.7.5]

The UE shall:

...

- 1> set the content of *RRCCONNECTIONREESTABLISHMENTCOMPLETE* message as follows:
 - 2> if the UE has radio link failure or handover failure information available in *VarRLF-Report* and *plmn-Identity* stored in *VarRLF-Report* is equal to the RPLMN:
 - 3> include the *rlf-InfoAvailable*;

...

1> submit the *RRCConnectionReestablishmentComplete* message to lower layers for transmission, upon which the procedure ends;

[TS 36.331, clause 5.6.5.3]

Upon receiving the *UEInformationRequest* message, the UE shall:

...

1> if *rlf-ReportReq* is set to *true* and the UE has radio link failure information or handover failure information available in *VarRLF-Report* and *plmn-Identity* stored in *VarRLF-Report* is equal to the RPLMN, set the *rlf-Report* in the *UEInformationResponse* message to the value of *rlf-Report* in *VarRLF-Report*;

1> if the *rlf-Report* is included in *UEInformationResponse*:

2> discard the *rlf-Report* from *VarRLF-Report* upon successful delivery of the *UEInformationResponse* message confirmed by lower layers.

...

1> if the *logMeasReport* is included in the *UEInformationResponse*:

...

1> else:

2> submit the *UEInformationResponse* message to lower layers for transmission via SRB1;

8.6.6.1.3 Test description

8.6.6.1.3.1 Pre-test conditions

System Simulator:

- Cell 1 and Cell 2

UE:

None.

Preamble:

- The UE is in state Generic RB Established (state 3) on Cell 1 according to [18].

8.6.6.1.3.2 Test procedure sequence

Table 8.6.6.1.3.2-1 illustrates the downlink power levels and other changing parameters to be applied for the cells at various time instants of the test execution. Row marked "T0" denotes the initial conditions after preamble, while columns marked "T1" and "T2" are to be applied subsequently. The exact instants on which these values shall be applied are described in the texts in this clause.

Table 8.6.6.1.3.2-1: Time instances of cell power level and parameter changes

	Parameter	Unit	Cell 1	Cell 2	Remark
T0	Cell-specific RS EPRE	dBm/15k Hz	-85	-91	The power level values are such that measurement results for Cell 1 (M1) and Cell 2 (M2) satisfy exit condition for event A3 (M2 < M1).
T1	Cell-specific RS EPRE	dBm/15k Hz	-85	-79	The power level values are such that measurement results for Cell 1 (M1) and Cell 2 (M2) satisfy entry condition for event A3 (M2 > M1).
T2	Cell-specific RS EPRE	dBm/15k Hz	-85	"Off"	Only Cell 1 is available. (NOTE 1)
NOTE 1: Power level "Off" is defined in TS 36.508 Table 6.2.2.1-1.					

Table 8.6.6.1.3.2-2: Main behaviour

St	Procedure	Message Sequence		TP	Verdict
		U - S	Message		
1	The SS transmits an <i>RRConnectionReconfiguration</i> message to setup intra-frequency measurement on Cell 1.	<--	<i>RRConnectionReconfiguration</i>	-	-
2	The UE transmits an <i>RRConnectionReconfigurationComplete</i> message on Cell 1.	-->	<i>RRConnectionReconfigurationComplete</i>	-	-
3	The SS changes Cell 2 parameters according to the row "T1" in Table 8.6.6.1.3.2-1.	-	-	-	-
4	The UE transmits a <i>MeasurementReport</i> message on Cell 1.	-->	<i>MeasurementReport</i>	-	-
5	The SS transmits an <i>RRConnectionReconfiguration</i> message including <i>mobilityControlInfo</i> on Cell 1.	<--	<i>RRConnectionReconfiguration</i>	-	-
-	EXCEPTION: In parallel to the events described in step 6 the steps specified in Table 8.6.6.1.3.2-3 should take place.	-	-	-	-
6	The SS changes Cell 2 parameter according to the row "T2" in Table 8.6.6.1.3.2-1.	-	-	-	-
7	The UE transmits an <i>RRConnectionReestablishmentRequest</i> message on Cell 1.	-->	<i>RRConnectionReestablishmentRequest</i>	-	-
8	The SS transmits an <i>RRConnectionReestablishment</i> message on Cell 1.	<--	<i>RRConnectionReestablishment</i>	-	-
9	The UE transmits an <i>RRConnectionReestablishmentComplete</i> message on Cell 1.	-->	<i>RRConnectionReestablishmentComplete</i>	-	-
10	The SS transmits an <i>RRConnectionReconfiguration</i> message on Cell 1.	<--	<i>RRConnectionReconfiguration</i>	-	-
11	The UE transmits an <i>RRConnectionReconfigurationComplete</i> message on Cell 1.	-->	<i>RRConnectionReconfigurationComplete</i>	-	-
12	The SS transmits a <i>UEInformationRequest</i> message on Cell 1.	<--	<i>UEInformationRequest</i>	-	-
13	Check: Does the UE transmit a <i>UEInformationResponse</i> message on Cell 1?	-->	<i>UEInformationResponse</i>	1	P
14	Check: Does the test result of generic test procedure in TS 36.508 subclause 6.4.2.3 indicate that the UE is in E-UTRA RRC_CONNECTED state on Cell 1?	-	-	1	-

Table 8.6.6.1.3.2-3: Parallel behaviour

St	Procedure	Message Sequence		TP	Verdict
		U - S	Message		
-	EXCEPTION: The steps 1 and 2 below are repeated for the duration of T304.	-	-	-	-
1	The UE attempts to perform the intra-frequency handover using MAC Random Access Preamble on Cell 2.	-	-	-	-
2	The SS does not respond.	-	-	-	-

8.6.6.1.3.3 Specific message contents

Table 8.6.6.1.3.3-1: *RRConnectionReconfiguration* (step 1, Table 8.6.6.1.3.2-2)

Derivation Path: 36.508, Table 4.6.1-8, condition MEAS
--

Table 8.6.6.1.3.3-2: MeasConfig (Table 8.6.6.1.3.3-1)

Derivation Path: 36.508, Table 4.6.6-1			
Information Element	Value/remark	Comment	Condition
MeasConfig ::= SEQUENCE {			
measObjectToAddModList SEQUENCE (SIZE (1..maxObjectId)) OF SEQUENCE {	1 entry		
measObjectId[1]	IdMeasObject-f1		
measObject[1]	MeasObjectEUTRA-GENERIC(f1)		
}			
reportConfigToAddModList SEQUENCE (SIZE (1..maxReportConfigId)) OF SEQUENCE {	1 entry		
reportConfigId[1]	IdReportConfig-A3		
reportConfig[1]	ReportConfigEUTRA-A3		
}			
measIdToAddModListSEQUENCE (SIZE (1..maxMeasId)) OF SEQUENCE {			
measId[1]	1		
measObjectId[1]	IdMeasObject-f1		
reportConfigId[1]	IdReportConfig-A3		
}			
}			

Table 8.6.6.1.3.3-3: MeasurementReport (step 4, Table 8.6.6.1.3.2-2)

Derivation Path: 36.508, Table 4.6.1-5			
Information Element	Value/remark	Comment	Condition
MeasurementReport ::= SEQUENCE {			
criticalExtensions CHOICE {			
c1 CHOICE{			
measurementReport-r8 SEQUENCE {			
measResults SEQUENCE {			
measId	1		
measResultPCell SEQUENCE {			
rsrpResult	(0..97)		
rsrqResult	(0..34)		
}			
measResultNeighCells CHOICE {			
measResultListEUTRA SEQUENCE (SIZE (1..maxCellReport)) OF SEQUENCE {	1 entry		
physCellId	PhysicalCellIdentity of Cell 2		
cgi-Info	Not present		
measResult SEQUENCE {			
rsrpResult	(0..97)		
rsrqResult	(0..34)		
additionalSI-Info-r9	Not present		
}			
}			
}			
measResultForECID-r9	Not present		
locationInfo-r10	Not present or any allowed value		
measResultServFreqList-r10	Not present		
}			
}			
}			
}			

Table 8.6.6.1.3.3-4: RRCConnectionReconfiguration (step 5, Table 8.6.6.1.3.2-2)

Derivation Path: 36.508, Table 4.6.1-8, condition HO

Table 8.6.6.1.3.3-5: MobilityControlInfo (Table 8.6.6.1.3.3-4)

Derivation Path: 36.508, Table 4.6.5-1			
Information Element	Value/remark	Comment	Condition
MobilityControlInfo ::= SEQUENCE {			
targetPhysCellId	PhysicalCellId of Cell 2		
carrierFreq	Not present		
}			

Table 8.6.6.1.3.3-6: RRCConnectionReestablishmentRequest (step 7, Table 8.6.6.1.3.2-2)

Derivation Path: 36.508, Table 4.6.1-13			
Information Element	Value/remark	Comment	Condition
RRCConnectionReestablishmentRequest ::= SEQUENCE {			
criticalExtensions CHOICE {			
rrcConnectionReestablishmentRequest-r8			
SEQUENCE {			
ue-Identity SEQUENCE {			
c-RNTI	the value of the C-RNTI of the UE		
physCellId	PhysicalCellId of Cell 1		
shortMAC-I	The same value as the 16 least significant bits of the XMAC-I value calculated by SS		
}			
reestablishmentCause	handoverFailure		
}			
}			

Table 8.6.6.1.3.3-7: RRCConnectionReestablishmentComplete (step 9, Table 8.6.6.1.3.2-2)

Derivation Path: 36.508, Table 4.6.1-11			
Information Element	Value/remark	Comment	Condition
RRCConnectionReestablishmentComplete ::= SEQUENCE {			
criticalExtensions CHOICE {			
rrcConnectionReestablishmentComplete-r8 =			
SEQUENCE {			
nonCriticalExtension SEQUENCE {			
rfl-InfoAvailable-r9	true		
nonCriticalExtension	Not present or any allowed value		
}			
}			
}			

Table 8.6.6.1.3.3-8: RRCConnectionReconfiguration (step 10, Table 8.6.6.1.3.2-2)

Derivation Path: 36.508, Table 4.6.1-8			
Information Element	Value/remark	Comment	Condition
RRCConnectionReconfiguration ::= SEQUENCE {			
criticalExtensions CHOICE {			
c1 CHOICE{			
rrcConnectionReconfiguration-r8 SEQUENCE {			
radioResourceConfigDedicated	RadioResourceConfigDe dicated-HO		
}			
}			
}			
}			

Table 8.6.6.1.3.3-9: UEInformationRequest (step 12, Table 8.6.6.1.3.2-2)

Derivation Path: 36.508, Table 4.6.1-23A			
Information Element	Value/remark	Comment	Condition
UEInformationRequest-r9 ::=SEQUENCE {			
criticalExtensions CHOICE {			
c1 CHOICE {			
ueInformationRequest-r9 SEQUENCE {			
rf-ReportReq-r9	TRUE		
}			
}			
}			
}			

Table 8.6.6.1.3.3-10: *UEInformationResponse* (step 13, Table 8.6.6.1.3.2-2)

Derivation Path: 36.508, Table 4.6.1-23B			
Information Element	Value/remark	Comment	Condition
<i>UEInformationResponse</i> -r9 ::=SEQUENCE {			
criticalExtensions CHOICE {			
c1 CHOICE {			
<i>ueInformationResponse</i> -r9 SEQUENCE {			
rfl-Report-r9 SEQUENCE {			
measResultLastServCell-r9 SEQUENCE {			
rsrpResult-r9	(0..97)		
rsrqResult-r9	Not present or (0..34)		
}			
measResultNeighCells-r9 SEQUENCE {			
measResultListEUTRA-r9 SEQUENCE (SIZE (1..maxFreq)) OF SEQUENCE {	1 entry		
carrierFreq-r9[1]	Same downlink EARFCN as used for Cell 2		
measResultList-r9[1] SEQUENCE (SIZE (1..maxCellReport)) OF SEQUENCE {	1 entry		
physCellId[1]	PhysicalCellIdentity of Cell 2		
cgi-Info[1]	Not present		
measResult[1] SEQUENCE {			
rsrpResult	(0..97)		
rsrqResult	(0..34)		
additionalSI-Info-r9	Not present		
}			
}			
}			
measResultListUTRA-r9	Not present		
measResultListGERAN-r9	Not present		
measResultsCDMA2000-r9	Not present		
}			
locationInfo-r10	Not present or any allowed value		
failedPCellId-r10 CHOICE {	cellGlobalId-r10 or pci-arfcn-r10	If the UE has the global cell identity depending on UE implementation, the UE sets the global cell identity, otherwise the UE sets the physical cell identity and the carrier frequency.	
cellGlobalId-r10 SEQUENCE {			
plmn-Identity	<i>plmn-Identity</i> within <i>SystemInformationBlockType1</i> broadcasted in Cell 2		
cellIdentity	<i>cellIdentity</i> within <i>SystemInformationBlockType1</i> broadcasted in Cell 2		
}			
pci-arfcn-r10 SEQUENCE {			
physCellId-r10	PhysicalCellIdentity of Cell 2		
carrierFreq-r10	Same downlink EARFCN as used for Cell 2		
}			
}			
reestablishmentCellId-r10 SEQUENCE {			
plmn-Identity	<i>plmn-Identity</i> within <i>SystemInformationBlockT</i>		

	<i>ype1</i> broadcasted in Cell 1		
cellIdentity	<i>cellIdentity</i> within <i>SystemInformationBlockType1</i> broadcasted in Cell 1		
}			
timeConnFailure-r10	Any allowed value		
connectionFailureType-r10	hof		
previousPCellId-r10 SEQUENCE {			
plmn-Identity	<i>plmn-Identity</i> within <i>SystemInformationBlockType1</i> broadcasted in Cell 1		
cellIdentity	<i>cellIdentity</i> within <i>SystemInformationBlockType1</i> broadcasted in Cell 1		
}			
}			
}			
}			
}			
}			

8.6.6.2 Handover Failure logging / Reporting of Inter-frequency measurements

8.6.6.2.1 Test Purpose (TP)

(1)

```

with { UE in RRC_CONNECTED having performed the inter-frequency measurement and reported that the UE
has handover failure information available }
ensure that {
  when { UE receives the UEInformationRequest message containing rlf-ReportReq }
  then { UE sends the UEInformationResponse message containing the measurement result for inter-
frequency neighbour cell }
}

```

8.6.6.2.2 Conformance requirements

References: The conformance requirements covered in the present TC are specified in: TS 36.331, clause 5.3.5.6, 5.3.7.4, 5.3.7.5 and 5.6.5.3.

[TS 36.331, clause 5.3.5.6]

The UE shall:

1> if T304 expires (handover failure):

NOTE: Following T304 expiry any dedicated preamble, if provided within the *rach-ConfigDedicated*, is not available for use by the UE anymore.

2> revert back to the configuration used in the source PCell, excluding the configuration configured by the *physicalConfigDedicated*, the *mac-MainConfig* and the *sps-Config*;

2> store the following handover failure information in *VarRLF-Report* by setting its fields as follows:

3> clear the information included in *VarRLF-Report*, if any;

3> set the *plmn-Identity* to the RPLMN;

3> set the *measResultLastServCell* to include the RSRP and RSRQ, if available, of the PCell based on measurements collected up to the moment the UE detected handover failure;

- 3> set the *measResultNeighCells* to include the best measured cells, other than the PCell, ordered such that the best cell is listed first, and based on measurements collected up to the moment the UE detected handover failure, and set its fields as follows;
 - 4> if the UE was configured to perform measurements for one or more EUTRA frequencies, include the *measResultListEUTRA*;
 - 4> if the UE was configured to perform measurement reporting for one or more neighbouring UTRA frequencies, include the *measResultListUTRA*;
 - 4> if the UE was configured to perform measurement reporting for one or more neighbouring GERAN frequencies, include the *measResultListGERAN*;
 - 4> if the UE was configured to perform measurement reporting for one or more neighbouring CDMA2000 frequencies, include the *measResultsCDMA2000*;

NOTE 1: The measured quantities are filtered by the L3 filter as configured in the mobility measurement configuration. The measurements are based on the time domain measurement resource restriction, if configured. Blacklisted cells are not required to be reported.

- 3> if detailed location information is available, set the content of the *locationInfo* as follows:
 - 4> include the *locationCoordinates*;
 - 4> include the *horizontalVelocity*, if available;
- 3> set the *failedPCellId* to the global cell identity, if available, and otherwise to the physical cell identity and carrier frequency of the target PCell of the failed handover;
- 3> include *previousPCellId* and set it to the global cell identity of the PCell where the last *RRCCONNECTIONRECONFIGURATION* message including *mobilityControlInfo* was received;
- 3> set the *timeConnFailure* to the elapsed time since reception of the last *RRCCONNECTIONRECONFIGURATION* message including the *mobilityControlInfo*;
- 3> set the *connectionFailureType* to 'hof';
- 2> initiate the connection re-establishment procedure as specified in 5.3.7, upon which the RRC connection reconfiguration procedure ends;

The UE may discard the handover failure information, i.e. release the UE variable *VarRLF-Report* 48 hours after the failure is detected.

NOTE 2: E-UTRAN may retrieve the handover failure information using the UE information procedure with *rlf-ReportReq* set to *true*, as specified in 5.6.5.3.

[TS 36.331, clause 5.3.7.4]

If the procedure was initiated due to radio link failure or handover failure, the UE shall:

- 1> set the *reestablishmentCellId* in the *VarRLF-Report* to the global cell identity of the selected cell;

[TS 36.331, clause 5.3.7.5]

The UE shall:

...

- 1> set the content of *RRCCONNECTIONREESTABLISHMENTCOMPLETE* message as follows:
 - 2> if the UE has radio link failure or handover failure information available in *VarRLF-Report* and *plmn-Identity* stored in *VarRLF-Report* is equal to the RPLMN:
 - 3> include the *rlf-InfoAvailable*;

...

1> submit the *RRCConnectionReestablishmentComplete* message to lower layers for transmission, upon which the procedure ends;

[TS 36.331, clause 5.6.5.3]

Upon receiving the *UEInformationRequest* message, the UE shall:

...

1> if *rlf-ReportReq* is set to *true* and the UE has radio link failure information or handover failure information available in *VarRLF-Report* and *plmn-Identity* stored in *VarRLF-Report* is equal to the RPLMN, set the *rlf-Report* in the *UEInformationResponse* message to the value of *rlf-Report* in *VarRLF-Report*;

1> if the *rlf-Report* is included in *UEInformationResponse*:

2> discard the *rlf-Report* from *VarRLF-Report* upon successful delivery of the *UEInformationResponse* message confirmed by lower layers.

...

1> if the *logMeasReport* is included in the *UEInformationResponse*:

...

1> else:

2> submit the *UEInformationResponse* message to lower layers for transmission via SRB1;

8.6.6.2.3 Test description

8.6.6.2.3.1 Pre-test conditions

System Simulator:

- Cell 1 and Cell 3
- System information combination 3 as defined in TS 36.508 [18] clause 4.4.3.1 is used in E-UTRA cells.

UE:

None.

Preamble:

- The UE is in state Generic RB Established (state 3) on Cell 1 according to [18].

8.6.6.2.3.2 Test procedure sequence

Table 8.6.6.2.3.2-1 illustrates the downlink power levels and other changing parameters to be applied for the cells at various time instants of the test execution. Row marked "T0" denotes the initial conditions after preamble, while columns marked "T1" and "T2" are to be applied subsequently. The exact instants on which these values shall be applied are described in the texts in this clause.

Table 8.6.6.2.3.2-1: Time instances of cell power level and parameter changes

	Parameter	Unit	Cell 1	Cell 3	Remark
T0	Cell-specific RS EPRE	dBm/15k Hz	-85	-97	The power level values are such that measurement results for Cell 1 (M1) and Cell 3 (M3) satisfy exit condition for event A3 (M3 < M1).
T1	Cell-specific RS EPRE	dBm/15k Hz	-85	-73	The power level values are such that measurement results for Cell 1 (M1) and Cell 3 (M3) satisfy entry condition for event A3 (M3 > M1).
T2	Cell-specific RS EPRE	dBm/15k Hz	-85	"Off"	Only Cell 1 is available. (NOTE 1)
NOTE 1: Power level "Off" is defined in TS 36.508 Table 6.2.2.1-1.					

Table 8.6.6.2.3.2-2: Main behaviour

St	Procedure	Message Sequence		TP	Verdict
		U - S	Message		
1	The SS transmits an <i>RRConnectionReconfiguration</i> message to setup inter-frequency measurement on Cell 1.	<--	<i>RRConnectionReconfiguration</i>	-	-
2	The UE transmits an <i>RRConnectionReconfigurationComplete</i> message on Cell 1.	-->	<i>RRConnectionReconfigurationComplete</i>	-	-
3	The SS changes Cell 3 parameters according to the row "T1" in Table 8.6.6.2.3.2-1.	-	-	-	-
4	The UE transmits a <i>MeasurementReport</i> message on Cell 1.	-->	<i>MeasurementReport</i>	-	-
5	The SS transmits an <i>RRConnectionReconfiguration</i> message including <i>mobilityControlInfo</i> on Cell 1.	<--	<i>RRConnectionReconfiguration</i>	-	-
-	EXCEPTION: In parallel to the events described in step 6 the steps specified in Table 8.6.6.2.3.2-3 should take place.	-	-	-	-
6	The SS changes Cell 3 parameter according to the row "T2" in Table 8.6.6.2.3.2-1.	-	-	-	-
7	The UE transmits an <i>RRConnectionReestablishmentRequest</i> message on Cell 1.	-->	<i>RRConnectionReestablishmentRequest</i>	-	-
8	The SS transmits an <i>RRConnectionReestablishment</i> message on Cell 1.	<--	<i>RRConnectionReestablishment</i>	-	-
9	The UE transmits an <i>RRConnectionReestablishmentComplete</i> message on Cell 1.	-->	<i>RRConnectionReestablishmentComplete</i>	-	-
10	The SS transmits an <i>RRConnectionReconfiguration</i> message on Cell 1.	<--	<i>RRConnectionReconfiguration</i>	-	-
11	The UE transmits an <i>RRConnectionReconfigurationComplete</i> message on Cell 1.	-->	<i>RRConnectionReconfigurationComplete</i>	-	-
12	The SS transmits a <i>UEInformationRequest</i> message on Cell 1.	<--	<i>UEInformationRequest</i>	-	-
13	Check: Does the UE transmit a <i>UEInformationResponse</i> message on Cell 1?	-->	<i>UEInformationResponse</i>	1	P
14	Check: Does the test result of generic test procedure in TS 36.508 subclause 6.4.2.3 indicate that the UE is in E-UTRA RRC_CONNECTED state on Cell 1?	-	-	1	-

Table 8.6.6.2.3.2-3: Parallel behaviour

St	Procedure	Message Sequence		TP	Verdict
		U - S	Message		
-	EXCEPTION: The steps 1 and 2 below are repeated for the duration of T304.	-	-	-	-
1	The UE attempts to perform the inter-frequency handover using MAC Random Access Preamble on Cell 3.	-	-	-	-
2	The SS does not respond.	-	-	-	-

8.6.6.2.3.3 Specific message contents

Table 8.6.6.2.3.3-1: *RRConnectionReconfiguration* (step 1, Table 8.6.6.2.3.2-2)

Derivation Path: 36.508, Table 4.6.1-8, condition MEAS
--

Table 8.6.6.2.3.3-2: *MeasConfig* (Table 8.6.6.2.3.3-1)

Derivation Path: 36.508, Table 4.6.6-1, condition INTER-FREQ			
Information Element	Value/remark	Comment	Condition
MeasConfig ::= SEQUENCE {			
measObjectToAddModList SEQUENCE (SIZE (1..maxObjectId)) OF SEQUENCE {	2 entries		
measObjectId[1]	IdMeasObject-f1		
measObject[1]	MeasObjectEUTRA-GENERIC(f1)		
measObjectId[2]	IdMeasObject-f2		
measObject[2]	MeasObjectEUTRA-GENERIC(f2)		
}			
reportConfigToAddModList SEQUENCE (SIZE (1..maxReportConfigId)) OF SEQUENCE {	1 entry		
reportConfigId[1]	IdReportConfig-A3		
reportConfig[1]	ReportConfigEUTRA-A3		
}			
measIdToAddModList SEQUENCE (SIZE (1..maxMeasId)) OF SEQUENCE {			
measId[1]	1		
measObjectId[1]	IdMeasObject-f2		
reportConfigId[1]	IdReportConfig-A3		
}			
}			

Table 8.6.6.2.3.3-3: *MeasurementReport* (step 4, Table 8.6.6.2.3.2-2)

Derivation Path: 36.508, Table 4.6.1-5			
Information Element	Value/remark	Comment	Condition
MeasurementReport ::= SEQUENCE {			
criticalExtensions CHOICE {			
c1 CHOICE{			
measurementReport-r8 SEQUENCE {			
measResults SEQUENCE {			
measId	1		
measResultServCell SEQUENCE {			
rsrpResult	(0..97)		
rsrqResult	(0..34)		
}			
measResultNeighCells CHOICE {			
measResultListEUTRA SEQUENCE (SIZE (1..maxCellReport)) OF SEQUENCE {	1 entry		
physCellId	PhysicalCellIdentity of Cell 3		
cgi-Info	Not present		
measResult SEQUENCE {			
rsrpResult	(0..97)		
rsrqResult	(0..34)		
additionalSI-Info-r9	Not present		
}			
}			
}			
measResultForECID-r9	Not present		
}			
}			
}			

Table 8.6.6.2.3.3-4: RRCConnectionReconfiguration (step 5, Table 8.6.6.2.3.2-2)

Derivation Path: 36.508, Table 4.6.1-8, condition HO

Table 8.6.6.2.3.3-5: MobilityControlInfo (Table 8.6.6.2.3.3-5)

Derivation Path: 36.508, Table 4.6.5-1			
Information Element	Value/remark	Comment	Condition
MobilityControlInfo ::= SEQUENCE {			
targetPhysCellId	PhysicalCellIdentity of Cell 3		
carrierFreq SEQUENCE {			
dl-CarrierFreq	Same downlink EARFCN as used for Cell 3		
ul-CarrierFreq	Not present		
}			
}			

Table 8.6.6.2.3.3-6: RRCConnectionReestablishmentRequest (step 7, Table 8.6.6.2.3.2-2)

Derivation Path: 36.508, Table 4.6.1-13			
Information Element	Value/remark	Comment	Condition
RRCConnectionReestablishmentRequest ::= SEQUENCE {			
criticalExtensions CHOICE {			
rrcConnectionReestablishmentRequest-r8 SEQUENCE {			
ue-Identity SEQUENCE {			
c-RNTI	the value of the C-RNTI of the UE		
physCellId	PhysicalCellIdentity of Cell 1		
shortMAC-I	The same value as the 16 least significant bits of the XMAC-I value calculated by SS		
}			
reestablishmentCause	handoverFailure		
}			
}			
}			

Table 8.6.6.2.3.3-7: RRCConnectionReestablishmentComplete (step 9, Table 8.6.6.2.3.2-2)

Derivation Path: 36.508, Table 4.6.1-11			
Information Element	Value/remark	Comment	Condition
RRCConnectionReestablishmentComplete ::= SEQUENCE {			
criticalExtensions CHOICE {			
rrcConnectionReestablishmentComplete-r8 = SEQUENCE {			
nonCriticalExtension SEQUENCE {			
rfl-InfoAvailable-r9	true		
nonCriticalExtension	Not present or any allowed value		
}			
}			
}			
}			

Table 8.6.6.2.3.3-8: RRCConnectionReconfiguration (step 10, Table 8.6.6.2.3.2-2)

Derivation Path: 36.508, Table 4.6.1-8			
Information Element	Value/remark	Comment	Condition
RRCConnectionReconfiguration ::= SEQUENCE {			
criticalExtensions CHOICE {			
c1 CHOICE {			
rrcConnectionReconfiguration-r8 SEQUENCE {			
radioResourceConfigDedicated	RadioResourceConfigDe dicated-HO		
}			
}			
}			
}			

Table 8.6.6.2.3.3-9: UEInformationRequest (step 12, Table 8.6.6.2.3.2-2)

Derivation Path: 36.508, Table 4.6.1-23A			
Information Element	Value/remark	Comment	Condition
UEInformationRequest-r9 ::= SEQUENCE {			
criticalExtensions CHOICE {			
c1 CHOICE {			
ueInformationRequest-r9 SEQUENCE {			
rf-ReportReq-r9	TRUE		
}			
}			
}			
}			

Table 8.6.6.2.3.3-10: *UEInformationResponse* (step 13, Table 8.6.6.2.3.2-2)

Derivation Path: 36.508, Table 4.6.1-23B			
Information Element	Value/remark	Comment	Condition
<i>UEInformationResponse</i> -r9 ::=SEQUENCE {			
criticalExtensions CHOICE {			
c1 CHOICE {			
<i>ueInformationResponse</i> -r9 SEQUENCE {			
rfl-Report-r9 SEQUENCE {			
measResultLastServCell-r9 SEQUENCE {			
rsrpResult-r9	(0..97)		
rsrqResult-r9	Not present or (0..34)		
}			
measResultNeighCells-r9 SEQUENCE {			
measResultListEUTRA-r9 SEQUENCE (SIZE (1..maxFreq)) OF SEQUENCE {	1 entry		
carrierFreq-r9[1]	Same downlink EARFCN as used for Cell 3		
measResultList-r9[1] SEQUENCE (SIZE (1..maxCellReport)) OF SEQUENCE {	1 entry		
physCellId[1]	PhysicalCellId of Cell 3		
cgi-Info[1]	Not present		
measResult[1] SEQUENCE {			
rsrpResult	(0..97)		
rsrqResult	(0..34)		
additionalSI-Info-r9	Not present		
}			
}			
}			
measResultListUTRA-r9	Not present		
measResultListGERAN-r9	Not present		
measResultsCDMA2000-r9	Not present		
}			
locationInfo-r10	Not present or any allowed value		
failedPCellId-r10 CHOICE {	cellGlobalId-r10 or pci-arfcn-r10	If the UE has the global cell identity depending on UE implementation, the UE sets the global cell identity, otherwise the UE sets the physical cell identity and the carrier frequency.	
cellGlobalId-r10 SEQUENCE {			
plmn-Identity	<i>plmn-Identity</i> within <i>SystemInformationBlockType1</i> broadcasted in Cell 3		
cellIdentity	<i>cellIdentity</i> within <i>SystemInformationBlockType1</i> broadcasted in Cell 3		
}			
pci-arfcn-r10 SEQUENCE {			
physCellId-r10	PhysicalCellId of Cell 3		
carrierFreq-r10	Same downlink EARFCN as used for Cell 3		
}			
}			
reestablishmentCellId-r10 SEQUENCE {			
plmn-Identity	<i>plmn-Identity</i> within <i>SystemInformationBlockT</i>		

	<i>ype1</i> broadcasted in Cell 1		
cellIdentity	<i>cellIdentity</i> within <i>SystemInformationBlockType1</i> broadcasted in Cell 1		
}			
timeConnFailure-r10	Any allowed value		
connectionFailureType-r10	hof		
previousPCellId-r10 SEQUENCE {			
plmn-Identity	<i>plmn-Identity</i> within <i>SystemInformationBlockType1</i> broadcasted in Cell 1		
cellIdentity	<i>cellIdentity</i> within <i>SystemInformationBlockType1</i> broadcasted in Cell 1		
}			
}			
}			
}			
}			
}			

8.6.6.3 Handover Failure logging / Reporting of HOF report availability / PLMN change

8.6.6.3.1 Test Purpose (TP)

(1)

```
with { UE in RRC_CONNECTED having detected handover failure }
ensure that {
  when { UE moves to the cell that belongs to the PLMN different from the PLMN where the handover
failure was detected }
    then { UE does not indicate IE rlf-InfoAvailable }
}
```

(2)

```
with { UE in RRC_CONNECTED having detected handover failure }
ensure that {
  when { UE returns to the cell that belongs to the PLMN where the handover failure was detected }
    then { UE indicates IE rlf-InfoAvailable }
}
```

8.6.6.3.2 Conformance requirements

References: The conformance requirements covered in the present TC are specified in: TS 36.331, clause 5.3.3.4 and 5.3.5.6.

[TS 36.331, clause 5.3.3.4 (TP1, TP2)]

The UE shall:

1> set the content of *RRCConnectionSetupComplete* message as follows:

...

2> if the UE has radio link failure or handover failure information available in *VarRLF-Report* and *plmn-Identity* stored in *VarRLF-Report* is equal to the RPLMN:

3> include *rlf-InfoAvailable*;

...

- 2> submit the *RRCConnectionSetupComplete* message to lower layers for transmission, upon which the procedure ends;

[TS 36.331, clause 5.3.5.6 (TP1, TP2)]

The UE shall:

- 1> if T304 expires (handover failure):

NOTE 1: Following T304 expiry any dedicated preamble, if provided within the *rach-ConfigDedicated*, is not available for use by the UE anymore.

- 2> revert back to the configuration used in the source PCell, excluding the configuration configured by the *physicalConfigDedicated*, the *mac-MainConfig* and the *sps-Config*;
- 2> store the following handover failure information in *VarRLF-Report* by setting its fields as follows:
 - 3> clear the information included in *VarRLF-Report*, if any;
 - 3> set the *plmn-Identity* to the RPLMN;
 - 3> set the *measResultLastServCell* to include the RSRP and RSRQ, if available, of the PCell based on measurements collected up to the moment the UE detected handover failure;
 - 3> set the *measResultNeighCells* to include the best measured cells, other than the PCell, ordered such that the best cell is listed first, and based on measurements collected up to the moment the UE detected handover failure, and set its fields as follows:
 - 4> if the UE was configured to perform measurements for one or more EUTRA frequencies, include the *measResultListEUTRA*;
 - 4> if the UE was configured to perform measurement reporting for one or more neighbouring UTRA frequencies, include the *measResultListUTRA*;
 - 4> if the UE was configured to perform measurement reporting for one or more neighbouring GERAN frequencies, include the *measResultListGERAN*;
 - 4> if the UE was configured to perform measurement reporting for one or more neighbouring CDMA2000 frequencies, include the *measResultsCDMA2000*;

NOTE 2: The measured quantities are filtered by the L3 filter as configured in the mobility measurement configuration. The measurements are based on the time domain measurement resource restriction, if configured. Blacklisted cells are not required to be reported.

- 3> if detailed location information is available, set the content of the *locationInfo* as follows:
 - 4> include the *locationCoordinates*;
 - 4> include the *horizontalVelocity*, if available;
- 3> set the *failedPCellId* to the global cell identity, if available, and otherwise to the physical cell identity and carrier frequency of the target PCell of the failed handover;
- 3> include *previousPCellId* and set it to the global cell identity of the PCell where the last *RRCConnectionReconfiguration* message including *mobilityControlInfo* was received;
- 3> set the *timeConnFailure* to the elapsed time since reception of the last *RRCConnectionReconfiguration* message including the *mobilityControlInfo*;
- 3> set the *connectionFailureType* to 'hof';
- 2> initiate the connection re-establishment procedure as specified in 5.3.7, upon which the RRC connection reconfiguration procedure ends;

The UE may discard the handover failure information, i.e. release the UE variable *VarRLF-Report*, 48 hours after the failure is detected, upon power off or upon detach.

NOTE 3: E-UTRAN may retrieve the handover failure information using the UE information procedure with *rlf-ReportReq* set to *true*, as specified in 5.6.5.3.

8.6.6.3.3 Test description

8.6.6.3.3.1 Pre-test conditions

System Simulator:

- Cell 1, Cell 2 and Cell 12
- System information combination 3 as defined in TS 36.508 [18] clause 4.4.3.1 is used in E-UTRA cells.

UE:

None.

Preamble:

- The UE is in state Generic RB Established (state 3) on Cell 1 according to [18].

8.6.6.3.3.2 Test procedure sequence

Table 8.6.6.3.3.2-1 illustrates the downlink power levels and other changing parameters to be applied for the cells at various time instants of the test execution. Configurations marked "T1", "T2", "T3", and "T4" are applied at the points indicated in the Main behaviour description in Table 8.6.6.3.3.2-2. The exact instants on which these values shall be applied are described in the texts in this clause.

Table 8.6.6.3.3.2-1: Time instances of cell power level and parameter changes

	Parameter	Unit	Cell 1	Cell 2	Cell 12	Remark
T1	Cell-specific RS EPRE	dBm/15kHz	-85	-79	"Off"	The power level values are such that measurement results for Cell 1 (M1) and Cell 2 (M2) satisfy entry condition for event A3 ($M2 > M1$). (NOTE 1)
T2	Cell-specific RS EPRE	dBm/15kHz	"Off"	-79	"Off"	Only Cell 2 is available. (NOTE1)
T3	Cell-specific RS EPRE	dBm/15kHz	"Off"	-85	-73	The power level values are assigned to satisfy $R_{Cell\ 2} < R_{Cell\ 12}$. (NOTE 1)
T4	Cell-specific RS EPRE	dBm/15kHz	-73	"Off"	-85	The power level values are assigned to satisfy $R_{Cell\ 1} > R_{Cell\ 12}$. (NOTE 1)
NOTE 1: Power level "Off" is defined in TS 36.508 Table 6.2.2.1-1.						

Table 8.6.6.3.3.2-2: Main behaviour

St	Procedure	Message Sequence		TP	Verdict
		U - S	Message		
1	The SS transmits an <i>RRConnectionReconfiguration</i> message to setup intra-frequency measurement on Cell 1.	<--	<i>RRConnectionReconfiguration</i>	-	-
2	The UE transmits an <i>RRConnectionReconfigurationComplete</i> message on Cell 1.	-->	<i>RRConnectionReconfigurationComplete</i>	-	-
3	The SS changes Cell 1 and Cell 2 parameters according to the row "T1" in Table 8.6.6.3.3.2-1.	-	-	-	-
4	The UE transmits a <i>MeasurementReport</i> message on Cell 1.	-->	<i>MeasurementReport</i>	-	-
5	The SS transmits an <i>RRConnectionReconfiguration</i> message including <i>mobilityControlInfo</i> on Cell 1.	<--	<i>RRConnectionReconfiguration</i>	-	-
-	EXCEPTION: In parallel to the events described in step 6 the steps specified in Table 8.6.6.3.3.2-3 should take place.	-	-	-	-
6	The SS changes Cell 1 parameter according to the row "T2" in Table 8.6.6.3.3.2-1.	-	-	-	-
7	The UE transmits an <i>RRConnectionReestablishmentRequest</i> message on Cell 2.	-->	<i>RRConnectionReestablishmentRequest</i>	-	-
8	The SS transmits an <i>RRConnectionReestablishment</i> message on Cell 2.	<--	<i>RRConnectionReestablishment</i>	-	-
9	The UE transmits an <i>RRConnectionReestablishmentComplete</i> message with handover failure information on Cell 2.	-->	<i>RRConnectionReestablishmentComplete</i>	-	-
10	The SS transmits an <i>RRConnectionReconfiguration</i> message on Cell 2.	<--	<i>RRConnectionReconfiguration</i>	-	-
11	The UE transmits an <i>RRConnectionReconfigurationComplete</i> message on Cell 2.	-->	<i>RRConnectionReconfigurationComplete</i>	-	-
12	The SS transmits an <i>RRConnectionRelease</i> message on Cell 2.	<--	<i>RRConnectionRelease</i>	-	-
13	Wait for 5 s for the UE to enter E-UTRA RRC_IDLE state.	-	-	-	-
14	The SS changes Cell 2 and Cell 12 parameters according to the row "T3" in Table 8.6.6.3.3.2-1.	-	-	-	-
15-16	Steps 1 to 2 of the generic test procedure in TS 36.508 [18] subclause 6.4.2.7 are performed on Cell 12.	-	-	-	-
17	Check: Does the UE transmit an <i>RRConnectionSetupComplete</i> message without handover failure information on Cell 12? This message includes a TRACKING AREA UPDATE REQUEST message.	-->	<i>RRConnectionSetupComplete</i>	1	P
18-20	Steps 4 to 6 of the generic test procedure in TS 36.508 [18] subclause 6.4.2.7 are performed on Cell 12. Note: The UE performs a TAU procedure and the RRC connection is released.	-	-	-	-
21	Wait for 5 s for the UE to enter E-UTRA RRC_IDLE state.	-	-	-	-
22	The SS changes Cell 1, Cell 2 and Cell 12 parameters according to the row "T4" in Table 8.6.6.3.3.2-1.	-	-	-	-
23-24	Steps 1 to 2 of the generic test procedure in TS 36.508 [18] subclause 6.4.2.7 are performed on Cell 1.	-	-	-	-

25	Check: Does the UE transmit an <i>RRCCConnectionSetupComplete</i> message with handover failure information on Cell 1? This message includes a TRACKING AREA UPDATE REQUEST message.	-->	<i>RRCCConnectionSetupComplete</i>	2	P
26-28	Steps 4 to 6 of the generic test procedure in TS 36.508 [18] subclause 6.4.2.7 are performed on Cell 1. Note: The UE performs a TAU procedure and the RRC connection is released.	-	-	-	-
29	Wait for 5 s for the UE to enter E-UTRA RRC_IDLE state.	-	-	-	-
30	Check: Does the test result of generic test procedure in TS 36.508 subclause 6.4.2.2 indicate that the UE is in E-UTRA RRC_IDLE state on Cell 1?	-	-	2	-

Table 8.6.6.3.3.2-3: Parallel behaviour

St	Procedure	Message Sequence		TP	Verdict
		U - S	Message		
-	EXCEPTION: The steps 1 and 2 below are repeated for the duration of T304.	-	-	-	-
1	The UE attempts to perform the intra-frequency handover using MAC Random Access Preamble on Cell 2.	-	-	-	-
2	The SS does not respond.	-	-	-	-

8.6.6.3.3.3 Specific message contents

Table 8.6.6.3.3.3-1: *SystemInformationBlockType2* for Cell 2 (preamble and all steps, Table 8.6.6.3.3.2-2)

Derivation Path: 36.508, Table 4.4.3.3-1			
Information Element	Value/remark	Comment	Condition
SystemInformationBlockType2 ::= SEQUENCE {			
radioResourceConfigCommon SEQUENCE {			
rach-ConfigCommon SEQUENCE {			
ra-SupervisionInfo SEQUENCE {			
preambleTransMax	n50		
}			
}			
uplinkPowerControlCommon-v1020	Not present		
}			
lateNonCriticalExtension	Not present		
ssac-BarringForMMTEL-Voice-r9	Not present		
ssac-BarringForMMTEL-Video-r9	Not present		
ac-BarringForCSFB-r10	Not present		
}			

Table 8.6.6.3.3.3-2: *RRCCConnectionReconfiguration* (step 1, Table 8.6.6.3.3.2-2)

Derivation Path: 36.508, Table 4.6.1-8, condition MEAS
--

Table 8.6.6.3.3.3-3: MeasConfig (Table 8.6.6.3.3.2)

Derivation Path: 36.508, Table 4.6.6-1			
Information Element	Value/remark	Comment	Condition
MeasConfig ::= SEQUENCE {			
measObjectToAddModList SEQUENCE (SIZE (1..maxObjectId)) OF SEQUENCE {	1 entry		
measObjectId[1]	IdMeasObject-f1		
measObject[1]	MeasObjectEUTRA-GENERIC(f1)		
}			
reportConfigToAddModList SEQUENCE (SIZE (1..maxReportConfigId)) OF SEQUENCE {	1 entry		
reportConfigId[1]	IdReportConfig-A3		
reportConfig[1]	ReportConfigEUTRA-A3		
}			
measIdToAddModList SEQUENCE (SIZE (1..maxMeasId)) OF SEQUENCE {			
measId[1]	1		
measObjectId[1]	IdMeasObject-f1		
reportConfigId[1]	IdReportConfig-A3		
}			
}			

Table 8.6.6.3.3.3-4: MeasurementReport (step 4, Table 8.6.6.3.3.2-2)

Derivation Path: 36.508, Table 4.6.1-5			
Information Element	Value/remark	Comment	Condition
MeasurementReport ::= SEQUENCE {			
criticalExtensions CHOICE {			
c1 CHOICE {			
measurementReport-r8 SEQUENCE {			
measResults SEQUENCE {			
measId	1		
measResultServCell SEQUENCE {			
rsrpResult	(0..97)		
rsrqResult	(0..34)		
}			
measResultNeighCells CHOICE {			
measResultListEUTRA SEQUENCE (SIZE (1..maxCellReport)) OF SEQUENCE {	1 entry		
physCellId	PhysicalCellIdentity of Cell 2		
cgi-Info	Not present		
measResult SEQUENCE {			
rsrpResult	(0..97)		
rsrqResult	(0..34)		
additionalSI-Info-r9	Not present		
}			
}			
}			
measResultForECID-r9	Not present		
}			
}			
}			
}			

Table 8.6.6.3.3.3-5: RRCConnectionReconfiguration (step 5, Table 8.6.6.3.3.2-2)

Derivation Path: 36.508, Table 4.6.1-8, condition HO
--

Table 8.6.6.3.3.3-6: *MobilityControlInfo* (Table 8.6.6.3.3.3-5)

Derivation Path: 36.508, Table 4.6.5-1			
Information Element	Value/remark	Comment	Condition
MobilityControlInfo ::= SEQUENCE {			
targetPhysCellId	PhysicalCellId of Cell 2		
carrierFreq	Not present		
}			

Table 8.6.6.3.3.3-7: *RRCCConnectionReestablishmentRequest* (step 7, Table 8.6.6.3.3.2-2)

Derivation Path: 36.508, Table 4.6.1-13			
Information Element	Value/remark	Comment	Condition
RRCCConnectionReestablishmentRequest ::= SEQUENCE {			
criticalExtensions CHOICE {			
rrcConnectionReestablishmentRequest-r8 SEQUENCE {			
ue-Identity SEQUENCE {			
c-RNTI	the value of the C-RNTI of the UE		
physCellId	PhysicalCellId of Cell 1		
shortMAC-I	The same value as the 16 least significant bits of the XMAC-I value calculated by SS		
}			
reestablishmentCause	handoverFailure		
}			
}			

Table 8.6.6.3.3.3-8: *RRCCConnectionReestablishmentComplete* (step 9, Table 8.6.6.3.3.2-2)

Derivation Path: 36.508, Table 4.6.1-11			
Information Element	Value/remark	Comment	Condition
RRCCConnectionReestablishmentComplete ::= SEQUENCE {			
criticalExtensions CHOICE {			
rrcConnectionReestablishmentComplete-r8 = SEQUENCE {			
nonCriticalExtension SEQUENCE {			
rf-InfoAvailable-r9	true		
nonCriticalExtension	Not present or any allowed value		
}			
}			
}			
}			

Table 8.6.6.3.3.3-9: RRCConnectionReconfiguration (step 10, Table 8.6.6.3.3.2-2)

Derivation Path: 36.508, Table 4.6.1-8			
Information Element	Value/remark	Comment	Condition
RRCConnectionReconfiguration ::= SEQUENCE {			
criticalExtensions CHOICE {			
c1 CHOICE{			
rrcConnectionReconfiguration-r8 SEQUENCE {			
radioResourceConfigDedicated	RadioResourceConfigDe dicated-HO		
}			
}			
}			
}			

Table 8.6.6.3.3.3-10: RRCConnectionSetupComplete (step 25, Table 8.6.6.3.3.2-2)

Derivation Path: 36.508, Table 4.6.1-18			
Information Element	Value/remark	Comment	Condition
RRCConnectionSetupComplete ::= SEQUENCE {			
criticalExtensions CHOICE {			
c1 CHOICE{			
rrcConnectionSetupComplete-r8 SEQUENCE {			
nonCriticalExtension SEQUENCE {			
nonCriticalExtension SEQUENCE {			
gummei-Type-r10	native		
rlf-InfoAvailable-r10	true		
logMeasAvailable-r10	Not present		
rn-SubframeConfigReq-r10	Not present		
nonCriticalExtension	Not present		
}			
}			
}			
}			
}			
}			

8.6.6.4 Handover Failure logging / Location information

8.6.6.4.1 Test Purpose (TP)

(1)

```

with { UE in RRC_CONNECTED having performed the intra-frequency measurement and reported that the UE
has handover failure information with location information available }
ensure that {
  when { UE receives the UEInformationRequest message containing rlf-ReportReq }
  then { UE sends the UEInformationResponse message containing the measurement result for intra-
frequency neighbour cell including locationCoordinates }
}

```

8.6.6.4.2 Conformance requirements

References: The conformance requirements covered in the present TC are specified in: TS 34.306, clause 4.3.13.2; TS 36.331, clause 5.3.5.6 and 5.6.5.3.

[TS 36.306, clause 4.3.13.2 (TP1)]

standaloneGNSS-Location

This parameter defines whether the UE is equipped with a standalone GNSS receiver that may be used to provide detailed location information in RRC measurement report and logged measurements in RRC_IDLE.

[TS 36.331, clause 5.3.5.6]

The UE shall:

1> if T304 expires (handover failure):

NOTE 1: Following T304 expiry any dedicated preamble, if provided within the *rach-ConfigDedicated*, is not available for use by the UE anymore.

2> revert back to the configuration used in the source PCell, excluding the configuration configured by the *physicalConfigDedicated*, the *mac-MainConfig* and the *sps-Config*;

2> store the following handover failure information in *VarRLF-Report* by setting its fields as follows:

3> clear the information included in *VarRLF-Report*, if any;

3> set the *plmn-Identity* to the RPLMN;

3> set the *measResultLastServCell* to include the RSRP and RSRQ, if available, of the PCell based on measurements collected up to the moment the UE detected handover failure;

3> set the *measResultNeighCells* to include the best measured cells, other than the PCell, ordered such that the best cell is listed first, and based on measurements collected up to the moment the UE detected handover failure, and set its fields as follows;

4> if the UE was configured to perform measurements for one or more EUTRA frequencies, include the *measResultListEUTRA*;

4> if the UE was configured to perform measurement reporting for one or more neighbouring UTRA frequencies, include the *measResultListUTRA*;

4> if the UE was configured to perform measurement reporting for one or more neighbouring GERAN frequencies, include the *measResultListGERAN*;

4> if the UE was configured to perform measurement reporting for one or more neighbouring CDMA2000 frequencies, include the *measResultsCDMA2000*;

NOTE 2: The measured quantities are filtered by the L3 filter as configured in the mobility measurement configuration. The measurements are based on the time domain measurement resource restriction, if configured. Blacklisted cells are not required to be reported.

3> if detailed location information is available, set the content of the *locationInfo* as follows:

4> include the *locationCoordinates*;

4> include the *horizontalVelocity*, if available;

3> set the *failedPCellId* to the global cell identity, if available, and otherwise to the physical cell identity and carrier frequency of the target PCell of the failed handover;

3> include *previousPCellId* and set it to the global cell identity of the PCell where the last *RRCCONNECTIONRECONFIGURATION* message including *mobilityControlInfo* was received;

3> set the *timeConnFailure* to the elapsed time since reception of the last *RRCCONNECTIONRECONFIGURATION* message including the *mobilityControlInfo*;

3> set the *connectionFailureType* to 'hof';

2> initiate the connection re-establishment procedure as specified in 5.3.7, upon which the RRC connection reconfiguration procedure ends;

The UE may discard the handover failure information, i.e. release the UE variable *VarRLF-Report* 48 hours after the failure is detected.

NOTE 3: E-UTRAN may retrieve the handover failure information using the UE information procedure with *rlf-ReportReq* set to *true*, as specified in 5.6.5.3.

[TS 36.331, clause 5.6.5.3]

Upon receiving the *UEInformationRequest* message, the UE shall:

...

1> if *rlf-ReportReq* is set to *true* and the UE has radio link failure information or handover failure information available in *VarRLF-Report* and *plmn-Identity* stored in *VarRLF-Report* is equal to the RPLMN, set the *rlf-Report* in the *UEInformationResponse* message to the value of *rlf-Report* in *VarRLF-Report*;

1> if the *rlf-Report* is included in *UEInformationResponse*:

2> discard the *rlf-Report* from *VarRLF-Report* upon successful delivery of the *UEInformationResponse* message confirmed by lower layers.

...

1> if the *logMeasReport* is included in the *UEInformationResponse*:

...

1> else:

2> submit the *UEInformationResponse* message to lower layers for transmission via SRB1;

8.6.6.4.3 Test description

8.6.6.4.3.1 Pre-test conditions

System Simulator:

- Cell 1 and Cell 2

UE:

None.

Preamble:

- The UE's positioning engine (e.g. standalone GNSS receiver) should be provided with any necessary stimulus to allow it to provide the position. This shall be done by use of the test function Update UE Location Information defined in TS 36.509 [25], if supported by the UE according to *pc_UpdateUE_LocationInformation*. Otherwise, or in addition any other suitable method may also be used.
- The UE is in state Generic RB Established (state 3) on Cell 1 according to [18].

8.6.6.4.3.2 Test procedure sequence

Same test procedure as specified in 8.6.6.1.3.2 with the following exception:

- The specific message content for the *UEInformationResponse* message in Table 8.6.6.1.3.3-10 is replaced by the specific message content in Table 8.6.6.4.3.3-1.

8.6.6.4.3.3 Specific message contents

Table 8.6.6.4.3.3-1: UEInformationResponse (step 13, Table 8.6.6.1.3.2-2)

Derivation Path: 36.508, Table 4.6.1-23B			
Information Element	Value/remark	Comment	Condition
UEInformationResponse-r9 ::=SEQUENCE {			
criticalExtensions CHOICE {			
c1 CHOICE {			
ueInformationResponse-r9 SEQUENCE {			
rf-Report-r9 SEQUENCE {			
measResultLastServCell-r9 SEQUENCE {			
rsrpResult-r9	(0..97)		
rsrqResult-r9	Not present or (0..34)		
}			
measResultNeighCells-r9 SEQUENCE {			
measResultListEUTRA-r9 SEQUENCE (SIZE (1..maxFreq)) OF SEQUENCE {	1 entry		
carrierFreq-r9[1]	Same downlink EARFCN as used for Cell 2		
measResultList-r9[1] SEQUENCE (SIZE (1..maxCellReport)) OF SEQUENCE {	1 entry		
physCellId[1]	PhysicalCellId of Cell 2		
cgi-Info[1]	Not present		
measResult[1] SEQUENCE {			
rsrpResult	(0..97)		
rsrqResult	(0..34)		
additionalSI-Info-r9	Not present		
}			
}			
measResultListUTRA-r9	Not present		
measResultListGERAN-r9	Not present		
measResultsCDMA2000-r9	Not present		
}			
locationInfo-r10 SEQUENCE {			
locationCoordinates-r10 CHOICE {			
ellipsoid-Point-r10	Any allowed value		
ellipsoidPointWithAltitude-r10	Any allowed value		
}			
failedPCellId-r10 CHOICE {	cellGlobalId-r10 or pci-arfcn-r10	If the UE has the global cell identity depending on UE implementation, the UE sets the global cell identity, otherwise the UE sets the physical cell identity and the carrier frequency.	
cellGlobalId-r10 SEQUENCE {			
plmn-Identity	<i>plmn-Identity</i> within <i>SystemInformationBlockType1</i> broadcasted in Cell 2		
cellIdentity	<i>cellIdentity</i> within <i>SystemInformationBlockType1</i> broadcasted in Cell 2		
}			
pci-arfcn-r10 SEQUENCE {			
physCellId-r10	PhysicalCellId of Cell 2		
carrierFreq-r10	Same downlink EARFCN		

	as used for Cell 2		
}			
}			
reestablishmentCellId-r10 SEQUENCE {			
plmn-Identity	<i>plmn-Identity</i> within <i>SystemInformationBlockType1</i> broadcasted in Cell 1		
cellIdentity	<i>cellIdentity</i> within <i>SystemInformationBlockType1</i> broadcasted in Cell 1		
}			
timeConnFailure-r10	Any allowed value		
connectionFailureType-r10	hof		
previousPCellId-r10 SEQUENCE {			
plmn-Identity	<i>plmn-Identity</i> within <i>SystemInformationBlockType1</i> broadcasted in Cell 1		
cellIdentity	<i>cellIdentity</i> within <i>SystemInformationBlockType1</i> broadcasted in Cell 1		
}			
}			
}			
}			
}			
}			
}			

8.6.6.5 Handover Failure logging / Logging and reporting / Reporting at RRC connection establishment / PLMN list

8.6.6.5.1 Test Purpose (TP)

(1)

```
with { UE in RRC_CONNECTED having detected handover failure }
ensure that {
  when { UE reselects to a cell that belongs to a PLMN which is different from the PLMN where the
handover failure was detected but included in the plmn_IdentityList stored in VarRLF-Report }
  then { UE transmits the RRCConnectionSetupComplete with IE rlf-InfoAvailable included }
}
```

(2)

```
with { UE indicated the availability of handover failure information in RRCConnectionSetupComplete
message and the RPLMN is included in plmn-IdentityList stored in VarRLF-Report: }
ensure that {
  when { UE receives a UEInformationRequest message with rlf-ReportReq set to true }
  then { UE transmits a UEInformationResponse message including rlf-Report }
}
```

8.6.6.5.2 Conformance requirements

References: The conformance requirements covered in the present TC are specified in: TS 36.331, clause 5.3.3.4, 5.3.5.6 and 5.6.5.3. Unless otherwise stated these are Rel-11 requirements.

[TS 36.331, clause 5.3.3.4 (TP1, TP2)]

The UE shall:

- 1> set the content of *RRCConnectionSetupComplete* message as follows:

...

- 2> if the UE has radio link failure or handover failure information available in *VarRLF-Report* and if the RPLMN is included in *plmn-IdentityList* stored in *VarRLF-Report*:
- 3> include *rlf-InfoAvailable*;

...

- 2> submit the *RRCConnectionSetupComplete* message to lower layers for transmission, upon which the procedure ends;

[TS 36.331, clause 5.3.5.6 (TP1, TP2)]

The UE shall:

- 1> if T304 expires (handover failure):

NOTE 1: Following T304 expiry any dedicated preamble, if provided within the *rach-ConfigDedicated*, is not available for use by the UE anymore.

- 2> revert back to the configuration used in the source PCell, excluding the configuration configured by the *physicalConfigDedicated*, the *mac-MainConfig* and the *sps-Config*;
- 2> store the following handover failure information in *VarRLF-Report* by setting its fields as follows:
 - 3> clear the information included in *VarRLF-Report*, if any;
 - 3> set the *plmn-IdentityList* to include the list of EPLMNs stored by the UE (i.e. includes the RPLMN);
 - 3> set the *measResultLastServCell* to include the RSRP and RSRQ, if available, of the PCell based on measurements collected up to the moment the UE detected handover failure;
 - 3> set the *measResultNeighCells* to include the best measured cells, other than the PCell, ordered such that the best cell is listed first, and based on measurements collected up to the moment the UE detected handover failure, and set its fields as follows:
 - 4> if the UE was configured to perform measurements for one or more EUTRA frequencies, include the *measResultListEUTRA*;
 - 4> if the UE was configured to perform measurement reporting for one or more neighbouring UTRA frequencies, include the *measResultListUTRA*;
 - 4> if the UE was configured to perform measurement reporting for one or more neighbouring GERAN frequencies, include the *measResultListGERAN*;
 - 4> if the UE was configured to perform measurement reporting for one or more neighbouring CDMA2000 frequencies, include the *measResultsCDMA2000*;
 - 4> for each neighbour cell included, include the optional fields that are available;

NOTE 2: The measured quantities are filtered by the L3 filter as configured in the mobility measurement configuration. The measurements are based on the time domain measurement resource restriction, if configured. Blacklisted cells are not required to be reported.

- 3> if detailed location information is available, set the content of the *locationInfo* as follows:
 - 4> include the *locationCoordinates*;
 - 4> include the *horizontalVelocity*, if available;
- 3> set the *failedPCellId* to the global cell identity, if available, and otherwise to the physical cell identity and carrier frequency of the target PCell of the failed handover;
- 3> include *previousPCellId* and set it to the global cell identity of the PCell where the last *RRCConnectionReconfiguration* message including *mobilityControlInfo* was received;
- 3> set the *timeConnFailure* to the elapsed time since reception of the last *RRCConnectionReconfiguration* message including the *mobilityControlInfo*;

- 3> set the *connectionFailureType* to 'hof';
- 3> set the *c-RNTI* to the C-RNTI used in the source PCell;
- 2> initiate the connection re-establishment procedure as specified in 5.3.7, upon which the RRC connection reconfiguration procedure ends;

The UE may discard the handover failure information, i.e. release the UE variable *VarRLF-Report*, 48 hours after the failure is detected, upon power off or upon detach.

NOTE 3: E-UTRAN may retrieve the handover failure information using the UE information procedure with *rlf-ReportReq* set to *true*, as specified in 5.6.5.3.

[TS 36.331, clause 5.6.5.3 (TP2)]

Upon receiving the *UEInformationRequest* message, the UE shall:

- ...
- 1> if *rlf-ReportReq* is set to *true* and the UE has radio link failure information or handover failure information available in *VarRLF-Report* and if the RPLMN is included in *plmn-IdentityList* stored in *VarRLF-Report*:
 - 2> set *timeSinceFailure* in *VarRLF-Report* to the time that elapsed since the last radio link or handover failure in E-UTRA;
 - 2> set the *rlf-Report* in the *UEInformationResponse* message to the value of *rlf-Report* in *VarRLF-Report*;
 - 2> discard the *rlf-Report* from *VarRLF-Report* upon successful delivery of the *UEInformationResponse* message confirmed by lower layers;
- ...
- 1> else:
 - 2> submit the *UEInformationResponse* message to lower layers for transmission via SRB1;

8.6.6.5.3 Test description

8.6.6.5.3.1 Pre-test conditions

System Simulator:

- Cell 1, Cell 2 and Cell 12
- System information combination 3 as defined in TS 36.508 [18] clause 4.4.3.1 is used in E-UTRA cells.
- The PLMNs are identified in the test by the identifiers in Table 8.6.6.5.3.1-1.

Table 8.6.6.5.3.1-1: PLMN identifiers

Cell	PLMN name
1, 2	PLMN1
12	PLMN2

UE:

None.

Preamble:

- The UE is registered on PLMN1 (Cell 1) using the procedure described in TS 36.508[18] clause 4.5.2.3 except that the ATTACH ACCEPT message indicates PLMN2 in the Equivalent PLMN list as described in Table 8.6.6.5.3.3-13.
- The UE is in state Generic RB Established (state 3) on Cell 1 according to [18].

8.6.6.5.3.2 Test procedure sequence

Table 8.6.6.5.3.2-1 illustrates the downlink power levels and other changing parameters to be applied for the cells at various time instants of the test execution. Configurations marked "T1" and "T2" are applied at the points indicated in the Main behaviour description in Table 8.6.6.5.3.2-2. The exact instants on which these values shall be applied are described in the texts in this clause.

Table 8.6.6.5.3.2-1: Time instances of cell power level and parameter changes

	Parameter	Unit	Cell 1	Cell 2	Cell 12	Remark
T1	Cell-specific RS EPRE	dBm/15kHz	-85	-79	"Off"	The power level values are such that measurement results for Cell 1 (M1) and Cell 2 (M2) satisfy entry condition for event A3 ($M2 > M1$). (NOTE 1)
T2	Cell-specific RS EPRE	dBm/15kHz	"Off"	-85	-73	The power level values are assigned to satisfy $R_{\text{Cell 2}} < R_{\text{Cell 12}}$. (NOTE 1)

NOTE 1: Power level "Off" is defined in TS 36.508 Table 6.2.2.1-1.

Table 8.6.6.5.3.2-2: Main behaviour

St	Procedure	Message Sequence		TP	Verdict
		U - S	Message		
1	The SS transmits an <i>RRCCONNECTIONRECONFIGURATION</i> message to setup intra-frequency measurement on Cell 1.	<--	<i>RRCCONNECTIONRECONFIGURATION</i>	-	-
2	The UE transmits an <i>RRCCONNECTIONRECONFIGURATIONCOMPLETE</i> message on Cell 1.	-->	<i>RRCCONNECTIONRECONFIGURATIONCOMPLETE</i>	-	-
3	The SS changes Cell 1 and Cell 2 parameters according to the row "T1" in Table 8.6.6.5.3.2-1.	-	-	-	-
4	The UE transmits a <i>MEASUREMENTREPORT</i> message on Cell 1.	-->	<i>MEASUREMENTREPORT</i>	-	-
5	The SS transmits an <i>RRCCONNECTIONRECONFIGURATION</i> message on Cell 1 to order the UE to perform intra frequency handover to Cell 2.	<--	<i>RRCCONNECTIONRECONFIGURATION</i>	-	-
-	EXCEPTION: In parallel to the events described in step 6 the steps specified in Table 8.6.6.5.3.2-3 should take place.	-	-	-	-
6	The UE transmits an <i>RRCCONNECTIONREESTABLISHMENTREQUEST</i> message on Cell 2.	-->	<i>RRCCONNECTIONREESTABLISHMENTREQUEST</i>	-	-
7	The SS transmits an <i>RRCCONNECTIONREESTABLISHMENT</i> message on Cell 2.	<--	<i>RRCCONNECTIONREESTABLISHMENT</i>	-	-
8	The UE transmits an <i>RRCCONNECTIONREESTABLISHMENTCOMPLETE</i> message with <i>rif-InfoAvailable</i> on Cell 2.	-->	<i>RRCCONNECTIONREESTABLISHMENTCOMPLETE</i>	-	-
9	The SS transmits an <i>RRCCONNECTIONRECONFIGURATION</i> message to resume existing radio bearer on Cell 2.	<--	<i>RRCCONNECTIONRECONFIGURATION</i>	-	-
10	The UE transmits an <i>RRCCONNECTIONRECONFIGURATIONCOMPLETE</i> message on Cell 2.	-->	<i>RRCCONNECTIONRECONFIGURATIONCOMPLETE</i>	-	-
11	The SS transmits an <i>RRCCONNECTIONRELEASE</i> message on Cell 2.	<--	<i>RRCCONNECTIONRELEASE</i>	-	-
12	Wait for 5 s for the UE to enter E-UTRA RRC_IDLE state.	-	-	-	-
13	The SS changes Cell 1, Cell 2 and Cell 12 parameters according to the row "T2" in Table 8.6.6.5.3.2-1.	-	-	-	-
14-15	Steps 1 to 2 of the generic test procedure in TS 36.508 [18] subclause 6.4.2.7 are performed on Cell 12.	-	-	-	-
16	Check: Does the UE transmit an <i>RRCCONNECTIONSETUPCOMPLETE</i> message with <i>rif-InfoAvailable</i> on Cell 12?	-->	RRC: <i>RRCCONNECTIONSETUPCOMPLETE</i> NAS: TRACKING AREA UPDATE REQUEST	1	P
17-19	Steps 4 to 6 of the generic test procedure in TS 36.508 [18] subclause 6.4.2.7 are performed on Cell 12. Note: The UE performs a TAU procedure and the RRC connection is released.	-	-	-	-
20-27	Steps 2 to 9 of the generic radio bearer establishment procedure in TS 36.508 subclause 4.5.3.3 are executed to successfully complete the service request procedure on Cell 12.	-	-	-	-
28	The SS sends a <i>UEINFORMATIONREQUEST</i> message with <i>rif-ReportReq</i> set to true.	<--	<i>UEINFORMATIONREQUEST</i>	-	-
29	Check: Does the UE transmit a <i>UEINFORMATIONRESPONSE</i> message including <i>rif-Report</i> ?	-->	<i>UEINFORMATIONRESPONSE</i>	2	P

Table 8.6.6.5.3.2-3: Parallel behaviour

St	Procedure	Message Sequence		TP	Verdict
		U - S	Message		
-	EXCEPTION: The steps 1 and 2 below are repeated for the duration of T304.	-	-	-	-
1	The UE attempts to perform the intra-frequency handover using MAC Random Access Preamble on Cell 2.	-	-	-	-
2	The SS does not respond.	-	-	-	-

8.6.6.5.3.3 Specific message contents

Table 8.6.6.5.3.3-1: *SystemInformationBlockType2* for Cell 2 (preamble and all steps, Table 8.6.6.5.3.2-2)

Derivation Path: 36.508, Table 4.4.3.3-1			
Information Element	Value/remark	Comment	Condition
SystemInformationBlockType2 ::= SEQUENCE {			
radioResourceConfigCommon SEQUENCE {			
rach-ConfigCommon SEQUENCE {			
ra-SupervisionInfo SEQUENCE {			
preambleTransMax	n50		
}			
}			
uplinkPowerControlCommon-v1020	Not present		
}			
lateNonCriticalExtension	Not present		
ssac-BarringForMMTEL-Voice-r9	Not present		
ssac-BarringForMMTEL-Video-r9	Not present		
ac-BarringForCSFB-r10	Not present		
}			
}			

Table 8.6.6.5.3.3-2: *RRCConnectionReconfiguration* (step 1, Table 8.6.6.5.3.2-2)

Derivation Path: 36.508, Table 4.6.1-8, condition MEAS
--

Table 8.6.6.5.3.3-3: *MeasConfig* (Table 8.6.6.5.3.3-2)

Derivation Path: 36.508, Table 4.6.6-1			
Information Element	Value/remark	Comment	Condition
MeasConfig ::= SEQUENCE {			
measObjectToAddModList SEQUENCE (SIZE (1..maxObjectId)) OF SEQUENCE {	1 entry		
measObjectId[1]	IdMeasObject-f1		
measObject[1]	MeasObjectEUTRA-GENERIC(f1)		
}			
reportConfigToAddModList SEQUENCE (SIZE (1..maxReportConfigId)) OF SEQUENCE {	1 entry		
reportConfigId[1]	IdReportConfig-A3		
reportConfig[1]	ReportConfigEUTRA-A3		
}			
measIdToAddModList SEQUENCE (SIZE (1..maxMeasId)) OF SEQUENCE {			
measId[1]	1		
measObjectId[1]	IdMeasObject-f1		
reportConfigId[1]	IdReportConfig-A3		
}			
}			

Table 8.6.6.5.3.3-4: MeasurementReport (step 4, Table 8.6.6.5.3.2-2)

Derivation Path: 36.508, Table 4.6.1-5			
Information Element	Value/remark	Comment	Condition
MeasurementReport ::= SEQUENCE {			
criticalExtensions CHOICE {			
c1 CHOICE{			
measurementReport-r8 SEQUENCE {			
measResults SEQUENCE {			
measId	1		
measResultPCell SEQUENCE {		Cell 1	
rsrpResult	(0..97)		
rsrqResult	(0..34)		
}			
measResultNeighCells CHOICE {			
measResultListEUTRA SEQUENCE (SIZE (1..maxCellReport)) OF SEQUENCE {	1 entry		
physCellId	PhysicalCellIdentity of Cell 2		
cgi-Info	Not present		
measResult SEQUENCE {			
rsrpResult	(0..97)		
rsrqResult	(0..34)		
additionalSI-Info-r9	Not present		
}			
}			
}			
measResultForECID-r9	Not present		
locationInfo-r10	Not present		
measResultServFreqList-r10	Not present		
}			
}			
}			

Table 8.6.6.5.3.3-5: RRCConnectionReconfiguration (step 5, Table 8.6.6.5.3.2-2)

Derivation Path: 36.508, Table 4.6.1-8, condition HO

Table 8.6.6.5.3.3-6: MobilityControlInfo (Table 8.6.6.5.3.3-5)

Derivation Path: 36.508, Table 4.6.5-1			
Information Element	Value/remark	Comment	Condition
MobilityControlInfo ::= SEQUENCE {			
targetPhysCellId	PhysicalCellIdentity of Cell 2		
carrierFreq	Not present		
}			

Table 8.6.6.5.3.3-7: RRCConnectionReestablishmentRequest (step 6, Table 8.6.6.5.3.2-2)

Derivation Path: 36.508, Table 4.6.1-13			
Information Element	Value/remark	Comment	Condition
RRCConnectionReestablishmentRequest ::= SEQUENCE {			
criticalExtensions CHOICE {			
rrcConnectionReestablishmentRequest-r8			
SEQUENCE {			
ue-Identity SEQUENCE {			
c-RNTI	the C-RNTI used in the Cell 1		
physCellId	PhysicalCellIdentity of Cell 1		
shortMAC-I	The same value as the 16 least significant bits of the XMAC-I value calculated by SS		
}			
reestablishmentCause	handoverFailure		
}			
}			
}			

Table 8.6.6.5.3.3-8: RRCConnectionReestablishmentComplete (step 8, Table 8.6.6.5.3.2-2)

Derivation Path: 36.508, Table 4.6.1-11			
Information Element	Value/remark	Comment	Condition
RRCConnectionReestablishmentComplete ::= SEQUENCE {			
criticalExtensions CHOICE {			
rrcConnectionReestablishmentComplete-r8 =			
SEQUENCE {			
nonCriticalExtension SEQUENCE {			
rfl-InfoAvailable-r9	true		
nonCriticalExtension	Not present or any allowed value		
}			
}			
}			
}			

Table 8.6.6.5.3.3-9: RRCConnectionReconfiguration (step 9, Table 8.6.6.5.3.2-2)

Derivation Path: 36.508, Table 4.6.1-8			
Information Element	Value/remark	Comment	Condition
RRCConnectionReconfiguration ::= SEQUENCE {			
criticalExtensions CHOICE {			
c1 CHOICE{			
rrcConnectionReconfiguration-r8 SEQUENCE {			
radioResourceConfigDedicated	RadioResourceConfigDedicated-HO		
}			
}			
}			
}			

Table 8.6.6.5.3.3-10: RRCConnectionSetupComplete (step 16, Table 8.6.6.5.3.2-2)

Derivation Path: 36.508, Table 4.6.1-18			
Information Element	Value/remark	Comment	Condition
RRCConnectionSetupComplete ::= SEQUENCE {			
criticalExtensions CHOICE {			
c1 CHOICE{			
rrcConnectionSetupComplete-r8 SEQUENCE {			
selectedPLMN-Identity	PLMN2		
nonCriticalExtension SEQUENCE {			
nonCriticalExtension SEQUENCE {			
gummei-Type-r10	native		
rlf-InfoAvailable-r10	true		
logMeasAvailable-r10	Not present		
rn-SubframeConfigReq-r10	Not present		
nonCriticalExtension	Not present		
}			
}			
}			
}			
}			
}			

Table 8.6.6.5.3.3-11: UEInformationRequest (step 28, Table 8.6.6.5.3.2-2)

Derivation Path: 36.508, Table 4.6.1-23A, condition RLF report
--

Table 8.6.6.5.3.3-12: *UEInformationResponse* (step 29, Table 8.6.6.5.3.2-2)

Derivation Path: 36.508, Table 4.6.1-23B			
Information Element	Value/remark	Comment	Condition
<i>UEInformationResponse</i> -r9 ::=SEQUENCE {			
criticalExtensions CHOICE {			
c1 CHOICE {			
<i>ueInformationResponse</i> -r9 SEQUENCE {			
rfl-Report-r9 SEQUENCE {			
measResultLastServCell-r9 SEQUENCE {		Cell 1	
rsrpResult-r9	(0..97)		
rsrqResult-r9	Not present or (0..34)		
}			
measResultNeighCells-r9 SEQUENCE {			
measResultListEUTRA-r9 SEQUENCE (SIZE (1..maxFreq)) OF SEQUENCE {	1 entry		
carrierFreq-r9[1]	Same downlink EARFCN as used for Cell 2		
measResultList-r9[1] SEQUENCE (SIZE (1..maxCellReport)) OF SEQUENCE {	1 entry		
physCellId[1]	PhysicalCellIdentity of Cell 2		
cgi-Info[1]	Not present		
measResult[1] SEQUENCE {			
rsrpResult	(0..97)		
rsrqResult	(0..34)		
additionalSI-Info-r9	Not present		
}			
}			
}			
measResultListUTRA-r9	Not present		
measResultListGERAN-r9	Not present		
measResultsCDMA2000-r9	Not present		
}			
locationInfo-r10	Not present or any allowed value		
failedPCellId-r10 CHOICE {	cellGlobalId-r10 or pci-arfcn-r10	If the UE has the global cell identity depending on UE implementation, the UE sets the global cell identity; otherwise the UE sets the physical cell identity and the carrier frequency.	
cellGlobalId-r10 SEQUENCE {			
plmn-Identity	<i>plmn-Identity</i> within <i>SystemInformationBlockType1</i> broadcasted in Cell 2		
cellIdentity	<i>cellIdentity</i> within <i>SystemInformationBlockType1</i> broadcasted in Cell 2		
}			
pci-arfcn-r10 SEQUENCE {			
physCellId-r10	PhysicalCellIdentity of Cell 2		
carrierFreq-r10	Same downlink EARFCN as used for Cell 2		
}			
}			
reestablishmentCellId-r10 SEQUENCE {			
plmn-Identity	<i>plmn-Identity</i> within <i>SystemInformationBlockT</i>		

	<i>ype1</i> broadcasted in Cell 2		
<i>cellIdentity</i>	<i>cellIdentity</i> within <i>SystemInformationBlockType1</i> broadcasted in Cell 2		
}			
<i>timeConnFailure-r10</i>	Any allowed value	Time from UE receive HO command to the failure	
<i>connectionFailureType-r10</i>	<i>hof</i>		
<i>previousPCellId-r10</i> SEQUENCE {			
<i>plmn-Identity</i>	<i>plmn-Identity</i> within <i>SystemInformationBlockType1</i> broadcasted in Cell 1		
<i>cellIdentity</i>	<i>cellIdentity</i> within <i>SystemInformationBlockType1</i> broadcasted in Cell 1		
}			
<i>basicFields-r11</i> SEQUENCE {			
<i>c-RNTI-r11</i>	C-RNTI used in Cell 1		
<i>rlf-Cause-r11</i>	<i>randomAccessProblem</i>		
<i>timeSinceFailure-r11</i>	Any value	Time elapsed from connection failure	
}			
}			
}			
}			
}			
}			

Table 8.6.6.5.3.3-13: ATTACH ACCEPT for Cell 1 (preamble)

Derivation path: 36.508 Table 4.7.2-1			
Information Element	Value/Remark	Comment	Condition
Equivalent PLMNs	PLMN2		

8.6.6.6 Handover Failure logging / Logging and reporting / Reporting at intra LTE handover / PLMN list

8.6.6.6.1 Test Purpose (TP)

(1)

```

with { UE in RRC_CONNECTED having detected handover failure }
ensure that {
  when { UE handovers to another cell that belongs to a PLMN which is different from the PLMN where
the handover failure was detected but included in the plmn-IdentityList stored in VarRLF-Report }
  then { UE transmits the RRCConnectionReconfigurationComplete with IE rlf-InfoAvailable included
}
}

```

(2)

```

with { UE indicated the availability of handover failure information in
RRCConnectionReconfigurationComplete message and the RPLMN is included in plmn-IdentityList stored
in VarRLF-Report }
ensure that {
  when { UE receives a UEInformationRequest message with rlf-ReportReq set to true }
  then { UE transmits a UEInformationResponse message including rlf-Report }
}

```

8.6.6.6.2 Conformance requirements

References: The conformance requirements covered in the present TC are specified in: TS 36.331, clause 5.3.5.4, 5.3.5.6 and 5.6.5.3. Unless otherwise stated these are Rel-11 requirements.

[TS 36.331, clause 5.3.5.4 (TP1, TP2)]

If the *RRConnectionReconfiguration* message includes the *mobilityControlInfo* and the UE is able to comply with the configuration included in this message, the UE shall:

...

1> set the content of *RRConnectionReconfigurationComplete* message as follows:

2> if the UE has radio link failure or handover failure information available in *VarRLF-Report* and if the RPLMN is included in *plmn-IdentityList* stored in *VarRLF-Report*:

3> include *rlf-InfoAvailable*;

2> if the UE has logged measurements available for E-UTRA and if the RPLMN is included in *plmn-IdentityList* stored in *VarLogMeasReport*:

3> include the *logMeasAvailable*;

2> if the UE has connection establishment failure information available in *VarConnEstFailReport* and if the RPLMN is equal to *plmn-Identity* stored in *VarConnEstFailReport*:

3> include *connEstFailInfoAvailable*;

1> submit the *RRConnectionReconfigurationComplete* message to lower layers for transmission;

[TS 36.331, clause 5.3.5.6 (TP1, TP2)]

The UE shall:

1> if T304 expires (handover failure):

NOTE 1: Following T304 expiry any dedicated preamble, if provided within the *rach-ConfigDedicated*, is not available for use by the UE anymore.

2> revert back to the configuration used in the source PCell, excluding the configuration configured by the *physicalConfigDedicated*, the *mac-MainConfig* and the *sps-Config*;

2> store the following handover failure information in *VarRLF-Report* by setting its fields as follows:

3> clear the information included in *VarRLF-Report*, if any;

3> set the *plmn-IdentityList* to include the list of EPLMNs stored by the UE (i.e. includes the RPLMN);

3> set the *measResultLastServCell* to include the RSRP and RSRQ, if available, of the PCell based on measurements collected up to the moment the UE detected handover failure;

3> set the *measResultNeighCells* to include the best measured cells, other than the PCell, ordered such that the best cell is listed first, and based on measurements collected up to the moment the UE detected handover failure, and set its fields as follows;

4> if the UE was configured to perform measurements for one or more EUTRA frequencies, include the *measResultListEUTRA*;

4> if the UE was configured to perform measurement reporting for one or more neighbouring UTRA frequencies, include the *measResultListUTRA*;

4> if the UE was configured to perform measurement reporting for one or more neighbouring GERAN frequencies, include the *measResultListGERAN*;

4> if the UE was configured to perform measurement reporting for one or more neighbouring CDMA2000 frequencies, include the *measResultsCDMA2000*;

4> for each neighbour cell included, include the optional fields that are available;

NOTE 2: The measured quantities are filtered by the L3 filter as configured in the mobility measurement configuration. The measurements are based on the time domain measurement resource restriction, if configured. Blacklisted cells are not required to be reported.

3> if detailed location information is available, set the content of the *locationInfo* as follows:

4> include the *locationCoordinates*;

4> include the *horizontalVelocity*, if available;

3> set the *failedPCellId* to the global cell identity, if available, and otherwise to the physical cell identity and carrier frequency of the target PCell of the failed handover;

3> include *previousPCellId* and set it to the global cell identity of the PCell where the last *RRCCConnectionReconfiguration* message including *mobilityControlInfo* was received;

3> set the *timeConnFailure* to the elapsed time since reception of the last *RRCCConnectionReconfiguration* message including the *mobilityControlInfo*;

3> set the *connectionFailureType* to 'hof';

3> set the *c-RNTI* to the C-RNTI used in the source PCell;

2> initiate the connection re-establishment procedure as specified in 5.3.7, upon which the RRC connection reconfiguration procedure ends;

The UE may discard the handover failure information, i.e. release the UE variable *VarRLF-Report*, 48 hours after the failure is detected, upon power off or upon detach.

NOTE 3: E-UTRAN may retrieve the handover failure information using the UE information procedure with *rlf-ReportReq* set to *true*, as specified in 5.6.5.3.

[TS 36.331, clause 5.6.5.3 (TP2)]

Upon receiving the *UEInformationRequest* message, the UE shall:

...

1> if *rlf-ReportReq* is set to *true* and the UE has radio link failure information or handover failure information available in *VarRLF-Report* and if the RPLMN is included in *plmn-IdentityList* stored in *VarRLF-Report*:

2> set *timeSinceFailure* in *VarRLF-Report* to the time that elapsed since the last radio link or handover failure in E-UTRA;

2> set the *rlf-Report* in the *UEInformationResponse* message to the value of *rlf-Report* in *VarRLF-Report*;

2> discard the *rlf-Report* from *VarRLF-Report* upon successful delivery of the *UEInformationResponse* message confirmed by lower layers;

...

1> else:

2> submit the *UEInformationResponse* message to lower layers for transmission via SRB1;

8.6.6.6.3 Test description

8.6.6.6.3.1 Pre-test conditions

System Simulator:

- Cell 1, Cell 2 and Cell 12
- System information combination 3 as defined in TS 36.508 [18] clause 4.4.3.1 is used in E-UTRA cells.
- The PLMNs are identified in the test by the identifiers in Table 8.6.6.6.3.1-1.

Table 8.6.6.3.1-1: PLMN identifiers

Cell	PLMN name
1, 2	PLMN1
12	PLMN2

UE:

None.

Preamble:

- The UE is registered on PLMN1 (Cell 1) using the procedure described in TS 36.508[18] clause 4.5.2.3 except that the ATTACH ACCEPT message indicates PLMN2 in the Equivalent PLMN list as described in Table 8.6.6.3.3-13.
- The UE is in state Generic RB Established (state 3) on Cell 1 according to [18].

8.6.6.3.2 Test procedure sequence

Table 8.6.6.3.2-1 illustrates the downlink power levels and other changing parameters to be applied for the cells at various time instants of the test execution. Configurations marked "T1" and "T2" are applied at the points indicated in the Main behaviour description in Table 8.6.6.3.2-2. The exact instants on which these values shall be applied are described in the texts in this clause.

Table 8.6.6.3.2-1: Time instances of cell power level and parameter changes

	Parameter	Unit	Cell 1	Cell 2	Cell 12	Remark
T1	Cell-specific RS EPRE	dBm/15kHz	-85	-79	"Off"	The power level values are such that measurement results for Cell 1 (M1) and Cell 2 (M2) satisfy entry condition for event A3 ($M2 > M1$). (NOTE 1)
T2	Cell-specific RS EPRE	dBm/15kHz	"Off"	-85	-73	The power level values are such that measurement results for Cell 2 (M2) and Cell 12 (M12) satisfy entry condition for event A3 ($M12 > M2$). (NOTE 1)
NOTE 1: Power level "Off" is defined in TS 36.508 Table 6.2.2.1-1.						

Table 8.6.6.3.2-2: Main behaviour

St	Procedure	Message Sequence		TP	Verdict
		U - S	Message		
1	The SS transmits an <i>RRConnectionReconfiguration</i> message to setup intra and inter frequency measurement on Cell 1.	<--	<i>RRConnectionReconfiguration</i>	-	-
2	The UE transmits an <i>RRConnectionReconfigurationComplete</i> message on Cell 1.	-->	<i>RRConnectionReconfigurationComplete</i>	-	-
3	The SS changes Cell 1 and Cell 2 parameters according to the row "T1" in Table 8.6.6.3.2-1.	-	-	-	-
4	The UE transmits a <i>MeasurementReport</i> message on Cell 1.	-->	<i>MeasurementReport</i>	-	-
5	The SS transmits an <i>RRConnectionReconfiguration</i> message on Cell 1 to order the UE to perform intra frequency handover to Cell 2.	<--	<i>RRConnectionReconfiguration</i>	-	-
-	EXCEPTION: In parallel to the events described in step 6 the steps specified in Table 8.6.6.3.2-3 should take place.	-	-	-	-
6	The UE transmits an <i>RRConnectionReestablishmentRequest</i> message on Cell 2.	-->	<i>RRConnectionReestablishmentRequest</i>	-	-
7	The SS transmits an <i>RRConnectionReestablishment</i> message on Cell 2.	<--	<i>RRConnectionReestablishment</i>	-	-
8	The UE transmits an <i>RRConnectionReestablishmentComplete</i> message with <i>rfl-InfoAvailable</i> on Cell 2.	-->	<i>RRConnectionReestablishmentComplete</i>	-	-
9	The SS transmits an <i>RRConnectionReconfiguration</i> message to resume existing radio bearer on Cell 2.	<--	<i>RRConnectionReconfiguration</i>	-	-
10	The UE transmits an <i>RRConnectionReconfigurationComplete</i> message on Cell 2.	-->	<i>RRConnectionReconfigurationComplete</i>	-	-
11	The SS changes Cell 1, Cell 2 and Cell 12 parameters according to the row "T2" in Table 8.6.6.3.2-1.	-	-	-	-
12	The UE transmits a <i>MeasurementReport</i> message on Cell 2 to report event A3 with the measured RSRP, RSRQ value for Cell 12.	-->	<i>MeasurementReport</i>	-	-
13	The SS transmits an <i>RRConnectionReconfiguration</i> message on Cell 2 to order the UE to perform inter frequency handover to Cell 12.	<--	<i>RRConnectionReconfiguration</i>	-	-
14	Check: Does the UE transmit an <i>RRConnectionReconfigurationComplete</i> message on Cell 12 with <i>rfl-InfoAvailable</i> included?	-->	<i>RRConnectionReconfigurationComplete</i>	1	P
15	The SS sends a <i>UEInformationRequest</i> message with <i>rfl-ReportReq</i> set to true.	<--	<i>UEInformationRequest</i>	-	-
16	Check: Does the UE send a <i>UEInformationResponse</i> message including <i>rfl-Report</i> ?	-->	<i>UEInformationResponse</i>	2	P

Table 8.6.6.3.2-3: Parallel behaviour

St	Procedure	Message Sequence		TP	Verdict
		U - S	Message		
-	EXCEPTION: The steps 1 and 2 below are repeated for the duration of T304.	-	-	-	-
1	The UE attempts to perform the intra-frequency handover using MAC Random Access Preamble on Cell 2.	-	-	-	-
2	The SS does not respond.	-	-	-	-

8.6.6.3.3 Specific message contents

Table 8.6.6.3.3-1: *SystemInformationBlockType2* for Cell 2 (preamble and all steps, Table 8.6.6.3.2-2)

Derivation Path: 36.508, Table 4.4.3.3-1			
Information Element	Value/remark	Comment	Condition
SystemInformationBlockType2 ::= SEQUENCE {			
radioResourceConfigCommon SEQUENCE {			
rach-ConfigCommon SEQUENCE {			
ra-SupervisionInfo SEQUENCE {			
preambleTransMax	n50		
}			
}			
uplinkPowerControlCommon-v1020	Not present		
}			
lateNonCriticalExtension	Not present		
ssac-BarringForMMTEL-Voice-r9	Not present		
ssac-BarringForMMTEL-Video-r9	Not present		
ac-BarringForCSFB-r10	Not present		
}			

Table 8.6.6.3.3-2: *RRCConnectionReconfiguration* (step 1, Table 8.6.6.3.2-2)

Derivation Path: 36.508, Table 4.6.1-8, condition MEAS
--

Table 8.6.6.3.3-3: MeasConfig (Table 8.6.6.3.3-2)

Derivation Path: 36.508, Table 4.6.6-1, condition INTER-FREQ			
Information Element	Value/remark	Comment	Condition
MeasConfig SEQUENCE {			
measObjectToAddModList SEQUENCE (SIZE (1..maxObjectId)) OF SEQUENCE {	2 entries		
measObjectId[1]	IdMeasObject-f1		
measObject[1]	MeasObjectEUTRA-GENERIC(f1)		
measObjectId[2]	IdMeasObject-f2		
measObject[2]	MeasObjectEUTRA-GENERIC(f2)		
}			
reportConfigToAddModList SEQUENCE (SIZE (1..maxReportConfigId)) OF SEQUENCE {	1 entry		
reportConfigId[1]	IdReportConfig-A3		
reportConfig[1]	ReportConfigEUTRA-A3		
}			
measIdToAddModList SEQUENCE (SIZE (1..maxMeasId)) OF SEQUENCE {	2 entries		
measId[1]	1		
measObjectId[1]	IdMeasObject-f1		
reportConfigId[1]	IdReportConfig-A3		
measId[2]	2		
measObjectId[2]	IdMeasObject-f2		
reportConfigId[2]	IdReportConfig-A3		
}			
}			

Table 8.6.6.3.3-4: MeasurementReport (step 4, Table 8.6.6.3.2-2)

Derivation Path: 36.508, Table 4.6.1-5			
Information Element	Value/remark	Comment	Condition
MeasurementReport ::= SEQUENCE {			
criticalExtensions CHOICE {			
c1 CHOICE{			
measurementReport-r8 SEQUENCE {			
measResults SEQUENCE {			
measId	1		
measResultPCell SEQUENCE {		Cell 1	
rsrpResult	(0..97)		
rsrqResult	(0..34)		
}			
measResultNeighCells CHOICE {			
measResultListEUTRA SEQUENCE (SIZE (1..maxCellReport)) OF SEQUENCE {	1 entry		
physCellId	PhysicalCellIdentity of Cell 2		
cgi-Info	Not present		
measResult SEQUENCE {			
rsrpResult	(0..97)		
rsrqResult	(0..34)		
additionalSI-Info-r9	Not present		
}			
}			
}			
measResultForECID-r9	Not present		
locationInfo-r10	Not present		
measResultServFreqList-r10	Not present		
}			
}			
}			

Table 8.6.6.3.3-5: RRCConnectionReconfiguration (step 5, Table 8.6.6.3.2-2)

Derivation Path: 36.508, Table 4.6.1-8, condition HO
--

Table 8.6.6.3.3-6: MobilityControlInfo (Table 8.6.6.3.3-5)

Derivation Path: 36.508, Table 4.6.5-1			
Information Element	Value/remark	Comment	Condition
MobilityControlInfo ::= SEQUENCE {			
targetPhysCellId	PhysicalCellIdentity of Cell 2		
carrierFreq	Not present		
}			

Table 8.6.6.6.3.3-7: RRCConnectionReestablishmentRequest (step 6, Table 8.6.6.6.3.2-2)

Derivation Path: 36.508, Table 4.6.1-13			
Information Element	Value/remark	Comment	Condition
RRCConnectionReestablishmentRequest ::= SEQUENCE {			
criticalExtensions CHOICE {			
rrcConnectionReestablishmentRequest-r8			
SEQUENCE {			
ue-Identity SEQUENCE {			
c-RNTI	the C-RNTI used in the Cell 1		
physCellId	PhysicalCellIdentity of Cell 1		
shortMAC-I	The same value as the 16 least significant bits of the XMAC-I value calculated by SS		
}			
reestablishmentCause	handoverFailure		
}			
}			

Table 8.6.6.6.3.3-8: RRCConnectionReestablishmentComplete (step 8, Table 8.6.6.6.3.2-2)

Derivation Path: 36.508, Table 4.6.1-11			
Information Element	Value/remark	Comment	Condition
RRCConnectionReestablishmentComplete ::= SEQUENCE {			
criticalExtensions CHOICE {			
rrcConnectionReestablishmentComplete-r8 =			
SEQUENCE {			
nonCriticalExtension SEQUENCE {			
rfl-InfoAvailable-r9	true		
nonCriticalExtension	Not present or any allowed value		
}			
}			
}			

Table 8.6.6.6.3.3-9: RRCConnectionReconfiguration (step 9, Table 8.6.6.6.3.2-2)

Derivation Path: 36.508, Table 4.6.1-8			
Information Element	Value/remark	Comment	Condition
RRCConnectionReconfiguration ::= SEQUENCE {			
criticalExtensions CHOICE {			
c1 CHOICE{			
rrcConnectionReconfiguration-r8 SEQUENCE {			
radioResourceConfigDedicated	RadioResourceConfigDedicated-HO		
}			
}			
}			

Table 8.6.4.4.3.3-10: MeasurementReport (step 12, Table 8.6.4.4.3.2-2)

Derivation Path: 36.508, Table 4.6.1-5			
Information Element	Value/remark	Comment	Condition
MeasurementReport ::= SEQUENCE {			
criticalExtensions CHOICE {			
c1 CHOICE{			
measurementReport-r8 SEQUENCE {			
measResults SEQUENCE {			
measId	2		
measResultPCell SEQUENCE {		Cell 2	
rsrpResult	(0..97)		
rsrqResult	(0..34)		
}			
measResultNeighCells CHOICE {			
measResultListEUTRA SEQUENCE (SIZE (1..maxCellReport)) OF SEQUENCE {	1 entry		
physCellId	PhysicalCellIdentity of Cell 12		
cgi-Info	Not present		
measResult SEQUENCE {			
rsrpResult	(0..97)		
rsrqResult	(0..34)		
additionalSI-Info-r9	Not present		
}			
}			
}			
measResultForECID-r9	Not present		
locationInfo-r10	Not present		
measResultServFreqList-r10	Not present		
}			
}			
}			

Table 8.6.6.6.3.3-11: RRCConnectionReconfigurationComplete (step 14, Table 8.6.6.6.3.2-2)

Derivation Path: 36.508, Table 4.6.1-9			
Information Element	Value/remark	Comment	Condition
RRCConnectionReconfigurationComplete ::= SEQUENCE {			
rrc-TransactionIdentifier	RRC-TransactionIdentifier-UL		
criticalExtensions CHOICE {			
rrcConnectionReconfigurationComplete-r8 SEQUENCE {			
nonCriticalExtension SEQUENCE {			
nonCriticalExtension SEQUENCE {			
rlf-InfoAvailable-r10	true		
}			
}			
}			
}			
}			

Table 8.6.6.6.3.3-12: UEInformationRequest (step 15, Table 8.6.6.6.3.2-2)

Derivation Path: 36.508, Table 4.6.1-23A, condition RLF report
--

Table 8.6.6.3.3-13: *UEInformationResponse* (step 16, Table 8.6.6.3.2-2)

Derivation Path: 36.508, Table 4.6.1-23B			
Information Element	Value/remark	Comment	Condition
<i>UEInformationResponse</i> -r9 ::=SEQUENCE {			
criticalExtensions CHOICE {			
c1 CHOICE {			
<i>ueInformationResponse</i> -r9 SEQUENCE {			
rfl-Report-r9 SEQUENCE {			
measResultLastServCell-r9 SEQUENCE {		Cell 1	
rsrpResult-r9	(0..97)		
rsrqResult-r9	Not present or (0..34)		
}			
measResultNeighCells-r9 SEQUENCE {			
measResultListEUTRA-r9 SEQUENCE (SIZE (1..maxFreq)) OF SEQUENCE {	1 entry		
carrierFreq-r9[1]	Same downlink EARFCN as used for Cell 2		
measResultList-r9[1] SEQUENCE (SIZE (1..maxCellReport)) OF SEQUENCE {	1 entry		
physCellId[1]	PhysicalCellIdentity of Cell 2		
cgi-Info[1]	Not present		
measResult[1] SEQUENCE {			
rsrpResult	(0..97)		
rsrqResult	(0..34)		
additionalSI-Info-r9	Not present		
}			
}			
}			
measResultListUTRA-r9	Not present		
measResultListGERAN-r9	Not present		
measResultsCDMA2000-r9	Not present		
}			
locationInfo-r10	Not present or any allowed value		
failedPCellId-r10 CHOICE {	cellGlobalId-r10 or pci-arfcn-r10	If the UE has the global cell identity depending on UE implementation, the UE sets the global cell identity; otherwise the UE sets the physical cell identity and the carrier frequency.	
cellGlobalId-r10 SEQUENCE {			
plmn-Identity	<i>plmn-Identity</i> within <i>SystemInformationBlockType1</i> broadcasted in Cell 2		
cellIdentity	<i>cellIdentity</i> within <i>SystemInformationBlockType1</i> broadcasted in Cell 2		
}			
pci-arfcn-r10 SEQUENCE {			
physCellId-r10	PhysicalCellIdentity of Cell 2		
carrierFreq-r10	Same downlink EARFCN as used for Cell 2		
}			
}			
reestablishmentCellId-r10 SEQUENCE {			
plmn-Identity	<i>plmn-Identity</i> within <i>SystemInformationBlockT</i>		

	<i>ype1</i> broadcasted in Cell 2		
<i>cellIdentity</i>	<i>cellIdentity</i> within <i>SystemInformationBlockType1</i> broadcasted in Cell 2		
}			
<i>timeConnFailure-r10</i>	Any allowed value	Time from UE receive HO command to the failure	
<i>connectionFailureType-r10</i>	<i>hof</i>		
<i>previousPCellId-r10</i> SEQUENCE {			
<i>plmn-Identity</i>	<i>plmn-Identity</i> within <i>SystemInformationBlockType1</i> broadcasted in Cell 1		
<i>cellIdentity</i>	<i>cellIdentity</i> within <i>SystemInformationBlockType1</i> broadcasted in Cell 1		
}			
<i>basicFields-r11</i> SEQUENCE {			
<i>c-RNTI-r11</i>	C-RNTI used in Cell 1		
<i>rlf-Cause-r11</i>	<i>randomAccessProblem</i>		
<i>timeSinceFailure-r11</i>	Any allowed value	Time elapsed from connection failure	
}			
}			
}			
}			
}			
}			

Table 8.6.6.3.3-14: ATTACH ACCEPT for Cell 1 (preamble)

Derivation path: 36.508 Table 4.7.2-1			
Information Element	Value/Remark	Comment	Condition
Equivalent PLMNs	PLMN2		

8.6.6.7 Handover Failure logging / Logging and reporting / Reporting at RRC connection re-establishment / PLMN list

8.6.6.7.1 Test Purpose (TP)

(1)

```

with { UE in RRC_CONNECTED having detected handover failure }
ensure that {
  when { UE re-establishes to a cell that belongs to a PLMN which is different from the PLMN where
the handover failure was detected but included in the plmn-IdentityList stored in VarRLF-Report }
  then { UE transmits the RRCConnectionReestablishmentComplete with IE rlf-InfoAvailable included
}
}

```

(2)

```

with { UE indicated the availability of handover failure information in
RRCConnectionReestablishmentComplete message and the RPLMN is included in plmn-IdentityList stored
in VarRLF-Report }
ensure that {
  when { UE receives a UEInformationRequest message with rlf-ReportReq set to true }
  then { UE transmits a UEInformationResponse message including rlf-Report }
}

```

8.6.6.7.2 Conformance requirements

References: The conformance requirements covered in the present TC are specified in: TS 36.331, clause 5.3.5.6, 5.3.7.5 and 5.6.5.3. Unless otherwise stated these are Rel-11 requirements.

[TS 36.331, clause 5.3.5.6 (TP1, TP2)]

The UE shall:

1> if T304 expires (handover failure):

NOTE 1: Following T304 expiry any dedicated preamble, if provided within the *rach-ConfigDedicated*, is not available for use by the UE anymore.

2> revert back to the configuration used in the source PCell, excluding the configuration configured by the *physicalConfigDedicated*, the *mac-MainConfig* and the *sps-Config*;

2> store the following handover failure information in *VarRLF-Report* by setting its fields as follows:

3> clear the information included in *VarRLF-Report*, if any;

3> set the *plmn-IdentityList* to include the list of EPLMNs stored by the UE (i.e. includes the RPLMN);

3> set the *measResultLastServCell* to include the RSRP and RSRQ, if available, of the PCell based on measurements collected up to the moment the UE detected handover failure;

3> set the *measResultNeighCells* to include the best measured cells, other than the PCell, ordered such that the best cell is listed first, and based on measurements collected up to the moment the UE detected handover failure, and set its fields as follows;

4> if the UE was configured to perform measurements for one or more EUTRA frequencies, include the *measResultListEUTRA*;

4> if the UE was configured to perform measurement reporting for one or more neighbouring UTRA frequencies, include the *measResultListUTRA*;

4> if the UE was configured to perform measurement reporting for one or more neighbouring GERAN frequencies, include the *measResultListGERAN*;

4> if the UE was configured to perform measurement reporting for one or more neighbouring CDMA2000 frequencies, include the *measResultsCDMA2000*;

4> for each neighbour cell included, include the optional fields that are available;

NOTE 2: The measured quantities are filtered by the L3 filter as configured in the mobility measurement configuration. The measurements are based on the time domain measurement resource restriction, if configured. Blacklisted cells are not required to be reported.

3> if detailed location information is available, set the content of the *locationInfo* as follows:

4> include the *locationCoordinates*;

4> include the *horizontalVelocity*, if available;

3> set the *failedPCellId* to the global cell identity, if available, and otherwise to the physical cell identity and carrier frequency of the target PCell of the failed handover;

3> include *previousPCellId* and set it to the global cell identity of the PCell where the last *RRCCONNECTIONRECONFIGURATION* message including *mobilityControlInfo* was received;

3> set the *timeConnFailure* to the elapsed time since reception of the last *RRCCONNECTIONRECONFIGURATION* message including the *mobilityControlInfo*;

3> set the *connectionFailureType* to 'hof';

3> set the *c-RNTI* to the C-RNTI used in the source PCell;

- 2> initiate the connection re-establishment procedure as specified in 5.3.7, upon which the RRC connection reconfiguration procedure ends;

The UE may discard the handover failure information, i.e. release the UE variable *VarRLF-Report*, 48 hours after the failure is detected, upon power off or upon detach.

NOTE 3: E-UTRAN may retrieve the handover failure information using the UE information procedure with *rlf-ReportReq* set to *true*, as specified in 5.6.5.3.

[TS 36.331, clause 5.3.7.5 (TP1)]

The UE shall:

...

- 1> set the content of *RRCConnectionReestablishmentComplete* message as follows:
 - 2> if the UE has radio link failure or handover failure information available in *VarRLF-Report* and if the RPLMN is included in *plmn-IdentityList* stored in *VarRLF-Report*:
 - 3> include the *rlf-InfoAvailable*;
 - 2> if the UE has logged measurements available for E-UTRA and if the RPLMN is included in *plmn-IdentityList* stored in *VarLogMeasReport*:
 - 3> include the *logMeasAvailable*;
 - 2> if the UE has connection establishment failure information available in *VarConnEstFailReport* and if the RPLMN is equal to *plmn-Identity* stored in *VarConnEstFailReport*:
 - 3> include the *connEstFailInfoAvailable*;
- 1> perform the measurement related actions as specified in 5.5.6.1;
- 1> perform the measurement identity autonomous removal as specified in 5.5.2.2a;
- 1> submit the *RRCConnectionReestablishmentComplete* message to lower layers for transmission;
- 1> if *SystemInformationBlockType15* is broadcast by the PCell:
 - 2> if the UE has transmitted an *MBMSInterestIndication* message during the last 1 second preceding detection of radio link failure:
 - 3> ensure having a valid version of *SystemInformationBlockType15* for the PCell;
 - 3> determine the set of MBMS frequencies of interest in accordance with 5.8.5.3;
 - 3> initiate transmission of the *MBMSInterestIndication* message in accordance with 5.8.5.4;
- 1> the procedure ends;

[TS 36.331, clause 5.6.5.3 (TP2)]

Upon receiving the *UEInformationRequest* message, the UE shall:

...

- 1> if *rlf-ReportReq* is set to *true* and the UE has radio link failure information or handover failure information available in *VarRLF-Report* and if the RPLMN is included in *plmn-IdentityList* stored in *VarRLF-Report*:
 - 2> set *timeSinceFailure* in *VarRLF-Report* to the time that elapsed since the last radio link or handover failure in E-UTRA;
 - 2> set the *rlf-Report* in the *UEInformationResponse* message to the value of *rlf-Report* in *VarRLF-Report*;
 - 2> discard the *rlf-Report* from *VarRLF-Report* upon successful delivery of the *UEInformationResponse* message confirmed by lower layers;

...

1> else:

2> submit the *UEInformationResponse* message to lower layers for transmission via SRB1;**8.6.6.7.3 Test description****8.6.6.7.3.1 Pre-test conditions****System Simulator:**

- Cell 1 and Cell 12
- System information combination 3 as defined in TS 36.508 [18] clause 4.4.3.1 is used in E-UTRA cells.
- The PLMNs are identified in the test by the identifiers in Table 8.6.6.7.3.1-1.

Table 8.6.6.7.3.1-1: PLMN identifiers

Cell	PLMN name
1	PLMN1
12	PLMN2

UE:

None.

Preamble:

- The UE is registered on PLMN1 (Cell 1) using the procedure described in TS 36.508[18] clause 4.5.2.3 except that the ATTACH ACCEPT message indicates PLMN2 in the Equivalent PLMN list as described in Table 8.6.6.7.3.3-12.
- The UE is in state Generic RB Established (state 3) on Cell 1 according to [18].

8.6.6.7.3.2 Test procedure sequence

Table 8.6.6.7.3.2-1 illustrates the downlink power levels and other changing parameters to be applied for the cells at various time instants of the test execution. Configurations marked "T1" are applied at the points indicated in the Main behaviour description in Table 8.6.6.7.3.2-2. The exact instants on which these values shall be applied are described in the texts in this clause.

Table 8.6.6.7.3.2-1: Time instances of cell power level and parameter changes

	Parameter	Unit	Cell 1	Cell 12	Remark
T1	Cell-specific RS EPRE	dBm/15kHz	-85	-79	The power level values are such that measurement results for Cell 1 (M1) and Cell 12 (M12) satisfy entry condition for event A3 (M12 > M1).

Table 8.6.6.7.3.2-2: Main behaviour

St	Procedure	Message Sequence		TP	Verdict
		U - S	Message		
1	The SS transmits an <i>RRConnectionReconfiguration</i> message to setup inter-frequency measurement on Cell 1.	<--	<i>RRConnectionReconfiguration</i>	-	-
2	The UE transmits an <i>RRConnectionReconfigurationComplete</i> message on Cell 1.	-->	<i>RRConnectionReconfigurationComplete</i>	-	-
3	The SS changes Cell 1 and Cell 12 parameters according to the row "T1" in Table 8.6.6.7.3.2-1.	-	-	-	-
4	The UE transmits a <i>MeasurementReport</i> message on Cell 1.	-->	<i>MeasurementReport</i>	-	-
5	The SS transmits an <i>RRConnectionReconfiguration</i> message on Cell 1 to order the UE to perform inter frequency handover to Cell 12.	<--	<i>RRConnectionReconfiguration</i>	-	-
-	EXCEPTION: In parallel to the events described in step 6 the steps specified in Table 8.6.6.7.3.2-3 should take place.	-	-	-	-
6	The UE transmits an <i>RRConnectionReestablishmentRequest</i> message on Cell 12.	-->	<i>RRConnectionReestablishmentRequest</i>	-	-
7	The SS transmits an <i>RRConnectionReestablishment</i> message on Cell 12.	<--	<i>RRConnectionReestablishment</i>	-	-
8	Check: Does the UE transmit an <i>RRConnectionReestablishmentComplete</i> message with <i>rif-InfoAvailable</i> on Cell 12?	-->	<i>RRConnectionReestablishmentComplete</i>	1	P
9	The SS transmits an <i>RRConnectionReconfiguration</i> message to resume existing radio bearer on Cell 12.	<--	<i>RRConnectionReconfiguration</i>	-	-
10	The UE transmits an <i>RRConnectionReconfigurationComplete</i> message on Cell 12.	-->	<i>RRConnectionReconfigurationComplete</i>	-	-
11	The SS sends a <i>UEInformationRequest</i> message with <i>rif-ReportReq</i> set to true.	<--	<i>UEInformationRequest</i>	-	-
12	Check: Does the UE transmit a <i>UEInformationResponse</i> message including <i>rif-Report</i> ?	-->	<i>UEInformationResponse</i>	2	P

Table 8.6.6.7.3.2-3: Parallel behaviour

St	Procedure	Message Sequence		TP	Verdict
		U - S	Message		
-	EXCEPTION: The steps 1 and 2 below are repeated for the duration of T304.	-	-	-	-
1	The UE attempts to perform the inter-frequency handover using MAC Random Access Preamble on Cell 12.	-	-	-	-
2	The SS does not respond.	-	-	-	-

8.6.6.7.3.3 Specific message contents

Table 8.6.6.7.3.3-1: SystemInformationBlockType2 for Cell 12 (preamble and all steps, Table 8.6.6.7.3.2-2)

Derivation Path: 36.508, Table 4.4.3.3-1			
Information Element	Value/remark	Comment	Condition
SystemInformationBlockType2 ::= SEQUENCE {			
radioResourceConfigCommon SEQUENCE {			
rach-ConfigCommon SEQUENCE {			
ra-SupervisionInfo SEQUENCE {			
preambleTransMax	n50		
}			
}			
uplinkPowerControlCommon-v1020	Not present		
}			
lateNonCriticalExtension	Not present		
ssac-BarringForMMTEL-Voice-r9	Not present		
ssac-BarringForMMTEL-Video-r9	Not present		
ac-BarringForCSFB-r10	Not present		
}			
}			

Table 8.6.6.7.3.3-2: RRCConnectionReconfiguration (step 1, Table 8.6.6.7.3.2-2)

Derivation Path: 36.508, Table 4.6.1-8, condition MEAS			
--	--	--	--

Table 8.6.6.7.3.3-3: MeasConfig (Table 8.6.6.7.3.3-2)

Derivation Path: 36.508, Table 4.6.6-1			
Information Element	Value/remark	Comment	Condition
MeasConfig ::= SEQUENCE {			
measObjectToAddModList SEQUENCE (SIZE (1..maxObjectId)) OF SEQUENCE {	1 entry		
measObjectId[1]	IdMeasObject-f1		
measObject[1]	MeasObjectEUTRA-GENERIC(f1)		
measObjectId[2]	IdMeasObject-f2		
measObject[2]	MeasObjectEUTRA-GENERIC(f2)		
}			
reportConfigToAddModList SEQUENCE (SIZE (1..maxReportConfigId)) OF SEQUENCE {	1 entry		
reportConfigId[1]	IdReportConfig-A3		
reportConfig[1]	ReportConfigEUTRA-A3		
}			
measIdToAddModList SEQUENCE (SIZE (1..maxMeasId)) OF SEQUENCE {			
measId[1]	1		
measObjectId[1]	IdMeasObject-f2		
reportConfigId[1]	IdReportConfig-A3		
}			
}			

Table 8.6.6.7.3.3-4: MeasurementReport (step 4, Table 8.6.6.7.3.2-2)

Derivation Path: 36.508, Table 4.6.1-5			
Information Element	Value/remark	Comment	Condition
MeasurementReport ::= SEQUENCE {			
criticalExtensions CHOICE {			
c1 CHOICE{			
measurementReport-r8 SEQUENCE {			
measResults SEQUENCE {			
measId	1		
measResultPCell SEQUENCE {		Cell 1	
rsrpResult	(0..97)		
rsrqResult	(0..34)		
}			
measResultNeighCells CHOICE {			
measResultListEUTRA SEQUENCE (SIZE (1..maxCellReport)) OF SEQUENCE {	1 entry		
physCellId	PhysicalCellIdentity of Cell 12	Cell 12	
cgi-Info	Not present		
measResult SEQUENCE {			
rsrpResult	(0..97)		
rsrqResult	(0..34)		
additionalSI-Info-r9	Not present		
}			
}			
}			
measResultForECID-r9	Not present		
locationInfo-r10	Not present		
measResultServFreqList-r10	Not present		
}			
}			

Table 8.6.6.7.3.3-5: RRCConnectionReconfiguration (step 5, Table 8.6.6.7.3.2-2)

Derivation Path: 36.508, Table 4.6.1-8, condition HO

Table 8.6.6.7.3.3-6: MobilityControlInfo (Table 8.6.6.7.3.3-5)

Derivation Path: 36.508, Table 4.6.5-1			
Information Element	Value/remark	Comment	Condition
MobilityControlInfo ::= SEQUENCE {			
targetPhysCellId	PhysicalCellIdentity of Cell 12		
carrierFreq	Same downlink EARFCN as used for Cell 12		
}			

Table 8.6.6.7.3.3-7: RRCConnectionReestablishmentRequest (step 6, Table 8.6.6.7.3.2-2)

Derivation Path: 36.508, Table 4.6.1-13			
Information Element	Value/remark	Comment	Condition
RRCConnectionReestablishmentRequest ::= SEQUENCE {			
criticalExtensions CHOICE {			
rrcConnectionReestablishmentRequest-r8			
SEQUENCE {			
ue-Identity SEQUENCE {			
c-RNTI	the C-RNTI used in the Cell 1		
physCellId	PhysicalCellIdentity of Cell 1		
shortMAC-I	The same value as the 16 least significant bits of the XMAC-I value calculated by SS		
}			
reestablishmentCause	handoverFailure		
}			
}			

Table 8.6.6.7.3.3-8: RRCConnectionReestablishmentComplete (step 8, Table 8.6.6.7.3.2-2)

Derivation Path: 36.508, Table 4.6.1-11			
Information Element	Value/remark	Comment	Condition
RRCConnectionReestablishmentComplete ::= SEQUENCE {			
criticalExtensions CHOICE {			
rrcConnectionReestablishmentComplete-r8 =			
SEQUENCE {			
nonCriticalExtension SEQUENCE {			
rfl-InfoAvailable-r9	true		
nonCriticalExtension	Not present or any allowed value		
}			
}			
}			

Table 8.6.6.7.3.3-9: RRCConnectionReconfiguration (step 9, Table 8.6.6.7.3.2-2)

Derivation Path: 36.508, Table 4.6.1-8			
Information Element	Value/remark	Comment	Condition
RRCConnectionReconfiguration ::= SEQUENCE {			
criticalExtensions CHOICE {			
c1 CHOICE {			
rrcConnectionReconfiguration-r8 SEQUENCE {			
radioResourceConfigDedicated	RadioResourceConfigDedicated-HO		
}			
}			
}			

Table 8.6.6.7.3.3-10: UEInformationRequest (step 11, Table 8.6.6.7.3.2-2)

Derivation Path: 36.508, Table 4.6.1-23A, condition RLF report			

Table 8.6.6.7.3.3-11: *UEInformationResponse* (step 12, Table 8.6.6.7.3.2-2)

Derivation Path: 36.508, Table 4.6.1-23B			
Information Element	Value/remark	Comment	Condition
<i>UEInformationResponse</i> -r9 ::=SEQUENCE {			
criticalExtensions CHOICE {			
c1 CHOICE {			
<i>ueInformationResponse</i> -r9 SEQUENCE {			
rfl-Report-r9 SEQUENCE {			
measResultLastServCell-r9 SEQUENCE {			
rsrpResult-r9	(0..97)	Cell 1	
rsrqResult-r9	Not present or (0..34)		
}			
measResultNeighCells-r9 SEQUENCE {			
measResultListEUTRA-r9 SEQUENCE (SIZE (1..maxFreq)) OF SEQUENCE {	1 entry		
carrierFreq-r9[1]	Same downlink EARFCN as used for Cell 12		
measResultList-r9[1] SEQUENCE (SIZE (1..maxCellReport)) OF SEQUENCE {	1 entry		
physCellId[1]	PhysicalCellIdentity of Cell 12		
cgi-Info[1]	Not present		
measResult[1] SEQUENCE {			
rsrpResult	(0..97)		
rsrqResult	(0..34)		
additionalSI-Info-r9	Not present		
}			
}			
}			
measResultListUTRA-r9	Not present		
measResultListGERAN-r9	Not present		
measResultsCDMA2000-r9	Not present		
}			
locationInfo-r10	Not present or any allowed value		
failedPCellId-r10 CHOICE {	cellGlobalId-r10 or pci-arfcn-r10	If the UE has the global cell identity depending on UE implementation, the UE sets the global cell identity; otherwise the UE sets the physical cell identity and the carrier frequency.	
cellGlobalId-r10 SEQUENCE {			
plmn-Identity	<i>plmn-Identity</i> within <i>SystemInformationBlockType1</i> broadcasted in Cell 12		
cellIdentity	<i>cellIdentity</i> within <i>SystemInformationBlockType1</i> broadcasted in Cell 12		
}			
pci-arfcn-r10 SEQUENCE {			
physCellId-r10	PhysicalCellIdentity of Cell 12		
carrierFreq-r10	Same downlink EARFCN as used for Cell 12		
}			
}			
reestablishmentCellId-r10 SEQUENCE {			
plmn-Identity	<i>plmn-Identity</i> within <i>SystemInformationBlockT</i>		

	<i>ype1</i> broadcasted in Cell 12		
<i>cellIdentity</i>	<i>cellIdentity</i> within <i>SystemInformationBlockType1</i> broadcasted in Cell 12		
}			
<i>timeConnFailure-r10</i>	Any allowed value	Time from UE receive HO command to the failure	
<i>connectionFailureType-r10</i>	hof		
<i>previousPCellId-r10</i> SEQUENCE {			
<i>plmn-Identity</i>	<i>plmn-Identity</i> within <i>SystemInformationBlockType1</i> broadcasted in Cell 1		
<i>cellIdentity</i>	<i>cellIdentity</i> within <i>SystemInformationBlockType1</i> broadcasted in Cell 1		
}			
<i>basicFields-r11</i> SEQUENCE {			
<i>c-RNTI-r11</i>	C-RNTI used in Cell 1		
<i>rlf-Cause-r11</i>	randomAccessProblem		
<i>timeSinceFailure-r11</i>	Any value	Time elapsed from connection failure	
}			
}			
}			
}			
}			
}			

Table 8.6.6.7.3.3-12: ATTACH ACCEPT for Cell 1 (preamble)

Derivation path: 36.508 Table 4.7.2-1			
Information Element	Value/Remark	Comment	Condition
Equivalent PLMNs	PLMN2		

8.6.7 Inter-RAT Logged Handover Failure

8.6.7.1 Handover Failure logging / Reporting of UTRAN Inter-RAT measurements

8.6.7.1.1 Test Purpose (TP)

(1)

```

with { UE in RRC_CONNECTED having performed the UTRA measurement and reported that the UE has
handover failure information available }
ensure that {
  when { UE receives the UEInformationRequest message containing rlf-ReportReq }
  then { UE sends the UEInformationResponse message containing the measurement result for UTRA
neighbour cell }
}
    
```

8.6.7.1.2 Conformance requirements

References: The conformance requirements covered in the present TC are specified in: TS 36.331, clause 5.3.5.6, 5.3.7.4, 5.3.7.5 and 5.6.5.3.

[TS 36.331, clause 5.3.5.6]

The UE shall:

1> if T304 expires (handover failure):

NOTE 1: Following T304 expiry any dedicated preamble, if provided within the *rach-ConfigDedicated*, is not available for use by the UE anymore.

- 2> revert back to the configuration used in the source PCell, excluding the configuration configured by the *physicalConfigDedicated*, the *mac-MainConfig* and the *sps-Config*;
- 2> store the following handover failure information in *VarRLF-Report* by setting its fields as follows:
 - 3> clear the information included in *VarRLF-Report*, if any;
 - 3> set the *plmn-Identity* to the RPLMN;
 - 3> set the *measResultLastServCell* to include the RSRP and RSRQ, if available, of the PCell based on measurements collected up to the moment the UE detected handover failure;
 - 3> set the *measResultNeighCells* to include the best measured cells, other than the PCell, ordered such that the best cell is listed first, and based on measurements collected up to the moment the UE detected handover failure, and set its fields as follows:
 - 4> if the UE was configured to perform measurements for one or more EUTRA frequencies, include the *measResultListEUTRA*;
 - 4> if the UE was configured to perform measurement reporting for one or more neighbouring UTRA frequencies, include the *measResultListUTRA*;
 - 4> if the UE was configured to perform measurement reporting for one or more neighbouring GERAN frequencies, include the *measResultListGERAN*;
 - 4> if the UE was configured to perform measurement reporting for one or more neighbouring CDMA2000 frequencies, include the *measResultsCDMA2000*;

NOTE 2: The measured quantities are filtered by the L3 filter as configured in the mobility measurement configuration. The measurements are based on the time domain measurement resource restriction, if configured. Blacklisted cells are not required to be reported.

- 3> if detailed location information is available, set the content of the *locationInfo* as follows:
 - 4> include the *locationCoordinates*;
 - 4> include the *horizontalVelocity*, if available;
- 3> set the *failedPCellId* to the global cell identity, if available, and otherwise to the physical cell identity and carrier frequency of the target PCell of the failed handover;
- 3> include *previousPCellId* and set it to the global cell identity of the PCell where the last *RRCCONNECTIONRECONFIGURATION* message including *mobilityControlInfo* was received;
- 3> set the *timeConnFailure* to the elapsed time since reception of the last *RRCCONNECTIONRECONFIGURATION* message including the *mobilityControlInfo*;
- 3> set the *connectionFailureType* to 'hof';
- 2> initiate the connection re-establishment procedure as specified in 5.3.7, upon which the RRC connection reconfiguration procedure ends;

The UE may discard the handover failure information, i.e. release the UE variable *VarRLF-Report*, 48 hours after the failure is detected, upon power off or upon detach.

NOTE 3: E-UTRAN may retrieve the handover failure information using the UE information procedure with *rlf-ReportReq* set to *true*, as specified in 5.6.5.3.

[TS 36.331, clause 5.3.7.4]

If the procedure was initiated due to radio link failure or handover failure, the UE shall:

1> set the *reestablishmentCellId* in the *VarRLF-Report* to the global cell identity of the selected cell;

[TS 36.331, clause 5.3.7.5]

The UE shall:

...

1> set the content of *RRCCConnectionReestablishmentComplete* message as follows:

2> if the UE has radio link failure or handover failure information available in *VarRLF-Report* and *plmn-Identity* stored in *VarRLF-Report* is equal to the RPLMN:

3> include the *rlf-InfoAvailable*;

...

1> submit the *RRCCConnectionReestablishmentComplete* message to lower layers for transmission, upon which the procedure ends;

[TS 36.331, clause 5.6.5.3]

Upon receiving the *UEInformationRequest* message, the UE shall:

...

1> if *rlf-ReportReq* is set to *true* and the UE has radio link failure information or handover failure information available in *VarRLF-Report* and *plmn-Identity* stored in *VarRLF-Report* is equal to the RPLMN, set the *rlf-Report* in the *UEInformationResponse* message to the value of *rlf-Report* in *VarRLF-Report*;

1> if the *rlf-Report* is included in *UEInformationResponse*:

2> discard the *rlf-Report* from *VarRLF-Report* upon successful delivery of the *UEInformationResponse* message confirmed by lower layers.

...

1> if the *logMeasReport* is included in the *UEInformationResponse*:

...

1> else:

2> submit the *UEInformationResponse* message to lower layers for transmission via SRB1;

8.6.7.1.3 Test description

8.6.7.1.3.1 Pre-test conditions

System Simulator:

- Cell 1, Cell 2 and Cell 5
- System information combination 4 as defined in TS 36.508 [18] clause 4.4.3.1 is used in E-UTRA cells.

UE:

None.

Preamble:

- The UE is in state Generic RB Established (state 3) on Cell 1 according to [18].

8.6.7.1.3.2 Test procedure sequence

Table 8.6.7.1.3.2-1 illustrates the downlink power levels and other changing parameters to be applied for the cells at various time instants of the test execution. Row marked "T0" denotes the initial conditions after preamble, while columns marked "T1", "T2" and "T3" are to be applied subsequently. The exact instants on which these values shall be applied are described in the texts in this clause

Table 8.6.7.1.3.2-1: Time instances of cell power level and parameter changes

	Parameter	Unit	Cell 1	Cell 2	Cell 5	Remark
T0	Cell-specific RS EPRE	dBm/15kHz	-60	-60	-	The power level values are such that entering conditions for event A3 and event B2 are not satisfied.
	CPICH Ec (UTRA FDD)	dBm/3.84MHz	-	-	-88	
	PCCPCH Ec (UTRA LCR TDD)	dBm/1.28 MHz	-	-	-88	
T1	Cell-specific RS EPRE	dBm/15kHz	-84	-84	-	The power level values are such that entering conditions for event B2 are satisfied.
	CPICH Ec (UTRA FDD)	dBm/3.84MHz	-	-	-64	
	PCCPCH Ec (UTRA LCR TDD)	dBm/1.28 MHz	-	-	-64	
T2	Cell-specific RS EPRE	dBm/15kHz	-80	-74	-	The power level values are such that entering conditions for event A3 are satisfied. (NOTE 1)
	CPICH Ec (UTRA FDD)	dBm/3.84MHz	-	-	"Off"	
	PCCPCH Ec (UTRA LCR TDD)	dBm/1.28 MHz	-	-	"Off"	
T3	Cell-specific RS EPRE	dBm/15kHz	"Off"	-74	-	Only Cell 2 is available. (NOTE 1,NOTE 2)
	CPICH Ec (UTRA FDD)	dBm/3.84MHz	-	-	"Off"	
	PCCPCH Ec (UTRA LCR TDD)	dBm/1.28 MHz	-	-	"Off"	
NOTE 1: Power level "Off" for UTRA cell is defined in TS 34.108 Table 6.1.4.						
NOTE 2: Power level "Off" for E-UTRA cell is defined in TS 36.508 Table 6.2.2.1-1.						

Table 8.6.7.1.3.2-2: Main behaviour

St	Procedure	Message Sequence		TP	Verdict
		U - S	Message		
1	The SS transmits an <i>RRConnectionReconfiguration</i> message to setup inter-RAT measurement on Cell 1.	<--	<i>RRConnectionReconfiguration</i>	-	-
2	The UE transmits an <i>RRConnectionReconfigurationComplete</i> message on Cell 1.	-->	<i>RRConnectionReconfigurationComplete</i>	-	-
3	The SS changes Cell 1, Cell 2 and Cell 5 parameters according to the row "T1" in Table 8.6.7.1.3.2-1.	-	-	-	-
4	The UE transmits a <i>MeasurementReport</i> message on Cell 1.	-->	<i>MeasurementReport</i>	-	-
5	The SS changes Cell 2 and Cell 5 parameters according to the row "T2" in Table 8.6.7.1.3.2-1.	-	-	-	-
6	The UE transmits a <i>MeasurementReport</i> message on Cell 1.	-->	<i>MeasurementReport</i>	-	-
7	The SS transmits an <i>RRConnectionReconfiguration</i> message including <i>mobilityControlInfo</i> on Cell 1.	<--	<i>RRConnectionReconfiguration</i>	-	-
-	EXCEPTION: In parallel to the events described in step 8 the steps specified in Table 8.6.7.1.3.2-3 should take place.	-	-	-	-
8	The SS changes Cell 1 parameter according to the row "T3" in Table 8.6.7.1.3.2-1.	-	-	-	-
9	The UE transmits an <i>RRConnectionReestablishmentRequest</i> message on Cell 2.	-->	<i>RRConnectionReestablishmentRequest</i>	-	-
10	The SS transmits an <i>RRConnectionReestablishment</i> message on Cell 2.	<--	<i>RRConnectionReestablishment</i>	-	-
11	The UE transmits an <i>RRConnectionReestablishmentComplete</i> message with handover failure information on Cell 2.	-->	<i>RRConnectionReestablishmentComplete</i>	-	-
12	The SS transmits an <i>RRConnectionReconfiguration</i> message on Cell 2.	<--	<i>RRConnectionReconfiguration</i>	-	-
13	The UE transmits an <i>RRConnectionReconfigurationComplete</i> message on Cell 2.	-->	<i>RRConnectionReconfigurationComplete</i>	-	-
14	The SS transmits a <i>UEInformationRequest</i> message on Cell 2.	<--	<i>UEInformationRequest</i>	-	-
15	Check: Does the UE transmit a <i>UEInformationResponse</i> message on Cell 2?	-->	<i>UEInformationResponse</i>	1	P
16	Check: Does the test result of generic test procedure in TS 36.508 subclause 6.4.2.3 indicate that the UE is in E-UTRA RRC_CONNECTED state on Cell 2?	-	-	1	-

Table 8.6.7.1.3.2-3: Parallel behaviour

St	Procedure	Message Sequence		TP	Verdict
		U - S	Message		
-	EXCEPTION: The steps 1 and 2 below are repeated for the duration of T304.	-	-	-	-
1	The UE attempts to perform the handover using MAC Random Access Preamble on Cell 2.	-	-	-	-
2	The SS does not respond.	-	-	-	-

8.6.7.1.3.3 Specific message contents

Table 8.6.7.1.3.3-1: SystemInformationBlockType2 for Cell 2 (preamble and all steps, Table 8.6.7.1.3.2-2)

Derivation Path: 36.508, Table 4.4.3.3-1			
Information Element	Value/remark	Comment	Condition
SystemInformationBlockType2 ::= SEQUENCE {			
radioResourceConfigCommon SEQUENCE {			
rach-ConfigCommon SEQUENCE {			
ra-SupervisionInfo SEQUENCE {			
preambleTransMax	n50		
}			
uplinkPowerControlCommon-v1020	Not present		
}			
ssac-BarringForMMTEL-Voice-r9	Not present		
ssac-BarringForMMTEL-Video-r9	Not present		
ac-BarringForCSFB-r10	Not present		
}			

Table 8.6.7.1.3.3-2: RRCConnectionReconfiguration (step 1, Table 8.6.7.1.3.2-2)

Derivation Path: 36.508, Table 4.6.1-8, condition MEAS			
--	--	--	--

Table 8.6.7.1.3.3-3: MeasConfig (Table 8.6.7.1.3.3-2)

Derivation Path: 36.508, Table 4.6.6-1, condition UTRAN			
Information Element	Value/remark	Comment	Condition
MeasConfig ::= SEQUENCE {			
measObjectToAddModList SEQUENCE (SIZE (1..maxObjectId)) OF SEQUENCE {	2 entries		
measObjectId[1]	IdMeasObject-f1		
measObject[1]	MeasObjectEUTRA-GENERIC(f1)		
measObjectId[2]	IdMeasObject-f8		
measObject[2]	MeasObjectUTRA-f8		
}			
reportConfigToAddModList SEQUENCE (SIZE (1..maxReportConfigId)) OF SEQUENCE {	2 entries		
reportConfigId[1]	IdReportConfig-A3		
reportConfig[1]	ReportConfigEUTRA-A3		
reportConfigId[2]	IdReportConfig-B2-UTRA		
reportConfig[2]	ReportConfigInterRAT-B2-UTRA(-72, -76)		
}			
measIdToAddModList SEQUENCE (SIZE (1..maxMeasId)) OF SEQUENCE {	2 entries		
measId[1]	1		
measObjectId[1]	IdMeasObject-f1		
reportConfigId[1]	IdReportConfig-A3		
measId[2]	2		
measObjectId[2]	IdMeasObject-f8		
reportConfigId[2]	IdReportConfig-B2-UTRA		
}			
}			

Condition	Explanation
UTRA-FDD	UTRA FDD cell environment
UTRA-TDD	UTRA TDD cell environment

Table 8.6.7.1.3.3-4: QuantityConfig (Table 8.6.7.1.3.3-3)

Derivation Path: 36.508, Table 4.6.6-3A, condition UTRAN			
Information Element	Value/remark	Comment	Condition
QuantityConfig SEQUENCE {			
quantityConfigUTRA SEQUENCE {			
measQuantityUTRA-FDD	cpich-RSCP		UTRA-FDD
measQuantityUTRA-TDD	pccpch-RSCP		UTRA-TDD
filterCoefficient	fc0		
}			
quantityConfigUTRA-v1020	Not present		
}			

Condition	Explanation
UTRA-FDD	UTRA FDD cell environment
UTRA-TDD	UTRA TDD cell environment

Table 8.6.7.1.3.3-5: MeasObjectUTRA-f8 (Table 8.6.7.1.3.3-3)

Derivation Path: 36.508, Table 4.6.6-3			
Information Element	Value/remark	Comment	Condition
MeasObjectUTRA ::= SEQUENCE {			
carrierFreq	Same downlink ARFCN as used for Cell 5		
cellsToAddModList CHOICE {			
cellsToAddModListUTRA-FDD SEQUENCE (SIZE (1..maxCellMeas)) OF SEQUENCE {			UTRA-FDD
cellIndex[1]	1		
physCellId[1]	PhysicalCellIdentity of Cell 5		
}			
cellsToAddModListUTRA-TDD SEQUENCE (SIZE (1..maxCellMeas)) OF SEQUENCE {			UTRA-TDD
cellIndex[1]	1		
physCellId[1]	PhysicalCellIdentity of Cell 5		
}			
}			
csg-allowedReportingCells-v930	Not present		
}			

Condition	Explanation
UTRA-FDD	UTRA FDD cell environment
UTRA-TDD	UTRA TDD cell environment

Table 8.6.7.1.3.3-7: MeasurementReport (step 6, Table 8.6.7.1.3.2-2)

Derivation Path: 36.508, Table 4.6.1-5			
Information Element	Value/remark	Comment	Condition
MeasurementReport ::= SEQUENCE {			
criticalExtensions CHOICE {			
c1 CHOICE{			
measurementReport-r8 SEQUENCE {			
measResults SEQUENCE {			
measId	1		
measResultServCell SEQUENCE {			
rsrpResult	(0..97)		
rsrqResult	(0..34)		
}			
measResultNeighCells CHOICE {			
measResultListEUTRA SEQUENCE (SIZE (1..maxCellReport)) OF SEQUENCE {	1 entry		
physCellId[1]	PhysicalCellIdentity of Cell 2		
cgi-Info[1]	Not present		
measResult[1] SEQUENCE {			
rsrpResult	(0..97)		
rsrqResult	(0..34)		
additionalSI-Info-r9	Not present		
}			
}			
}			
measResultForECID-r9	Not present		
locationInfo-r10	Not present		
measResultServFreqList-r10	Not present		
}			
}			

Table 8.6.7.1.3.3-8: RRCConnectionReconfiguration (step 7, Table 8.6.7.1.3.2-2)

Derivation Path: 36.508, Table 4.6.1-8, condition HO
--

Table 8.6.7.1.3.3-9: MobilityControlInfo (Table 8.6.7.1.3.3-8)

Derivation Path: 36.508, Table 4.6.5-1			
Information Element	Value/remark	Comment	Condition
MobilityControlInfo ::= SEQUENCE {			
targetPhysCellId	PhysicalCellIdentity of Cell 2		
carrierFreq	Not present		
}			

Table 8.6.7.1.3.3-10: RRCConnectionReestablishmentRequest (step 9, Table 8.6.7.1.3.2-2)

Derivation Path: 36.508, Table 4.6.1-13			
Information Element	Value/remark	Comment	Condition
RRCConnectionReestablishmentRequest ::= SEQUENCE {			
criticalExtensions CHOICE {			
rrcConnectionReestablishmentRequest-r8			
SEQUENCE {			
ue-Identity SEQUENCE {			
c-RNTI	the value of the C-RNTI of the UE		
physCellId	PhysicalCellIdentity of Cell 1		
shortMAC-I	The same value as the 16 least significant bits of the XMAC-I value calculated by SS		
}			
reestablishmentCause	handoverFailure		
}			
}			

Table 8.6.7.1.3.3-11: RRCConnectionReestablishmentComplete (step 11, Table 8.6.7.1.3.2-2)

Derivation Path: 36.508, Table 4.6.1-11			
Information Element	Value/remark	Comment	Condition
RRCConnectionReestablishmentComplete ::= SEQUENCE {			
criticalExtensions CHOICE {			
rrcConnectionReestablishmentComplete-r8 =			
SEQUENCE {			
nonCriticalExtension SEQUENCE {			
rfl-InfoAvailable-r9	true		
nonCriticalExtension	Not present or any allowed value		
}			
}			
}			

Table 8.6.7.1.3.3-12: RRCConnectionReconfiguration (step 12, Table 8.6.7.1.3.2-2)

Derivation Path: 36.508, Table 4.6.1-8			
Information Element	Value/remark	Comment	Condition
RRCConnectionReconfiguration ::= SEQUENCE {			
criticalExtensions CHOICE {			
c1 CHOICE{			
rrcConnectionReconfiguration-r8 SEQUENCE {			
radioResourceConfigDedicated	RadioResourceConfigDedicated-HO		
}			
}			
}			

Table 8.6.7.1.3.3-13: UEInformationRequest (step 14, Table 8.6.7.1.3.2-2)

Derivation Path: 36.508, Table 4.6.1-23A			
Information Element	Value/remark	Comment	Condition
UEInformationRequest-r9 ::=SEQUENCE {			
criticalExtensions CHOICE {			
c1 CHOICE {			
ueInformationRequest-r9 SEQUENCE {			
rf-ReportReq-r9	TRUE		
}			
}			
}			
}			

Table 8.6.7.1.3.3-14: *UEInformationResponse* (step 15, Table 8.6.7.1.3.2-2)

Derivation Path: 36.508, Table 4.6.1-23B			
Information Element	Value/remark	Comment	Condition
UEInformationResponse-r9 ::=SEQUENCE {			
criticalExtensions CHOICE {			
c1 CHOICE {			
ueInformationResponse-r9 SEQUENCE {			
r1f-Report-r9 SEQUENCE {			
measResultLastServCell-r9 SEQUENCE {			
rsrpResult-r9	(0..97)		
rsrqResult-r9	Not present or (0..34)		
}			
measResultNeighCells-r9 SEQUENCE {			
measResultListEUTRA-r9 SEQUENCE (SIZE (1..maxFreq)) OF SEQUENCE {	1 entry		
carrierFreq-r9[1]	Same downlink EARFCN as used for Cell 2		
measResultList-r9[1] SEQUENCE (SIZE (1..maxCellReport)) OF SEQUENCE {	1 entry		
physCellId[1]	PhysicalCellId of Cell 2		
cgi-Info[1]	Not present		
measResult[1] SEQUENCE {			
rsrpResult	(0..97)		
rsrqResult	(0..34)		
additionalSI-Info-r9	Not present		
}			
}			
measResultListUTRA-r9 SEQUENCE (SIZE (1..maxFreq)) OF SEQUENCE {	1 entry		
carrierFreq-r9[1]	Same downlink ARFCN as used for Cell 5		
measResultList-r9 SEQUENCE (SIZE (1..maxCellReport)) OF SEQUENCE {	1 entry		
physCellId[1] CHOICE {			
fdd	Physical cell Identity of Cell 5		UTRA-FDD
tdt	Physical cell Identity of Cell 5		UTRA-TDD
}			
cgi-Info[1]	Not present		
measResult[1] SEQUENCE {			
utra-RSCP	Not present or (-5..91)		
utra-EcN0	Not present		
additionalSI-Info-r9	Not present		
}			
}			
measResultListGERAN-r9	Not present		
measResultsCDMA2000-r9	Not present		
}			
locationInfo-r10	Not present or any allowed value		
failedPCellId-r10 CHOICE {	cellGlobalId-r10 or pci-arfcn-r10	If the UE has the global cell identity depending on UE implementation, the UE sets the global cell identity, otherwise the UE sets the physical cell identity and the carrier frequency.	

cellGlobalId-r10 SEQUENCE {			
plmn-Identity	<i>plmn-Identity</i> within <i>SystemInformationBlockType1</i> broadcasted in Cell 2		
cellIdentity	<i>cellIdentity</i> within <i>SystemInformationBlockType1</i> broadcasted in Cell 2		
}			
pci-arfcn-r10 SEQUENCE {			
physCellId-r10	Physical cell Identity of Cell 2		
carrierFreq-r10	Same downlink EARFCN as used for Cell 2		
}			
}			
reestablishmentCellId-r10 SEQUENCE {			
plmn-Identity	<i>plmn-Identity</i> within <i>SystemInformationBlockType1</i> broadcasted in Cell 2		
cellIdentity	<i>cellIdentity</i> within <i>SystemInformationBlockType1</i> broadcasted in Cell 2		
}			
timeConnFailure-r10	Any allowed value		
connectionFailureType-r10	hof		
previousPCellId-r10 SEQUENCE {			
plmn-Identity	<i>plmn-Identity</i> within <i>SystemInformationBlockType1</i> broadcasted in Cell 1		
cellIdentity	<i>cellIdentity</i> within <i>SystemInformationBlockType1</i> broadcasted in Cell 1		
}			
}			
}			
}			
}			
}			

Condition	Explanation
UTRA-FDD	UTRA FDD cell environment
UTRA-TDD	UTRA TDD cell environment

8.6.7.2 Handover Failure logging / Reporting of GERAN Inter-RAT measurements

8.6.7.2.1 Test Purpose (TP)

(1)

```

with { UE in RRC_CONNECTED having performed the GERAN measurement and reported that the UE has
handover failure information available }
ensure that {
  when { UE receives the UEInformationRequest message containing rlf-ReportReq }
  then { UE sends the UEInformationResponse message containing the measurement result for GERAN
neighbour cell }
}
    
```

8.6.7.2.2 Conformance requirements

References: The conformance requirements covered in the present TC are specified in: TS 36.331, clause 5.3.5.6, 5.3.7.4, 5.3.7.5 and 5.6.5.3.

[TS 36.331, clause 5.3.5.6(TP1)]

The UE shall:

1> if T304 expires (handover failure):

NOTE: Following T304 expiry any dedicated preamble, if provided within the *rach-ConfigDedicated*, is not available for use by the UE anymore.

2> revert back to the configuration used in the source PCell, excluding the configuration configured by the *physicalConfigDedicated*, the *mac-MainConfig* and the *sps-Config*;

2> store the following handover failure information in *VarRLF-Report* by setting its fields as follows:

3> clear the information included in *VarRLF-Report*, if any;

3> set the *plmn-Identity* to the RPLMN;

3> set the *measResultLastServCell* to include the RSRP and RSRQ, if available, of the PCell based on measurements collected up to the moment the UE detected handover failure;

3> set the *measResultNeighCells* to include the best measured cells, other than the PCell, ordered such that the best cell is listed first, and based on measurements collected up to the moment the UE detected handover failure, and set its fields as follows;

4> if the UE was configured to perform measurements for one or more EUTRA frequencies, include the *measResultListEUTRA*;

4> if the UE was configured to perform measurement reporting for one or more neighbouring UTRA frequencies, include the *measResultListUTRA*;

4> if the UE was configured to perform measurement reporting for one or more neighbouring GERAN frequencies, include the *measResultListGERAN*;

4> if the UE was configured to perform measurement reporting for one or more neighbouring CDMA2000 frequencies, include the *measResultsCDMA2000*;

NOTE 1: The measured quantities are filtered by the L3 filter as configured in the mobility measurement configuration. The measurements are based on the time domain measurement resource restriction, if configured. Blacklisted cells are not required to be reported.

3> if detailed location information is available, set the content of the *locationInfo* as follows:

4> include the *locationCoordinates*;

4> include the *horizontalVelocity*, if available;

3> set the *failedPCellId* to the global cell identity, if available, and otherwise to the physical cell identity and carrier frequency of the target PCell of the failed handover;

3> include *previousPCellId* and set it to the global cell identity of the PCell where the last *RRConnectionReconfiguration* message including *mobilityControlInfo* was received;

3> set the *timeConnFailure* to the elapsed time since reception of the last *RRConnectionReconfiguration* message including the *mobilityControlInfo*;

3> set the *connectionFailureType* to 'hof';

2> initiate the connection re-establishment procedure as specified in 5.3.7, upon which the RRC connection reconfiguration procedure ends;

The UE may discard the handover failure information, i.e. release the UE variable *VarRLF-Report*, 48 hours after the failure is detected, upon power off or upon detach.

NOTE 2: E-UTRAN may retrieve the handover failure information using the UE information procedure with *rlf-ReportReq* set to *true*, as specified in 5.6.5.3.

[TS 36.331, clause 5.3.7.4(TP1)]

If the procedure was initiated due to radio link failure or handover failure, the UE shall:

1> set the *reestablishmentCellId* in the *VarRLF-Report* to the global cell identity of the selected cell;

The UE shall set the contents of *RRConnectionReestablishmentRequest* message as follows:

...

1> set the *reestablishmentCause* as follows:

...

2> else if the re-establishment procedure was initiated due to handover failure as specified in 5.3.5.6 (intra-LTE handover failure) or 5.4.3.5 (inter-RAT mobility from EUTRA failure):

3> set the *reestablishmentCause* to the value *handoverFailure*;

[TS 36.331, clause 5.3.7.5(TP1)]

The UE shall:

...

1> set the content of *RRConnectionReestablishmentComplete* message as follows:

2> if the UE has radio link failure or handover failure information available in *VarRLF-Report* and *plmn-Identity* stored in *VarRLF-Report* is equal to the RPLMN:

3> include the *rlf-InfoAvailable*;

...

1> submit the *RRConnectionReestablishmentComplete* message to lower layers for transmission, upon which the procedure ends;

[TS 36.331, clause 5.6.5.3(TP1)]

Upon receiving the *UEInformationRequest* message, the UE shall:

...

1> if *rlf-ReportReq* is set to *true* and the UE has radio link failure information or handover failure information available in *VarRLF-Report* and *plmn-Identity* stored in *VarRLF-Report* is equal to the RPLMN, set the *rlf-Report* in the *UEInformationResponse* message to the value of *rlf-Report* in *VarRLF-Report*;

1> if the *rlf-Report* is included in *UEInformationResponse*:

2> discard the *rlf-Report* from *VarRLF-Report* upon successful delivery of the *UEInformationResponse* message confirmed by lower layers.

...

1> if the *logMeasReport* is included in the *UEInformationResponse*:

...

1> else:

2> submit the *UEInformationResponse* message to lower layers for transmission via SRB1;

8.6.7.2.3 Test description

8.6.7.2.3.1 Pre-test conditions

System Simulator:

- Cell 1, Cell 2 and Cell 24 - Cell 1 and Cell 2 are E-UTRAN cell, Cell 24 is a GERAN cell.
- All cells belong to the same PLMN.
- System information combination 5 as defined in TS 36.508 [18] clause 4.4.3.1 is used in E-UTRA cells.

UE:

None.

Preamble:

- The UE is in state Generic RB Established (state 3) on Cell 1 according to [18].

8.6.7.2.3.2 Test procedure sequence

Table 8.6.7.2.3.2-1 illustrates the downlink power levels and other changing parameters to be applied for the cells at various time instants of the test execution. Row marked "T0" denotes the initial conditions after preamble, while columns marked "T1", "T2" and "T3" are to be applied subsequently. The exact instants on which these values shall be applied are described in the texts in this clause

Table 8.6.7.2.3.2-1: Time instances of cell power level and parameter changes

	Parameter	Unit	Cell 1	Cell 2	Cell 24	Remark
T0	Cell-specific RS EPRE	dBm/15kHz	-60	-60	-	The power level values are such that entering conditions for event A3 and event B2 are not satisfied.
	RSSI	dBm			-85	
T1	Cell-specific RS EPRE	dBm/15kHz	-80	-80	-	The power level values are such that entering conditions for event B2 are satisfied.
	RSSI	dBm			-65	
T2	Cell-specific RS EPRE	dBm/15kHz	-80	-74	-	The power level values are such that entering conditions for event A3 are satisfied. (NOTE 1)
	RSSI	dBm	-	-	"Off"	
T3	Cell-specific RS EPRE	dBm/15kHz	"Off"	-74	-	Only Cell 2 is available. (NOTE 1,NOTE 2)
	RSSI	dBm	-	-	"Off"	
NOTE 1: Power level "Off" for GERAN cell is defined in TS 36.508 Table 6.2.2.1-1.						
NOTE 2: Power level "Off" for E-UTRA cell is defined in TS 36.508 Table 6.2.2.1-1.						

Table 8.6.7.2.3.2-2: Main behaviour

St	Procedure	Message Sequence		TP	Verdict
		U - S	Message		
1	The SS transmits an <i>RRConnectionReconfiguration</i> message to setup inter-RAT measurement on Cell 1.	<--	<i>RRConnectionReconfiguration</i>	-	-
2	The UE transmits an <i>RRConnectionReconfigurationComplete</i> message on Cell 1.	-->	<i>RRConnectionReconfigurationComplete</i>	-	-
3	The SS changes Cell 1, Cell 2 and Cell 24 parameters according to the row "T1" in Table 8.6.7.2.3.2-1.	-	-	-	-
4	The UE transmits a <i>MeasurementReport</i> message on Cell 1.	-->	<i>MeasurementReport</i>	-	-
5	The SS changes Cell 2 and Cell 24 parameters according to the row "T2" in Table 8.6.7.2.3.2-1.	-	-	-	-
6	The UE transmits a <i>MeasurementReport</i> message on Cell 1.	-->	<i>MeasurementReport</i>	-	-
7	The SS transmits an <i>RRConnectionReconfiguration</i> message including <i>mobilityControlInfo</i> on Cell 1.	<--	<i>RRConnectionReconfiguration</i>	-	-
-	EXCEPTION: In parallel to the events described in step 8 the steps specified in Table 8.6.7.2.3.2-3 should take place.	-	-	-	-
8	The SS changes Cell 1 parameter according to the row "T3" in Table 8.6.7.2.3.2-1.	-	-	-	-
9	The UE transmits an <i>RRConnectionReestablishmentRequest</i> message on Cell 2.	-->	<i>RRConnectionReestablishmentRequest</i>	-	-
10	The SS transmits an <i>RRConnectionReestablishment</i> message on Cell 2.	<--	<i>RRConnectionReestablishment</i>	-	-
11	The UE transmits an <i>RRConnectionReestablishmentComplete</i> message with handover failure information on Cell 2.	-->	<i>RRConnectionReestablishmentComplete</i>	-	-
12	The SS transmits an <i>RRConnectionReconfiguration</i> message on Cell 2.	<--	<i>RRConnectionReconfiguration</i>	-	-
13	The UE transmits an <i>RRConnectionReconfigurationComplete</i> message on Cell 2.	-->	<i>RRConnectionReconfigurationComplete</i>	-	-
14	The SS transmits a <i>UEInformationRequest</i> message on Cell 2.	<--	<i>UEInformationRequest</i>	-	-
15	Check: Does the UE transmit a <i>UEInformationResponse</i> message on Cell 2?	-->	<i>UEInformationResponse</i>	1	P
16	Check: Does the test result of generic test procedure in TS 36.508 subclause 6.4.2.3 indicate that the UE is in E-UTRA RRC_CONNECTED state on Cell 2?	-	-	1	-

Table 8.6.7.2.3.2-3: Parallel behaviour

St	Procedure	Message Sequence		TP	Verdict
		U - S	Message		
-	EXCEPTION: The steps 1 and 2 below are repeated for the duration of T304.	-	-	-	-
1	The UE attempts to perform handover using MAC Random Access Preamble on Cell 2.	-	-	-	-
2	The SS does not respond.	-	-	-	-

8.6.7.2.3.3 Specific message contents

Table 8.6.7.2.3.3-1: SystemInformationBlockType2 for Cell 2 (preamble and all steps, Table 8.6.7.2.3.2-2)

Derivation Path: 36.508, Table 4.4.3.3-1			
Information Element	Value/remark	Comment	Condition
SystemInformationBlockType2 ::= SEQUENCE {			
radioResourceConfigCommon SEQUENCE {			
rach-ConfigCommon SEQUENCE {			
ra-SupervisionInfo SEQUENCE {			
preambleTransMax	n50		
}			
uplinkPowerControlCommon-v1020	Not present		
}			
ssac-BarringForMMTEL-Voice-r9	Not present		
ssac-BarringForMMTEL-Video-r9	Not present		
ac-BarringForCSFB-r10	Not present		
}			

Table 8.6.7.2.3.3-2: RRCConnectionReconfiguration (step 1, Table 8.6.7.2.3.2-2)

Derivation Path: 36.508, Table 4.6.1-8, condition MEAS			
--	--	--	--

Table 8.6.7.2.3.3-3: MeasConfig (Table 8.6.7.2.3.3-2)

Derivation Path: 36.508, Table 4.6.6-1, condition GERAN			
Information Element	Value/remark	Comment	Condition
MeasConfig ::= SEQUENCE {			
measObjectToAddModList SEQUENCE (SIZE (1..maxObjectId)) OF SEQUENCE {	2 entries		
measObjectId[1]	IdMeasObject-f1		
measObject[1]	MeasObjectEUTRA-GENERIC(f1)		
measObjectId[2]	IdMeasObject-f11		
measObject[2]	MeasObjectGERAN-GENERIC(f11)		
}			
reportConfigToAddModList SEQUENCE (SIZE (1..maxReportConfigId)) OF SEQUENCE {	2 entries		
reportConfigId[1]	IdReportConfig-A3		
reportConfig[1]	ReportConfigEUTRA-A3		
reportConfigId[2]	IdReportConfig-B2-GERAN		
reportConfig[2]	ReportConfigInterRAT-B2-GERAN(-69, [-79])		
}			
measIdToAddModList SEQUENCE (SIZE (1..maxMeasId)) OF SEQUENCE {	2 entries		
measId[1]	1		
measObjectId[1]	IdMeasObject-f1		
reportConfigId[1]	IdReportConfig-A3		
measId[2]	2		
measObjectId[2]	IdMeasObject-f11		
reportConfigId[2]	IdReportConfig-B2-GERAN		
}			
}			

Derivation Path: 36.508, Table 4.6.6-1, condition GERAN			
Information Element	Value/remark	Comment	Condition
MeasConfig ::= SEQUENCE {			
measObjectToAddModList SEQUENCE (SIZE (1..maxObjectld)) OF SEQUENCE {	2 entries		
measObjectld[1]	ldMeasObject-f1		
measObject[1]	MeasObjectEUTRA-GENERIC(f1)		
measObjectld[2]	ldMeasObject-f11		
measObject[2]	MeasObjectGERAN-GENERIC(f11)		
}			
reportConfigToAddModList SEQUENCE (SIZE (1..maxReportConfigld)) OF SEQUENCE {	1 entry		
reportConfigld[1]	ldReportConfig-B2-GERAN		
reportConfig[1]	ReportConfigInterRAT-B2-GERAN(-69, [-79])		
}			
measldToAddModList SEQUENCE (SIZE (1..maxMeasld)) OF SEQUENCE {	1 entry		
measld[1]	1		
measObjectld[1]	ldMeasObject-f11		
reportConfigld[1]	ldReportConfig-B2-GERAN		
}			
quantityConfig SEQUENCE {			
quantityConfigGERAN SEQUENCE {			
measQuantityGERAN	rssI		
filterCoefficient	fc0		
}			
}			
}			

Condition	Explanation
GERAN	For inter-RAT measurements with GERAN

Table 8.6.7.2.3.3-5: MeasObjectGERAN-GENERIC(f11) (Table 8.6.7.2.3.3-3)

Derivation Path: 36.508, Table 4.6.6-2A			
Information Element	Value/remark	Comment	Condition
MeasObjectUTRA-GENERIC(Freq) ::= SEQUENCE {			
carrierFreq	Same downlink ARFCN as used for Cell 24		
offsetFreq	0 (dB 0)		
cellsToRemoveList	Not present		
cellsToAddModList	Not present	For UTRA, the neighbouring cell list needs to be provided in specific test cases.	
cellForWhichToReportCGI	Not present		
}			

Table 8.6.7.2.3.3-6: *MeasurementReport* (step 4, Table 8.6.7.2.3.2-2)

Derivation Path: 36.508, Table 4.6.1-5			
Information Element	Value/remark	Comment	Condition
MeasurementReport ::= SEQUENCE {			
criticalExtensions CHOICE {			
c1 CHOICE{			
measurementReport-r8 SEQUENCE {			
measResults SEQUENCE {			
measId	2		
measResultPCell SEQUENCE {			
rsrpResult	(0..97)		
rsrqResult	(0..34)		
}			
measResultNeighCells CHOICE {			
measResultListGERAN SEQUENCE (SIZE (1..maxCellReport)) OF SEQUENCE {	1 entry		
physCellId[1] SEQUENCE {			
physCellId[1]	PhysicalCellIdentity of Cell 24		
}			
}			
cgi-Info[1]	Not present		
measResult[1] SEQUENCE {			
rssi	(0..63)		
additionalSI-Info-r9	Not present		
}			
}			
measResultForECID-r9	Not present		
locationInfo-r10	Not present		
measResultServFreqList-r10	Not present		
}			
}			
}			
}			
}			

Table 8.6.7.2.3.3-7: MeasurementReport (step 6, Table 8.6.7.2.3.2-2)

Derivation Path: 36.508, Table 4.6.1-5			
Information Element	Value/remark	Comment	Condition
MeasurementReport ::= SEQUENCE {			
criticalExtensions CHOICE {			
c1 CHOICE{			
measurementReport-r8 SEQUENCE {			
measResults SEQUENCE {			
measId	1		
measResultServCell SEQUENCE {			
rsrpResult	(0..97)		
rsrqResult	(0..34)		
}			
measResultNeighCells CHOICE {			
measResultListEUTRA SEQUENCE (SIZE (1..maxCellReport)) OF SEQUENCE {	1 entry		
physCellId[1]	PhysicalCellIdentity of Cell 2		
cgi-Info[1]	Not present		
measResult[1] SEQUENCE {			
rsrpResult	(0..97)		
rsrqResult	(0..34)		
additionalSI-Info-r9	Not present		
}			
}			
}			
measResultForECID-r9	Not present		
locationInfo-r10	Not present		
measResultServFreqList-r10	Not present		
}			
}			

Table 8.6.7.2.3.3-8: RRCConnectionReconfiguration (step 7, Table 8.6.7.2.3.2-2)

Derivation Path: 36.508, Table 4.6.1-8, condition HO
--

Table 8.6.7.2.3.3-9: MobilityControlInfo (Table 8.6.7.2.3.3-8)

Derivation Path: 36.508, Table 4.6.5-1			
Information Element	Value/remark	Comment	Condition
MobilityControlInfo ::= SEQUENCE {			
targetPhysCellId	PhysicalCellIdentity of Cell 2		
carrierFreq	Not present		
}			

Table 8.6.7.2.3.3-10: RRCConnectionReestablishmentRequest (step 9, Table 8.6.7.2.3.2-2)

Derivation Path: 36.508, Table 4.6.1-13			
Information Element	Value/remark	Comment	Condition
RRCConnectionReestablishmentRequest ::= SEQUENCE {			
criticalExtensions CHOICE {			
rrcConnectionReestablishmentRequest-r8			
SEQUENCE {			
ue-Identity SEQUENCE {			
c-RNTI	the value of the C-RNTI of the UE		
physCellId	PhysicalCellIdentity of Cell 1		
shortMAC-I	The same value as the 16 least significant bits of the XMAC-I value calculated by SS		
}			
reestablishmentCause	handoverFailure		
}			
}			

Table 8.6.7.2.3.3-11: RRCConnectionReestablishmentComplete (step 11, Table 8.6.7.2.3.2-2)

Derivation Path: 36.508, Table 4.6.1-11			
Information Element	Value/remark	Comment	Condition
RRCConnectionReestablishmentComplete ::= SEQUENCE {			
criticalExtensions CHOICE {			
rrcConnectionReestablishmentComplete-r8 =			
SEQUENCE {			
nonCriticalExtension SEQUENCE {			
rfl-InfoAvailable-r9	true		
nonCriticalExtension	Not present or any allowed value		
}			
}			
}			

Table 8.6.7.2.3.3-12: RRCConnectionReconfiguration (step 12, Table 8.6.7.2.3.2-2)

Derivation Path: 36.508, Table 4.6.1-8			
Information Element	Value/remark	Comment	Condition
RRCConnectionReconfiguration ::= SEQUENCE {			
criticalExtensions CHOICE {			
c1 CHOICE {			
rrcConnectionReconfiguration-r8 SEQUENCE {			
radioResourceConfigDedicated	RadioResourceConfigDedicated-HO		
}			
}			
}			

Table 8.6.7.2.3.3-13: UEInformationRequest (step 14, Table 8.6.7.2.3.2-2)

Derivation Path: 36.508, Table 4.6.1-23A			
Information Element	Value/remark	Comment	Condition
UEInformationRequest-r9 ::=SEQUENCE {			
criticalExtensions CHOICE {			
c1 CHOICE {			
ueInformationRequest-r9 SEQUENCE {			
rf-ReportReq-r9	TRUE		
}			
}			
}			
}			

Table 8.6.7.2.3.3-14: *UEInformationResponse* (step 15, Table 8.6.7.2.3.2-2)

Derivation Path: 36.508, Table 4.6.1-23B			
Information Element	Value/remark	Comment	Condition
UEInformationResponse-r9 ::=SEQUENCE {			
criticalExtensions CHOICE {			
c1 CHOICE {			
ueInformationResponse-r9 SEQUENCE {			
r1f-Report-r9 SEQUENCE {			
measResultLastServCell-r9 SEQUENCE {			
rsrpResult-r9	(0..97)		
rsrqResult-r9	Not present or (0..34)		
}			
measResultNeighCells-r9 SEQUENCE {			
measResultListEUTRA-r9 SEQUENCE (SIZE (1..maxFreq)) OF SEQUENCE {	1 entry		
carrierFreq-r9[1]	Same downlink EARFCN as used for Cell 2		
measResultList-r9[1] SEQUENCE (SIZE (1..maxCellReport)) OF SEQUENCE {	1 entry		
physCellId[1]	PhysicalCellIdentity of Cell 2		
cgi-Info[1]	Not present		
measResult[1] SEQUENCE {			
rsrpResult	(0..97)		
rsrqResult	(0..34)		
additionalSI-Info-r9	Not present		
}			
}			
}			
measResultListGERAN-r9 SEQUENCE (SIZE (1..maxFreq)) OF SEQUENCE {	1 entry		
carrierFreq-r9[1]	Same downlink ARFCN as used for Cell 24		
measResultList-r9 SEQUENCE (SIZE (1..maxCellReport)) OF SEQUENCE {	1 entry		
physCellId[1]	Physical cell Identity of Cell 24		
cgi-Info[1]	Not present		
measResult[1] SEQUENCE {			
rssi	(0..63)		
additionalSI-Info-r9	Not present		
}			
}			
measResultList UTRA-r9	Not present		
measResultsCDMA2000-r9	Not present		
}			
locationInfo-r10	Not present or any allowed value		
failedPCellId-r10 CHOICE {	cellGlobalId-r10 or pci-arfcn-r10	If the UE has the global cell identity depending on UE implementation, the UE sets the global cell identity, otherwise the UE sets the physical cell identity and the carrier frequency.	
cellGlobalId-r10 SEQUENCE {			
plmn-Identity	<i>plmn-Identity</i> within <i>SystemInformationBlockType1</i> broadcasted in Cell 2		

cellIdentity	<i>cellIdentity</i> within <i>SystemInformationBlockType1</i> broadcasted in Cell 2		
}			
pci-arfcn-r10 SEQUENCE {			
physCellId-r10	Physical cell Identity of Cell 2		
carrierFreq-r10	Same downlink EARFCN as used for Cell 2		
}			
}			
reestablishmentCellId-r10 SEQUENCE {			
plmn-Identity	<i>plmn-Identity</i> within <i>SystemInformationBlockType1</i> broadcasted in Cell 2		
cellIdentity	<i>cellIdentity</i> within <i>SystemInformationBlockType1</i> broadcasted in Cell 2		
}			
timeConnFailure-r10	Any allowed value		
connectionFailureType-r10	hof		
previousPCellId-r10 SEQUENCE {			
plmn-Identity	<i>plmn-Identity</i> within <i>SystemInformationBlockType1</i> broadcasted in Cell 1		
cellIdentity	<i>cellIdentity</i> within <i>SystemInformationBlockType1</i> broadcasted in Cell 1		
}			
}			
}			
}			
}			
}			
}			

8.6.7.3 Handover Failure logging / Reporting of CDMA2000 Inter-RAT measurements

8.6.7.3.1 Test Purpose (TP)

(1)

```

with { UE in RRC_CONNECTED having performed the CDMA2000 measurement and reported that the UE has
handover failure information available }
ensure that {
  when { UE receives the UEInformationRequest message containing rlf-ReportReq }
  then { UE sends the UEInformationResponse message containing the measurement result for CDMA
neighbour cell
}
}

```

8.6.7.3.2 Conformance requirements

References: The conformance requirements covered in the present TC are specified in: TS 36.331, clause 5.3.5.6, 5.3.7.4, 5.3.7.5 and 5.6.5.3.

[TS 36.331, clause 5.3.5.6(TP1)]

The UE shall:

- 1> if T304 expires (handover failure):

NOTE: Following T304 expiry any dedicated preamble, if provided within the *rach-ConfigDedicated*, is not available for use by the UE anymore.

- 2> revert back to the configuration used in the source PCell, excluding the configuration configured by the *physicalConfigDedicated*, the *mac-MainConfig* and the *sps-Config*;
- 2> store the following handover failure information in *VarRLF-Report* by setting its fields as follows:
 - 3> clear the information included in *VarRLF-Report*, if any;
 - 3> set the *plmn-Identity* to the RPLMN;
 - 3> set the *measResultLastServCell* to include the RSRP and RSRQ, if available, of the PCell based on measurements collected up to the moment the UE detected handover failure;
 - 3> set the *measResultNeighCells* to include the best measured cells, other than the PCell, ordered such that the best cell is listed first, and based on measurements collected up to the moment the UE detected handover failure, and set its fields as follows:
 - 4> if the UE was configured to perform measurements for one or more EUTRA frequencies, include the *measResultListEUTRA*;
 - 4> if the UE was configured to perform measurement reporting for one or more neighbouring UTRA frequencies, include the *measResultListUTRA*;
 - 4> if the UE was configured to perform measurement reporting for one or more neighbouring GERAN frequencies, include the *measResultListGERAN*;
 - 4> if the UE was configured to perform measurement reporting for one or more neighbouring CDMA2000 frequencies, include the *measResultsCDMA2000*;

NOTE 1: The measured quantities are filtered by the L3 filter as configured in the mobility measurement configuration. The measurements are based on the time domain measurement resource restriction, if configured. Blacklisted cells are not required to be reported.

- 3> if detailed location information is available, set the content of the *locationInfo* as follows:
 - 4> include the *locationCoordinates*;
 - 4> include the *horizontalVelocity*, if available;
- 3> set the *failedPCellId* to the global cell identity, if available, and otherwise to the physical cell identity and carrier frequency of the target PCell of the failed handover;
- 3> include *previousPCellId* and set it to the global cell identity of the PCell where the last *RRCConnectionReconfiguration* message including *mobilityControlInfo* was received;
- 3> set the *timeConnFailure* to the elapsed time since reception of the last *RRCConnectionReconfiguration* message including the *mobilityControlInfo*;
- 3> set the *connectionFailureType* to 'hof';
- 2> initiate the connection re-establishment procedure as specified in 5.3.7, upon which the RRC connection reconfiguration procedure ends;

The UE may discard the handover failure information, i.e. release the UE variable *VarRLF-Report*, 48 hours after the failure is detected, upon power off or upon detach.

NOTE 2: E-UTRAN may retrieve the handover failure information using the UE information procedure with *rlf-ReportReq* set to *true*, as specified in 5.6.5.3.

[TS 36.331, clause 5.3.7.4(TP1)]

If the procedure was initiated due to radio link failure or handover failure, the UE shall:

- 1> set the *reestablishmentCellId* in the *VarRLF-Report* to the global cell identity of the selected cell;

The UE shall set the contents of *RRCCConnectionReestablishmentRequest* message as follows:

...

1> set the *reestablishmentCause* as follows:

...

2> else if the re-establishment procedure was initiated due to handover failure as specified in 5.3.5.6 (intra-LTE handover failure) or 5.4.3.5 (inter-RAT mobility from EUTRA failure):

3> set the *reestablishmentCause* to the value *handoverFailure*;

...

[TS 36.331, clause 5.3.7.5(TP1)]

The UE shall:

...

1> set the content of *RRCCConnectionReestablishmentComplete* message as follows:

2> if the UE has radio link failure or handover failure information available in *VarRLF-Report* and *plmn-Identity* stored in *VarRLF-Report* is equal to the RPLMN:

3> include the *rlf-InfoAvailable*;

...

1> submit the *RRCCConnectionReestablishmentComplete* message to lower layers for transmission, upon which the procedure ends;

[TS 36.331, clause 5.6.5.3(TP1)]

Upon receiving the *UEInformationRequest* message, the UE shall:

...

1> if *rlf-ReportReq* is set to *true* and the UE has radio link failure information or handover failure information available in *VarRLF-Report* and *plmn-Identity* stored in *VarRLF-Report* is equal to the RPLMN, set the *rlf-Report* in the *UEInformationResponse* message to the value of *rlf-Report* in *VarRLF-Report*;

1> if the *rlf-Report* is included in *UEInformationResponse*:

2> discard the *rlf-Report* from *VarRLF-Report* upon successful delivery of the *UEInformationResponse* message confirmed by lower layers.

...

1> if the *logMeasReport* is included in the *UEInformationResponse*:

...

1> else:

2> submit the *UEInformationResponse* message to lower layers for transmission via SRB1;

8.6.7.3.3 Test description

8.6.7.3.3.1 Pre-test conditions

System Simulator:

- Cell 1, Cell 2 and Cell 15- Cell 1 and Cell 2 are E-UTRAN cell, Cell 15 is a HRPD cell.
- All cells belong to the same PLMN.

- System information combination 6 as defined in TS 36.508 [18] clause 4.4.3.1 is used in E-UTRA cells.

UE:

None.

Preamble:

- The UE is in state Generic RB Established (state 3) on Cell 1 according to [18].

8.6.7.3.3.2 Test procedure sequence

Table 8.6.7.3.3.2-1 illustrates the downlink power levels and other changing parameters to be applied for the cells at various time instants of the test execution. Row marked "T0" denotes the initial conditions after preamble, while columns marked "T1", "T2" and "T3" are to be applied subsequently. The exact instants on which these values shall be applied are described in the texts in this clause.

Table 8.6.7.3.3.2-1: Time instances of cell power level and parameter changes

	Parameter	Unit	Cell 1	Cell 2	Cell 15	Remark
T0	Cell-specific RS EPRE	dBm/15kHz	-60	-60	-	The power level values are such that entering conditions for event A3 and event B2 are not satisfied.
	┐or/loc	dB	-	-	-20	
	loc	dBm/1.23 MHz	-	-	-55	
	Pilot Ec/Io (NOTE 1)	dB	-	-	-20	
T1	Cell-specific RS EPRE	dBm/15kHz	-80	-80	-	The power level values are such that entering conditions for event B2 are satisfied.
	┐or/loc	dB	-	-	-5	
	loc	dBm/1.23 MHz	-	-	-55	
	Pilot Ec/Io (NOTE 1)	dB	-	-	-6	
T2	Cell-specific RS EPRE	dBm/15kHz	-80	-74	-	The power level values are such that entering conditions for event A3 are satisfied.
	┐or/loc	dB	-	-	"Off"	
	loc	dBm/1.23 MHz	-	-	"Off"	
	Pilot Ec/Io (NOTE 1)	dB	-	-	"Off"	
T3	Cell-specific RS EPRE	dBm/15kHz	"Off"	-74	-	Only Cell 2 is available. (NOTE 2)
	┐or/loc	dB	-	-	"Off"	
	loc	dBm/1.23 MHz	-	-	"Off"	
	Pilot Ec/Io (NOTE 1)	dB	-	-	"Off"	
NOTE 1: This parameter is not directly settable, but is derived by calculation from the other parameters set by the SS.						
NOTE 2: Power level "Off" for E-UTRA cell is defined in TS 36.508 Table 6.2.2.1-1.						

Table 8.6.7.3.3.2-2: Main behaviour

St	Procedure	Message Sequence		TP	Verdict
		U - S	Message		
1	The SS transmits an <i>RRConnectionReconfiguration</i> message to setup inter-RAT measurement on Cell 1.	<--	<i>RRConnectionReconfiguration</i>	-	-
2	The UE transmits an <i>RRConnectionReconfigurationComplete</i> message on Cell 1.	-->	<i>RRConnectionReconfigurationComplete</i>	-	-
3	The SS changes Cell 1, Cell 2 and Cell 15 parameters according to the row "T1" in Table 8.6.7.3.3.2-1.	-	-	-	-
4	The UE transmits a <i>MeasurementReport</i> message on Cell 1.	-->	<i>MeasurementReport</i>	-	-
5	The SS changes Cell 2 and Cell 15 parameters according to the row "T2" in Table 8.6.7.3.3.2-1.	-	-	-	-
6	The UE transmits a <i>MeasurementReport</i> message on Cell 1.	-->	<i>MeasurementReport</i>	-	-
7	The SS transmits an <i>RRConnectionReconfiguration</i> message including <i>mobilityControlInfo</i> on Cell 1.	<--	<i>RRConnectionReconfiguration</i>	-	-
-	EXCEPTION: In parallel to the events described in step 8 the steps specified in Table 8.6.7.3.3.2-3 should take place.	-	-	-	-
8	The SS changes Cell 1 parameter according to the row "T3" in Table 8.6.7.3.3.2-1.	-	-	-	-
9	The UE transmits an <i>RRConnectionReestablishmentRequest</i> message on Cell 2.	-->	<i>RRConnectionReestablishmentRequest</i>	-	-
10	The SS transmits an <i>RRConnectionReestablishment</i> message on Cell 2.	<--	<i>RRConnectionReestablishment</i>	-	-
11	The UE transmits an <i>RRConnectionReestablishmentComplete</i> message with handover failure information on Cell 2.	-->	<i>RRConnectionReestablishmentComplete</i>	-	-
12	The SS transmits an <i>RRConnectionReconfiguration</i> message on Cell 2.	<--	<i>RRConnectionReconfiguration</i>	-	-
13	The UE transmits an <i>RRConnectionReconfigurationComplete</i> message on Cell 2.	-->	<i>RRConnectionReconfigurationComplete</i>	-	-
14	The SS transmits a <i>UEInformationRequest</i> message on Cell 2.	<--	<i>UEInformationRequest</i>	-	-
15	Check: Does the UE transmit a <i>UEInformationResponse</i> message on Cell 2?	-->	<i>UEInformationResponse</i>	1	P
16	Check: Does the test result of generic test procedure in TS 36.508 subclause 6.4.2.3 indicate that the UE is in E-UTRA RRC_CONNECTED state on Cell 2?	-	-	1	-

Table 8.6.7.3.3.2-3: Parallel behaviour

St	Procedure	Message Sequence		TP	Verdict
		U - S	Message		
-	EXCEPTION: The steps 1 and 2 below are repeated for the duration of T304.	-	-	-	-
1	The UE attempts to perform handover using MAC Random Access Preamble on Cell 2.	-	-	-	-
2	The SS does not respond.	-	-	-	-

8.6.7.3.3.3 Specific message contents

Table 8.6.7.3.3.3-1: SystemInformationBlockType2 for Cell 2 (preamble and all steps, Table 8.6.7.3.3.2-2)

Derivation Path: 36.508, Table 4.4.3.3-1			
Information Element	Value/remark	Comment	Condition
SystemInformationBlockType2 ::= SEQUENCE {			
radioResourceConfigCommon SEQUENCE {			
rach-ConfigCommon SEQUENCE {			
ra-SupervisionInfo SEQUENCE {			
preambleTransMax	n50		
}			
uplinkPowerControlCommon-v1020	Not present		
}			
ssac-BarringForMMTEL-Voice-r9	Not present		
ssac-BarringForMMTEL-Video-r9	Not present		
ac-BarringForCSFB-r10	Not present		
}			

Table 8.6.7.3.3.3-2: RRCConnectionReconfiguration (step 1, Table 8.6.7.3.3.2-2)

Derivation Path: 36.508, Table 4.6.1-8, condition MEAS			
--	--	--	--

Table 8.6.7.3.3.3-3: MeasConfig (Table 8.6.7.3.3.2-2)

Derivation Path: 36.508, Table 4.6.6-1			
Information Element	Value/remark	Comment	Condition
MeasConfig ::= SEQUENCE {			
measObjectToAddModList SEQUENCE (SIZE (1..maxObjectId)) OF SEQUENCE {	2 entries		
measObjectId[1]	IdMeasObject-f1		
measObject[1]	MeasObjectEUTRA-GENERIC(f1)		
measObjectId[2]	IdMeasObject-f14		
measObject[2]	MeasObjectCDMA2000-f14		
}			
reportConfigToAddModList SEQUENCE (SIZE (1..maxReportConfigId)) OF SEQUENCE {	2 entries		
reportConfigId[1]	IdReportConfig-A3		
reportConfig[1]	ReportConfigEUTRA-A3		
reportConfigId[2]	IdReportConfig-B2-CDMA2000		
reportConfig[2]	ReportConfigInterRAT-B2-CDMA2000(-69, -18)		
}			
measIdToAddModList SEQUENCE (SIZE (1..maxMeasId)) OF SEQUENCE {	2 entries		
measId[1]	1		
measObjectId[1]	IdMeasObject-f1		
reportConfigId[1]	IdReportConfig-A3		
measId[2]	2		
measObjectId[2]	IdMeasObject-f14		
reportConfigId[2]	IdReportConfig-B2-CDMA2000		
}			
quantityConfig			
}			

Table 8.6.7.3.3.3-4: QuantityConfig (Table 8.6.7.3.3.3-3)

Derivation Path: 36.508, Table 4.6.6-3A, condition CDMA2000			
Information Element	Value/remark	Comment	Condition
QuantityConfig SEQUENCE {			
quantityConfigCDMA2000 SEQUENCE {			
measQuantityCDMA2000	pilotStrength		
}			
}			

Table 8.6.7.3.3.3-5: MeasObjectCDMA2000-f14 (Table 8.6.7.3.3.3-3)

Derivation Path: 36.508, Table 4.6.6-1C			
Information Element	Value/remark	Comment	Condition
MeasObjectCDMA2000 ::= SEQUENCE {			
cdma2000-Type	typeHRPD		
CarrierFreqCDMA2000 SEQUENCE {			
bandClass	Band Class of f14		
arfcn	f14		
}			
searchWindowSize	15		
offsetFreq	0dB		
cellsToAddModList CHOICE {			
cellsToAddModListCDMA2000 SEQUENCE (SIZE (1..maxCellMeas)) OF SEQUENCE {			
cellIndex[1]	1		
physCellId[1]	PhysicalCellIdentity of Cell 15		
}			
}			
cellForWhichToReportCGI	50		
}			

Table 8.6.7.3.3.3-6: *MeasurementReport* (step 4, Table 8.6.7.3.3.2-2)

Derivation Path: 36.508, Table 4.6.1-5			
Information Element	Value/remark	Comment	Condition
MeasurementReport ::= SEQUENCE {			
criticalExtensions CHOICE {			
c1 CHOICE{			
measurementReport-r8 SEQUENCE {			
measResults SEQUENCE {			
measId	2		
measResultPCell SEQUENCE {			
rsrpResult	(0..97)		
rsrqResult	(0..34)		
}			
measResultNeighCells CHOICE {			
measResultsCDMA2000 SEQUENCE (SIZE (1..maxCellReport)) OF SEQUENCE {	1 entry		
preRegistrationStatusHRPD			
measResultListCDMA2000 ::=SEQUENCE (SIZE (1..maxCellReport)) OF SEQUENCE {			
physCellId[1]	PhysicalCellId of Cell 15		
cgi-Info[1]	Not present		
measResult[1] SEQUENCE {			
pilotStrength	(0..63)		
}			
}			
}			
measResultForECID-r9	Not present		
locationInfo-r10	Not present		
measResultServFreqList-r10	Not present		
}			
}			
}			
}			
}			
}			
}			

Table 8.6.7.3.3.3-7: MeasurementReport (step 6, Table 8.6.7.3.3.2-2)

Derivation Path: 36.508, Table 4.6.1-5			
Information Element	Value/remark	Comment	Condition
MeasurementReport ::= SEQUENCE {			
criticalExtensions CHOICE {			
c1 CHOICE{			
measurementReport-r8 SEQUENCE {			
measResults SEQUENCE {			
measId	1		
measResultServCell SEQUENCE {			
rsrpResult	(0..97)		
rsrqResult	(0..34)		
}			
measResultNeighCells CHOICE {			
measResultListEUTRA SEQUENCE (SIZE (1..maxCellReport)) OF SEQUENCE {	1 entry		
physCellId[1]	PhysicalCellIdentity of Cell 2		
cgi-Info[1]	Not present		
measResult[1] SEQUENCE {			
rsrpResult	(0..97)		
rsrqResult	(0..34)		
additionalSI-Info-r9	Not present		
}			
}			
}			
measResultForECID-r9	Not present		
locationInfo-r10	Not present		
measResultServFreqList-r10	Not present		
}			
}			

Table 8.6.7.3.3.3-8: RRCConnectionReconfiguration (step 7, Table 8.6.7.3.3.2-2)

Derivation Path: 36.508, Table 4.6.1-8, condition HO

Table 8.6.7.3.3.3-9: MobilityControlInfo (Table 8.6.7.3.3.3-8)

Derivation Path: 36.508, Table 4.6.5-1			
Information Element	Value/remark	Comment	Condition
MobilityControlInfo ::= SEQUENCE {			
targetPhysCellId	PhysicalCellIdentity of Cell 2		
carrierFreq	Not present		
}			

Table 8.6.7.3.3.3-10: RRCConnectionReestablishmentRequest (step 9, Table 8.6.7.3.3.2-2)

Derivation Path: 36.508, Table 4.6.1-13			
Information Element	Value/remark	Comment	Condition
RRCConnectionReestablishmentRequest ::= SEQUENCE {			
criticalExtensions CHOICE {			
rrcConnectionReestablishmentRequest-r8			
SEQUENCE {			
ue-Identity SEQUENCE {			
c-RNTI	the value of the C-RNTI of the UE		
physCellId	PhysicalCellIdentity of Cell 1		
shortMAC-I	The same value as the 16 least significant bits of the XMAC-I value calculated by SS		
}			
reestablishmentCause	handoverFailure		
}			
}			
}			

Table 8.6.7.3.3.3-11: RRCConnectionReestablishmentComplete (step 11, Table 8.6.7.3.3.2-2)

Derivation Path: 36.508, Table 4.6.1-11			
Information Element	Value/remark	Comment	Condition
RRCConnectionReestablishmentComplete ::= SEQUENCE {			
criticalExtensions CHOICE {			
rrcConnectionReestablishmentComplete-r8 =			
SEQUENCE {			
nonCriticalExtension SEQUENCE {			
rfl-InfoAvailable-r9	true		
nonCriticalExtension	Not present or any allowed value		
}			
}			
}			
}			

Table 8.6.7.3.3.3-12: RRCConnectionReconfiguration (step 12, Table 8.6.7.3.3.2-2)

Derivation Path: 36.508, Table 4.6.1-8			
Information Element	Value/remark	Comment	Condition
RRCConnectionReconfiguration ::= SEQUENCE {			
criticalExtensions CHOICE {			
c1 CHOICE{			
rrcConnectionReconfiguration-r8 SEQUENCE {			
radioResourceConfigDedicated	RadioResourceConfigDedicated-HO		
}			
}			
}			
}			

Table 8.6.7.3.3.3-13: UEInformationRequest (step 14, Table 8.6.7.3.3.2-2)

Derivation Path: 36.508, Table 4.6.1-23A			
Information Element	Value/remark	Comment	Condition
UEInformationRequest-r9 ::=SEQUENCE {			
criticalExtensions CHOICE {			
c1 CHOICE {			
ueInformationRequest-r9 SEQUENCE {			
rf-ReportReq-r9	TRUE		
}			
}			
}			
}			

Table 8.6.7.3.3-14: *UEInformationResponse* (step 15, Table 8.6.7.3.3.2-2)

Derivation Path: 36.508, Table 4.6.1-23B			
Information Element	Value/remark	Comment	Condition
UEInformationResponse-r9 ::=SEQUENCE {			
criticalExtensions CHOICE {			
c1 CHOICE {			
ueInformationResponse-r9 SEQUENCE {			
r1f-Report-r9 SEQUENCE {			
measResultLastServCell-r9 SEQUENCE {			
rsrpResult-r9	(0..97)		
rsrqResult-r9	Not present or (0..34)		
}			
measResultNeighCells-r9 SEQUENCE {			
measResultListEUTRA-r9 SEQUENCE (SIZE (1..maxFreq)) OF SEQUENCE {	1 entry		
carrierFreq-r9[1]	Same downlink EARFCN as used for Cell 2		
measResultList-r9[1] SEQUENCE (SIZE (1..maxCellReport)) OF SEQUENCE {	1 entry		
physCellId[1]	PhysicalCellId of Cell 2		
cgi-Info[1]	Not present		
measResult[1] SEQUENCE {			
rsrpResult	(0..97)		
rsrqResult	(0..34)		
additionalSI-Info-r9	Not present		
}			
}			
measResultsCDMA2000-r9 SEQUENCE (SIZE (1..maxFreq)) OF SEQUENCE {	1 entry		
carrierFreq-r9[1]	Same downlink ARFCN as used for Cell 15		
measResultList-r9 SEQUENCE (SIZE (1..maxCellReport)) OF SEQUENCE {	1 entry		
preRegistrationStatusHRPD			
}			
measResultListCDMA2000 SEQUENCE (SIZE (1..maxCellReport)) OF SEQUENCE {			
physCellId[1]	PhysicalCellId of Cell 15		
cgi-Info[1]	Not present		
measResult[1] SEQUENCE {			
pilotStrength	(0..63)		
}			
}			
measResultListGERAN-r9	Not present		
measResultListUTRA-r9	Not present		
}			
locationInfo-r10	Not present or any allowed value		
failedPCCellId-r10 CHOICE {	cellGlobalId-r10 or pci-arfcn-r10	If the UE has the global cell identity depending on UE implementation, the UE sets the global cell identity, otherwise the UE sets the physical cell identity and the carrier frequency.	
cellGlobalId-r10 SEQUENCE {			
plmn-Identity	plmn-Identity within		

	<i>SystemInformationBlockType1</i> broadcasted in Cell 2		
cellIdentity	<i>cellIdentity</i> within <i>SystemInformationBlockType1</i> broadcasted in Cell 2		
}			
pci-arfcn-r10 SEQUENCE {			
physCellId-r10	Physical cell Identity of Cell 2		
carrierFreq-r10	Same downlink EARFCN as used for Cell 2		
}			
}			
reestablishmentCellId-r10 SEQUENCE {			
plmn-Identity	<i>plmn-Identity</i> within <i>SystemInformationBlockType1</i> broadcasted in Cell 2		
cellIdentity	<i>cellIdentity</i> within <i>SystemInformationBlockType1</i> broadcasted in Cell 2		
}			
timeConnFailure-r10	Any allowed value		
connectionFailureType-r10	hof		
previousPCellId-r10 SEQUENCE {			
plmn-Identity	<i>plmn-Identity</i> within <i>SystemInformationBlockType1</i> broadcasted in Cell 1		
cellIdentity	<i>cellIdentity</i> within <i>SystemInformationBlockType1</i> broadcasted in Cell 1		
}			
}			
}			
}			
}			
}			

8.6.7.4 Handover Failure logging / Reporting at UTRAN Inter-RAT handover / PLMN list

8.6.7.4.1 Test Purpose (TP)

(1)

```
with { UE selects the UTRAN cell and enters UTRA CELL_DCH(PS-DCCH+DTCH_DCH) after detection of radio link failure in an E-UTRAN cell }
ensure that {
  when { UE receives a HANDOVER FROM UTRAN COMMAND message including the eutra-Message and UE selects the EPLMN which is not the RPLMN }
  then { UE transmits an RRCCONNECTIONRECONFIGURATIONCOMPLETE message containing rlf-InfoAvailable and enters E-UTRA RRC_CONNECTED state }
}
```

(2)

```
with { UE in RRC_CONNECTED having reported that the UE has radio link failure information available }
ensure that {
  when { UE receives the UEINFORMATIONREQUEST message containing rlf-ReportReq }
  then { UE sends the UEINFORMATIONRESPONSE message containing the measurement result for UTRA neighbour cell }
}
```

}

8.6.7.4.2 Conformance requirements

References: The conformance requirements covered in the present TC are specified in: TS 36.331, clause 5.3.11.3, 5.4.2.3 and 5.6.5.3.

[TS 36.331, clause 5.3.11.3 (TP1, TP2)]

The UE shall:

- 1> upon T310 expiry; or
- 1> upon random access problem indication from MAC while neither T300, T301, T304 nor T311 is running; or
- 1> upon indication from RLC that the maximum number of retransmissions has been reached:
 - 2> consider radio link failure to be detected;
 - 2> store the following radio link failure information in the *VarRLF-Report* by setting its fields as follows:
 - 3> clear the information included in *VarRLF-Report*, if any;
 - 3> set the *plmn-IdentityList* to include the list of EPLMNs stored by the UE (i.e. includes the RPLMN);
 - 3> set the *measResultLastServCell* to include the RSRP and RSRQ, if available, of the PCell based on measurements collected up to the moment the UE detected radio link failure;
 - 3> set the *measResultNeighCells* to include the best measured cells, other than the PCell, ordered such that the best cell is listed first, and based on measurements collected up to the moment the UE detected radio link failure, and set its fields as follows:
 - 4> if the UE was configured to perform measurements for one or more EUTRA frequencies, include the *measResultListEUTRA*;
 - 4> if the UE was configured to perform measurement reporting for one or more neighbouring UTRA frequencies, include the *measResultListUTRA*;
 - 4> if the UE was configured to perform measurement reporting for one or more neighbouring GERAN frequencies, include the *measResultListGERAN*;
 - 4> if the UE was configured to perform measurement reporting for one or more neighbouring CDMA2000 frequencies, include the *measResultsCDMA2000*;
 - 4> for each neighbour cell included, include the optional fields that are available;

NOTE: The measured quantities are filtered by the L3 filter as configured in the mobility measurement configuration. The measurements are based on the time domain measurement resource restriction, if configured. Blacklisted cells are not required to be reported.

- 3> if detailed location information is available, set the content of the *locationInfo* as follows:
 - 4> include the *locationCoordinates*;
 - 4> include the *horizontalVelocity*, if available;
- 3> set the *failedPCellId* to the global cell identity, if available, and otherwise to the physical cell identity and carrier frequency of the PCell where radio link failure is detected;
- 3> if an *RRCCConnectionReconfiguration* message including the *mobilityControlInfo* was received before the connection failure:
 - 4> if the last *RRCCConnectionReconfiguration* message including the *mobilityControlInfo* concerned an intra E-UTRA handover:
 - 5> include the *previousPCellId* and set it to the global cell identity of the PCell where the last *RRCCConnectionReconfiguration* message including *mobilityControlInfo* was received;

- 5> set the *timeConnFailure* to the elapsed time since reception of the last *RRCCONNECTIONRECONFIGURATION* message including the *mobilityControlInfo*;
- 4> if the last *RRCCONNECTIONRECONFIGURATION* message including the *mobilityControlInfo* concerned a handover to E-UTRA from UTRA and if the UE supports Radio Link Failure Report for Inter-RAT MRO:
 - 5> include the *previousUTRA-CellId* and set it to the physical cell identity, the carrier frequency and the global cell identity, if available, of the UTRA Cell in which the last *RRCCONNECTIONRECONFIGURATION* message including *mobilityControlInfo* was received;
 - 5> set the *timeConnFailure* to the elapsed time since reception of the last *RRCCONNECTIONRECONFIGURATION* message including the *mobilityControlInfo*;
- 3> set the *connectionFailureType* to *rlf*;
- 3> set the *c-RNTI* to the C-RNTI used in the PCell;
- 3> set the *rlf-Cause* to the trigger for detecting radio link failure;
- 2> if AS security has not been activated:
 - 3> perform the actions upon leaving RRC_CONNECTED as specified in 5.3.12, with release cause 'other';
- 2> else:
 - 3> initiate the connection re-establishment procedure as specified in 5.3.7;

The UE may discard the radio link failure information, i.e. release the UE variable *VarRLF-Report*, 48 hours after the radio link failure is detected, upon power off or upon detach.

[TS 36.331, clause 5.4.2.3 (TP1)]

If the UE is able to comply with the configuration included in the *RRCCONNECTIONRECONFIGURATION* message, the UE shall:

...

- 1> set the content of *RRCCONNECTIONRECONFIGURATIONCOMPLETE* message as follows:
 - 2> if the UE has radio link failure or handover failure information available in *VarRLF-Report* and if the RPLMN is included in *plmn-IdentityList* stored in *VarRLF-Report*:
 - 3> include *rlf-InfoAvailable*;
 - 2> if the UE has logged measurements available for E-UTRA and if the RPLMN is included in *plmn-IdentityList* stored in *VarLogMeasReport*:
 - 3> include the *logMeasAvailable*;
 - 2> if the UE has connection establishment failure information available in *VarConnEstFailReport* and if the RPLMN is equal to *plmn-Identity* stored in *VarConnEstFailReport*:
 - 3> include *connEstFailInfoAvailable*;

[TS 36.331, clause 5.6.5.3 (TP2)]

Upon receiving the *UEINFORMATIONREQUEST* message, the UE shall:

...

- 1> if *rlf-ReportReq* is set to *true* and the UE has radio link failure information or handover failure information available in *VarRLF-Report* and if the RPLMN is included in *plmn-IdentityList* stored in *VarRLF-Report*:
 - 2> set *timeSinceFailure* in *VarRLF-Report* to the time that elapsed since the last radio link or handover failure in E-UTRA;
 - 2> set the *rlf-Report* in the *UEINFORMATIONRESPONSE* message to the value of *rlf-Report* in *VarRLF-Report*;

- 2> discard the *rlf-Report* from *VarRLF-Report* upon successful delivery of the *UEInformationResponse* message confirmed by lower layers;

...

- 1> if the *logMeasReportReq* is present and if the RPLMN is included in *plmn-IdentityList* stored in *VarLogMeasReport*:

...

- 1> else:

- 2> submit the *UEInformationResponse* message to lower layers for transmission via SRB1;

8.6.7.4.3 Test description

8.6.7.4.3.1 Pre-test conditions

System Simulator:

- Cell 1, Cell 5 and Cell 12
- System information combination 4 as defined in TS 36.508 [18] clause 4.4.3.1 is used in E-UTRA cell.

Table 8.6.7.4.3.1-1: PLMN identifiers

Cell	PLMN name
1	PLMN1
5	PLMN1
12	PLMN2

UE:

None.

Preamble:

- The UE is registered on PLMN1 (Cell 1) using the procedure described in TS 36.508[18] clause 4.5.2.3 except that the ATTACH ACCEPT message indicates PLMN2 in the Equivalent PLMN list as described in Table 8.6.7.4.3.3-1
- The UE is in state Generic RB Established (state 3) on Cell 1 according to [18].

8.6.7.4.3.2 Test procedure sequence

Table 8.6.7.4.3.2-1 illustrates the downlink power levels and other changing parameters to be applied for the cells at various time instants of the test execution. Configurations marked "T1", "T2" and "T3" are applied at the points indicated in the Main behaviour description in Table 8.6.7.4.3.2-2. The exact instants on which these values shall be applied are described in the texts in this clause.

Table 8.6.7.4.3.2-1: Time instances of cell power level and parameter changes

	Parameter	Unit	Cell 1	Cell 5	Cell12	Remark
T1	Cell-specific RS EPRE	dBm/15kHz	-80	-	"Off"	The power level values are such that entering conditions for event B2 are satisfied. (NOTE2)
	CPICH Ec (UTRA FDD)	dBm/3.84MHz	-	-70	"Off"	
	PCCPCH Ec (UTRA LCR TDD)	dBm/1.28 MHz	-	-70	"Off"	
T2	Cell-specific RS EPRE	dBm/15kHz	"Off"	-	"Off"	Only Cell 5 is available. (NOTE 1, NOTE 2)
	CPICH Ec (UTRA FDD)	dBm/3.84MHz	-	-70	"Off"	
	PCCPCH Ec (UTRA LCR TDD)	dBm/1.28 MHz	-	-70	"Off"	
T3	Cell-specific RS EPRE	dBm/15kHz	"Off"	-	-70	The power level values are such that entering conditions for event 3a are satisfied. (NOTE 1)
	CPICH Ec (UTRA FDD)	dBm/3.84MHz	-	-100	-	
	PCCPCH Ec (UTRA LCR TDD)	dBm/1.28 MHz	-	-100	-	
NOTE 1: Power level "Off" for E-UTRA cell is defined in TS 36.508 Table 6.2.2.1-1.						
NOTE 2: Power level "Off" for UTRA cell is defined in TS 34.108 Table 6.1.4 and Table 6.1.9.						

Table 8.6.7.4.3.2-2: Main behaviour

St	Procedure	Message Sequence		TP	Verdict
		U - S	Message		
1	The SS transmits an <i>RRConnectionReconfiguration</i> message to setup inter-RAT measurement on Cell 1.	<--	<i>RRConnectionReconfiguration</i>	-	-
2	The UE transmits an <i>RRConnectionReconfigurationComplete</i> message on Cell 1.	-->	<i>RRConnectionReconfigurationComplete</i>	-	-
3	The SS changes Cell 1 and Cell 5 parameters according to the row "T1" in Table 8.6.7.4.3.2-1.	-	-	-	-
4	The UE transmits a <i>MeasurementReport</i> message on Cell 1.	-->	<i>MeasurementReport</i>	-	-
5	The SS changes Cell 1 parameter according to the row "T2" in Table 8.6.7.4.3.2-1.	-	-	-	-
6	Generic test procedure in TS 36.508 subclause 6.4.2.8 is performed on Cell 5. NOTE: The UE performs an RAU procedure and the RRC connection is released.	-	-	-	-
7-11	Step 7 to 11 of test procedure in TS 34.123-1 subclause 12.9.14.4 is performed on Cell 5 using the UTRA reference radio bearer parameters and combination "UTRA PS RB" according to TS 36.508 subclause 4.8.3 and Table 4.8.3-1. NOTE: The UE performs NW initiated RAB re-establishment in a UTRAN cell.	-	-	-	-
-	For UTRAN FDD, EXCEPTION: Steps 12a1 to 12a2 describe behaviour that depends on the UE capability; the "lower case letter" identifies a step sequence that takes place if a capability is supported. For UTRAN TDD, goto Step 13.	-	-	-	-
12a1	IF <i>pc_UTRA_CompandedModeRequired</i> THEN the SS transmits a PHYSICAL CHANNEL RECONFIGURATION message on Cell 5 including the DPCH compressed mode info.	<--	PHYSICAL CHANNEL RECONFIGURATION	-	-
12a2	The UE transmits a PHYSICAL CHANNEL RECONFIGURATION COMPLETE message on Cell 5.	-->	PHYSICAL CHANNEL RECONFIGURATION COMPLETE	-	-
13	The SS transmits a MEASUREMENT CONTROL message to setup inter-RAT measurement on Cell 5.	<--	MEASUREMENT CONTROL	-	-
14	The SS changes Cell 5 and Cell 12 parameters according to the row "T3" in Table 8.6.7.4.3.2-1.	-	-	-	-
15	The UE transmits a MEASUREMENT REPORT message on Cell 5 including the E-UTRA event results.	-->	MEASUREMENT REPORT	-	-
16	The SS transmits a HANDOVER FROM UTRAN COMMAND message on Cell 5.	<--	HANDOVER FROM UTRAN COMMAND	-	-
17	Check: Does the UE transmit an <i>RRConnectionReconfigurationComplete</i> message with radio link failure information on Cell 12?	-->	<i>RRConnectionReconfigurationComplete</i>	1	P
18	Generic test procedure in TS 36.508 subclause 6.4.2.10 is performed on Cell 12. NOTE: The UE performs tracking area updating procedure without ISR and security reconfiguration after successful completion of handover from UTRA.	-	-	-	-
19	The SS transmits a <i>UEInformationRequest</i> message on Cell 12.	<--	<i>UEInformationRequest</i>	-	-
20	Check: Does the UE transmit a	-->	<i>UEInformationResponse</i>	2	P

	<i>UEInformationResponse</i> message on Cell 12?				
21	Check: Does the test result of generic test procedure in TS 36.508 subclause 6.4.2.3 indicate that the UE is in E-UTRA RRC_CONNECTED state on Cell 12?	-	-	2	-

8.6.7.4.3.3 Specific message contents

Table 8.6.7.4.3.3-1: ATTACH ACCEPT for Cell 1 (preamble)

Derivation path: 36.508 Table 4.7.2-1			
Information Element	Value/Remark	Comment	Condition
Equivalent PLMNs	PLMN2		

Table 8.6.7.4.3.3-2: RRCConnectionReconfiguration (step 1, Table 8.6.7.4.3.2-2)

Derivation Path: 36.508, Table 4.6.1-8, condition MEAS
--

Table 8.6.7.4.3.3-3: MeasConfig (Table 8.6.7.4.3.3-2)

Derivation Path: 36.508, Table 4.6.6-1, condition UTRAN			
Information Element	Value/remark	Comment	Condition
MeasConfig ::= SEQUENCE {			
measObjectToAddModList SEQUENCE (SIZE (1..maxObjectId)) OF SEQUENCE {	2 entries		
measObjectId[1]	IdMeasObject-f1		
measObject[1]	MeasObjectEUTRA-GENERIC(f1)		
measObjectId[2]	IdMeasObject-f8		
measObject[2]	MeasObjectUTRA-f8		
}			
reportConfigToAddModList SEQUENCE (SIZE (1..maxReportConfigId)) OF SEQUENCE {	1 entry		
reportConfigId[1]	IdReportConfig-B2-UTRA		
reportConfig[1]	ReportConfigInterRAT-B2-UTRA(-92, -82)		
}			
measIdToAddModList SEQUENCE (SIZE (1..maxMeasId)) OF SEQUENCE {	1 entry		
measId[1]	1		
measObjectId[1]	IdMeasObject-f8		
reportConfigId[1]	IdReportConfig-B2-UTRA		
}			
}			

Condition	Explanation
UTRA-FDD	UTRA FDD cell environment
UTRA-TDD	UTRA TDD cell environment

Table 8.6.7.4.3.3-4: QuantityConfig (Table 8.6.7.4.3.3-3)

Derivation Path: 36.508, Table 4.6.6-3A, condition UTRAN			
Information Element	Value/remark	Comment	Condition
QuantityConfig ::= SEQUENCE {			
quantityConfigUTRA SEQUENCE {			
measQuantityUTRA-FDD	cpich-RSCP		UTRA-FDD
measQuantityUTRA-TDD	pccpch-RSCP		UTRA-TDD
filterCoefficient	fc0		
}			
quantityConfigUTRA-v1020	Not present		
}			

Condition	Explanation
UTRA-FDD	UTRA FDD cell environment
UTRA-TDD	UTRA TDD cell environment

Table 8.6.7.4.3.3-5: MeasObjectUTRA-f8 (Table 8.6.7.4.3.3-3)

Derivation Path: 36.508, Table 4.6.6-3			
Information Element	Value/remark	Comment	Condition
MeasObjectUTRA ::= SEQUENCE {			
carrierFreq	Same downlink ARFCN as used for Cell 5		
cellsToAddModList CHOICE {			
cellsToAddModListUTRA-FDD SEQUENCE (SIZE (1..maxCellMeas)) OF SEQUENCE {			UTRA-FDD
cellIndex[1]	1		
physCellId[1]	PhysicalCellIdentity of Cell 5		
}			
cellsToAddModListUTRA-TDD SEQUENCE (SIZE (1..maxCellMeas)) OF SEQUENCE {			UTRA-TDD
cellIndex[1]	1		
physCellId[1]	PhysicalCellIdentity of Cell 5		
}			
}			
csg-allowedReportingCells-v930	Not present		
}			

Condition	Explanation
UTRA-FDD	UTRA FDD cell environment
UTRA-TDD	UTRA TDD cell environment

Table 8.6.7.4.3.3-9: *MobilityControlInfo* (Table 8.6.7.4.3.3-8)

Derivation Path: 36.508, Table 4.6.5-1			
Information Element	Value/remark	Comment	Condition
MobilityControlInfo ::= SEQUENCE {			
targetPhysCellId	PhysicalCellId of Cell 12.		
carrierFreq SEQUENCE {			
dl-CarrierFreq	Same downlink EARFCN as used for Cell 12.		
ul-CarrierFreq	Not present		
}			
carrierBandwidth SEQUENCE {			
dl-Bandwidth	Same downlink system bandwidth as used for Cell 12		
ul-Bandwidth	Same uplink system bandwidth as used for Cell 12		FDD
ul-Bandwidth	Not present		TDD
}			
additionalSpectrumEmission	1		
}			

Condition	Explanation
FDD	FDD cell environment
TDD	TDD cell environment

Table 8.6.7.4.3.3-10: SecurityConfigHO (Table 8.6.7.4.3.3-8)

Derivation Path: 36.508, Table 4.6.4-1			
Information Element	Value/remark	Comment	Condition
SecurityConfigHO ::= SEQUENCE {			
handoverType CHOICE {			
interRAT SEQUENCE {			
securityAlgorithmConfig SEQUENCE {			
cipheringAlgorithm	Set according to PIXIT parameter for default ciphering protection algorithm		
integrityProtAlgorithm	Set according to PIXIT parameter for default integrity algorithm		
}			
nas-SecurityParamToEUTRA	<p>Octets 1 to 4 are arbitrarily selected.</p> <p>Bits 1 to 3 of octet 5 are set according to PIXIT parameter for default integrity protection algorithm.</p> <p>Bits 5 to 7 of octet 5 are set according to PIXIT parameter for default ciphering algorithm.</p> <p>Bits 1 to 3 of octet 6 are arbitrarily selected between '000'B and '110'B, different from the valid NAS key set identifier of the UE if such a value exists.</p> <p>Bit 4 of octet 6 is set to 1.</p>	<p>Octets 1 to 4 include the NonceMME value.</p> <p>Bits 1 to 3 of octet 5 include the Type of integrity protection algorithm</p> <p>Bits 5 to 7 of octet 5 include the Type of ciphering algorithm.</p> <p>Bits 1 to 4 of octet 6 include the NAS key set identifier.</p>	
}			
}			
}			
}			

Table 8.6.7.4.3.3-11: RRCConnectionReconfigurationComplete (step 17, Table 8.6.7.4.3.2-2)

Derivation Path: 36.508, Table 4.6.1-9			
Information Element	Value/remark	Comment	Condition
RRCConnectionReconfigurationComplete ::= SEQUENCE {			
criticalExtensions CHOICE {			
nonCriticalExtension SEQUENCE {			
lateNonCriticalExtension	Not present or any allowed value		
nonCriticalExtension SEQUENCE {			
rf-InfoAvailable-r10	true		
logMeasAvailable-r10	Not present		
nonCriticalExtension	Not present or any allowed value		
}			
}			
}			
}			

Table 8.6.7.4.3.3-12: *UEInformationRequest* (step 19, Table 8.6.7.4.3.2-2)

Derivation Path: 36.508, Table 4.6.1-23A, condition RLF report
--

Table 8.6.7.4.3.3-13: *UEInformationResponse* (step 20, Table 8.6.7.4.3.2-2)

Derivation Path: 36.508, Table 4.6.1-23B			
Information Element	Value/remark	Comment	Condition
UEInformationResponse-r9 ::=SEQUENCE {			
criticalExtensions CHOICE {			
c1 CHOICE {			
ueInformationResponse-r9 SEQUENCE {			
r1f-Report-r9 SEQUENCE {			
measResultLastServCell-r9 SEQUENCE {			
rsrpResult-r9	(0..97)		
rsrqResult-r9	Not present or (0..34)		
}			
measResultNeighCells-r9 SEQUENCE {			
measResultListEUTRA-r9	Not present		
measResultListUTRA-r9 SEQUENCE (SIZE (1..maxFreq)) OF SEQUENCE {	1 entry		
carrierFreq-r9	Same downlink ARFCN as used for Cell 5		
measResultList-r9 SEQUENCE (SIZE (1..maxCellReport)) OF SEQUENCE {	1 entry		
physCellId CHOICE {			
fdd	PhysicalCellIdentity of Cell 5		UTRA-FDD
tdd	PhysicalCellIdentity of Cell 5		UTRA-TDD
}			
cgi-Info	Not present		
measResult SEQUENCE {			
utra-RSCP	Not present or (-5..91)		
utra-EcN0	Not present		
additionalSI-Info-r9	Not present		
}			
}			
measResultListGERAN-r9	Not present		
measResultsCDMA2000-r9	Not present		
}			
locationInfo-r10	Not present or any allowed value		
failedPCellId-r10 CHOICE {	cellGlobalId-r10 or pci-arfcn-r10	If the UE has the global cell identity depending on UE implementation, the UE sets the global cell identity; otherwise the UE sets the physical cell identity and the carrier frequency.	
cellGlobalId-r10 SEQUENCE {			
plmn-Identity	<i>plmn-Identity</i> within <i>SystemInformationBlockType1</i> broadcasted in Cell 1		
cellIdentity	<i>cellIdentity</i> within <i>SystemInformationBlockType1</i> broadcasted in Cell 1		
}			
pci-arfcn-r10 SEQUENCE {			
physCellId-r10	Physical cell Identity of Cell 1		
carrierFreq-r10	Same downlink EARFCN as used for Cell 1		
}			

}			
reestablishmentCellId-r10	Not present		
timeConnFailure-r10	Not present		
connectionFailureType-r10	r1f		
previousPCellId-r10	Not present		
basicFields-r11SEQUENCE {			
c-RNTI-r11	Any allowed value		
r1f-Cause-r11	t310-Expiry		
timeSinceFailure-r11	Any allowed value		
}			
previousUTRA-CellId-r11	Not present		
selectedUTRA-CellId-r11	Not present		
}			
}			
}			
}			
}			
}			
}			

Condition	Explanation
UTRA-FDD	UTRA FDD cell environment
UTRA-TDD	UTRA TDD cell environment

8.6.8 Connection Establishment Failure

8.6.8.1 Connection Establishment Failure logging / Logging and reporting / T300 expiry

8.6.8.1.1 Test Purpose (TP)

(1)

```
with { UE having sent an RRCConnectionRequest message }
ensure that {
  when { T300 is expired }
  then { UE stores the connection establishment failure information }
}
```

(2)

```
with { UE having sent an RRCConnectionSetupComplete message with connEstFailInfoAvailable }
ensure that {
  when { UE receives a UEInformationRequest message with connEstFailReportReq set to true }
  then { UE sends a UEInformationResponse message with connEstFailReport }
}
```

8.6.8.1.2 Conformance requirements

References: The conformance requirements covered in the present TC are specified in: TS 36.331, clause 5.3.3.4 and 5.3.3.6.

[TS 36.331, clause 5.3.3.4]

The UE shall:

...

1> set the content of *RRCConnectionSetupComplete* message as follows:

...

2> if the UE has connection establishment failure information available in *VarConnEstFailReport* and if the RPLMN is equal to *plmn-Identity* stored in *VarConnEstFailReport*:

3> include *connEstFailInfoAvailable*;

[TS 36.331, clause 5.3.3.6]

The UE shall:

- 1> if timer T300 expires:
 - 2> reset MAC, release the MAC configuration and re-establish RLC for all RBs that are established;
 - 2> store the following connection establishment failure information in the *VarConnEstFailReport* by setting its fields as follows:
 - 3> clear the information included in *VarConnEstFailReport*, if any;
 - 3> set the *plmn-Identity* to the PLMN selected by upper layers (see TS 23.122 [11], TS 24.301 [35]) from the PLMN(s) included in the *plmn-IdentityList* in *SystemInformationBlockType1*;
 - 3> set the *failedCellId* to the global cell identity of the cell where connection establishment failure is detected;
 - 3> set the *measResultFailedCell* to include the RSRP and RSRQ, if available, of the cell where connection establishment failure is detected and based on measurements collected up to the moment the UE detected the failure;
 - 3> if available, set the *measResultNeighCells*, in order of decreasing ranking-criterion as used for cell reselection, to include neighbouring cell measurements for at most the following number of neighbouring cells: 6 intra-frequency and 3 inter-frequency neighbours per frequency as well as 3 inter-RAT neighbours, per frequency/ set of frequencies (GERAN) per RAT and according to the following:
 - 4> for each neighbour cell included, include the optional fields that are available;

NOTE: The UE includes the latest results of the available measurements as used for cell reselection evaluation, which are performed in accordance with the performance requirements as specified in TS 36.133 [16].

- 3> if detailed location information is available, set the content of the *locationInfo* as follows:
 - 4> include the *locationCoordinates*;
 - 4> include the *horizontalVelocity*, if available;
 - 3> set the *numberOfPreamblesSent* to indicate the number of preambles sent by MAC for the failed random access procedure;
 - 3> set *contentionDetected* to indicate whether contention resolution was not successful as specified in TS 36.321 [6] for at least one of the transmitted preambles for the failed random access procedure;
 - 3> set *maxTxPowerReached* to indicate whether or not the maximum power level was used for the last transmitted preamble, see TS 36.321 [6];
- 2> inform upper layers about the failure to establish the RRC connection, upon which the procedure ends;

The UE may discard the connection establishment failure information, i.e. release the UE variable *VarConnEstFailReport*, 48 hours after the failure is detected, upon power off or upon detach.

8.6.8.1.3 Test description

8.6.8.1.3.1 Pre-test conditions

System Simulator:

- Cell 1

UE:

None.

Preamble:

- The UE is in state Registered, Idle Mode (state 2) on Cell 1 according to [18].

8.6.8.1.3.2 Test procedure sequence

Table 8.6.8.1.3.2-1: Main behaviour

St	Procedure	Message Sequence		TP	Verdict
		U - S	Message		
1	The SS transmits a <i>Paging</i> message.	<--	<i>Paging</i>	-	-
2	The UE transmits an <i>RRCConnectionRequest</i> message.	-->	<i>RRCConnectionRequest</i>	-	-
3	The SS waits for 2s. Note: the UE may transmit one or more <i>RRCConnectionRequest</i> messages but the SS does not answer to these messages.	-	-	-	-
4	The SS transmits a <i>Paging</i> message.	<--	<i>Paging</i>	-	-
5	The UE transmits an <i>RRCConnectionRequest</i> message.	-->	<i>RRCConnectionRequest</i>	-	-
6	The SS transmits an <i>RRCConnectionSetup</i> message.	<--	<i>RRCConnectionSetup</i>	-	-
7	Check: Does the UE transmit an <i>RRCConnectionSetupComplete</i> message including <i>connEstFailInfoAvailable</i> IE set it to <i>true</i> ?	-->	<i>RRCConnectionSetupComplete</i>	1	P
8-11	Steps 6 to 9 of the generic radio bearer establishment procedure in TS 36.508 subclause 4.5.3.3 are executed to successfully complete the service request procedure.	-	-	-	-
12	The SS sends a <i>UEInformationRequest</i> message to get <i>connEstFailReportReq</i> .	<--	<i>UEInformationRequest</i>	-	-
13	Check: Does the UE send a <i>UEInformationResponse</i> message with <i>connEstFailReport</i> ?	-->	<i>UEInformationResponse</i>	2	P

8.6.8.1.3.3 Specific message contents

Table 8.6.8.1.3.3-1: *RRCConnectionSetupComplete* (step 7, Table 8.6.8.1.3.2-1)

Derivation Path: TS 36.508 Table 4.6.1-18			
Information Element	Value/remark	Comment	Condition
<i>RRCConnectionSetupComplete</i> ::= SEQUENCE {			
criticalExtensions CHOICE {			
c1 CHOICE{			
<i>rrcConnectionSetupComplete-r8</i> SEQUENCE {			
nonCriticalExtension SEQUENCE {			
nonCriticalExtension SEQUENCE {			
nonCriticalExtension SEQUENCE {			
<i>connEstFailInfoAvailable-r11</i>	true		
nonCriticalExtension SEQUENCE {}	Not present		
}			
}			
}			
}			
}			
}			

Table 8.6.8.1.3.3-2: *UEInformationRequest* (step 12, Table 8.6.8.1.3.2-1)

Derivation Path: 36.508, Table 4.6.1-23A, condition ConEstFail
--

Table 8.6.8.1.3.3-3: UEInformationResponse (step 13, Table 8.6.8.1.3.2-1)

Derivation Path: 36.508, Table 4.6.1-23B			
Information Element	Value/remark	Comment	Condition
UEInformationResponse-r9 ::=SEQUENCE {			
criticalExtensions CHOICE {			
c1 CHOICE {			
ueInformationResponse-r9 SEQUENCE {			
nonCriticalExtension SEQUENCE {			
nonCriticalExtension SEQUENCE {			
nonCriticalExtension SEQUENCE {			
connEstFailReport-r11 SEQUENCE {			
failedCellId-r11 SEQUENCE {			
plmn-Identity	plmn-Identity within SystemInformationBlockType1 broadcasted in Cell 1		
cellIdentity	cellIdentity within SystemInformationBlockType1 broadcasted in Cell 1		
}			
locationInfo-r11	Not present or any allowed value		
measResultFailedCell-r11 SEQUENCE {			
rsrpResult-r11	(0..97)		
rsrqResult-r11	Not present or (0..34)		
}			
measResultNeighCells-r11	Not present		
numberOfPreamblesSent-r11	Any allowed value		
contentionDetected-r11	Any allowed value		
maxTxPowerReached-r11	Any allowed value		
timeSinceFailure-r11	Any allowed value		
measResultListEUTRA-v1130	Not present		
}			
}			
}			
}			
}			

8.6.8.2 Connection Establishment Failure logging / Logging and reporting / Reporting at intra-LTE handover

8.6.8.2.1 Test Purpose (TP)

(1)

```
with { UE has connection establishment failure information available }
ensure that {
  when { UE performs an Handover procedure }
  then { UE sends an RRCConnectionReconfigurationComplete message with connEstFailInfoAvailable }
}
```

8.6.8.2.2 Conformance requirements

References: The conformance requirements covered in the present TC are specified in: TS 36.331, clause 5.3.3.6 and 5.3.5.4.

[TS 36.331, clause 5.3.3.6]

The UE shall:

- 1> if timer T300 expires:
 - 2> reset MAC, release the MAC configuration and re-establish RLC for all RBs that are established;
 - 2> store the following connection establishment failure information in the *VarConnEstFailReport* by setting its fields as follows:
 - 3> clear the information included in *VarConnEstFailReport*, if any;
 - 3> set the *plmn-Identity* to the PLMN selected by upper layers (see TS 23.122 [11], TS 24.301 [35]) from the PLMN(s) included in the *plmn-IdentityList* in *SystemInformationBlockType1*;
 - 3> set the *failedCellId* to the global cell identity of the cell where connection establishment failure is detected;
 - 3> set the *measResultFailedCell* to include the RSRP and RSRQ, if available, of the cell where connection establishment failure is detected and based on measurements collected up to the moment the UE detected the failure;
 - 3> if available, set the *measResultNeighCells*, in order of decreasing ranking-criterion as used for cell reselection, to include neighbouring cell measurements for at most the following number of neighbouring cells: 6 intra-frequency and 3 inter-frequency neighbours per frequency as well as 3 inter-RAT neighbours, per frequency/ set of frequencies (GERAN) per RAT and according to the following:
 - 4> for each neighbour cell included, include the optional fields that are available;

NOTE: The UE includes the latest results of the available measurements as used for cell reselection evaluation, which are performed in accordance with the performance requirements as specified in TS 36.133 [16].

- 3> if detailed location information is available, set the content of the *locationInfo* as follows:
 - 4> include the *locationCoordinates*;
 - 4> include the *horizontalVelocity*, if available;
- 3> set the *numberOfPreamblesSent* to indicate the number of preambles sent by MAC for the failed random access procedure;
- 3> set *contentionDetected* to indicate whether contention resolution was not successful as specified in TS 36.321 [6] for at least one of the transmitted preambles for the failed random access procedure;
- 3> set *maxTxPowerReached* to indicate whether or not the maximum power level was used for the last transmitted preamble, see TS 36.321 [6];
- 2> inform upper layers about the failure to establish the RRC connection, upon which the procedure ends;

The UE may discard the connection establishment failure information, i.e. release the UE variable *VarConnEstFailReport*, 48 hours after the failure is detected, upon power off or upon detach.

[TS 36.331, clause 5.3.5.4]

If the *RRCCConnectionReconfiguration* message includes the *mobilityControlInfo* and the UE is able to comply with the configuration included in this message, the UE shall:

...

- 1> set the content of *RRCCConnectionReconfigurationComplete* message as follows:
 - 2> if the UE has radio link failure or handover failure information available in *VarRLF-Report* and if the RPLMN is included in *plmn-IdentityList* stored in *VarRLF-Report*:
 - 3> include *rlf-InfoAvailable*;
 - 2> if the UE has logged measurements available for E-UTRA and if the RPLMN is included in *plmn-IdentityList* stored in *VarLogMeasReport*:
 - 3> include the *logMeasAvailable*;

2> if the UE has connection establishment failure information available in *VarConnEstFailReport* and if the RPLMN is equal to *plmn-Identity* stored in *VarConnEstFailReport*:

3> include *connEstFailInfoAvailable*;

8.6.8.2.3 Test description

8.6.8.2.3.1 Pre-test conditions

System Simulator:

- Cell 1 and Cell 3
- System information combination 3 as defined in TS 36.508 [18] clause 4.4.3.1 is used in E-UTRA cells.

UE:

None.

Preamble:

- The UE is in state Registered, Idle Mode (state 2) on Cell 1 according to [18].

8.6.8.2.3.2 Test procedure sequence

Table 8.6.8.2.3.2-1 illustrates the downlink power levels and other changing parameters to be applied for the cells at various time instants of the test execution. Row marked "T0" denotes the initial conditions after preamble, while columns marked "T1" is to be applied subsequently. The exact instants on which these values shall be applied are described in the texts in this clause.

Table 8.6.8.2.3.2-1: Time instances of cell power level and parameter changes

	Parameter	Unit	Cell 1	Cell 3	Remark
T0	Cell-specific RS EPRE	dBm/15 kHz	-85	-97	
T1	Cell-specific RS EPRE	dBm/15 kHz	-85	-73	

Table 8.6.8.2.3.2-2: Main behaviour

St	Procedure	Message Sequence		TP	Verdict
		U - S	Message		
1	The SS transmits a <i>Paging</i> message.	<--	<i>Paging</i>	-	-
2	The UE transmits an <i>RRCCONNECTIONREQUEST</i> message.	-->	<i>RRCCONNECTIONREQUEST</i>	-	-
3	The SS waits for 2s. Note: the UE may transmit one or more <i>RRCCONNECTIONREQUEST</i> messages but the SS does not answer to these messages.	-		-	-
4	SS sends a <i>Paging</i> message to the UE on the appropriate paging block, and including the UE identity in one entry of the IE <i>pagingRecordLists</i> .	<--	RRC: <i>Paging</i> (PCCH)	-	-
5	UE transmits an <i>RRCCONNECTIONREQUEST</i> message.	-->	RRC: <i>RRCCONNECTIONREQUEST</i>	-	-
6	SS transmit an <i>RRCCONNECTIONSETUP</i> message.	<--	RRC: <i>RRCCONNECTIONSETUP</i>	-	-
7	The UE transmits an <i>RRCCONNECTIONSETUPCOMPLETE</i> message to confirm the successful completion of the connection establishment and to initiate the session management procedure by including the SERVICE REQUEST message. (State3)	-->	RRC: <i>RRCCONNECTIONSETUPCOMPLETE</i> NAS: SERVICE REQUEST	-	-
8-11	Steps 6 to 9 the generic radio bearer establishment procedure in TS 36.508 subclause 4.5.3.3 are executed to successfully complete the service request procedure.	-		-	-
12	The SS transmits a <i>RRCCONNECTIONRECONFIGURATION</i> message	<--	<i>RRCCONNECTIONRECONFIGURATION</i>	-	-
13	The UE transmits a <i>RRCCONNECTIONRECONFIGURATIONCOMPLETE</i> message	-->	<i>RRCCONNECTIONRECONFIGURATIONCOMPLETE</i>	-	-
14	The SS changes cell 1 and cell 3 parameters according to the row "T1" in table 8.6.8.2.3.2-1	-		-	-
15	The UE transmits a <i>MEASUREMENTREPORT</i> message.	-->	<i>MEASUREMENTREPORT</i>	-	-
16	The SS transmits an <i>RRCCONNECTIONRECONFIGURATION</i> message to order the UE to perform handover to Cell 3.	<--	<i>RRCCONNECTIONRECONFIGURATION</i>	-	-
17	The UE transmit an <i>RRCCONNECTIONRECONFIGURATIONCOMPLETE</i> message containing <i>connEstFailInfoAvailable</i> to Cell 3.	-->	<i>RRCCONNECTIONRECONFIGURATIONCOMPLETE</i>	1	P

8.6.8.2.3.3 Specific message contents

Table 8.6.8.2.3.3-1: RRCConnectionSetupComplete (step 7, Table 8.6.8.2.3.2-1)

Derivation Path: TS 36.508 Table 4.6.1-18			
Information Element	Value/remark	Comment	Condition
RRCConnectionSetupComplete ::= SEQUENCE {			
criticalExtensions CHOICE {			
c1 CHOICE{			
rrcConnectionSetupComplete-r8 SEQUENCE {			
nonCriticalExtension SEQUENCE {			
nonCriticalExtension SEQUENCE {			
nonCriticalExtension SEQUENCE {			
connEstFailInfoAvailable-r11	true		
nonCriticalExtension SEQUENCE {}	Not present		
}			
}			
}			
}			
}			
}			
}			

Table 8.6.8.2.3.3-2 : RRCConnectionReconfiguration (step 12, Table 8.6.8.2.3.2-2)

Derivation Path: 36.508 clause 4.6.1-8 Condition MEAS

Table 8.6.8.2.3.3-3: MeasConfig (Table 8.6.8.2.3.3-1)

Derivation Path: 36.508, Table 4.6.6-1, condition INTER-FREQ			
Information Element	Value/remark	Comment	Condition
MeasConfig ::= SEQUENCE {			
measObjectToAddModList SEQUENCE (SIZE (1..maxObjectId)) OF SEQUENCE {	2 entries		
measObjectId[1]	IdMeasObject-f1		
measObject[1]	MeasObjectEUTRA-GENERIC(f1)		
measObjectId[2]	IdMeasObject-f2		
measObject[2]	MeasObjectEUTRA-GENERIC(f2)		
}			
reportConfigToAddModList SEQUENCE (SIZE (1..maxReportConfigId)) OF SEQUENCE {	1 entry		
reportConfigId[1]	IdReportConfig-A3		
reportConfig[1]	ReportConfigEUTRA-A3		
}			
measIdToAddModListSEQUENCE (SIZE (1..maxMeasId)) OF SEQUENCE {			
measId[1]	1		
measObjectId[1]	IdMeasObject-f2		
reportConfigId[1]	IdReportConfig-A3		
}			
}			

Table 8.6.8.2.3.3-4: MeasurementReport (step 15, Table 8.6.8.2.3.2-2)

Derivation Path: 36.508, Table 4.6.1-5			
Information Element	Value/remark	Comment	Condition
MeasurementReport ::= SEQUENCE {			
criticalExtensions CHOICE {			
c1 CHOICE{			
measurementReport-r8 SEQUENCE {			
measResults SEQUENCE {			
measId	1		
measResultServCell SEQUENCE {			
rsrpResult	(0..97)		
rsrqResult	(0..34)		
}			
measResultNeighCells CHOICE {			
measResultListEUTRA SEQUENCE (SIZE (1..maxCellReport)) OF SEQUENCE {	1 entry		
physCellId	PhysicalCellIdentity of Cell 3		
cgi-Info	Not present		
measResult SEQUENCE {			
rsrpResult	(0..97)		
rsrqResult	(0..34)		
additionalSI-Info-r9	Not present		
}			
}			
}			
measResultForECID-r9	Not present		
}			
}			
}			

Table 8.6.8.2.3.3-5: RRCConnectionReconfiguration (step 16, Table 8.6.8.2.3.2-2)

Derivation Path: 36.508 Table 4.6.1-8 Condition HO
--

Table 8.6.8.2.3.3-6: MobilityControlInfo (Table 8.6.8.2.3.3-4)

Derivation Path: 36.508, Table 4.6.5-1			
Information Element	Value/remark	Comment	Condition
MobilityControlInfo ::= SEQUENCE {			
targetPhysCellId	PhysicalCellIdentity of Cell 3		
carrierFreq SEQUENCE {			
dl-CarrierFreq	Same downlink EARFCN as used for Cell 3		
ul-CarrierFreq	Not present		
}			
}			

Table 8.6.8.2.3.3-7: RRCConnectionReconfigurationComplete (step 17, Table 8.6.8.2.3.2-2)

Derivation Path: 36.331 clause 6.2.2			
Information Element	Value/remark	Comment	Condition
RRCConnectionReconfigurationComplete ::= SEQUENCE {			
rrc-TransactionIdentifier	RRC-TransactionIdentifier-UL		
criticalExtensions CHOICE {			
rrcConnectionReconfigurationComplete-v1130-IEs SEQUENCE {			
nonCriticalExtension SEQUENCE {			
connEstFailInfoAvailable-r11	true		
}			
}			
}			
}			

8.6.8.3 Connection Establishment Failure logging / Logging and reporting / Reporting at RRC connection re-establishment

8.6.8.3.1 Test Purpose (TP)

(1)

```
with { UE has connection establishment failure information available }
ensure that {
  when { UE performs an RRC Connection re-establishment procedure }
  then { UE sends an RRCConnectionReestablishmentComplete message with connEstFailInfoAvailable }
}
```

8.6.8.3.2 Conformance requirements

References: The conformance requirements covered in the present TC are specified in: TS 36.331, clause 5.3.3.6 and .5.3.7.5.

[TS 36.331, clause 5.3.3.6]

The UE shall:

- 1> if timer T300 expires:
 - 2> reset MAC, release the MAC configuration and re-establish RLC for all RBs that are established;
 - 2> store the following connection establishment failure information in the *VarConnEstFailReport* by setting its fields as follows:
 - 3> clear the information included in *VarConnEstFailReport*, if any;
 - 3> set the *plmn-Identity* to the PLMN selected by upper layers (see TS 23.122 [11], TS 24.301 [35]) from the PLMN(s) included in the *plmn-IdentityList* in *SystemInformationBlockType1*;
 - 3> set the *failedCellId* to the global cell identity of the cell where connection establishment failure is detected;
 - 3> set the *measResultFailedCell* to include the RSRP and RSRQ, if available, of the cell where connection establishment failure is detected and based on measurements collected up to the moment the UE detected the failure;
 - 3> if available, set the *measResultNeighCells*, in order of decreasing ranking-criterion as used for cell re-selection, to include neighbouring cell measurements for at most the following number of neighbouring cells: 6 intra-frequency and 3 inter-frequency neighbours per frequency as well as 3 inter-RAT neighbours, per frequency/ set of frequencies (GERAN) per RAT and according to the following:
 - 4> for each neighbour cell included, include the optional fields that are available;

NOTE: The UE includes the latest results of the available measurements as used for cell reselection evaluation, which are performed in accordance with the performance requirements as specified in TS 36.133 [16].

3> if detailed location information is available, set the content of the *locationInfo* as follows:

4> include the *locationCoordinates*;

4> include the *horizontalVelocity*, if available;

3> set the *numberOfPreamblesSent* to indicate the number of preambles sent by MAC for the failed random access procedure;

3> set *contentionDetected* to indicate whether contention resolution was not successful as specified in TS 36.321 [6] for at least one of the transmitted preambles for the failed random access procedure;

3> set *maxTxPowerReached* to indicate whether or not the maximum power level was used for the last transmitted preamble, see TS 36.321 [6];

2> inform upper layers about the failure to establish the RRC connection, upon which the procedure ends;

The UE may discard the connection establishment failure information, i.e. release the UE variable *VarConnEstFailReport*, 48 hours after the failure is detected, upon power off or upon detach.

[TS 36.331, clause 5.3.7.5]

NOTE 1: Prior to this, lower layer signalling is used to allocate a C-RNTI. For further details see TS 36.321 [6];

The UE shall:

...

1> set the content of *RRCConnectionReestablishmentComplete* message as follows:

2> if the UE has radio link failure or handover failure information available in *VarRLF-Report* and if the RPLMN is included in *plmn-IdentityList* stored in *VarRLF-Report*:

3> include the *rlf-InfoAvailable*;

2> if the UE has logged measurements available for E-UTRA and if the RPLMN is included in *plmn-IdentityList* stored in *VarLogMeasReport*:

3> include the *logMeasAvailable*;

2> if the UE has connection establishment failure information available in *VarConnEstFailReport* and if the RPLMN is equal to *plmn-Identity* stored in *VarConnEstFailReport*:

3> include the *connEstFailInfoAvailable*;

1> perform the measurement related actions as specified in 5.5.6.1;

1> perform the measurement identity autonomous removal as specified in 5.5.2.2a;

1> submit the *RRCConnectionReestablishmentComplete* message to lower layers for transmission, upon which the procedure ends;

8.6.8.3.3 Test description

8.6.8.3.3.1 Pre-test conditions

System Simulator:

- Cell 1 and Cell 2

UE:

None.

Preamble:

- The UE is in state Registered, Idle Mode (state 2) on Cell 1 according to [18].
- System information combination 2 as defined in TS 36.508 [18] clause 4.4.3.1 is used in E-UTRA cells.

8.6.8.3.3.2 Test procedure sequence

Table 8.6.8.3.3.2-1 illustrates the downlink power levels and other changing parameters to be applied for the cells at various time instants of the test execution. Row marked "T0" denotes the initial conditions after preamble, while columns marked "T1" is to be applied subsequently. The exact instants on which these values shall be applied are described in the texts in this clause.

Table 8.6.8.3.3.2-1: Time instances of cell power level and parameter changes

	Parameter	Unit	Cell 1	Cell 2	Remark
T0	Cell-specific RS EPRE	dBm/15 kHz	-80	"Off"	Only Cell 1 is available. (NOTE 1).
T1	Cell-specific RS EPRE	dBm/15 kHz	"Off"	-80	Only Cell 2 is available. (NOTE 1).

NOTE 1: Power level "Off" is defined in TS 36.508 Table 6.2.2.1-1.

Table 8.6.8.3.3.2-2: Main behaviour

St	Procedure	Message Sequence		TP	Verdict
		U - S	Message		
1	The SS transmits a <i>Paging</i> message on Cell 1.	<--	<i>Paging</i>	-	-
2	The UE transmits an <i>RRCCONNECTIONREQUEST</i> message on Cell 1.	-->	<i>RRCCONNECTIONREQUEST</i>	-	-
3	The SS waits for 2s. Note: the UE may transmit one or more <i>RRCCONNECTIONREQUEST</i> messages but the SS does not answer to these messages.	-	-	-	-
4-11	Steps 2 to 9 of the generic radio bearer establishment procedure in TS 36.508 subclause 4.5.3.3 are executed to successfully complete the service request procedure on Cell 1.	-	-	-	-
12	The SS changes Cell 1 parameter according to the row "T1" in Table 8.6.8.3.3.2-1.	-	-	-	-
13	The UE transmits an <i>RRCCONNECTIONREESTABLISHMENTREQUEST</i> message on Cell 2.	-->	<i>RRCCONNECTIONREESTABLISHMENTREQUEST</i>	-	-
14	The SS transmits an <i>RRCCONNECTIONREESTABLISHMENT</i> message on Cell 2.	<--	<i>RRCCONNECTIONREESTABLISHMENT</i>	-	-
15	Check: Does the UE send an <i>RRCCONNECTIONREESTABLISHMENTCOMPLETE</i> message with <i>connEstFailInfoAvailable</i> on Cell 2?	-->	<i>RRCCONNECTIONREESTABLISHMENTCOMPLETE</i>	1	P
16	The SS transmits an <i>RRCCONNECTIONRECONFIGURATION</i> message on Cell 2.	<--	<i>RRCCONNECTIONRECONFIGURATION</i>	-	-
17	The UE transmits an <i>RRCCONNECTIONRECONFIGURATIONCOMPLETE</i> message on Cell 2.	-->	<i>RRCCONNECTIONRECONFIGURATIONCOMPLETE</i>	-	-

8.6.8.3.3.3 Specific message contents

Table 8.6.8.3.3.3-1: RRCConnectionSetupComplete (step 7, Table 8.6.8.3.3.2-2)

Derivation Path: 36.508, Table 4.6.1-18			
Information Element	Value/remark	Comment	Condition
RRCConnectionSetupComplete ::= SEQUENCE {			
criticalExtensions CHOICE {			
c1 CHOICE{			
rrcConnectionSetupComplete-r8 SEQUENCE {			
nonCriticalExtension SEQUENCE {			
nonCriticalExtension SEQUENCE {			
nonCriticalExtension SEQUENCE {			
connEstFailInfoAvailable-r11	true		
nonCriticalExtension SEQUENCE {}	Not present		
}			
}			
}			
}			
}			
}			
}			
}			

Table 8.6.8.3.3.3-2: RRCConnectionReestablishmentRequest (step 13, Table 8.6.8.3.3.2-2)

Derivation Path: 36.508, Table 4.6.1-13			
Information Element	Value/remark	Comment	Condition
RRCConnectionReestablishmentRequest ::= SEQUENCE {			
criticalExtensions CHOICE {			
rrcConnectionReestablishmentRequest-r8 SEQUENCE {			
ue-Identity SEQUENCE {			
c-RNTI	the value of the C-RNTI of the UE		
physCellId	PhysicalCellIdentity of Cell 1		
shortMAC-I	The same value as the 16 least significant bits of the XMAC-I value calculated by SS		
}			
reestablishmentCause	otherFailure		
}			
}			
}			

Table 8.6.8.3.3-3: *RRCConnectionReestablishmentComplete* (step 15, Table 8.6.8.3.2-2)

Derivation Path: 36.508, Table 4.6.1-11			
Information Element	Value/remark	Comment	Condition
RRCConnectionReestablishmentComplete ::= SEQUENCE {			
criticalExtensions CHOICE {			
rrcConnectionReestablishmentComplete-r8 = SEQUENCE {			
nonCriticalExtension SEQUENCE {			
rf-InfoAvailable-r9	true		
nonCriticalExtension SEQUENCE {			
nonCriticalExtension SEQUENCE {			
nonCriticalExtension SEQUENCE {			
connEstFailInfoAvailable-r11	true		
nonCriticalExtension SEQUENCE {}	Not present		
}			
}			
}			
}			
}			

8.6.8.4 Connection Establishment Failure logging / Logging and reporting / Location Information

8.6.8.4.1 Test Purpose (TP)

(1)

```
with { UE has connection establishment failure information available with location information }
ensure that {
  when { UE receives the UEInformationRequest message containing connEstFailReportReq }
  then { UE sends the UEInformationResponse message containing connEstFailReport with
locationCoordinates }
}
```

8.6.8.4.2 Conformance requirements

References: The conformance requirements covered in the present TC are specified in: TS 36.306, clause 4.3.13.2; TS 36.331, clauses 5.3.3.6 and 5.6.5.3.

[TS 36.306, clause 4.3.13.2]

This parameter defines whether the UE is equipped with a standalone GNSS receiver that may be used to provide detailed location information in RRC measurement report and logged measurements in RRC_IDLE.

[TS 36.331, clause 5.3.3.6]

The UE shall:

- 1> if timer T300 expires:
 - 2> reset MAC, release the MAC configuration and re-establish RLC for all RBs that are established;
 - 2> store the following connection establishment failure information in the *VarConnEstFailReport* by setting its fields as follows:
 - 3> clear the information included in *VarConnEstFailReport*, if any;
 - 3> set the *plmn-Identity* to the PLMN selected by upper layers (see TS 23.122 [11], TS 24.301 [35]) from the PLMN(s) included in the *plmn-IdentityList* in *SystemInformationBlockType1*;
 - 3> set the *failedCellId* to the global cell identity of the cell where connection establishment failure is detected;

- 3> set the *measResultFailedCell* to include the RSRP and RSRQ, if available, of the cell where connection establishment failure is detected and based on measurements collected up to the moment the UE detected the failure;
- 3> if available, set the *measResultNeighCells*, in order of decreasing ranking-criterion as used for cell re-selection, to include neighbouring cell measurements for at most the following number of neighbouring cells: 6 intra-frequency and 3 inter-frequency neighbours per frequency as well as 3 inter-RAT neighbours, per frequency/ set of frequencies (GERAN) per RAT and according to the following:
 - 4> for each neighbour cell included, include the optional fields that are available;

NOTE: The UE includes the latest results of the available measurements as used for cell reselection evaluation, which are performed in accordance with the performance requirements as specified in TS 36.133 [16].

- 3> if detailed location information is available, set the content of the *locationInfo* as follows:
 - 4> include the *locationCoordinates*;
 - 4> include the *horizontalVelocity*, if available;
- 3> set the *numberOfPreamblesSent* to indicate the number of preambles sent by MAC for the failed random access procedure;
- 3> set *contentionDetected* to indicate whether contention resolution was not successful as specified in TS 36.321 [6] for at least one of the transmitted preambles for the failed random access procedure;
- 3> set *maxTxPowerReached* to indicate whether or not the maximum power level was used for the last transmitted preamble, see TS 36.321 [6];
- 2> inform upper layers about the failure to establish the RRC connection, upon which the procedure ends;

The UE may discard the connection establishment failure information, i.e. release the UE variable *VarConnEstFailReport*, 48 hours after the failure is detected, upon power off or upon detach.

[TS 36.331, clause 5.6.5.3]

Upon receiving the *UEInformationRequest* message, the UE shall:

...

- 1> if *connEstFailReportReq* is set to *true* and the UE has connection establishment failure information in *VarConnEstFailReport* and if the RPLMN is equal to *plmn-Identity* stored in *VarConnEstFailReport*:
 - 2> set *timeSinceFailure* in *VarConnEstFailReport* to the time that elapsed since the last connection establishment failure in E-UTRA;
 - 2> set the *connEstFailReport* in the *UEInformationResponse* message to the value of *connEstFailReport* in *VarConnEstFailReport*;
 - 2> set the *connEstFailReport* in the *UEInformationResponse* message to the value of *connEstFailReport* in *VarConnEstFailReport*;

...

- 1> if the *logMeasReport* is included in the *UEInformationResponse*:

...

- 1> else:

- 2> submit the *UEInformationResponse* message to lower layers for transmission via SRB1;

8.6.8.4.3 Test description

8.6.8.4.3.1 Pre-test conditions

System Simulator:

- Cell 1

UE:

None.

Preamble:

- The UE's positioning engine (e.g. standalone GNSS receiver) should be provided with any necessary stimulus to allow it to provide the position. This shall be done by use of the test function Update UE Location Information defined in TS 36.509 [25] , if supported by the UE according to pc_UpdateUE_LocationInformation. Otherwise, or in addition any other suitable method may also be used.
- The UE is in state Registered, Idle Mode (state 2) on Cell 1 according to [18].

8.6.8.4.3.2 Test procedure sequence

Table 8.6.8.4.3.2-1: Main behaviour

St	Procedure	Message Sequence		TP	Verdict
		U - S	Message		
1	The SS transmits a <i>Paging</i> message.	<--	<i>Paging</i>	-	-
2	The UE transmits an <i>RRCConnectionRequest</i> message.	-->	<i>RRCConnectionRequest</i>	-	-
3	The SS waits for 2s. Note: the UE may transmit one or more <i>RRCConnectionRequest</i> messages but the SS does not answer to these messages.	-	-	-	-
4-11	Steps 2 to 9 of the generic radio bearer establishment procedure in TS 36.508 subclause 4.5.3.3 are executed to successfully complete the service request procedure.	-	-	-	-
12	The SS sends a <i>UEInformationRequest</i> message to get <i>connEstFailReportReq</i> .	<--	<i>UEInformationRequest</i>	-	-
13	Check: Does the UE send a <i>UEInformationResponse</i> message with <i>connEstFailReport</i> with the IE <i>locationInfo-r11</i> is present?	-->	<i>UEInformationResponse</i>	1	P

8.6.8.4.3.3 Specific message contents

Table 8.6.8.4.3.3-1: RRCConnectionSetupComplete (step 7, Table 8.6.8.4.3.2-1)

Derivation Path: 36.508, Table 4.6.1-18			
Information Element	Value/remark	Comment	Condition
RRCConnectionSetupComplete ::= SEQUENCE {			
criticalExtensions CHOICE {			
c1 CHOICE{			
rrcConnectionSetupComplete-r8 SEQUENCE {			
nonCriticalExtension SEQUENCE {			
nonCriticalExtension SEQUENCE {			
nonCriticalExtension SEQUENCE {			
connEstFailInfoAvailable-r11	true		
nonCriticalExtension SEQUENCE {}	Not present		
}			
}			
}			
}			
}			
}			
}			
}			

Table 8.6.8.4.3.3-2: UEInformationRequest (step 12, Table 8.6.8.4.3.2-1)

Derivation Path: 36.508, Table 4.6.1-23A, condition ConEstFail
--

Table 8.6.8.4.3.3-3: UEInformationResponse (step 13, Table 8.6.8.4.3.2-1)

Derivation Path: 36.508, Table 4.6.1-23B			
Information Element	Value/remark	Comment	Condition
UEInformationResponse-r9 ::=SEQUENCE {			
criticalExtensions CHOICE {			
c1 CHOICE {			
ueInformationResponse-r9 SEQUENCE {			
nonCriticalExtension SEQUENCE {			
nonCriticalExtension SEQUENCE {			
nonCriticalExtension SEQUENCE {			
connEstFailReport-r11 SEQUENCE {			
failedCellId-r11 SEQUENCE {			
plmn-Identity	<i>plmn-Identity</i> within <i>SystemInformationBlockType1</i> broadcasted in Cell 1		
cellIdentity	<i>cellIdentity</i> within <i>SystemInformationBlockType1</i> broadcasted in Cell 1		
}			
locationInfo-r11 SEQUENCE {			
locationCoordinates-r10 CHOICE {			
ellipsoid-Point-r10	Any allowed value		
ellipsoidPointWithAltitude-r10	Any allowed value		
ellipsoidPointWithUncertaintyCircle-r11	Any allowed value		
ellipsoidPointWithAltitudeAndUncertaintyEllipsoid-r11	Any allowed value		
ellipsoidArc-r11	Any allowed value		
polygon-r11	Any allowed value		
}			
horizontalVelocity-r10	Any allowed value		
gnss-TOD-msec-r10	Any allowed value		
}			
measResultFailedCell-r11 SEQUENCE {			
rsrpResult-r11	(0..97)		
rsrqResult-r11	Not present or (0..34)		
}			
measResultNeighCells-r11	Not present		
numberOfPreamblesSent-r11	Any allowed value		
contentionDetected-r11	Any allowed value		
maxTxPowerReached-r11	Any allowed value		
timeSinceFailure-r11	Any allowed value		
measResultListEUTRA-v1130	Not present		
}			
}			
}			
}			
}			
}			

8.6.8.5 Connection Establishment Failure logging / Logging and reporting / Reporting of Intra-frequency measurements

8.6.8.5.1 Test Purpose (TP)

(1)

```
with { UE has connection establishment failure information available with the intra-frequency measurement result }
ensure that {
  when { UE receives a UEInformationRequest message with connEstFailReportReq set to true }
```

```

    then { UE sends a UEInformationResponse message containing the measurement result for intra-
frequency neighbouring cell }
}

```

8.6.8.5.2 Conformance requirements

References: The conformance requirements covered in the present TC are specified in: TS 36.331, clause 5.3.3.6 and 5.6.5.3.

[TS 36.331, clause 5.3.3.6]

The UE shall:

- 1> if timer T300 expires:
 - 2> reset MAC, release the MAC configuration and re-establish RLC for all RBs that are established;
 - 2> store the following connection establishment failure information in the *VarConnEstFailReport* by setting its fields as follows:
 - 3> clear the information included in *VarConnEstFailReport*, if any;
 - 3> set the *plmn-Identity* to the PLMN selected by upper layers (see TS 23.122 [11], TS 24.301 [35]) from the PLMN(s) included in the *plmn-IdentityList* in *SystemInformationBlockType1*;
 - 3> set the *failedCellId* to the global cell identity of the cell where connection establishment failure is detected;
 - 3> set the *measResultFailedCell* to include the RSRP and RSRQ, if available, of the cell where connection establishment failure is detected and based on measurements collected up to the moment the UE detected the failure;
 - 3> if available, set the *measResultNeighCells*, in order of decreasing ranking-criterion as used for cell reselection, to include neighbouring cell measurements for at most the following number of neighbouring cells: 6 intra-frequency and 3 inter-frequency neighbours per frequency as well as 3 inter-RAT neighbours, per frequency/ set of frequencies (GERAN) per RAT and according to the following:
 - 4> for each neighbour cell included, include the optional fields that are available;

NOTE: The UE includes the latest results of the available measurements as used for cell reselection evaluation, which are performed in accordance with the performance requirements as specified in TS 36.133 [16].

- 3> if detailed location information is available, set the content of the *locationInfo* as follows:
 - 4> include the *locationCoordinates*;
 - 4> include the *horizontalVelocity*, if available;
 - 3> set the *numberOfPreamblesSent* to indicate the number of preambles sent by MAC for the failed random access procedure;
 - 3> set *contentionDetected* to indicate whether contention resolution was not successful as specified in TS 36.321 [6] for at least one of the transmitted preambles for the failed random access procedure;
 - 3> set *maxTxPowerReached* to indicate whether or not the maximum power level was used for the last transmitted preamble, see TS 36.321 [6];
- 2> inform upper layers about the failure to establish the RRC connection, upon which the procedure ends;

The UE may discard the connection establishment failure information, i.e. release the UE variable *VarConnEstFailReport*, 48 hours after the failure is detected, upon power off or upon detach.

[TS 36.331, clause 5.6.5.3]

Upon receiving the *UEInformationRequest* message, the UE shall:

...

- 1> if *connEstFailReportReq* is set to *true* and the UE has connection establishment failure information in *VarConnEstFailReport* and if the RPLMN is equal to *plmn-Identity* stored in *VarConnEstFailReport*:

 - 2> set *timeSinceFailure* in *VarConnEstFailReport* to the time that elapsed since the last connection establishment failure in E-UTRA;
 - 2> set the *connEstFailReport* in the *UEInformationResponse* message to the value of *connEstFailReport* in *VarConnEstFailReport*;
 - 2> discard the *connEstFailReport* from *VarConnEstFailReport* upon successful delivery of the *UEInformationResponse* message confirmed by lower layers;

...

- 1> if the *logMeasReport* is included in the *UEInformationResponse*:

...

- 1> else:

 - 2> submit the *UEInformationResponse* message to lower layers for transmission via SRB1;

8.6.8.5.3 Test description

8.6.8.5.3.1 Pre-test conditions

System Simulator:

- Cell 1 and Cell 2

UE:

None.

Preamble:

- The UE is in state Registered, Idle Mode (state 2) on Cell 1 according to [18].
- System information combination 2 as defined in TS 36.508 [18] clause 4.4.3.1 is used in E-UTRA cells.

8.6.8.5.3.2 Test procedure sequence

Table 8.6.8.5.3.2-1 illustrates the downlink power levels and other changing parameters to be applied for the cells at various time instants of the test execution. Row marked "T0" denotes the initial conditions after preamble, while columns marked "T1" is to be applied subsequently. The exact instants on which these values shall be applied are described in the texts in this clause.

Table 8.6.8.5.3.2-1: Time instances of cell power level and parameter changes

	Parameter	Unit	Cell 1	Cell 2	Remark
T0	Cell-specific RS EPRE	dBm/15 kHz	-85	"Off"	Only Cell 1 is available. (NOTE 1).
T1	Cell-specific RS EPRE	dBm/15 kHz	-85	-91	The power level values are assigned to satisfy $R_{Cell\ 1} > R_{Cell\ 2}$.
NOTE 1: Power level "Off" is defined in TS 36.508 Table 6.2.2.1-1.					

Table 8.6.8.5.3.2-2: Main behaviour

St	Procedure	Message Sequence		TP	Verdict
		U - S	Message		
1	The SS changes Cell 1 parameter according to the row "T1" in Table 8.6.8.5.3.2-1.	-	-	-	-
2	The SS waits for 40s to ensure that the UE detects intra-frequency cell.	-	-	-	-
3	The SS transmits a <i>Paging</i> message on Cell 1.	<--	<i>Paging</i>	-	-
4	The UE transmits an <i>RRCCONNECTIONREQUEST</i> message on Cell 1.	-->	<i>RRCCONNECTIONREQUEST</i>	-	-
5	The SS waits for 2s. Note: the UE may transmit one or more <i>RRCCONNECTIONREQUEST</i> messages but the SS does not answer to these messages.	-	-	-	-
6-13	Steps 2 to 9 of the generic radio bearer establishment procedure in TS 36.508 subclause 4.5.3.3 are executed to successfully complete the service request procedure on Cell 1.	-	-	-	-
14	The SS sends a <i>UEINFORMATIONREQUEST</i> message to get <i>CONNESTFAILREPORTREQ</i> on Cell 1.	<--	<i>UEINFORMATIONREQUEST</i>	-	-
15	Check: Does the UE send a <i>UEINFORMATIONRESPONSE</i> message with <i>CONNESTFAILREPORT</i> on Cell 1?	-->	<i>UEINFORMATIONRESPONSE</i>	1	P

8.6.8.5.3.3 Specific message contents

Table 8.6.8.5.3.3-1: *RRCCONNECTIONSETUPCOMPLETE* (step 9, Table 8.6.8.5.3.2-2)

Derivation Path: 36.508, Table 4.6.1-18			
Information Element	Value/remark	Comment	Condition
<i>RRCCONNECTIONSETUPCOMPLETE</i> ::= SEQUENCE {			
criticalExtensions CHOICE {			
c1 CHOICE{			
<i>rrcConnectionSetupComplete-r8</i> SEQUENCE {			
nonCriticalExtension SEQUENCE {			
nonCriticalExtension SEQUENCE {			
nonCriticalExtension SEQUENCE {			
<i>connEstFailInfoAvailable-r11</i>	true		
nonCriticalExtension SEQUENCE {}	Not present		
}			
}			
}			
}			
}			
}			

Table 8.6.8.5.3.3-2: *UEINFORMATIONREQUEST* (step 14, Table 8.6.8.5.3.2-2)

Derivation Path: 36.508, Table 4.6.1-23A, condition ConEstFail
--

Table 8.6.8.5.3.3-3: UEInformationResponse (step 15, Table 8.6.8.5.3.2-2)

Derivation Path: 36.508, Table 4.6.1-23B			
Information Element	Value/remark	Comment	Condition
UEInformationResponse-r9 ::=SEQUENCE {			
criticalExtensions CHOICE {			
c1 CHOICE {			
ueInformationResponse-r9 SEQUENCE {			
nonCriticalExtension SEQUENCE {			
nonCriticalExtension SEQUENCE {			
nonCriticalExtension SEQUENCE {			
connEstFailReport-r11 SEQUENCE {			
failedCellId-r11 SEQUENCE {			
plmn-Identity	plmn-Identity within SystemInformationBlockType1 broadcasted in Cell 1		
cellIdentity	cellIdentity within SystemInformationBlockType1 broadcasted in Cell 1		
}			
}			
}			
locationInfo-r11	Not present or any allowed value		
measResultFailedCell-r11 SEQUENCE {			
rsrpResult-r11	(0..97)		
rsrqResult-r11	Not present or (0..34)		
}			
measResultNeighCells-r11 SEQUENCE {			
measResultListEUTRA-r11 SEQUENCE {	1 entry		
carrierFreq-r9[1]	Same as Cell 2		
measResultList-r9 SEQUENCE (SIZE (1..maxCellReport)) OF SEQUENCE {	1 entry		
physCellId[1]	Same as Cell 2		
cgi-Info[1]	Not present		
measResult[1] SEQUENCE {			
rsrpResult	Not present or (0..97)		
rsrqResult	Not present or (0..34)		
additionalSI-Info-r9	Not present		
}			
}			
}			
measResultListUTRA-r11	Not present		
measResultListGERAN-r11	Not present		
measResultsCDMA2000-r11	Not present		
}			
numberOfPreamblesSent-r11	Any allowed value		
contentionDetected-r11	Any allowed value		
maxTxPowerReached-r11	Any allowed value		
timeSinceFailure-r11	Any allowed value		
measResultListEUTRA-v1130	Not present		
}			
}			
}			
}			

8.6.8.6 Connection Establishment Failure logging / Logging and reporting / Reporting of Inter-frequency measurements

8.6.8.6.1 Test Purpose (TP)

(1)

```
with { UE has connection establishment failure information available with the inter-frequency
measurement result }
ensure that {
  when { UE receives a UEInformationRequest message with connEstFailReportReq set to true }
  then { UE sends a UEInformationResponse message containing the measurement result for inter-
frequency neighbouring cell }
}
```

8.6.8.6.2 Conformance requirements

References: The conformance requirements covered in the present TC are specified in: TS 36.331, clause 5.3.3.6 and 5.6.5.3.

[TS 36.331, clause 5.3.3.6]

The UE shall:

- 1> if timer T300 expires:
 - 2> reset MAC, release the MAC configuration and re-establish RLC for all RBs that are established;
 - 2> store the following connection establishment failure information in the *VarConnEstFailReport* by setting its fields as follows:
 - 3> clear the information included in *VarConnEstFailReport*, if any;
 - 3> set the *plmn-Identity* to the PLMN selected by upper layers (see TS 23.122 [11], TS 24.301 [35]) from the PLMN(s) included in the *plmn-IdentityList* in *SystemInformationBlockType1*;
 - 3> set the *failedCellId* to the global cell identity of the cell where connection establishment failure is detected;
 - 3> set the *measResultFailedCell* to include the RSRP and RSRQ, if available, of the cell where connection establishment failure is detected and based on measurements collected up to the moment the UE detected the failure;
 - 3> if available, set the *measResultNeighCells*, in order of decreasing ranking-criterion as used for cell reselection, to include neighbouring cell measurements for at most the following number of neighbouring cells: 6 intra-frequency and 3 inter-frequency neighbours per frequency as well as 3 inter-RAT neighbours, per frequency/ set of frequencies (GERAN) per RAT and according to the following:
 - 4> for each neighbour cell included, include the optional fields that are available;

NOTE: The UE includes the latest results of the available measurements as used for cell reselection evaluation, which are performed in accordance with the performance requirements as specified in TS 36.133 [16].

- 3> if detailed location information is available, set the content of the *locationInfo* as follows:
 - 4> include the *locationCoordinates*;
 - 4> include the *horizontalVelocity*, if available;
- 3> set the *numberOfPreamblesSent* to indicate the number of preambles sent by MAC for the failed random access procedure;
- 3> set *contentionDetected* to indicate whether contention resolution was not successful as specified in TS 36.321 [6] for at least one of the transmitted preambles for the failed random access procedure;
- 3> set *maxTxPowerReached* to indicate whether or not the maximum power level was used for the last transmitted preamble, see TS 36.321 [6];

2> inform upper layers about the failure to establish the RRC connection, upon which the procedure ends;

The UE may discard the connection establishment failure information, i.e. release the UE variable *VarConnEstFailReport*, 48 hours after the failure is detected, upon power off or upon detach.

[TS 36.331, clause 5.6.5.3]

Upon receiving the *UEInformationRequest* message, the UE shall:

...

1> if *connEstFailReportReq* is set to *true* and the UE has connection establishment failure information in *VarConnEstFailReport* and if the RPLMN is equal to *plmn-Identity* stored in *VarConnEstFailReport*:

2> set *timeSinceFailure* in *VarConnEstFailReport* to the time that elapsed since the last connection establishment failure in E-UTRA;

2> set the *connEstFailReport* in the *UEInformationResponse* message to the value of *connEstFailReport* in *VarConnEstFailReport*;

2> discard the *connEstFailReport* from *VarConnEstFailReport* upon successful delivery of the *UEInformationResponse* message confirmed by lower layers;

...

1> if the *logMeasReport* is included in the *UEInformationResponse*:

...

1> else:

2> submit the *UEInformationResponse* message to lower layers for transmission via SRB1;

8.6.8.6.3 Test description

8.6.8.6.3.1 Pre-test conditions

System Simulator:

- Cell 1 and Cell 3

UE:

None.

Preamble:

- The UE is in state Registered, Idle Mode (state 2) on Cell 1 according to [18].
- System information combination 4 as defined in TS 36.508 [18] clause 4.4.3.1 is used in E-UTRA cells.

8.6.8.6.3.2 Test procedure sequence

Table 8.6.8.6.3.2-1 illustrates the downlink power levels and other changing parameters to be applied for the cells at various time instants of the test execution. Row marked "T0" denotes the initial conditions after preamble, while columns marked "T1" is to be applied subsequently. The exact instants on which these values shall be applied are described in the texts in this clause.

Table 8.6.8.6.3.2-1: Time instances of cell power level and parameter changes

	Parameter	Unit	Cell 1	Cell 3	Remark
T0	Cell-specific RS EPRE	dBm/15 kHz	-85	"Off"	Only Cell 1 is available. (NOTE 1).
T1	Cell-specific RS EPRE	dBm/15 kHz	-85	-97	The power level values are assigned to satisfy $R_{\text{Cell 1}} > R_{\text{Cell 3}}$.
NOTE 1: Power level "Off" is defined in TS 36.508 Table 6.2.2.1-1.					

Table 8.6.8.6.3.2-2: Main behaviour

St	Procedure	Message Sequence		TP	Verdict
		U - S	Message		
1	The SS changes Cell 1 parameter according to the row "T1" in Table 8.6.8.6.3.2-1.	-	-	-	-
2	The SS waits for 40s to ensure that the UE detects inter-frequency cell.	-	-	-	-
3	The SS transmits a <i>Paging</i> message on Cell 1.	<--	<i>Paging</i>	-	-
4	The UE transmits an <i>RRCCONNECTIONREQUEST</i> message on Cell 1.	-->	<i>RRCCONNECTIONREQUEST</i>	-	-
5	The SS waits for 2s. Note: the UE may transmit one or more <i>RRCCONNECTIONREQUEST</i> messages but the SS does not answer to these messages.	-	-	-	-
6-13	Steps 2 to 9 of the generic radio bearer establishment procedure in TS 36.508 subclause 4.5.3.3 are executed to successfully complete the service request procedure on Cell 1.	-	-	-	-
14	The SS sends a <i>UEINFORMATIONREQUEST</i> message to get <i>CONNESTFAILREPORTREQ</i> on Cell 1.	<--	<i>UEINFORMATIONREQUEST</i>	-	-
15	Check: Does the UE send a <i>UEINFORMATIONRESPONSE</i> message with <i>CONNESTFAILREPORT</i> on Cell 1?	-->	<i>UEINFORMATIONRESPONSE</i>	1	P

8.6.8.6.3.3 Specific message contents

Table 8.6.8.6.3.3-1: *RRCCONNECTIONSETUPCOMPLETE* (step 9, Table 8.6.8.6.3.2-2)

Derivation Path: 36.508, Table 4.6.1-18			
Information Element	Value/remark	Comment	Condition
<i>RRCCONNECTIONSETUPCOMPLETE</i> ::= SEQUENCE {			
<i>criticalExtensions</i> CHOICE {			
<i>c1</i> CHOICE {			
<i>rrcConnectionSetupComplete-r8</i> SEQUENCE {			
<i>nonCriticalExtension</i> SEQUENCE {			
<i>nonCriticalExtension</i> SEQUENCE {			
<i>nonCriticalExtension</i> SEQUENCE {			
<i>connEstFailInfoAvailable-r11</i>	true		
<i>nonCriticalExtension</i> SEQUENCE {}	Not present		
}			
}			
}			
}			
}			
}			
}			

Table 8.6.8.6.3.3-2: *UEINFORMATIONREQUEST* (step 14, Table 8.6.8.6.3.2-2)

Derivation Path: 36.508, Table 4.6.1-23A, condition ConEstFail
--

Table 8.6.8.6.3.3-3: UEInformationResponse (step 15, Table 8.6.8.6.3.2-2)

Derivation Path: 36.508, Table 4.6.1-23B			
Information Element	Value/remark	Comment	Condition
UEInformationResponse-r9 ::=SEQUENCE {			
criticalExtensions CHOICE {			
c1 CHOICE {			
ueInformationResponse-r9 SEQUENCE {			
nonCriticalExtension SEQUENCE {			
nonCriticalExtension SEQUENCE {			
nonCriticalExtension SEQUENCE {			
connEstFailReport-r11 SEQUENCE {			
failedCellId-r11 SEQUENCE {			
plmn-Identity	plmn-Identity within SystemInformationBlockType1 broadcasted in Cell 1		
cellIdentity	cellIdentity within SystemInformationBlockType1 broadcasted in Cell 1		
}			
}			
locationInfo-r11	Not present or any allowed value		
measResultFailedCell-r11 SEQUENCE {			
rsrpResult-r11	(0..97)		
rsrqResult-r11	Not present or (0..34)		
}			
measResultNeighCells-r11 SEQUENCE {			
measResultListEUTRA-r11 SEQUENCE {	1 entry		
carrierFreq-r9[1]	Same as Cell 3		
measResultList-r9 SEQUENCE (SIZE (1..maxCellReport)) OF SEQUENCE {	1 entry		
physCellId[1]	Same as Cell 3		
cgi-Info[1]	Not present		
measResult[1] SEQUENCE {			
rsrpResult	Not present or (0..97)		
rsrqResult	Not present or (0..34)		
additionalSI-Info-r9	Not present		
}			
}			
}			
measResultListUTRA-r11	Not present		
measResultListGERAN-r11	Not present		
measResultsCDMA2000-r11	Not present		
}			
numberOfPreamblesSent-r11	Any allowed value		
contentionDetected-r11	Any allowed value		
maxTxPowerReached-r11	Any allowed value		
timeSinceFailure-r11	Any allowed value		
measResultListEUTRA-v1130	Not present		
}			
}			
}			
}			
}			
}			
}			
}			
}			
}			

8.6.9 Inter-RAT Connection Establishment Failure

8.6.9.1 Connection Establishment Failure logging / Logging and reporting / Reporting at UTRAN Inter-RAT handover

8.6.9.1.1 Test Purpose (TP)

(1)

```
with { UE has connection establishment failure information available }
ensure that {
  when { UE performs an RRC Connection reconfiguration procedure at UTRAN Inter-RAT handover }
  then { UE sends an RRCCONNECTIONRECONFIGURATIONCOMPLETE message with connEstFailInfoAvailable }
}
```

(2)

```
with { UE having sent an RRCCONNECTIONRECONFIGURATIONCOMPLETE message with connEstFailInfoAvailable }
ensure that {
  when { UE receives a UEINFORMATIONREQUEST message with connEstFailReportReq set to true }
  then { UE sends a UEINFORMATIONRESPONSE message with connEstFailReport }
}
```

8.6.9.1.2 Conformance requirements

References: The conformance requirements covered in the present TC are specified in: TS 36.331, clause 5.3.3.6 and .5.4.2.3.

[TS 36.331, clause 5.3.3.6]

The UE shall:

- 1> if timer T300 expires:
 - 2> reset MAC, release the MAC configuration and re-establish RLC for all RBs that are established;
 - 2> store the following connection establishment failure information in the *VarConnEstFailReport* by setting its fields as follows:
 - 3> clear the information included in *VarConnEstFailReport*, if any;
 - 3> set the *plmn-Identity* to the PLMN selected by upper layers (see TS 23.122 [11], TS 24.301 [35]) from the PLMN(s) included in the *plmn-IdentityList* in *SystemInformationBlockType1*;
 - 3> set the *failedCellId* to the global cell identity of the cell where connection establishment failure is detected;
 - 3> set the *measResultFailedCell* to include the RSRP and RSRQ, if available, of the cell where connection establishment failure is detected and based on measurements collected up to the moment the UE detected the failure;
 - 3> if available, set the *measResultNeighCells*, in order of decreasing ranking-criterion as used for cell reselection, to include neighbouring cell measurements for at most the following number of neighbouring cells: 6 intra-frequency and 3 inter-frequency neighbours per frequency as well as 3 inter-RAT neighbours, per frequency/ set of frequencies (GERAN) per RAT and according to the following:
 - 4> for each neighbour cell included, include the optional fields that are available;

NOTE: The UE includes the latest results of the available measurements as used for cell reselection evaluation, which are performed in accordance with the performance requirements as specified in TS 36.133 [16].

- 3> if detailed location information is available, set the content of the *locationInfo* as follows:
 - 4> include the *locationCoordinates*;
 - 4> include the *horizontalVelocity*, if available;

- 3> set the *numberOfPreamblesSent* to indicate the number of preambles sent by MAC for the failed random access procedure;
 - 3> set *contentionDetected* to indicate whether contention resolution was not successful as specified in TS 36.321 [6] for at least one of the transmitted preambles for the failed random access procedure;
 - 3> set *maxTxPowerReached* to indicate whether or not the maximum power level was used for the last transmitted preamble, see TS 36.321 [6];
- 2> inform upper layers about the failure to establish the RRC connection, upon which the procedure ends;

The UE may discard the connection establishment failure information, i.e. release the UE variable *VarConnEstFailReport*, 48 hours after the failure is detected, upon power off or upon detach.

[TS 36.331, clause 5.4.2.3]

If the UE is able to comply with the configuration included in the *RRCConnectionReconfiguration* message, the UE shall:

...

- 1> set the content of *RRCConnectionReconfigurationComplete* message as follows:
 - 2> if the UE has radio link failure or handover failure information available in *VarRLF-Report* and if the RPLMN is included in *plmn-IdentityList* stored in *VarRLF-Report*:
 - 3> include *rlf-InfoAvailable*;
 - 2> if the UE has logged measurements available for E-UTRA and if the RPLMN is included in *plmn-IdentityList* stored in *VarLogMeasReport*:
 - 3> include the *logMeasAvailable*;
 - 2> if the UE has connection establishment failure information available in *VarConnEstFailReport* and if the RPLMN is equal to *plmn-Identity* stored in *VarConnEstFailReport*:
 - 3> include *connEstFailInfoAvailable*;
- 1> submit the *RRCConnectionReconfigurationComplete* message to lower layers for transmission using the new configuration;

...

8.6.9.1.3 Test description

8.6.9.1.3.1 Pre-test conditions

System Simulator:

- Cell 1 and Cell 5.
- System information combination 4 as defined in TS 36.508 [18] clause 4.4.3.1 is used in E-UTRA cells.

UE:

None.

Preamble:

- The UE is in state Registered, Idle Mode (state 2) on Cell 1 according to [18].

8.6.9.1.3.2 Test procedure sequence

Table 8.6.9.1.3.2-1 illustrates the downlink power levels and other changing parameters to be applied for the cells at various time instants of the test execution. Subsequent configurations marked "T1" and "T2" are applied at the points indicated in the Main behaviour description in Table 8.6.9.1.3.2-2.

Table 8.6.9.1.3.2-1: Time instances of cell power level and parameter changes

	Parameter	Unit	Cell 1	Cell 5	Remark
T1	Cell-specific RS EPRE	dBm/15kHz	-90	-	The power level values are assigned to satisfy $\text{Thresh}_{x,\text{high}} < \text{Srxlev}_{\text{cell } 5}$.
	CPICH Ec (UTRA FDD)	dBm/3.84 MHz	-	-65	
	PCCPCH Ec(UTRA LCR TDD)	dBm/1.28 MHz	-	-65	
T2	Cell-specific RS EPRE	dBm/15kHz	-70	-	The power level values are such that entering conditions for event 3a are satisfied.
	CPICH Ec (UTRA FDD)	dBm/3.84 MHz	-	-85	
	PCCPCH Ec (UTRA LCR TDD)	dBm/1.28 MHz	-	-85	

Table 8.6.9.1.3.2-2: Main behaviour

St	Procedure	Message Sequence		TP	Verdict
		U - S	Message		
1	The SS transmits a <i>Paging</i> message on Cell 1.	<--	<i>Paging</i>	-	-
2	The UE transmits an <i>RRCConectionRequest</i> message on Cell 1.	-->	<i>RRCConectionRequest</i>	-	-
3	The SS waits for 2s. Note: the UE may transmit one or more <i>RRCConectionRequest</i> messages but the SS does not answer to these messages.	-	-	-	-
4	The SS changes Cell 1 and Cell 5 level according to the row "T1" in table 8.6.9.1.3.2-1.	-	-	-	-
5	Generic test procedure in TS 36.508 subclause 6.4.2.8 is performed on Cell 5. NOTE: The UE performs an RAU procedure and the RRC connection is released.	-	-	-	-
6-10	Step 7 to 11 of test procedure in TS 34.123-1 subclause 12.9.14.4 is performed on Cell 5 using the UTRA reference radio bearer parameters and combination "UTRA HSDPA RB" according to TS 36.508 subclause 4.8.3 and Table 4.8.3-1. NOTE: The UE performs Network initiated RAB re-establishment in a UTRAN cell.	-	-	-	-
-	UTRAN FDD: EXCEPTION: Steps 11a1 to 11a2 describe behaviour that depends on the UE capability; the "lower case letter" identifies a step sequence that takes place if a capability is supported. UTRAN TDD : go to step 12	-	-	-	-
11a1	IF <i>pc_UTRA_CompressedModeRequired</i> THEN the SS transmits a PHYSICAL CHANNEL RECONFIGURATION message on Cell 5 including the DPCH compressed mode info.	<--	PHYSICAL CHANNEL RECONFIGURATION	-	-
11a2	The UE transmits a PHYSICAL CHANNEL RECONFIGURATION COMPLETE message on Cell 5.	-->	PHYSICAL CHANNEL RECONFIGURATION COMPLETE	-	-
12	The SS transmits a MEASUREMENT CONTROL message to setup inter-RAT measurement on Cell 5.	<--	MEASUREMENT CONTROL	-	-
13	The SS changes Cell 1 and Cell 5 level according to the row "T2" in table 8.6.9.1.3.2-1.	-	-	-	-
14	The UE transmits a MEASUREMENT REPORT message on Cell 5 including the E-UTRA event results.	-->	MEASUREMENT REPORT	-	-
15	The SS transmits a HANDOVER FROM UTRAN COMMAND message on Cell 5.	<--	HANDOVER FROM UTRAN COMMAND	-	-
16	Check: Does the UE transmit an <i>RRCConectionReconfigurationComplete</i> message with <i>connEstFailInfoAvailable</i> on Cell 1 using the security key derived from the new KeNB?	-->	<i>RRCConectionReconfigurationComplete</i>	1	P
17	Generic test procedure in TS 36.508 subclause 6.4.2.10 is performed on Cell 1. NOTE: The UE performs tracking area updating procedure without ISR and security reconfiguration after successful completion of handover from UTRA.	-	-	-	-
18	The SS transmits a <i>UEInformationRequest</i> message to get <i>connEstFailReportReq</i> on Cell 1.	<--	<i>UEInformationRequest</i>	-	-
19	Check: Does the UE transmit a <i>UEInformationResponse</i> message with <i>connEstFailReport</i> on Cell 1?	-->	<i>UEInformationResponse</i>	2	P

8.6.9.1.3.3 Specific message contents

Table 8.6.9.1.3.3-1: SystemInformationBlockType6 for Cell 1 (preamble, Table 8.6.9.1.3.2-2)

Derivation Path: 36.508, Table 4.4.3.3-5			
Information Element	Value/remark	Comment	Condition
SystemInformationBlockType6 ::= SEQUENCE {			
carrierFreqListUTRA-FDD SEQUENCE (SIZE (1..maxUTRA-FDD-Carrier)) OF SEQUENCE {			UTRA-FDD
carrierFreq[n]	Same downlink UARFCN as used for Cell 5		
cellReselectionPriority[n]	5		
p-MaxUTRA[n]	0		
}			
carrierFreqListUTRA-TDD SEQUENCE (SIZE (1..maxUTRA-TDD-Carrier)) OF SEQUENCE {			UTRA-TDD
carrierFreq[n]	Same downlink UARFCN as used for Cell 5		
cellReselectionPriority[n]	5		
}			
p-MaxUTRA[n]	0		
}			
}			

Condition	Explanation
UTRA-FDD	UTRA FDD cell environment
UTRA-TDD	UTRA TDD cell environment

Table 8.6.9.1.3.3-2: RRCConnectionSetupComplete (step 7, Table 8.6.9.1.3.2-2)

Derivation Path: 36.508, Table 4.6.1-18			
Information Element	Value/remark	Comment	Condition
RRCConnectionSetupComplete ::= SEQUENCE {			
criticalExtensions CHOICE {			
c1 CHOICE{			
rrcConnectionSetupComplete-r8 SEQUENCE {			
nonCriticalExtension SEQUENCE {			
nonCriticalExtension SEQUENCE {			
nonCriticalExtension SEQUENCE {			
connEstFailInfoAvailable-r11	true		
nonCriticalExtension SEQUENCE {}	Not present		
}			
}			
}			
}			
}			

Table 8.6.9.1.3.3-3: RRCConnectionReconfigurationComplete (step 24, Table 8.6.9.1.3.2-2)

Derivation Path: 36.508 clause 4.6.1-9			
Information Element	Value/remark	Comment	Condition
RRCConnectionReconfigurationComplete ::= SEQUENCE {			
rrc-TransactionIdentifier	RRC-TransactionIdentifier-UL		
criticalExtensions CHOICE {			
rrcConnectionReconfigurationComplete-r8			
SEQUENCE {			
nonCriticalExtension SEQUENCE {			
nonCriticalExtension SEQUENCE {			
nonCriticalExtension SEQUENCE {			
connEstFailInfoAvailable-r11	true		
nonCriticalExtension SEQUENCE {}	Not present		
}			
}			
}			
}			
}			

Table 8.6.9.1.3.3-4: UEInformationRequest (step 26, Table 8.6.9.1.3.2-2)

Derivation Path: 36.508, Table 4.6.1-23A, condition ConEstFail
--

Table 8.6.9.1.3.3-5: *UEInformationResponse* (step 27, Table 8.6.9.1.3.2-2)

Derivation Path: 36.508, Table 4.6.1-23B			
Information Element	Value/remark	Comment	Condition
<i>UEInformationResponse</i> -r9 ::=SEQUENCE {			
criticalExtensions CHOICE {			
c1 CHOICE {			
<i>ueInformationResponse</i> -r9 SEQUENCE {			
nonCriticalExtension SEQUENCE {			
nonCriticalExtension SEQUENCE {			
nonCriticalExtension SEQUENCE {			
connEstFailReport-r11 SEQUENCE {			
failedCellId-r11 SEQUENCE {			
plmn-Identity	plmn-Identity within <i>SystemInformationBlockType1</i> broadcasted in Cell 1		
cellIdentity	cellIdentity within <i>SystemInformationBlockType1</i> broadcasted in Cell 1		
}			
locationInfo-r11	Not present or any allowed value		
measResultFailedCell-r11 SEQUENCE {			
rsrpResult-r11	(0..97)		
rsrqResult-r11	Not present or (0..34)		
}			
measResultNeighCells-r11	Not present		
numberOfPreamblesSent-r11	Any allowed value		
contentionDetected-r11	Any allowed value		
maxTxPowerReached-r11	Any allowed value		
timeSinceFailure-r11	Any allowed value		
measResultListEUTRA-v1130	Not present		
}			
}			
}			

8.6.9.2 Connection Establishment Failure logging / Logging and reporting / Reporting of UTRAN Inter-RAT measurements

8.6.9.2.1 Test Purpose (TP)

(1)

```

with { UE has connection establishment failure information available with the UTRA measurement result }
ensure that {
  when { UE receives a UEInformationRequest message with connEstFailReportReq set to true }
  then { UE sends a UEInformationResponse message containing the measurement result for UTRA neighbouring cell }
}

```

8.6.9.2.2 Conformance requirements

References: The conformance requirements covered in the present TC are specified in: TS 36.331, clause 5.3.3.6 and 5.6.5.3.

[TS 36.331, clause 5.3.3.6]

The UE shall:

- 1> if timer T300 expires:
 - 2> reset MAC, release the MAC configuration and re-establish RLC for all RBs that are established;
 - 2> store the following connection establishment failure information in the *VarConnEstFailReport* by setting its fields as follows:
 - 3> clear the information included in *VarConnEstFailReport*, if any;
 - 3> set the *plmn-Identity* to the PLMN selected by upper layers (see TS 23.122 [11], TS 24.301 [35]) from the PLMN(s) included in the *plmn-IdentityList* in *SystemInformationBlockType1*;
 - 3> set the *failedCellId* to the global cell identity of the cell where connection establishment failure is detected;
 - 3> set the *measResultFailedCell* to include the RSRP and RSRQ, if available, of the cell where connection establishment failure is detected and based on measurements collected up to the moment the UE detected the failure;
 - 3> if available, set the *measResultNeighCells*, in order of decreasing ranking-criterion as used for cell re-selection, to include neighbouring cell measurements for at most the following number of neighbouring cells: 6 intra-frequency and 3 inter-frequency neighbours per frequency as well as 3 inter-RAT neighbours, per frequency/ set of frequencies (GERAN) per RAT and according to the following:
 - 4> for each neighbour cell included, include the optional fields that are available;

NOTE: The UE includes the latest results of the available measurements as used for cell reselection evaluation, which are performed in accordance with the performance requirements as specified in TS 36.133 [16].

- 3> if detailed location information is available, set the content of the *locationInfo* as follows:
 - 4> include the *locationCoordinates*;
 - 4> include the *horizontalVelocity*, if available;
 - 3> set the *numberOfPreamblesSent* to indicate the number of preambles sent by MAC for the failed random access procedure;
 - 3> set *contentionDetected* to indicate whether contention resolution was not successful as specified in TS 36.321 [6] for at least one of the transmitted preambles for the failed random access procedure;
 - 3> set *maxTxPowerReached* to indicate whether or not the maximum power level was used for the last transmitted preamble, see TS 36.321 [6];
- 2> inform upper layers about the failure to establish the RRC connection, upon which the procedure ends;

The UE may discard the connection establishment failure information, i.e. release the UE variable *VarConnEstFailReport*, 48 hours after the failure is detected, upon power off or upon detach.

[TS 36.331, clause 5.6.5.3]

Upon receiving the *UEInformationRequest* message, the UE shall:

...

- 1> if *connEstFailReportReq* is set to *true* and the UE has connection establishment failure information in *VarConnEstFailReport* and if the RPLMN is equal to *plmn-Identity* stored in *VarConnEstFailReport*:
 - 2> set *timeSinceFailure* in *VarConnEstFailReport* to the time that elapsed since the last connection establishment failure in E-UTRA;
 - 2> set the *connEstFailReport* in the *UEInformationResponse* message to the value of *connEstFailReport* in *VarConnEstFailReport*;
 - 2> discard the *connEstFailReport* from *VarConnEstFailReport* upon successful delivery of the *UEInformationResponse* message confirmed by lower layers;

...

1> if the *logMeasReport* is included in the *UEInformationResponse*:

...

1> else:

2> submit the *UEInformationResponse* message to lower layers for transmission via SRB1;

8.6.9.2.3 Test description

8.6.9.2.3.1 Pre-test conditions

System Simulator:

- Cell 1 and Cell 5
- System information combination 4 as defined in TS 36.508 [18] clause 4.4.3.1 is used in E-UTRA cells.

UE:

None.

Preamble:

- The UE is in state Registered, Idle Mode (state 2) on Cell 1 according to [18].

8.6.9.2.3.2 Test procedure sequence

Table 8.6.9.2.3.2-1 illustrates the downlink power levels and other changing parameters to be applied for the cells at various time instants of the test execution. Row marked "T0" denotes the initial conditions after preamble, while columns marked "T1" is to be applied subsequently. The exact instants on which these values shall be applied are described in the texts in this clause.

Table 8.6.9.2.3.2-1: Time instances of cell power level and parameter changes

	Parameter	Unit	Cell 1	Cell 5	Remark
T0	Cell-specific RS EPRE	dBm/15kHz	-85	-	Only Cell 1 is available. (NOTE 1)
	CPICH Ec (UTRA FDD)	dBm/3.84MHz	-	"Off"	
	PCCPCH Ec (UTRA LCR TDD)	dBm/1.28 MHz	-	"Off"	
T1	Cell-specific RS EPRE	dBm/15kHz	-85	-	Cell 1 and Cell 5 are available.
	CPICH Ec (UTRA FDD)	dBm/3.84MHz	-	-90	
	PCCPCH Ec (UTRA LCR TDD)	dBm/1.28 MHz	-	-92	

NOTE 1: Power level "Off" for UTRA cell is defined in TS 34.108 Table 6.1.4 and Table 6.1.9.

Table 8.6.9.2.3.2-2: Main behaviour

St	Procedure	Message Sequence		TP	Verdict
		U - S	Message		
1	The SS changes Cell 1 parameter according to the row "T1" in Table 8.6.9.2.3.2-1.	-	-	-	-
2	The SS waits for [30s] to ensure that the UE detects UTRA cell.	-	-	-	-
3	The SS transmits a <i>Paging</i> message on Cell 1.	<--	<i>Paging</i>	-	-
4	The UE transmits an <i>RRCCONNECTIONREQUEST</i> message on Cell 1.	-->	<i>RRCCONNECTIONREQUEST</i>	-	-
5	The SS waits for 2s. Note: the UE may transmit one or more <i>RRCCONNECTIONREQUEST</i> messages but the SS does not answer to these messages.	-	-	-	-
6-13	Steps 2 to 9 of the generic radio bearer establishment procedure in TS 36.508 subclause 4.5.3.3 are executed to successfully complete the service request procedure on Cell 1.	-	-	-	-
14	The SS sends a <i>UEINFORMATIONREQUEST</i> message to get <i>CONNESTFAILREPORTREQ</i> on Cell 1.	<--	<i>UEINFORMATIONREQUEST</i>	-	-
15	Check: Does the UE send a <i>UEINFORMATIONRESPONSE</i> message with <i>CONNESTFAILREPORT</i> on Cell 1?	-->	<i>UEINFORMATIONRESPONSE</i>	1	P

8.6.9.2.3.3 Specific message contents

Table 8.6.9.2.3.3-1: *RRCCONNECTIONSETUPCOMPLETE* (step 9, Table 8.6.9.2.3.2-2)

Derivation Path: 36.508, Table 4.6.1-18			
Information Element	Value/remark	Comment	Condition
<i>RRCCONNECTIONSETUPCOMPLETE</i> ::= SEQUENCE {			
<i>criticalExtensions</i> CHOICE {			
<i>c1</i> CHOICE {			
<i>rrcConnectionSetupComplete-r8</i> SEQUENCE {			
<i>nonCriticalExtension</i> SEQUENCE {			
<i>nonCriticalExtension</i> SEQUENCE {			
<i>nonCriticalExtension</i> SEQUENCE {			
<i>connEstFailInfoAvailable-r11</i>	true		
<i>nonCriticalExtension</i> SEQUENCE {}	Not present		
}			
}			
}			
}			
}			
}			
}			

Table 8.6.9.2.3.3-2: *UEINFORMATIONREQUEST* (step 14, Table 8.6.9.2.3.2-2)

Derivation Path: 36.508, Table 4.6.1-23A, condition ConEstFail
--

Table 8.6.9.2.3.3-3: UEInformationResponse (step 15, Table 8.6.9.2.3.2-2)

Derivation Path: 36.508, Table 4.6.1-23B			
Information Element	Value/remark	Comment	Condition
UEInformationResponse-r9 ::=SEQUENCE {			
criticalExtensions CHOICE {			
c1 CHOICE {			
ueInformationResponse-r9 SEQUENCE {			
nonCriticalExtension SEQUENCE {			
nonCriticalExtension SEQUENCE {			
nonCriticalExtension SEQUENCE {			
connEstFailReport-r11 SEQUENCE {			
failedCellId-r11 SEQUENCE {			
plmn-Identity	plmn-Identity within SystemInformationBlockType1 broadcasted in Cell 1		
cellIdentity	cellIdentity within SystemInformationBlockType1 broadcasted in Cell 1		
}			
locationInfo-r11	Not present or any allowed value		
measResultFailedCell-r11 SEQUENCE {			
rsrpResult-r11	(0..97)		
rsrqResult-r11	Not present or (0..34)		
}			
measResultNeighCells-r11 SEQUENCE {			
measResultListEUTRA-r11	Not present		
measResultListUTRA-r11 SEQUENCE {	1 entry		
carrierFreq-r9[1]	Same as Cell 5		
measResultList-r9 SEQUENCE (SIZE (1..maxCellReport)) OF SEQUENCE {	1 entry		
physCellId[1]	Same as Cell 5		
cgi-Info[1]	Not present		
measResult[1] SEQUENCE {			
utra-RSCP	Not present or (-5..91)		
utra-EcN0	Not present or (0..49)		
additionalSI-Info-r9	Not present		
}			
}			
}			
measResultListGERAN-r11	Not present		
measResultsCDMA2000-r11	Not present		
}			
numberOfPreamblesSent-r11	Any allowed value		
contentionDetected-r11	Any allowed value		
maxTxPowerReached-r11	Any allowed value		
timeSinceFailure-r11	Any allowed value		
measResultListEUTRA-v1130	Not present		
}			
}			
}			
}			
}			
}			
}			
}			
}			
}			

8.6.9.3 Connection Establishment Failure logging / Logging and reporting / Reporting of GERAN Inter-RAT measurements

8.6.9.3.1 Test Purpose (TP)

(1)

```
with { UE has connection establishment failure information available with the GERAN measurement
result }
ensure that {
  when { UE receives a UEInformationRequest message with connEstFailReportReq set to true }
  then { UE sends a UEInformationResponse message containing the measurement result for GERAN
neighbouring cell }
}
```

8.6.9.3.2 Conformance requirements

References: The conformance requirements covered in the present TC are specified in: TS 36.331, clause 5.3.3.6. Unless otherwise stated these are Rel-11 requirements.

[TS 36.331, clause 5.3.3.6]

The UE shall:

- 1> if timer T300 expires:
 - 2> reset MAC, release the MAC configuration and re-establish RLC for all RBs that are established;
 - 2> store the following connection establishment failure information in the *VarConnEstFailReport* by setting its fields as follows:
 - 3> clear the information included in *VarConnEstFailReport*, if any;
 - 3> set the *plmn-Identity* to the PLMN selected by upper layers (see TS 23.122 [11], TS 24.301 [35]) from the PLMN(s) included in the *plmn-IdentityList* in *SystemInformationBlockType1*;
 - 3> set the *failedCellId* to the global cell identity of the cell where connection establishment failure is detected;
 - 3> set the *measResultFailedCell* to include the RSRP and RSRQ, if available, of the cell where connection establishment failure is detected and based on measurements collected up to the moment the UE detected the failure;
 - 3> if available, set the *measResultNeighCells*, in order of decreasing ranking-criterion as used for cell reselection, to include neighbouring cell measurements for at most the following number of neighbouring cells: 6 intra-frequency and 3 inter-frequency neighbours per frequency as well as 3 inter-RAT neighbours, per frequency/ set of frequencies (GERAN) per RAT and according to the following:
 - 4> for each neighbour cell included, include the optional fields that are available;

NOTE: The UE includes the latest results of the available measurements as used for cell reselection evaluation, which are performed in accordance with the performance requirements as specified in TS 36.133 [16].

- 3> if detailed location information is available, set the content of the *locationInfo* as follows:
 - 4> include the *locationCoordinates*;
 - 4> include the *horizontalVelocity*, if available;
- 3> set the *numberOfPreamblesSent* to indicate the number of preambles sent by MAC for the failed random access procedure;
- 3> set *contentionDetected* to indicate whether contention resolution was not successful as specified in TS 36.321 [6] for at least one of the transmitted preambles for the failed random access procedure;
- 3> set *maxTxPowerReached* to indicate whether or not the maximum power level was used for the last transmitted preamble, see TS 36.321 [6];

2> inform upper layers about the failure to establish the RRC connection, upon which the procedure ends;

The UE may discard the connection establishment failure information, i.e. release the UE variable *VarConnEstFailReport*, 48 hours after the failure is detected, upon power off or upon detach.

8.6.9.3.3 Test description

8.6.9.3.3.1 Pre-test conditions

System Simulator:

- Cell 1 and Cell 24.
- System information combination 5 as defined in TS 36.508 [18] clause 4.4.3.1 is used in E-UTRA cells.

UE:

None.

Preamble:

- The UE is in state Registered, Idle Mode (state 2) on Cell 1 according to [18].

8.6.9.3.3.2 Test procedure sequence

Table 8.6.9.3.3.2-1 illustrates the downlink power levels and other changing parameters to be applied for the cells at various time instants of the test execution. Row marked "T0" denotes the initial conditions after preamble, while columns marked "T1" is to be applied subsequently. The exact instants on which these values shall be applied are described in the texts in this clause.

Table 8.6.9.3.3.2-1: Time instances of cell power level and parameter changes

	Parameter	Unit	Cell 1	Cell 24	Remark
T0	Cell-specific RS EPRE	dBm/15kHz	-85	-	Only Cell 1 is available. (NOTE 1)
	RSSI	dBm	-	"Off"	
T1	Cell-specific RS EPRE	dBm/15kHz	-85	-	Cell 1 and Cell 24 are available.
	RSSI	dBm	-	-85	
NOTE 1: Power level "Off" for GERAN cell is defined in TS 36.508 Table 6.2.2.1-1.					

Table 8.6.9.3.3.2-2: Main behaviour

St	Procedure	Message Sequence		TP	Verdict
		U - S	Message		
1	The SS changes Cell 1 parameter according to the row "T1" in Table 8.6.9.3.3.2-1.	-	-	-	-
2	The SS waits for [30s] to ensure that the UE detects GERAN cell.	-	-	-	-
3	The SS transmits a <i>Paging</i> message on Cell 1.	<--	<i>Paging</i>	-	-
4	The UE transmits an <i>RRCConnectionRequest</i> message on Cell 1.	-->	<i>RRCConnectionRequest</i>	-	-
5	The SS waits for 2s. Note: the UE may transmit one or more <i>RRCConnectionRequest</i> messages but the SS does not answer to these messages.	-	-	-	-
6-13	Steps 2 to 9 of the generic radio bearer establishment procedure in TS 36.508 subclause 4.5.3.3 are executed to successfully complete the service request procedure on Cell 1.	-	-	-	-
14	The SS sends a <i>UEInformationRequest</i> message to get <i>connEstFailReportReq</i> on Cell 1.	<--	<i>UEInformationRequest</i>	-	-
15	Check: Does the UE send a <i>UEInformationResponse</i> message with <i>connEstFailReport</i> on Cell 1?	-->	<i>UEInformationResponse</i>	1	P

8.6.9.3.3.3 Specific message contents

Table 8.6.9.3.3.3-1: RRCConnectionSetupComplete (step 9, Table 8.6.9.3.3.2-2)

Derivation Path: 36.508, Table 4.6.1-18			
Information Element	Value/remark	Comment	Condition
RRCConnectionSetupComplete ::= SEQUENCE {			
criticalExtensions CHOICE {			
c1 CHOICE{			
rrcConnectionSetupComplete-r8 SEQUENCE {			
nonCriticalExtension SEQUENCE {			
nonCriticalExtension SEQUENCE {			
nonCriticalExtension SEQUENCE {			
connEstFailInfoAvailable-r11	true		
nonCriticalExtension SEQUENCE {}	Not present		
}			
}			
}			
}			
}			
}			
}			
}			

Table 8.6.9.3.3.3-2: UEInformationRequest (step 14, Table 8.6.9.3.3.2-2)

Derivation Path: 36.508, Table 4.6.1-23A, condition ConEstFail
--

8.6.9.4 Connection Establishment Failure logging / Logging and reporting / Reporting of CDMA2000 Inter-RAT measurements

8.6.9.4.1 Test Purpose (TP)

(1)

```
with { UE in RRC_IDLE state with connection establishment failure information available }
ensure that {
  when { UE successfully performs a RRC connection establishment procedure and the RPLMN is equal to
plmn-Identity stored in VarConnEstFailReport }
  then { UE transmits the RRCConnectionSetupComplete with IE connEstFailInfoAvailable present }
}
```

(2)

```
with { UE has connection establishment failure information available with the CDMA2000 measurement
result and the RPLMN is equal to plmn-Identity stored in VarConnEstFailReport }
ensure that {
  when { UE receives a UEInformationRequest message with connEstFailReportReq set to true }
  then { UE sends a UEInformationResponse message with connEstFailReport containing the
measurement result for CDMA2000 neighbouring cell }
}
```

8.6.9.4.2 Conformance requirements

References: The conformance requirements covered in the present TC are specified in: TS 36.331, clause 5.3.3.4, 5.3.3.6 and 5.6.5.3. Unless otherwise stated these are Rel-11 requirements.

[TS 36.331, clause 5.3.3.4]

The UE shall:

...

1> set the content of *RRCConnectionSetupComplete* message as follows:

...

2> if the UE has connection establishment failure information available in *VarConnEstFailReport* and if the RPLMN is equal to *plmn-Identity* stored in *VarConnEstFailReport*:

3> include *connEstFailInfoAvailable*;

2> submit the *RRCConnectionSetupComplete* message to lower layers for transmission, upon which the procedure ends;

[TS 36.331, clause 5.3.3.6]

The UE shall:

1> if timer T300 expires:

2> reset MAC, release the MAC configuration and re-establish RLC for all RBs that are established;

2> store the following connection establishment failure information in the *VarConnEstFailReport* by setting its fields as follows:

3> clear the information included in *VarConnEstFailReport*, if any;

3> set the *plmn-Identity* to the PLMN selected by upper layers (see TS 23.122 [11], TS 24.301 [35]) from the PLMN(s) included in the *plmn-IdentityList* in *SystemInformationBlockType1*;

3> set the *failedCellId* to the global cell identity of the cell where connection establishment failure is detected;

- 3> set the *measResultFailedCell* to include the RSRP and RSRQ, if available, of the cell where connection establishment failure is detected and based on measurements collected up to the moment the UE detected the failure;
- 3> if available, set the *measResultNeighCells*, in order of decreasing ranking-criterion as used for cell re-selection, to include neighbouring cell measurements for at most the following number of neighbouring cells: 6 intra-frequency and 3 inter-frequency neighbours per frequency as well as 3 inter-RAT neighbours, per frequency/ set of frequencies (GERAN) per RAT and according to the following:
 - 4> for each neighbour cell included, include the optional fields that are available;

NOTE: The UE includes the latest results of the available measurements as used for cell reselection evaluation, which are performed in accordance with the performance requirements as specified in TS 36.133 [16].

- 3> if detailed location information is available, set the content of the *locationInfo* as follows:
 - 4> include the *locationCoordinates*;
 - 4> include the *horizontalVelocity*, if available;
- 3> set the *numberOfPreamblesSent* to indicate the number of preambles sent by MAC for the failed random access procedure;
- 3> set *contentionDetected* to indicate whether contention resolution was not successful as specified in TS 36.321 [6] for at least one of the transmitted preambles for the failed random access procedure;
- 3> set *maxTxPowerReached* to indicate whether or not the maximum power level was used for the last transmitted preamble, see TS 36.321 [6];
- 2> inform upper layers about the failure to establish the RRC connection, upon which the procedure ends;

The UE may discard the connection establishment failure information, i.e. release the UE variable *VarConnEstFailReport*, 48 hours after the failure is detected, upon power off or upon detach.

[TS 36.331, clause 5.6.5.3]

Upon receiving the *UEInformationRequest* message, the UE shall:

...

- 1> if *connEstFailReportReq* is set to *true* and the UE has connection establishment failure information in *VarConnEstFailReport* and if the RPLMN is equal to *plmn-Identity* stored in *VarConnEstFailReport*:
 - 2> set *timeSinceFailure* in *VarConnEstFailReport* to the time that elapsed since the last connection establishment failure in E-UTRA;
 - 2> set the *connEstFailReport* in the *UEInformationResponse* message to the value of *connEstFailReport* in *VarConnEstFailReport*;
 - 2> discard the *connEstFailReport* from *VarConnEstFailReport* upon successful delivery of the *UEInformationResponse* message confirmed by lower layers;

...

1> else:

- 2> submit the *UEInformationResponse* message to lower layers for transmission via SRB1;

8.6.9.4.3 Test description

8.6.9.4.3.1 Pre-test conditions

System Simulator:

- Cell 1 and Cell 15- Cell 1 is E-UTRAN cell, Cell 15 is a HRPD cell.
- All cells belong to the same PLMN.

- System information combination 6 as defined in TS 36.508 [18] clause 4.4.3.1 is used in E-UTRA cells with content of CDMA2000 HRPD carrier frequency list in SIB8 set as defined in TS 36.508 [18] table 6.3.1.5-1.

UE:

None.

Preamble:

- The UE is in state Registered, Idle Mode (state 2) on Cell 1 according to [18].

8.6.9.4.3.2 Test procedure sequence

Table 8.6.9.4.3.2-1 illustrates the downlink power levels and other changing parameters to be applied for the cells at various time instants of the test execution. Row marked "T0" denotes the initial conditions after preamble, while columns marked "T1" is to be applied subsequently. The exact instants on which these values shall be applied are described in the texts in this clause.

Table 8.6.9.4.3.2-1: Time instances of cell power level and parameter changes

	Parameter	Unit	Cell 1	Cell 15	Remark
T0	Cell-specific RS EPRE	dBm/15kHz	-75	-	The power level values are such that camping on Cell 1 is guaranteed
	$\hat{I}_{or/loc}$	dB	-	"Off"	
	loc	dBm/1.23 MHz	-	"Off"	
	Pilot Ec/Io (NOTE 1)	dB	-	"Off"	
T1	Cell-specific RS EPRE	dBm/15kHz	-75	-	Cell 15 is detectable
	$\hat{I}_{or/loc}$	dB	-	-20	
	loc	dBm/1.23 MHz	-	-55	
	Pilot Ec/Io (NOTE 1)	dB	-	-20	

Table 8.6.9.4.3.2-2: Main behaviour

St	Procedure	Message Sequence		TP	Verdict
		U - S	Message		
1	The SS changes Cell 15 parameter according to the row "T1" in Table 8.6.9.4.3.2-1.	-	-	-	-
2	The SS waits for 20s to ensure that the UE detects CDMA2000 Cell 15.	-	-	-	-
3	The SS transmits a <i>Paging</i> message on Cell 1.	<--	<i>Paging</i>	-	-
4	The UE transmits an <i>RRCCONNECTIONREQUEST</i> message on Cell 1.	-->	<i>RRCCONNECTIONREQUEST</i>	-	-
5	The SS waits for 2s. Note: the UE may transmit one or more <i>RRCCONNECTIONREQUEST</i> messages but the SS does not answer to these messages.	-	-	-	-
6-13	Steps 2 to 9 of the generic radio bearer establishment procedure in TS 36.508 subclause 4.5.3.3 are executed to successfully complete the service request procedure on Cell 1.	-	-	1	-
14	The SS sends a <i>UEINFORMATIONREQUEST</i> message with <i>connEstFailReportReq-r11</i> set to true on Cell 1.	<--	<i>UEINFORMATIONREQUEST</i>	-	-
15	Check: Does the UE send a <i>UEINFORMATIONRESPONSE</i> message with <i>connEstFailReport-r11</i> on Cell 1?	-->	<i>UEINFORMATIONRESPONSE</i>	2	P

8.6.9.4.3.3 Specific message contents

Table 8.6.9.4.3.3-1: RRCConnectionSetupComplete (step 9, Table 8.6.9.4.3.2-2)

Derivation Path: 36.508, Table 4.6.1-18			
Information Element	Value/remark	Comment	Condition
RRCConnectionSetupComplete ::= SEQUENCE {			
criticalExtensions CHOICE {			
c1 CHOICE{			
rrcConnectionSetupComplete-r8 SEQUENCE {			
nonCriticalExtension SEQUENCE {			
nonCriticalExtension SEQUENCE {			
nonCriticalExtension SEQUENCE {			
connEstFailInfoAvailable-r11	true		
nonCriticalExtension SEQUENCE {}	Not present		
}			
}			
}			
}			
}			
}			
}			
}			

Table 8.6.9.4.3.3-2: UEInformationRequest (step 14, Table 8.6.9.4.3.2-2)

Derivation Path: 36.508, Table 4.6.1-23A, condition ConEstFail
--

Table 8.6.9.4.3.3-3: UEInformationResponse (step 15, Table 8.6.9.4.3.2-2)

Derivation Path: 36.508, Table 4.6.1-23B			
Information Element	Value/remark	Comment	Condition
UEInformationResponse-r9 ::=SEQUENCE {			
criticalExtensions CHOICE {			
c1 CHOICE {			
ueInformationResponse-r9 SEQUENCE {			
nonCriticalExtension SEQUENCE {			
nonCriticalExtension SEQUENCE {			
nonCriticalExtension SEQUENCE {			
connEstFailReport-r11 SEQUENCE {			
failedCellId-r11 SEQUENCE {			
plmn-Identity	plmn-Identity within SystemInformationBlockType1 broadcasted in Cell 1		
cellIdentity	cellIdentity within SystemInformationBlockType1 broadcasted in Cell 1		
}			
locationInfo-r11	Not present or any allowed value		
measResultFailedCell-r11 SEQUENCE {		Cell 1	
rsrpResult-r11	(0..97)		
rsrqResult-r11	Not present or (0..34)		
}			
measResultNeighCells-r11 SEQUENCE {			
measResultListEUTRA-r11	Not present		
measResultListUTRA-r11	Not present		
measResultListGERAN-r11	Not present		
measResultsCDMA2000-r11 SEQUENCE (SIZE (1..maxFreq)) OF {	1 entry		
carrierFreq-r9[1] SEQUENCE {	Same as Cell 15		
bandClass	Operating band class under test		
arfcn	f14		
}			
measResultList-r9[1] SEQUENCE {			
preRegistrationStatusHRPD	false		
measResultListCDMA2000 SEQUENCE (SIZE (1..maxCellReport)) OF SEQUENCE {			
physCellId[1]	PhysicalCellIdentity of Cell 15		
cgi-Info[1]	Not present		
measResult[1] SEQUENCE {			
pilotStrength	(0..63)		
}			
}			
}			
}			
numberOfPreamblesSent-r11	Any allowed value		
contentionDetected-r11	Any allowed value		
maxTxPowerReached-r11	Any allowed value		
timeSinceFailure-r11	Any allowed value		
measResultListEUTRA-v1130	Not present		
}			
}			
}			
}			

8.6.10 Inter-RAT Immediate MDT

8.6.10.1 Inter-RAT Immediate MDT / Reporting / Location information / Event B2

8.6.10.1.1 Test Purpose (TP)

(1)

```
with { UE in E-UTRA RRC_CONNECTED state and measurement with event B2 configured with
includeLocationInfo included in the reportConfig }
ensure that {
  when { Entry condition for event B2 is met and detailed location information that has not been
reported is available }
  then { UE sends MeasurementReport message with locationInfo included }
}
```

8.6.10.1.2 Conformance requirements

References: The conformance requirements covered in the present TC are specified in: TS 36.306, clause 4.3.13.2; TS 36.331, clauses 5.5.5 and 5.6.5.3.

[TS 36.306, clause 4.3.13.2]

This parameter defines whether the UE is equipped with a standalone GNSS receiver that may be used to provide detailed location information in RRC measurement report and logged measurements in RRC_IDLE.

[TS 36.331, clause 5.5.5]

The purpose of this procedure is to transfer measurement results from the UE to E-UTRAN.

For the *measId* for which the measurement reporting procedure was triggered, the UE shall set the *measResults* within the *MeasurementReport* message as follows:

...

- 1> if the *includeLocationInfo* is configured in the corresponding *reportConfig* for this *measId* and detailed location information that has not been reported is available, set the content of the *locationInfo* as follows:
 - 2> include the *locationCoordinates*;
 - 2> if available, include the *gnss-TOD-msec*;

[TS 36.331, clause 5.6.5.3]

Upon receiving the *UEInformationRequest* message, the UE shall:

...

- 1> if *connEstFailReportReq* is set to *true* and the UE has connection establishment failure information in *VarConnEstFailReport* and if the RPLMN is equal to *plmn-Identity* stored in *VarConnEstFailReport*:
 - 2> set *timeSinceFailure* in *VarConnEstFailReport* to the time that elapsed since the last connection establishment failure in E-UTRA;
 - 2> set the *connEstFailReport* in the *UEInformationResponse* message to the value of *connEstFailReport* in *VarConnEstFailReport*;
 - 2> set the *connEstFailReport* in the *UEInformationResponse* message to the value of *connEstFailReport* in *VarConnEstFailReport*;

...

- 1> if the *logMeasReport* is included in the *UEInformationResponse*:

...

1> else:

2> submit the *UEInformationResponse* message to lower layers for transmission via SRB1;

8.6.10.1.3 Test description

8.6.10.1.3.1 Pre-test conditions

System Simulator:

- Cell 1 and Cell 7.
- System information combination 4 as defined in TS 36.508 [18] clause 4.4.3.1 is used in E-UTRA cells.

UE:

None.

Preamble:

- The UE's positioning engine (e.g. standalone GNSS receiver) should be provided with any necessary stimulus to allow it to provide the position. This shall be done by use of the test function Update UE Location Information defined in TS 36.509 [25] , if supported by the UE according to *pc_UpdateUE_LocationInformation*. Otherwise, or in addition any other suitable method may also be used.
- The UE is in state Generic RB Established (state 3) on Cell 1 according to [18].

8.6.10.1.3.2 Test procedure sequence

Table 8.6.10.1.3.2-1 illustrates the downlink power levels and other changing parameters to be applied for the cells at various time instants of the test execution. Row marked "T0" denotes the initial conditions after preamble, while columns marked "T1" is to be applied subsequently. The exact instants on which these values shall be applied are described in the texts in this clause.

Table 8.6.10.1.3.2-1: Time instances of cell power level and parameter changes

	Parameter	Unit	Cell 1	Cell 7	Remark
T0	Cell-specific RS EPRE	dBm/15kHz	-60	-	The power level values are such that entering conditions for event B2 are not satisfied.
	CPICH Ec (UTRA FDD)	dBm/3.84MHz	-	-88	
	PCCPCH Ec (UTRA LCR TDD)	dBm/1.28 MHz	-	-88	
T1	Cell-specific RS EPRE	dBm/15kHz	-84	-	The power level values are such that entering conditions for event B2 are satisfied.
	CPICH Ec (UTRA FDD)	dBm/3.84MHz	-	-64	
	PCCPCH Ec (UTRA LCR TDD)	dBm/1.28 MHz	-	-64	

Table 8.6.10.1.3.2-2: Main behaviour

St	Procedure	Message Sequence		TP	Verdict
		U - S	Message		
1	The SS transmits an <i>RRCCONNECTIONRECONFIGURATION</i> message to setup inter-RAT measurement with <i>includeLocationInfo</i> on Cell 1.	<--	<i>RRCCONNECTIONRECONFIGURATION</i>	-	-
2	The UE transmits an <i>RRCCONNECTIONRECONFIGURATIONCOMPLETE</i> message to confirm the setup of inter-RAT measurement on Cell 1.	-->	<i>RRCCONNECTIONRECONFIGURATIONCOMPLETE</i>	-	-
3	The SS changes Cell 1 and Cell 7 parameters according to the row "T1" in table 8.3.2.3.3.2-1.	-	-	-	-
4	Check: Does the UE transmit a <i>MEASUREMENTREPORT</i> message to report the event B2 for Cell 7 with <i>locationInfo</i> ?	-->	<i>MEASUREMENTREPORT</i>	1	P

8.6.10.1.3.3 Specific message contents

Table 8.6.10.1.3.3-1: RRCConnectionReconfiguration (step 1, Table 8.6.10.1.3.2-2)

Derivation Path: 36.508, Table 4.6.1-8, condition MEAS

Table 8.6.10.1.3.3-2: MeasConfig (Table 8.6.10.1.3.3-1)

Derivation Path: 36.508, Table 4.6.6-1, condition UTRAN			
Information Element	Value/remark	Comment	Condition
MeasConfig ::= SEQUENCE {			
measObjectToAddModList SEQUENCE (SIZE (1..maxObjectId)) OF SEQUENCE{	2 entries		
measObjectId[1]	IdMeasObject-f1		
measObject[1]	MeasObjectEUTRA-GENERIC(f1)		
measObjectId[2]	IdMeasObject-f8		
measObject[2]	MeasObjectUTRA-f8		
}			
reportConfigToAddModList SEQUENCE (SIZE (1..maxReportConfigId)) OF SEQUENCE{	1 entry		
reportConfigId	IdReportConfig-B2-UTRA		
reportConfig	ReportConfigInterRAT-B2-UTRA(-72, -76)		
}			
measIdToAddModList SEQUENCE (SIZE (1..maxMeasId)) OF SEQUENCE {	1 entry		
measId	1		
measObjectId[1]	IdMeasObject-f8		
reportConfigId[1]	IdReportConfig-B2-UTRA		
}			
}			

Table 8.6.10.1.3.3-2A: QuantityConfig (Table 8.6.10.1.3.3-1)

Derivation Path: 36.508, Table 4.6.6-3A, condition UTRAN			
Information Element	Value/remark	Comment	Condition
QuantityConfig ::= SEQUENCE {			
quantityConfigUTRA SEQUENCE {			
measQuantityUTRA-FDD	cpich-RSCP		UTRA-FDD
measQuantityUTRA-TDD	pccpch-RSCP		UTRA-TDD
filterCoefficient	fc0		
}			
}			

Condition	Explanation
UTRA-FDD	UTRA FDD cell environment
UTRA-TDD	UTRA TDD cell environment

Table 8.6.10.1.3.3-2B: MeasObjectUTRA-f8 (Table 8.6.10.1.3.3-1)

Derivation Path: 36.508, Table 4.6.6-3 MeasObjectUTRA-GENERIC(f8)			
Information Element	Value/remark	Comment	Condition
MeasObjectUTRA -GENERIC(f8) ::= SEQUENCE {			
carrierFreq	UTRA DL carrier frequency of the cell 7		
cellsToAddModList CHOICE {			
cellsToAddModListUTRA-FDD ::= SEQUENCE (SIZE (1.. maxCellMeas)) OF SEQUENCE {			UTRA-FDD
cellIndex[1]	1		
physCellId[1]	physicalCellIdentity – Cell 7		
}			
cellsToAddModListUTRA-TDD ::= SEQUENCE (SIZE (1..maxMeasId)) OF SEQUENCE {			UTRA-TDD
cellIndex[1]	1		
physCellId[1]	physicalCellIdentity – Cell 7		
}			
}			
}			

Condition	Explanation
UTRA-FDD	UTRA FDD cell environment
UTRA-TDD	UTRA TDD cell environment

- 1> if *rach-ReportReq* is set to *true*, set the contents of the *rach-Report* in the *UEInformationResponse* message as follows:
 - 2> set the *numberOfPreamblesSent* to indicate the number of preambles sent by MAC for the last successfully completed random access procedure;
 - 2> if contention resolution was not successful as specified in TS 36.321 [6] for at least one of the transmitted preambles for the last successfully completed random access procedure:
 - 3> set the *contentionDetected* to *true*;
 - 2> else:
 - 3> set the *contentionDetected* to *false*;

8.6.11.1.3 Test description

8.6.11.1.3.1 Pre-test conditions

System Simulator:

- Cell 1

UE:

None.

Preamble:

- The UE is in state Generic RB Established (state 3) on Cell 1 according to [18].

8.6.11.1.3.2 Test procedure sequence

Table 8.6.11.1.3.2-1: Main behaviour

St	Procedure	Message Sequence		TP	Verdict
		U - S	Message		
1	The SS transmits a <i>UEInformationRequest</i> message.	<--	<i>UEInformationRequest</i>	-	-
2	Check: Does the UE transmit a <i>UEInformationResponse</i> message with <i>rach-Report</i> ?	-->	<i>UEInformationResponse</i>	1	P

8.6.11.1.3.3 Specific message contents

Table 8.6.11.1.3.3-1: *UEInformationRequest* (step 1, Table 8.6.11.1.3.2-1)

Derivation Path: 36.508, Table 4.6.1-23A			
Information Element	Value/remark	Comment	Condition
<i>UEInformationRequest</i> -r9 ::=SEQUENCE {			
criticalExtensions CHOICE {			
c1 CHOICE {			
ueInformationRequest-r9 SEQUENCE {			
<i>rach-ReportReq</i> -r9	TRUE		
}			
}			
}			
}			

Table 8.6.11.1.3.3-2: *UEInformationResponse* (step 2, Table 8.6.11.1.3.2-1)

Derivation Path: 36.508, Table 4.6.1-23B			
Information Element	Value/remark	Comment	Condition
UEInformationResponse-r9 ::=SEQUENCE {			
criticalExtensions CHOICE {			
c1 CHOICE {			
ueInformationResponse-r9 SEQUENCE {			
rach-Report-r9 SEQUENCE {			
numberOfPreamblesSent-r9	Any allowed value		
contentionDetected-r9	Any allowed value		
}			
}			
}			
}			
}			

8.7 Automatic Neighbour Relation (ANR) for UTRAN

8.7.1 Inter-RAT / UTRAN ANR measurement, logging and reporting / E-UTRAN cell

8.7.1.1 Test Purpose (TP)

(1)

```
with { UE in UTRA CELL_DCH state }
ensure that {
  when { UE receives a LOGGING MEASUREMENT CONFIGURATION message containing Logged ANR configuration
Info with E-UTRA Indicator set to TRUE }
  then { UE reads "Logged ANR configuration info" and configure UE to perform inter-RAT ANR
measurements for E-UTRAN to be reported in the logged ANR report provided to the network in the UE
INFORMATION RESPONSE message }
}
```

(2)

```
with { UE in E-UTRA RRC IDLE state and T327 timer is running }
ensure that {
  when { UE performs cell reselection to a UTRAN cell belonging to the PLMN or the list of
Equivalent PLMNs where the Logging Measurement Configuration was received and source E-UTRAN cell is
not included in the blacklist for the E-UTRAN frequency in SIB 19 on target UTRAN cell }
  then { UE performs inter-RAT ANR logging for the E-UTRAN cell to be reported in the logged ANR
report provided to the network in the UE INFORMATION RESPONSE message }
}
```

(3)

```
with { UE in UTRA IDLE state and UE has a Inter-RAT ANR logging measurement stored for E-UTRAN cell
and the registered PLMN is the same as the IE "PLMN Identity" stored in LOG_ANR_REPORT_VARIABLE }
ensure that {
  when { receiving RRC CONNECTION SETUP message }
  then { UE includes the ANR Logging Results Available IE in the RRC CONNETION SETUP COMPLETE
message }
}
```

(4)

```
with { UE in UTRA CELL_DCH state and UE has inter-RAT ANR logging results available for E-UTRAN and
the registered PLMN is the same as the IE "PLMN Identity" stored in variable LOG_ANR_REPORT_VARIABLE }
ensure that {
  when { UE receives an UE INFORMATION REQUEST message with Logged ANR Report Request IE which is
asking for ANR log from UE }
  then { UE sends an UE INFORMATION RESPONSE message with ANR logged data for E-UTRAN }
}
```

8.7.1.2 Conformance requirements

References: The conformance requirements covered in the current TC is specified in: TS 25.304, clauses 5.8.2.2; TS 25.331, clauses 8.1.3.6, 8.5.63.3, 8.5.64.3 and 8.5.67.2

[TS 25.304, clause 5.8.2.2 (TP2)]

If configured to perform inter-RAT ANR via the Logging Measurement Configuration message, the UE may perform inter-RAT ANR logging only when:

- after inter-RAT cell reselection from E-UTRAN or GSM to a normal UTRAN cell belonging to the PLMN or the list of Equivalent PLMNs where the Logging Measurement Configuration is received.

During the inter-RAT ANR process, the UE may log the corresponding information of the previously camped E-UTRAN or GSM cell as specified in TS 25.331.

[TS 25.331, clause 7.2.1 (TP2)]

The UE shall perform ANR measurements and logging as specified in [4], when logged ANR measurement is configured.

[TS 25.331, clause 8.1.3.6 (TP3)]

The UE shall compare the value of the IE "Initial UE identity" in the received RRC CONNECTION SETUP message with the value of the variable INITIAL_UE_IDENTITY.

...

If the values are identical, the UE shall:

...

- 1> submit an RRC CONNECTION SETUP COMPLETE message to the lower layers on the uplink DCCH after successful state transition per subclause 8.6.3.3, with the contents set as specified below:
- 2> if an IE "Logged ANR Report Info" in variable LOG_ANR_REPORT_VARIABLE is present and the registered PLMN is the same as the IE "PLMN Identity" stored in variable LOG_ANR_REPORT_VARIABLE:
- 3> include IE "ANR Logging Results Available".

[TS 25.331, clause 8.5.63.3 (TP1)]

Upon receiving the LOGGING MEASUREMENT CONFIGURATION message the UE shall:

- 1> if IE "Logged ANR configuration Info" is present:
 - 2> if variable LOG_ANR_CONFIG was already stored, discard the existing logged measurement configuration for ANR purpose as well as the associated logged measurement information as specified in 8.5.66;
 - 2> store the received IEs in the IE "Logged ANR configuration Info" in variable LOG_ANR_CONFIG;
 - 2> store the current Registered PLMN in the IE "PLMN Identity" in variable LOG_ANR_REPORT_VARIABLE;
 - 2> start timer T327 with the timer value set to the IE "Logging Duration" included in IE "Logged ANR configuration Info".

[TS 25.331, clause 8.5.64.3 (TP4)]

The UE shall:

- 1> if IE "Logged ANR Report Request" is present:
 - 2> if Registered PLMN is the same as the IE "PLMN Identity" stored in variable LOG_ANR_REPORT_VARIABLE:

- 3> if IE "Logged ANR Report Info" in variable LOG_ANR_REPORT_VARIABLE is present:
 - 4> set IEs "Logged ANR Report Info" in the UE INFORMATION RESPONSE as follows:
 - 5> include the IEs "Logged ANR Report Info List" and set it to include entries from LOG_ANR_REPORT_VARIABLE;
 - 5> clear the logged measurement results included in the list of IEs "Logged ANR Report Info List" from the LOG_ANR_REPORT_VARIABLE;
 - 5> clear the variable LOG_ANR_CONFIG and stop timer T327.
- 2> transmit a UE INFORMATION RESPONSE message on the uplink DCCH using AM RLC.

[TS 25.331, clause 8.5.67.2 (TP2,TP4)]

While T327 is running, the UE shall:

- 1> perform the ANR measurements and evaluation on UTRAN, E-UTRAN or GERAN cells in accordance with the following:
 - 2> if IE "Inter-RAT ANR for E-UTRA Indicator" is included in variable LOG_ANR_CONFIG:
 - 3> if the UE reselected from a E-UTRA cell to an UTRA cell (serving cell) that is part of the PLMN which is the same PLMN as the IE "PLMN Identity" stored in variable LOG_ANR_REPORT_VARIABLE; and
 - 3> if the previously camped E-UTRAN cell is not included in the blacklist for the EUTRAN frequency in SIB19 of the serving cell; and
 - 3> if both the previously camped E-UTRAN cell and serving cell are not CSG cells:
 - 4> log the ANR information into the variable LOG_ANR_REPORT_VARIABLE, if E-UTRA related ANR information has not been logged before, as follows:
 - 5> set the IEs "Serving PLMN Identity" and "Serving Cell" to indicate cell identity of the serving cell;
 - 5> set the IE "Cell Identity" to indicate cell identity of this previously camped E-UTRAN cell;
 - 5> set the IE "PLMN Identity" to indicate the Primary PLMN which this previously camped E-UTRAN cell belongs to;
 - 5> set the IE "Tracking Area Code" to indicate the TAC which this previously camped E-UTRAN cell belongs to;
 - 5> set the IE "EARFCN" and "Physical Cell Identity" of this previously camped E-UTRAN cell.

8.7.1.3 Test Description

8.7.1.3.1 Pre-test conditions

System Simulator:

- SS shall use Rel-10 branch of UTRAN ASN.1 for downlink messages.
- Cell 1 and Cell 5.
- System information combination 4 as defined in TS 36.508 [18] clause 4.4.3.1 is used in E-UTRA cell: Cell 1.
- System Information Block type 19 as defined in TS 36.508 [18] clause 4.4.4.1 is used in UTRA cell: Cell 5.

UE:

None.

Preamble:

- The UE is in CELL_DCH (state 6-9) on Cell 5 (serving cell) according to clause 7.4 of TS 34.108.

8.7.1.3.2 Test procedure sequence

Table 8.7.1.3.2-1 illustrates the downlink power levels and other changing parameters to be applied for the cells at various time instants of the test execution. Row marked "T0" denotes the initial conditions after preamble, while columns marked "T1" and "T2" are to be applied subsequently. The exact instants on which these values are applied are described in the texts in this clause.

Table 8.7.1.3.2-1: Time instances of cell power level and parameter changes

	Parameter name	Unit	Cell 1	Cell 5	Remark
T0	RS EPRE	dBm/15kHz	-115	-	
	CPICH_Ec	dBm/3.84 MHz	-	-60	
	P-CCPCH	dBm/1.28 MHz	-	-62	
T1	RS EPRE	dBm/15kHz	-60	-	UE performs cell reselection from Cell 5 to Cell 1
	CPICH_Ec	dBm/3.84 MHz	-	-70	
	P-CCPCH	dBm/1.28 MHz	-	-72	
T2	RS EPRE	dBm/15kHz	-115	-	UE performs cell reselection from Cell 1 to Cell 5
	CPICH_Ec	dBm/3.84 MHz	-	-60	
	P-CCPCH	dBm/1.28 MHz	-	-62	

Table 8.7.1.3.2-2: Main behaviour

St	Procedure	Message Sequence		TP	Verdict
		U - S	Message		
1	The SS transmits a LOGGING MEASUREMENT CONFIGURATION message including to configure the UE to perform inter-RAT ANR logging for E-UTRA on Cell 5.	<--	LOGGING MEASUREMENT CONFIGURATION	-	-
2	The SS transmits an RRC CONNECTION RELEASE message on CCCH.	<--	RRC CONNECTION RELEASE	-	-
3	The SS changes Cell 1 and Cell 5 levels according to the row "T1" in table 8.7.1.3.2-1.	-	-	-	-
4	Generic test procedure in TS 36.508 Table 6.4.2.7A is performed on Cell 1.	-	-	-	-
5	Wait for 6 s for UE to receive system information.				
6	The SS changes Cell 1 and Cell 5 levels according to the row "T2" in table 8.7.1.3.2-1.	-	-	-	-
7	Generic test procedure in TS 36.508 Table 6.4.2.8 is performed on Cell 5. And the UE move to idle mode on Cell 5.	-	-	-	-
8	Wait for [TBD] seconds to allow UE to activate ANR logging.	-	-	-	-
9	The SS transmits a Paging message to the UE.	<--	PAGING	-	-
10	The UE sends an RRC CONNECTION REQUEST message.	-->	RRC CONNECTION REQUEST	-	-
11	The SS transmits an RRC CONNECTION SETUP message.	<--	RRC CONNECTION SETUP	-	-
12	Check: Does the UE sends an RRC CONNECTION SETUP COMPLETE with the IE "ANR Logging Results Available".	-->	RRC CONNECTION SETUP COMPLETE	3	P
13	The SS transmits a UE INFORMATION REQUEST message on Cell 5.	<--	UE INFORMATION REQUEST	-	-
14	Check: Does the UE send UE INFORMATION RESPONSE with the IE "Logged ANR Report Info".	-->	UE INFORMATION RESPONSE	1,2,4	P

8.7.1.3.3 Specific message contents

Table 8.7.1.3.3-1: LOGGING MEASUREMENT CONFIGURATION (step 1, Table 8.7.1.3.2-2)

Derivation path: 34.108 default LOGGING MEASUREMENT CONFIGURATION in section 9.1.1			
Information Element	Value/Remark	Comment	Condition
Logged Measurements Configuration Info			
Logged ANR configuration Info			
- Logging Duration	1 hour		
- Inter-RAT ANR for E-UTRA Indicator	TRUE		

Table 8.7.1.3.3-2: RRC CONNECTION SETUP COMPLETE (step 12, Table 8.7.1.3.2-2)

Derivation path: 34.108 default RRC CONNECTION SETUP COMPLETE in section 9.1.1			
Information Element	Value/Remark	Comment	Condition
Other information elements			
Deferred measurement control reading			
-ANR Logging Results Available	TRUE		

Table 8.7.1.3.3-3: UE INFORMATION REQUEST (step 13, Table 8.7.1.3.2-2)

Derivation path: 34.108 default UE INFORMATION REQUEST in section 9.1.1			
Information Element	Value/Remark	Comment	Condition
Logged ANR Report Request	TRUE		

Table 8.7.1.3.3-4: UE INFORMATION RESPONSE (step 14, Table 8.7.1.3.2-2)

Derivation path: 34.108 default UE INFORMATION RESPONSE in section 9.1.1			
Information Element	Value/Remark	Comment	Condition
Logged ANR Report Info List			
-Serving PLMN Identity	PLMN Identity of Cell 5		
-Serving Cell	Cell Identity of Cell 5		
-CHOICE <i>logged cell info</i>			
-E-UTRA			
- PLMN Identity	PLMN Identity within System Information Block Type1 broadcasted in Cell 1		
- Tracking Area Code	Tracking Area Code of Cell 1		
- Cell Identity	Cell Identity within System Information Block Type1 broadcasted in Cell 1		
- EARFCN	Same downlink EARFCN as used in Cell 1		
- Physical Cell identity	Physical Cell Identity of Cell 1		

9 EPS mobility management

9.1 EMM common procedures

9.1.1 Void

9.1.1.1 Void

9.1.1.2 Void

9.1.2 Authentication procedure

9.1.2.1 Authentication accepted

9.1.2.1.1 Test Purpose (TP)

(1)

```
with { a NAS signalling connection existing }
ensure that {
  when { the UE receives an AUTHENTICATION REQUEST message }
  then { the UE responds with a correct AUTHENTICATION RESPONSE message and establishes correct
  EPS security context }
}
```

9.1.2.1.2 Conformance requirements

References: The conformance requirements covered in the current TC are specified in: TS 24.301, clauses 5.4.2.1 and 5.4.2.3 and TS 33.401, clause 6.1.1.

[TS 24.301, clause 5.4.2.1]

The UE shall support the EPS authentication challenge only if a USIM is present.

An EPS security context is established in the UE and the network when an EPS authentication is successfully performed. During a successful EPS authentication, the CK and IK keys are computed. CK and IK are then used as key material to compute a new key, K_{ASME} . K_{ASME} is stored in the EPS security contexts (see 3GPP TS 33.401 [19]) of both the network and the UE, and is the root for the EPS integrity protection and ciphering key hierarchy.

[TS 24.301, clause 5.4.2.3]

The UE shall respond to an AUTHENTICATION REQUEST message. With the exception of the cases described in subclause 5.4.2.6, the UE shall process the authentication challenge data and respond with an AUTHENTICATION RESPONSE message to the network.

Upon a successful EPS authentication challenge, the new K_{ASME} calculated from the authentication challenge data shall be stored in a new EPS security context.

[TS 33.401, clause 6.1.1]

UE shall compute K_{ASME} from CK, IK, and serving network's identity (SN id) using the KDF as specified in Annex A. SN id binding implicitly authenticates the serving network's identity when the derived keys from K_{ASME} are successfully used.

...

UE shall respond with User authentication response message including RES in case of successful AUTN verification as described in TS 33.102[4] and successful AMF verification as described above. Otherwise UE shall send User authentication reject message with a proper CAUSE value.

9.1.2.1.3 Test description

9.1.2.1.3.1 Pre-test conditions

System Simulator:

- cell A.

UE:

- the UE is previously registered on E-UTRAN, and when on E-UTRAN, the UE is last authenticated and registered on cell A using default message contents according to TS 36.508 [18].

Preamble:

- the UE is in state Switched OFF (State 1) according to TS 36.508 [18].

9.1.2.1.3.2 Test procedure sequence

Table 9.1.2.1.3.2-1: Main behaviour

St	Procedure	Message Sequence		TP	Verdict
		U - S	Message		
1	Switch the UE on	-	-	-	-
2	The UE transmits an ATTACH REQUEST including a GUTI and a PDN CONNECTIVITY REQUEST message	-->	ATTACH REQUEST	-	-
3	SS transmits an AUTHENTICATION REQUEST message, KSI_{ASME} value is different to the KSI_{ASME} value provided in the ATTACH REQUEST	<--	AUTHENTICATION REQUEST	-	-
4	Check: Does the UE respond with AUTHENTICATION RESPONSE message within 6 seconds and the included RES is equal to the XRES calculated in the SS?	-->	AUTHENTICATION RESPONSE	1	P
5	SS transmits a NAS SECURITY MODE COMMAND message including the KSI_{ASME} of the new EPS security context (as provided in step 3)	<--	SECURITY MODE COMMAND	-	-
6	Check: Does the UE respond with NAS SECURITY MODE COMPLETE message integrity protected and ciphered with the new EPS security context identified by the KSI_{ASME} received in the SECURITY MODE COMMAND message in step 5	-->	SECURITY MODE COMPLETE	1	P
-	EXCEPTION: Steps 7a1 to 7a2 describe behaviour that depends on UE configuration; the "lower case letter" identifies a step sequence that take place if the UE has ESM information which needs to be transferred.	-	-	-	-
7a1	IF the UE sets the ESM information transfer flag in the last PDN CONNECTIVITY REQUEST message THEN the SS transmits an ESM INFORMATION REQUEST message to initiate exchange of protocol configuration options and/or APN.	<--	ESM INFORMATION REQUEST	-	-
7a2	The UE transmits an ESM INFORMATION RESPONSE message to transfer protocol configuration options and/or APN.	-->	ESM INFORMATION RESPONSE	-	-
8	SS responds with ATTACH ACCEPT message. The ACTIVATE DEFAULT EPS BEARER CONTEXT REQUEST message is piggybacked in ATTACH ACCEPT message	<--	ATTACH ACCEPT	-	-
-	EXCEPTION: In parallel to the event described in step 9 below the generic procedure for IP address allocation in the U-plane specified in TS 36.508 subclause 4.5A.1 takes place performing IP address allocation in the U-plane if requested by the UE.	-	-	-	-
9	The UE transmits an ATTACH COMPLETE message including an ACTIVATE DEFAULT EPS BEARER CONTEXT ACCEPT message	-->	ATTACH COMPLETE	-	-
10a1	Void	-	-	-	-
11	SS releases the RRC connection	-	-	-	-
12	SS pages the UE using S-TMSI with CN domain indicator set to "PS".	-	-	-	-
13	Check: Does the UE respond with SERVICE REQUEST message providing KSI_{ASME} value that equals the value provided in the AUTHENTICATION REQUEST message in Step 3, and, integrity protected with new EPS security context?	-->	SERVICE REQUEST	1	P
14-17	Steps 6 to 9 of the generic radio bearer establishment procedure (TS 36.508 4.5.3.3-1) are executed to successfully complete the	-	-	-	-

service request procedure.				
----------------------------	--	--	--	--

9.1.2.1.3.3 Specific message contents

Table 9.1.2.1.3.3-1: AUTHENTICATION RESPONSE (step 4, Table 9.1.2.1.3.2-1)

Derivation Path: 36.508, Table 4.7.2-8			
Information Element	Value/remark	Comment	Condition
Authentication response parameter	RES equal to the XRES calculated in the SS with the parameters provided/indicated in the AUTHENTICATION REQUEST		

9.1.2.2 Void

9.1.2.3 Authentication not accepted by the network / GUTI used / Authentication reject and re-authentication

9.1.2.3.1 Test Purpose (TP)

(1)

```
with { UE having sent an initial NAS message with type of identity GUTI }
ensure that {
  when { as a result of failure of an Authentication procedure initiated by the network the UE
receives an AUTHENTICATION REJECT message }
  then { the UE shall set the update status to EU3 ROAMING NOT ALLOWED, delete the stored GUTI,
TAI list, last visited registered TAI and KSIASME and enter state EMM-DEREGISTERED }
}
```

9.1.2.3.2 Conformance requirements

References: The conformance requirements covered in the current TC are specified in: TS 24.301, clauses 5.4.2.5.

[TS 24.301, clause 5.4.2.5]

Upon receipt of an AUTHENTICATION REJECT message, the UE shall set the update status to EU3 ROAMING NOT ALLOWED, delete the stored GUTI, TAI list, last visited registered TAI and KSI_{ASME}. The USIM shall be considered invalid until switching off the UE or the UICC containing the USIM is removed.

If the AUTHENTICATION REJECT message is received by the UE, the UE shall abort any EMM signalling procedure, stop any of the timers T3410, T3417 or T3430 (if running) and enter state EMM-DEREGISTERED.

9.1.2.3.3 Test description

9.1.2.3.3.1 Pre-test conditions

System Simulator:

- cell A.

UE:

- the UE is previously registered on E-UTRAN, and when on E-UTRAN, the UE is last authenticated and registered on cell A using default message contents according to TS 36.508 [18].

Preamble:

- the UE is in state Switched OFF (state 1) according to TS 36.508 [18].

9.1.2.3.3.2 Test procedure sequence

Table 9.1.2.3.3.2-1: Main behaviour

St	Procedure	Message Sequence		TP	Verdict
		U - S	Message		
1	Switch the UE on	-	-	-	-
2	The UE transmits an ATTACH REQUEST message including a GUTI and a PDN CONNECTIVITY REQUEST message	-->	ATTACH REQUEST	-	-
3	The SS transmits an AUTHENTICATION REQUEST message without integrity protection and ciphering	<--	AUTHENTICATION REQUEST	-	-
4	The UE transmits an AUTHENTICATION RESPONSE.	-->	AUTHENTICATION RESPONSE	-	-
5	The SS transmits an AUTHENTICATION REJECT message without integrity protection and ciphering	<--	AUTHENTICATION REJECT	-	-
6	SS releases the RRC connection	-	-	-	-
7	Check: Does the UE transmit an ATTACH REQUEST message in the next 30 seconds?	-->	ATTACH REQUEST	1	F
8	Check: Does the test result of CALL generic procedure "Test procedure for no response to paging (for NAS testing)" clause 6.4.2.5 [18] indicates that the UE responds to paging when paged with S-TMSI include GUTI-1 and with CN domain indicator set to "PS"?	-	-	1	-
9	Check: Does the test result of CALL generic procedure "Test procedure for no response to paging (for NAS testing)" clause 6.4.2.5 [18] indicate that the UE responds to paging when paged with IMSI and with CN domain indicator set to "PS"?	-	-	1	-
10	If possible (see ICS) switch off is performed or the USIM is removed. Otherwise the power is removed.	-	-	-	-
11	The UE is brought back to operation or the USIM is inserted.	-	-	-	-
12	Check: Does UE transmit a NOT integrity protected ATTACH REQUEST message including IMSI and a PDN CONNECTIVITY REQUEST message?	-->	ATTACH REQUEST	1	P
13-24	The attach procedure is completed by executing steps 5 to 16 of the UE registration procedure in TS 36.508 sub clause 4.5.2.3.	-	-	-	-
-	At the end of this test procedure sequence, the UE is in end state E-UTRA connected (E2) according to TS 36.508.	-	-	-	-

9.1.2.3.3.3 Specific message contents

Table 9.1.2.3.3.3-1a: ATTACH REQUEST (step 2, Table 9.1.2.3.3.2-1)

Derivation Path: 36.508, Table 4.7.2-4			
Information Element	Value/remark	Comment	Condition
Old GUTI or IMSI	GUTI-1	GUTI allocated in pre-test conditions.	

Table 9.1.2.3.3.3-1: ATTACH REQUEST (step 12, Table 9.1.2.3.3.2-1)

Derivation Path: 36.508, Table 4.7.2-4			
Information Element	Value/remark	Comment	Condition
NAS key set identifier	'111'B	no key is available	
Old GUTI or IMSI	IMSI		
Last visited registered TAI	Not Present		

9.1.2.4 Authentication not accepted by the UE / MAC code failure

9.1.2.4.1 Test Purpose (TP)

(1)

```
with { a NAS signalling connection existing }
ensure that {
  when { the UE receives an AUTHENTICATION REQUEST message with invalid MAC code }
  then { the UE shall send an AUTHENTICATION FAILURE message to the network, with the reject cause
#20 "MAC failure" }
}
```

9.1.2.4.2 Conformance requirements

References: The conformance requirements covered in the current TC are specified in: TS 24.301, clauses 5.4.2.6.

[TS 24.301, clause 5.4.2.6]

In an EPS authentication challenge, the UE shall check the authenticity of the core network by means of the AUTN parameter received in the AUTHENTICATION REQUEST message. This enables the UE to detect a false network.

During an EPS authentication procedure, the UE may reject the core network due to an incorrect AUTN parameter (see 3GPP TS 33.401 [19]). This parameter contains three possible causes for authentication failure:

a) MAC code failure:

If the UE finds the MAC code (supplied by the core network in the AUTN parameter) to be invalid, the UE shall send an AUTHENTICATION FAILURE message to the network, with the EMM cause #20 "MAC failure". The UE shall then follow the procedure described in subclause 5.4.2.7, item c.

[TS 24.301, clause 5.4.2.7]

c) Authentication failure (EMM cause #20 "MAC failure"):

The UE shall send an AUTHENTICATION FAILURE message, with EMM cause #20 "MAC failure" according to subclause 5.4.2.6, to the network and start timer T3418 (see example in figure 5.4.2.7.1). Furthermore, the UE shall stop any of the retransmission timers that are running (e.g. T3410, T3417, T3421 or T3430). Upon the first receipt of an AUTHENTICATION FAILURE message from the UE with EMM cause #20 "MAC failure", the network may initiate the identification procedure described in subclause 5.4.4. This is to allow the network to obtain the IMSI from the UE. The network may then check that the GUTI originally used in the authentication challenge corresponded to the correct IMSI. Upon receipt of the IDENTITY REQUEST message from the network, the UE shall send the IDENTITY RESPONSE message.

...

If the GUTI/IMSI mapping in the network was incorrect, the network should respond by sending a new AUTHENTICATION REQUEST message to the UE. Upon receiving the new AUTHENTICATION REQUEST message from the network, the UE shall stop the timer T3418, if running, and then process the challenge information as normal.

9.1.2.4.3 Test description

9.1.2.4.3.1 Pre-test conditions

System Simulator:

- cell A.

UE:

none.

Preamble:

- the UE is in state Switched OFF (State 1) according to TS 36.508 [18].

9.1.2.4.3.2 Test procedure sequence

Table 9.1.2.4.3.2-1: Main behaviour

St	Procedure	Message Sequence		TP	Verdict
		U - S	Message		
1	Switch the UE on	-	-	-	-
2	The UE transmits an ATTACH REQUEST message including a PDN CONNECTIVITY REQUEST message	-->	ATTACH REQUEST	-	-
3	SS transmits an AUTHENTICATION REQUEST message which contains an invalid MAC code	<--	AUTHENTICATION REQUEST	-	-
4	Check: Does the UE respond with an AUTHENTICATION FAILURE message, with reject cause "MAC failure"?	-->	AUTHENTICATION FAILURE	1	P
5	SS transmits an IDENTITY REQUEST message requesting IMSI in the IE Identity type	<--	IDENTITY REQUEST	-	-
6	The UE responds with a correct IDENTITY RESPONSE message providing its IMSI in the IE Mobile Identity	-->	IDENTITY RESPONSE	-	-
7	SS transmits a correct AUTHENTICATION REQUEST message, RAND different to the one send in Step 3	<--	AUTHENTICATION REQUEST	-	-
8	Check: Does the UE respond with a correct AUTHENTICATION RESPONSE message with RES that is equal to the XRES calculated in the SS?	-->	AUTHENTICATION RESPONSE	1	P
9	SS transmits a NAS SECURITY MODE COMMAND message including the KSI_{ASME} of the new EPS security context (as provided in step 8)	<--	SECURITY MODE COMMAND	-	-
10	UE transmits a NAS SECURITY MODE COMPLETE message integrity protected and ciphered with the new EPS security context identified by the KSI_{ASME} received in the SECURITY MODE COMMAND message in step 9	-->	SECURITY MODE COMPLETE	-	-
-	EXCEPTION: Steps 11a1 to 11a2 describe behaviour that depends on UE configuration; the "lower case letter" identifies a step sequence that take place if the UE has ESM information which needs to be transferred.	-	-	-	-
11a 1	IF the UE sets the ESM information transfer flag in the last PDN CONNECTIVITY REQUEST message THEN the SS transmits an ESM INFORMATION REQUEST message to initiate exchange of protocol configuration options and/or APN.	<--	ESM INFORMATION REQUEST	-	-
11a 2	The UE transmits an ESM INFORMATION RESPONSE message to transfer protocol configuration options and/or APN.	-->	ESM INFORMATION RESPONSE	-	-
12	SS responds with ATTACH ACCEPT. The ACTIVATE DEFAULT EPS BEARER CONTEXT REQUEST message is piggybacked in ATTACH ACCEPT message	<--	ATTACH ACCEPT	-	-
-	EXCEPTION: In parallel to the event described in step 13 below the generic procedure for IP address allocation in the U-plane specified in TS 36.508 subclause 4.5A.1 takes place performing IP address allocation in the U-plane if requested by the UE.	-	-	-	-
13	The UE transmits an ATTACH COMPLETE message including an ACTIVATE DEFAULT EPS BEARER CONTEXT ACCEPT message	-->	ATTACH COMPLETE	-	-
14a 1	Void	-	-	-	-

9.1.2.4.3.3 Specific message contents

Table 9.1.2.4.3.3-1: AUTHENTICATION REQUEST (step 3, Table 9.1.2.4.3.2-1)

Derivation Path: 36.508, Table 4.7.2-7			
Information Element	Value/remark	Comment	Condition
Authentication parameter AUTN	Invalid MAC	SS shall calculate the correct MAC value as specified in TS 33.102 and use any different value, e.g. correct_MAC+5.	

Table 9.1.2.4.3.3-2: AUTHENTICATION RESPONSE (step 8, Table 9.1.2.4.3.2-1)

Derivation Path: 36.508, Table 4.7.2-8			
Information Element	Value/remark	Comment	Condition
Authentication response parameter	RES equal to the XRES calculated in the SS with the parameters provided/indicated in the AUTHENTICATION REQUEST		

9.1.2.5 Authentication not accepted by the UE / SQN failure

9.1.2.5.1 Test Purpose (TP)

(1)

```
with { a NAS signalling connection existing }
ensure that {
  when { the UE receives an AUTHENTICATION REQUEST message with SQN out of range }
  then { the UE sends an AUTHENTICATION FAILURE message to the network, with EMM cause "synch failure" and a re-synchronization token }
}
```

(2)

```
with { UE having sent an AUTHENTICATION FAILURE message to the network, with EMM cause "synch failure" }
ensure that {
  when { the UE receives a new correct AUTHENTICATION REQUEST message while T3420 is running }
  then { the UE sends a correct AUTHENTICATION RESPONSE message }
}
```

9.1.2.5.2 Conformance requirements

References: The conformance requirements covered in the current TC are specified in: TS 24.301, clauses 5.4.2.6 and 5.4.2.7.

[TS 24.301, clause 5.4.2.6]

In an EPS authentication challenge, the UE shall check the authenticity of the core network by means of the AUTN parameter received in the AUTHENTICATION REQUEST message. This enables the UE to detect a false network.

During an EPS authentication procedure, the UE may reject the core network due to an incorrect AUTN parameter (see 3GPP TS 33.401 [19]). This parameter contains three possible causes for authentication failure:

...

c) SQN failure:

If the UE finds the SQN (supplied by the core network in the AUTN parameter) to be out of range, the UE shall send an AUTHENTICATION FAILURE message to the network, with the EMM cause #21 "synch failure" and a re-synchronization token AUTS provided by the USIM (see 3GPP TS 33.102 [18]). The UE shall then follow the procedure described in subclause 5.4.2.7, item e.

[TS 24.301, clause 5.4.2.7]

e) Authentication failure (EMM cause #21 "synch failure"):

The UE shall send an AUTHENTICATION FAILURE message, with EMM cause #21 "synch failure", to the network and start the timer T3420 (see example in figure 5.4.2.7.2). Furthermore, the UE shall stop any of the retransmission timers that are running (e.g. T3410, T3417, T3421 or T3430). Upon the first receipt of an AUTHENTICATION FAILURE message from the UE with the EMM cause #21 "synch failure", the network shall use the returned AUTS parameter from the authentication failure parameter IE in the AUTHENTICATION FAILURE message, to re-synchronise. The re-synchronisation procedure requires the MME to delete all unused authentication vectors for that IMSI and obtain new vectors from the HSS. When re-synchronisation is complete, the network shall initiate the authentication procedure. Upon receipt of the AUTHENTICATION REQUEST message, the UE shall stop the timer T3420, if running.

...

If the network is validated successfully (a new AUTHENTICATION REQUEST is received which contains a valid SQN and MAC) while T3420 is running, the UE shall send the AUTHENTICATION RESPONSE message to the network and shall start any retransmission timers (e.g. T3410, T3417, T3421 or T3430), if they were running and stopped when the UE received the first failed AUTHENTICATION REQUEST message.

9.1.2.5.3 Test description

9.1.2.5.3.1 Pre-test conditions

System Simulator:

- cell A.

UE:

none.

Preamble:

- the UE is in state Switched OFF (State 1) according to TS 36.508 [18].

9.1.2.5.3.2 Test procedure sequence

Table 9.1.2.5.3.2-1: Main behaviour

St	Procedure	Message Sequence		TP	Verdict
		U - S	Message		
1	Switch the UE on	-	-	-	-
2	The UE transmits an ATTACH REQUEST message including a PDN CONNECTIVITY REQUEST message	-->	ATTACH REQUEST	-	-
3	SS transmits AUTHENTICATION REQUEST message with the AMF field in the IE "Authentication parameter AUTN" set to "AMF _{RESYNCH} " value to trigger SQN re-synchronisation procedure in test USIM	<--	AUTHENTICATION REQUEST	-	-
4	Check: Does the UE respond with an AUTHENTICATION FAILURE message, with EMM cause "synch failure"?	-->	AUTHENTICATION FAILURE	1	P
5	SS transmits an IDENTITY REQUEST message requesting IMSI in the IE Identity type	<--	IDENTITY REQUEST	-	-
6	The UE responds with IDENTITY RESPONSE message providing its IMSI in the IE Mobile Identity	-->	IDENTITY RESPONSE	-	-
7	SS transmits AUTHENTICATION REQUEST message (Note 1)	<--	AUTHENTICATION REQUEST	-	-
8	Check: Does the UE respond with AUTHENTICATION RESPONSE message with RES that is equal to the XRES calculated in the SS?	-->	AUTHENTICATION RESPONSE	2	P
9	SS transmits a NAS SECURITY MODE COMMAND message including the KSI _{ASME} of the new EPS security context (as provided in step 8)	<--	SECURITY MODE COMMAND	-	-
10	UE transmits a NAS SECURITY MODE COMPLETE message integrity protected and ciphered with the new EPS security context identified by the KSI _{ASME} received in the SECURITY MODE COMMAND message in step 9	-->	SECURITY MODE COMPLETE	-	-
-	EXCEPTION: Steps 11a1 to 11a2 describe behaviour that depends on UE configuration; the "lower case letter" identifies a step sequence that take place if the UE has ESM information which needs to be transferred.	-	-	-	-
11a1	IF the UE sets the ESM information transfer flag in the last PDN CONNECTIVITY REQUEST message THEN the SS transmits an ESM INFORMATION REQUEST message to initiate exchange of protocol configuration options and/or APN.	<--	ESM INFORMATION REQUEST	-	-
11a2	The UE transmits an ESM INFORMATION RESPONSE message to transfer protocol configuration options and/or APN.	-->	ESM INFORMATION RESPONSE	-	-
12	SS responds with ATTACH ACCEPT. The ACTIVATE DEFAULT EPS BEARER CONTEXT REQUEST message is piggybacked in ATTACH ACCEPT message	<--	ATTACH ACCEPT	-	-
-	EXCEPTION: In parallel to the event described in step 13 below the generic procedure for IP address allocation in the U-plane specified in TS 36.508 subclause 4.5A.1 takes place performing IP address allocation in the U-plane if requested by the UE.	-	-	-	-
13	The UE transmits an ATTACH COMPLETE message including an ACTIVATE DEFAULT EPS BEARER CONTEXT ACCEPT message	-->	ATTACH COMPLETE	-	-

14a1	Void	-	-	-	-
Note 1: The SS shall ensure that the AUTHENTICATION REQUEST message sent in step 7 is sent less than (T3420-10%) sec after the message sent in step 4 otherwise it cannot be ensured that the UE will behave as specified in step 8.					

9.1.2.5.3.3 Specific message contents

Table 9.1.2.5.3.3-1: AUTHENTICATION REQUEST (step 3, Table 9.1.2.5.3.2-1)

Derivation Path: 36.508, Table 4.7.2-7			
Information Element	Value/remark	Comment	Condition
Authentication parameter AUTN	AMF field set to "AMF _{RESYNCH} "		

Table 9.1.2.5.3.3-2: AUTHENTICATION FAILURE (step 4, Table 9.1.2.5.3.2-1)

Derivation Path: 36.508, Table 4.7.2-5			
Information Element	Value/remark	Comment	Condition
EMM cause	'0001 0101'B	Synch failure	
Authentication failure parameter	'1111 1111 1111 1111'B	AMF _{RESYNCH} see TS 34.108, 8.1.2.2	

Table 9.1.2.5.3.3-3: AUTHENTICATION RESPONSE (step 8, Table 9.1.2.5.3.2-1)

Derivation Path: 36.508, Table 4.7.2-8			
Information Element	Value/remark	Comment	Condition
Authentication response parameter	RES equal to the XRES calculated in the SS with the parameters provided/indicated in the AUTHENTICATION REQUEST		

9.1.2.6 Abnormal cases / Network failing the authentication check

9.1.2.6.1 Test Purpose (TP)

(1)

```
with { UE in EMM-REGISTERED state / EMM-CONNECTED mode}
ensure that {
  when { UE receives an AUTHENTICATION REQUEST message but UE deems that the network failed the authentication check }
  then { UE locally release the RRC connection and treat the active cell as barred }
}
```

9.1.2.6.2 Conformance requirements

References: The conformance requirements covered in the present TC are specified in: TS 24.301, clause 5.4.2.7.

[TS 24.301, clause 5.4.2.7]

It can be assumed that the source of the authentication challenge is not genuine (authentication not accepted by the UE) if any of the following occur:

- after sending the AUTHENTICATION FAILURE message with the EMM cause #20 "MAC failure" the timer T3418 expires;

...

When it has been deemed by the UE that the source of the authentication challenge is not genuine (i.e. authentication not accepted by the UE), the UE shall proceed as described in item f.

...

f) Network failing the authentication check:

If the UE deems that the network has failed the authentication check, then it shall request RRC to locally release the RRC connection and treat the active cell as barred (see 3GPP TS 36.331 [22]). The UE shall start any retransmission timers (e.g. T3410, T3417, T3421 or T3430), if they were running and stopped when the UE received the first AUTHENTICATION REQUEST message containing an invalid MAC or SQN.

9.1.2.6.3 Test description

9.1.2.6.3.1 Pre-test conditions

System Simulator:

- Cell A and Cell B are configured according to table 6.3.2.2-1 in TS 36.508 [18]; cell A and Cell B belong to different PLMNs

UE:

none.

Preamble:

- the UE is in state Switched OFF (state 1) according to clause [18].

9.1.2.6.3.2 Test procedure sequence

Table 9.1.2.6.3.2-1: Main behaviour

St	Procedure	Message Sequence		TP	Verdict
		U - S	Message		
1	The SS configures: - Cell A as the "Serving cell". - Cell B as a " Suitable neighbour intra-frequency cell".	-	-	-	-
-	The following messages are to be observed on Cell A unless explicitly stated otherwise.	-	-	-	-
2	The UE is switched on.	-	-	-	-
3	The UE transmits an ATTACH REQUEST message including a PDN CONNECTIVITY REQUEST message.	-->	ATTACH REQUEST	-	-
4	SS transmits an AUTHENTICATION REQUEST message which contains an invalid MAC code	<--	AUTHENTICATION REQUEST	-	-
5	UE responds with an AUTHENTICATION FAILURE message, with reject cause "MAC failure" .	-->	AUTHENTICATION FAILURE	-	-
6	SS responds nothing and waits for the expiration of T3418.				
6A	The SS configures: - Cell B as the "Serving cell". - Cell A as a " Suitable neighbour intra-frequency cell".	-	-	-	-
-	The following messages are to be observed on Cell B unless explicitly stated otherwise.	-	-	-	-
7	Check: Does the UE transmit an ATTACH REQUEST message including a PDN CONNECTIVITY REQUEST message?	-->	ATTACH REQUEST	1	P
8-19	The attach procedure is completed by executing steps 5 to 16 of the UE registration procedure in TS 36.508 sub clause 4.5.2.3.	-	-	-	-
-	At the end of this test procedure sequence, the UE is in end state E-UTRA connected (E2) according to TS 36.508.	-	-	-	-

9.1.2.6.3.3 Specific message contents

Table 9.1.2.6.3.3-1: AUTHENTICATION REQUEST (step 3, Table 9.1.2.6.3.2-1)

Derivation Path: 36.508, Table 4.7.2-7			
Information Element	Value/remark	Comment	Condition
Authentication parameter AUTN	Invalid MAC	SS shall calculate the correct MAC value as specified in TS 33.401 and use any different value, e.g. correct_MAC+5.	

Table 9.1.2.6.3.3-2: AUTHENTICATION FAILURE (step 5, Table 9.1.2.6.3.2-1)

Derivation Path: 36.508, Table 4.7.2-5			
Information Element	Value/remark	Comment	Condition
EMM cause	'0001 0100'B	MAC failure	
Authentication failure parameter	Not present		

Table 9.1.2.6.3.3-3: SystemInformationBlockType1(Cell A, Preamble and all steps)

Derivation Path: 36.508 Table 4.4.3.2-3			
Information Element	Value/remark	Comment	Condition
SystemInformationBlockType1 ::= SEQUENCE {			
cellAccessRelatedInfo SEQUENCE {			
cellBarred	notBarred		
intraFreqReselection	allowed		
}			
}			

9.1.3 Security mode control procedure

9.1.3.1 NAS security mode command accepted by the UE

9.1.3.1.1 Test Purpose (TP)

(1)

```
with { successful completion of EPS authentication and key agreement (AKA) procedure }
ensure that {
  when { UE receives an integrity protected SECURITY MODE COMMAND message including replayed
security capabilities and IMEISV request }
  then { UE sends an integrity protected and ciphered SECURITY MODE COMPLETE message including
IMEISV and starts applying the NAS Security in both UL and DL }
}
```

(2)

```
with { NAS Security Activated and EPS Authentication and key agreement procedure is executed for new
Key generation }
ensure that {
  when { UE receives an integrity protected SECURITY MODE COMMAND message corresponding to NAS count
reset to zero including replayed security capabilities and IMEISV request }
  then { UE sends integrity protected and ciphered SECURITY MODE COMPLETE message with NAS count
set to zero including IMEISV and starts applying the NAS Security in both UL and DL }
}
```

9.1.3.1.2 Conformance requirements

References: The conformance requirements covered in the current TC are specified in: TS 24.301 clause 4.4.3.1, 5.4.3.1, 5.4.3.2 and 5.4.3.3.

[TS 24.301, clause 4.4.3.1]

Each EPS NAS security context shall be associated with two separate counters NAS COUNT: one related to uplink NAS messages and one related to downlink NAS messages. The NAS COUNT counters use 24 bit internal representation and are independently maintained by UE and MME. The NAS COUNT shall be constructed as a NAS sequence number (8 least significant bits) concatenated with a NAS overflow counter (16 most significant bits).

When NAS COUNT is input to NAS ciphering or NAS integrity algorithms it shall be considered to be a 32-bit entity which shall be constructed by padding the 24-bit internal representation with 8 zeros in the most significant bits.

During the handover from UTRAN/GERAN to E-UTRAN, if the mapped EPS security context is taken into use, the NAS COUNT values for this EPS security context shall be initialized to zero in the UE and the network for uplink and downlink NAS messages.

The NAS sequence number part of the NAS COUNT shall be exchanged between the UE and the MME as part of the NAS signalling. After each new or retransmitted outbound security protected NAS message, the sender shall increase the NAS COUNT number by one. Specifically, on the sender side, the NAS sequence number shall be increased by one, and if the result is zero (due to wrap around), the NAS overflow counter shall also be incremented by one (see subclause 4.4.3.5). The receiving side shall estimate the NAS COUNT used by the sending side. Specifically, if the estimated NAS sequence number wraps around, the NAS overflow counter shall be incremented by one.

[TS 24.301, clause 5.4.3.1]

The purpose of the NAS security mode control procedure is to take an EPS security context into use, and initialise and start NAS signalling security between the UE and the MME with the corresponding NAS keys and security algorithms.

[TS 24.301, clause 5.4.3.2]

The MME initiates the NAS security mode control procedure by sending a SECURITY MODE COMMAND message to the UE and starting timer T3460 (see example in figure 5.4.3.2.1).

If the security mode control procedure is initiated further to a successful execution of the authentication procedure, the MME shall use the reset downlink NAS COUNT to integrity protect the SECURITY MODE COMMAND message.

The MME shall send the SECURITY MODE COMMAND message unciphered, but shall integrity protect the message with the NAS integrity key based on K_{ASME} or mapped K'_{ASME} indicated by the eKSI included in the message. The MME shall set the security header type of the message to "integrity protected with new EPS security context".

...

The MME shall include the replayed security capabilities of the UE (including the security capabilities with regard to NAS, RRC and UP (user plane) ciphering as well as NAS, RRC integrity, and other possible target network security capabilities, i.e. UTRAN/GERAN if UE included them in the message to network), the replayed nonce_{UE} if the UE included it in the message to the network, the selected NAS ciphering and integrity algorithms and the Key Set Identifier (eKSI).

Additionally, the MME may request the UE to include its IMEISV in the SECURITY MODE COMPLETE message.

NOTE: The AS and NAS security capabilities will be the same, i.e. if the UE supports one algorithm for NAS it is also be supported for AS.

[TS 24.301, clause 5.4.3.3]

Upon receipt of the SECURITY MODE COMMAND message, the UE shall check whether the security mode command can be accepted or not. This is done by performing the integrity check of the message and by checking that the received UE security capabilities and the received nonce_{UE} have not been altered compared to what the UE provided in the initial layer 3 message that triggered this procedure.

If the type of security context flag is set to "native security context" and if the KSI matches a valid native EPS security context held in the UE while the UE has a mapped EPS security context as the current security context, the UE shall take the native EPS security context into use. The UE shall store the native EPS security context, as specified in annex C.

If the security mode command can be accepted, the UE shall reset the uplink NAS COUNT and the UE shall take the new EPS security context into use when:

- a) the SECURITY MODE COMMAND message is received further to a successful execution of the authentication procedure; or
- b) the type of security context flag is set to "mapped security context" in the NAS KSI IE included in the SECURITY MODE COMMAND message.

If the security mode command can be accepted and the eKSI was included in the SECURITY MODE COMMAND message, the UE shall send a SECURITY MODE COMPLETE message integrity protected with the selected NAS integrity algorithm and the NAS integrity key based on the K_{ASME} or mapped K'_{ASME} if the type of security context flag is set to "mapped security context" indicated by the eKSI. If the SECURITY MODE COMMAND message includes the type of security context flag set to "mapped security context" in the NAS KSI IE, $nonce_{MME}$ and $nonce_{UE}$, the UE shall generate K'_{ASME} from both nonces as indicated in 3GPP TS 33.401 [19] and reset the downlink NAS COUNT to check whether the SECURITY MODE COMMAND can be accepted or not. The UE shall cipher the SECURITY MODE COMPLETE message with the selected NAS ciphering algorithm and the NAS ciphering key based on the K_{ASME} or mapped K'_{ASME} indicated by the eKSI. The UE shall set the security header type of the message to "integrity protected and ciphered with new EPS security context".

From this time onwards the UE shall cipher and integrity protect all NAS signalling messages with the selected NAS ciphering and NAS integrity algorithms.

If the MME indicated in the SECURITY MODE COMMAND message that the IMEISV is requested, the UE shall include its IMEISV in the SECURITY MODE COMPLETE message.

9.1.3.1.3 Test description

9.1.3.1.3.1 Pre-test conditions

System Simulator:

- cell A.

UE:

None.

Preamble:

- the UE is in state Switched OFF (state 1) according to TS 36.508 [18].

9.1.3.1.3.2 Test procedure sequence

Table 9.1.3.1.3.2-1: Main behaviour

St	Procedure	Message Sequence		TP	Verdict
		U - S	Message		
1	The UE is switched on.	-	-	-	-
2	The UE transmits an ATTACH REQUEST message including a PDN CONNECTIVITY REQUEST message.	-->	ATTACH REQUEST	-	-
3	The SS transmits an AUTHENTICATION REQUEST message to initiate the EPS authentication and AKA procedure.	<--	AUTHENTICATION REQUEST	-	-
4	The UE transmits an AUTHENTICATION RESPONSE message and establishes mutual authentication.	-->	AUTHENTICATION RESPONSE	-	-
5	The SS transmits a SECURITY MODE COMMAND message to activate NAS security. It is integrity protected and includes request to include IMEISV (Note 1).	<--	SECURITY MODE COMMAND	-	-
6	Check: Does the UE transmit a SECURITY MODE COMPLETE message and does it establish the initial security configuration?	-->	SECURITY MODE COMPLETE	1	P
-	EXCEPTION: Steps 6Aa1 to 6Aa2 describe behaviour that depends on UE configuration; the "lower case letter" identifies a step sequence that take place if the UE has ESM information which needs to be transferred.	-	-	-	-
6A a1	IF the UE sets the ESM information transfer flag in the last PDN CONNECTIVITY REQUEST message THEN the SS transmits an ESM INFORMATION REQUEST message to initiate exchange of protocol configuration options and/or APN.	<--	ESM INFORMATION REQUEST	-	-
6A a2	The UE transmits an ESM INFORMATION RESPONSE message to transfer protocol configuration options and/or APN.	-->	ESM INFORMATION RESPONSE	-	-
7	The SS transmits an ATTACH ACCEPT message. The ACTIVATE DEFAULT EPS BEARER CONTEXT REQUEST message is piggybacked in ATTACH ACCEPT message	<--	ATTACH ACCEPT	-	-
8	The UE transmits an ATTACH COMPLETE message including an ACTIVATE DEFAULT EPS BEARER CONTEXT ACCEPT message	-->	ATTACH COMPLETE	-	-
9	The SS transmits an IDENTITY REQUEST message (Security protected as per the algorithms specified in step 5)	<-	IDENTITY REQUEST	-	-
10	Check: Does the UE transmit an IDENTITY RESPONSE message (Security Protected as per the algorithms specified in step 5)?	->	IDENTITY RESPONSE	1	P
11	The SS transmits an AUTHENTICATION REQUEST message to initiate the EPS authentication and AKA procedure for new key set generation.	<--	AUTHENTICATION REQUEST	-	-
12	The UE transmits an AUTHENTICATION RESPONSE message and establishes mutual authentication.	-->	AUTHENTICATION RESPONSE	-	-
13	SS resets UL and DL NAS Count to zero	-	-	-	-
14	The SS transmits a SECURITY MODE COMMAND message to activate NAS security. It is integrity protected and includes request to include IMEISV	<--	SECURITY MODE COMMAND	-	-
15	The UE transmits a NAS SECURITY MODE COMPLETE message and establishes the initial security configuration.	-->	SECURITY MODE COMPLETE	2	P
-	Exception: Steps 16 and 17 are executed 100 times to check UE is applying security correctly.	-	-	-	-

16	The SS transmits an IDENTITY REQUEST message (Security protected as per the algorithms specified in step 14)	<-	IDENTITY REQUEST	-	-
17	Check: Does the UE transmit an IDENTITY RESPONSE message (Security Protected as per the algorithms specified in step 14)?	->	IDENTITY RESPONSE	2	P
18	SS releases the RRC connection	-	-	-	-
19	The UE is brought in state Switched OFF (state 1) according to TS 36.508 [18]	-	-	-	-
20-29	Steps 1 to 10 above are executed again null ciphering algorithm requested in step 5. (Note 1)	-	-	-	-
Note 1: This TC verifies the usage of a not null and the null ciphering algorithms. The type of algorithm is specified in the SECURITY MODE COMMAND and then is applied in the messages that follow accordingly.					

9.1.3.1.3.3 Specific message contents

Table 9.1.3.1.3.3-1: SECURITY MODE COMMAND (Steps 5 and 14, Table 9.1.3.1.3.2-1)

Derivation path: 36.508 [18], table 4.7.2-19			
Information Element	Value/Remark	Comment	Condition
Selected NAS security algorithms			
Type of ciphering algorithm	Set according to PIXIT parameter for default ciphering algorithm if it is set to a value different to EEA0, or, set to any value different to EEA0 otherwise	Non-zero ciphering algorithm	
IMEISV request	Present		

Table 9.1.3.1.3.3-2: SECURITY MODE COMPLETE (Steps 6, 15 and 25, Table 9.1.3.1.3.2-1)

Derivation path: 36.508 [18], table 4.7.2-20			
Information Element	Value/Remark	Comment	Condition
IMEISV	Present		

Table 9.1.3.1.3.3-3: SECURITY MODE COMMAND (Step 24, Table 9.1.3.1.3.2-1)

Derivation path: 36.508 [18], table 4.7.2-19			
Information Element	Value/Remark	Comment	Condition
Selected NAS security algorithms			
Type of ciphering algorithm	EEA0	Zero ciphering algorithm	
IMEISV request	Present		

9.1.3.2 NAS security mode command not accepted by the UE

9.1.3.2.1 Test Purpose (TP)

(1)

```
with { successful completion of EPS authentication and key agreement (AKA) procedure[ ]
ensure that {
  when { UE receives an integrity protected SECURITY MODE COMMAND message including not matching
replayed security capabilities}
  then { UE sends SECURITY MODE REJECT and does not start applying the NAS security in both UL and
DL}
}
```

9.1.3.2.2 Conformance requirements

References: The conformance requirements covered in the current TC are specified in: TS 24.301 clause 5.4.3.1, 5.4.3.2, 5.4.3.3 and 5.4.3.5.

[TS 24.301, clause 5.4.3.1]

The purpose of the NAS security mode control procedure is to take an EPS security context into use, and initialise and start NAS signalling security between the UE and the MME with the corresponding NAS keys and security algorithms.

[TS 24.301, clause 5.4.3.2]

The MME initiates the NAS security mode control procedure by sending a SECURITY MODE COMMAND message to the UE and starting timer T3460 (see example in figure 5.4.3.2.1).

If the security mode control procedure is initiated further to a successful execution of the authentication procedure, the MME shall use the reset downlink NAS COUNT to integrity protect the SECURITY MODE COMMAND message.

The MME shall send the SECURITY MODE COMMAND message unciphered, but shall integrity protect the message with the NAS integrity key based on K_{ASME} or mapped K'_{ASME} indicated by the eKSI included in the message. The MME shall set the security header type of the message to "integrity protected with new EPS security context".

...

The MME shall include the replayed security capabilities of the UE (including the security capabilities with regard to NAS, RRC and UP (user plane) ciphering as well as NAS, RRC integrity, and other possible target network security capabilities, i.e. UTRAN/GERAN if UE included them in the message to network), the replayed nonce_{UE} if the UE included it in the message to the network, the selected NAS ciphering and integrity algorithms and the Key Set Identifier (eKSI).

Additionally, the MME may request the UE to include its IMEISV in the SECURITY MODE COMPLETE message.

NOTE: The AS and NAS security capabilities will be the same, i.e. if the UE supports one algorithm for NAS it is also be supported for AS.

[TS 24.301, clause 5.4.3.3]

Upon receipt of the SECURITY MODE COMMAND message, the UE shall check whether the security mode command can be accepted or not. This is done by performing the integrity check of the message and by checking that the received UE security capabilities and the received nonce_{UE} have not been altered compared to what the UE provided in the initial layer 3 message that triggered this procedure.

[TS 24.301, clause 5.4.3.5]

If the security mode command cannot be accepted, the UE shall send a SECURITY MODE REJECT message, which shall not be integrity protected. The SECURITY MODE REJECT message contains an EMM cause that typically indicates one of the following cause values:

#23: UE security capabilities mismatch;

#24: security mode rejected, unspecified.

Upon receipt of the SECURITY MODE REJECT message, the MME shall stop timer T3460. The MME shall also abort the ongoing procedure that triggered the initiation of the NAS security mode control procedure.

9.1.3.2.3 Test description

9.1.3.2.3.1 Pre-test conditions

System Simulator:

- cell A.

UE:

none.

Preamble:

- the UE is in state Switched OFF (state 1) according to TS 36.508 [18].

9.1.3.2.3.2 Test procedure sequence

Table 9.1.3.2.3.2-1: Main behaviour

St	Procedure	Message Sequence		TP	Verdict
		U - S	Message		
1	The UE is switched on.	-	-	-	-
2	The UE transmits an ATTACH REQUEST message including a PDN CONNECTIVITY REQUEST message.	-->	ATTACH REQUEST	-	-
3	The SS transmits an AUTHENTICATION REQUEST message to initiate the EPS authentication and AKA procedure.	<--	AUTHENTICATION REQUEST	-	-
4	The UE transmits an AUTHENTICATION RESPONSE message and establishes mutual authentication.	-->	AUTHENTICATION RESPONSE	-	-
5	The SS transmits a NAS SECURITY MODE COMMAND message to activate NAS security. It is integrity protected and includes un matched replayed security capabilities.	<--	SECURITY MODE COMMAND	-	-
6	Check: Does the UE transmit a NAS SECURITY MODE REJECT message with cause'#23: UE security capabilities mismatch'?	-->	SECURITY MODE REJECT	1	P
7	The SS Transmits an IDENTITY REQUEST message for IMSI (Security not applied)	<-	IDENTITY REQUEST	-	-
8	Check: Does the UE transmit a non security protected IDENTITY RESPONSE message?	->	IDENTITY RESPONSE	1	P
9	The SS transmits a SECURITY MODE COMMAND message to activate NAS security. It is integrity protected and includes request to include IMEISV	<--	SECURITY MODE COMMAND	-	-
10	The UE transmits a SECURITY MODE COMPLETE message and establishes the initial security configuration.	-->	SECURITY MODE COMPLETE	-	-
-	EXCEPTION: Steps 10Aa1 to 10Aa2 describe behaviour that depends on UE configuration; the "lower case letter" identifies a step sequence that take place if the UE has ESM information which needs to be transferred.	-	-	-	-
10 Aa 1	IF the UE sets the ESM information transfer flag in the last PDN CONNECTIVITY REQUEST message THEN the SS transmits an ESM INFORMATION REQUEST message to initiate exchange of protocol configuration options and/or APN.	<--	ESM INFORMATION REQUEST	-	-
10 A a2	The UE transmits an ESM INFORMATION RESPONSE message to transfer protocol configuration options and/or APN.	-->	ESM INFORMATION RESPONSE	-	-
11	The SS transmits an ATTACH ACCEPT message. The ACTIVATE DEFAULT EPS BEARER CONTEXT REQUEST message is piggybacked in ATTACH ACCEPT message	<--	ATTACH ACCEPT	-	-
12	The UE transmits an ATTACH COMPLETE message including an ACTIVATE DEFAULT EPS BEARER CONTEXT ACCEPT message	-->	ATTACH COMPLETE	-	-

9.1.3.2.3.3 Specific message contents

Table 9.1.3.2.3.3-1: SECURITY MODE COMMAND (Step 5)

Derivation path: 36.508 table 4.7.2-19			
Information Element	Value/Remark	Comment	Condition
Replayed UE security capabilities	Set to mismatch the security capability of UE under test		

Table 9.1.3.2.3.3-2: SECURITY MODE REJECT (Step 6)

Derivation path: 36.508 table 4.7.2-21			
Information Element	Value/Remark	Comment	Condition
EMM cause	#23		

9.1.3.3 No emergency bearer service / NAS security mode command with EIA0 not accepted by the UE

9.1.3.3.1 Test Purpose (TP)

(1)

```
with { UE not having a PDN connection for emergency bearer services established or not establishing
a PDN connection for emergency bearer }
ensure that {
  when { UE receives a SECURITY MODE COMMAND message indicating the "null integrity protection
algorithm" EIA0 }
  then { UE sends SECURITY MODE REJECT and does not start applying the "null integrity protection
algorithm" EIA0 }
}
```

9.1.3.3.2 Conformance requirements

References: The conformance requirements covered in the current TC are specified in: TS 24.301 clause 4.4.4.1, 4.4.4.2, 5.4.3.3 and 5.4.3.5.

[TS 24.301, clause 4.4.4.1]

For the UE, integrity protected signalling is mandatory for the NAS messages once a valid EPS security context exists and has been taken into use. For the network, integrity protected signalling is mandatory for the NAS messages once a secure exchange of NAS messages has been established for the NAS signalling connection. Integrity protection of all NAS signalling messages is the responsibility of the NAS. It is the network which activates integrity protection.

The use of "null integrity protection algorithm" EIA0 (see subclause 9.9.3.23) in the current security context is only allowed for an unauthenticated UE. For setting the security header type in outbound NAS messages, the UE and the MME shall apply the same rules irrespective of whether the "null integrity protection algorithm" or any other integrity protection algorithm is indicated in the security context.

[TS 24.301, clause 4.4.4.2]

Except the messages listed below, no NAS signalling messages shall be processed by the receiving EMM entity in the UE or forwarded to the ESM entity, unless the network has established secure exchange of NAS messages for the NAS signalling connection:

- EMM messages:
 - IDENTITY REQUEST (if requested identification parameter is IMSI);
 - AUTHENTICATION REQUEST;
 - ...

NOTE: These messages are accepted by the UE without integrity protection, as in certain situations they are sent by the network before security can be activated.

All ESM messages are integrity protected.

Once the secure exchange of NAS messages has been established, the receiving EMM or ESM entity in the UE shall not process any NAS signalling messages unless they have been successfully integrity checked by the NAS. If NAS signalling messages, having not successfully passed the integrity check, are received, then the NAS in the UE shall discard that message. The processing of the SECURITY MODE COMMAND message that has not successfully passed the integrity check is specified in subclause 5.4.3.5. If any NAS signalling message is received as not integrity protected even though the secure exchange of NAS messages has been established by the network, then the NAS shall discard this message.

[TS 24.301, clause 5.4.3.3]

Upon receipt of the SECURITY MODE COMMAND message, the UE shall check whether the security mode command can be accepted or not. This is done by performing the integrity check of the message and by checking that the received replayed UE security capabilities and the received nonce_{UE} have not been altered compared to what the UE provided in the initial layer 3 message that triggered this procedure. However, the UE is not required to perform the checking of the received nonce_{UE} if the UE does not want to re-generate the K'_{ASME} (i.e. the SECURITY MODE COMMAND message is to derive and take into use a mapped EPS security context and the eKSI matches the current EPS security context, if it is a mapped EPS security context). When the UE has a PDN connection for emergency bearer services established or the UE is establishing a PDN connection for emergency bearer services, the UE is not required to locally re-generate the K_{ASME} (i.e. the SECURITY MODE COMMAND message is used to derive and take into use a native EPS security context where the KSI value "000" is included in the NAS key set identifier IE and the EIA0 and EEA0 are included as the selected NAS security algorithms).

The UE shall accept a SECURITY MODE COMMAND message indicating the "null integrity protection algorithm" EIA0 as the selected NAS integrity algorithm only if the message is received for a UE that has a PDN connection for emergency bearer services established or a UE that is establishing a PDN connection for emergency bearer services.

[TS 24.301, clause 5.4.3.5]

If the security mode command cannot be accepted, the UE shall send a SECURITY MODE REJECT message, which shall not be integrity protected. The SECURITY MODE REJECT message contains an EMM cause that typically indicates one of the following cause values:

#23: UE security capabilities mismatch;

#24: security mode rejected, unspecified.

9.1.3.3.3 Test description

9.1.3.3.3.1 Pre-test conditions

System Simulator:

- Cell A.

UE:

None.

Preamble:

- the UE is in state Switched OFF (state 1) according to TS 36.508 [18].

Note: The preamble is executed with non-null NAS security algorithms indicated in the PIXT.

9.1.3.3.3.2 Test procedure sequence

Table 9.1.3.3.3.2-1: Main behaviour

St	Procedure	Message Sequence		TP	Verdict
		U - S	Message		
1	The UE is switched on.	-	-	-	-
2	The UE transmits an ATTACH REQUEST message including a PDN CONNECTIVITY REQUEST message.	-->	ATTACH REQUEST	-	-
3	The SS transmits an AUTHENTICATION REQUEST message with SQN out of range and an invalid MAC code, and, "separation bit" in the AMF field of AUTN = 1. Note: The present TC is simulating a man-in-the-middle security threat scenario. The man-in-the-middle is not expected to have these parameters right.	<--	AUTHENTICATION REQUEST	-	-
4	UE transmits an AUTHENTICATION FAILURE message with EMM cause #20 "MAC failure" or EMM cause #21 "synch failure".	-->	AUTHENTICATION FAILURE	-	-
5	The SS transmits a NAS SECURITY MODE COMMAND message; EIA0 (NULL integrity), EEA0 (NULL ciphering), matched replayed security capabilities. Note: 'matched replayed security capabilities' shall be sent to ensure that the SECURITY MODE REJECT is not sent due to problem with this information.	<--	SECURITY MODE COMMAND	-	-
6	Check: Does the UE transmit a NAS SECURITY MODE REJECT message?	-->	SECURITY MODE REJECT	1	P
7	The SS transmits an IDENTITY REQUEST message for IMSI (Security not applied)	<-	IDENTITY REQUEST	-	-
8	The UE transmits an integrity protected only IDENTITY RESPONSE message.	->	IDENTITY RESPONSE	-	-
-	EXCEPTION: Steps 9a1 to 9a2 describe behaviour that depends on UE configuration; the "lower case letter" identifies a step sequence that take place if the UE has ESM information which needs to be transferred.	-	-	-	-
9a1	The SS transmits an ESM INFORMATION REQUEST message - no integrity protection applied - to initiate exchange of protocol configuration options and/or APN.	<--	ESM INFORMATION REQUEST	-	-
9a2	Check: Does the UE transmit an ESM INFORMATION RESPONSE message? Note: The UE is expected to discard the ESM INFORMATION REQUEST message without security protection.	-->	ESM INFORMATION RESPONSE	1	F
10	The SS transmits an ATTACH ACCEPT message- no integrity protection applied. The ACTIVATE DEFAULT EPS BEARER CONTEXT REQUEST message is piggybacked in ATTACH ACCEPT message	<--	ATTACH ACCEPT	-	-
-	EXCEPTION: Steps 11a1 to 11b13 describe behaviour that depends on the UE action; the "lower case letter" identifies a step sequence that take place if a particular sequential line of behaviour is manifested.	-	-	-	-
11a 1	Check: Does the UE transmit an ATTACH COMPLETE message? Note: The UE is expected to discard the ATTACH ACCEPT message without security protection.	-->	ATTACH COMPLETE	1	F
11b 1	Check: Does the UE transmit an ATTACH REQUEST message? Note 1: After timer T3411 expire the UE is expected to re-attempt to attach.	-->	ATTACH REQUEST	1	P

	Note 2: Steps 11b1 to 11b13 are executed with non-null NAS security algorithms indicated in the PIXIT.				
11b 2- 11b 13	The attach procedure is completed by executing steps 5 to 16 of the UE registration procedure in TS 36.508 [18] sub clause 4.5.2.3.	-	-	-	-
-	At the end of this test procedure sequence, the UE is in end state E-UTRA connected (E2) according to TS 36.508 [18].	-	-	-	-

9.1.3.3.3 Specific message contents

Table 9.1.3.3.3-1: AUTHENTICATION REQUEST (Step 3, Table 9.1.3.3.2-1)

Derivation Path: 36.508 [18], Table 4.7.2-7			
Information Element	Value/remark	Comment	Condition
Authentication parameter AUTN	AMF field set to "AMF _{RESYNCH} "		
	Invalid MAC	SS shall calculate the correct MAC value as specified in TS 33.102 [26] and use any different value, e.g. correct_MAC+5.	

Table 9.1.3.3.3-2: AUTHENTICATION FAILURE (Step 4, Table 9.1.3.3.2-1)

Derivation Path: 36.508 [18], Table 4.7.2-5			
Information Element	Value/remark	Comment	Condition
EMM cause	#20	Note 1	
	#21	Note 1	
Note 1: Any of these two values is allowed.			

Table 9.1.3.3.3-3: SECURITY MODE COMMAND (Step 5, Table 9.1.3.3.2-1)

Derivation path: 36.508 [18], table 4.7.2-19			
Information Element	Value/Remark	Comment	Condition
Selected NAS security algorithms			
Type of integrity protection algorithm	EIA0		
Type of ciphering algorithm	EEA0		
NAS key set identifier			
NAS key set identifier	'000'B		
TSC	'0'B	native security context (for KSI _{ASME})	
Spare half octet	'0000'B		

Table 9.1.3.3.3-4: SECURITY MODE REJECT (Step 6, Table 9.1.3.3.2-1)

Derivation path: 36.508 [18], table 4.7.2-21			
Information Element	Value/Remark	Comment	Condition
EMM cause	#23	Note 1	
	#24	Note 1	
Note 1: Any of these two values is allowed.			

9.1.4 Identification procedure

9.1.4.1 Void

9.1.4.2 Identification procedure / IMEI / IMEISV requested

9.1.4.2.1 Test Purpose (TP)

(1)

```
with { UE in EMM-REGISTERED state / EMM-CONNECTED mode}
ensure that {
  when { UE receives an IDENTITY REQUEST message with IMEI in the IE Identity type }
  then { UE sends an IDENTITY RESPONSE message providing its IMEI }
}
```

(2)

```
with { UE in EMM-REGISTERED state / EMM-CONNECTED mode}
ensure that {
  when { UE receives an IDENTITY REQUEST message with IMEISV in the IE Identity type }
  then { UE sends an IDENTITY RESPONSE message providing its IMEISV }
}
```

9.1.4.2.2 Conformance requirements

References: The conformance requirements covered in the current TC are specified in: TS 24.301, clause 5.4.4.3.

[TS 24.301, clause 5.4.4.3]

A UE shall be ready to respond to an IDENTITY REQUEST message at any time whilst in EMM-CONNECTED mode.

Upon receipt of the IDENTITY REQUEST message the UE shall send an IDENTITY RESPONSE message to the network. The IDENTITY RESPONSE message shall contain the identification parameters as requested by the network.

9.1.4.2.3 Test description

9.1.4.2.3.1 Pre-test conditions

System Simulator:

- cell A.

UE:

none.

Preamble:

- the UE is in state Generic RB established (state 3) on cell A according to TS 36.508 [18].

9.1.4.2.3.2 Test procedure sequence

Table 9.1.4.2.3.2-1: Main behaviour

St	Procedure	Message Sequence		TP	Verdict
		U - S	Message		
1	SS transmits an IDENTITY REQUEST message requesting IMEI in the IE Identity type.	<--	IDENTITY REQUEST	-	-
2	Check: Does the UE respond with an IDENTITY RESPONSE message providing its IMEI?	-->	IDENTITY RESPONSE	1	P
3	SS transmits an IDENTITY REQUEST message requesting the international mobile equipment identity together with the software version number (IMEISV) in the IE Identity type.	<--	IDENTITY REQUEST	-	-
4	Check: Does the UE respond with an IDENTITY RESPONSE message providing its IMEISV?	-->	IDENTITY RESPONSE	2	P

9.1.4.2.3.3 Specific message contents

Table 9.1.4.2.3.3-1: Message IDENTITY REQUEST (step 1, Table 9.1.4.2.3.2-1)

Derivation Path: 36.508, Table 4.7.2-17			
Information Element	Value/Remark	Comment	Condition
Identity Type	0010	IMEI	

Table 9.1.4.2.3.3-2: IDENTITY RESPONSE (step 2, Table 9.1.4.2.3.2-1)

Derivation path: 36.508, Table 4.7.2-18			
Information Element	Value/Remark	Comment	Condition
Mobile Identity			
Type of identity	010	IMEI	
Identity digits	UE's IMEI		

Table 9.1.4.2.3.3-3: Message IDENTITY REQUEST (step 3, Table 9.1.4.2.3.2-1)

Derivation Path: 36.508, Table 4.7.2-17			
Information Element	Value/Remark	Comment	Condition
Identity Type	0011	IMEISV	

Table 9.1.4.2.3.3-4: IDENTITY RESPONSE (step 4, Table 9.1.4.2.3.2-1)

Derivation path: 36.508, Table 4.7.2-18			
Information Element	Value/Remark	Comment	Condition
Mobile Identity			
Type of identity	011	IMEISV	
Identity digits	UE's IMEISV		

9.1.5 EMM information procedure

9.1.5.1 EMM information procedure

9.1.5.1.1 Test Purpose (TP)

(1)

```

with { UE in EMM-REGISTERED state and UE supporting the EMM information message }
ensure that {
  when { UE receives an EMM Information message }

```

```

    then { UE accepts the message and uses the contents to update appropriate information stored
within the UE }
    }

```

9.1.5.1.2 Conformance requirements

References: The conformance requirements covered in the present TC are specified in: TS 24.301, clause 5.4.5.3.

[TS 24.301, clause 5.4.5.3]

When the UE (supporting the EMM information message) receives an EMM INFORMATION message, it shall accept the message and optionally use the contents to update appropriate information stored within the UE.

9.1.5.1.3 Test description

9.1.5.1.3.1 Pre-test conditions

System Simulator:

- cell A.

UE:

The UE is equipped with a USIM containing default values (as per TS 36.508) except for those listed in Table 9.1.5.1.3.1-1

Table 9.1.5.1.3.1-1: USIM configuration

USIM field	Priority	Value
EF _{UST}		Services 19 and 51 are not supported

Preamble:

- the UE is in state Generic RB established (state 3) on cell A according to TS 36.508 [18].

9.1.5.1.3.2 Test procedure sequence

Table 9.1.5.1.3.2-1: Main behaviour

St	Procedure	Message Sequence		TP	Verdict
		U - S	Message		
1	The SS transmits an EMM INFORMATION message.	<--	EMM INFORMATION	-	-
2	Check: Does the UE transmit in the next 5 seconds an EMM STATUS message with cause #97 "message type non-existent or not implemented"?	-->	EMM STATUS	1	F
-	EXCEPTION: Steps 3a1 to 3a4 describe behaviour that depends on the UE capability; the "lower case letter" identifies a step sequence that takes place if a capability is supported.	-	-	-	-
3a1	IF pc_FullNameNetwork THEN Check: Does the UE associate the "full length name of the network" with the MCC and MNC contained in the last visited tracking area identification and is presented to the MS user at the earliest opportunity? (Note 1)	-	-	1	P
3b1	IF pc_ShortNameNetwork THEN Check: Does the UE associate the "abbreviated name of the network" with the MCC and MNC contained in the last visited tracking area identification and is presented to the MS user at the earliest opportunity? (Note 1)	-	-	1	P
3c1	IF pc_LocalTimeZone THEN Check: Does the UE assume that this time zone applies to the tracking area of the current cell and is presented to the MS user at the earliest opportunity? (Note 2)	-	-	1	P
3d1	IF pc_UniversalAndLocalTimeZone THEN Check: Does the UE assume that this time zone applies to the tracking area of the current cell and is presented to the MS user at the earliest opportunity? (Note 2)	-	-	1	P
Note 1: AT command +COPS is assumed to be used for check.					
Note 2: AT command +CCLK is assumed to be used for check.					

9.1.5.1.3.3 Specific message contents

Table 9.1.5.1.3.3-1: EMM INFORMATION (step 1, Table 9.1.5.1.3.2-1)

Derivation Path: 36.508 table 4.7.2-13			
Information Element	Value/Remark	Comment	Condition
Full name for network	"C63A9BED0CB7CB31D98C56B3DD70" O	"FullName12345678", Note	
Short name for network	"5367B85D8EC966" O	"SName123", Note	
Local time zone	"04" O	"GMT+1", Note	
Universal time and local time zone	"01402131832510" O	"2010 12 April 13:38 52s GMT+1", Note	
Network daylight saving time	"01" O	"+1 hour adjustment for Daylight Saving Time", Note	
Note: Hard coded values have been chosen to allow for consistent/comparable SS behaviour.			

Table 9.1.5.1.3.3-2: Message EMM STATUS (step 2, Table 9.1.5.1.3.2-1)

Derivation path: 36.508 table 4.7.2-14			
Information Element	Value/Remark	Comment	Condition
EMM cause	'0110 0001'B	Message type non-existent or not implemented	

9.1.5.2 EMM information procedure not supported by the UE

9.1.5.2.1 Test Purpose (TP)

(1)

```
with { UE in EMM-REGISTERED state }
ensure that {
  when { UE receives an EMM Information message }
  then { UE ignore the contents of the message and return an EMM STATUS message with cause #97
"message type non-existent or not implemented" }
}
```

9.1.5.2.2 Conformance requirements

References: The conformance requirements covered in the present TC are specified in: TS 24.301, clause 5.4.5.3.

[TS 24.301, clause 5.4.5.3]

If the UE does not support the EMM information message the UE shall ignore the contents of the message and return an EMM STATUS message with cause #97 "message type non-existent or not implemented".

9.1.5.2.3 Test description

9.1.5.2.3.1 Pre-test conditions

System Simulator:

- cell A.

UE:

none.

Preamble:

- the UE is in state Generic RB established (state 3) on cell A according to TS 36.508 [18].

9.1.5.2.3.2 Test procedure sequence

Table 9.1.5.2.3.2-1: Main behaviour

St	Procedure	Message Sequence		TP	Verdict
		U - S	Message		
1	The SS transmits an EMM INFORMATION message.	<--	EMM INFORMATION	-	-
2	Check: Does the UE transmit an EMM STATUS message with cause #97 "message type non-existent or not implemented".	-->	EMM STATUS	1	P

9.1.5.2.3.3 Specific message contents

Table 9.1.5.2.3.3-1: EMM INFORMATION (step 1, Table 9.1.5.2.3.2-1)

Derivation Path: 36.508 table 4.7.2-13			
Information Element	Value/remark	Comment	Condition
Full name for network	Not present		
Short name for network	Not present		
Local time zone	Not present		
Universal time and local time zone	Not present		
Network daylight saving time	'00'B	No adjustment for Daylight Saving Time	

Table 9.1.5.2.3.3-2: Message EMM STATUS (step 2, Table 9.1.5.2.3.2-1)

Derivation path: 36.508 table 4.7.2-14			
Information Element	Value/Remark	Comment	Condition
EMM cause	'0110 0001'B	Message type non-existent or not implemented	

9.2 EMM specific procedures

9.2.1 Attach procedure

9.2.1.1 Attach procedure for EPS services

9.2.1.1.0 General

NOTE: Although section 9.2.1.1 is specifically dedicated to Attach for EPS services, it contains also a number of TCs that verify UE behaviour in EPS and Combined attach environments. The extension of the scope of these TCs was decided on a later stage and they were kept in the present section to avoid problems with changing TC numbers which would have been the result if the TCs were moved to another section.

9.2.1.1.1 Attach / Success / Valid GUTI

9.2.1.1.1.1 Test Purpose (TP)

(1)

```
with { the UE is switched-off with a valid USIM inserted and the USIM contains a valid GUTI and last visited registered TAI }
ensure that {
  when { UE is powered on in a cell not belonging to the last visited registered TAI and in a different PLMN }
  then { the UE establishes the RRC connection without S-TMSI, with registeredMME and with the RRC establishmentCause set to 'mo-Signalling' }
}
```

(2)

```
with { UE is switched-off with a valid USIM inserted and the USIM contains a valid GUTI and last visited registered TAI }
ensure that {
  when { UE is powered on in a cell not belonging to the last visited registered TAI }
  then { the UE transmits an ATTACH REQUEST message with the EPS attach type set to "EPS attach", including the GUTI and last visited registered TAI copied from the USIM, and, a PDN CONNECTIVITY REQUEST message with the request type set to "initial request" and not including APN }
}
```

(3)

```
with { UE has sent an ATTACH REQUEST message }
ensure that {
  when { UE receives an ATTACH ACCEPT message with EPS attach result matching the requested service(s), the TAI list the UE is registered to and including an ACTIVATE DEFAULT EPS CONTEXT BEARER message with IE EPS Bearer Identity for the default EPS bearer context activated for the UE }
}
```

```

    then { UE accepts the allocated GUTI, deletes the old TAI list and transmits an ATTACH COMPLETE
message, together with ACTIVATE DEFAULT EPS BEARER CONTEXT ACCEPT message and enters EMM-REGISTERED
state }
}

```

9.2.1.1.1.2 Conformance requirements

References: The conformance requirements covered in the current TC are specified in: TS 24.301, clauses 5.3.1.1, 5.5.1.2.1, 5.5.1.2.2, 5.5.1.2.4, 6.2.2, 6.4.1.3, 6.5.1.2 and Annex D, and TS 36.331, clauses 5.3.3.3 and 5.3.3.4.

[TS 24.301, clause 5.3.1.1]

When the UE is in EMM-IDLE mode and needs to transmit an initial NAS message, the UE shall request the lower layer to establish a RRC connection. In this request to the lower layer the NAS shall provide to the lower layer the RRC establishment cause and the call type as specified in annex D of this specification.

...

For the routing of the initial NAS message to the appropriate MME, the UE NAS provides the lower layers with either the S-TMSI or the registered globally unique MME identifier (GUMMEI) that consists of the PLMN ID, the MME group ID, and the MME code (see 3GPP TS 23.003 [2]) according to the following rules:

- When the UE is registered in the tracking area of the current cell during the NAS signalling connection establishment, the UE NAS shall provide the lower layers with the S-TMSI, but shall not provide the registered MME identifier to the lower layers. Exceptionally, when the UE in EMM-IDLE mode initiates a tracking area updating or combined tracking area updating procedure for load balancing purposes, the UE NAS shall provide the lower layers with neither S-TMSI nor registered MME identifier.
- When the UE is not registered in the tracking area of the current cell during the NAS signalling connection establishment, the UE NAS does not provide the lower layers with the S-TMSI. Instead,
 - a) if the TIN indicates "GUTI" or "RAT-related TMSI", or the TIN is not available, and the UE holds a valid GUTI, the UE NAS shall provide the lower layers with the MME identifier part of the valid GUTI; or
 - b) if the TIN indicates "P-TMSI" and the UE holds a valid P-TMSI and RAI, the UE NAS shall provide the lower layers with the MME identifier part of the mapped GUTI, which is generated from the P-TMSI and RAI.

[TS 24.301, clause 5.5.1.1]

The attach procedure is used to attach to an EPC for packet services in EPS.

The attach procedure is used for two purposes:

- by a UE in PS mode of operation to attach for EPS services only; or
- by a UE in CS/PS mode 1 or CS/PS mode 2 of operation to attach for both EPS and non-EPS services.

With a successful attach procedure, a context is established for the UE in the MME, and a default bearer is established between the UE and the PDN GW, thus enabling always-on IP connectivity to the UE. The network may also initiate the activation of dedicated bearers as part of the attach procedure.

...

[TS 24.301, clause 5.5.1.2.1]

This procedure is used by a UE to attach for EPS services only. When the UE initiates the EPS attach procedure, the UE shall indicate "EPS attach" in the EPS attach type IE.

[TS 24.301, clause 5.5.1.2.2]

In state EMM-DEREGISTERED, the UE initiates the attach procedure by sending an ATTACH REQUEST message to the MME, starting timer T3410 and entering state EMM-REGISTERED-INITIATED (see example in figure 5.5.1.2.2.1). If timer T3402 is currently running, the UE shall stop timer T3402. If timer T3411 is currently running, the UE shall stop timer T3411.

If the UE supports neither A/Gb mode nor Iu mode, the UE shall handle the Old GUTI or IMSI IE in the ATTACH REQUEST message as follows:

- The UE shall include in the ATTACH REQUEST message a valid GUTI together with the last visited registered TAI, if available. If there is no valid GUTI available, the UE shall include the IMSI in the ATTACH REQUEST message.

...

The UE shall send the ATTACH REQUEST message together with a PDN CONNECTIVITY REQUEST message contained in the ESM message container information element to request PDN connectivity.

...

If a valid NAS security context exists, the UE shall integrity protect the ATTACH REQUEST message combined with the PDN CONNECTIVITY REQUEST message. When the UE does not have a valid NAS security context, the ATTACH REQUEST message combined with the PDN CONNECTIVITY REQUEST message is not integrity protected.

...

[TS 24.301, clause 5.5.1.2.4]

...

If the ATTACH ACCEPT message contains a GUTI, the UE shall use this GUTI as the new temporary identity. The UE shall delete its old GUTI and store the new assigned GUTI. If no GUTI has been included by the MME in the ATTACH ACCEPT message, the old GUTI, if any available, shall be kept.

...

When the UE receives the ATTACH ACCEPT message combined with the ACTIVATE DEFAULT EPS BEARER CONTEXT REQUEST message, it shall forward the ACTIVATE DEFAULT EPS BEARER CONTEXT REQUEST message to the ESM sublayer. Upon receipt of an indication from the ESM sublayer that the default EPS bearer context has been activated, the UE shall send an ATTACH COMPLETE message together with an ACTIVATE DEFAULT EPS BEARER CONTEXT ACCEPT message contained in the ESM message container information element to the network.

...

[TS 24.301, clause 6.2.2]

The UE shall set the PDN type IE in the PDN CONNECTIVITY REQUEST message based on its IP stack configuration as follows:

- a) A UE, which is IPv6 and IPv4 capable and
 - has not been allocated an IP address for this APN, shall set the PDN type IE to IPv4v6.
 - has been allocated an IPv4 address for this APN and received the ESM cause #52, "single address bearers only allowed", and is requesting an IPv6 address, shall set the PDN type IE to IPv6.
 - has been allocated an IPv6 address for this APN and received the ESM cause #52, "single address bearers only allowed", and is requesting an IPv4 address, shall set the PDN type IE to IPv4.
- b) A UE, which is only IPv4 capable, shall set the PDN type IE to IPv4.
- c) A UE, which is only IPv6 capable, shall set the PDN type IE to IPv6.
- d) When the IP version capability of the UE is unknown in the UE (as in the case when the MT and TE are separated and the capability of the TE is not known in the MT), the UE shall set the PDN type IE to IPv4v6.

...

[TS 24.301, clause 6.4.1.3]

Upon receipt of the ACTIVATE DEFAULT EPS BEARER CONTEXT REQUEST message, the UE shall send an ACTIVATE DEFAULT EPS BEARER CONTEXT ACCEPT message and enter the state BEARER CONTEXT ACTIVE. When the default bearer is activated as part of the attach procedure, the UE shall send the ACTIVATE DEFAULT EPS BEARER CONTEXT ACCEPT message together with ATTACH COMPLETE message. When the

default bearer is activated as the response to the stand-alone PDN CONNECTIVITY REQUEST message, the UE shall send the ACTIVATE DEFAULT EPS BEARER CONTEXT ACCEPT message alone.

The UE checks the PTI in the ACTIVATE DEFAULT EPS BEARER CONTEXT REQUEST message to identify the UE requested PDN connectivity procedure to which the default bearer context activation is related (see subclause 6.5.1).

...

[TS 24.301, clause 6.5.1.2]

When the PDN CONNECTIVITY REQUEST message is sent together with an ATTACH REQUEST message, the UE shall not include the APN.

NOTE: If the UE needs to provide PCO which require ciphering or provide an APN, or both, during the attach procedure, the ESM information transfer flag is included in the PDN CONNECTIVITY REQUEST. The MME then at a later stage in the PDN connectivity procedure initiates the ESM information request procedure in which the UE can provide the MME with PCO or APN or both.

...

The UE shall set the request type to "initial request" when the UE is establishing connectivity to a PDN for the first time, i.e. when it is an initial attach to that PDN. The UE shall set the request type to "handover" when the connectivity to a PDN is established upon handover from a non-3GPP access network and the UE was connected to that PDN before the handover to the 3GPP access network.

...

[TS 24.301, Annex D]

...

Table D.1.1: Mapping of NAS procedure to establishment cause and call type

NAS procedure	RRC establishment cause (according 3GPP TS 36.331 [22])	Call type
Attach	MO signalling (See Note 1)	"originating signalling"
...		
Note 1: For these NAS procedures initiated by UEs of access class 12, 13 or 14 in their home country, the RRC establishment cause will be set to "High priority access AC 11 – 15". For this purpose the home country is defined as the country of the MCC part of the IMSI, see 3GPP TS 22.011 [1A]. For these NAS procedures initiated by UE of access class 11 or 15 in their HPLMN or (if the EHPLMN list is not present or is empty) EHPLMN, (if the EHPLMN list is present) the RRC establishment cause will be set to "High priority access AC 11 – 15".		

[TS 36.331, clause 5.3.3.3 "Actions related to transmission of *RRCCConnectionRequest* message"]

The UE shall set the contents of *RRCCConnectionRequest* message as follows:

- 1> set the *ue-Identity* as follows:
 - 2> if upper layers provide an S-TMSI:
 - 3> set the *ue-Identity* to the value received from upper layers;
 - 2> else
 - 3> draw a random value in the range 0 .. 2⁴⁰-1 and set the *ue-Identity* to this value;

NOTE 1 Upper layers provide the S-TMSI if the UE is registered in the TA of the current cell.

- 1> Set the *establishmentCause* in accordance with the information received from upper layers;

[TS 36.331 clause 5.3.3.4]

...

The UE shall:

...

1> set the content of *RRCCConnectionSetupComplete* message as follows:

2> set the *selectedPLMN-Identity* to the PLMN selected by upper layers (see TS 23.122 [11], TS 24.301 [35]) from the PLMN(s) included in the *plmn-IdentityList* in *SystemInformationBlockType1*;

2> if upper layers provide the 'Registered MME', include and set the *registeredMME* as follows:

3> if the PLMN identity of the 'Registered MME' is different from the PLMN selected by the upper layers:

4> include the *plmnIdentity* in the *registeredMME* and set it to the value of the PLMN identity in the 'Registered MME' received from upper layers;

3> set the *mmegi* and the *mmec* to the value received from upper layers;

...

2> submit the *RRCCConnectionSetupComplete* message to lower layers for transmission, upon which the procedure ends;

9.2.1.1.1.3 Test description

9.2.1.1.1.3.1 Pre-test conditions

System Simulator:

- cell A.

UE:

- the UE is configured to initiate EPS attach;
- The UE is previously registered on E-UTRAN, and when on E-UTRAN, the UE is last authenticated and registered on cell H using default message contents according to TS 36.508 [18].

NOTE: For cell A, (MCC, MNC, TAI) is (MCC stored in EF_{IMSI}, 02, TAI-8).

Preamble:

- the UE is in state Switched OFF (state 1) according to TS 36.508 [18].

9.2.1.1.1.3.2 Test procedure sequence

Table 9.2.1.1.1.3.2-1: Main behaviour

St	Procedure	Message Sequence		TP	Verdict
		U - S	Message		
1	The UE is switched on.	-	-	-	-
2	Check: Does the UE transmit an <i>RRCCoNNECTIONRequest</i> message not including S-TMSI and with <i>establishmentCause</i> set to 'mo-Signalling'?	-	-	1	P
3	The SS transmits an <i>RRCCoNNECTIONSetup</i> message.	-	-	-	-
4	Check: Does the UE transmit an <i>RRCCoNNECTIONSetupComplete</i> message including PLMN ID, MME group ID and MME code with ATTACH REQUEST message including a GUTI and a PDN CONNECTIVITY REQUEST message?	-->	ATTACH REQUEST	2	P
5	The SS transmits an AUTHENTICATION REQUEST message to initiate the EPS authentication and AKA procedure.	<--	AUTHENTICATION REQUEST	-	-
6	The UE transmits an AUTHENTICATION RESPONSE message and establishes mutual authentication.	-->	AUTHENTICATION RESPONSE	-	-
7	The SS transmits a NAS SECURITY MODE COMMAND message to activate NAS security.	<--	SECURITY MODE COMMAND	-	-
8	The UE transmits a NAS SECURITY MODE COMPLETE message and establishes the initial security configuration.	-->	SECURITY MODE COMPLETE	-	-
-	EXCEPTION: Steps 9a1 to 9a2 describe behaviour that depends on UE configuration the "lower case letter" identifies a step sequence that take place depending on the last sent by the UE PDN CONNECTIVITY REQUEST message, IE Protocol configuration options setting.	-	-	-	-
9a1	IF the UE sets the ESM information transfer flag in the last PDN CONNECTIVITY REQUEST message THEN the SS transmits an ESM INFORMATION REQUEST message to initiate exchange of protocol configuration options and/or APN.	<--	ESM INFORMATION REQUEST	-	-
9a2	The UE transmits an ESM INFORMATION RESPONSE message to transfer protocol configuration options and/or APN.	-->	ESM INFORMATION RESPONSE	-	-
10	SS responds with ATTACH ACCEPT message including a valid TAI list. The ACTIVATE DEFAULT EPS BEARER CONTEXT REQUEST message is piggybacked in ATTACH ACCEPT message	<--	ATTACH ACCEPT	-	-
-	EXCEPTION: In parallel to the event described in step 11 below the generic procedure for IP address allocation in the U-plane specified in TS 36.508 subclause 4.5A.1 takes place performing IP address allocation in the U-plane if requested by the UE.	-	-	-	-
11	Check: Does the UE transmit an ATTACH COMPLETE message including an ACTIVATE DEFAULT EPS BEARER CONTEXT ACCEPT message?	-->	ATTACH COMPLETE	2	P
12	Void	-	-	-	-
13	The SS releases the RRC connection.	-	-	-	-
14	Check: Does the test result of CALL generic procedure [18] clause 6.4.2.4 indicate that the UE is in E-UTRA EMM-REGISTERED state on Cell A?	-	-	3	-

-	At the end of this test procedure sequence, the UE is in end state E-UTRA idle (E1) according to TS 36.508.	-	-	-	-
---	---	---	---	---	---

9.2.1.1.1.3.3 Specific message contents

Table 9.2.1.1.1.3.3-1: Message *RRCConnectionRequest* (step 2, Table 9.2.1.1.1.3.2-1)

Derivation path: 36.508 table 4.6.1-16			
Information Element	Value/Remark	Comment	Condition
RRCConnectionRequest ::= SEQUENCE {			
criticalExtensions CHOICE {			
rrcConnectionRequest-r8 SEQUENCE {			
ue-Identity CHOICE {			
randomValue	Not checked		
}			
establishmentCause	mo-Signalling		
}			
}			
}			

Table 9.2.1.1.1.3.3-2: Message *RRCConnectionSetupComplete* (step 4, Table 9.2.1.1.1.3.2-1)

Derivation path: 36.508 table 4.6.1-18			
Information Element	Value/Remark	Comment	Condition
RRCConnectionSetupComplete ::= SEQUENCE {			
criticalExtensions CHOICE {			
c1 CHOICE {			
rrcConnectionSetupComplete-r8 SEQUENCE {			
registeredMME {			
plmn-Identity	PLMN ID(MCC as stored in EF _{IMSI} on the test USIM card and MNC 02)		
mmegi	1000000000001000	Bit 0 is LSB	
mmec	00000001	Bit 0 is LSB	
}			
}			
}			
}			
}			

Table 9.2.1.1.1.3.3-3: Message ATTACH REQUEST (step 4, Table 9.2.1.1.1.3.2-1)

Derivation path: TS 36.508 table 4.7.2-4			
Information Element	Value/Remark	Comment	Condition
Old GUTI or IMSI	GUTI(belonging to PLMN with same MCC as stored in EF _{IMSI} on the test USIM card and MNC 02)	GUTI copied from USIM Old and valid GUTI is included by the UE	
ESM message container	PDN CONNECTIVITY REQUEST message to request PDN connectivity to the default PDN		
Last visited registered TAI	TAI8	GUTI copied from USIM If available, the last TAI is included by UE and will be used to establish a good list of TAIs in subsequent ATTACH ACCEPT message.	

Table 9.2.1.1.1.3.3-4: Void**Table 9.2.1.1.1.3.3-5: Message ATTACH ACCEPT (step 10, Table 9.2.1.1.1.3.2-1)**

Derivation path: TS 36.508 table 4.7.2-1			
Information Element	Value/Remark	Comment	Condition
ESM message container	Contains the ACTIVATE DEFAULT EPS BEARER CONTEXT REQUEST message specified in table 9.2.1.1.1.3.3-6.		

Table 9.2.1.1.1.3.3-6: Void**Table 9.2.1.1.1.3.3-7: Message ACTIVATE DEFAULT EPS BEARER CONTEXT ACCEPT (step 11, Table 9.2.1.1.1.3.2-1)**

Derivation path: TS 36.508 table 4.7.3-4			
Information Element	Value/Remark	Comment	Condition
EPS bearer identity	Default EBId	Same value as in ACTIVATE DEFAULT EPS BEARER CONTEXT REQUEST	
Procedure transaction identity	PTI-0	Same value as in PDN CONNECTIVITY REQUEST	

9.2.1.1.1a Attach Procedure / Success / Last visited TAI, TAI list and equivalent PLMN list handling

9.2.1.1.1a.1 Test Purpose (TP)

(1)

```
with { UE attached to the network with a valid USIM inserted and a valid GUTI }
ensure that {
  when { UE is powered off and then powered on }
  then { the UE transmits an ATTACH REQUEST message with the EPS attach type set to "initial EPS
attach", including GUTI and last visited registered TAI and a PDN CONNECTIVITY REQUEST message with
the request type set to "initial attach" and not including APN }
}
```

(2)

```
with { UE having a valid NAS security context and the UE switched-off }
ensure that {
  when { UE is powered on }
  then { the UE transmits an integrity protected ATTACH REQUEST message combined with the PDN
CONNECTIVITY REQUEST message }
}
```

(3)

```
with { UE has sent an ATTACH REQUEST message }
ensure that {
  when { UE receives an ATTACH ACCEPT message with EPS attach result matching the requested
service(s), the TAI list the UE is registered to, a set of equivalent PLMNs matching the PLMNs
within the TAI list, and including an ACTIVATE DEFAULT EPS CONTEXT BEARER message with IE EPS Bearer
Identity for the default EPS bearer context activated for the UE }
  then { UE deletes the old TAI list, stores the new TAI list, and does not perform a TAU while
moving within this set of TAs }
}
```

(4)

```
with { UE has sent an ATTACH REQUEST message }
ensure that {
  when { UE receives an ATTACH ACCEPT message with EPS attach result matching the requested
service(s), the TAI list the UE is registered to, a set of equivalent PLMNs matching the PLMNs
within the TAI list, and including an ACTIVATE DEFAULT EPS CONTEXT BEARER message with IE EPS Bearer
Identity for the default EPS bearer context activated for the UE }
  then { UE deletes the old TAI list, stores the new TAI list, and performs a TAU when moving out
of this set of TAs }
}
```

(5)

```
with { UE has received a set of equivalent PLMNs in an ATTACH ACCEPT message }
ensure that {
  when { the UE has been switched off; then switched on; and then the UE receives an ATTACH_ACCEPT
message with a new set of equivalent PLMNs }
  then { UE deletes the old equivalent PLMN list, and uses the new equivalent PLMN list }
}
```

9.2.1.1.1a.2 Conformance requirements

References: The conformance requirements covered in the current TC are specified in: TS 24.301, clauses 5.3.3, 5.5.1.2.2, 5.5.1.2.4, 6.5.1.2 and 9.9.3.33, and TS 36.304 clause 4.3.

[TS 24.301, clause 5.3.3]

The UE shall store a list of equivalent PLMNs. These PLMNs shall be regarded by the UE as equivalent to each other for PLMN selection and cell selection/re-selection. The same list is used by EMM, GMM and MM.

The UE shall update or delete this list at the end of each attach or tracking area updating procedure. The stored list consists of a list of equivalent PLMNs as downloaded by the network plus the PLMN code of the registered PLMN that downloaded the list. When the UE is switched off, it shall keep the stored list so that it can be used for PLMN selection

after switch on. The UE shall delete the stored list if the USIM is removed. The maximum number of possible entries in the stored list is 16.

[TS 24.301, clause 5.5.1.2.2]

In state EMM-DEREGISTERED, the UE initiates the attach procedure by sending an ATTACH REQUEST message to the MME, starting timer T3410 and entering state EMM-REGISTERED-INITIATED (see figure 5.5.1.2.2.1).

...

The UE shall include in the ATTACH REQUEST message a valid GUTI together with the last visited registered TAI, if available. If there is no valid GUTI available, the UE shall include the IMSI in the ATTACH REQUEST message.

The UE shall send the ATTACH REQUEST message together with a PDN CONNECTIVITY REQUEST message to request PDN connectivity to the default PDN (see subclause 6.5.1).

...

If a valid NAS security context exists, the UE shall integrity protect the ATTACH REQUEST message combined with the PDN CONNECTIVITY REQUEST message.

...[TS 24.301, clause 5.5.1.2.4]

...

The MME shall assign and include the TAI list the UE is registered to in the ATTACH ACCEPT message. The UE, upon receiving an ATTACH ACCEPT message, shall delete its old TAI list and store the received TAI list.

...

If the ATTACH ACCEPT message contains a GUTI, the UE shall use this GUTI as the new temporary identity and set its TIN to "GUTI". The UE shall delete its old GUTI and store the new assigned GUTI. If no GUTI has been included by the MME in the ATTACH ACCEPT message, the old GUTI, if any available, shall be kept.

...

The MME may also include a list of equivalent PLMNs in the ATTACH ACCEPT message. Each entry in the list contains a PLMN code (MCC+MNC). The UE shall store the list as provided by the network, after having removed from the list any PLMN code that is already in the list of forbidden PLMNs. In addition, the UE shall add to the stored list the PLMN code of the registered PLMN that sent the list. The UE shall replace the stored list on each receipt of the ATTACH ACCEPT message. If the ATTACH ACCEPT message does not contain a list, then the UE shall delete the stored list.

...

[TS 24.301, clause 5.5.3.2.2, "Normal and periodic tracking area updating procedure initiation"]

The UE in state EMM-REGISTERED shall initiate the tracking area updating procedure by sending a TRACKING AREA UPDATE REQUEST message to the MME,

- a) when the UE detects entering a tracking area that is not in the list of tracking areas that the UE previously registered in the MME;

...

[TS 24.301, clause 6.5.1.2, "UE requested PDN connectivity procedure initiation"]

In order to request connectivity to the default PDN, the UE shall not include any APN in the PDN CONNECTIVITY REQUEST message.

...

[TS 24.301, clause 9.9.3.33, "Tracking area identity list"]

...

The Tracking area identity list is a type 4 information element, with a minimum length of 8 octets and a maximum length of 98 octets. The list can contain a maximum of 16 different tracking area identities.

...

The value part of the Tracking area identity list information element consists of one or several partial tracking area identity lists. The length of each partial tracking area identity list can be determined from the 'type of list' field and the 'number of elements' field in the first octet of the partial tracking area identity list.

...

Partial tracking area identity list: Type of list (octet 1) Bits 7 6 0 0 list of TACs belonging to one PLMN, with non-consecutive TAC values 0 1 list of TACs belonging to one PLMN, with consecutive TAC values 1 0 list of TAIs belonging to different PLMNs
--

...

For type of list = "001" and number of elements = k: octet 2 to 4 contain the MCC+MNC, and octet 5 and 6 contain the TAC of the first TAI belonging to the partial list. The TAC values of the other k-1 TAIs are TAC+1, TAC+2, ..., TAC+k-1.
--

...

The MNC shall consist of 2 or 3 digits.

...

[TS 36.304, clause 4.3]

...

suitable cell:

A "suitable cell" is a cell on which the UE may camp on to obtain normal service. Such a cell shall fulfil all the following requirements.

- The cell is part of either:
 - the selected PLMN, or:
 - the registered PLMN, or:
 - a PLMN of the Equivalent PLMN list
 according to the latest information provided by NAS:

...

9.2.1.1.1a.3 Test description

9.2.1.1.1a.3.1 Pre-test conditions

System Simulator:

NOTE: while this test describes the uses of 8 cells, it is intended that this test only requires 2 cells to be active at any one instant.

Table 9.2.1.1.1a-1: Cell TAI values

Cell	MCC	MNC	TAC (hex)	Remark	Freq	List of frequencies in SIB5	Remark
A	001	01	0002	2 digit MNC	f1	f2, f3	HPLMN
I	310	102	0002	3 digit MNC	f3	f1, f2	See Note 1
B	001	01	0001		f1	f2, f3	HPLMN
C	001	01	0027		f1	f2, f3	HPLMN
G	004	07	fff0		f2	f1, f3	See Note 2
H	004	07	fff9		f2	f1, f3	See Note 2
K	316	002	0003	3 digit MNC	f3	f1, f2	See Note 1
E	004	02	0003		f2	f1, f3	See Note 2

Note 1: Cell I and Cell K do not co-exist; the same frequency f3 is used.
Note 2: Cell E and Cells G and H do not co-exist; the same frequency f2 is used.

- System information combination 3 as defined in TS 36.508[18] clause 4.4.3.1 is used in E-UTRA cells;
- with the exception of the Physical Cell Identity and the list of frequencies in SIB5, all other parameters for these cells are the same as defined for cell I in TS 36.508 [18];
- the power level of cell A is the Serving Cell level defined in table 6.2.2.1-1 of TS 36.508 [18];
- the power levels of cells B to K are set to the Non-suitable Off level defined in table 6.2.2.1-1 of TS 36.508 [18].

Table 9.2.1.1.1a-2: Time instances of cell power level and parameter changes

	Parameter	Unit	Cell A	Cell I	Cell B	Cell C	Cell G	Cell H	Cell K	Cell E
T0	Cell-specific RS EPRE	dBm/15kHz	[-85]	Off	Off	Off	Off	Off	Off	Off
T1	Cell-specific RS EPRE	dBm/15kHz	[-97]	[-85]	Off	Off	Off	Off	Off	Off
T2	Cell-specific RS EPRE	dBm/15kHz	Off	Off	[-85]	Off	Off	Off	Off	Off
T3 (N=3)	Cell-specific RS EPRE	dBm/15kHz	Off	Off	[-97]	[-85]	Off	Off	Off	Off
T3 (N=4)	Cell-specific RS EPRE	dBm/15kHz	Off	Off	Off	[-97]	[-85]	Off	Off	Off
T3 (N=5)	Cell-specific RS EPRE	dBm/15kHz	Off	Off	Off	Off	[-97]	[-85]	Off	Off
T3 (N=6)	Cell-specific RS EPRE	dBm/15kHz	Off	Off	Off	Off	Off	[-97]	[-85]	Off
T3 (N=7)	Cell-specific RS EPRE	dBm/15kHz	Off	Off	Off	Off	Off	Off	[-97]	[-85]
T4	Cell-specific RS EPRE	dBm/15kHz	Off	[-85]	Off	Off	Off	Off	Off	[-97]
T5	Cell-specific RS EPRE	dBm/15kHz	[-85]	Off	Off	Off	Off	Off	Off	[-97]

UE:

- the UE is previously registered on E-UTRAN, and when on E-UTRAN, the UE is last authenticated and registered on cell A using default message contents according to TS 36.508 [18].

Preamble:

- the UE is in state Switched OFF (state 1) according to TS 36.508 [18].

9.2.1.1.1a.3.2 Test procedure sequence

Table 9.2.1.1.1a.3.2-1: Main behaviour

St	Procedure	Message Sequence		TP	Verdict
		U – S	Message		
-	The following messages are to be observed on Cell A unless explicitly stated otherwise.	-	-	-	-
1	The UE is switched on.	-	-	-	-
2	The UE transmits an ATTACH REQUEST message on cell A including a PDN CONNECTIVITY REQUEST message	-->	ATTACH REQUEST		
3	The SS transmits an AUTHENTICATION REQUEST message to initiate the EPS authentication and AKA procedure.	<--	AUTHENTICATION REQUEST	-	-
4	The UE transmits an AUTHENTICATION RESPONSE message and establishes mutual authentication.	-->	AUTHENTICATION RESPONSE	-	-
5	The SS transmits a NAS SECURITY MODE COMMAND message to activate NAS security.	<--	SECURITY MODE COMMAND	-	-
6	The UE transmits a NAS SECURITY MODE COMPLETE message and establishes the initial security configuration.	-->	SECURITY MODE COMPLETE	-	-
-	EXCEPTION: Steps 7a1 to 7a2 describe behaviour that depends on UE configuration; the "lower case letter" identifies a step sequence that take place if the UE has ESM information which needs to be transferred.	-	-	-	-
7a1	IF the UE sets the ESM information transfer flag in the last PDN CONNECTIVITY REQUEST message THEN the SS transmits an ESM INFORMATION REQUEST message to initiate exchange of protocol configuration options and/or APN.	<--	ESM INFORMATION REQUEST	-	-
7a2	The UE transmits the ESM INFORMATION REQUEST message to transfer protocol configuration options and/or APN.	-->	ESM INFORMATION RESPONSE	-	-
8	SS responds with ATTACH ACCEPT message including a valid TAI list containing the TAIs of Cell A and Cell I; with PLMN ID of Cell A included in the GUTI; and with the PLMN ID of Cell I included in the Equivalent PLMNs IE. The ACTIVATE DEFAULT EPS BEARER CONTEXT REQUEST message is piggybacked in ATTACH ACCEPT message	<--	ATTACH ACCEPT	-	-
-	EXCEPTION: In parallel to the event described in step 9 below the generic procedure for IP address allocation in the U-plane specified in TS 36.508 subclause 4.5A.1 takes place performing IP address allocation in the U-plane if requested by the UE.	-	-	-	-
9	The UE transmits an ATTACH COMPLETE message including an ACTIVATE DEFAULT EPS BEARER CONTEXT ACCEPT message.	-->	ATTACH COMPLETE	-	-
10	Void	-	-	-	-
11	The SS releases the RRC connection.	-	-	-	-
12	The signal strength of Cell I is raised to that of the Serving Cell and that of Cell A is lowered to that of a Suitable Neighbour Cell as defined in table 6.2.2.1-1 of TS 36.508 [18]. Note: Cell A is still suitable but the UE shall select Cell I				
-	The following messages are to be observed on Cell I unless explicitly stated otherwise.	-	-	-	-
13	Wait 70 seconds for mobile to camp on Cell I				
14	If possible (see ICS) switch off is performed or				

	the USIM is removed. Otherwise the power is removed.				
-	EXCEPTION: Step 15 describes behaviour that depends on the UE capability.				
15	If pc_SwitchOnOff or pc_USIM_Removal then Check: Does the UE send DETACH REQUEST message?	-->	DETACH REQUEST	3	P
16	Cells A and I are set to the Non-suitable "Off" level and Cell B is set to the Serving Cell level.				
-	The following messages are to be observed on Cell B unless explicitly stated otherwise.	-	-	-	-
17	The UE is brought back to operation or the USIM is inserted.				
18	Check: Does the UE send an integrity protected ATTACH REQUEST message (including a PDN CONNECTIVITY REQUEST message) with the last visited TAI correctly indicating the TAI of cell I; the GUTI allocated in step 8 and the KSI _{ASME} allocated in step 3?	-->	ATTACH REQUEST	1, 2	P
18 A	Void	-	-	-	-
18 B	Void	-	-	-	-
-	EXCEPTION: Steps 18a1 to 18a2 describe behaviour that depends on UE configuration; the "lower case letter" identifies a step sequence that take place if the UE has ESM information which needs to be transferred.	-	-	-	-
18a 1	IF the UE sets the ESM information transfer flag in the last PDN CONNECTIVITY REQUEST message THEN the SS transmits an ESM INFORMATION REQUEST message to initiate exchange of protocol configuration options and/or APN.	<--	ESM INFORMATION REQUEST	-	-
18a 2	The UE transmits the ESM INFORMATION REQUEST message to transfer protocol configuration options and/or APN.	-->	ESM INFORMATION RESPONSE	-	-
19	The SS sends an ATTACH ACCEPT message allocating 16 TAIs and an aligned set of equivalent PLMNs. The ACTIVATE DEFAULT EPS BEARER CONTEXT REQUEST message is piggybacked in ATTACH ACCEPT message.	<--	ATTACH ACCEPT		
-	EXCEPTION: In parallel to the event described in step 20 below the generic procedure for IP address allocation in the U-plane specified in TS 36.508 subclause 4.5A.1 takes place performing IP address allocation in the U-plane if requested by the UE.	-	-	-	-
20	The UE sends ATTACH COMPLETE including an ACTIVATE DEFAULT EPS BEARER CONTEXT ACCEPT message.	-->	ATTACH COMPLETE		
21	Void	-	-		
22	The SS releases the RRC connection.	-	-	-	-
23	The SS waits 5seconds	-	-	-	-
-	EXCEPTION steps 24 to 26 are repeated for N = 3 to N = 7 with cells C,G,H,K,E according to T3 in table 9.2.1.1.1a-2.				
24	Cell power levels are set according to T3 and the value of N.				
25	Check: Does the UE transmit a TRACKING AREA UPDATE REQUEST message in the next 70 seconds?	-->	TRACKING AREA UPDATE REQUEST	3	F
26	Using the procedure of clause 6.4.2.2 of TS 36.508 [18], Check: Does the UE camp on the strongest			3	P

	cell ?				
27	Cell K is set to the Non-suitable "Off" level. The signal strength of Cell E is lowered to that of a Suitable Neighbour Cell and that of Cell I is raised to the Serving Cell level. Note: the new list of equivalent PLMNs allocated in step 19 means that list of equivalent PLMNs allocated in step 8 should have been deleted. Hence the PLMN of Cell I shall not be selected by a cell reselection process, and the UE shall remain camped on Cell E.				
28	Check: Does the UE transmit a TRACKING AREA UPDATE REQUEST message on cell I in the next 70 seconds?	-->	TRACKING AREA UPDATE REQUEST	5	F
29	Using the procedure of clause 6.4.2.2 of TS 36.508 [18], page the UE on Cells E and I. Check: Does the UE camp on cell E and not on Cell I?			5	P
30	Cell I is set to the Non-suitable "Off" level. The signal strength of Cell A is raised to the Serving Cell level such that the UE shall select Cell A.				
31	Check: Does the UE transmit a TRACKING AREA UPDATE REQUEST message on cell A with the last visited TAI set to the TAI of cell E; the GUTI allocated in step 8 and the KSI _{ASME} allocated in step 3?	-->	TRACKING AREA UPDATE REQUEST	4	P
32	SS responds with TRACKING AREA UPDATE ACCEPT message	<--	TRACKING AREA UPDATE ACCEPT	-	-
33	The UE transmits a TRACKING AREA UPDATE COMPLETE message	-->	TRACKING AREA UPDATE COMPLETE	-	-
-	At the end of this test procedure sequence, the UE is in end state E-UTRA connected (E2_T3440) according to TS 36.508.	-	-	-	-

9.2.1.1.1a.3.3 Specific message contents

Table 9.2.1.1.1a.3.3-1: Message ATTACH ACCEPT (step 8, Table 9.2.1.1.1a.3.2-1)

Derivation path: 36.508 table 4.7.2-1			
Information Element	Value/Remark	Comment	Condition
TAI list		List of 2 TAIs	
Length of tracking area identity list contents	11	The value in the length field	
Number of elements	00001		
Type of list	010	More than one PLMN	
Partial tracking area identity list	First TAI = TAI of Cell I; Second TAI = TAI of Cell A		
GUTI	MCC=001, MNC=01, MMEGI = 1, MMEC= 1, M-TMSI arbitrarily allocated but compliant to rules of TS 23.003 sub clause 2.8	Includes PLMN ID of cell A	
Equivalent PLMNs	MCC=310, MNC=102	PLMN ID of cell I	

Table 9.2.1.1.1a.3.3-2: Message ATTACH REQUEST (step 18, Table 9.2.1.1.1a.3.2-1)

Derivation path: 36.508 table 4.7.2-4			
Information Element	Value/Remark	Comment	Condition
Sent in SECURITY PROTECTED NAS MESSAGE with valid integrity check			
Old GUTI or IMSI	GUTI allocated in step 8		
NAS key set identifier	KSI allocated in step 3		
Last visited registered TAI	TAI of cell 2		

Table 9.2.1.1.1a.3.3-3: Message ATTACH ACCEPT (step 19, Table 9.2.1.1.1a.3.2-1)

Derivation path: 36.508 table 4.7.2-1			
Information Element	Value/Remark	Comment	Condition
TAI list		Contains 3 separate partial tracking area ID lists	
Length of tracking area identity list contents	32	The decimal value of the value in the length field	
Type of first partial tracking area identity list	010	More than one PLMN	
Number of elements	00010	3 elements	
First TAI	MCC = 004, MNC = 02, TAC = 0003		
Second TAI	MCC = 005, MNC = 002, TAC = 0003		
Third TAI	MCC = 316, MNC = 002, TAC = 0003		
Type of second partial tracking area identity list	001	Consecutive TACs on same PLMN	
Number of consecutive TACS	01001	10 elements	
TAI	MCC = 004 MNC = 07 TAC = fff0	TAI with lowest numbered TAC	
Type of third partial tracking area identity list	000	Individual TACs on same PLMN	
Number of elements	00010	3	
MCC	MCC = 001		
MNC	MNC = 01		
First TAC	TAC = 0001		
Second TAC	TAC = 0005		
Third TAC	TAC = 0027		
GUTI	MCC=001, MNC = 01, MMEGI = 64000, MMEC= 127, M-TMSI arbitrarily allocated but compliant to rules of TS 23.003 sub clause 2.8	Includes PLMN ID of cell B.	
Equivalent PLMNs	MCC=004, MNC=02; MCC=004, MNC=03; MCC=004, MNC=07; MCC=316, MNC=002;	4 equivalent PLMNs	

Table 9.2.1.1.1a.3.3-4: Message TRACKING AREA UPDATE REQUEST (step 37, Table 9.2.1.1.1a.3.2-1)

Derivation path: 36.508 table 4.7.2-27			
Information Element	Value/Remark	Comment	Condition
Old GUTI	GUTI allocated in step 19		
NAS key set identifier <small>ASME</small>	Same as allocated in step 3		
Last visited registered TAI	TAI of cell 8		

9.2.1.1.1b Attach Procedure / Success / Last visited TAI, TAI list and equivalent PLMN list handling / Single Frequency operation

9.2.1.1.1b.1 Test Purpose (TP)

Same Test Purpose as in clause 9.2.1.1.1a.1

9.2.1.1.1b.2 Conformance requirements

Same Conformance requirements as in clause 9.2.1.1.1a.2

9.2.1.1.1b.3 Test description

9.2.1.1.1b.3.1 Pre-test conditions

System Simulator:

- Eight intra-frequency cells with the PLMNs identified in the test by the identifiers in Table 9.2.1.1.1b-1.

NOTE: while this test describes the uses of 8 cells, it is intended that this test only requires 2 cells to be active at any one instant.

Table 9.2.1.1.1b-1: Cell TAI values

Cell	MCC	MNC	TAC (hex)	Remark	Freq	Remark
A	001	01	0002	2 digit MNC	f1	HPLMN
L	310	102	0002	3 digit MNC	f1	
B	001	01	0001		f1	HPLMN
C	001	01	0027		f1	HPLMN
G	004	07	fff0		f1	
H	004	07	fff9		f1	
K	316	002	0003	3 digit MNC	f1	
E	004	02	0003		f1	

- System information combination 2 as defined in TS 36.508[18] clause 4.4.3.1 is used in E-UTRA cells;
- with the exception of the Physical Cell Identity, all other parameters for these cells are the same as defined for cell 1 in TS 36.508 [18];
- the power level of cell A is the Serving Cell level defined in table 6.2.2.1-1 of TS 36.508 [18];
- the power levels of cells B to K are set to the Non-suitable Off level defined in table 6.2.2.1-1 of TS 36.508 [18].

Table 9.2.1.1b-2: Time instances of cell power level and parameter changes

	Parameter	Unit	Cell A	Cell L	Cell B	Cell C	Cell G	Cell H	Cell K	Cell E
T0	Cell-specific RS EPRE	dBm/15kHz	-85	Off	Off	Off	Off	Off	Off	Off
T1	Cell-specific RS EPRE	dBm/15kHz	-91	-85	Off	Off	Off	Off	Off	Off
T2	Cell-specific RS EPRE	dBm/15kHz	Off	Off	-85	Off	Off	Off	Off	Off
T3 (N=3)	Cell-specific RS EPRE	dBm/15kHz	Off	Off	-91	-85	Off	Off	Off	Off
T3 (N=4)	Cell-specific RS EPRE	dBm/15kHz	Off	Off	Off	-91	-85	Off	Off	Off
T3 (N=5)	Cell-specific RS EPRE	dBm/15kHz	Off	Off	Off	Off	-91	-85	Off	Off
T3 (N=6)	Cell-specific RS EPRE	dBm/15kHz	Off	Off	Off	Off	Off	-91	-85	Off
T3 (N=7)	Cell-specific RS EPRE	dBm/15kHz	Off	Off	Off	Off	Off	Off	-91	-85
T4	Cell-specific RS EPRE	dBm/15kHz	Off	-85	Off	Off	Off	Off	Off	-91
T5	Cell-specific RS EPRE	dBm/15kHz	-85	Off	Off	Off	Off	Off	Off	-91

UE:

- the UE is previously registered on E-UTRAN, and when on E-UTRAN, the UE is last authenticated and registered on cell A using default message contents according to TS 36.508 [18].

Preamble:

- the UE is in state Switched OFF (state 1) according to TS 36.508 [18].

9.2.1.1.1b.3.2 Test procedure sequence

Same Test procedure sequence as in clause 9.2.1.1.1a.3.2. Cell I shall be replaced by Cell L.

9.2.1.1.1b.3.3 Specific message contents

Same Specific message contents as in clause 9.2.1.1.1a.3.3. Cell I shall be replaced by Cell L.

9.2.1.1.2 Attach Procedure / Success / With IMSI / GUTI reallocation

9.2.1.1.2.1 Test Purpose (TP)

(1)

```
with { UE in EMM-DEREGISTERED state }
ensure that {
  when { there is no valid GUTI available in UE }
  then { UE sends ATTACH REQUEST message, containing IMSI as the EPS mobile identity }
}
```

(2)

```
with { UE having received reallocated GUTI in the ATTACH ACCEPT message }
ensure that {
  when { UE detaches from the EPS services }
  then { UE sends DETACH REQUEST message, containing GUTI as the EPS mobile identity }
}
```

9.2.1.1.2.2 Conformance requirements

References: The conformance requirements covered in the current TC are specified in: TS 24.301, clause 5.5.1.2.

[TS 24.301, clause 5.5.1.2.2]

In state EMM-DEREGISTERED, the UE initiates the attach procedure by sending an ATTACH REQUEST message to the MME, starting timer T3410 and entering state EMM-REGISTERED-INITIATED (see example in figure 5.5.1.2.2.1). If timer T3402 is currently running, the UE shall stop timer T3402. If timer T3411 is currently running, the UE shall stop timer T3411.

If the UE supports neither A/Gb mode nor Iu mode, the UE shall handle the Old GUTI or IMSI IE in the ATTACH REQUEST message as follows:

- The UE shall include in the ATTACH REQUEST message a valid GUTI together with the last visited registered TAI, if available. If there is no valid GUTI available, the UE shall include the IMSI in the ATTACH REQUEST message.

[TS 24.301, clause 5.5.1.2.4]

If the attach request is accepted by the network, the MME shall send an ATTACH ACCEPT message to the UE and start timer T3450. The MME shall send the ATTACH ACCEPT message together with an ACTIVATE DEFAULT EPS BEARER CONTEXT REQUEST message contained in the ESM message container information element to activate the default bearer (see subclause 6.4.1). The network may also initiate the activation of dedicated bearers towards the UE by invoking the dedicated EPS bearer context activation procedure (see subclause 6.4.2).

...

The MME shall assign and include the TAI list the UE is registered to in the ATTACH ACCEPT message. The UE, upon receiving an ATTACH ACCEPT message, shall delete its old TAI list and store the received TAI list.

Upon receiving the ATTACH ACCEPT message, the UE shall stop timer T3410.

The GUTI reallocation may be part of the attach procedure. When the ATTACH REQUEST message includes the IMSI, the MME considers the GUTI provided by the UE is invalid, or the GUTI provided by the UE was assigned by another MME, the MME shall allocate a new GUTI to the UE. The MME shall include in the ATTACH ACCEPT message the new assigned GUTI together with the assigned TAI list. In this case the MME shall enter state EMM-COMMON-PROCEDURE-INITIATED as described in subclause 5.4.1.

For a shared network, the TAIs included in the TAI list can contain different PLMN identities. The MME indicates the selected core network operator PLMN identity to the UE in the GUTI (see 3GPP TS 23.251). If the ATTACH ACCEPT message contains a GUTI, the UE shall use this GUTI as the new temporary identity. The UE shall delete its old GUTI and store the new assigned GUTI. If no GUTI has been included by the MME in the ATTACH ACCEPT message, the old GUTI, if any available, shall be kept.

If A/Gb mode or Iu mode is supported in the UE, the UE shall set its TIN to "GUTI" when receiving the ATTACH ACCEPT message.

9.2.1.1.2.3 Test description

9.2.1.1.2.3.1 Pre-test conditions

System Simulator:

- cell A (HPLMN).

UE:

- the UE is configured to initiate EPS attach.

Preamble:

- the UE is in state Registered, Idle Mode (State 2) according to TS 36.508 [18].

9.2.1.1.2.3.2 Test procedure sequence

Table 9.2.1.1.2.3.2-1: Main behaviour

St	Procedure	Message Sequence		TP	Verdict
		U - S	Message		
1	The SS transmits Paging on cell A with IMSI. Upon reception of paging with IMSI the UE shall locally deactivate any EPS bearer context(s), locally detach from EPS and delete the GUTI-1. After local detach the UE shall perform an EPS attach procedure.	-	-	-	-
	EXCEPTION: Steps 1a describes a behaviour which depends on the UE capability	-	-	-	-
1a	IF NOT pc_Automatic_EPS_Re_Attach, the user initiates an attach by MMI or by AT command.	-	-	-	-
2	Check: Does the UE transmit an ATTACH REQUEST message including IMSI in the EPS mobile identity IE including a PDN CONNECTIVITY REQUEST message?	-->	ATTACH REQUEST	1	P
3	The SS transmits an AUTHENTICATION REQUEST message to initiate the EPS authentication and AKA procedure.	<--	AUTHENTICATION REQUEST	-	-
4	The UE transmits an AUTHENTICATION RESPONSE message and establishes mutual authentication.	-->	AUTHENTICATION RESPONSE	-	-
5	The SS transmits a NAS SECURITY MODE COMMAND message to activate NAS security.	<--	SECURITY MODE COMMAND	-	-
6	The UE transmits a NAS SECURITY MODE COMPLETE message and establishes the initial security configuration.	-->	SECURITY MODE COMPLETE	-	-
-	EXCEPTION: Steps 6Aa1 to 6Aa2 describe behaviour that depends on UE configuration; the "lower case letter" identifies a step sequence that take place if the UE has ESM information which needs to be transferred.	-	-	-	-
6A a1	IF the UE sets the ESM information transfer flag in the last PDN CONNECTIVITY REQUEST message THEN the SS transmits an ESM INFORMATION REQUEST message to initiate exchange of protocol configuration options and/or APN.	<--	ESM INFORMATION REQUEST	-	-
6A a2	The UE transmits an ESM INFORMATION RESPONSE message to transfer protocol configuration options and/or APN.	-->	ESM INFORMATION RESPONSE	-	-
7	SS responds with ATTACH ACCEPT message with a new GUTI-2 included in the EPS mobile identity IE. The ACTIVATE DEFAULT EPS BEARER CONTEXT REQUEST message is piggybacked in ATTACH ACCEPT message.	<--	ATTACH ACCEPT	-	-
8	The UE transmits an ATTACH COMPLETE message including an ACTIVATE DEFAULT EPS BEARER CONTEXT ACCEPT message	-->	ATTACH COMPLETE	-	-
9	Cause UE to detach from the EPS services	-	-	-	-
10	Check: Does the UE transmit a DETACH REQUEST message including GUTI-2 in the EPS mobile identity IE?	-->	DETACH REQUEST	2	P
11	SS responds with DETACH ACCEPT message	<--	DETACH ACCEPT	-	-
12	The SS releases the RRC connection.	-	-	-	-

9.2.1.1.2.3.3 Specific message contents

Table 9.2.1.1.2.3.3-1: ATTACH REQUEST (step 2, Table 9.2.1.1.2.3.2-1)

Derivation Path: 36.508, Table 4.7.2-4			
Information Element	Value/remark	Comment	Condition
Old GUTI or IMSI	IMSI		
Last visited registered TAI	Not present		

Table 9.2.1.1.2.3.3-2: DETACH REQUEST (step 10, Table 9.2.1.1.2.3.2-1)

Derivation Path: 36.508, Table 4.7.2-11			
Information Element	Value/remark	Comment	Condition
GUTI or IMSI	GUTI-2		

9.2.1.1.2a Attach Procedure / AttachWithIMSI configured / Selected PLMN is neither the registered PLMN nor in the list of equivalent PLMNs / Success

9.2.1.1.2a.1 Test Purpose (TP)

(1)

```
with { UE in state EMM-REGISTERED and EMM-IDLE mode and configured for "AttachWithIMSI" }
ensure that {
  when { UE enters a tracking area in a new PLMN that is neither the registered PLMN nor in the list
of equivalent PLMNs }
  then { UE sends ATTACH REQUEST message, containing IMSI as the EPS mobile identity }
}
```

9.2.1.1.2a.2 Conformance requirements

References: The conformance requirements covered in the current TC are specified in: TS 24.301, clause 5.5.3.2.2, and, TS 24.368 clauses 4 and 5.4.

[TS 24.301, clause 5.5.3.2.2]

The UE in state EMM-REGISTERED shall initiate the tracking area updating procedure by sending a TRACKING AREA UPDATE REQUEST message to the MME,

- a) when the UE detects entering a tracking area that is not in the list of tracking areas that the UE previously registered in the MME, unless the UE is configured for "AttachWithIMSI" as specified in 3GPP TS 24.368 [15A] or 3GPP TS 31.102 [17] and is entering a tracking area in a new PLMN that is neither the registered PLMN nor in the list of equivalent PLMNs;

[TS 24.368, clause 4]

The NAS configuration MO is used to manage configuration parameters related to NAS functionality for a UE supporting provisioning of such information. The presence and format of the non access stratum configuration file on the USIM is specified in 3GPP TS 31.102 [6].

...

The following nodes and leaf objects are possible in the NAS configuration MO as described in figure 4-1:

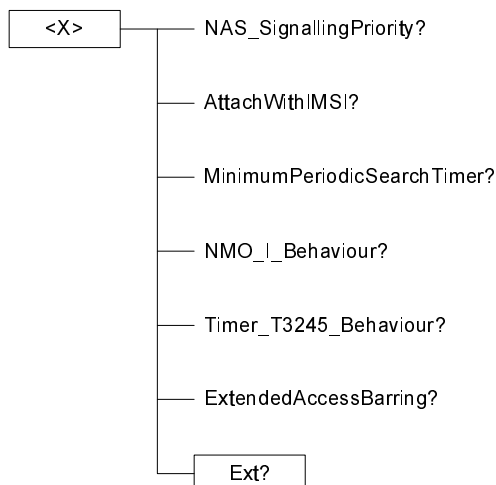

Figure 4-1: The NAS configuration Management Object

[TS 24.368, clause 5.4]

The AttachWithIMSI leaf indicates whether attach with IMSI is performed when moving to a non-equivalent PLMN as specified in 3GPP TS 24.008 [4] and 3GPP TS 24.301 [5].

- Occurrence: ZeroOrOne
- Format: bool
- Access Types: Get, Replace
- Values: 0, 1
 - 0 Indicates that normal behaviour is applied.
 - 1 Indicates that attach with IMSI is performed when moving to a non-equivalent PLMN.

The default value 0 applies if this leaf is not provisioned.

9.2.1.1.2a.3 Test description

9.2.1.1.2a.3.1 Pre-test conditions

System Simulator:

- cell A (HPLMN), cell B a different PLMN.

UE:

- The UE (USIM) is configured to do "AttachWithIMSI"
- The UE is configured to initiate EPS attach.

Preamble:

- The UE is in state Registered, Idle Mode (State 2) according to TS 36.508 [18] on cell A. During the registration a list with 2 equivalent PLMNs is provided however the PLMN of cell B is not among them.

9.2.1.1.2a.3.2 Test procedure sequence

Table 9.2.1.1.2a.3.2-1: Main behaviour

St	Procedure	Message Sequence		TP	Verdict
		U - S	Message		
1	The SS configures: - Cell B as the "Serving cell". - Cell A as a "Non-Suitable cell".	-	-	-	-
-	The following messages are to be observed on Cell B unless explicitly stated otherwise.	-	-	-	-
2	Check: Does the UE transmit an ATTACH REQUEST message including IMSI as the EPS mobile identity? The UE includes a PDN CONNECTIVITY REQUEST message.	-->	ATTACH REQUEST	1	P
3-14	Steps 5-16 from the UE Registration (State 2) procedure described in TS 36.508 [18], Table 4.5.2.3-1 take place.	-	-	-	-
15	The SS releases the RRC connection.	-	-	-	-
-	At the end of this test procedure sequence, the UE is in end state E-UTRA idle (E1) according to TS 36.508 [18].	-	-	-	-

9.2.1.1.2a.3.3 Specific message contents

Table 9.2.1.1.2a.3.3-1: ATTACH REQUEST (step 2, Table 9.2.1.1.2a.3.2-1)

Derivation Path: 36.508, Table 4.7.2-4			
Information Element	Value/remark	Comment	Condition
Old GUTI or IMSI	IMSI		

9.2.1.1.3 Attach Procedure / Success / Request for obtaining the IPv6 address of the home agent

9.2.1.1.3.1 Test Purpose (TP)

(1)

```
with { UE is configured to request the IPv6 address of the Home Agent during Attach procedure }
ensure that {
  when { UE is switched on and has established the RRC connection }
  then { UE transmits an ATTACH REQUEST message and a PDN CONNECTIVITY REQUEST message indicating
a request for DSMIPv6 Home Agent Address in the protocol configuration options }
}
```

(2)

```
with { UE having transmitted an ATTACH REQUEST message and a PDN CONNECTIVITY REQUEST message
indicating a request for DSMIPv6 Home Agent Address in the protocol configuration options }
ensure that {
  when { the SS responds to the ATTACH REQUEST with an IPv6 Home Agent address }
  then { the UE transmits an ATTACH COMPLETE message }
}
```

9.2.1.1.3.2 Conformance requirements

References: The conformance requirements covered in the present TC are specified in: TS 24.301, clauses 5.5.1.1 and 6.5.1.2, and TS 24.008, clause 10.5.6.3.

[24.301 clause 5.5.1.1]

During the attach procedure, the UE may also obtain the home agent IPv4 and IPv6 addresses.

[24.301 clause 6.5.1.2]

If the UE supports DSMIPv6, the UE may include a request for obtaining the IPv6 address and optionally the IPv4 address of the home agent in the Protocol configuration options IE in the PDN CONNECTIVITY REQUEST message. The UE may also include a request for obtaining the IPv6 Home Network Prefix. The UE shall request the IPv6 Home Network Prefix only if the UE has requested the home agent IPv6 address. The requested home agent address(es) and the Home Network Prefix are related to the APN the UE requested connectivity for.

[24.008 clause 10.5.6.3]

Table 10.5.154/3GPP TS 24.008: *Protocol configuration options* information element

<p>Additional parameters list (octets w+1 to z)</p> <p>The <i>additional parameters list</i> is included when special parameters and/or requests (associated with a PDP context) need to be transferred between the MS and the network. These parameters and/or requests are not related to a specific configuration protocol (e.g. PPP), and therefore are not encoded as the "Packets" contained in the <i>configuration protocol options list</i>.</p> <p>The <i>additional parameters list</i> contains a list of special parameters, each one in a separate container. The type of the parameter carried in a container is identified by a specific <i>container identifier</i>. In this version of the protocol, the following container identifiers are specified:</p> <p>MS to network direction:</p> <ul style="list-style-type: none"> - 0001H (P-CSCF Address Request); - 0002H (IM CN Subsystem Signalling Flag); - 0003H (DNS Server Address Request); - 0004H (Not Supported); - 0005H (MS Support of Network Requested Bearer Control indicator); - 0006H (Reserved); - 0007H (DSMIPv6 Home Agent Address Request); - 0008H (DSMIPv6 Home Network Prefix Request); - 0009H (DSMIPv6 IPv4 Home Agent Address Request); - 000AH (IP address allocation via NAS signalling); and - 000BH (IPv4 address allocation via DHCPv4). <p>Network to MS direction:</p> <ul style="list-style-type: none"> - 0001H (P-CSCF Address); - 0002H (IM CN Subsystem Signalling Flag); - 0003H (DNS Server Address); - 0004H (Policy Control rejection code); - 0005H (Selected Bearer Control Mode); - 0006H (Reserved); - 0007H (DSMIPv6 Home Agent Address) ; - 0008H (DSMIPv6 Home Network Prefix); and - 0009H (DSMIPv6 IPv4 Home Agent Address). <p>If the <i>additional parameters list</i> contains a container identifier that is not supported by the receiving entity the corresponding unit shall be discarded.</p> <p>The <i>container identifier</i> field is encoded as the <i>protocol identifier</i> field and the <i>length of container identifier contents</i> field is encoded as the <i>length of the protocol identifier contents</i> field.</p> <p>When the <i>container identifier</i> indicates P-CSCF Address Request or DNS Server Address Request, the <i>container identifier contents</i> field is empty and the <i>length of container identifier contents</i> indicates a length equal to zero. If the <i>container identifier contents</i> field is not empty, it shall be ignored.</p> <p>When the <i>container identifier</i> indicates IM CN Subsystem Signalling Flag (see 3GPP</p>
--

TS 24.229 [95]), the *container identifier contents* field is empty and the *length of container identifier contents* indicates a length equal to zero. If the *container identifier contents* field is not empty, it shall be ignored. In Network to MS direction this information may be used by the MS to indicate to the user whether the requested dedicated signalling PDP context was successfully established.

When the *container identifier* indicates P-CSCF Address, the *container identifier contents* field contains one IPv6 address corresponding to a P-CSCF address (see 3GPP TS 24.229 [95]). This IPv6 address is encoded as a 128-bit address according to RFC 3513 [99]. When there is need to include more than one P-CSCF address, then more logical units with *container identifier* indicating P-CSCF Address are used.

When the *container identifier* indicates DNS Server Address, the *container identifier contents* field contains one IPv6 DNS server address (see 3GPP TS 27.060 [36a]). This IPv6 address is encoded as a 128-bit address according to RFC 3513 [99]. When there is need to include more than one DNS server address, then more logical units with *container identifier* indicating DNS Server Address are used.

When the *container identifier* indicates Policy Control rejection code, the *container identifier contents* field contains a Go interface related cause code from the GGSN to the UE (see 3GPP TS 29.207 [100]). The *length of container identifier contents* indicates a length equal to one. If the *container identifier contents* field is empty or its actual length is greater than one octet, then it shall be ignored by the receiver.

When the *container identifier* indicates MS Support of Network Requested Bearer Control indicator, the *container identifier contents* field is empty and the *length of container identifier contents* indicates a length equal to zero. If the *container identifier contents* field is not empty, it shall be ignored.

When the *container identifier* indicates Selected Bearer Control Mode, the *container identifier contents* field contains the selected bearer control mode, where '01H' indicates that 'MS only' mode has been selected and '02H' indicates that 'MS/NW' mode has been selected. The *length of container identifier contents* indicates a length equal to one. If the *container identifier contents* field is empty or its actual length is greater than one octet, then it shall be ignored by the receiver.

When the *container identifier* indicates DSMIPv6 Home Agent Address Request, the *container identifier contents* field is empty and the *length of container identifier contents* indicates a length equal to zero. If the *container identifier contents* field is not empty, it shall be ignored.

When the *container identifier* indicates DSMIPv6 Home Network Prefix Request, the *container identifier contents* field is empty and the *length of container identifier contents* indicates a length equal to zero. If the *container identifier contents* field is not empty, it shall be ignored.

When the *container identifier* indicates DSMIPv6 IPv4 Home Agent Address Request, the *container identifier contents* field is empty and the *length of container identifier contents* indicates a length equal to zero. If the *container identifier contents* field is not empty, it shall be ignored.

When the *container identifier* indicates DSMIPv6 Home Agent Address, the *container identifier contents* field contains one IPv6 address corresponding to a DSMIPv6 HA address (see 3GPP TS 24.303 [124] and 3GPP TS 24.327 [125]). This IPv6 address is encoded as a 128-bit address according to IETF RFC 3513 [99].

When the *container identifier* indicates DSMIPv6 Home Network Prefix, the *container identifier contents* field contains one IPv6 Home Network Prefix (see 3GPP TS 24.303 [124] and 3GPP TS 24.327 [125]). This IPv6 prefix is encoded as an IPv6 address according to RFC 3513 [99] followed by 8 bits which specifies the prefix length.

When the *container identifier* indicates DSMIPv6 IPv4 Home Agent Address, the *container identifier contents* field contains one IPv4 address corresponding to a DSMIPv6 IPv4 Home Agent address (see 3GPP TS 24.303 [124] and 3GPP TS 24.327 [125]).

When the *container identifier* indicates IP address allocation via NAS signalling, the

container identifier contents field is empty and the *length of container identifier contents* indicates a length equal to zero. If the *container identifier contents* field is not empty, it shall be ignored.

When the *container identifier* indicates IP address allocation DHCPv4, the *container identifier contents* field is empty and the *length of container identifier contents* indicates a length equal to zero. If the *container identifier contents* field is not empty, it shall be ignored.

NOTE 1: The *additional parameters list* and the *configuration protocol options list* are logically separated since they carry different type of information. The beginning of the *additional parameters list* is marked by a logical unit, which has an identifier (i.e. the first two octets) equal to a *container identifier* (i.e. it is not a *protocol identifier*).

9.2.1.1.3.3 Test description

9.2.1.1.3.3.1 Pre-test conditions

System Simulator:

- cell A.

UE:

- the UE is previously registered on E-UTRAN, and when on E-UTRAN, the UE is last authenticated and registered on cell A using default message contents according to [18];

NOTE: Any type of attach is acceptable.

- the UE is configured to request the IPv6 address of the Home Agent in the protocol configuration options IE as part of the Attach / PDN connectivity request procedure.

Preamble:

- the UE is in state Switched OFF (state 1) according to TS 36.508 [18].

9.2.1.1.3.3.2 Test procedure sequence

Table 9.2.1.1.3.3.2-1: Main behaviour

St	Procedure	Message Sequence		TP	Verdict
		U - S	Message		
1	The UE is switched on.	-	-	-	-
2	Check: Does the UE transmit an ATTACH REQUEST message including a PDN CONNECTIVITY REQUEST message with IE PROTOCOL CONFIGURATION OPTIONS indicating a DSMIPv6 Home Agent Address Request?	-->	ATTACH REQUEST	1	P
3-11	Steps 5 to 13 of the generic test procedure in TS 36.508 Table 4.5.2.3-1 (Attach procedure) are performed on Cell A .	-	-	-	-
12	SS responds with ATTACH ACCEPT message including a valid TAI list. The ACTIVATE DEFAULT EPS BEARER CONTEXT REQUEST message is piggybacked in ATTACH ACCEPT message, including the IE PROTOCOL CONFIGURATION OPTIONS indicating a DSMIPv6 Home Agent Address.	<--	ATTACH ACCEPT	-	-
-	EXCEPTION: In parallel to the event described in step 13 below the generic procedure for IP address allocation in the U-plane specified in TS 36.508 subclause 4.5A.1 takes place performing IP address allocation in the U-plane if requested by the UE.	-	-	-	-
13	Check: Does the UE transmit an ATTACH COMPLETE message including an ACTIVATE DEFAULT EPS BEARER CONTEXT ACCEPT message?	-->	ATTACH COMPLETE	2	P
14	The SS releases the RRC connection.	-	-	-	-
-	At the end of this test procedure sequence, the UE is in end state E-UTRA idle (E1) according to TS 36.508.	-	-	-	-

9.2.1.1.3.3.3 Specific message contents

Table 9.2.1.1.3.3.3-1: Message ATTACH REQUEST (step 2, Table 9.2.1.1.3.3.2-1)

Derivation path: TS 36.508 table 4.7.2-4			
Information Element	Value/Remark	Comment	Condition
ESM message container	PDN CONNECTIVITY REQUEST message as specified in table 9.2.1.1.3.3.3-2.		

Table 9.2.1.1.3.3.3-2: PDN CONNECTIVITY REQUEST (Table 9.2.1.1.3.3.3-1)

Derivation path: TS 36.508 table 4.7.3-20			
Information Element	Value/Remark	Comment	Condition
Protocol configuration options	The IE Protocol configuration options contains a configuration protocol option = '0007H' ("DSMIPv6 Home Agent Address Request", length of contents = 0).		

Table 9.2.1.1.3.3-3: Message ATTACH ACCEPT (step 12, Table 9.2.1.1.3.3.2-1)

Derivation path: TS 36.508 table 4.7.3-1			
Information Element	Value/Remark	Comment	Condition
ESM message container	Contains the ACTIVATE DEFAULT EPS BEARER CONTEXT REQUEST message specified in table 9.2.1.1.3.3.3-4.		

Table 9.2.1.1.3.3-4: Message ACTIVATE DEFAULT EPS BEARER CONTEXT REQUEST (Table 9.2.1.1.3.3.3-3)

Derivation path: TS 36.508 table 4.7.3-6			
Information Element	Value/Remark	Comment	Condition
Protocol configuration options	The IE Protocol configuration options contains a configuration protocol option = '0007H' ("DSMIPv6 Home Agent Address", non-zero length), with the value set to the IPv6 address of the Home Agent.		

9.2.1.1.4 Attach Procedure / Success / Request for obtaining the IPv4 address of the home agent

9.2.1.1.4.1 Test Purpose (TP)

(1)

```
with { UE is configured to request the DSMIPv6 IPv4 Home Agent Address }
ensure that {
  when { UE is switched on and has established the RRC connection }
  then { UE transmits an ATTACH REQUEST and a PDN CONNECTIVITY REQUEST message indicating a request for DSMIPv6 IPv4 Home Agent Address in the protocol configuration options }
}
```

(2)

```
with { UE having transmitted an ATTACH REQUEST and a PDN CONNECTIVITY REQUEST message indicating a request for DSMIPv6 IPv4 Home Agent Address in the protocol configuration options }
ensure that {
  when { SS responds to the ATTACH REQUEST with a DSMIPv6 IPv4 Home Agent Address }
  then { UE transmits an ATTACH COMPLETE message }
}
```

9.2.1.1.4.2 Conformance requirements

References: The conformance requirements covered in the current TC are specified in: TS 24.301, clauses 5.5.1.1, and 6.5.1.2, and TS 24.008, clause 10.5.6.3.

[24.301 clause 5.5.1.1]

During the attach procedure, the UE may also obtain the home agent IPv4 and IPv6 addresses.

[24.301 clause 6.5.1.2]

If the UE supports DSMIPv6, the UE may include a request for obtaining the IPv6 address and optionally the IPv4 address of the home agent in the Protocol configuration options IE in the PDN CONNECTIVITY REQUEST message. The UE may also include a request for obtaining the IPv6 Home Network Prefix. The UE shall request the IPv6 Home Network Prefix only if the UE has requested the home agent IPv6 address. The requested home agent address(es) and the Home Network Prefix are related to the APN the UE requested connectivity for.

[24.008 clause 10.5.6.3]

Table 10.5.154/3GPP TS 24.008: Protocol configuration options information element

<p>Additional parameters list (octets w+1 to z)</p> <p>The <i>additional parameters list</i> is included when special parameters and/or requests (associated with a PDP context) need to be transferred between the MS and the network. These parameters and/or requests are not related to a specific configuration protocol (e.g. PPP), and therefore are not encoded as the "Packets" contained in the <i>configuration protocol options list</i>.</p> <p>The <i>additional parameters list</i> contains a list of special parameters, each one in a separate container. The type of the parameter carried in a container is identified by a specific <i>container identifier</i>. In this version of the protocol, the following container identifiers are specified:</p> <p>MS to network direction:</p> <ul style="list-style-type: none"> - 0001H (P-CSCF Address Request); - 0002H (IM CN Subsystem Signalling Flag); - 0003H (DNS Server Address Request); - 0004H (Not Supported); - 0005H (MS Support of Network Requested Bearer Control indicator); - 0006H (Reserved); - 0007H (DSMIPv6 Home Agent Address Request); - 0008H (DSMIPv6 Home Network Prefix Request); - 0009H (DSMIPv6 IPv4 Home Agent Address Request); - 000AH (IP address allocation via NAS signalling); and - 000BH (IPv4 address allocation via DHCPv4). <p>Network to MS direction:</p> <ul style="list-style-type: none"> - 0001H (P-CSCF Address); - 0002H (IM CN Subsystem Signalling Flag); - 0003H (DNS Server Address); - 0004H (Policy Control rejection code); - 0005H (Selected Bearer Control Mode); - 0006H (Reserved); - 0007H (DSMIPv6 Home Agent Address) ; - 0008H (DSMIPv6 Home Network Prefix); and - 0009H (DSMIPv6 IPv4 Home Agent Address). <p>If the <i>additional parameters list</i> contains a container identifier that is not supported by the receiving entity the corresponding unit shall be discarded.</p> <p>The <i>container identifier</i> field is encoded as the <i>protocol identifier</i> field and the <i>length of container identifier contents</i> field is encoded as the <i>length of the protocol identifier contents</i> field.</p> <p>When the <i>container identifier</i> indicates P-CSCF Address Request or DNS Server Address Request, the <i>container identifier contents</i> field is empty and the <i>length of container identifier contents</i> indicates a length equal to zero. If the <i>container identifier contents</i> field is not empty, it shall be ignored.</p> <p>When the <i>container identifier</i> indicates IM CN Subsystem Signalling Flag (see 3GPP</p>
--

TS 24.229 [95]), the *container identifier contents* field is empty and the *length of container identifier contents* indicates a length equal to zero. If the *container identifier contents* field is not empty, it shall be ignored. In Network to MS direction this information may be used by the MS to indicate to the user whether the requested dedicated signalling PDP context was successfully established.

When the *container identifier* indicates P-CSCF Address, the *container identifier contents* field contains one IPv6 address corresponding to a P-CSCF address (see 3GPP TS 24.229 [95]). This IPv6 address is encoded as a 128-bit address according to RFC 3513 [99]. When there is need to include more than one P-CSCF address, then more logical units with *container identifier* indicating P-CSCF Address are used.

When the *container identifier* indicates DNS Server Address, the *container identifier contents* field contains one IPv6 DNS server address (see 3GPP TS 27.060 [36a]). This IPv6 address is encoded as a 128-bit address according to RFC 3513 [99]. When there is need to include more than one DNS server address, then more logical units with *container identifier* indicating DNS Server Address are used.

When the *container identifier* indicates Policy Control rejection code, the *container identifier contents* field contains a Go interface related cause code from the GGSN to the UE (see 3GPP TS 29.207 [100]). The *length of container identifier contents* indicates a length equal to one. If the *container identifier contents* field is empty or its actual length is greater than one octet, then it shall be ignored by the receiver.

When the *container identifier* indicates MS Support of Network Requested Bearer Control indicator, the *container identifier contents* field is empty and the *length of container identifier contents* indicates a length equal to zero. If the *container identifier contents* field is not empty, it shall be ignored.

When the *container identifier* indicates Selected Bearer Control Mode, the *container identifier contents* field contains the selected bearer control mode, where '01H' indicates that 'MS only' mode has been selected and '02H' indicates that 'MS/NW' mode has been selected. The *length of container identifier contents* indicates a length equal to one. If the *container identifier contents* field is empty or its actual length is greater than one octet, then it shall be ignored by the receiver.

When the *container identifier* indicates DSMIPv6 Home Agent Address Request, the *container identifier contents* field is empty and the *length of container identifier contents* indicates a length equal to zero. If the *container identifier contents* field is not empty, it shall be ignored.

When the *container identifier* indicates DSMIPv6 Home Network Prefix Request, the *container identifier contents* field is empty and the *length of container identifier contents* indicates a length equal to zero. If the *container identifier contents* field is not empty, it shall be ignored.

When the *container identifier* indicates DSMIPv6 IPv4 Home Agent Address Request, the *container identifier contents* field is empty and the *length of container identifier contents* indicates a length equal to zero. If the *container identifier contents* field is not empty, it shall be ignored.

When the *container identifier* indicates DSMIPv6 Home Agent Address, the *container identifier contents* field contains one IPv6 address corresponding to a DSMIPv6 HA address (see 3GPP TS 24.303 [124] and 3GPP TS 24.327 [125]). This IPv6 address is encoded as a 128-bit address according to IETF RFC 3513 [99].

When the *container identifier* indicates DSMIPv6 Home Network Prefix, the *container identifier contents* field contains one IPv6 Home Network Prefix (see 3GPP TS 24.303 [124] and 3GPP TS 24.327 [125]). This IPv6 prefix is encoded as an IPv6 address according to RFC 3513 [99] followed by 8 bits which specifies the prefix length.

When the *container identifier* indicates DSMIPv6 IPv4 Home Agent Address, the *container identifier contents* field contains one IPv4 address corresponding to a DSMIPv6 IPv4 Home Agent address (see 3GPP TS 24.303 [124] and 3GPP TS 24.327 [125]).

When the *container identifier* indicates IP address allocation via NAS signalling, the

container identifier contents field is empty and the *length of container identifier contents* indicates a length equal to zero. If the *container identifier contents* field is not empty, it shall be ignored.

When the *container identifier* indicates IP address allocation DHCPv4, the *container identifier contents* field is empty and the *length of container identifier contents* indicates a length equal to zero. If the *container identifier contents* field is not empty, it shall be ignored.

NOTE 1: The *additional parameters list* and the *configuration protocol options list* are logically separated since they carry different type of information. The beginning of the *additional parameters list* is marked by a logical unit, which has an identifier (i.e. the first two octets) equal to a *container identifier* (i.e. it is not a *protocol identifier*).

9.2.1.1.4.3 Test description

9.2.1.1.4.3.1 Pre-test conditions

System Simulator:

- cell A.

UE:

- the UE is previously registered on E-UTRAN, and when on E-UTRAN, the UE is last authenticated and registered on cell A using default message contents according to TS 36.508 [18];

NOTE: Any type of attach is acceptable.

- the UE is configured to request the DSMIPv6 IPv4 Home Agent Address in the protocol configuration options IE as part of the Attach / PDN connectivity request procedure.

Preamble:

- the UE is in state Switched OFF (state 1) according to TS 36.508 [18].

9.2.1.1.4.3.2 Test procedure sequence

Table 9.2.1.1.4.3.2-1: Main behaviour

St	Procedure	Message Sequence		TP	Verdict
		U - S	Message		
1	The UE is switched on.	-	-	-	-
2	Void	-	-	-	-
3	Void	-	-	-	-
4	Check: Does the UE transmit an ATTACH REQUEST message including a PDN CONNECTIVITY REQUEST message with IE PROTOCOL CONFIGURATION OPTIONS indicating a DSMIPv6 IPv4 Home Agent Address Request?	-->	ATTACH REQUEST	1	P
5-13	Steps 5 to 13 of the generic test procedure in TS 36.508 Table 4.5.2.3-1 (Attach procedure) are performed on Cell A.	-	-	-	-
14	SS responds with ATTACH ACCEPT message including a valid TAI list. The ACTIVATE DEFAULT EPS BEARER CONTEXT REQUEST message is piggybacked in ATTACH ACCEPT message, including the IE PROTOCOL CONFIGURATION OPTIONS indicating a DSMIPv6 IPv4 Home Agent Address	<--	ATTACH ACCEPT	-	-
-	EXCEPTION: In parallel to the event described in step 11 below the generic procedure for IP address allocation in the U-plane specified in TS 36.508 subclause 4.5A.1 takes place performing IP address allocation in the U-plane if requested by the UE.	-	-	-	-
15	Check: Does the UE transmit an ATTACH COMPLETE message including an ACTIVATE DEFAULT EPS BEARER CONTEXT ACCEPT message?	-->	ATTACH COMPLETE	2	P
16	The SS releases the RRC connection.	-	-	-	-
-	At the end of this test procedure sequence, the UE is in end state E-UTRA idle (E1) according to TS 36.508.	-	-	-	-

9.2.1.1.4.3.3 Specific message contents

Table 9.2.1.1.4.3.3-1: Void**Table 9.2.1.1.4.3.3-2: Message ATTACH REQUEST (step 4, Table 9.2.1.1.4.3.2-1)**

Derivation path: TS 36.508 table 4.7.2-4			
Information Element	Value/Remark	Comment	Condition
ESM message container	PDN CONNECTIVITY REQUEST message as specified in table 9.2.1.1.4.3.3-3.		

Table 9.2.1.1.4.3.3-3: PDN CONNECTIVITY REQUEST (Table 9.2.1.1.4.3.3-2)

Derivation path: TS 36.508 table 4.7.3-20			
Information Element	Value/Remark	Comment	Condition
Protocol configuration options	The IE Protocol configuration options contains a configuration protocol option = '0009H' ("DSMIPv6 IPv4 Home Agent Address Request", length of contents = 0).		

Table 9.2.1.1.4.3.3-4: Message ATTACH ACCEPT (step 11, Table 9.2.1.1.4.3.2-1)

Derivation path: TS 36.508 table 4.7.3-1			
Information Element	Value/Remark	Comment	Condition
ESM message container	Contains the ACTIVATE DEFAULT EPS BEARER CONTEXT REQUEST message specified in table 9.2.1.1.4.3.3-5.		

Table 9.2.1.1.4.3.3-5: Message ACTIVATE DEFAULT EPS BEARER CONTEXT REQUEST (Table 9.2.1.1.4.3.3-4)

Derivation path: TS 36.508 table 4.7.3-6			
Information Element	Value/Remark	Comment	Condition
Protocol configuration options	The IE Protocol configuration options contains a configuration protocol option = '0009H' ("DSMIPv6 IPv4 Home Agent Address", non-zero length), with the value set to the IPv4 address of the Home Agent.		

9.2.1.1.5 Void

9.2.1.1.6 Void

9.2.1.1.7 Attach Procedure / Success / List of equivalent PLMNs in the ATTACH ACCEPT message

9.2.1.1.7.1 Test Purpose (TP)

(1)

```
with { UE in EMM-REGISTERED-INITIATED state }
ensure that {
  when { the UE receives ATTACH ACCEPT message including a list of equivalent PLMNs }
  then { the UE stores correctly the list and does not consider forbidden PLMNs as equivalent PLMNs }
}
```

(2)

```
with { UE in EMM-REGISTERED-INITIATED state }
ensure that {
  when { the UE receives ATTACH ACCEPT message without a list of equivalent PLMNs }
  then { the UE deletes the stored list and applies a normal PLMN selection process }
}
```

9.2.1.1.7.2 Conformance requirements

References: The conformance requirements covered in the current TC are specified in: TS 24.301, clause 5.5.1.2.4.

[TS 24.301, clause 5.5.1.2.4]

The MME may also include a list of equivalent PLMNs in the ATTACH ACCEPT message. Each entry in the list contains a PLMN code (MCC+MNC). The UE shall store the list as provided by the network, after having removed from the list any PLMN code that is already in the list of forbidden PLMNs. In addition, the UE shall add to the stored list the PLMN code of the registered PLMN that sent the list. The UE shall replace the stored list on each receipt of the ATTACH ACCEPT message. If the ATTACH ACCEPT message does not contain a list, then the UE shall delete the stored list.

9.2.1.1.7.3 Test description

9.2.1.1.7.3.1 Pre-test conditions

System Simulator:

- Cell A (PLMN1, HPLMN), cell G (PLMN2, visited PLMN), cell I (PLMN3, another visited PLMN) and cell J (PLMN4, another visited PLMN, different than cell I and switched OFF) are configured according to table 6.3.2.2-1 in TS 36.508 [18];
- at most 3 cells are active simultaneously.
- system information combination 3 as defined in TS 36.508[18] clause 4.4.3.1 is used in E-UTRA cell A

UE:

- the UE is configured to initiate EPS attach;
- the UE is previously registered on E-UTRAN, and when on E-UTRAN, the UE last attempted to register on cell I and received reject cause "forbidden PLMN".

Preamble:

- the UE is in state Switched OFF (state 1) according to TS 36.508 [18].

9.2.1.1.7.3.2 Test procedure sequence

Table: 9.2.1.1.7.3.2-1: Main behaviour

St	Procedure	Message Sequence		TP	Verdict
		U - S	Message		
1	The SS configures: - Cell A as the "Serving cell". - Cell G as a "Non-Suitable cell". - Cell I as a "Non-Suitable cell".	-	-	-	-
-	The following messages are to be observed on Cell A unless explicitly stated otherwise.	-	-	-	-
2	The UE is switched on.	-	-	-	-
3	The UE transmits an ATTACH REQUEST message including a PDN CONNECTIVITY REQUEST message.	-->	ATTACH REQUEST	-	-
4	The SS transmits an AUTHENTICATION REQUEST message to initiate the EPS authentication and AKA procedure.	<--	AUTHENTICATION REQUEST	-	-
5	The UE transmits an AUTHENTICATION RESPONSE message and establishes mutual authentication.	-->	AUTHENTICATION RESPONSE	-	-
6	The SS transmits a NAS SECURITY MODE COMMAND message to activate NAS security.	<--	SECURITY MODE COMMAND	-	-
7	The UE transmits a NAS SECURITY MODE COMPLETE message and establishes the initial security configuration.	-->	SECURITY MODE COMPLETE	-	-
-	EXCEPTION: Steps 7Aa1 to 7Aa2 describe behaviour that depends on UE configuration; the "lower case letter" identifies a step sequence that take place if the UE has ESM information which needs to be transferred.	-	-	-	-
7A a1	IF the UE sets the ESM information transfer flag in the last PDN CONNECTIVITY REQUEST message THEN the SS transmits an ESM INFORMATION REQUEST message to initiate exchange of protocol configuration options and/or APN.	<--	ESM INFORMATION REQUEST	-	-
7A a2	The UE transmits an ESM INFORMATION RESPONSE message to transfer protocol configuration options and/or APN.	-->	ESM INFORMATION RESPONSE	-	-
8	SS responds with ATTACH ACCEPT message including PLMN2, PLMN3 and PLMN4 in the list of equivalent PLMNs. The ACTIVATE DEFAULT EPS BEARER CONTEXT REQUEST message is piggybacked in ATTACH ACCEPT message.	<--	ATTACH ACCEPT	-	-
9	The UE transmits an ATTACH COMPLETE message including an ACTIVATE DEFAULT EPS BEARER CONTEXT ACCEPT message.	-->	ATTACH COMPLETE		
10	If possible (see ICS) switch off is performed or the USIM is removed. Otherwise the power is removed.			-	-
-	EXCEPTION: Step 10a1 describes behaviour that depends on the UE capability.				
10a	If pc_SwitchOnOff or pc_USIM_Removal then UE sends DETACH REQUEST message	-->	DETACH REQUEST		
11	The SS configures: - Cell A as the "Non-Suitable cell". - Cell G as a "Suitable cell". - Cell I as a "Serving cell". Note: Cell I belongs to the forbidden PLMN.	-	-	-	-
-	The following messages are to be observed on Cell G unless explicitly stated otherwise.	-	-	-	-
12	The UE is brought back to operation or the USIM is inserted.	-	-	-	-

-	EXCEPTION: The behaviour in table 9.2.1.1.7.3.2-2 occurs in parallel with step 13.				
13	Check: Does the UE transmit an ATTACH REQUEST message including a PDN CONNECTIVITY REQUEST message?	-->	ATTACH REQUEST	1	P
13 A	Void	-	-	-	-
13 B	Void	-	-	-	-
-	EXCEPTION: Steps 13Aa1 to 13Aa2 describe behaviour that depends on UE configuration; the "lower case letter" identifies a step sequence that take place if the UE has ESM information which needs to be transferred.	-	-	-	-
13 Aa 1	IF the UE sets the ESM information transfer flag in the last PDN CONNECTIVITY REQUEST message THEN the SS transmits an ESM INFORMATION REQUEST message to initiate exchange of protocol configuration options and/or APN.	<--	ESM INFORMATION REQUEST	-	-
13 A a2	The UE transmits an ESM INFORMATION RESPONSE message to transfer protocol configuration options and/or APN.	-->	ESM INFORMATION RESPONSE	-	-
-	EXCEPTION: In parallel to the event described in step 14 below the generic procedure for IP address allocation in the U-plane specified in TS 36.508 subclause 4.5A.1 takes place performing IP address allocation in the U-plane if requested by the UE.	-	-	-	-
14	The SS transmits an ATTACH ACCEPT message without the Equivalent PLMNs list. The ACTIVATE DEFAULT EPS BEARER CONTEXT REQUEST message is piggybacked in ATTACH ACCEPT message.	<--	ATTACH ACCEPT	-	-
15	The UE transmits an ATTACH COMPLETE message on Cell G (PLMN2) including an ACTIVATE DEFAULT EPS BEARER CONTEXT ACCEPT message.	-->	ATTACH COMPLETE	-	-
15 AA	The SS releases the RRC connection.	-	-	-	-
15 A	The SS configures: - Cell A as a "Suitable cell". - Cell G as a "Non-Suitable cell". - Cell I as a "Non-suitable "Off" cell". - Cell J as a "Serving cell".	-	-	-	-
-	The following messages are to be observed on Cell A unless explicitly stated otherwise.	-	-	-	-
-	EXCEPTION: The behaviour in table 9.2.1.1.7.3.2-3 occurs in parallel with step 15B.				
15 B	Check: Does the UE transmit a TRACKING AREA UPDATE REQUEST message?	-->	TRACKING AREA UPDATE REQUEST	2	P
15 C	SS responds with TRACKING AREA UPDATE ACCEPT message.	<--	TRACKING AREA UPDATE ACCEPT	-	-
15 D	The UE transmits a TRACKING AREA UPDATE COMPLETE message	-->	TRACKING AREA UPDATE COMPLETE		
16-34	Void	-	-	-	-
-	At the end of this test procedure sequence, the UE is in end state E-UTRA connected (E2_T3440) according to TS 36.508.	-	-	-	-

Table 9.2.1.1.7.3.2-2: Parallel behaviour

St	Procedure	Message Sequence		TP	Verdict
		U - S	Message		
1	Check: Does the UE transmit an ATTACH REQUEST message on Cell I (PLMN3) ?	-->	ATTACH REQUEST	1	F

Table 9.2.1.1.7.3.2-3: Parallel behaviour

St	Procedure	Message Sequence		TP	Verdict
		U - S	Message		
1	Check: Does the UE transmit a TRACKING AREA UPDATE REQUEST message on Cell J (PLMN4)?	-->	TRACKING AREA UPDATE REQUEST	2	F

9.2.1.1.7.3.3 Specific message contents

Table 9.2.1.1.7.3.3-1: SystemInformationBlockType5 for Cell A

Derivation path: 36.508 Table 4.4.3.3-4			
Information Element	Value/Remark	Comment	Condition
SystemInformationBlockType5 ::= SEQUENCE {			
interFreqCarrierFreqList SEQUENCE (SIZE (1..maxFreq)) OF SEQUENCE {	3 entries		
dl-CarrierFreq[1]	Same downlink EARFCN as used for Cell G		
dl-CarrierFreq[2]	Same downlink EARFCN as used for Cell I		
dl-CarrierFreq[2]	Same downlink EARFCN as used for Cell J		
}			
}			

Table 9.2.1.1.7.3.3-2: Message ATTACH ACCEPT (step 8, Table 9.2.1.1.7.3.2-1)

Derivation path: 36.508 table 4.7.2-1			
Information Element	Value/Remark	Comment	Condition
Equivalent PLMNs	-	Includes MCC and MNC digits for PLMN2, PLMN3 and PLMN4.	

Table 9.2.1.1.7.3.3-3: Message ATTACH ACCEPT (step 14, Table 9.2.1.1.7.3.2-1)

Derivation path: 36.508 table 4.7.2-1			
Information Element	Value/Remark	Comment	Condition
Equivalent PLMNs	Not present		

9.2.1.1.7a Attach Procedure / Success / List of equivalent PLMNs in the ATTACH ACCEPT message / Single Frequency operation

9.2.1.1.7a.1 Test Purpose (TP)

Same Test Purpose as in clause 9.2.1.1.7.1

9.2.1.1.7a.2 Conformance requirements

Same Conformance requirements as in clause 9.2.1.1.7.2

9.2.1.1.7a.3 Test description

9.2.1.1.7a.3.1 Pre-test conditions

System Simulator:

- Cell A (PLMN1, HPLMN), cell B (PLMN2, visited PLMN), and cell C (PLMN3, another visited PLMN)
- The cells are configured according to Table 6.3.2.2-1 and Table 6.3.2.2-3 in 36.508 [18], and are configured on same frequency f1;
- system information combination 2 as defined in TS 36.508[18] clause 4.4.3.1 is used in E-UTRA cell A

UE:

- the UE is configured to initiate EPS attach;
- the UE is previously registered on E-UTRAN, and when on E-UTRAN, the UE last attempted to register on cell C and received reject cause "forbidden PLMN".

Preamble:

- the UE is in state Switched OFF (state 1) according to TS 36.508 [18].

9.2.1.1.7a.3.2 Test procedure sequence

Table: 9.2.1.1.7a.3.2-1: Main behaviour

St	Procedure	Message Sequence		TP	Verdict
		U - S	Message		
1	The SS configures: - Cell A as the "Serving cell". - Cell B as a "Non-Suitable cell". - Cell C as a "Non-Suitable cell".	-	-	-	-
-	The following messages are to be observed on Cell A unless explicitly stated otherwise.	-	-	-	-
2	The UE is switched on.	-	-	-	-
3	The UE transmits an ATTACH REQUEST message including a PDN CONNECTIVITY REQUEST message.	-->	ATTACH REQUEST	-	-
4	The SS transmits an AUTHENTICATION REQUEST message to initiate the EPS authentication and AKA procedure.	<--	AUTHENTICATION REQUEST	-	-
5	The UE transmits an AUTHENTICATION RESPONSE message and establishes mutual authentication.	-->	AUTHENTICATION RESPONSE	-	-
6	The SS transmits a NAS SECURITY MODE COMMAND message to activate NAS security.	<--	SECURITY MODE COMMAND	-	-
7	The UE transmits a NAS SECURITY MODE COMPLETE message and establishes the initial security configuration.	-->	SECURITY MODE COMPLETE	-	-
-	EXCEPTION: Steps 7Aa1 to 7Aa2 describe behaviour that depends on UE configuration; the "lower case letter" identifies a step sequence that take place if the UE has ESM information which needs to be transferred.	-	-	-	-
7A a1	IF the UE sets the ESM information transfer flag in the last PDN CONNECTIVITY REQUEST message THEN the SS transmits an ESM INFORMATION REQUEST message to initiate exchange of protocol configuration options and/or APN.	<--	ESM INFORMATION REQUEST	-	-
7A a2	The UE transmits an ESM INFORMATION RESPONSE message to transfer protocol configuration options and/or APN.	-->	ESM INFORMATION RESPONSE	-	-
8	SS responds with ATTACH ACCEPT message including PLMN2, PLMN3 and PLMN4 in the list of equivalent PLMNs. The ACTIVATE DEFAULT EPS BEARER CONTEXT REQUEST message is piggybacked in ATTACH ACCEPT message.	<--	ATTACH ACCEPT	-	-
9	The UE transmits an ATTACH COMPLETE message including an ACTIVATE DEFAULT EPS BEARER CONTEXT ACCEPT message.	-->	ATTACH COMPLETE		
10	If possible (see ICS) switch off is performed or the USIM is removed. Otherwise the power is removed.			-	-
-	EXCEPTION: Step 10a1 describes behaviour that depends on the UE capability.				
10a	If pc_SwitchOnOff or pc_USIM_Removal then UE sends DETACH REQUEST message	-->	DETACH REQUEST		
11	The SS configures: - Cell A as the "Non-Suitable cell". - Cell B as a " Non-Suitable cell ". - Cell C as a "Serving cell". Note: Cell C belongs to the forbidden PLMN.	-	-	-	-
12	The UE is brought back to operation or the USIM is inserted.	-	-	-	-
12a	Check: Does the UE transmit an ATTACH REQUEST message in the next 60 seconds on Cell C	-	-	1	F

12b	The SS configures: - Cell A as the "Non-Suitable cell". - Cell B as a "Serving cell". - Cell C as a "Non-Suitable cell".				
-	The following messages are to be observed on Cell B unless explicitly stated otherwise.	-	-	-	-
13	Check: Does the UE transmit an ATTACH REQUEST message including a PDN CONNECTIVITY REQUEST message?	-->	ATTACH REQUEST	1	P
-	EXCEPTION: Steps 13Aa1 to 13Aa2 describe behaviour that depends on UE configuration; the "lower case letter" identifies a step sequence that take place if the UE has ESM information which needs to be transferred.	-	-	-	-
13 Aa 1	IF the UE sets the ESM information transfer flag in the last PDN CONNECTIVITY REQUEST message THEN the SS transmits an ESM INFORMATION REQUEST message to initiate exchange of protocol configuration options and/or APN.	<--	ESM INFORMATION REQUEST	-	-
13 A a2	The UE transmits an ESM INFORMATION RESPONSE message to transfer protocol configuration options and/or APN.	-->	ESM INFORMATION RESPONSE	-	-
-	EXCEPTION: In parallel to the event described in step 14 below the generic procedure for IP address allocation in the U-plane specified in TS 36.508 subclause 4.5A.1 takes place performing IP address allocation in the U-plane if requested by the UE.	-	-	-	-
14	The SS transmits an ATTACH ACCEPT message without the Equivalent PLMNs list. The ACTIVATE DEFAULT EPS BEARER CONTEXT REQUEST message is piggybacked in ATTACH ACCEPT message.	<--	ATTACH ACCEPT	-	-
15	The UE transmits an ATTACH COMPLETE message on Cell B (PLMN2) including an ACTIVATE DEFAULT EPS BEARER CONTEXT ACCEPT message.	-->	ATTACH COMPLETE	-	-
15 AA	The SS releases the RRC connection.	-	-	-	-
15 A	The SS configures: - Cell A as a "Serving cell". - Cell B as a "Non-Suitable cell". - Cell C as a "Non-suitable "Off" cell".	-	-	-	-
-	The following messages are to be observed on Cell A unless explicitly stated otherwise.	-	-	-	-
15 B	Check: Does the UE transmit a TRACKING AREA UPDATE REQUEST message?	-->	TRACKING AREA UPDATE REQUEST	2	P
15 C	SS responds with TRACKING AREA UPDATE ACCEPT message.	<--	TRACKING AREA UPDATE ACCEPT	-	-
15 D	The UE transmits a TRACKING AREA UPDATE COMPLETE message	-->	TRACKING AREA UPDATE COMPLETE		
16- 34	Void	-	-	-	-
-	At the end of this test procedure sequence, the UE is in end state E-UTRA connected (E2_T3440) according to TS 36.508.	-	-	-	-

9.2.1.1.7a.3.3 Specific message contents

Table 9.2.1.1.7a.3.3-1: Message ATTACH ACCEPT (step 8, Table 9.2.1.1.7a.3.2-1)

Derivation path: 36.508 table 4.7.2-1			
Information Element	Value/Remark	Comment	Condition
Equivalent PLMNs	-	Includes MCC and MNC digits for PLMN2, PLMN3 and PLMN4.	

Table 9.2.1.1.7a.3.3-2: Message ATTACH ACCEPT (step 14, Table 9.2.1.1.7a.3.2-1)

Derivation path: 36.508 table 4.7.2-1			
Information Element	Value/Remark	Comment	Condition
Equivalent PLMNs	Not present		

9.2.1.1.8 Void

9.2.1.1.9 Attach / Rejected / IMSI invalid

9.2.1.1.9.1 Test Purpose (TP)

(1)

```
with { UE has sent an ATTACH REQUEST message including a PDN CONNECTIVITY REQUEST message }
ensure that {
  when { UE receives an ATTACH REJECT message with the reject cause set to "Illegal UE" }
  then { UE considers the USIM as invalid for EPS services and non-EPS services and enters state
EMM-DEREGISTERED }
}
```

(2)

```
with { UE receives an ATTACH REJECT message with the reject cause set to "Illegal UE" }
ensure that {
  when { the UE has been switched off, then switched on }
  then { the UE sends an ATTACH REQUEST message with IMSI, including a PDN CONNECTIVITY REQUEST
message }
}
```

9.2.1.1.9.2 Conformance requirements

References: The conformance requirements covered in the present TC are specified in: TS 24.301, clause 5.5.1.2.5.

[TS 24.301, clause 5.5.1.2.5]

...

Upon receiving the ATTACH REJECT message, the UE shall stop timer T3410 and take the following actions depending on the reject cause value received.

#3 (Illegal UE); or

...

The UE shall set the EPS update status to EU3 ROAMING NOT ALLOWED (and shall store it according to subclause 5.1.3.3) and shall delete any GUTI, last visited registered TAI and KSI. The UE shall consider the USIM as invalid for EPS services and non-EPS services until switching off or the UICC containing the USIM is removed. Additionally, the UE shall delete the list of equivalent PLMNs and enter state EMM-DEREGISTERED.

If A/Gb mode or Iu mode is supported by the UE, the UE shall in addition handle the MM parameters update status, TMSI, LAI and ciphering key sequence number, and the GMM parameters GMM state, GPRS update status, P-TMSI, P-TMSI signature, RAI and GPRS ciphering key sequence number as specified in 3GPP TS 24.008 [13] for the case when the normal attach procedure is rejected with the GMM cause with the same value.

NOTE: The possibility to configure a UE so that the radio transceiver for a specific RAT is not active, although it is implemented in the UE, is out of scope of the present specification.

...

9.2.1.1.9.3 Test description

9.2.1.1.9.3.1 Pre-test conditions

System Simulator:

- cell A, cell B and If (px_SinglePLMN_Tested = Multi PLMN) cell G:
 - Cell A and Cell B (home PLMN, different TAs),
 - If (px_SinglePLMN_Tested = Multi PLMN), Cell G (another PLMN);
- the different cells may not be simultaneously activated (at most 2 cells are active simultaneously).

UE:

- the UE is configured to initiate EPS attach;
- the UE is previously registered on E-UTRAN, and when on E-UTRAN, the UE is last authenticated and registered on cell A using default message contents according to TS 36.508 [18].

Preamble:

- the UE is in state Switched OFF (state 1) according to TS 36.508 [18].

9.2.1.1.9.3.2 Test procedure sequence

Table 9.2.1.1.9.3.2-1: Main behaviour

St	Procedure	Message Sequence		TP	Verdict
		U - S	Message		
1	The SS configures: - cell A as the "Serving cell". - cell B as a "Non-Suitable cell". - If present, Cell G as a "Non-Suitable Off cell".	-	-	-	-
-	The following messages are to be observed on cell A unless explicitly stated otherwise.	-	-	-	-
2	The UE is switched on.	-	-	-	-
3	The UE transmits an ATTACH REQUEST message including a PDN CONNECTIVITY REQUEST message on cell A.	-->	ATTACH REQUEST	-	-
4	The SS transmits an ATTACH REJECT message with EMM cause = "Illegal UE" as specified.	<--	ATTACH REJECT	-	-
5	The SS releases the RRC connection.	-	-	-	-
6	The SS configures: - Cell A as a "Non-Suitable cell". - Cell B as the "Serving cell".	-	-	-	-
-	The following messages are to be observed on Cell B unless explicitly stated otherwise.	-	-	-	-
7	Check: Does the UE transmit an ATTACH REQUEST message in the next 30 seconds? Note: Cell B belongs to the same PLMN where the UE was rejected but a different TA	-->	ATTACH REQUEST	1	F
8	The operator initiates an attach by MMI or by AT command.	-	-	-	-
9	Check: Does the UE transmit an ATTACH REQUEST message in the next 30 seconds?	-->	ATTACH REQUEST	1	F
10	Void	-	-	-	-
11	Check: Does the test result of CALL generic procedure (TS 36.508 subclause 6.4.2.5) indicate that the UE ignores paging on cell B for PS domain with S-TMSI included in GUTI-1?	-	-	1	-
-	EXCEPTION: Steps 12a1 to 12a4 describe behaviour that depends on the network capability / preference; the "lower case letter" identifies a step sequence that takes place if the network is capable or prefers.	-	-	-	-
12a1	IF (px_SinglePLMN_Tested = Multi PLMN) The SS configures: - Cell A as a "Non-Suitable Off cell". - Cell B as a "Non-Suitable cell". - Cell G as the "Serving cell".	-	-	-	-
-	The following messages are to be observed on Cell G unless explicitly stated otherwise.	-	-	-	-
12a2	Check: Does the UE transmit an ATTACH REQUEST message in the next 30 seconds? Note: Cell G belongs to a PLMN which is not the same like the one on which the UE was rejected.	-->	ATTACH REQUEST	1	F
12a3	The user initiates an attach by MMI or by AT command.	-	-	-	-
12a4	Check: Does the UE transmit an ATTACH REQUEST message in the next 30 seconds?	-->	ATTACH REQUEST	1	F
13-15	Void	-	-	-	-
16	if possible (see ICS) switch off is performed or the USIM is removed. Otherwise the power is removed.				

16 A	The SS configures: - Cell A as a "Non-Suitable cell". - Cell B as the "Serving cell". -If present Cell G as a "Non-Suitable off cell".	-	-	-	-
17	The UE is brought back to operation or the USIM is inserted.	-	-	-	-
17 A	The following messages are to be observed on Cell B unless explicitly stated otherwise	-	-	-	-
18	Void	-	-	-	-
19	Check: Does the UE transmit an ATTACH REQUEST message with IMSI-1?	-->	ATTACH REQUEST	2	P
20- 31	The attach procedure is completed by executing steps 5 to 16 of the UE registration procedure in TS 36.508 sub clause 4.5.2.3.	-	-	-	-
-	At the end of this test procedure sequence, the UE is in end state E-UTRA connected (E2) according to TS 36.508.	-	-	-	-

9.2.1.1.9.3.3 Specific message contents

Table 9.2.1.1.9.3.3-1: Message ATTACH REJECT (steps 4 and 20, Table 9.2.1.1.9.3.2-1)

Derivation path: 36.508 table 4.7.2-3			
Information Element	Value/Remark	Comment	Condition
Security header type	0000	" Plain NAS message, not security protected "	
EMM cause	00000011	#3 "Illegal UE"	
ESM message container	Not present		

Table 9.2.1.1.9.3.3-2: Message ATTACH REQUEST (step 19, Table 9.2.1.1.9.3.2-1)

Derivation path: TS 36.508 table 4.7.2-4			
Information Element	Value/Remark	Comment	Condition
Old GUTI or IMSI	IMSI-1		
ESM message container	PDN CONNECTIVITY REQUEST message to request PDN connectivity to the default PDN		
Last visited registered TAI	Not present		
Old LAI	Not present		
TMSI status	Not present		

9.2.1.1.10 Attach / Rejected / Illegal ME

9.2.1.1.10.1 Test Purpose (TP)

(1)

```

with { UE has sent an ATTACH REQUEST message including a PDN CONNECTIVITY REQUEST message }
ensure that {
  when { UE receives an ATTACH REJECT message with the reject cause set to "Illegal ME" }
  then { UE considers the USIM as invalid for EPS services and non-EPS services and enters state EMM-DEREGISTERED }
}

```

(2)

```

with { UE receives an ATTACH REJECT message with the reject cause set to "Illegal ME" }
ensure that {
  when { the UE has been switched off, then switched on }
  then { the UE sends an ATTACH REQUEST message with IMSI, including a PDN CONNECTIVITY REQUEST message }
}

```

9.2.1.1.10.2 Conformance requirements

References: The conformance requirements covered in the present TC are specified in: TS 24.301, clause 5.5.1.2.5.

[TS 24.301, clause 5.5.1.2.5]

...

Upon receiving the ATTACH REJECT message, the UE shall stop timer T3410 and take the following actions depending on the reject cause value received.

#6 (Illegal ME);

The UE shall set the EPS update status to EU3 ROAMING NOT ALLOWED (and shall store it according to subclause 5.1.3.3) and shall delete any GUTI, last visited registered TAI and KSI. The UE shall consider the USIM as invalid for EPS services and non-EPS services until switching off or the UICC containing the USIM is removed. Additionally, the UE shall delete the list of equivalent PLMNs and enter state EMM-DEREGISTERED.

...

9.2.1.1.10.3 Test description

The test description is identical to the one of subclause 9.2.1.1.9 except that in the test procedure and in the specific message contents, the reject cause #3 "Illegal UE" is replaced with the reject cause #6 "Illegal ME".

9.2.1.1.11 Attach / Rejected / EPS services and non-EPS services not allowed

9.2.1.1.11.1 Test Purpose (TP)

(1)

```
with { UE has sent an ATTACH REQUEST message including a PDN CONNECTIVITY REQUEST message }
ensure that {
  when { UE receives an ATTACH REJECT message with the reject cause set to "EPS services and non-EPS
services not allowed" }
    then { UE considers the USIM as invalid for EPS services and non-EPS services and enters state
EMM-DEREGISTERED }
}
```

(2)

```
with { UE receives an ATTACH REJECT message with the reject cause set to "EPS services and non-EPS
services not allowed" }
ensure that {
  when { the UE has been switched off, then switched on }
    then { the UE sends an ATTACH REQUEST message with IMSI, including a PDN CONNECTIVITY REQUEST
message }
}
```

(3)

```
with { UE receives an ATTACH REJECT message with the reject cause set to "EPS services and non-EPS
services not allowed" }
ensure that {
  when { the UE has been switched off, then switched on and a UMTS or GSM cell is found }
    then { the UE sends an ATTACH REQUEST message with IMSI }
}
```

9.2.1.1.11.2 Conformance requirements

References: The conformance requirements covered in the present TC are specified in: TS 24.301, clause 5.5.1.2.5.

[TS 24.301, clause 5.5.1.2.5]

...

Upon receiving the ATTACH REJECT message, the UE shall stop timer T3410 and take the following actions depending on the reject cause value received.

#8 (EPS services and non-EPS services not allowed);

The UE shall set the EPS update status to EU3 ROAMING NOT ALLOWED (and shall store it according to subclause 5.1.3.3) and shall delete any GUTI, last visited registered TAI and KSI. The UE shall consider the USIM as invalid for EPS services and non-EPS services until switching off or the UICC containing the USIM is removed. Additionally, the UE shall delete the list of equivalent PLMNs and enter state EMM-DEREGISTERED.

If A/Gb mode or Iu mode is supported by the UE, the UE shall in addition handle the MM parameters update status, TMSI, LAI and ciphering key sequence number, and the GMM parameters GMM state, GPRS update status, P-TMSI, P-TMSI signature, RAI and GPRS ciphering key sequence number as specified in 3GPP TS 24.008 [13] for the case when the normal attach procedure is rejected with the GMM cause with the same value.

...

[TS 24.008, clause 4.7.3.2.4]

...

The MS shall then take one of the following actions depending upon the reject cause:

8 (GPRS services and non-GPRS services not allowed);

...

The MS shall set the GPRS update status to GU3 ROAMING NOT ALLOWED (shall store it according to subclause 4.1.3.2) and shall delete any P-TMSI, P-TMSI signature, RAI and GPRS ciphering key sequence number. The new GMM state is GMM-DEREGISTERED. The new MM state is MM IDLE.

The MS shall set the update status to U3 ROAMING NOT ALLOWED, shall delete any TMSI, LAI and ciphering key sequence number. The SIM/USIM shall be considered as invalid for GPRS and non-GPRS services until switching off or the SIM/USIM is removed.

9.2.1.1.11.3 Test description

The test description is identical to the one of subclause 9.2.1.1.9 with the following exceptions:

9.2.1.1.11.3.1 Pre-test conditions

System Simulator:

- cell A, Cell B (home PLMN, different TAs) and if (px_SinglePLMN_Tested = Multi PLMN) Cell G TS 36.508 (another PLMN)
- If (px_RATComb_Tested = EUTRA_UTRA OR px_RATComb_Tested = EUTRA_GERAN) ;
 - if pc_UTRA AND px_RATComb_Tested = EUTRA_UTRA, cell 9 (is configured);
 - if pc_GERAN AND px_RATComb_Tested = EUTRA_GERAN, cell 24 (is configured);
 - system information combination 10 as defined in TS 36.508[18] clause 4.4.3.1 is applied in E-UTRA cells;
- If (px_RATComb_Tested = EUTRA_Only):
 - neither cell 9 nor cell 24 is configured;
 - system information combination 1 as defined in TS 36.508[18] clause 4.4.3.1 is applied in E-UTRA cells;

UE:

- the UE is configured to initiate EPS attach;
- the UE is previously registered on E-UTRAN, and when on E-UTRAN, the UE is last authenticated and registered on cell A using default message contents according to TS 36.508 [18];

- if pc_UTRA AND px_RATComb_Tested = EUTRA_UTRA, the UE is previously registered on UTRAN cell 9 using default message contents according to TS 36.508 [18].
- if pc_GERAN AND px_RATComb_Tested = EUTRA_GERAN, the UE is previously registered on GERAN cell 24 using default message contents according to TS 36.508 [18].

Preamble:

- the UE is in state Switched OFF (state 1) according to TS 36.508 [18].

9.2.1.1.11.3.2 Test procedure sequence

Table 9.2.1.1.11.3.2-1: Main behaviour

St	Procedure	Message Sequence		TP	Verdict
		U - S	Message		
1	The SS configures: - Cell A as the "Serving cell". - Cell B as a "Non-Suitable cell". - If present, Cell G as a "Non-Suitable cell".	-	-	-	-
-	The following messages are to be observed on Cell A unless explicitly stated otherwise.	-	-	-	-
2	The UE is switched on.	-	-	-	-
3	The UE transmits an ATTACH REQUEST message including a PDN CONNECTIVITY REQUEST message.	-->	ATTACH REQUEST	-	-
4	The SS transmits an ATTACH REJECT message with EMM cause = "EPS services and non-EPS services not allowed" as specified.	<--	ATTACH REJECT	-	-
5	The SS releases the RRC connection.	-	-	-	-
6	The SS configures: - Cell A as a "Non-Suitable cell". - Cell B as the "Serving cell".	-	-	-	-
-	The following messages are to be observed on Cell B unless explicitly stated otherwise.	-	-	-	-
7	Check: Does the UE transmit an ATTACH REQUEST message in the next 30 seconds? Note: Cell B belongs to the same PLMN where the UE was rejected but a different TA	-->	ATTACH REQUEST	1	F
8	The operator initiates an attach by MMI or by AT command.	-	-	-	-
9	Check: Does the UE transmit an ATTACH REQUEST message in the next 30 seconds?	-->	ATTACH REQUEST	1	F
10	Void	-	-	-	-
11	Check: Does the test result of CALL generic procedure (TS 36.508 subclause 6.4.2.5) indicate that the UE ignores paging on cell B for PS domain with S-TMSI included in GUTI-1?	-	-	1	-
-	EXCEPTION: Steps 12a1 to 12a4 describe behaviour that depends on the network capability / preference; the "lower case letter" identifies a step sequence that takes place if the network is capable or prefers.	-	-	-	-
12a1	IF (px_SinglePLMN_Tested = Multi PLMN) The SS configures: - Cell A as a "Non-Suitable "off" cell". - Cell B as a "Non-Suitable cell". - Cell G as the "Serving cell".	-	-	-	-
-	The following messages are to be observed on Cell G unless explicitly stated otherwise.	-	-	-	-
12a2	Check: Does the UE transmit an ATTACH REQUEST message in the next 30 seconds? Note: Cell G belongs to a PLMN which is not the same like the one on which the UE was rejected.	-->	ATTACH REQUEST	1	F
12a3	The user initiates an attach by MMI or by AT command.	-	-	-	-
12a4	Check: Does the UE transmit an ATTACH REQUEST message in the next 30 seconds?	-->	ATTACH REQUEST	1	F
13-15	Void	-	-	-	-
16	If possible (see ICS) switch off is performed or the USIM is removed.	-	-	-	-

	Otherwise the power is removed.				
16 A	The SS configures: - Cell A as a "Non-Suitable cell". - Cell B as the "Serving cell". -If present, Cell G as a "Non-Suitable off cell".	-	-	-	-
17	The UE is brought back to operation or the USIM is inserted.	-	-	-	-
18	The following message is sent on Cell B.	-	-	-	-
19	Check: Does the UE transmit an ATTACH REQUEST message with IMSI-1?	-->	ATTACH REQUEST	2	P
20	The SS transmits an ATTACH REJECT message with EMM cause = "EPS services and non-EPS services not allowed" as specified.	<--	ATTACH REJECT	-	-
20 A	The SS releases the RRC connection.	-	-	-	-
-	EXCEPTION: Steps 21a1 to 21a10 describe behaviour that depends on the UE capability.	-	-	-	-
21a 1	IF pc_UTRA AND px_RATComb_Tested = EUTRA_UTRA OR pc_GERAN AND px_RATComb_Tested = EUTRA_GERAN THEN the SS sets - Cell B as a "Non-Suitable cell". - Cell 24 (GERAN) or Cell 9 (UTRAN) as the "Serving cell".	-	-	-	-
-	The following messages are to be observed on Cell 24 or Cell 9 (depending on which cell was set as "Serving cell" in the preceding step) unless explicitly stated otherwise.	-	-	-	-
21a 2	Check: Does the UE transmit an ATTACH REQUEST message in the next 30 seconds?	-->	ATTACH REQUEST	1	F
21a 3	The user initiates an attach by MMI or by AT command.	-	-	-	-
21a 4	Check: Does the UE transmit an ATTACH REQUEST message in the next 30 seconds?	-->	ATTACH REQUEST	1	F
21a 5	If possible (see ICS) switch off is performed or the USIM is removed. Otherwise the power is removed.	-	-	-	-
21a 6	The UE is brought back to operation or the USIM is inserted.	-	-	-	-
-	EXCEPTION: Steps 21a6a1, 21a6a2 describe behaviour that depends on the UE capability; the "lower case letter" identifies a step sequence that take place if pc_AutomaticAttachSwitchON is NOT supported	-	-	-	-
21a 6A a1	IF NOT pc_AutomaticAttachSwitchON	-	Registration on CS	-	-
21a 6A a2	IF NOT pc_AutomaticAttachSwitchON the user initiates an attach by MMI or by AT command.	-	-	-	-
21a 7	Void	-	-	-	-
21a 8	Check: Does the UE transmit an ATTACH REQUEST message with IMSI-1?	-->	ATTACH REQUEST	3	P
22	The attach procedure is completed	-	-	-	-
-	If (px_RATComb_Tested = EUTRA_UTRA OR px_RATComb_Tested = EUTRA_GERAN); At the end of this test procedure sequence, the UE is in end state either U1_IDLE or G1_IDLE E-UTRA connected (E2) according to TS 36.508. Else: At the end of this test procedure sequence, the UE is in end state E-UTRA deregistered (E4) according to TS 36.508.	-	-	-	-

9.2.1.1.11.3.3 Specific message contents

Table 9.2.1.1.11.3.3-1: Message ATTACH REJECT (steps 4 and 20, Table 9.2.1.1.11.3.2-1)

Derivation path: 36.508 table 4.7.2-3			
Information Element	Value/Remark	Comment	Condition
Security header type	0000	" Plain NAS message, not security protected "	
EMM cause	00001000	#8 "EPS services and non-EPS services not allowed"	
ESM message container	Not present		

Table 9.2.1.1.11.3.3-2: Message ATTACH REQUEST (step 19, Table 9.2.1.1.11.3.2-1)

Derivation path: TS 36.508 table 4.7.2-4			
Information Element	Value/Remark	Comment	Condition
Old GUTI or IMSI	IMSI-1		
ESM message container	PDN CONNECTIVITY REQUEST message to request PDN connectivity to the default PDN		
Last visited registered TAI	Not present		
Old LAI	Not present		
TMSI status	Not present		

Table 9.2.1.1.11.3.3-3: Message ATTACH REQUEST (step 21a8, Table 9.2.1.1.11.3.2-1)

Derivation path: TS 24.008 table 9.4.1			
Information Element	Value/Remark	Comment	Condition
MS network capability	Not checked		
Attach type	Not checked		
GPRS ciphering key sequence number	111	No key is available	
DRX parameter	Not checked		
P-TMSI or IMSI	IMSI-1		
Old routing area identification	Deleted RAI-1	The MNC and the MCC in the coding of the RAI are replaced by the RAC of RAC-1	
MS Radio Access capability	Not checked		
Old P-TMSI signature	Not present		
Requested READY timer Value	Not checked		
TMSI status	Not checked		
PS LCS Capability	Not checked		
Mobile station classmark 2	Not checked		
Mobile station classmark 3	Not checked		
Supported Codecs	Not checked		
UE network capability	Not checked		
Additional mobile identity	Not present		
Additional old routing area identification	Not present		

9.2.1.1.12 Attach / Rejected / EPS services not allowed

9.2.1.1.12.1 Test Purpose (TP)

(1)

```
with { UE has sent an ATTACH REQUEST message including a PDN CONNECTIVITY REQUEST message }
ensure that {
  when { UE receives an ATTACH REJECT message with the reject cause set to "EPS services not
allowed" }
  then { UE deletes the GUTI and the last visited registered TAI and KSI and considers the USIM as
invalid for EPS services until switching off or the UICC containing the USIM is removed and deletes
the list of equivalent PLMNs and UE enters state EMM-DEREGISTERED }
}
```

9.2.1.1.12.2 Conformance requirements

References: The conformance requirements covered in the present TC are specified in: TS 24.301, clauses 5.5.1.2.2 and 5.5.1.2.5.

[TS 24.301, clause 5.5.1.2.2]

In state EMM-DEREGISTERED, the UE initiates the attach procedure by sending an ATTACH REQUEST message to the MME, starting timer T3410 and entering state EMM-REGISTERED-INITIATED (see example in figure 5.5.1.2.2.1). If timer T3402 is currently running, the UE shall stop timer T3402. If timer T3411 is currently running, the UE shall stop timer T3411.

If the UE supports neither A/Gb mode nor Iu mode, the UE shall handle the Old GUTI or IMSI IE in the ATTACH REQUEST message as follows:

- The UE shall include in the ATTACH REQUEST message a valid GUTI together with the last visited registered TAI, if available. If there is no valid GUTI available, the UE shall include the IMSI in the ATTACH REQUEST message.

...

[TS 24.301, clause 5.5.1.2.5]

...

Upon receiving the ATTACH REJECT message, the UE shall stop timer T3410 and take the following actions depending on the reject cause value received.

#7 (EPS services not allowed);

The UE shall set the EPS update status to EU3 ROAMING NOT ALLOWED (and shall store it according to subclause 5.1.3.3) and shall delete any GUTI, last visited registered TAI and KSI. The UE shall consider the USIM as invalid for EPS services until switching off or the UICC containing the USIM is removed. Additionally, the UE shall delete the list of equivalent PLMNs and enter state EMM-DEREGISTERED.

If A/Gb mode or Iu mode is supported by the UE, the UE shall in addition handle the GMM parameters GMM state, GPRS update status, P-TMSI, P-TMSI signature, RAI and GPRS ciphering key sequence number as specified in 3GPP TS 24.008 [6] for the case when the normal attach procedure is rejected with the GMM cause with the same value.

9.2.1.1.12.3 Test description

9.2.1.1.12.3.1 Pre-test conditions

System Simulator:

- cell A, cell B and cell G:
 - cell A and cell B (HPLMN, different TAs), if (px_SinglePLMN_Tested = Multi PLMN) cell G (another PLMN);

- If (px_RATComb_Tested = EUTRA_UTRA OR px_RATComb_Tested = EUTRA_GERAN) ;
 - if pc_UTRA, AND px_RATComb_Tested = EUTRA_UTRA cell 9 (HPLMN, UTRAN);
 - if pc_GERAN AND px_RATComb_Tested = EUTRA_GERAN, cell 24 (HPLMN, GERAN);
- If (px_RATComb_Tested = EUTRA_Only):
 - neither cell 9 nor cell 24 is configured;
- system information combination 1 as defined in TS 36.508[18] clause 4.4.3.1 is applied in E-UTRA cells;
- the different cells may not be simultaneously activated (at most 2 cells are active simultaneously);

UE:

- the UE is configured to initiate EPS attach;
- the UE is previously registered on E-UTRAN, and when on E-UTRAN, the UE is last authenticated and registered on cell A using default message contents according to TS 36.508 [18];
- if pc_UTRA AND px_RATComb_Tested = EUTRA_UTRA, the UE is previously registered on UTRAN cell 9 using default message contents according to TS 36.508 [18].
- if pc_GERAN AND px_RATComb_Tested = EUTRA_GERAN, the UE is previously registered on GERAN cell 24 using default message contents according to TS 36.508 [18].

Preamble:

- the UE is in state Switched OFF (state 1) according to TS 36.508 [18].

9.2.1.1.12.3.2 Test procedure sequence

Table 9.2.1.1.12.3.2-1: Main behaviour

St	Procedure	Message Sequence		TP	Verdict
		U - S	Message		
1	The SS configures: - Cell A as the "Serving cell". - Cell B as a " Suitable neighbour cell". - If present, Cell G as a "Non-Suitable Off cell". - If present, Cell 9 or 24 as a "Non-Suitable Off cell".	-	-	-	-
-	The following messages are to be observed on Cell A unless explicitly stated otherwise.	-	-	-	-
2	The user switches the UE on.	-	-	-	-
3	The UE transmits an ATTACH REQUEST message including a PDN CONNECTIVITY REQUEST message.	-->	ATTACH REQUEST	-	-
4	The SS transmits an ATTACH REJECT message with EMM cause = "EPS services not allowed".	<--	ATTACH REJECT	-	-
5	The SS releases the RRC connection.	-	-	-	-
6	The SS reconfigures: Cell A as a " Suitable neighbour cell". Cell B as the "Serving cell". Note: Cell A and Cell B are in different TAIs – same PLMN.	-	-	-	-
-	The following messages are to be observed on Cell B unless explicitly stated otherwise.	-	-	-	-
7	Check: Does the UE transmit an ATTACH REQUEST message in the next 30 seconds?	-->	ATTACH REQUEST	1	F
8	The user initiates an attach by MMI or by AT command.	-	-	-	-
9	Check: Does the UE transmit an ATTACH REQUEST message in the next 30 seconds?	-->	ATTACH REQUEST	1	F
-	EXCEPTION: Steps 10a1 to 10a6 describe behaviour that depends on the UE capability.	-	-	-	-
10a1	IF pc_UTRA AND px_RATComb_Tested = EUTRA_UTRA OR pc_GERAN AND px_RATComb_Tested = EUTRA_GERAN THEN the SS configures - Cell A as "Non-suitable Off cell" - Cell B as a " Suitable neighbour cell". - Cell 24 (GERAN) or 9 (UTRAN) as the "Serving cell". Note: Cell B and Cell 24 (GERAN) or 9 (UTRAN) are in different PLMNs	-	-	-	-
10a2	Void	-	-	-	-
-	EXCEPTION: The following messages are to be observed on Cell 24 or Cell 9 (depending on which cell was set as "Serving cell" in the preceding step) unless explicitly stated otherwise.	-	-	-	-
-	EXCEPTION: Depending on UE capabilities the behaviour in table 9.2.1.1.12.3.2-2 occurs in parallel with step 10a3.	-	-	-	-
-	EXCEPTION: The behaviour in table 9.2.1.1.12.3.2-2 occurs in parallel with step 10a3.	-	-	-	-
10a3	Check: Does the UE transmit an ATTACH REQUEST message in the next 2 minutes?	-->	ATTACH REQUEST	1	F
10a4	The user initiates an attach by MMI or by AT command.	-	-	-	-

10a5	Check : Does the UE transmit an ATTACH REQUEST message in the next 30 seconds?	-->	ATTACH REQUEST	1	F
10a6	The SS configures cell 24 or cell 9 as " Non-Suitable Off cell".	-	-	-	-
-	EXCEPTION: Steps 11a1 to 11a4 describe behaviour that depends on the network capability / preference; the "lower case letter" identifies a step sequence that takes place if the network is capable or prefers.	-	-	-	-
11a1	If (px_SinglePLMN_Tested = Multi PLMN) The SS sets: - Cell B as a "Non-Suitable Off cell". - Cell G as the "Serving cell". Note: Cell B and Cell G are different PLMNs.	-	-	-	-
-	The following messages are to be observed on Cell G unless explicitly stated otherwise.	-	-	-	-
11a2	Check: Does the UE transmit an ATTACH REQUEST message in the next 60 seconds?	-->	ATTACH REQUEST	1	F
11a3	The operator initiates an attach by MMI or by AT command.	-	-	-	-
11a4	Check: Does the UE transmit an ATTACH REQUEST message in the next 30 seconds?	-->	ATTACH REQUEST	1	F
-	At the end of this test procedure sequence, the UE is in end state E-UTRA deregistered (E4) according to TS 36.508.	-	-	-	-

Table 9.2.1.1.12.3.2-2: Parallel behaviour

St	Procedure	Message Sequence		TP	Verdict
		U - S	Message		
-	EXCEPTION: Steps 1a1-1a 5 describe a behaviour which depends on the UE capability; the "lower case letter" identifies a step sequence that take place if a capability is supported.	-	-	-	-
1a1	IF pc_CS THEN the UE transmits a LOCATION UPDATING REQUEST message.	-->	LOCATION UPDATING REQUEST	-	-
-	EXCEPTION: The messages in the next two steps are sent only IF pc_GERAN AND px_RATComb_Tested = EUTRA_GERAN	-	-	-	-
1a2a 1	The UE transmits a <i>Classmark Change</i> message	-->	CLASSMARK CHANGE	-	-
1a2a 2	IF pc_UTRA THEN the UE transmits a <i>Utran Classmark Change</i> message.	-->	UTRAN CLASSMARK CHANGE.	-	-
1a3	The SS transmits an AUTHENTICATION REQUEST message to initiate the authentication and AKA procedure.	<--	AUTHENTICATION REQUEST	-	-
1a4	The UE transmits an AUTHENTICATION RESPONSE message.	-->	AUTHENTICATION RESPONSE	-	-
1a5	The SS transmits a LOCATION UPDATING ACCEPT message including IMSI-1	<--	LOCATION UPDATING ACCEPT	-	-

9.2.1.1.12.3.3 Specific message contents

Table 9.2.1.1.12.3.3-1: Message ATTACH REJECT (step 4, Table 9.2.1.1.12.3.2-1)

Derivation path: 36.508 table 4.7.2-3 (This message is transmitted as a "plain NAS message")			
Information Element	Value/Remark	Comment	Condition
Security header type	0000	"Plain NAS message, not security protected"	
EMM cause	00000111	#7 "EPS services not allowed"	
ESM message container	Not present		

Table 9.2.1.1.12.3.3-2: LOCATION UPDATING ACCEPT (step 5, Table 9.2.1.1.12.3.2-2)

Derivation Path: TS 36.508 Table 4.7B.2-5			
Information Element	Value/remark	Comment	Condition
Mobile identity			
IMSI	IMSI-1		

9.2.1.1.13 Attach / Rejected / PLMN not allowed

9.2.1.1.13.1 Test Purpose (TP)

(1)

```
with { the UE has sent an ATTACH REQUEST message including a PDN CONNECTIVITY REQUEST message }
ensure that {
  when { the UE receives an ATTACH REJECT message with the reject cause set to "PLMN not allowed" }
  then { the UE deletes the GUTI, the last visited registered TAI, KSI, the list of equivalent
  PLMNs and UE enters state EMM-DEREGISTERED.PLMN-SEARCH and UE stores the PLMN in the "forbidden PLMN
  list" in the USIM }
}
```

(2)

```
with { the UE is switched off and a PLMN is stored in the "forbidden PLMN list" in the USIM }
ensure that {
  when { the UE is switched on }
  then { the UE doesn't attempt to attach on this PLMN }
}
```

(3)

```
with { the UE in E-UTRA EMM-DEREGISTERED.PLMN-SEARCH state and a PLMN is stored in the "forbidden
PLMN list" }
ensure that {
  when { the UE detects a cell belonging to a PLMN which is not in the "forbidden PLMN list" }
  then { the UE attaches to this PLMN }
}
```

(4)

```
with {the UE in E-UTRA EMM-DEREGISTERED.PLMN-SEARCH state and a PLMN is stored in the "forbidden
PLMN list" }
ensure that {
  when { the forbidden PLMN is selected manually }
  then { the UE attaches to the forbidden PLMN and deletes this PLMN from the USIM}
}
```

9.2.1.1.13.2 Conformance requirements

References: The conformance requirements covered in the present TC are specified in: TS 24.301, clauses 5.5.1.2.2 and 5.5.1.2.5.

[TS 24.301, clause 5.5.1.2.2]

In state EMM-DEREGISTERED, the UE initiates the attach procedure by sending an ATTACH REQUEST message to the MME, starting timer T3410 and entering state EMM-REGISTERED-INITIATED (see example in figure

5.5.1.2.2.1). If timer T3402 is currently running, the UE shall stop timer T3402. If timer T3411 is currently running, the UE shall stop timer T3411.

If the UE supports neither A/Gb mode nor Iu mode, the UE shall handle the Old GUTI or IMSI IE in the ATTACH REQUEST message as follows:

- The UE shall include in the ATTACH REQUEST message a valid GUTI together with the last visited registered TAI, if available. If there is no valid GUTI available, the UE shall include the IMSI in the ATTACH REQUEST message.

If the UE supports A/Gb mode or Iu mode, the UE shall handle the Old GUTI or IMSI IE as follows:

...

- If the TIN indicates "GUTI" or "RAT-related TMSI" and the UE holds a valid GUTI, the UE shall indicate the GUTI in the Old GUTI or IMSI IE.

...

- Otherwise the UE shall include the IMSI in the Old GUTI or IMSI IE.

...

[TS 24.301, clause 5.5.1.2.5]

If the attach request cannot be accepted by the network, the MME shall send an ATTACH REJECT message to the UE including an appropriate EMM cause value.

...

Upon receiving the ATTACH REJECT message, the UE shall stop timer T3410 and take the following actions depending on the EMM cause value received.

...

#11 (PLMN not allowed);

The UE shall set the EPS update status to EU3 ROAMING NOT ALLOWED (and shall store it according to subclause 5.1.3.3) and shall delete any GUTI, last visited registered TAI and KSI. Additionally, the UE shall delete the list of equivalent PLMNs and reset the attach attempt counter, and enter state EMM-DEREGISTERED.PLMN-SEARCH.

In S1 mode, the UE shall store the PLMN identity in the "forbidden PLMN list" and enter state EMM-DEREGISTERED.PLMN-SEARCH. The UE shall perform a PLMN selection according to 3GPP TS 23.122 [6].

...

If A/Gb mode or Iu mode is supported by the UE, the UE shall in addition handle the MM parameters update status, TMSI, LAI, ciphering key sequence number and location update attempt counter, and the GMM parameters GMM state, GPRS update status, P-TMSI, P-TMSI signature, RAI, GPRS ciphering key sequence number and GPRS attach attempt counter as specified in 3GPP TS 24.008 [13] for the case when the normal attach procedure is rejected with the GMM cause with the same value and no RR connection exists.

9.2.1.1.13.3 Test description

9.2.1.1.13.3.1 Pre-test conditions

System Simulator:

- cell G, cell H (VPLMN, same MCC like HPLMN, different TAs) and cell I (VPLMN, different MCC from HPLMN);
- the cells are configured according to Table 6.3.2.2-1 and Table 6.3.2.2-3 in 36.508[18], except replacing f3 with f1;

- the cells may not be simultaneously activated.

UE:

- the UE is previously registered on E-UTRAN, and when on E-UTRAN, the UE is last authenticated and registered on cell G using default message contents according to TS 36.508 [18];
- the "forbidden PLMN list" is empty;
- the UE is configured to initiate EPS attach.

Preamble:

- the UE is in state Switched OFF (state 1) according to TS 36.508 [18].

9.2.1.1.13.3.2 Test procedure sequence

Table 9.2.1.1.13.3.2-1: Main behaviour

St	Procedure	Message Sequence		TP	Verdict
		U - S	Message		
1	The SS configures: - Cell G as the "Serving cell". - Cell H as a " Suitable Neighbour cell". - Cell I as a "Non-Suitable Off cell". Note: Cell G and Cell H are in the different TAI – same PLMN.	-	-	-	-
-	The following messages are to be observed on Cell G unless explicitly stated otherwise.	-	-	-	-
2	The UE is switched on.	-	-	-	-
3	The UE transmits an ATTACH REQUEST message including a PDN CONNECTIVITY REQUEST message.	-->	ATTACH REQUEST	-	-
4	The SS transmits an ATTACH REJECT message including EMM cause = "PLMN not allowed".	<--	ATTACH REJECT	-	-
5	The SS releases the RRC connection.	-	-	-	-
6	Check: Does the UE transmit an ATTACH REQUEST message on cell G or H in the next 30 seconds?	-->	ATTACH REQUEST	1	F
7	If possible (see ICS) switch off is performed or the USIM is removed. Otherwise the power is removed.	-	-	-	-
8	The UE is brought back to operation or the USIM is inserted.	-	-	-	-
9	Check: Does the UE transmit an ATTACH REQUEST message in the next 90 seconds?	-->	ATTACH REQUEST	2	F
10	The SS configures: - Cell G as the "Serving cell" - Cell H as a "Non-Suitable Off cell" - Cell I as a " Suitable neighbour cell".	-	-	-	-
11	The following messages are to be observed on Cell I unless explicitly stated otherwise.	-	-	-	-
12	Check: Does the UE transmit an ATTACH REQUEST message including a PDN CONNECTIVITY REQUEST message as specified?	-->	ATTACH REQUEST	1, 3	P
12 A-12 M	The attach procedure is completed and the RRC connection is released by executing steps 5 to 17 of the UE registration procedure in TS 36.508 clause 4.5.2.3.	-	-	-	-
13 - 19	Void	-	-	-	-
20	If possible (see ICS) switch off is performed or the USIM is removed. Otherwise the power is removed.	-	-	-	-
-	EXCEPTION: Step 21 describes behaviour that depends on the UE capability.				
21	If pc_SwitchOnOff or pc_USIM_Removal then the UE transmits a DETACH REQUEST message.	-->	DETACH REQUEST	-	-
22	The SS configures: - Cell G as the "Serving cell" - Cell I as a "Non-suitable Off cell". Note: Cell G belongs to the forbidden PLMN.	-	-	-	-
23	The UE is brought back to operation or the USIM is inserted.	-	-	-	-
24	The following messages are to be observed on Cell G unless explicitly stated otherwise.	-	-	-	-
25	The user sets the UE in manual PLMN	-	-	-	-

	selection mode or requests a PLMN search.				
26	The user selects PLMN of cell G.	-	-	-	-
27	Check: Does the UE transmit an ATTACH REQUEST message including a PDN CONNECTIVITY REQUEST message as specified?	-->	ATTACH REQUEST	4	P
28-40	The attach procedure is completed and the RRC connection is released by executing steps 5 to 17 of the UE registration procedure in TS 36.508 clause 4.5.2.3.	-	-	-	-
-	At the end of this test procedure sequence, the UE is in end state E-UTRA idle (E1) according to TS 36.508.	-	-	-	-

9.2.1.1.13.3.3 Specific message contents

Table 9.2.1.1.13.3.3-1: Message ATTACH REJECT (step 4, Table 9.2.1.1.13.3.2-1)

Derivation path: 36.508 table 4.7.2-3 (Plain NAS message)			
Information Element	Value/Remark	Comment	Condition
Security header type	0000	"No security protection" #11 "PLMN not allowed"	
EMM cause	00001011		
ESM message container	Not present		

Table 9.2.1.1.13.3.3-2: Message ATTACH REQUEST (step 12, Table 9.2.1.1.13.3.2-1)

Derivation path: 36.508 table 4.7.2-4			
Information Element	Value/Remark	Comment	Condition
Old GUTI or IMSI	IMSI-1	GUTI has been deleted after receiving ATTACH REJECT at step 5; only IMSI is available. TAI has been deleted after receiving ATTACH REJECT at step 5.	
Last visited registered TAI	Not present		

Table 9.2.1.1.13.3.3-3: Message ATTACH REQUEST (step 27, Table 9.2.1.1.13.3.2-1)

Derivation path: 36.508 table 4.7.2-4			
Information Element	Value/Remark	Comment	Condition
Old GUTI or IMSI	GUTI allocated in step 18	TAI 9 is allocated on Cell I according to 36.508 table 6.3.2.2-1	
Last visited registered TAI	TAI-9		

9.2.1.1.13a Attach / Rejected / PLMN not allowed / Single Frequency operation

9.2.1.1.13a.1 Test Purpose (TP)

Same test purpose as in clause 9.2.1.1.13.1

9.2.1.1.13a.2 Conformance requirements

Same conformance requirements as in clause 9.2.1.1.13.2

9.2.1.1.13a.3 Test description

9.2.1.1.13a.3.1 Pre-test conditions

System Simulator:

- cell A (belongs to TAI-7, visited PLMN, MCC = MCC in USIM MNC=02),
- cell B (belongs to TAI-8, visited PLMN, MCC = MCC in USIM MNC=02)) and
- cell C (belongs to TAI-9, visited PLMN, MCC=002 MNC=101);
- the cells may not be simultaneously activated.

UE:

- the UE is previously registered on E-UTRAN, and when on E-UTRAN, the UE is last authenticated and registered on cell A using default message contents according to TS 36.508 [18];
- the "forbidden PLMN list" is empty;
- the UE is configured to initiate EPS attach.

Preamble:

- the UE is in state Switched OFF (state 1) according to TS 36.508 [18].

9.2.1.1.13a.3.2 Test procedure sequence

Table 9.2.1.1.13a.3.2-1: Main behaviour

St	Procedure	Message Sequence		TP	Verdict
		U - S	Message		
1	The SS configures: - Cell A as the "Serving cell". - Cell B as a " Suitable Neighbour cell". - Cell C as a "Non-Suitable Off cell". Note: Cell A and Cell B are in the different TAI – same PLMN.	-	-	-	-
-	The following messages are to be observed on Cell A unless explicitly stated otherwise.	-	-	-	-
2	The UE is switched on.	-	-	-	-
3	The UE transmits an ATTACH REQUEST message including a PDN CONNECTIVITY REQUEST message.	-->	ATTACH REQUEST	-	-
4	The SS transmits an ATTACH REJECT message including EMM cause = "PLMN not allowed".	<--	ATTACH REJECT	-	-
5	The SS releases the RRC connection.	-	-	-	-
6	Check: Does the UE transmit an ATTACH REQUEST message on cell A or B in the next 30 seconds?	-->	ATTACH REQUEST	1	F
7	If possible (see ICS) switch off is performed or the USIM is removed. Otherwise the power is removed.	-	-	-	-
8	The UE is brought back to operation or the USIM is inserted.	-	-	-	-
9	Check: Does the UE transmit an ATTACH REQUEST message in the next 90 seconds?	-->	ATTACH REQUEST	2	F
10	The SS configures: - Cell A as the " Suitable neighbour intrafrequency cell" - Cell B as a "Non-Suitable Off cell" - Cell C as a " Serving cell".	-	-	-	-
11	The following messages are to be observed on Cell C unless explicitly stated otherwise.	-	-	-	-
12	Check: Does the UE transmit an ATTACH REQUEST message including a PDN CONNECTIVITY REQUEST message as specified?	-->	ATTACH REQUEST	1, 3	P
12 A-12 M	The attach procedure is completed and the RRC connection is released by executing steps 5 to 17 of the UE registration procedure in TS 36.508 clause 4.5.2.3.	-	-	-	-
13-19	Void	-	-	-	-
20	If possible (see ICS) switch off is performed or the USIM is removed. Otherwise the power is removed.	-	-	-	-
-	EXCEPTION: Step 21 describes behaviour that depends on the UE capability.				
21	If pc_SwitchOnOff or pc_USIM_Removal then the UE transmits a DETACH REQUEST message.	-->	DETACH REQUEST	-	-
22	The SS configures: - Cell A as the "Serving cell" - Cell C as a "Non-suitable Off cell". Note: Cell A belongs to the forbidden PLMN.	-	-	-	-
23	The UE is brought back to operation or the USIM is inserted.	-	-	-	-
24	The following messages are to be observed on	-	-	-	-

	Cell A unless explicitly stated otherwise.				
25	The user sets the UE in manual PLMN selection mode or requests a PLMN search.	-	-	-	-
26	The user selects PLMN of cell A.	-	-	-	-
27	Check: Does the UE transmit an ATTACH REQUEST message including a PDN CONNECTIVITY REQUEST message as specified?	-->	ATTACH REQUEST	4	P
28-40	The attach procedure is completed and the RRC connection is released by executing steps 5 to 17 of the UE registration procedure in TS 36.508 clause 4.5.2.3.	-	-	-	-
-	At the end of this test procedure sequence, the UE is in end state E-UTRA idle (E1) according to TS 36.508.	-	-	-	-

9.2.1.1.13a.3.3 Specific message contents

Table 9.2.1.1.13a.3.3-1: Message ATTACH REJECT (step 4, Table 9.2.1.1.13a.3.2-1)

Derivation path: 36.508 table 4.7.2-3 (Plain NAS message)			
Information Element	Value/Remark	Comment	Condition
Security header type	0000	"No security protection" #11 "PLMN not allowed"	
EMM cause	00001011		
ESM message container	Not present		

Table 9.2.1.1.13a.3.3-2: Message ATTACH REQUEST (step 12, Table 9.2.1.1.13a.3.2-1)

Derivation path: 36.508 table 4.7.2-4			
Information Element	Value/Remark	Comment	Condition
Old GUTI or IMSI	IMSI-1	GUTI has been deleted after receiving ATTACH REJECT at step 5; only IMSI is available. TAI has been deleted after receiving ATTACH REJECT at step 5.	
Last visited registered TAI	Not present		

Table 9.2.1.1.13a.3.3-3: Message ATTACH REQUEST (step 27, Table 9.2.1.1.13a.3.2-1)

Derivation path: 36.508 table 4.7.2-4			
Information Element	Value/Remark	Comment	Condition
Old GUTI or IMSI Last visited registered TAI	GUTI allocated in step 18 TAI-9	TAI 9 is allocated on Cell C according to 36.508 table 6.3.2.2-1	

9.2.1.1.14 Attach / Rejected / Tracking area not allowed

9.2.1.1.14.1 Test Purpose (TP)

(1)

with { UE has sent an ATTACH REQUEST message including a PDN CONNECTIVITY REQUEST message }
ensure that {

```

when { UE receives an ATTACH REJECT message with the reject cause set to "Tracking area not
allowed" }
then { UE sets the EPS update status to EU3 ROAMING NOT ALLOWED, UE deletes the GUTI, last
visited registered TAI and KSI, UE enters the state EMM-DEREGISTERED.LIMITED-SERVICE and UE stores
the current TAI in the list of "forbidden tracking areas for regional provision of service" }
}

```

(2)

```

with { UE is in EMM-DEREGISTERED.LIMITED-SERVICE state and the current TAI in the list of "forbidden
tracking areas for regional provision of service"}
ensure that {
when { serving cell belongs to TAI where UE was rejected }
then { UE does not attempt to attach on any other cell }
}

```

(3)

```

with { UE is in EMM-DEREGISTERED.LIMITED-SERVICE state and the current TAI in the list of "forbidden
tracking areas for regional provision of service"}
ensure that {
when { UE re-selects a new cell in the same TAI it was already rejected }
then { UE does not attempt to attach }
}

```

(4)

```

with { UE is in EMM-DEREGISTERED.LIMITED-SERVICE state and the current TAI in the list of "forbidden
tracking areas for regional provision of service"}
ensure that {
when { UE enters a cell belonging to a tracking area not in the list of "forbidden tracking areas
for regional provision of service"}
then { UE attempts to attach with IMSI }
}

```

(5)

```

with { UE is in EMM-DEREGISTERED.LIMITED-SERVICE state and the list of "forbidden tracking areas for
regional provision of service" contains more than one TAI}
ensure that {
when { UE re-selects a cell belonging to one of the TAIs in the list of "forbidden tracking areas
for regional provision of service" }
then { UE does not attempt to attach }
}

```

(6)

```

with { UE is switched off }
ensure that {
when { UE is powered on in the cell belonging to the TAI which was in the list of "forbidden
tracking areas for regional provision of service" before the UE was switched off }
then { UE performs registration on that cell }
}

```

9.2.1.1.14.2 Conformance requirements

References: The conformance requirements covered in the present TC are specified in: TS 24.301, clauses 5.3.2, 5.5.1.2.2, 5.5.1.2.5, 5.2.2.3.2, Annex C and TS 36.304 clause 4.3.

[TS 24.301, clause 5.3.2]

The UE shall store a list of "forbidden tracking areas for roaming", as well as a list of "forbidden tracking areas for regional provision of service". These lists shall be erased when the UE is switched off or when the UICC containing the USIM is removed, and periodically (with a period in the range 12 to 24 hours).

...

In S1 mode, the UE shall update the suitable list whenever an ATTACH REJECT, TRACKING AREA UPDATE REJECT, SERVICE REJECT or DETACH REQUEST message is received with the EMM cause #12 "tracking area not allowed", #13 "roaming not allowed in this tracking area", or #15 "no suitable cells in tracking area".

Each list shall accommodate 40 or more TAIs. When the list is full and a new entry has to be inserted, the oldest entry shall be deleted.

[TS 24.301, clause 5.5.1.2.2]

In state EMM-DEREGISTERED, the UE initiates the attach procedure by sending an ATTACH REQUEST message to the MME, starting timer T3410 and entering state EMM-REGISTERED-INITIATED (see example in figure 5.5.1.2.2.1).

...

If the UE supports neither A/Gb mode nor Iu mode, the UE shall handle the Old GUTI or IMSI IE in the ATTACH REQUEST message as follows:

- The UE shall include in the ATTACH REQUEST message a valid GUTI together with the last visited registered TAI, if available. If there is no valid GUTI available, the UE shall include the IMSI in the ATTACH REQUEST message.

If the UE supports A/Gb mode or Iu mode, the UE shall handle the Old GUTI or IMSI IE as follows:

...

- If the TIN indicates "GUTI" or "RAT-related TMSI" and the UE holds a valid GUTI, the UE shall indicate the GUTI in the Old GUTI or IMSI IE.

...

The UE shall send the ATTACH REQUEST message together with a PDN CONNECTIVITY REQUEST message contained in the ESM message container information element to request PDN connectivity.

...

[TS 24.301, clause 5.5.1.2.5]

If the attach request cannot be accepted by the network, the MME shall send an ATTACH REJECT message to the UE including an appropriate EMM cause value.

...

Upon receiving the ATTACH REJECT message, the UE shall stop timer T3410 and take the following actions depending on the EMM cause value received.

...

#12 (Tracking area not allowed);

The UE shall set the EPS update status to EU3 ROAMING NOT ALLOWED (and shall store it according to subclause 5.1.3.3) and shall delete any GUTI, last visited registered TAI and KSI. Additionally, the UE shall reset the attach attempt counter.

In S1 mode, the UE shall store the current TAI in the list of "forbidden tracking areas for regional provision of service" and enter the state EMM-DEREGISTERED.LIMITED-SERVICE.

...

[TS 24.301, clause 5.2.2.3.2]

The UE shall perform an attach or combined attach procedure when entering a cell which provides normal service.

[TS 24.301, Annex C (normative)]

The following EMM parameters shall be stored on the USIM if the corresponding file is present:

- GUTI;
- last visited registered TAI;
- EPS update status;
- Allowed CSG list; and

- EPS security context parameters from a full native EPS security context (see 3GPP TS 33.401 [19]).

The presence and format of corresponding files on the USIM is specified in 3GPP TS 31.102 [17].

If the corresponding file is not present on the USIM, these EMM parameters except allowed CSG list are stored in a non-volatile memory in the ME together with the IMSI from the USIM. The allowed CSG list is stored in a non-volatile memory in the ME if the UE supports CSG selection. These EMM parameters can only be used if the IMSI from the USIM matches the IMSI stored in the non-volatile memory; else the UE shall delete the EMM parameters.

...

[TS 36.304, clause 4.3]

...

suitable cell:

...

Following exceptions to these definitions are applicable for UEs:

- camped on a cell that belongs to a registration area that is forbidden for regional provision of service; a cell that belongs to a registration area that is forbidden for regional provision service ([5], [16]) is suitable but provides only limited service.

...

9.2.1.1.14.3 Test description

9.2.1.1.14.3.1 Pre-test conditions

System Simulator:

- cell A (home PLMN) and cell B (home PLMN, another TA) are configured according to table 6.3.2.2-1 in TS 36.508 [18] and belong to the same frequency as specified in TS 36.523-3 [20].
- System information combination 3 as defined in TS 36.508[18] clause 4.4.3.1 is used in E-UTRA cells;

UE:

- the UE is configured to initiate EPS attach;
- the UE is previously registered on E-UTRAN, and when on E-UTRAN, the UE is last authenticated and registered on cell A using default message contents according to TS 36.508 [18].

Preamble:

- the UE is in state Switched OFF (state 1) according to TS 36.508 [18].

9.2.1.1.14.3.2 Test procedure sequence

Table 9.2.1.1.14.3.2-1: Main behaviour

St	Procedure	Message Sequence		TP	Verdict
		U - S	Message		
1	The SS configures: - Cell A as the "Serving cell". - Cell B as a "Suitable Neighbour cell".	-	-	-	-
-	The following messages are to be observed on Cell A unless explicitly stated otherwise.	-	-	-	-
2	The UE is switched on.	-	-	-	-
3	The UE transmits an ATTACH REQUEST message including a PDN CONNECTIVITY REQUEST message.	-->	ATTACH REQUEST	-	-
4	The SS transmits an ATTACH REJECT message, EMM cause = "Tracking area not allowed". (The list of "forbidden tracking areas for regional provision of service " in the UE should now contain TAI-1)	<--	ATTACH REJECT	-	-
5	The SS releases the RRC connection.	-	-	-	-
6	Check: Does the UE transmit the ATTACH REQUEST message in the next 30 seconds on Cell A or Cell B?	-->	ATTACH REQUEST	1, 2	F
7	The user initiates an attach by MMI or by AT command.	-	-	-	-
8	Check: Does the UE transmit the ATTACH REQUEST message in the next 30 seconds?	-->	ATTACH REQUEST	1	F
9	The SS reconfigures: Cell A as a "Suitable Neighbour cell", Cell B as the "Serving cell".	-	-	-	-
-	The following messages are to be observed on Cell B unless explicitly stated otherwise.	-	-	-	-
10	Check: Does the UE transmit the ATTACH REQUEST message including a PDN CONNECTIVITY REQUEST message?	-->	ATTACH REQUEST	1,4	P
11	The SS transmits an ATTACH REJECT message, EMM cause = "Tracking area not allowed". (The list of "forbidden tracking areas for regional provision of service " in the UE should now contain TAI-1 and TAI-2)	<--	ATTACH REJECT	-	-
12	The SS releases the RRC connection.	-	-	-	-
13	The SS reconfigures: Cell A as the "Serving cell". Cell B as a " Suitable Neighbour cell".	-	-	-	-
-	The following messages are to be observed on Cell A unless explicitly stated otherwise.	-	-	-	-
14	Check: Does the UE transmit the ATTACH REQUEST message in the next 30 seconds?	-->	ATTACH REQUEST	1, 3, 5	F
15	If possible (see ICS) switch off is performed or the USIM is removed. Otherwise the power is removed.	-	-	-	-
16	The SS reconfigures: Cell A as the "Serving cell", Cell B as a "Non-Suitable cell".	-	-	-	-
-	The following messages are to be observed on Cell A unless explicitly stated otherwise.	-	-	-	-
17	The UE is brought back to operation or the USIM is inserted.	-	-	-	-
18	Void	-	-	-	-
19	Check: Does the UE transmit the ATTACH REQUEST message including a PDN CONNECTIVITY REQUEST message as specified?	-->	ATTACH REQUEST	1, 6	P

20-32	The attach procedure is completed and the RRC connection released by executing steps 5 to 17 of the UE registration procedure in TS 36.508 clause 4.5.2.3.	-	-	-	-
-	At the end of this test procedure sequence, the UE is in end state E-UTRA idle (E1) according to TS 36.508.	-	-	-	-

9.2.1.1.14.3.3 Specific message contents

Table 9.2.1.1.14.3.3-1: Message ATTACH REJECT (steps 4 and 11, Table 9.2.1.1.14.3.2-1)

Derivation path: 36.508 table 4.7.2-3			
Information Element	Value/Remark	Comment	Condition
Security header type	0000	"No security protection" #12 "Tracking area not allowed"	
EMM cause	00001100		
ESM message container	Not present		

Table 9.2.1.1.14.3.3-2: Message ATTACH REQUEST (steps 10 and 18 Table 9.2.1.1.14.3.2-1)

Derivation path: 36.508 table 4.7.2-4			
Information Element	Value/Remark	Comment	Condition
Old GUTI or IMSI	IMSI-1	GUTI has been deleted after receiving ATTACH REJECT at step 4; only IMSI is available. TAI has been deleted after receiving ATTACH REJECT at step 4.	
Last visited registered TAI	Not present		

9.2.1.1.15 Attach / Rejected / Roaming not allowed in this tracking area

9.2.1.1.15.1 Test Purpose (TP)

(1)

```
with { the UE has sent an ATTACH REQUEST message including a PDN CONNECTIVITY REQUEST message }
ensure that {
  when { the UE receives an ATTACH REJECT message with the reject cause set to "roaming not allowed in this tracking area" }
  then { the UE sets the EPS update status to E3 ROAMING NOT ALLOWED and the UE deletes the GUTI, the last visited registered TAI and KSI and the UE enters the state EMM-DEREGISTERED.LIMITED-SERVICE or optionally EMM-DEREGISTERED.PLMN-SEARCH and the UE stores the current TAI in the list of "forbidden tracking areas for roaming" }
}
```

(2)

```
with { the UE is in EMM-DEREGISTERED.LIMITED-SERVICE or EMM-DEREGISTERED.PLMN-SEARCH state and the TAI of the current cell belongs to the list of "forbidden tracking areas for roaming" }
ensure that {
  when { the UE enters a cell belonging to a tracking area not in the list of "forbidden tracking areas for roaming" }
  then { the UE attempts to attach with IMSI }
}
```

(3)

```
with { the UE is in EMM-DEREGISTERED.LIMITED-SERVICE or EMM-DEREGISTERED.PLMN-SEARCH state and the list of "forbidden tracking areas for roaming" contains more than one TAI }
ensure that {
  when { the UE selects a cell belonging to one of the TAIs in the list of "forbidden tracking areas for roaming" }
}
```

```

    then { the UE does not attempt to attach }
  }

```

(4)

```

with { the UE is switched off or the UICC containing the USIM is removed }
ensure that {
  when { UE is powered on in the cell belonging to the TAI which was in the list of "forbidden
tracking areas for roaming" before the UE was switched off or the USIM is inserted again on that
cell }
  then { UE performs registration on that cell }
}

```

(5)

```

with { the UE has sent an ATTACH REQUEST message including a PDN CONNECTIVITY REQUEST message }
ensure that {
  when { the UE receives an ATTACH REJECT message with the reject cause set to "roaming not allowed
in this tracking area" }
  then { the UE performs a PLMN selection }
}

```

9.2.1.1.15.2 Conformance requirements

References: The conformance requirements covered in the present TC are specified in: TS 24.301, clauses 5.3.2, 5.5.1.2.2, 5.5.1.2.5 and in TS 36.304 clause 5.2.4.4.

[TS 24.301, clause 5.3.2]

The UE shall store a list of "forbidden tracking areas for roaming", as well as a list of "forbidden tracking areas for regional provision of service". These lists shall be erased when the UE is switched off or when the UICC containing the USIM is removed, and periodically (with a period in the range 12 to 24 hours).

...

In S1 mode, the UE shall update the suitable list whenever an ATTACH REJECT, TRACKING AREA UPDATE REJECT, SERVICE REJECT or DETACH REQUEST message is received with the EMM cause #12 "tracking area not allowed", #13 "roaming not allowed in this tracking area", or #15 "no suitable cells in tracking area".

Each list shall accommodate 40 or more TAIs. When the list is full and a new entry has to be inserted, the oldest entry shall be deleted.

[TS 24.301, clause 5.5.1.2.2]

In state EMM-DEREGISTERED, the UE initiates the attach procedure by sending an ATTACH REQUEST message to the MME, starting timer T3410 and entering state EMM-REGISTERED-INITIATED (see example in figure 5.5.1.2.2.1).

...

If the UE supports neither A/Gb mode nor Iu mode, the UE shall handle the Old GUTI or IMSI IE in the ATTACH REQUEST message as follows:

- The UE shall include in the ATTACH REQUEST message a valid GUTI together with the last visited registered TAI, if available. If there is no valid GUTI available, the UE shall include the IMSI in the ATTACH REQUEST message. If the UE supports A/Gb mode or Iu mode, the UE shall handle the Old GUTI or IMSI IE as follows:

...

- If the TIN indicates "GUTI" or "RAT-related TMSI" and the UE holds a valid GUTI, the UE shall indicate the GUTI in the Old GUTI or IMSI IE.

...

The UE shall send the ATTACH REQUEST message together with a PDN CONNECTIVITY REQUEST message contained in the ESM message container information element to request PDN connectivity.

...

[TS 24.301, clause 5.5.1.2.5]

If the attach request cannot be accepted by the network, the MME shall send an ATTACH REJECT message to the UE including an appropriate EMM cause value.

...

Upon receiving the ATTACH REJECT message, the UE shall stop timer T3410 and take the following actions depending on the EMM cause value received.

...

#13 (Roaming not allowed in this tracking area);

The UE shall set the EPS update status to EU3 ROAMING NOT ALLOWED (and shall store it according to subclause 5.1.3.3) and shall delete any GUTI, last visited registered TAI and KSI. The UE shall delete the list of equivalent PLMNs and reset the attach attempt counter.

In S1 mode, the UE shall store the current TAI in the list of "forbidden tracking areas for roaming". Additionally, the UE shall enter the state EMM-DEREGISTERED.LIMITED-SERVICE or optionally EMM-DEREGISTERED.PLMN-SEARCH. The UE shall perform a PLMN selection according to 3GPP TS 23.122 [6].

...

[TS 36.304 subclause 5.2.4.4]

...

If the highest ranked cell is an intra-frequency or inter-frequency cell which is not suitable due to being part of the "list of forbidden TAs for roaming" or belonging to a PLMN which is not indicated as being equivalent to the registered PLMN, the UE shall not consider this cell and other cells on the same frequency, as candidates for reselection for a maximum of 300s. If the UE enters into state *any cell selection*, any limitation shall be removed. If the UE is redirected under E-UTRAN control to a frequency for which the timer is running, any limitation on that frequency shall be removed.

...

9.2.1.1.15.3 Test description

9.2.1.1.15.3.1 Pre-test conditions

System Simulator:

- cell C (home PLMN), cell I (visited PLMN) and cell E (same visited PLMN, another TA), but at most two cells are simultaneously activated.

NOTE 1: Cell E shall not use the same frequency as cell I.

NOTE 2: The requirement in 3GPP TS 24.301 to store at least 40 entries in the list of "forbidden tracking areas for roaming" is not fully tested.

NOTE 3: Different types of UE may use different methods to periodically clear the list of forbidden areas (e.g. every day at 12 am) for roaming. If the list is cleared while the test is being run, it may be necessary to re-run the test.

UE:

- the UE is configured to initiate EPS attach;
- the UE is previously registered on E-UTRAN, and when on E-UTRAN, the UE is last authenticated and registered on cell I using default message contents according to TS 36.508 [18].

Preamble:

- the UE is in state Switched OFF (state 1) according to TS 36.508 [18].

9.2.1.1.15.3.2 Test procedure sequence

Table 9.2.1.1.15.3.2-1: Main behaviour

St	Procedure	Message Sequence		TP	Verdict
		U - S	Message		
1	The SS configures: Cell I as the "Serving cell". cell E as a " Non-Suitable Off cell", cell C as a "Non-Suitable Off cell".	-	-	-	-
-	The following messages are to be observed on cell I unless explicitly stated otherwise.	-	-	-	-
2	The UE is switched on.	-	-	-	-
3	The UE transmits an ATTACH REQUEST message including a PDN CONNECTIVITY REQUEST message.	-->	ATTACH REQUEST	-	-
4	The SS transmits an ATTACH REJECT message, EMM cause = "roaming not allowed in this tracking area ". (The list of "forbidden tracking areas for roaming" in the UE should now contain TAI-9)	<--	ATTACH REJECT	-	-
5	The SS releases the RRC connection.	-	-	-	-
6	Check: Does the UE transmit an ATTACH REQUEST message in the next 30 seconds?	-->	ATTACH REQUEST	1,5	F
7	The user initiates an attach by MMI or by AT command.	-	-	-	-
8	Check: Does the UE transmit an ATTACH REQUEST message in the next 30 seconds?	-->	ATTACH REQUEST	1,5	F
-	The following messages are to be observed on Cell E unless explicitly stated otherwise.	-	-	-	-
8A	The SS configures: Cell I as the "Serving cell". Cell E as a "Suitable Neighbour cell", Cell C as a "Non-Suitable Off cell".	-	-	-	-
9	Check: Does the UE transmit an ATTACH REQUEST message including a PDN CONNECTIVITY REQUEST message on Cell E as specified? Note: according to TS 24.301, the UE has the choice to enter "LIMITED-SERVICE" or "PLMN- SEARCH" state. But in any case it shall do a PLMN selection. In the first option, the UE shall apply reselection so it will select cell E and then attempt to attach; in the second option it will select the same PLMN again and exclude cells from forbidden TAs so it will select cell E.	-->	ATTACH REQUEST	1, 2	P
10	The SS transmits an ATTACH REJECT message, EMM cause = "roaming not allowed in this tracking area". (The list of "forbidden tracking areas for roaming" in the UE should now contain TAI-9 and TAI-12)	<--	ATTACH REJECT	-	-
11	The SS releases the RRC connection.	-	-	-	-
12	Check: Does the UE transmit an ATTACH REQUEST message in the next 60 seconds on Cell I or Cell E?	-->	ATTACH REQUEST	1, 3	F
13	If possible (see ICS) switch off is performed or the USIM is removed. Otherwise the power is removed.	-	-	-	-
14	The SS reconfigures: Cell I as the "Serving cell", Cell E as a "Non-Suitable Off cell", Cell C as a "Non-Suitable Off cell".	-	-	-	-
-	The following messages are to be observed on Cell I unless explicitly stated otherwise.	-	-	-	-
15	The UE is brought back to operation or the	-	-	-	-

	USIM is inserted.				
16	The UE transmits an ATTACH REQUEST message including a PDN CONNECTIVITY REQUEST message as specified.	-->	ATTACH REQUEST	4	P
17	The SS transmits an ATTACH REJECT message, EMM cause = "roaming not allowed in this tracking area ". (The list of "forbidden tracking areas for roaming" in the UE should now contain TAI-9)	<--	ATTACH REJECT	-	-
18	The SS reconfigures: Cell I as the "Serving cell", Cell E as a "Non-Suitable Off cell", Cell C as a "Suitable neighbour cell".	-	-	-	-
-	The following messages are to be observed on Cell C unless explicitly stated otherwise.	-	-	-	-
19	Check: Does the UE transmit an ATTACH REQUEST message including a PDN CONNECTIVITY REQUEST message as specified?	-->	ATTACH REQUEST	5	P
20-32	The attach procedure is completed and the RRC connection released by executing steps 5 to 17 of the UE registration procedure in TS 36.508 clause 4.5.2.3.	-	-	-	-
-	At the end of this test procedure sequence, the UE is in end state E-UTRA idle (E1) according to TS 36.508.	-	-	-	-

9.2.1.1.15.3.3 Specific message contents

Table 9.2.1.1.15.3.3-1: Message ATTACH REJECT (steps 4, 10 and 17 in table 9.2.1.1.15.3.2-1)

Derivation path: 36.508 table 4.7.2-3			
Information Element	Value/Remark	Comment	Condition
Security header type	0000	"Plain NAS message, not security protected" #13 "roaming not allowed in this tracking area "	
EMM cause	00001101		
ESM message container	Not present		

Table 9.2.1.1.15.3.3-2: Message ATTACH REQUEST (steps 9,12, 16 and 19 in table 9.2.1.1.15.3.2-1)

Derivation path: 36.508 table 4.7.2-4			
Information Element	Value/Remark	Comment	Condition
Old GUTI or IMSI	IMSI1	GUTI has been deleted after receiving ATTACH REJECT at step 4; only IMSI is available. TAI has been deleted after receiving ATTACH REJECT at step 4.	
Last visited registered TAI	Not present		

9.2.1.1.15a Attach / Rejected / Roaming not allowed in this tracking area / Single Frequency operation

9.2.1.1.15a.1 Test Purpose (TP)

Same test purpose as in clause 9.2.1.1.15a.1.

9.2.1.1.15a.2 Conformance requirements

Same conformance requirements as in clause 9.2.1.1.15a.2

9.2.1.1.15a.3 Test description

9.2.1.1.15a.3.1 Pre-test conditions

System Simulator:

- Three intra-frequency cells.
- cell C (home PLMN), cell B (visited PLMN, TAI-9) and cell A (same visited PLMN, TAI-12), but at most two cells are simultaneously activated.

NOTE 1: The requirement in 3GPP TS 24.301 to store at least 40 entries in the list of "forbidden tracking areas for roaming" is not fully tested.

NOTE 2: Different types of UE may use different methods to periodically clear the list of forbidden areas (e.g. every day at 12 am) for roaming. If the list is cleared while the test is being run, it may be necessary to re-run the test.

UE:

- the UE is configured to initiate EPS attach;
- the UE is previously registered on E-UTRAN, and when on E-UTRAN, the UE is last authenticated and registered on cell B using default message contents according to TS 36.508 [18].

Preamble:

- the UE is in state Switched OFF (state 1) according to TS 36.508 [18].

9.2.1.1.15a.3.2 Test procedure sequence

Table 9.2.1.1.15a.3.2-1: Main behaviour

St	Procedure	Message Sequence		TP	Verdict
		U - S	Message		
1	The SS configures: Cell B as the "Serving cell". cell A as a " Non-Suitable Off cell", cell C as a "Non-Suitable Off cell".	-	-	-	-
-	The following messages are to be observed on cell B unless explicitly stated otherwise.	-	-	-	-
2	The UE is switched on.	-	-	-	-
3	The UE transmits an ATTACH REQUEST message including a PDN CONNECTIVITY REQUEST message.	-->	ATTACH REQUEST	-	-
4	The SS transmits an ATTACH REJECT message, EMM cause = "roaming not allowed in this tracking area ". (The list of "forbidden tracking areas for roaming" in the UE should now contain TAI-9)	<--	ATTACH REJECT	-	-
5	The SS releases the RRC connection.	-	-	-	-
6	Check: Does the UE transmit an ATTACH REQUEST message in the next 90 seconds?	-->	ATTACH REQUEST	1,5	F
7	The user initiates an attach by MMI or by AT command.	-	-	-	-
8	Check: Does the UE transmit an ATTACH REQUEST message in the next 90 seconds?	-->	ATTACH REQUEST	1,5	F
-	The following messages are to be observed on Cell A unless explicitly stated otherwise.	-	-	-	-
8A	The SS configures: Cell B as the "Serving cell". Cell A as a "Suitable Neighbour intrafrequency cell", Cell C as a "Non-Suitable Off cell".	-	-	-	-
9	Check: Does the UE transmit an ATTACH REQUEST message including a PDN CONNECTIVITY REQUEST message on Cell A as specified? Note: according to TS 24.301, the UE has the choice to enter "LIMITED-SERVICE" or "PLMN- SEARCH" state. But in any case it shall do a PLMN selection. In the first option, the UE shall apply reselection so it will select cell A and then attempt to attach; in the second option it will select the same PLMN again and exclude cells from forbidden TAs so it will select cell A.	-->	ATTACH REQUEST	1, 2	P
10	The SS transmits an ATTACH REJECT message, EMM cause = "roaming not allowed in this tracking area". (The list of "forbidden tracking areas for roaming" in the UE should now contain TAI-9 and TAI-12)	<--	ATTACH REJECT	-	-
11	The SS releases the RRC connection.	-	-	-	-
12	Check: Does the UE transmit an ATTACH REQUEST message in the next 90 seconds on Cell B or Cell A?	-->	ATTACH REQUEST	1, 3	F
13	If possible (see ICS) switch off is performed or the USIM is removed. Otherwise the power is removed.	-	-	-	-
14	The SS reconfigures: Cell B as the "Serving cell", Cell A as a "Non-Suitable Off cell", Cell C as a "Non-Suitable Off cell".	-	-	-	-
-	The following messages are to be observed on Cell B unless explicitly stated otherwise.	-	-	-	-

15	The UE is brought back to operation or the USIM is inserted.	-	-	-	-
16	The UE transmits an ATTACH REQUEST message including a PDN CONNECTIVITY REQUEST message as specified.	-->	ATTACH REQUEST	4	P
17	The SS transmits an ATTACH REJECT message, EMM cause = "roaming not allowed in this tracking area ". (The list of "forbidden tracking areas for roaming" in the UE should now contain TAI-9)	<--	ATTACH REJECT	-	-
18	The SS reconfigures: Cell B as the " Suitable neighbour intrafrequency cell", Cell A as a "Non-Suitable Off cell", Cell C as a " Serving cell".	-	-	-	-
-	The following messages are to be observed on Cell C unless explicitly stated otherwise.	-	-	-	-
19	Check: Does the UE transmit an ATTACH REQUEST message including a PDN CONNECTIVITY REQUEST message as specified?	-->	ATTACH REQUEST	5	P
20-32	The attach procedure is completed and the RRC connection released by executing steps 5 to 17 of the UE registration procedure in TS 36.508 clause 4.5.2.3.	-	-	-	-
-	At the end of this test procedure sequence, the UE is in end state E-UTRA idle (E1) according to TS 36.508.	-	-	-	-

9.2.1.1.15a.3.3 Specific message contents

Same specific message contents as clause 9.2.1.1.15.3.3

9.2.1.1.16 Attach / Rejected / EPS services not allowed in this PLMN

9.2.1.1.16.1 Test Purpose (TP)

(1)

```
with { UE has sent an ATTACH REQUEST message including a PDN CONNECTIVITY REQUEST message }
ensure that {
  when { UE receives an ATTACH REJECT message with the reject cause set to "EPS services not allowed in this PLMN" }
  then { UE deletes any GUTI, last visited registered TAI, KSI and enters EMM-DEREGISTERED.PLMN-SEARCH state }
}
```

(2)

```
with { UE in E-UTRA EMM-DEREGISTERED.PLMN-SEARCH state, and a PLMN is stored in the "forbidden PLMNs for GPRS service list" }
ensure that {
  when { UE detects a cell which belongs to a PLMN which is in the "forbidden PLMNs for GPRS service list" }
  then { UE doesn't perform an attach procedure }
}
```

(3)

```
with { UE in E-UTRA EMM-DEREGISTERED.PLMN-SEARCH state, and a PLMN is stored in the "forbidden PLMNs for GPRS service list" }
ensure that {
  when { UE detects a cell which belongs to a PLMN which is not in the "forbidden PLMNs for GPRS service list" }
  then { UE performs an attach procedure }
}
```

(4)

```
with { UE is switched off when a PLMN is stored in the "forbidden PLMNs for GPRS service list" }
ensure that {
```

```

when { UE is powered on a cell which belongs to this PLMN }
  then { UE performs an attach procedure }
}

```

(5)

```

with { UE in E-UTRA EMM-DEREGISTERED.PLMN-SEARCH state, and a PLMN is stored in the "forbidden PLMNs
for GPRS service list" }
ensure that {
  when { UE is in the cell which belongs to the rejected PLMN and when that PLMN is selected
manually }
  then { UE performs an attach procedure }
}

```

9.2.1.1.16.2 Conformance requirements

References: The conformance requirements covered in the present TC are specified in: TS 24.301, clauses 5.5.1.2.5 and TS23.122, clause 3.1.

[TS24.301 clause 5.5.1.2.5]

If the attach request cannot be accepted by the network, the MME shall send an ATTACH REJECT message to the UE including an appropriate EMM cause value. If the attach procedure fails due to a default EPS bearer setup failure, an ESM procedure failure, or operator determined barring is applied on default EPS bearer context activation during attach procedure, the MME shall combine the ATTACH REJECT message with a PDN CONNECTIVITY REJECT message contained in the ESM message container information element. In this case the EMM cause value in the ATTACH REJECT message shall be set to #19 "ESM failure".

Upon receiving the ATTACH REJECT message, the UE shall stop timer T3410 and take the following actions depending on the EMM cause value received.

...

#14 (EPS services not allowed in this PLMN);

The UE shall set the EPS update status to EU3 ROAMING NOT ALLOWED (and shall store it according to subclause 5.1.3.3) and shall delete any GUTI, last visited registered TAI and KSI.

In S1 mode, the UE shall store the PLMN identity in the "forbidden PLMNs for GPRS service" list. Additionally, the UE shall enter state EMM-DEREGISTERED.PLMN-SEARCH. The UE shall perform a PLMN selection according to 3GPP TS 23.122 [6]:

In S101 mode, the UE shall store the PLMN identity provided with the indication from the lower layers to prepare for an S101 mode to S1 mode handover in the list of "forbidden PLMNs for attach in S101 mode" and enter the state EMM-DEREGISTERED.NO-CELL-AVAILABLE.

If A/Gb mode or Iu mode is supported by the UE, the UE shall in addition handle the GMM parameters GMM state, GPRS update status, P-TMSI, P-TMSI signature, RAI, GPRS ciphering key sequence number and GPRS attach attempt counter as specified in 3GPP TS 24.008 [13] for the case when the normal attach procedure is rejected with the GMM cause with the same value.

...

[TS23.122 clause 3.1]

...

If a message with cause value "GPRS services not allowed in this PLMN" is received by an MS in response to an GPRS attach, GPRS detach, routing area update, attach or tracking area update request (see 3GPP TS 24.008 [23] and 3GPP TS 24.301 [23A]) from a VPLMN, that VPLMN is added to a list of "forbidden PLMNs for GPRS service" which is stored in the MS and thereafter that VPLMN will not be accessed by the MS for GPRS service when in automatic mode. This list is deleted when the MS is switched off or when the SIM is removed. A PLMN is removed from the list of "forbidden PLMNs for GPRS service" if, after a subsequent manual selection of that PLMN, there is a successful GPRS attach. The maximum number of possible entries in this list is implementation dependant, but must be at least one entry. The HPLMN (if the EHPLMN list is not present or is empty) or an EHPLMN (if the EHPLMN list is present) shall not be stored on the list of "forbidden PLMNs for GPRS service".

...

9.2.1.1.16.3 Test description

9.2.1.1.16.3.1 Pre-test conditions

System Simulator:

- cell G, Cell H and cell I are configured according to Table 6.3.2.2-1 in; [18].
- cell G and Cell H with MCC-1/MNC-2 (visited PLMN, different TAs)
- Cell I with MCC-2/MNC-101 (visited PLMN)
- the cells may not be simultaneously activated;
- the cells are configured according to Table 6.3.2.2-1 and Table 6.3.2.2-3 in 36.508 [18], except replacing f3 with f1.

UE:

- the UE is configured to initiate EPS attach;
- the UE is previously registered on E-UTRAN, and when on E-UTRAN, the UE is last authenticated and registered on cell G using default message contents according to TS 36.508 [18];
- the "forbidden PLMNs for GPRS service list" is empty.
- the different cells may not be simultaneously activated (at most 2 cells are active simultaneously).

Preamble:

- the UE is in state Switched OFF (state 1) according to TS 36.508 [18].

9.2.1.1.16.3.2 Test procedure sequence

Table 9.2.1.1.16.3.2-1: Main Behaviour

St	Procedure	Message Sequence		TP	Verdict
		U - S	Message		
1	The SS configures: - Cell G as the "Serving cell". - Cell H as a "Non-Suitable cell". - Cell I as a "Non-Suitable off cell".	-	-	-	-
-	The following messages are to be observed on Cell G unless explicitly stated otherwise.	-	-	-	-
2	Void	-	-	-	-
3	The UE is switched on.	-	-	-	-
4	The UE transmits an ATTACH REQUEST message including a PDN CONNECTIVITY REQUEST message.	-->	ATTACH REQUEST	-	-
5	The SS transmits an ATTACH REJECT message including EMM cause = "EPS services not allowed in this PLMN".	<--	ATTACH REJECT	-	-
6	The SS releases the RRC connection.	-	-	-	-
7	Check: Does the UE transmit an ATTACH REQUEST message in the next 90 seconds?	-->	ATTACH REQUEST	1	F
8	The SS configures: Cell G as a "Non-Suitable cell". Cell H as the "Serving cell". Note: Cell G and Cell H are in the different TAI – same PLMN.	-	-	-	-
-	The following messages are to be observed on Cell H unless explicitly stated otherwise.	-	-	-	-
9	Void	-	-	-	-
10	Check: Does the UE transmit an ATTACH REQUEST message in the next 90 seconds?	-->	ATTACH REQUEST	2	F
11	The SS configures: Cell H as a "Non-Suitable off cell". Cell I as the "Serving cell". Note: Cell G and Cell I are different PLMNs.	-	-	-	-
-	The following messages are to be observed on Cell I unless explicitly stated otherwise.	-	-	-	-
12	Void	-	-	-	-
13	Check: Does the UE transmit an ATTACH REQUEST message including and a PDN CONNECTIVITY REQUEST message as specified?	-->	ATTACH REQUEST	3	P
13 A	The SS completes the attach procedure successfully and then releases the RRC - connection by executing steps 5 to 17 of UE registration procedure in TS 36.508 clause 4.5.2.3.				
14 - 20	Void	-	-	-	-
21	If possible (see ICS) switch off is performed or the USIM is removed. Otherwise the power is removed.	-	-	-	-
22	The SS configures - Cell I as a "Non-Suitable cell". - Cell G as the "Serving cell".	-	-	-	-
-	The following messages are to be observed on Cell G unless explicitly stated otherwise.	-	-	-	-
23	The UE is brought back to operation or the USIM is inserted.				
24	Void	-	-	-	-
25	Check: Does the UE transmit an ATTACH REQUEST message including a PDN CONNECTIVITY REQUEST message?	-->	ATTACH REQUEST	4	P

26	The SS transmits an ATTACH REJECT message including EMM cause = "EPS services not allowed in this PLMN".	<--	ATTACH REJECT	-	-
26 A	SS releases the RRC connection.	-	-	-	-
27	The user sets the UE in manual PLMN selection mode or requests a PLMN search.				
28	The user selects PLMN (MCC-1/MNC-2)				
29	Check: Does the UE transmit an ATTACH REQUEST message including a PDN CONNECTIVITY REQUEST message as specified?	-->	ATTACH REQUEST	5	P
30- 42	The attach procedure is completed and the RRC connection released by executing steps 5 to 17 of the UE registration procedure in TS 36.508 clause 4.5.2.3.	-	-	-	-
-	At the end of this test procedure sequence, the UE is in end state E-UTRA idle (E1) according to TS 36.508.	-	-	-	-

9.2.1.1.16.3.3 Specific message contents

Table 9.2.1.1.16.3.3-1: Message ATTACH REJECT (step 5, Table 9.2.1.1.16.3.2-1)

Derivation path: 36.508 table 4.7.2-3 (Plain NAS message)			
Information Element	Value/Remark	Comment	Condition
EMM cause	00001110	#14 "EPS services not allowed in this PLMN "	
ESM message container	Not present		

Table 9.2.1.1.16.3.3-2: Message ATTACH REQUEST (step 13 and step 29, Table 9.2.1.1.16.3.2-1)

Derivation path: 36.508 table 4.7.2-4			
Information Element	Value/Remark	Comment	Condition
Old GUTI or IMSI	IMSI-1	GUTI has been deleted after receiving ATTACH REJECT at step 5 and step25; only IMSI is available.	
Last visited registered TAI	Not present	TAI has been deleted after receiving ATTACH REJECT at step 5 and step26.	

Table 9.2.1.1.16.3.3-3: Message ATTACH REJECT (step 26, Table 9.2.1.1.16.3.2-1)

Derivation path: 36.508 table 4.7.2-3			
Information Element	Value/Remark	Comment	Condition
EMM cause	00001110	#14 "EPS services not allowed in this PLMN "	
ESM message container	Not present		

9.2.1.1.16a Attach / Rejected / EPS services not allowed in this PLMN / Single Frequency operation

9.2.1.1.16a.1 Test Purpose (TP)

Same test purpose as in clause 9.2.1.1.16.1

9.2.1.1.16a.2 Conformance requirements

Same conformance requirements as in clause 9.2.1.1.16.2

9.2.1.1.16a.3 Test description

9.2.1.1.16a.3.1 Pre-test conditions

System Simulator:

- cell A(TAI-7), Cell B(TAI-8) and intra-frequency cells cell C(TAI-9) are configured according to Table 6.3.2.2-1 in; [18].
- cell A and Cell B with MCC-1/MNC-2 (visited PLMN, different TAs)
- Cell C with MCC-2/MNC-101 (visited PLMN)
- the cells may not be simultaneously activated.

UE:

- the UE is configured to initiate EPS attach;
- the UE is previously registered on E-UTRAN, and when on E-UTRAN, the UE is last authenticated and registered on cell A using default message contents according to TS 36.508 [18];
- the "forbidden PLMNs for GPRS service list" is empty.
- the different cells may not be simultaneously activated (at most 2 cells are active simultaneously).

Preamble:

- the UE is in state Switched OFF (state 1) according to TS 36.508 [18].

9.2.1.1.16a.3.2 Test procedure sequence

Table 9.2.1.1.16a.3.2-1: Main Behaviour

St	Procedure	Message Sequence		TP	Verdict
		U - S	Message		
1	The SS configures: - Cell A as the "Serving cell". - Cell B as a "Non-Suitable cell". - Cell C as a "Non-Suitable off cell".	-	-	-	-
-	The following messages are to be observed on Cell A unless explicitly stated otherwise.	-	-	-	-
2	Void	-	-	-	-
3	The UE is switched on.	-	-	-	-
4	The UE transmits an ATTACH REQUEST message including a PDN CONNECTIVITY REQUEST message.	-->	ATTACH REQUEST	-	-
5	The SS transmits an ATTACH REJECT message including EMM cause = "EPS services not allowed in this PLMN".	<--	ATTACH REJECT	-	-
6	The SS releases the RRC connection.	-	-	-	-
7	Check: Does the UE transmit an ATTACH REQUEST message in the next 90 seconds?	-->	ATTACH REQUEST	1	F
8	The SS configures: Cell A as a "Non-Suitable cell". Cell B as the "Serving cell". Note: Cell A and Cell B are in the different TAI – same PLMN.	-	-	-	-
-	The following messages are to be observed on Cell B unless explicitly stated otherwise.	-	-	-	-
9	Void	-	-	-	-
10	Check: Does the UE transmit an ATTACH REQUEST message in the next 90 seconds?	-->	ATTACH REQUEST	2	F
11	The SS configures: Cell B as a "Non-Suitable off cell". Cell C as the "Serving cell". Note: Cell A and Cell C are different PLMNs.	-	-	-	-
-	The following messages are to be observed on Cell C unless explicitly stated otherwise.	-	-	-	-
12	Void	-	-	-	-
13	Check: Does the UE transmit an ATTACH REQUEST message including and a PDN CONNECTIVITY REQUEST message as specified?	-->	ATTACH REQUEST	3	P
13 A	The SS completes the attach procedure successfully and then releases the RRC - connection by executing steps 5 to 17 of UE registration procedure in TS 36.508 clause 4.5.2.3.				
14 - 20	Void	-	-	-	-
21	If possible (see ICS) switch off is performed or the USIM is removed. Otherwise the power is removed.	-	-	-	-
22	The SS configures - Cell C as a "Non-Suitable cell". - Cell A as the "Serving cell".	-	-	-	-
-	The following messages are to be observed on Cell A unless explicitly stated otherwise.	-	-	-	-
23	The UE is brought back to operation or the USIM is inserted.				
24	Void	-	-	-	-
25	Check: Does the UE transmit an ATTACH REQUEST message including a PDN CONNECTIVITY REQUEST message?	-->	ATTACH REQUEST	4	P

26	The SS transmits an ATTACH REJECT message including EMM cause = "EPS services not allowed in this PLMN".	<--	ATTACH REJECT	-	-
26 A	SS releases the RRC connection.	-	-	-	-
27	The user sets the UE in manual PLMN selection mode or requests a PLMN search.				
28	The user selects PLMN of cell A				
29	Check: Does the UE transmit an ATTACH REQUEST message including a PDN CONNECTIVITY REQUEST message as specified?	-->	ATTACH REQUEST	5	P
30- 42	The attach procedure is completed and the RRC connection released by executing steps 5 to 17 of the UE registration procedure in TS 36.508 clause 4.5.2.3.	-	-	-	-
-	At the end of this test procedure sequence, the UE is in end state E-UTRA idle (E1) according to TS 36.508.	-	-	-	-

9.2.1.1.16a.3.3 Specific message contents

Same specific message contents as in clause 9.2.1.1.16.3.3

9.2.1.1.17 Attach / Rejected / No suitable cells in tracking area

9.2.1.1.17.1 Test Purpose (TP)

(1)

```
with { the UE has sent an ATTACH REQUEST message including a PDN CONNECTIVITY REQUEST message }
ensure that {
  when { the UE receives an ATTACH REJECT message with the EMM cause set to "No suitable cells in
tracking area" }
  then { the UE sets the EPS update status to EU3 ROAMING NOT ALLOWED, UE deletes any GUTI, last
visited registered TAI and KSI and the UE enters the state EMM-DEREGISTERED.LIMITED-SERVICE and the
UE stores the current TAI in the list of "forbidden tracking areas for roaming" }
}
```

(2)

```
with { the UE is in EMM-DEREGISTERED.LIMITED-SERVICE state and the current TAI in the list of
"forbidden tracking areas for roaming" }
ensure that {
  when { the UE re-selects a cell that belongs to the TAI where UE was rejected }
  then { the UE does not attempt to attach }
}
```

(3)

```
with { the UE is in EMM-DEREGISTERED.LIMITED-SERVICE state and the current TAI in the list of
"forbidden tracking areas for roaming" and KSI was deleted }
ensure that {
  when { in the same PLMN, the UE enters a cell which provides normal service and belongs to a
tracking area not in the list of "forbidden tracking areas for roaming" }
  then { the UE attempts to attach with IMSI }
}
```

(4)

```
with { the UE is in EMM-DEREGISTERED.LIMITED-SERVICE state and the current TAI in the list of
"forbidden tracking areas for roaming" }
ensure that {
  when { there are cells in the same PLMN and other PLMN that provide normal service and belong to
tracking areas not in the list of "forbidden tracking areas for roaming" }
  then { UE attempts to attach to the cell in the same PLMN }
}
```

Note: TP 4 is applicable only for Multi PLMN environment

(5)

```
with { UE is in EMM-DEREGISTERED.LIMITED-SERVICE state and the list of "forbidden tracking areas for
roaming" contains more than one TAI }
```

```

ensure that {
  when { UE re-selects a cell that belongs to one of the TAIs in the list of "forbidden tracking
areas for roaming" }
    then { UE does not attempt to attach }
}

```

(6)

```

with { UE is switched off }
ensure that {
  when { UE is powered on in the cell belonging to the TAI which was in the list of "forbidden
tracking areas for roaming" before the UE was switched off }
    then { UE attempts to attach }
}

```

9.2.1.1.17.2 Conformance requirements

References: The conformance requirements covered in the present TC are specified in: TS 24.301, clauses 5.3.2, 5.5.1.2.2 and 5.5.1.2.5, and in TS 36.304 clause 5.2.4.4.

[TS 24.301, clause 5.3.2]

The UE shall store a list of "forbidden tracking areas for roaming", as well as a list of "forbidden tracking areas for regional provision of service". These lists shall be erased when the UE is switched off or when the UICC containing the USIM is removed, and periodically (with a period in the range 12 to 24 hours).

...

In S1 mode, the UE shall update the suitable list whenever an ATTACH REJECT, TRACKING AREA UPDATE REJECT, SERVICE REJECT or DETACH REQUEST message is received with the EMM cause #12 "tracking area not allowed", #13 "roaming not allowed in this tracking area", or #15 "no suitable cells in tracking area".

Each list shall accommodate 40 or more TAIs. When the list is full and a new entry has to be inserted, the oldest entry shall be deleted.

...

[TS 24.301, clause 5.5.1.2.2]

In state EMM-DEREGISTERED, the UE initiates the attach procedure by sending an ATTACH REQUEST message to the MME, starting timer T3410 and entering state EMM-REGISTERED-INITIATED (see example in figure 5.5.1.2.2.1).

...

If the UE supports neither A/Gb mode nor Iu mode, the UE shall handle the Old GUTI or IMSI IE in the ATTACH REQUEST message as follows:

- The UE shall include in the ATTACH REQUEST message a valid GUTI together with the last visited registered TAI, if available. If there is no valid GUTI available, the UE shall include the IMSI in the ATTACH REQUEST message.

If the UE supports A/Gb mode or Iu mode, the UE shall handle the Old GUTI or IMSI IE as follows:

...

- If the TIN indicates "GUTI" or "RAT-related TMSI" and the UE holds a valid GUTI, the UE shall indicate the GUTI in the Old GUTI or IMSI IE.

...

- Otherwise the UE shall include the IMSI in the Old GUTI or IMSI IE.

...

The UE shall send the ATTACH REQUEST message together with a PDN CONNECTIVITY REQUEST message contained in the ESM message container information element to request PDN connectivity.

...

[TS 24.301, clause 5.5.1.2.5]

If the attach request cannot be accepted by the network, the MME shall send an ATTACH REJECT message to the UE including an appropriate EMM cause value.

...

Upon receiving the ATTACH REJECT message, the UE shall stop timer T3410 and take the following actions depending on the EMM cause value received.

...

#15 (No suitable cells in tracking area);

The UE shall set the EPS update status to EU3 ROAMING NOT ALLOWED (and shall store it according to subclause 5.1.3.3) and shall delete any GUTI, last visited registered TAI and KSI. Additionally, the UE shall reset the attach attempt counter.

In S1 mode, the UE shall store the current TAI in the list of "forbidden tracking areas for roaming" and enter the state EMM-DEREGISTERED.LIMITED-SERVICE. The UE shall search for a suitable cell in another tracking area or in another location area in the same PLMN according to 3GPP TS 36.304 [21].

...

[TS 36.304 subclause 5.2.4.4]

...

If the highest ranked cell is an intra-frequency or inter-frequency cell which is not suitable due to being part of the "list of forbidden TAs for roaming" or belonging to a PLMN which is not indicated as being equivalent to the registered PLMN, the UE shall not consider this cell and other cells on the same frequency, as candidates for reselection for a maximum of 300s. If the UE enters into state *any cell selection*, any limitation shall be removed. If the UE is redirected under E-UTRAN control to a frequency for which the timer is running, any limitation on that frequency shall be removed.

...

9.2.1.1.17.3 Test description

9.2.1.1.17.3.1 Pre-test conditions

System Simulator:

- cell I, , cell K, cell L and if (px_SinglePLMN_Tested = MultiPLMN) cell J are configured according to table 6.3.2.2-1 in TS 36.508 [18] (maximum 3 cells are simultaneously active):
 - cell I and cell K (visited PLMN, same TA);
 - cell L (same visited PLMN, another TA);
 - If (px_SinglePLMN_Tested = Multi PLMN) cell J (another VPLMN).

NOTE: Different types of UE may use different methods to periodically clear the list of forbidden areas (e.g. every day at 12 am) for roaming. If the list is cleared while the test is being run, it may be necessary to re-run the test.

UE:

- the UE is configured to initiate EPS attach;
- the UE is previously registered on E-UTRAN, and when on E-UTRAN, the UE is last authenticated and registered on cell I using default message contents according to TS 36.508 [18].

Preamble:

- the UE is in state Switched OFF (state 1) according to TS 36.508 [18].

9.2.1.1.17.3.2 Test procedure sequence

Table 9.2.1.1.17.3.2-1: Main behaviour

St	Procedure	Message Sequence		TP	Verdict
		U - S	Message		
1	The SS configures: Cell I as the "Serving cell", Cell K as a "Suitable Neighbour intrafrequency cell", Cell L as a "Non-Suitable Off cell", If present, Cell J as a "Non-Suitable Off cell".	-	-	-	-
-	The following messages are to be observed on Cell I unless explicitly stated otherwise.	-	-	-	-
2	The UE is switched on.	-	-	-	-
3	The UE transmits an ATTACH REQUEST message including a PDN CONNECTIVITY REQUEST message.	-->	ATTACH REQUEST	-	-
4	The SS transmits an ATTACH REJECT message, EMM cause = "No suitable cells in tracking area". (The list of "forbidden tracking areas for roaming" in the UE should now contain TAI-9)	<--	ATTACH REJECT	-	-
5	The SS releases the RRC connection.	-	-	-	-
6	Check: Does the UE transmit an ATTACH REQUEST message in the next 30 seconds on Cell I or Cell K?	-->	ATTACH REQUEST	1	F
7	The SS reconfigures: Cell I as a "Suitable neighbour intrafrequency cell", Cell K as the "Serving cell", Cell L as a "Non-Suitable Off cell", If present, Cell J as a "Non-Suitable Off cell".	-	-	-	-
8	Check: Does the UE transmit an ATTACH REQUEST message in the next 30 seconds on Cell K or Cell I?	-->	ATTACH REQUEST	2	F
8A	If possible (see ICS) switch off is performed or the USIM is removed. Otherwise the power is removed.	-	-	-	-
9	The SS reconfigures: Cell I as a "Serving cell", Cell K is the "Non-Suitable Off cell", Cell L as a "Non-Suitable Off cell", If present, Cell J as a "Non-Suitable Off cell".	-	-	-	-
9A	The UE is brought back to operation or the USIM is inserted.				
9B	The UE transmits an ATTACH REQUEST message including a PDN CONNECTIVITY REQUEST message.	-->	ATTACH REQUEST	-	-
9C	The SS reconfigures: Cell I as a "Suitable Neighbour intrafrequency cell", Cell L as a "Serving cell", If present, Cell J as a "Suitable Neighbour intrafrequency cell".	-	-		
9D	The SS transmits an ATTACH REJECT message, EMM cause = "No suitable cells in tracking area". (The list of "forbidden tracking areas for roaming" in the UE should now contain TAI-9)	<--	ATTACH REJECT	-	-
9E	The SS releases the RRC connection.	-	-	-	-
10	Check: Does the UE transmit an ATTACH REQUEST message including a PDN CONNECTIVITY REQUEST message as specified on Cell L?	-->	ATTACH REQUEST	3, 4	P

11	The SS transmits an ATTACH REJECT message, EMM cause = "No suitable cells in tracking area". (The list of "forbidden tracking areas for roaming" in the UE should now contain TAI-9 and TAI-11)	<--	ATTACH REJECT	-	-
12	The SS releases the RRC connection.	-	-	-	-
13	The SS reconfigures: Cell I as the "Serving cell". Cell K as a "Non-Suitable Off cell", Cell L as a " Suitable Neighbour intrafrequency cell", If present, Cell J as a "Non-Suitable Off cell".	-	-	-	-
-	The following messages are to be observed on Cell I unless explicitly stated otherwise.	-	-	-	-
14	Check: Does the UE transmit the ATTACH REQUEST message in the next 30 seconds?	-->	ATTACH REQUEST	5	F
15	If possible (see ICS) switch off is performed. Otherwise the power is removed.	-	-	-	-
16	The UE is brought back to operation.	-	-	-	-
17	Void	-	-	-	-
18	Check: Does the UE transmit an ATTACH REQUEST message including a PDN CONNECTIVITY REQUEST message?	-->	ATTACH REQUEST	6	P
19-31	The attach procedure is completed and the RRC connection released by executing steps 5 to 17 of the UE registration procedure in TS 36.508 clause 4.5.2.3.	-	-	-	-
-	At the end of this test procedure sequence, the UE is in end state E-UTRA idle (E1) according to TS 36.508.	-	-	-	-

9.2.1.1.17.3.3 Specific message contents

Table 9.2.1.1.17.3.3-1: Message ATTACH REJECT (step 4 and 11 Table 9.2.1.1.17.3.2-1)

Derivation Path: TS 36.508 Table 4.7.2-3			
Information Element	Value/remark	Comment	Condition
Security header type	0000	"No security protection"	
EMM cause	0000 1111	#15 "No suitable cells in tracking area"	
ESM message container	Not present		

Table 9.2.1.1.17.3.3-2: Message ATTACH REQUEST (step 10 Table 9.2.1.1.17.3.2-1)

Derivation Path: TS 36.508 Table 4.7.2-4			
Information Element	Value/remark	Comment	Condition
NAS key set identifier	111	"No key is available"	
Old GUTI or IMSI	IMSI-1	GUTI has been deleted after receiving ATTACH REJECT at step 4; only IMSI is available.	
Last visited registered TAI	Not present	TAI has been deleted after receiving ATTACH REJECT at step 4.	

9.2.1.1.18 Attach / Rejected / Not authorized for this CSG

9.2.1.1.18.1 Test Purpose (TP)

(1)

```
with { UE has sent an ATTACH REQUEST message including a PDN CONNECTIVITY REQUEST message }
ensure that {
  when { UE receives an ATTACH REJECT message with the reject cause set to " Not authorized for this
CSG " with integrity protection }
  then { UE shall remove the CSG ID from the allowed CSG list and search for a suitable cell in
the same PLMN }
}
```

(2)

```
with { UE in state EMM-REGISTERED and EMM-IDLE mode and the CSG ID is removed from the Allowed CSG
list }
ensure that {
  when { UE detects entering new tracking areas not included in the TAI list }
  then { UE attempts to enter a normal cell and does not choose a cell which not included in the
allowed CSG list }
}
```

9.2.1.1.18.2 Conformance requirements

References: The conformance requirements covered in the current TC are specified in: TS 24.301, clause 5.5.1.2.5.

[TS 24.301, clause 5.5.1.2.5]

#25 (Not authorized for this CSG);

Cause #25 is only applicable when received from a CSG cell. Cause #25 received from a non-CSG cell is considered as an abnormal case and the behaviour of the UE is specified in subclause 5.5.1.2.6.

If the ATTACH REJECT message with cause #25 was received without integrity protection, then the UE shall discard the message.

The UE shall set the EPS update status to EU3 ROAMING NOT ALLOWED (and shall store it according to subclause 5.1.3.3). Additionally, the UE shall reset the attach attempt counter and shall enter the state EMM-DEREGISTERED.LIMITED-SERVICE.

The UE shall remove the CSG ID of the cell where the UE has sent the ATTACH REQUEST message from the Allowed CSG list.

The UE shall search for a suitable cell in the same PLMN according to 3GPP TS 36.304 [21].

If A/Gb mode or Iu mode is supported by the UE, the UE shall in addition handle the GMM parameters GMM state, GPRS update status and GPRS attach attempt counter as specified in 3GPP TS 24.008 [13] for the case when the normal attach procedure is rejected with the GMM cause with the same value.

9.2.1.1.18.3 Test description

9.2.1.1.18.3.1 Pre-test conditions

System Simulator:

- cell A (TAC 1, frequency 1, not a CSG cell);
- cell B (TAC 2, frequency 1, is a CSG cell);
- cell D (TAC 3, frequency 1, not a CSG cell).
- System information combination 2 as defined in TS 36.508[18] clause 4.4.3.1 is used in E-UTRA cells A and D;
- System information combination 7 as defined in TS 36.508[18] clause 4.4.3.1 is used in cell B;

UE:

- the UE is configured to initiate EPS attach;
- the UE is previously registered on cell B using manual CSG selection (so the allowed CSG list includes CSG ID of cell B);
- the UE is previously registered on E-UTRAN, and when on E-UTRAN, the UE is last authenticated and registered in E-UTRAN using default message contents according to TS 36.508 [18].

Preamble:

- the UE is in state Switched OFF (state 1) according to TS 36.508 [18].

9.2.1.1.18.3.2 Test procedure sequence

Table 9.2.1.1.18.3.2-1: Main behaviour

St	Procedure	Message Sequence		TP	Verdict
		U - S	Message		
1	The SS configures: - Cell A as a "Not Suitable cell". - Cell B as a "Serving cell". - Cell D as a "Not Suitable cell".	-	-	-	-
-	The following messages are to be observed on Cell B unless explicitly stated otherwise.	-	-	-	-
2	The UE is switched on.	-	-	-	-
3	UE initiate attach procedure and send ATTACH REQUEST including a PDN CONNECTIVITY REQUEST message.	-->	ATTACH REQUEST	-	-
4	The SS transmits an ATTACH REJECT message with EMM cause = "Not authorized for this CSG" with integrity protection.	<--	ATTACH REJECT	-	-
5	The SS releases the RRC connection.	-	-	-	-
6	The SS configures: - Cell A as a "Not Suitable cell". - Cell B as a "Serving cell". - Cell D as a "Suitable neighbour intra-frequency cell".	-	-	-	-
-	The following messages are to be observed on Cell D unless explicitly stated otherwise.	-	-	-	-
7	Check: Does the UE transmit an ATTACH REQUEST message? Note: The UE shall search for a suitable cell in the same PLMN	-->	ATTACH REQUEST	1	P
8	The SS transmits an AUTHENTICATION REQUEST message to initiate the EPS authentication and AKA procedure.	<--	AUTHENTICATION REQUEST	-	-
9	The UE transmits an AUTHENTICATION RESPONSE message and establishes mutual authentication.	-->	AUTHENTICATION RESPONSE	-	-
10	The SS transmits a NAS SECURITY MODE COMMAND message to activate NAS security.	<--	SECURITY MODE COMMAND	-	-
11	The UE transmits a NAS SECURITY MODE COMPLETE message and establishes the initial security configuration.	-->	SECURITY MODE COMPLETE	-	-
-	EXCEPTION: Steps 12a1 to 12a2 describe behaviour that depends on UE configuration.	-	-	-	-
12a 1	IF the UE sets the ESM information transfer flag in the last PDN CONNECTIVITY REQUEST message THEN the SS transmits an ESM INFORMATION REQUEST message to initiate exchange of protocol configuration options and/or APN.	<--	ESM INFORMATION REQUEST	-	-
12a 2	The UE transmits an ESM INFORMATION RESPONSE message to transfer protocol configuration options and/or APN.	-->	ESM INFORMATION RESPONSE	-	-
13	SS responds with ATTACH ACCEPT message. The ACTIVATE DEFAULT EPS BEARER CONTEXT REQUEST message is piggybacked in ATTACH ACCEPT message.	<--	ATTACH ACCEPT	-	-
-	EXCEPTION: In parallel to the event described in step14 below the generic procedure for IP address allocation in the U-plane specified in TS 36.508 subclause 4.5A.1 takes place performing IP address allocation in the U-plane if requested by the UE.	-	-	-	-
14	The UE transmit an ATTACH COMPLETE message including an ACTIVATE DEFAULT EPS BEARER CONTEXT ACCEPT message.	-->	ATTACH COMPLETE	-	-

14 A	The SS releases the RRC Connection.	-	-	-	-
15	The SS configures: - Cell A as a "Non-Suitable cell". - Cell B as the "Serving cell". - Cell D as a "Not Suitable cell".	-	-	-	-
-	The following messages are to be observed on Cell B unless explicitly stated otherwise.	-	-	-	-
16	Check: Does the UE transmit a TRACKING AREA UPDATE REQUEST message in the next 30 seconds?	-->	TRACKING AREA UPDATE REQUEST	2	F
17	The SS configures: - Cell A as a "Serving cell". - Cell B as the "Not Suitable cell". - Cell D as a "Non-Suitable cell".	-	-	-	-
-	The following messages are to be observed on Cell A unless explicitly stated otherwise.	-	-	-	-
18	Check: Does the UE transmit a TRACKING AREA UPDATE REQUEST message?	-->	TRACKING AREA UPDATE REQUEST	2	P
19	The SS transmits a TRACKING AREA UPDATE ACCEPT message.	<--	TRACKING AREA UPDATE ACCEPT	-	-
20	The UE transmits a TRACKING AREA UPDATE COMPLETE message.	-->	TRACKING AREA UPDATE COMPLETE	-	-
-	At the end of this test procedure sequence, the UE is in end state E-UTRA connected (E2_T3440) according to TS 36.508.	-	-	-	-

9.2.1.1.18.3.3 Specific message contents

Table 9.2.1.1.18.3.3-1: Message ATTACH REJECT (step 4, Table 9.2.1.1.18.3.2-1)

Derivation path: 36.508 table 4.7.2-3			
Information Element	Value/Remark	Comment	Condition
EMM cause	00011001	#25 " Not authorized for this CSG "	
ESM message container	Not present		

Table 9.2.1.1.18.3.3-2: SystemInformationBlockType1 for Cell A, B, D (Pre-test conditions and all steps in Table 9.2.1.1.18.3.2-1)

Derivation Path: 36.508 clause 4.4.3-2			
Information Element	Value/remark	Comment	Condition
SystemInformationBlockType1 ::= SEQUENCE {			
cellAccessRelatedInfo SEQUENCE {			
csg-Indication	TRUE		Cell B
	FALSE		Cell A
	FALSE		Cell D
csg-Identity	Not present		Cell A
	Not present		Cell D
	'000 0000 0000 0000 0000 0000 0010'B		Cell B

9.2.1.1.19 Attach / Abnormal case / Failure due to non integrity protection

9.2.1.1.19.1 Test Purpose (TP)

(1)

```

with { UE having been initiated an Attach }
ensure that {
  when { UE receives an ATTACH ACCEPT messages without NAS integrity protection before NAS security
mode control procedure being performed }
  then { UE discards this message }
}

```

(2)

```

with { a valid NAS security context exists and the NAS security mode control procedure has been
successfully completed in the network and the UE }
ensure that {
  when { UE receives a valid NAS signalling message without integrity protection }
  then { UE discards this NAS signalling message }
}

```

(3)

```

with { a valid NAS security context exists and the NAS security mode control procedure has been
successfully completed in the network and the UE }
ensure that {
  when { UE receives a valid security protected NAS signalling message with the Message
authentication code set to an incorrect value }
  then { UE discards this NAS signalling message }
}

```

(4)

```

with { a valid NAS security context exists and the NAS security mode control procedure has been
successfully completed in the network and the UE }
ensure that {
  when { UE receives a valid NAS signalling message with integrity protection which require a
response from the UE }
  then { UE sends the response as a security protected NAS message }
}

```

9.2.1.1.19.2 Conformance requirements

References: The conformance requirements covered in the present TC are specified in: TS 24.301, clauses 4.4.4.1, 4.4.4.2 and 5.5.2.2.

[TS 24.301, clause 4.4.4.1]

For the UE, integrity protected signalling is mandatory for the NAS messages once a valid EPS security context exists and has been taken into use. For the network, integrity protected signalling is mandatory for the NAS messages once a secure exchange of NAS messages has been established for the NAS signalling connection. Integrity protection of all NAS signalling messages is the responsibility of the NAS. It is the network which activates integrity protection.

...

[TS 24.301, clause 4.4.4.2]

Except the messages listed below, no NAS signalling messages shall be processed by the receiving EMM entity in the UE or forwarded to the ESM entity, unless the secure exchange of NAS messages has been established for the NAS signalling connection:

- EMM messages:
- IDENTITY REQUEST (if requested identification parameter is IMSI);
- AUTHENTICATION REQUEST;
- AUTHENTICATION REJECT;
- ATTACH REJECT;
- DETACH REQUEST;
- DETACH ACCEPT (for non switch off);
- TRACKING AREA UPDATE REJECT;
- SERVICE REJECT.

NOTE: These messages are accepted by the UE without integrity protection, as in certain situations they are sent by the network before security can be activated.

All ESM messages are integrity protected.

Once the secure exchange of NAS messages has been established, the receiving EMM or ESM entity in the UE shall not process any NAS signalling messages unless they have been successfully integrity checked by the NAS. If NAS signalling messages, having not successfully passed the integrity check, are received, then the NAS in the UE shall discard that message. If any NAS signalling message is received as not integrity protected even though the secure exchange of NAS messages has been established by the network, then the NAS shall discard this message.

[TS 24.301, clause 5.5.2.2.1]

...

If the UE is to be switched off, the UE shall:

- delete the current EPS security context stored in the UE as specified in annex C, if it is a mapped EPS security context;
- store the native EPS security context (if it is valid), as specified in annex C; and
- try for a period of 5 seconds to send the DETACH REQUEST message. During this period, the UE may be switched off as soon as the DETACH REQUEST message has been sent.

...

9.2.1.1.19.3 Test description

9.2.1.1.19.3.1 Pre-test conditions

System Simulator:

- cell A.

UE:

- the UE is previously registered on E-UTRAN, and when on E-UTRAN, the UE is last authenticated and registered on cell A using default message contents according to TS 36.508 [18].

Note: Any type of attach is acceptable.

Preamble:

- the UE is in state Switched OFF (state 1) according to TS 36.508 [18].
- The NAS integrity algorithm shall be set to a different value than 'EPS integrity algorithm' EIA0 throughout the whole duration of the test.

9.2.1.1.19.3.2 Test procedure sequence

Table 9.2.1.1.19.3.2-1: Main behaviour

St	Procedure	Message Sequence		TP	Verdict
		U - S	Message		
1	The UE is switched on.	-	-	-	-
2	The UE transmits an ATTACH REQUEST message including a PDN CONNECTIVITY REQUEST message. Note: The ATTACH REQUEST message shall be sent as a security protected NAS message (see TS 24.301 – clause 9.1).	-->	ATTACH REQUEST	-	-
-	EXCEPTION: Steps 2Aa1 to 2Aa2 describe behaviour that depends on UE configuration; the "lower case letter" identifies a step sequence that take place if the UE has ESM information which needs to be transferred.	-	-	-	-
2A a1	IF the UE sets the ESM information transfer flag in the last PDN CONNECTIVITY REQUEST message THEN the SS transmits an ESM INFORMATION REQUEST message to initiate exchange of protocol configuration options and/or APN.	<--	ESM INFORMATION REQUEST	-	-
2A a2	The UE transmits an ESM INFORMATION RESPONSE message to transfer protocol configuration options and/or APN.	-->	ESM INFORMATION RESPONSE	-	-
3	The SS transmits an ATTACH ACCEPT although UE has not successfully completed any NAS security mode control procedure. Note: The ATTACH ACCEPT message is sent as a plain NAS message (see TS 24.301 – clause 9.1).	<--	ATTACH ACCEPT	-	-
4	Check: Does the UE transmit an ATTACH COMPLETE message within the next 3s? Note: The UE is expected to discard the ATTACH ACCEPT message without security protection.	-->	ATTACH COMPLETE	1	F
5	The SS transmits an AUTHENTICATION REQUEST message to initiate the EPS authentication and AKA procedure.	<--	AUTHENTICATION REQUEST	-	-
6	The UE transmits an AUTHENTICATION RESPONSE message to establish mutual authentication.	-->	AUTHENTICATION RESPONSE	-	-
7	The SS transmits a SECURITY MODE COMMAND message to activate NAS security.	<--	SECURITY MODE COMMAND	-	-
8	The UE transmits a SECURITY MODE COMPLETE message and establishes the initial security configuration.	-->	SECURITY MODE COMPLETE	-	-
9	The SS transmits an ATTACH ACCEPT without integrity protection. Note: The ATTACH ACCEPT message is sent as a plain NAS message (see TS 24.301 – clause 9.1).	<--	ATTACH ACCEPT	-	-
10	Check: Does the UE transmit an ATTACH COMPLETE message within the next 3s? Note: The UE is expected to discard the ATTACH ACCEPT message without security protection	-->	ATTACH COMPLETE	2	F
11	The SS transmits an ATTACH ACCEPT with integrity protection with the Message authentication code set to an incorrect value.	<--	ATTACH ACCEPT	-	-

	Note: The ATTACH ACCEPT message is sent as a security protected NAS message (see TS 24.301 – clause 9.1).				
12	Check: Does the UE transmit an ATTACH COMPLETE message within the next 3s? Note: The UE is expected to discard the ATTACH ACCEPT message because the integrity check is failed.	-->	ATTACH COMPLETE	3	F
13	The SS transmits an ATTACH ACCEPT message including an ACTIVATE DEFAULT EPS BEARER CONTEXT REQUEST. Note: The ATTACH ACCEPT message is sent as a security protected NAS message (see TS 24.301 – clause 9.1). Note 1: SS allocates a PDN address of a PDN type which is compliant with the PDN type requested by the UE.	<--	ATTACH ACCEPT	-	-
-	EXCEPTION: In parallel to the event described in step 14 below the generic procedure for IP address allocation in the U-plane specified in TS 36.508 subclause 4.5A.1 takes place performing IP address allocation in the U-plane if requested by the UE.	-	-	-	-
14	Check: Does the UE transmit an ATTACH COMPLETE message including an ACTIVATE DEFAULT EPS BEARER CONTEXT ACCEPT message as specified? Note: The ATTACH COMPLETE message is sent as a security protected NAS message (see TS 24.301 – clause 9.1).	-->	ATTACH COMPLETE	4	P
15	The SS releases the RRC connection.	-	-	-	-
16	Check: Does the test results of test procedure in 36.508 clause 6.4.2.4 indicate that the UE is in E-UTRA EMM-REGISTERED state with S-TMSI-2? Note: This step verifies that the UE has correctly stored the GUTI-4 which was included in the protected ATTACH ACCEPT messages.	-	-	4	-
-	At the end of this test procedure sequence, the UE is in end state E-UTRA idle (E1) according to TS 36.508.	-	-	-	-

9.2.1.1.19.3.3 Specific message contents

Table 9.2.1.1.19.3.3-1: Message ATTACH ACCEPT (steps 3 and 9, Table 9.2.1.1.19.3.2-1)

Derivation path: 36.508 table 4.7.2-1 (Plain NAS message)			
Information Element	Value/Remark	Comment	Condition
GUTI	GUTI-2	The SS chooses a value different from GUTI-1.	

Table 9.2.1.1.19.3.3-2: Message SECURITY PROTECTED NAS MESSAGE (step 11, Table 9.2.1.1.19.3.2-1)

Derivation path: 36.508 table 4.7.1-1 with condition CIPHERED			
Information Element	Value/Remark	Comment	Condition
Message authentication code	Incorrect value	The SS chooses an incorrect value which fails integrity checks. (e.g. 00000000)	
NAS message	ATTACH ACCEPT (see table 9.2.1.1.19.3.3-3)		

Table 9.2.1.1.19.3.3-3: Message ATTACH ACCEPT (step 11, Table 9.2.1.1.19.3.2-1)

Derivation path: 36.508 table 4.7.2-1 (Security protected NAS message)			
Information Element	Value/Remark	Comment	Condition
GUTI	GUTI-3	The SS chooses a value different from GUTI-1 and GUTI-2.	

Table 9.2.1.1.19.3.3-4: Message ATTACH ACCEPT (step 13, Table 9.2.1.1.19.3.2-1)

Derivation path: 36.508 table 4.7.2-1 (Security protected NAS message)			
Information Element	Value/Remark	Comment	Condition
GUTI	GUTI-4	The SS chooses a value different from GUTI-1, GUTI-2 and GUTI-3.	

9.2.1.1.20 Attach / Abnormal case / Access barred because of access class barring or NAS signalling connection establishment rejected by the network

9.2.1.1.20.1 Test Purpose (TP)

(1)

```
with { UE switched-on, and not yet attached to EPS }
ensure that {
  when { Access is barred for signalling in the cell UE is camping [Access Class barred in System information] }
  then { the UE will not initiate any Attach procedure on the current cell }
}
```

(2)

```
with { UE switched-on, and not yet attached to EPS }
ensure that {
  when { Access is barred for signalling in the cell UE is camping [T302 running due to RRCConnectionReject message reception] }
  then { the UE will not initiate any Attach procedure on the current cell }
}
```

(3)

```
with { UE switched-on, and not yet attached to EPS }
ensure that {
  when { Access is not barred for signalling in the cell UE is camping }
  then { the UE will initiate Attach procedure on the current cell }
}
```

(4)

```
with { UE switched-on, and not yet attached to EPS }
ensure that {
```

```

when { Access was barred for signalling in the cell and UE has reselected an new cell where access
for "signalling" is granted }
then { the UE will initiate Attach procedure on the new cell }
}

```

9.2.1.1.20.2 Conformance requirements

References: The conformance requirements covered in the current TC are specified in: TS 24.301, clause 5.5.1.2.6 and TS 36.331, clause 5.3.3.2

[TS 24.301, clause 5.5.1.2.6]

The following abnormal cases can be identified:

- a) Access barred because of access class barring or NAS signalling connection establishment rejected by the network

If access is barred for "signalling" (see 3GPP TS 36.331 [22]), the attach procedure shall not be started. The UE stays in the current serving cell and applies the normal cell reselection process. The attach procedure is started as soon as possible, i.e. when access for "signalling" is granted on the current cell or when the UE moves to a cell where access for "signalling" is granted.

[TS 36.331, clause 5. 3.3.2]

- 1> else (the UE is establishing the RRC connection for mobile originating signalling):
 - 2> if timer T302 or T305 is running:
 - 3> consider access to the cell as barred;
 - 2> else if *SystemInformationBlockType2* includes the *ac-BarringInformation* and the *ac-BarringForMO-Signalling* is present:
 - 3> if the UE has one or more Access Classes, as stored on the USIM, with a value in the range 11..15, which is valid for the UE to use according to TS 22.011 [10] and TS 23.122 [11], and
 - 3> for at least one of these Access Classes the corresponding bit in the *ac-BarringForSpecialAC* contained in *ac-BarringForMO-Signalling* is set to zero:
 - 4> consider access to the cell as not barred;
 - 3> else:
 - 4> draw a random number '*rand*' uniformly distributed in the range: $0 \leq rand < 1$;
 - 4> if '*rand*' is lower than the value indicated by *accessProbabilityFactor* included in *accessBarringForSignalling*:
 - 5> consider access to the cell as not barred;
 - 4> else:
 - 5> consider access to the cell as barred;
 - 2> else:
 - 3> consider access to the cell as not barred;

9.2.1.1.20.3 Test description

9.2.1.1.20.3.1 Pre-test conditions

System Simulator:

- cell I and cell K are configured according to table 6.3.2.2-1 in TS 36.508 [18].
- cell I and cell K belong to TAI-9 (home PLMN)

UE:

- the UE is configured to initiate EPS attach;
- the UE is previously registered on E-UTRAN, and when on E-UTRAN, the UE is last authenticated and registered on cell K using default message contents according to TS 36.508 [18].

Preamble:

- the UE is in state Switched OFF (state 1) according to TS 36.508 [18].

9.2.1.1.20.3.2 Test procedure sequence

Table 9.2.1.1.20.3.2-1: Main behaviour

St	Procedure	Message Sequence		TP	Verdict
		U - S	Message		
1	The SS sets the cell type of cell I to the "Serving cell", set the cell type of cell K to the "Non- Suitable cell", and sets SystemInformationBlockType2 parameters as described below. The UE is switched on.	-	-	-	-
-	The following messages are to be observed on Cell I unless explicitly stated otherwise.	-	-	-	-
2	Check: For 90 seconds if UE initiates Attach procedure and hence transmits RRC Connection Request?	-	-	1	F
3	The SS transmits a Paging message including systemInfoModification.	-	-	-	-
4	The SS changes SystemInformationBlockType2 parameters to default parameters defined in [18].	-	-	-	-
5	The UE transmits RRC Connection Request	-	-	-	-
6	SS responds with <i>RRCConnectionReject</i> message with IE <i>waitTime</i> set to 10 seconds (Max Value).	-	-	-	-
7	Check: For 10 seconds if UE initiates Attach procedure and hence transmits RRC Connection Request?	-	-	2	F
8	Check: Does the UE transmit an ATTACH REQUEST message including a PDN CONNECTIVITY REQUEST message?	-->	ATTACH REQUEST	3	P
9	The SS transmits an AUTHENTICATION REQUEST message to initiate the EPS authentication and AKA procedure.	<--	AUTHENTICATION REQUEST	-	-
10	The UE transmits an AUTHENTICATION RESPONSE message and establishes mutual authentication.	-->	AUTHENTICATION RESPONSE	-	-
11	The SS transmits a NAS SECURITY MODE COMMAND message to activate NAS security.	<--	SECURITY MODE COMMAND	-	-
12	The UE transmits a NAS SECURITY MODE COMPLETE message and establishes the initial security configuration.	-->	SECURITY MODE COMPLETE	-	-
-	EXCEPTION: Steps 12Aa1 to 12Aa2 describe behaviour that depends on UE configuration; the "lower case letter" identifies a step sequence that take place if the UE has ESM information which needs to be transferred.	-	-	-	-
12 Aa 1	IF the UE sets the ESM information transfer flag in the last PDN CONNECTIVITY REQUEST message THEN the SS transmits an ESM INFORMATION REQUEST message to initiate exchange of protocol configuration options and/or APN.	<--	ESM INFORMATION REQUEST	-	-
12 Aa 2	The UE transmits an ESM INFORMATION RESPONSE message to transfer protocol configuration options and/or APN.	-->	ESM INFORMATION RESPONSE	-	-
13	SS responds with ATTACH ACCEPT message including a valid TAI list. The ACTIVATE DEFAULT EPS BEARER CONTEXT REQUEST message is piggybacked in ATTACH ACCEPT message Note: The IP addresses of the UE are not allocated in this test so PDN address is not included in the message.	<--	ATTACH ACCEPT	-	-
14	Check: Does the UE transmit an ATTACH	-->	ATTACH COMPLETE	-	-

	COMPLETE message including an ACTIVATE DEFAULT EPS BEARER CONTEXT ACCEPT message?				
15	The SS releases the RRC connection.	-	-	-	-
16	If possible (see ICS) switch off is performed or the USIM is removed. Otherwise the power is removed.	-	-	-	-
-	EXCEPTION: Step 16a describes behaviour that depends on the UE capability.				
16a	If pc_SwitchOnOff or pc_USIM_Removal then UE sends DETACH REQUEST message	-->	DETACH REQUEST		
17	The SS sets the cell type of cell I to the "Serving cell", sets the cell type of cell K to the " Non- Suitable cell", and sets SystemInformationBlockType1 and SystemInformationBlockType2 parameters as described below. The UE is brought back to operation or the USIM is inserted.	-	-	-	-
18	Check: for 90 seconds if UE initiates Attach procedure and hence transmits RRC Connection Request?	-	-	1	F
19	The SS sets the cell type of cell K to the "serving cell" and cell I to "suitable Cell".				
-	The following messages are to be observed on Cell K unless explicitly stated otherwise.	-	-	-	-
20	Check: Does the UE transmit an ATTACH REQUEST message including a PDN CONNECTIVITY REQUEST message?	-->	ATTACH REQUEST	4	P
21-32	The attach procedure is completed by executing steps 5 to 16 of the UE registration procedure in TS 36.508 sub clause 4.5.2.3.	-	-	-	-
-	At the end of this test procedure sequence, the UE is in end state E-UTRA connected (E2) according to TS 36.508.	-	-	-	-

9.2.1.1.20.3

Specific message contents

Table 9.2.1.1.20.3.3-1: SystemInformationBlockType2 for Cell I (step 1 and 17)

Derivation Path: 36.508, Table 4.4.3.3-1			
Information Element	Value/remark	Comment	Condition
SystemInformationBlockType2 ::= SEQUENCE {			
accessBarringInformation SEQUENCE {			
accessBarringForEmergencyCalls	FALSE		
accessBarringForSignalling SEQUENCE {			
accessProbabilityFactor	p00		
accessBarringTime	s4		
accessClassBarringList SEQUENCE (SIZE (maxAC)) OF SEQUENCE {	5 entries		
accessClassBarring[1]	TRUE		
accessClassBarring[2]	TRUE		
accessClassBarring[3]	TRUE		
accessClassBarring[4]	TRUE		
accessClassBarring[5]	TRUE		
}			
}			
accessBarringForOriginatingCalls	Not present		
}			
}			

Table 9.2.1.1.20.3.3-2: SystemInformationBlockType1 for Cell I (step 17)

Derivation Path: 36.508, Table 4.4.3.2-3			
Information Element	Value/remark	Comment	Condition
SystemInformationBlockType1 ::= SEQUENCE {			
cellAccessRelatedInfo SEQUENCE {			
intraFreqReselection	allowed		
}			
}			

9.2.1.1.21 Attach / Abnormal case / Success after several attempts due to no network response

9.2.1.1.21.1 Test Purpose (TP)

(1)

```
with { UE has sent an ATTACH REQUEST message and started T3410 timer}
ensure that {
  when { T3410 timer expires }
  then { the UE release NAS signalling connection locally}
}
```

(2)

```
with { UE has sent an ATTACH REQUEST message and T3410 timer expired}
ensure that {
  when { T3411 timer expires and attach attempt counter is less than 5 }
  then { the UE restarts the attach procedure}
```

(3)

```
with { UE has sent an ATTACH REQUEST message }
ensure that {
  when { Lower Layer failure (RRC Connection is released) before the ATTACH ACCEPT or ATTACH REJECT
message is received, T3411 has expired and attach attempt counter is less than 5}
  then { the UE restarts the attach procedure }
}
```

9.2.1.1.21.2 Conformance requirements

References: The conformance requirements covered in the current TC are specified in: TS 24.301, clause 5.5.1.2.6 & 10.2

[TS 24.301, clause 5.5.1.2.6]

The following abnormal cases can be identified:

...

- b) Lower layer failure or release of the NAS signalling connection before the ATTACH ACCEPT or ATTACH REJECT message is received

The attach procedure shall be aborted, and the UE shall proceed as described below.

- c) T3410 timeout

The UE shall abort the attach procedure and proceed as described below. The NAS signalling connection shall be released locally.

...

For the cases b, c, and d the UE shall proceed as follows:

- Timer T3410 shall be stopped if still running. The attach attempt counter shall be incremented, unless it was already set to 5.

If the attach attempt counter is less than 5:

- timer T3411 is started and the state is changed to EMM-DEREGISTERED.ATTEMPTING-TO-ATTACH. When timer T3411 expires the attach procedure shall be restarted.

[TS 24.301, clause 10.2]

Table 10.2.1: EPS mobility management timers – UE side

TIMER NUM.	TIMER VALUE	STATE	CAUSE OF START	NORMAL STOP	ON EXPIRY
...					
T3410	15s	EMM-REGISTERED-INITIATED	ATTACH REQUEST sent	ATTACH ACCEPT received ATTACH REJECT received	Start T3411 or T3402 as described in subclause 5.5.1.2.6
T3411	10s	EMM-DEREGISTERED.ATTEMPTING-TO-ATTACH EMM-REGISTERED.ATTEMPTING-TO-UPDATE	At attach failure due to lower layer failure, T3410 timeout or attach rejected with other EMM cause values than those treated in subclause 5.5.1.2.5. At tracking area updating failure due to lower layer failure, T3430 timeout or TAU rejected with other EMM cause values than those treated in subclause 5.5.3.2.5.	ATTACH REQUEST sent TRACKING AREA UPDATE REQUEST sent	Retransmission of the ATTACH REQUEST or TRACKING AREA UPDATE REQUEST

9.2.1.1.21.3 Test description

9.2.1.1.21.3.1 Pre-test conditions

System Simulator:

- cell A.

UE:

- the UE is configured to initiate EPS attach.

Preamble:

- the UE is in state Switched OFF (state 1) according to TS 36.508 [18].

9.2.1.1.21.3.2 Test procedure sequence

Table 9.2.1.1.21.3.2-1: Main behaviour

St	Procedure	Message Sequence		TP	Verdict
		U - S	Message		
1	The UE is switched on.	-	-	-	-
2	The UE transmits an ATTACH REQUEST message.	-->	ATTACH REQUEST	-	-
3	The SS waits 20 seconds (15 seconds T3410 and 5 seconds half of T3411).	-		-	-
4	SS transmits an IDENTITY REQUEST message requesting IMSI in the IE Identity type	<--	IDENTITY REQUEST	-	-
	Exception: In parallel with steps 5 and 6, the parallel behaviour defined in table 9.2.1.1.1.3.2-2 is running.				
5	The SS waits 5 seconds (half of T3411)	-	-	-	-
6	Check: The UE transmit an ATTACH REQUEST message?	-->	ATTACH REQUEST	2	P
7	The SS releases the RRC connection.				
8	The SS waits 10 seconds (T3411).				
9	Check: The UE transmits an ATTACH REQUEST message?	-->	ATTACH REQUEST	3	P
10-21	The attach procedure is completed by executing steps 5 to 16 of the UE registration procedure in TS 36.508 sub clause 4.5.2.3.	-	-	-	-
-	At the end of this test procedure sequence, the UE is in end state E-UTRA connected (E2) according to TS 36.508.	-	-	-	-

Table 9.2.1.1.21.3.2-2: Parallel behaviour

St	Procedure	Message Sequence		TP	Verdict
		U - S	Message		
1	Check: Does the UE send an IDENTITY RESPONSE message?	-->	IDENTITY RESPONSE	1	F

9.2.1.1.21.3.3 Specific message contents

None

9.2.1.1.22 Attach / Abnormal case / Unsuccessful attach after 5 attempts

9.2.1.1.22.1 Test Purpose (TP)

(1)

```

with { UE has sent an ATTACH REQUEST message }
ensure that {
  when { T3411 has expired and attach attempt counter is equal to 5 }
  then { the UE stops attach attempts and starts timer T3402 }
}

```

9.2.1.1.22.2 Conformance requirements

References: The conformance requirements covered in the current TC are specified in: TS 24.301, clause 5.5.1.2.6 & 10.2

[TS 24.301, clause 5.5.1.2.6]

The following abnormal cases can be identified:

...

- b) Lower layer failure or release of the NAS signalling connection before the ATTACH ACCEPT or ATTACH REJECT message is received

The attach procedure shall be aborted, and the UE shall proceed as described below.

- c) T3410 timeout

The UE shall abort the attach procedure and proceed as described below. The NAS signalling connection shall be released locally.

...

For the cases b, c, and d the UE shall proceed as follows:

- Timer T3410 shall be stopped if still running. The attach attempt counter shall be incremented, unless it was already set to 5.

If the attach attempt counter is less than 5:

- timer T3411 is started and the state is changed to EMM-DEREGISTERED.ATTEMPTING-TO-ATTACH. When timer T3411 expires the attach procedure shall be restarted.

If the attach attempt counter is equal to 5:

- the UE shall delete any GUTI, TAI list, last visited registered TAI, list of equivalent PLMNs and KSI, shall set the update status to EU2 NOT UPDATED, and shall start timer T3402. The state is changed to EMM-DEREGISTERED.ATTEMPTING-TO-ATTACH or optionally to EMM-DEREGISTERED.PLMN-SEARCH in order to perform a PLMN selection according to 3GPP TS 23.122 [6].

If A/Gb mode or Iu mode is supported by the UE, the UE shall in addition handle the GMM parameters GMM state, GPRS update status, P-TMSI, P-TMSI signature, RAI and GPRS ciphering key sequence number as specified in 3GPP TS 24.008 [13] for the abnormal case when a normal attach procedure fails and the attach attempt counter is equal to 5.

[TS 24.301, clause 10.2]

Table 10.2.1: EPS mobility management timers – UE side

TIMER NUM.	TIMER VALUE	STATE	CAUSE OF START	NORMAL STOP	ON EXPIRY
T3402	Default 12 min. NOTE 1	EMM-DEREGISTERED EMM-REGISTERED	At attach failure and the attempt counter is equal to 5. At tracking area updating failure and the attempt counter is equal to 5.	ATTACH REQUEST sent TRACKING AREA UPDATE REQUEST sent	Initiation of the attach procedure or TAU procedure
...					
T3410	15s	EMM-REGISTERED-INITIATED	ATTACH REQUEST sent	ATTACH ACCEPT received ATTACH REJECT received	Start T3411 or T3402 as described in subclause 5.5.1.2.6
T3411	10s	EMM-DEREGISTERED.ATTEMPTING-TO-ATTACH EMM-REGISTERED.ATTEMPTING-TO-UPDATE	At attach failure due to lower layer failure, T3410 timeout or attach rejected with other EMM cause values than those treated in subclause 5.5.1.2.5. At tracking area updating failure due to lower layer failure, T3430 timeout or TAU rejected with other EMM cause values than those treated in subclause 5.5.3.2.5.	ATTACH REQUEST sent TRACKING AREA UPDATE REQUEST sent	Retransmission of the ATTACH REQUEST or TRACKING AREA UPDATE REQUEST
...					
Note 1: The default value of this timer is used if the network does not indicate another value in an EMM signalling procedure.					

9.2.1.1.22.3 Test description

9.2.1.1.22.3.1 Pre-test conditions

System Simulator:

- cell A.

Note: T3402 is set to default (12 min).

UE:

- the UE is configured to initiate EPS attach;
- the UE is previously registered on E-UTRAN, and when on E-UTRAN, the UE is last authenticated and registered on cell A using default message contents according to TS 36.508 [18].

Preamble:

- the UE is in state Switched OFF (state 1) according to TS 36.508 [18].

9.2.1.1.22.3.2 Test procedure sequence

Table 9.2.1.1.22.3.2-1: Main behaviour

St	Procedure	Message Sequence		TP	Verdict
		U – S	Message		
1	The UE is switched on.	-	-	-	-
2	The UE transmits an ATTACH REQUEST message. (Attach attempt counter = 1)	-->	ATTACH REQUEST	-	-
3	The SS waits 25 seconds (15 seconds T3410 and 10 seconds T3411).	-		-	-
4	The UE transmits an ATTACH REQUEST message. (Attach attempt counter = 2)	-->	ATTACH REQUEST	-	-
5	The SS releases the RRC connection.				
6	The SS waits 10 seconds (T3411).				
7	The UE transmits an ATTACH REQUEST message. (Attach attempt counter = 3)	-->	ATTACH REQUEST	-	-
8	The SS waits 25 seconds (15 seconds T3410 and 10 seconds T3411).	-		-	-
9	The UE transmits an ATTACH REQUEST message. (Attach attempt counter = 4)	-->	ATTACH REQUEST	-	-
10	The SS releases the RRC connection.				
11	The SS waits 10 seconds (T3411).				
12	The UE transmits an ATTACH REQUEST message. (Attach attempt counter = 5)	-->	ATTACH REQUEST		
13	The SS releases the RRC connection.				
14	Check: Does the UE transmit an ATTACH REQUEST message after 12 minutes (default value of T3402, after step 13?	-->	ATTACH REQUEST	1	P
15-26	The attach procedure is completed by executing steps 5 to 16 of the UE registration procedure in TS 36.508 sub clause 4.5.2.3.	-	-	-	-
-	At the end of this test procedure sequence, the UE is in end state E-UTRA connected (E2) according to TS 36.508.	-	-	-	-

9.2.1.1.22.3.3 Specific message contents

Table 9.2.1.1.22.3.3-1: Message ATTACH REQUEST (step 14, Table 9.2.1.1.22.3.2-1)

Derivation Path: TS 36.508 Table 4.7.2-4			
Information Element	Value/remark	Comment	Condition
NAS key set identifier	111	"No key is available"	
Old GUTI or IMSI	IMSI-1	GUTI has been deleted; only IMSI is available.	
Last visited registered TAI	Not present	TAI has been deleted.	

9.2.1.1.23 Attach / Abnormal case / Repeated rejects for network failures

9.2.1.1.23.1 Test Purpose (TP)

(1)

```

with { UE having valid GUTI, has sent an ATTACH REQUEST message }
ensure that {
  when { UE receives an ATTACH REJECT message with the reject cause set to #17 or #22 and attach
attempt counter is less than 5 }
    then { UE starts timer T3411 and shall not delete stored GUTI }
    when { Timer T3411 expires }
    then { UE restarts attach procedure }
}

```

(2)

```

with { UE having valid GUTI, has sent an ATTACH REQUEST message }
ensure that {
  when { UE receives an ATTACH REJECT message with the reject cause set to #22 and attempt counter
is set to 5 }
    then { the UE stops attach attempts and starts timer T3402, shall delete stored GUTI }
}

```

NOTE: Only representative coverage for various abnormal reject causes is provided.

9.2.1.1.23.2 Conformance requirements

References: The conformance requirements covered in the current TC are specified in: TS 24.301, clause 5.5.1.2.5, 5.5.1.2.6, 9.9.3.9 & 10.2

[TS 24.301, clause 5.5.1.2.5]

If the attach request cannot be accepted by the network, the MME shall send an ATTACH REJECT message to the UE including an appropriate EMM cause value. If the attach procedure fails due to a default EPS bearer setup failure, an ESM procedure failure, or operator determined barring is applied on default EPS bearer context activation during attach procedure, the MME shall combine the ATTACH REJECT message with a PDN CONNECTIVITY REJECT message contained in the ESM message container information element. In this case the EMM cause value in the ATTACH REJECT message shall be set to #19 "ESM failure".

Upon receiving the ATTACH REJECT message, the UE shall stop timer T3410 and take the following actions depending on the EMM cause value received.

...

Other values are considered as abnormal cases. The behaviour of the UE in those cases is specified in subclause 5.5.1.2.6.

[TS 24.301, clause 5.5.1.2.6]

The following abnormal cases can be identified:

...

d) ATTACH REJECT, other EMM cause values than those treated in subclause 5.5.1.2.5

Upon reception of the EMM cause #19, "ESM failure", the UE may set the attach attempt counter to 5. Upon reception of the EMM causes #95, #96, #97, #99 and #111 the UE should set the attach attempt counter to 5.

The UE shall proceed as described below.

...

For the cases b, c, and d the UE shall proceed as follows:

- Timer T3410 shall be stopped if still running. The attach attempt counter shall be incremented, unless it was already set to 5.

If the attach attempt counter is less than 5:

- timer T3411 is started and the state is changed to EMM-DEREGISTERED.ATTEMPTING-TO-ATTACH. When timer T3411 expires the attach procedure shall be restarted.

If the attach attempt counter is equal to 5:

- the UE shall delete any GUTI, TAI list, last visited registered TAI, list of equivalent PLMNs and KSI, shall set the update status to EU2 NOT UPDATED, and shall start timer T3402. The state is changed to EMM-DEREGISTERED.ATTEMPTING-TO-ATTACH or optionally to EMM-DEREGISTERED.PLMN-SEARCH in order to perform a PLMN selection according to 3GPP TS 23.122 [6].

If A/Gb mode or Iu mode is supported by the UE, the UE shall in addition handle the GMM parameters GMM state, GPRS update status, P-TMSI, P-TMSI signature, RAI and GPRS ciphering key sequence number as specified in 3GPP TS 24.008 [13] for the abnormal case when a normal attach procedure fails and the attach attempt counter is equal to 5.

[TS 24.301, clause 9.9.3.9]

Table 9.9.3.9.1: EMM cause information element

Cause value (octet 2)								
Bits								
8	7	6	5	4	3	2	1	
0	0	0	1	0	0	0	1	...
0	0	0	1	0	0	1	0	Network failure
0	0	0	1	0	0	1	1	CS domain not available
0	0	0	1	0	1	0	0	ESM failure
0	0	0	1	0	1	0	1	MAC failure
0	0	0	1	0	1	1	0	Synch failure
0	0	0	1	0	1	1	1	Congestion
0	0	0	1	0	1	1	1	UE security capabilities mismatch
								...
Any other value received by the mobile station shall be treated as 0110 1111, "protocol error, unspecified". Any other value received by the network shall be treated as 0110 1111, "protocol error, unspecified".								

[TS 24.301, clause 10.2]

Table 10.2.1: EPS mobility management timers – UE side

TIMER NUM.	TIMER VALUE	STATE	CAUSE OF START	NORMAL STOP	ON EXPIRY
T3402	Default 12 min. NOTE 1	EMM- DEREGISTERED EMM- REGISTERED	At attach failure and the attempt counter is equal to 5. At tracking area updating failure and the attempt counter is equal to 5.	ATTACH REQUEST sent TRACKING AREA UPDATE REQUEST sent	Initiation of the attach procedure or TAU procedure
...					
T3410	15s	EMM- REGISTERED- INITIATED	ATTACH REQUEST sent	ATTACH ACCEPT received ATTACH REJECT received	Start T3411 or T3402 as described in subclause 5.5.1.2.6
T3411	10s	EMM- DEREGISTERED. ATTEMPTING- TO-ATTACH EMM- REGISTERED. ATTEMPTING- TO-UPDATE	At attach failure due to lower layer failure, T3410 timeout or attach rejected with other EMM cause values than those treated in subclause 5.5.1.2.5. At tracking area updating failure due to lower layer failure, T3430 timeout or TAU rejected with other EMM cause values than those treated in subclause 5.5.3.2.5.	ATTACH REQUEST sent TRACKING AREA UPDATE REQUEST sent	Retransmission of the ATTACH REQUEST or TRACKING AREA UPDATE REQUEST
...					
Note 1:	The default value of this timer is used if the network does not indicate another value in an EMM signalling procedure.				

9.2.1.1.23.3 Test description

9.2.1.1.23.3.1 Pre-test conditions

System Simulator:

- cell A.

Note: T3402 is set to default (12 min.).

UE:

- the UE is configured to initiate EPS attach
- the UE is previously registered on E-UTRAN, and when on E-UTRAN, the UE is last authenticated and registered on cell A using default message contents according to TS 36.508 [18].

Preamble:

- the UE is in state Switched OFF (state 1) according to TS 36.508 [18].

9.2.1.1.23.3.2 Test procedure sequence

Table 9.2.1.1.23.3.2-1: Main behaviour

St	Procedure	Message Sequence		TP	Verdict
		U – S	Message		
1	The UE is switched on.	-	-	-	-
2	The UE transmits an ATTACH REQUEST message. (Attach attempt counter = 1)	-->	ATTACH REQUEST	-	-
3	The SS transmits an ATTACH REJECT message, EMM cause = Network failure (#17)	<--	ATTACH REJECT	-	-
4	The SS releases the RRC connection.	-	-	-	-
5	The SS waits 10 seconds (T3411).	-	-	-	-
6	Check: Does the UE transmit an ATTACH REQUEST message? (Attach attempt counter = 2)	-->	ATTACH REQUEST	1	P
7	The SS transmits an ATTACH REJECT message, EMM cause = Network failure (#17)	<--	ATTACH REJECT	-	-
8	The SS releases the RRC connection.	-	-	-	-
9	The SS waits 10 seconds (T3411).	-	-	-	-
10	Check: Does the UE transmit an ATTACH REQUEST message? (Attach attempt counter = 3)	-->	ATTACH REQUEST	1	P
11	The SS transmits an ATTACH REJECT message, EMM cause = Congestion (#22)	<--	ATTACH REJECT	-	-
12	The SS releases the RRC connection.	-	-	-	-
13	The SS waits 10 seconds (T3411).	-	-	-	-
14	Check: Does the UE transmit an ATTACH REQUEST message? (Attach attempt counter = 4)	-->	ATTACH REQUEST	-	-
15	The SS transmits an ATTACH REJECT message, EMM cause = Congestion (#22)	<--	ATTACH REJECT	1	-
16	The SS releases the RRC connection.	-	-	-	-
17	The SS waits 10 seconds (T3411).	-	-	-	-
18	The UE transmits an ATTACH REQUEST message. (Attach attempt counter = 5)	-->	ATTACH REQUEST	1	P
19	The SS transmits an ATTACH REJECT message, EMM cause = Congestion (#22)	<--	ATTACH REJECT	-	-
20	The SS releases the RRC connection.	-	-	-	-
21	The SS waits 12 minutes (default value of T3402).	-	-	-	-
22	Check: Does the UE transmit an ATTACH REQUEST message?	-->	ATTACH REQUEST	2	P
23-34	The attach procedure is completed by executing steps 5 to 16 of the UE registration procedure in TS 36.508 sub clause 4.5.2.3.	-	-	-	-
-	At the end of this test procedure sequence, the UE is in end state E-UTRA connected (E2) according to TS 36.508.	-	-	-	-

9.2.1.1.23.3.3 Specific message contents

Table 9.2.1.1.23.3.3-1: Message ATTACH REQUEST (step 2, 6, 10 &14 Table 9.2.1.1.23.2-1)

Derivation path: TS 36.508 table 4.7.2.-4			
Information Element	Value/Remark	Comment	Condition
NAS key set identifier	Any allowed value other than '111'B	"Stored key is available"	
Old GUTI or IMSI	GUTI-1	As stored in USIM	
Last visited registered TAI	TAI-1	Stored TAI.	

Table 9.2.1.1.23.3.3-2: Message ATTACH REJECT (steps 3 & 7 Table 9.2.1.1.23.3.2-1)

Derivation path: 36.508 table 4.7.2.3			
Information Element	Value/Remark	Comment	Condition
Security header type	0000	" Plain NAS message, not security protected "	
EMM cause	00010001	#17 " Network failure "	
ESM message container	Not present		

Table 9.2.1.1.23.3.3-3: Message ATTACH REJECT (steps 11, 15 & 19 Table 9.2.1.1.23.3.2-1)

Derivation path: 36.508 table 4.7.2.3			
Information Element	Value/Remark	Comment	Condition
Security header type	0000	" Plain NAS message, not security protected "	
EMM cause	00010110	#22 "Congestion "	
ESM message container	Not present		

Table 9.2.1.1.23.3.3-4: Message ATTACH REQUEST (step 22, Table 9.2.1.1.23.3.2-1)

Derivation Path: TS 36.508 Table 4.7.2.4			
Information Element	Value/remark	Comment	Condition
NAS key set identifier	111	"No key is available"	
Old GUTI or IMSI	IMSI-1	GUTI has been deleted; only IMSI is available.	
Last visited registered TAI	Not present	TAI has been deleted.	

9.2.1.1.24 Attach / Abnormal case / Change of cell into a new tracking area

9.2.1.1.24.1 Test Purpose (TP)

(1)

```
with { UE has sent an ATTACH Request message }
ensure that {
  when { cell change into a new tracking area occurs before the ATTACH procedure is completed }
  then { the UE aborts the ATTACH procedure and re-initiates it immediately in the new tracking area }
}
```

(2)

```
with { UE has sent an ATTACH REQUEST message and received ATTACH ACCEPT message containing GUTI }
ensure that {
  when { UE reselects a cell belonging to a new tracking area }
  then { the UE restarts the attach procedure }
}
```

9.2.1.1.24.2 Conformance requirements

References: The conformance requirements covered in the current TC are specified in: TS 24.301, clause 5.5.1.2.6 and 5.5.1.3.6.

[TS 24.301, clause 5.5.1.2.6]

The following abnormal cases can be identified:

...

e) Change of cell into a new tracking area

If a cell change into a new tracking area occurs before the attach procedure is completed, the attach procedure shall be aborted and re-initiated immediately. If a tracking area border is crossed when the ATTACH ACCEPT message has been received but before an ATTACH COMPLETE message is sent, the attach procedure shall be re-initiated. If a GUTI was allocated during the attach procedure, this GUTI shall be used in the attach procedure.

[TS 24.301, clause 5.5.1.3.6]

The UE shall proceed as follows:

...

- otherwise, the abnormal cases specified in subclause 5.5.1.2.6 apply with the following modification.

If the attach attempt counter is incremented according to subclause 5.5.1.2.6 the next actions depend on the value of the attach attempt counter:

9.2.1.1.24.3 Test description

9.2.1.1.24.3.1 Pre-test conditions

System Simulator:

- cells A and B:
 - cell A is the serving cell with TAI 1 (PLMN1+TAC1);
 - cell B is the non-suitable cell with TAI 2 (PLMN1+TAC2).
- System information combination 3 as defined in TS 36.508[18] clause 4.4.3.1 is used in E-UTRA cells;

UE:

- the UE is previously registered on E-UTRAN, and when on E-UTRAN, the UE is last authenticated and registered on cell A using default message contents according to TS 36.508 [18].

NOTE: Any type of attach is acceptable.

Preamble:

- the UE is in state Switched OFF (state 1) according to TS 36.508 [18].

9.2.1.1.24.3.2 Test procedure sequence

Table 9.2.1.1.24.3.2-1: Main behaviour

St	Procedure	Message Sequence		TP	Verdict
		U - S	Message		
0A	The SS configures: - Cell B as a "serving cell" - Cell A as a "non-suitable cell".	-	-	-	-
1	The UE is switched on.	-	-	-	-
-	The following messages are to be observed on Cell B unless explicitly stated otherwise.	-	-	-	-
2	The UE transmits an ATTACH REQUEST message in Cell B including a PDN CONNECTIVITY REQUEST message.	-->	ATTACH REQUEST	-	-
3	SS does not send ATTACH ACCEPT to the UE and update TAC value in <i>SystemInformationBlockType1</i> .	-		-	-
3A	The SS transmits a <i>Paging</i> message paging occasion including a <i>systemInfoModification</i> . From the beginning of the next modification period the SS transmits a modified <i>SystemInformationBlockType1</i> as specified.	<--	Paging	-	-
4	Check: Does the UE transmit an ATTACH REQUEST message in Cell B including a PDN CONNECTIVITY REQUEST message in the next 12 seconds? Note: Wait time is more than 2.1* modification period for the UE to receive system information and inferior to T3410.	-->	ATTACH REQUEST	1	P
4A	The SS transmits an AUTHENTICATION REQUEST message to initiate the EPS authentication and AKA procedure.	<--	AUTHENTICATION REQUEST	-	-
5	The UE transmits an AUTHENTICATION RESPONSE message and establishes mutual authentication.	-->	AUTHENTICATION RESPONSE	-	-
6	The SS transmits a NAS SECURITY MODE COMMAND message to activate NAS security.	<--	SECURITY MODE COMMAND	-	-
7	The UE transmits a NAS SECURITY MODE COMPLETE message and establishes the initial security configuration.	-->	SECURITY MODE COMPLETE	-	-
	EXCEPTION: Steps 8a to 8b describe behaviour that depends on UE configuration; the "lower case letter" identifies a step sequence that take place if the UE has ESM information which needs to be transferred.	-	-	-	-
8a	IF the UE sets the ESM information transfer flag in the last PDN CONNECTIVITY REQUEST message THEN the SS transmits an ESM INFORMATION REQUEST message to initiate exchange of protocol configuration options and/or APN.	<--	ESM INFORMATION REQUEST	-	-
8b	The UE transmits an ESM INFORMATION RESPONSE message to transfer protocol configuration options and/or APN.	-->	ESM INFORMATION RESPONSE	-	-
9	The SS configures: - Cell A as a "serving cell"	-	-	-	-
10	SS is configured to not allocate any UL grant or respond to any PRACH preambles for ATTACH COMPLETE in Cell B.	-	-	-	-
11	SS responds with ATTACH ACCEPT message including a valid TAI list. The ACTIVATE DEFAULT EPS BEARER CONTEXT REQUEST message is piggybacked in ATTACH ACCEPT message. GUTI-1 is allocated.	<--	ATTACH ACCEPT	-	-
12	The SS configures:	-	-	-	-

	- Cell B as a "non-suitable cell".				
13	UE transmits <i>RRCConnectionReestablishmentRequest</i> message in Cell A	-	-	-	-
14	SS Sends <i>RRCConnectionReestablishment</i>	-	-	-	-
15	The UE transmits a <i>RRCConnectionReestablishmentComplete</i> message	-	-	-	-
-	The following messages are to be observed on Cell A unless explicitly stated otherwise.	-	-	-	-
16	Check: Does the UE transmit an ATTACH REQUEST message, containing GUTI 1?	-->	ATTACH REQUEST	2	P
17	SS responds with ATTACH ACCEPT message including a valid TAI list. The ACTIVATE DEFAULT EPS BEARER CONTEXT REQUEST message is piggybacked in ATTACH ACCEPT message	<--	ATTACH ACCEPT	-	-
-	EXCEPTION: In parallel to the event described in step 13 below the generic procedure for IP address allocation in the U-plane specified in TS 36.508 subclause 4.5A.1 takes place performing IP address allocation in the U-plane if requested by the UE.	-	-	-	-
18	The UE transmits an ATTACH COMPLETE message including an ACTIVATE DEFAULT EPS BEARER CONTEXT ACCEPT message.	-->	ATTACH COMPLETE	-	-
19	The SS releases the RRC connection.	-	-	-	-
NOTE 1: UE already has NAS security context in step 17 and just sending a DL message with Integrity and Ciphering will start enable NAS security.					

9.2.1.1.24.3.3 Specific message contents

Table 9.2.1.1.24.3.3-1: Message ATTACH ACCEPT (step 11, Table 9.2.1.1.24.3.2-1)

Derivation path: TS 36.508 table 4.7.2-1			
Information Element	Value/Remark	Comment	Condition
TAI list			
Length of tracking area identity list contents	'0000 0110'B		
Partial tracking area identity list 1			
Number of elements	'0 0000'B		
Type of list	'00'B		
MCC	MCC of cell B		
MNC	MNC of cell B		
TAC 1	TAC-4		
GUTI	GUTI-1		

Table 9.2.1.1.24.3.3-2: SystemInformationBlockType1 for Cell B (From step 3 in Table 9.2.1.1.24.3.2-1)

Derivation Path: 36.508 clause 4.4.3.2-3			
Information Element	Value/remark	Comment	Condition
SystemInformationBlockType1 ::= SEQUENCE {			
cellAccessRelatedInfo SEQUENCE {			
trackingAreaCode	TAC =4		
}			
}			
}			

Table 9.2.1.1.24.3.3-3: Paging (step 3A, Table 9.2.1.1.24.3.2-1)

Derivation Path: 36.508 Table 4.6.1-7			
Information Element	Value/remark	Comment	Condition
Paging ::= SEQUENCE {			
pagingRecordList	Not present		
systemInfoModification	true		
}			

Table 9.2.1.1.24.3.3-4: Message ATTACH REQUEST (step 16, Table 9.2.1.1.24.3.2-1)

Derivation path: TS 36.508 table 4.7.2-4			
Information Element	Value/Remark	Comment	Condition
Last visited registered TAI	TAI of cell B with TAC-4		

9.2.1.1.25 Attach / Abnormal case / Mobile originated detach required

9.2.1.1.25.1 Test Purpose (TP)

(1)

```
with { UE in EMM-REGISTERED-INITIATED state }
ensure that {
  when { the UE initiates mobile originated detach }
  then { the UE aborts the attach procedure }
}
```

9.2.1.1.25.2 Conformance requirements

References: The conformance requirements covered in the current TC are specified in: TS 24.301, clause 5.5.1.2.6 and 5.5.1.3.6

[TS 24.301, clause 5.5.1.2.6]

The following abnormal cases can be identified:

f) Mobile originated detach required

The attach procedure shall be aborted, and the UE initiated detach procedure shall be performed.

[TS 24.301, clause 5.5.1.3.6]

The UE shall proceed as follows:

...

- otherwise, the abnormal cases specified in subclause 5.5.1.2.6 apply with the following modification.

If the attach attempt counter is incremented according to subclause 5.5.1.2.6 the next actions depend on the value of the attach attempt counter:

9.2.1.1.25.3 Test description

9.2.1.1.25.3.1 Pre-test conditions

System Simulator:

- cell A.

UE:

None.

Preamble:

- the UE is in state Switched OFF (state 1) according to TS 36.508 [18].

9.2.1.1.25.3.2 Test procedure sequence

Table 9.2.1.1.25.3.2-1: Main behaviour

St	Procedure	Message Sequence		TP	Verdict
		U - S	Message		
1	The UE is switched on.	-	-	-	-
2	The UE transmits an ATTACH REQUEST message. (NOTE 2)	-->	ATTACH REQUEST	-	-
3	The SS transmits an AUTHENTICATION REQUEST message to initiate the EPS authentication and AKA procedure.	<--	AUTHENTICATION REQUEST	-	-
4	The UE transmits an AUTHENTICATION RESPONSE message and establishes mutual authentication.	-->	AUTHENTICATION RESPONSE	-	-
5	The SS transmits a NAS SECURITY MODE COMMAND message to activate NAS security.	<--	SECURITY MODE COMMAND	-	-
6	The UE transmits a NAS SECURITY MODE COMPLETE message and establishes the initial security configuration.	-->	SECURITY MODE COMPLETE	-	-
7	The SS does not respond to ATTACH REQUEST message.	-	-	-	-
7A	Cause UE to initiate detach before the T3410 times out. (NOTE 1)	-	-	-	-
8	Check: Does the UE initiate mobile originated detach and abort the attach procedure while T3410 is running?	-->	DETACH REQUEST	1	P
9	The SS transmits DETACH ACCEPT message.	<--	DETACH ACCEPT	-	-
9A	The SS releases the RRC connection.	-	-	-	-
10	Check: Does the test result of CALL generic procedure "Test procedure for no response to paging (for NAS testing)" clause 6.4.2.5 [18] indicates that the UE responds to paging when paged with S-TMSI included in GUTI-1 and with CN domain indicator set to "PS"?	-	-	1	-
11	Void	-	-	-	-

NOTE 1: T3410 value is specified as 15s in TS 24.301.
NOTE 2: Any type of attach is acceptable.

9.2.1.1.25.3.3 Specific message contents

Table 9.2.1.1.25.3.3-1: Message DETACH REQUEST (step 8, Table 9.2.1.1.25.3.2-1)

Derivation path: 36.508 table 4.7.2-11			
Information Element	Value/Remark	Comment	Condition
Detach type			
Type of detach	001 or 011	EPS detach or combined EPS/IMSI detach	
Switch off	0	Normal detach	

9.2.1.1.26 Attach / Abnormal case / Detach procedure collision

9.2.1.1.26.1 Test Purpose (TP)

(1)

```

with { UE in EMM-REGISTERED-INITIATED state }
ensure that {
  when { UE receives a DETACH REQUEST message and detach type indicates "re-attach not required" }
  then { the UE sends DETACH ACCEPT }
}

```

(2)

```
with { UE in EMM-REGISTERED-INITIATED state }
ensure that {
  when { UE receives a DETACH REQUEST message and detach type indicates "re-attach required" }
  then { the UE continues with ATTACH procedure }
}
```

9.2.1.1.26.2 Conformance requirements

References: The conformance requirements covered in the current TC are specified in: TS 24.301, clause 5.5.1.2.6, 5.5.1.3.6.

[TS 24.301, clause 5.5.1.2.6]

The following abnormal cases can be identified:

...

g) Detach procedure collision

If the UE receives a DETACH REQUEST message from the network in state EMM-REGISTERED-INITIATED and the detach type indicates "re-attach not required", the detach procedure shall be progressed and the attach procedure shall be aborted. Otherwise the attach procedure shall be progressed and the DETACH REQUEST message shall be ignored.

[TS 24.301, clause 5.5.1.3.6]

The UE shall proceed as follows:

...

- otherwise, the abnormal cases specified in subclause 5.5.1.2.6 apply with the following modification.

If the attach attempt counter is incremented according to subclause 5.5.1.2.6 the next actions depend on the value of the attach attempt counter:

9.2.1.1.26.3 Test description

9.2.1.1.26.3.1 Pre-test conditions

System Simulator:

- cell A.

UE:

None.

Preamble:

- the UE is in state Switched OFF (state 1) according to TS 36.508 [18].

9.2.1.1.26.3.2 Test procedure sequence

Table 9.2.1.1.26.3.2-1: Main behaviour

St	Procedure	Message Sequence		TP	Verdict
		U - S	Message		
1	The UE is switched on.	-	-	-	-
2	The UE transmits an ATTACH REQUEST message including a PDN CONNECTIVITY REQUEST message. (NOTE 2)	-->	ATTACH REQUEST	-	-
3	The SS initiates Detach procedure with the Detach Type IE "re-attach not required"	<--	DETACH REQUEST	-	-
4	Check: Does the UE send DETACH ACCEPT message?	-->	DETACH ACCEPT	1	P
5	The SS releases the RRC connection.	-	-	-	-
5A	The SS waits 5 seconds (NOTE 1)	-	-	-	-
6	If possible (see ICS) switch off is performed or the USIM is removed. Otherwise the power is removed.	-	-	-	-
6A	The UE is brought back to operation or the USIM is inserted.	-	-	-	-
7	The UE transmit an ATTACH REQUEST message including a PDN CONNECTIVITY REQUEST message . (NOTE 2)	-->	ATTACH REQUEST	-	-
8	The SS transmits an AUTHENTICATION REQUEST message to initiate the EPS authentication and AKA procedure	<--	AUTHENTICATION REQUEST	-	-
9	The UE transmits an AUTHENTICATION RESPONSE message and establishes mutual authentication.	-->	AUTHENTICATION RESPONSE	-	-
10	The SS transmits a NAS SECURITY MODE COMMAND message to activate NAS security.	<--	SECURITY MODE COMMAND	-	-
11	The UE transmits a NAS SECURITY MODE COMPLETE message and establishes the initial security configuration.	-->	SECURITY MODE COMPLETE	-	-
-	EXCEPTION: Steps 12a1 to 12a2 describe behaviour that depends on UE configuration; the "lower case letter" identifies a step sequence that take place if the UE has ESM information which needs to be transferred.	-	-	-	-
12a1	IF the UE sets the ESM information transfer flag in the last PDN CONNECTIVITY REQUEST message THEN the SS transmits an ESM INFORMATION REQUEST message to initiate exchange of protocol configuration options and/or APN.	<--	ESM INFORMATION REQUEST	-	-
12a2	The UE transmits an ESM INFORMATION RESPONSE message to transfer protocol configuration options and/or APN.	-->	ESM INFORMATION RESPONSE	-	-
13	The SS initiates Detach procedure with the Detach Type IE "re-attach required"	<--	DETACH REQUEST	-	-
-	EXCEPTION: In parallel with steps 14 to 16, the parallel behaviour defined in table 9.2.1.1.26.3.2-2 is running.	-	-	-	-
14	SS responds with ATTACH ACCEPT message including a valid TAI list. The ACTIVATE DEFAULT EPS BEARER CONTEXT REQUEST message is piggybacked in ATTACH ACCEPT message. GUTI-1 is allocated.	<--	ATTACH ACCEPT	-	-
-	EXCEPTION: In parallel to the event described in steps 15 to 16 below the generic procedure for IP address allocation in the U-plane specified in TS 36.508 subclause 4.5A.1 takes place performing IP address allocation in the U-plane if requested by the UE.	-	-	-	-
15	The UE transmits an ATTACH COMPLETE	-->	ATTACH COMPLETE	2	P

	message including an ACTIVATE DEFAULT EPS BEARER CONTEXT ACCEPT message?				
16	The SS waits 5 seconds (NOTE 1)	-	-	-	-
17	The SS releases the RRC connection.	-	-	-	-
NOTE 1: The time delay is added to additionally guarantee UE has respected the content of the DETACH REQUEST message.					
NOTE 2: Any type of attach is acceptable.					

Table 9.2.1.1.26.3.2-2: Parallel behaviour

St	Procedure	Message Sequence		TP	Verdict
		U - S	Message		
1	Check: Does the UE send DETACH ACCEPT message?	-->	DETACH ACCEPT	2	F

9.2.1.1.26.3.3 Specific message contents

Table 9.2.1.1.26.3.3-1: Message DETACH REQUEST (step 3, Table 9.2.1.1.26.3.2-1)

Derivation path: 36.508 table 4.7.2-12			
Information Element	Value/Remark	Comment	Condition
Detach type	'010'B	"re-attach not required"	
EMM cause	'07'H	EPS services not allowed	

Table 9.2.1.1.26.3.3-2: Message DETACH REQUEST (step 13, Table 9.2.1.1.26.3.2-1)

Derivation path: 36.508 table 4.7.2-12			
Information Element	Value/Remark	Comment	Condition
Detach type	'001'B	"re-attach required"	
EMM cause	NOT PRESENT		

9.2.1.1.27 Attach / Abnormal case / Network reject with Extended Wait Timer

9.2.1.1.27.1 Test Purpose (TP)

(1)

```
with { UE configured for low access priority, has sent an ATTACH REQUEST message with NAS low
priority signalling indication }
ensure that {
  when { UE receives "Extended Wait Time" in the RRCConnectionRelease message }
  then { UE starts timer T3346 and abort the attach procedure }
}
```

(2)

```
with { UE having aborted attach procedure and with timer T3346 running }
ensure that {
  when { Timer T3346 expires }
  then { UE restarts attach procedure }
}
```

9.2.1.1.27.2 Conformance requirements

References: The conformance requirements covered in the current TC are specified in: TS 24.301, clause 5.5.1.2.6

[TS 24.301, clause 5.5.1.2.6]

The following abnormal cases can be identified:

...

l) "Extended wait time" from the lower layers

If the ATTACH REQUEST message contained the NAS signalling low priority indicator set to "MS is configured for NAS signalling low priority", the UE shall start timer T3346 with the "Extended wait time" value.

In other cases the UE shall ignore the "Extended wait time".

The UE shall abort the attach procedure, reset the attach attempt counter, stay in the current serving cell, change the state to EMM-DEREGISTERED.ATTEMPTING-TO-ATTACH and apply the normal cell reselection process.

The UE shall proceed as described below.

m) Timer T3346 is running

The UE shall not start the attach procedure unless the UE is accessing the network with access class 11 – 15 or needs to attach for emergency bearer services. The UE stays in the current serving cell and applies the normal cell reselection process.

NOTE: It is considered an abnormal case if the UE needs to initiate an attach procedure while timer T3346 is running independent on whether timer T3346 was started due to an abnormal case or a non successful case.

The UE shall proceed as described below.

For the cases b, c, and d the UE shall proceed as follows:

- Timer T3410 shall be stopped if still running. The attach attempt counter shall be incremented, unless it was already set to 5.

If the attach attempt counter is less than 5:

- for the cases l and m, the attach procedure is started, if still necessary, when timer T3346 expires or is stopped;
- for all other cases, timer T3411 is started and the state is changed to EMM-DEREGISTERED.ATTEMPTING-TO-ATTACH. When timer T3411 expires the attach procedure shall be restarted, if still required by ESM sublayer.

9.2.1.1.27.3 Test description

9.2.1.1.27.3.1 Pre-test conditions

System Simulator:

- cell A.

UE:

- the UE is configured to initiate EPS attach
- the UE is previously registered on E-UTRAN, and when on E-UTRAN, the UE is last authenticated and registered on cell A using default message contents according to TS 36.508 [18].
- the UE is configured for NAS signalling low priority

Preamble:

- the UE is in state Switched OFF (state 1) according to TS 36.508 [18].

9.2.1.1.27.3.2 Test procedure sequence

Table 9.2.1.1.27.3.2-1: Main behaviour

St	Procedure	Message Sequence		TP	Verdict
		U – S	Message		
1	The UE is switched on.	-	-	-	-
2	The UE transmits an ATTACH REQUEST message. (Device properties IE included)	-->	ATTACH REQUEST	-	-
3	The SS releases the RRC connection.	-	The SS includes the IE "Extended Wait Time" in the <i>RRCConnectionRelease</i> message. UE starts timer T3346 with the value 5 seconds	-	-
4	The SS waits 5 seconds (T3346).	-	-	-	-
5	Check: Does the UE transmit an ATTACH REQUEST message?	-->	ATTACH REQUEST	1,2	P
6-17	The attach procedure is completed by executing steps 5 to 16 of the UE registration procedure in TS 36.508 sub clause 4.5.2.3.	-	-	-	-
-	At the end of this test procedure sequence, the UE is in end state E-UTRA connected (E2) according to TS 36.508.	-	-	-	-

9.2.1.1.27.3.3 Specific message contents

Table 9.2.1.1.27.3.3-1: Message ATTACH REQUEST (step 2 and 6 Table 9.2.1.1.27.2-1)

Derivation path: TS 36.508 table 4.7.2.-4			
Information Element	Value/Remark	Comment	Condition
NAS key set identifier	Any allowed value other than '111'B	"Stored key is available"	
Old GUTI or IMSI	GUTI-1	As stored in USIM	
Last visited registered TAI	TAI-1	Stored TAI.	
Device properties	1	"MS is configured for NAS signalling low priority"	

Table 9.2.1.1.27.3.3-2: RRCConnectionRelease (step 3 Table 9.2.1.1.27.2-1)

Derivation Path: 36.508 Table 4.6.1-15			
Information Element	Value/remark	Comment	Condition
RRCConnectionRelease ::= SEQUENCE {			
criticalExtensions CHOICE {			
c1 CHOICE {			
rrcConnectionRelease-r8 SEQUENCE {			
nonCriticalExtension SEQUENCE {		RRCConnectionRelease-v890-IEs	
lateNonCriticalExtension	Not Present		
nonCriticalExtension SEQUENCE {		RRCConnectionRelease-v920-IEs	
cellInfoList-r9	Not Present		
nonCriticalExtension SEQUENCE {		RRCConnectionRelease-v1020-IEs	
extendedWaitTime-r10	5 seconds		
nonCriticalExtension	Not Present		
}			
}			
}			
}			
}			
}			
}			

9.2.1.1.28 Attach / Success / IMS

9.2.1.1.28.1 Test Purpose (TP)

(1)

```
with { the UE is switched-off and supports IMS}
ensure that {
  when { UE is powered on }
  then { the UE transmits an ATTACH REQUEST message and a PDN CONNECTIVITY REQUEST message with
request for SIP signalling }
}
```

(2)

```
with { the UE is switched-off and supports method II for P-CSCF discovery}
ensure that {
  when { UE is powered on }
  then { the UE transmits an ATTACH REQUEST message and a PDN CONNECTIVITY REQUEST message with
method II for P-CSCF discovery }
}
```

(3)

```
with { the UE supports conversational speech }
ensure that {
  when { UE is available for calls }
  then { the UE performs an initial IMS registration }
}
```

9.2.1.1.28.2 Conformance requirements

References: The conformance requirements covered in the current TC are specified in: TS 24.229, clauses L.2.2.1 and L.3.1.2. Unless otherwise stated these are Rel-8 requirements.

[TS 24.229, clause L.2.2.1 “EPS bearer context activation and P-CSCF discovery”]

Prior to communication with the IM CN subsystem, the UE shall:

- a) if not attached for EPS services yet, perform an EPS attach procedure as specified in 3GPP TS 24.301 [8J];
- b) ensure that an EPS bearer context used for SIP signalling according to the APN and P-GW selection criteria described in 3GPP TS 23.401 [7B], is available. This EPS bearer context shall remain active throughout the period the UE is connected to the IM CN subsystem, i.e. from the initial registration and at least until the deregistration. As a result, the EPS bearer context provides the UE with information that makes the UE able to construct an IPv4 or an IPv6 address;

NOTE 3: The default EPS bearer context can also be used for SIP signalling as well as any other EPS bearer context.

When the EPS bearer context establishment procedure for the SIP signalling is initiated by the UE:

- I. if a default EPS bearer context is not available with the selected P-GW, the UE shall indicate to the network in the PDN CONNECTIVITY REQUEST that the request is for SIP signalling. If the request is authorized, the network establishes a bearer with the appropriate QCI as described in 3GPP TS 24.301 [8J]. The UE may also use this EPS bearer context for DNS and DHCP signalling;
- II. if the default EPS bearer context is available with the selected P-GW, and is to be used for SIP signalling no additional steps are needed;
- III. if the default EPS bearer context is available with the selected P-GW and an EPS bearer for SIP signalling with the correct QCI and TFT is to be established, the UE shall indicate to the network, by setting the IM CN Subsystem Signalling Flag in the Protocol Configuration Options information element in the BEARER RESOURCE ALLOCATION REQUEST message, that the request is for SIP signalling. If the request is authorized, the network either establishes a new dedicated bearer or modifies an existing bearer with the appropriate QCI and TFT as described in 3GPP TS 24.301 [8J]. The general QoS negotiation mechanism is described in 3GPP TS 24.301 [8J].

NOTE 2: An EPS bearer with a QCI value other than the one for signalling can carry both IM CN subsystem signalling and media, in case the media does not need to be authorized by Policy and Charging control mechanisms as defined in 3GPP TS 29.212 [13B] and the media stream is not mandated by the P-CSCF to be carried in a separate EPS bearer.

c) acquire a P-CSCF address(es).

The methods for P-CSCF discovery are:

I. When using IPv4, employ the Dynamic Host Configuration Protocol (DHCP) RFC 2132 [20F], the DHCPv4 options for SIP servers RFC 3361 [35A], and RFC 3263 [27A] as described in subclause 9.2.1. When using IPv6, employ Dynamic Host Configuration Protocol for IPv6 (DHCPv6) RFC 3315 [40], the DHCPv6 options for SIP servers RFC 3319 [41] and DHCPv6 options for Domain Name Servers (DNS) RFC 3646 [56C] as described in subclause 9.2.1.

II. Transfer P-CSCF address(es) within the EPS bearer context activation procedure.

The UE shall indicate the request for a P-CSCF address to the network within the Protocol Configuration Options information element of the PDN CONNECTIVITY REQUEST message or BEARER RESOURCE ALLOCATION REQUEST message.

If the network provides the UE with a list of P-CSCF IPv4 or IPv6 addresses in the ACTIVATE DEFAULT EPS BEARER CONTEXT REQUEST message or ACTIVATE DEDICATED EPS BEARER CONTEXT REQUEST message, the UE shall assume that the list is prioritised with the first address within the Protocol Configuration Options information element as the P-CSCF address with the highest priority.

III. The UE selects a P-CSCF from the list (see 3GPP TS 31.103 [15B]) stored in the ISIM.

IV. The UE selects a P-CSCF from the list in IMS management object.

[TS 24.229, clause L.3.1.2 "Availability for calls"]

A UE shall perform an initial registration as specified in subclause 5.1.1.2, if all the following conditions are met:

- 1) if the UE is operating in one of the following modes of operation (see 3GPP TS 24.301 [8J]):
 - a) PS mode 1;
 - b) CS/PS mode 1 and the UE is attached for EPS-Services only;
- 2) if the UE is capable of receiving any (but not necessarily all) of the media types which the CS domain supports, such that the media type can also be used when accessing the IM CN subsystem using the current IP-CAN;
- 3) if the media type of item 2 is an "audio" media type, and the UE supports codecs suitable for (conversational) speech;
- 4) if the UE determines that its contact has not been bound to a public user identity using the IP-CAN, such that the contact is expected to be used for the delivery of incoming requests in the IM CN subsystem relating to the media of item 2 and item 3;
- 5) if the IMSVoPS indicator, provided by the lower layers (see 3GPP TS 24.301 [8J]), indicates voice is supported; and
- 6) if the procedures to perform the initial registration are enabled (see 3GPP TS 24.305 [8T]).

NOTE: Regardless of any of the above conditions, a UE might attempt to register with the IM CN subsystem at any time.

9.2.1.1.28.3 Test description

9.2.1.1.28.3.1 Pre-test conditions

System Simulator:

- cell A.

UE:

- The UE is previously registered on E-UTRAN, and when on E-UTRAN, the UE is last authenticated and registered on cell A using default message contents according to TS 36.508 [18].

Preamble:

- the UE is in state Switched OFF (state 1) according to TS 36.508 [18].

9.2.1.1.28.3.2 Test procedure sequence

Table 9.2.1.1.28.3.2-1: Main behaviour

St	Procedure	Message Sequence		TP	Verdict
		U - S	Message		
1	The UE is switched on.	-	-	-	-
2-4	Steps 1 to 3 of the generic test procedure for UE registration (TS 36.508 4.5.2.3-1).	-	-	-	-
5	The UE transmits an <i>RRCConnectionSetupComplete</i> message to confirm the successful completion of the connection establishment and to initiate the Attach procedure by including the ATTACH REQUEST message. The PDN CONNECTIVITY REQUEST message is piggybacked in ATTACH REQUEST	-->	RRC: <i>RRCConnectionSetupComplete</i> NAS: ATTACH REQUEST NAS: PDN CONNECTIVITY REQUEST	1,2	P
6-16	Steps 5 to 15 of the generic test procedure for UE registration (TS 36.508 4.5.2.3-1).	-	-	-	-
-	EXCEPTION: In parallel to the event described in step 17 below, if initiated by the UE the generic procedure for IP address allocation in the U-plane specified in TS 36.508 subclause 4.5A.1 takes place performing IP address allocation in the U-plane.	-	-	-	-
-	EXCEPTION: In parallel to the event described in step 16 below the generic procedure for IMS signalling in the U-plane specified in table 9.2.1.1.28.3.2-2 takes place.	-	-	-	-
17	This message includes the ATTACH COMPLETE message. The ACTIVATE DEFAULT EPS BEARER CONTEXT ACCEPT message is piggybacked in ATTACH COMPLETE.	-->	ATTACH COMPLETE ACTIVATE DEFAULT EPS BEARER CONTEXT ACCEPT	-	-

Table 9.2.1.1.28.3.2-2: Procedure for IMS signalling in the U-plane

St	Procedure	Message Sequence		TP	Verdict
		U - S	Message		
1-9	Registration procedure according TS 34.229-1 [43] subclause C.2 (steps 3-11)	-	-	3	P

9.2.1.1.28.3.3 Specific message contents

Table 9.2.1.1.28.3.3-1: Message PDN CONNECTIVITY REQUEST (step 2, table 9.2.1.1.28.3.2-1)

Derivation Path: TS 36.508 Table 4.7.3-20			
Information Element	Value/remark	Comment	Condition
Protocol configuration options			
Container ID n	'0002'H (IM CN Subsystem Signalling Flag)		
Container ID n	'0001'H (P-CSCF IPv6)	At least one value shall be present.	
Container ID n	'000C'H (P-CSCF IPv4)		

9.2.1.2 Combined attach procedure for EPS services and non-EPS services

9.2.1.2.1 Combined attach procedure / Success / EPS and non-EPS services

9.2.1.2.1.1 Test Purpose (TP)

(1)

```
with { UE in state EMM-DEREGISTERED and is switched off }
ensure that {
  when { UE is powered up or switched on}
  then { UE sends ATTACH REQUEST message with EPS attach type IE 'combined EPS/IMSI attach' }
}
```

(2)

```
with { UE in state EMM-REGISTERED-INITIATED}
ensure that {
  when { UE receives ATTACH ACCEPT message with EPS attach result 'combined EPS/IMSI attach' }
  then { UE sends ATTACH COMPLETE message and enters EMM state EMM-REGISTERED and MM state MM-IDLE }
}
```

(3)

```
with { UE in state EMM-REGISTERED and EMM-IDLE mode}
ensure that {
  when { UE enters a new tracking area already included in the TAI list }
  then { UE does not send TRACKING AREA UPDATE REQUEST message }
}
```

(4)

```
with { UE in state EMM-REGISTERED and EMM-IDLE mode}
ensure that {
  when { UE enters a new tracking area not included in the TAI list }
  then { UE sends TRACKING AREA UPDATE REQUEST message with 'EPS update type = combined TA/LA updated ' }
}
```

(5)

```
with { UE in state EMM-DEREGISTERED and is switched off and has a valid TAI value in 'Last visited registered TAI' IE and a valid GUTI}
ensure that {
  when { UE is powered up or switched on}
  then { UE sends ATTACH REQUEST message with EPS attach type IE 'combined EPS/IMSI attach' and with the value in 'Last visited registered TAI' and the valid GUTI}
}
```

9.2.1.2.1.2 Conformance requirements

References: The conformance requirements covered in the present TC are specified in: 3GPP TS 24.301 clauses 5.5.1.3.1, 5.5.1.3.4.1 and 5.5.1.3.4.2.

[TS24.301 clause5.5.1.3.1]

The combined EPS attach procedure is used by a UE in CS/PS mode 1 or CS/PS mode 2 of operation to attach for both EPS and non-EPS services.

The combined EPS attach procedure is also used by a UE in CS/PS mode 1 or CS/PS mode 2 of operation to attach for EPS services if it is already attached for non-EPS services.

When the UE initiates a combined EPS attach procedure, the UE shall indicate "combined EPS/IMSI attach" in the EPS attach type IE.

The combined EPS attach procedure follows the attach procedure for EPS described in subclause 5.5.1.2.

[TS24.301 clause5.5.1.3.2]

If the UE is in EMM state EMM-DEREGISTERED, the UE initiates the combined attach procedure by sending an ATTACH REQUEST message to the network, starting timer T3410 and entering state EMM-REGISTERED-INITIATED (see example in figure 5.5.1.2.2.1).

The UE shall include the TMSI status IE if no valid TMSI is available. Furthermore, if the UE has stored a valid location area identification, the UE shall include it in the Old location area identification IE in the ATTACH REQUEST message.

[TS24.301 clause 5.5.1.3.4.1]

Depending on the value of the EPS attach result IE received in the ATTACH ACCEPT message, two different cases can be distinguished:

- 1) The EPS attach result IE value indicates "combined EPS/IMSI attach": attach for EPS and non-EPS services have been successful.

...

[TS24.301 clause 5.5.1.3.4.2]

The description for attach for EPS services as specified in subclause 5.5.1.2.4 shall be followed. In addition, the following description for attach for non-EPS services applies.

The TMSI reallocation may be part of the combined attach procedure. The TMSI allocated is then included in the ATTACH ACCEPT message, together with the location area identification (LAI). In this case the MME shall start timer T3450 and enter state EMM-COMMON-PROCEDURE-INITIATED as described in subclause 5.4.1.

The UE, receiving an ATTACH ACCEPT message, stores the received location area identification, stops timer T3410, resets the location update attempt counter and sets the update status to U1 UPDATED. If the message contains an IMSI, the UE is not allocated any TMSI, and shall delete any TMSI accordingly. If the message contains a TMSI, the UE shall use this TMSI as the new temporary identity. The UE shall delete its old TMSI and shall store the new TMSI. If neither a TMSI nor an IMSI has been included by the network in the ATTACH ACCEPT message, the old TMSI, if any available, shall be kept. The UE, when receiving the ATTACH ACCEPT message combined with the ACTIVATE DEFAULT EPS BEARER CONTEXT REQUEST message, shall send an ATTACH COMPLETE message combined with an ACTIVATE DEFAULT EPS BEARER CONTEXT ACCEPT message to the network after which it shall enter state EMM-REGISTERED and MM state MM-IDLE and set the EPS update status to EU1 UPDATED.

9.2.1.2.1.3 Test description

9.2.1.2.1.3.1 Pre-test conditions

System Simulator:

- cell A, cell B and cell C are configured according to Table 6.3.2.2-1 in [18]:
 - cell A belongs to TAI-1 (home PLMN);
 - cell B belongs to TAI-2 (home PLMN, another TAC);
 - cell C belongs to TAI-3 (home PLMN, another TAC).
- The different cells may not be simultaneously activated (at most 2 cells are active simultaneously).
- System information combination 3 as defined in TS 36.508[18] clause 4.4.3.1 is used in E-UTRA cells;

UE:

- the UE is configured to initiate combined EPS/IMSI attach;
- the UE is previously registered on E-UTRAN, and when on E-UTRAN, the UE is last authenticated and registered on cell A using default message contents according to TS 36.508 [18].

Preamble:

- the UE is in state Switched OFF (state 1) according to TS 36.508 [18].

9.2.1.2.1.3.2 Test procedure sequence

Table 9.2.1.2.1.3.2-1: Main Behaviour

St	Procedure	Message Sequence		TP	Verdict
		U - S	Message		
1	The SS configures: - Cell A as the "Serving cell". - Cell B as a "Non-Suitable cell". - Cell C as a "Non-Suitable Off cell". cell	-	-	-	-
-	The following messages are to be observed on Cell A unless explicitly stated otherwise.	-	-	-	-
2	The UE is powered up or switched on.			-	-
3	Check: Does the UE send an ATTACH REQUEST message with a PDN CONNECTIVITY REQUEST message to request PDN connectivity to the default PDN. EPS attach type = "combined EPS/IMSI attach"?	-->	ATTACH REQUEST	1	P
4	The SS starts an authentication procedure	<--	AUTHENTICATION REQUEST	-	-
5	The UE responds properly to the authentication procedure	-->	AUTHENTICATION RESPONSE	-	-
6	The SS starts a NAS security mode command procedure to perform NAS integrity protection.	<--	SECURITY MODE COMMAND	-	-
7	The UE responds properly to the NAS security mode command procedure	-->	SECURITY MODE COMPLETE	-	-
-	EXCEPTION: Steps 7Aa1 to 7Aa2 describe behaviour that depends on UE configuration; the "lower case letter" identifies a step sequence that take place if the UE has ESM information which needs to be transferred.	-	-	-	-
7A a1	IF the UE sets the ESM information transfer flag in the last PDN CONNECTIVITY REQUEST message THEN the SS transmits an ESM INFORMATION REQUEST message to initiate exchange of protocol configuration options and/or APN.	<--	ESM INFORMATION REQUEST	-	-
7A a2	The UE transmits an ESM INFORMATION RESPONSE message to transfer protocol configuration options and/or APN.	-->	ESM INFORMATION RESPONSE	-	-
8	The SS sends ATTACH ACCEPT message with the ACTIVATE DEFAULT EPS BEARER CONTEXT REQUEST message.	<--	ATTACH ACCEPT	-	-
9	Check: Does the UE send ATTACH COMPLETE message with the ACTIVATE DEFAULT EPS BEARER CONTEXT ACCEPT message?	-->	ATTACH COMPLETE	2	P
10	The SS releases the RRC connection.			-	-
11	Void				
12	Void				
12 Aa 1	Void				
13	Void				
14	Void				
14 A	Void				
14 B	Void				
15	Void				
16	The SS configures: - Cell A as a "Non-Suitable cell". - Cell B as the "Serving cell". - Cell C as a "Non-Suitable Off cell".	-	-	-	-
-	The following messages are to be observed on	-	-	-	-

	Cell B unless explicitly stated otherwise.				
17	Check: Does the UE transmit a TRACKING AREA UPDATE REQUEST message in the next 30 seconds?	-	-	3	F
18	Void				
19	Void				
19 Aa 1	Void				
19 B	Void				
19 C	Void				
19 D	Void				
19 E	Void				
20	The SS configures: - Cell A as a "Non-Suitable Off cell". - Cell B as a "Non-Suitable cell". - Cell C as the "Serving cell".	-	-	-	-
-	The following messages are to be observed on Cell C unless explicitly stated otherwise.	-	-	-	-
21	Check: Does the UE transmit a TRACKING AREA UPDATE REQUEST message?	-->	TRACKING AREA UPDATE REQUEST	4	P
22	The SS transmits a TRACKING AREA UPDATE ACCEPT message.	<--	TRACKING AREA UPDATE ACCEPT	-	-
23	The UE transmits a TRACKING AREA UPDATE COMPLETE message?	-->	TRACKING AREA UPDATE COMPLETE	-	-
24	The SS releases the RRC connection.	-	-	-	-
25	If possible (see ICS) switch off is performed or the USIM is removed. Otherwise the power is removed.	-	-	-	-
-	EXCEPTION: Step 26 describes behaviour that depends on the UE capability.				
26	If pc_SwitchOnOff or pc_USIM_Removal then the UE transmit a DETACH REQUEST.	-->	DETACH REQUEST	-	-
27	The UE is brought back to operation or the USIM is inserted.	-	-	-	-
28	Check: Does the UE send ATTACH REQUEST message with a PDN CONNECTIVITY REQUEST message to request PDN connectivity to the default PDN.	-->	ATTACH REQUEST	5	P
29- 30	The attach procedure is completed by executing steps 5 to 16 of the UE registration procedure in TS 36.508 sub clause 4.5.2.3. NOTE: For the content of the ATTACH ACCEPT message to be used in the UE registration procedure in TS 36.508 clause 4.5.2.3 see Table 9.2.1.2.1.3.3-8 below	-	-	-	-
-	At the end of this test procedure sequence, the UE is in end state E-UTRA connected (E2) according to TS 36.508.	-	-	-	-

9.2.1.2.1.3.3 Specific message contents

Table 9.2.1.2.1.3.3-1: Message ATTACH REQUEST (step 3, Table 9.2.1.2.1.3.2-1)

Derivation path: 36.508 table 4.7.2-4			
Information Element	Value/Remark	Comment	Condition
EPS attach type	'0010'B	"combined EPS/IMSI attach"	
Old GUTI or IMSI	GUTI-1		
Last visited registered TAI	TAI-1		
Old location area identification	LAI-1		
TMSI status	Not Present		

Table 9.2.1.2.1.3.3-2: Message ATTACH ACCEPT (step 8, Table 9.2.1.2.1.3.2-1)

Derivation path: 36.508 table 4.7.2-1			
Information Element	Value/Remark	Comment	Condition
EPS attach result	'010'B	"Combined EPS/IMSI attach"	
TAI list			
Number of elements	'00001'B		
Type of list	'00'B	"list of TACs belonging to one PLMN, with non-consecutive TAC values"	
MCC MNC TAC 1 TAC 2	PLMN= MCC/MNC TAC 1=1 TAC 2=2	"PLMN is set to the same MCC/MNC stored in EF _{IMSI} " "TAI-1" "TAI-2"	
GUTI	GUTI-2		
LAI	LAI-1		
MS identity	TMSI-1		

Table 9.2.1.2.1.3.3-3: Void

Table 9.2.1.2.1.3.3-4: Void

Table 9.2.1.2.1.3.3-5: Message TRACKING AREA UPDATE REQUEST (step 21, Table 9.2.1.2.1.3.2-1)

Derivation path: 36.508 table 4.7.2-27			
Information Element	Value/Remark	Comment	Condition
EPS update type EPS update type value	'001'B	"Combined TA/LA updating"	
Old GUTI	GUTI-2	"Old GUTI is included by UE if valid, IMSI otherwise"	
Old location area identification	LAI-1		
TMSI status	Not Present		

Table 9.2.1.2.1.3.3-6: Message TRACKING AREA UPDATE ACCEPT (step 22, Table 9.2.1.2.1.3.2-1)

Derivation path: 36.508 table 4.7.2-24			
Information Element	Value/Remark	Comment	Condition
EPS update result	'001'B	"combined TA/LA updated"	
GUTI	GUTI-3		
TAI list			
Length of tracking area identity list contents	'00000110'B		
Partial tracking area identity list			
Number of elements	'00000'B		
Type of list	'00'B	"list of TACs belonging to one PLMN, with non-consecutive TAC values"	
MCC MNC TAC 1	TAI-3		
Location area identification	LAI-3		
MS identity	TMSI-3		

Table 9.2.1.2.1.3.3-7: Message ATTACH REQUEST (step 28, Table 9.2.1.2.1.3.2-1)

Derivation path: 36.508 table 4.7.2-4			
Information Element	Value/Remark	Comment	Condition
EPS attach type	'0010'B	"combined EPS/IMSI attach"	
Old GUTI or IMSI	GUTI-3		
Last visited registered TAI	TAI-3		
Old location area identification	LAI-3		
TMSI status	Not Present		

Table 9.2.1.2.1.3.3-8: Message ATTACH ACCEPT (For the UE registration procedure in TS 36.508 clause 4.5.2.3)

Derivation path: 36.508 table 4.7.2-1			
Information Element	Value/Remark	Comment	Condition
EPS attach result	'010'B	"Combined EPS/IMSI attach"	
TAI list			
Length of tracking area identity list contents	'00000110'B		
Partial tracking area identity list			
Number of elements	'00000'B		
Type of list	'00'B	"list of TACs belonging to one PLMN, with non-consecutive TAC values"	
MCC MNC TAC 1	TAI-3		
GUTI	GUTI-3		

9.2.1.2.1b Combined attach procedure / Success / SMS only

9.2.1.2.1b.1 Test Purpose (TP)

(1)

```
with { UE operating in CS/PS mode 1, in state EMM-REGISTERED-INITIATED}
ensure that {
  when { UE receives ATTACH ACCEPT message with EPS attach result 'combined EPS/IMSI attach' and
Additional update result IE 'SMS only' and indicating that IMS voice over PS sessions is not
supported }
}
```

```

    then { UE automatically disables the E-UTRA capability and performs a registration to UTRAN cell
or GERAN cell (depending on the UE capability) }
}

```

(2)

```

with { UE operating in CS/PS mode 2, in state EMM-REGISTERED and state MM-IDLE }
ensure that {
  when { UE receives ATTACH ACCEPT message with EPS attach result 'combined EPS/IMSI attach' and
Additional update result IE 'SMS only' and indicating that IMS voice over PS sessions is not
supported and SS sends Paging message with PS domain }
  then { UE sends SERVICE REQUEST message }
}

```

(3)

```

with { UE operating in CS/PS mode 2 and configured to use IMS voice, in state EMM-REGISTERED and
state MM-IDLE }
ensure that {
  when { UE receives ATTACH ACCEPT message with EPS attach result 'combined EPS/IMSI attach' and
Additional update result IE 'SMS only' and indicating that IMS voice over PS sessions is not
supported and the user initiates an IMS voice call }
  then { UE does not initiate an IMS voice call }
}

```

(4)

```

with { UE operating in CS/PS mode 1" }
ensure that {
  when { receives ATTACH ACCEPT message with EPS attach result 'combined EPS/IMSI attach' and
Additional update result IE 'SMS only' and indicating that IMS voice over PS sessions is not
supported }
  then { UE does not set the E-UTRA support bit in the relevant RRC messages }
}

```

9.2.1.2.1b.2 Conformance requirements

References: The conformance requirements covered in the present TC are specified in: 3GPP TS 24.301 clauses 4.3.1, 4.5, 5.5.1.3.1, 5.5.1.3.4.1 5.5.1.3.4.2 and 5.6.2.4.

[TS 24.301 clause 4.3.1]

The behaviour of the UE in CS/PS mode 1 of operation, upon failure to access the CS domain or upon reception of a "CS fallback not preferred" or "SMS only" indication, will depend on the availability of voice over IMS. In the present document, "IMS voice not available" refers to one of the following conditions:

- the UE is not configured to use IMS;
- the UE is not configured to use IMS voice, i.e. when the voice domain preference for E-UTRAN, as defined in 3GPP TS 24.167 [13B], indicates that voice communication services are allowed to be invoked only over the CS domain;
- the UE is configured to use IMS voice, but the network indicates in the ATTACH ACCEPT message or the TRACKING AREA UPDATE ACCEPT message that IMS voice over PS sessions are not supported; or
- the UE is configured to use IMS voice, the network indicates in the ATTACH ACCEPT message or the TRACKING AREA UPDATE ACCEPT message that IMS voice over PS sessions are supported, but the upper layers indicate that the UE is not available for voice calls in the IMS.

[TS 24.301 clause 4.5]

When the UE supporting the A/Gb and/or Iu mode together with the S1 mode needs to stay in A/Gb or Iu mode, in order to prevent unwanted handover or cell reselection from UTRAN/GERAN to E-UTRAN, the UE shall disable the E-UTRA capability.

- The UE shall not set the E-UTRA support bits of the MS Radio Access capability IE (see 3GPP TS 24.008 [13], subclause 10.5.5.12a), the E-UTRA support bits of Mobile Station Classmark 3 IE (see 3GPP TS 24.008 [13], subclause 10.5.1.7) and the ISR support bit of the MS network capability IE (see 3GPP TS 24.008 [13], subclause 10.5.5.12) in the ATTACH REQUEST message and the ROUTING AREA UPDATE REQUEST message after it selects GERAN or UTRAN; and

- the UE NAS layer shall indicate the access stratum layer(s) of disabling of the E-UTRA capability.

NOTE: The UE can only disable the E-UTRAN capabilities when in EMM-IDLE mode.

The UE shall enable the E-UTRA capability again in the following cases:

- the UE mode of operation changes from CS/PS mode 1 of operation to CS/PS mode 2 of operation;
- the UE mode of operation changes from PS mode 1 of operation to PS mode 2 of operation;
- the UE powers off and powers on again; or
- for the PLMN selection purpose.

[TS24.301 clause5.5.1.3.1]

The combined attach procedure is used by a UE in CS/PS mode 1 or CS/PS mode 2 of operation to attach for both EPS and non-EPS services, or both EPS services and "SMS only".

The combined attach procedure is also used by a UE in CS/PS mode 1 or CS/PS mode 2 of operation to attach for EPS services if it is already IMSI attached for non-EPS services.

When the UE initiates a combined attach procedure, the UE shall indicate "combined EPS/IMSI attach" in the EPS attach type IE.

The combined attach procedure follows the attach procedure for EPS described in subclause 5.5.1.2.

[TS24.301 clause5.5.1.3.2]

If the UE is in EMM state EMM-DEREGISTERED, the UE initiates the combined attach procedure by sending an ATTACH REQUEST message to the network, starting timer T3410 and entering state EMM-REGISTERED-INITIATED (see example in figure 5.5.1.2.2.1).

The UE shall include the TMSI status IE if no valid TMSI is available. Furthermore, if the UE has stored a valid location area identification, the UE shall include it in the Old location area identification IE in the ATTACH REQUEST message.

If the UE initiates a combined attach procedure for EPS services and "SMS only", the UE shall indicate "SMS only" in the Additional update type IE.

[TS24.301 clause5.5.1.3.4.1]

Depending on the value of the EPS attach result IE received in the ATTACH ACCEPT message, the following different cases can be distinguished:

- 1) The EPS attach result IE value indicates "combined EPS/IMSI attach": attach for EPS and non-EPS services, or for EPS services and "SMS only" have been successful.

...

[TS24.301 clause5.5.1.3.4.2]

The description for attach for EPS services as specified in subclause 5.5.1.2.4 shall be followed. In addition, the following description for attach for non-EPS services or "SMS only" applies.

...

If the UE requested "SMS only" in the Additional update type IE, the network shall indicate "SMS only" in the Additional update result IE.

If the ATTACH ACCEPT message includes the Additional update result IE with value "SMS only" or "CS Fallback not preferred", a UE operating in CS/PS mode 1 with "IMS voice not available" shall attempt to select GERAN or UTRAN radio access technology rather than E-UTRAN for the selected PLMN or equivalent PLMN. The UE shall disable the E-UTRA capability (see subclause 4.5). If the UE is in the EMM-CONNECTED mode, the UE shall locally release the established NAS signalling connection and enter the EMM-IDLE mode before selecting GERAN or UTRAN radio access technology.

If the ATTACH ACCEPT message includes the Additional update result IE with value "SMS only", a UE operating in CS/PS mode 2 shall not attempt to use CS fallback for mobile originating services.

....

[TS24.301 clause 5.6.2.4]

The network shall initiate the paging procedure when it receives an incoming mobile terminating SMS to the UE that is IMSI attached for non-EPS services or for "SMS only", and no NAS signalling connection exists.

To initiate the procedure for SMS when no NAS signalling connection exists, the EMM entity in the network requests the lower layer to start paging (see 3GPP TS 36.413 [23]). The paging message shall include a CN domain indicator set to "PS". The paging procedure is performed according to subclause 5.6.2.2.1. The MME shall not start timer T3413 for this procedure.

9.2.1.2.1b.3 Test description

9.2.1.2.1b.3.1 Pre-test conditions

System Simulator:

- Cell A is configured according to Table 6.3.2.2-1 in [18].
- If pc_UTRA AND px_RATComb_Tested = EUTRA_UTRA, Cell 5;
- If pc_GERAN AND px_RATComb_Tested = EUTRA_GERAN then, Cell 24;
 - Cell 24 belongs to LAI-1 and RAI-1(home PLMN)
- System information combination 10 as defined in TS 36.508[18] clause 4.4.3.1 is used in E-UTRA cells.

Note: Setting px_RATComb_Tested = EUTRA_Only is not allowed.

UE:

- The UE is configured to initiate combined EPS/IMSI attach and to be voice centric (UE operates in CS/PS mode 1). If the UE does not support to be configured voice centric initiate combined EPS/IMSI attach and to be data centric (UE operates in CS/PS mode 2).
- the UE is previously registered on E-UTRAN, and when on E-UTRAN, the UE is last authenticated and registered on cell A using default message contents according to TS 36.508 [18].

Preamble:

- The UE is in state Switched OFF (state 1) according to [18].

9.2.1.2.1b.3.2 Test procedure sequence

Table 9.2.1.2.1b.3.2-1: Main Behaviour

St	Procedure	Message Sequence		TP	Verdict
		U - S	Message		
	The following messages are sent and shall be received on cell A.				
1	Set the cell type of cell A to the "Serving cell". Set the cell type of cell 5 or cell 24 to the "Non-Suitable cell".	-	-	-	-
2	The UE is powered up or switched on.			-	-
2A1	UE sends RRCConnectionRequest message	-	-	-	-
2A2	SS sends RRCConnectionSetup message	-	-	-	-
2A3	Set the cell type of cell 5 or cell 24 to "Suitable neighbour cell".	-	-	-	-
3	UE sends ATTACH REQUEST message with a PDN CONNECTIVITY REQUEST message to request PDN connectivity to the default PDN. EPS attach type = "combined EPS/IMSI attach".	-->	ATTACH REQUEST	-	-
4	The SS starts an authentication procedure	<--	AUTHENTICATION REQUEST	-	-
5	The UE responds properly to the authentication procedure	-->	AUTHENTICATION RESPONSE	-	-
6	The SS starts a NAS security mode command procedure to perform NAS integrity protection.	<--	SECURITY MODE COMMAND	-	-
7	The UE responds properly to the NAS security mode command procedure	-->	SECURITY MODE COMPLETE	-	-
-	EXCEPTION: Steps 7Aa1 to 7Aa2 describe behaviour that depends on UE configuration; the "lower case letter" identifies a step sequence that take place if the UE has ESM information which needs to be transferred.	-	-	-	-
7Aa1	IF the UE sets the ESM information transfer flag in the last PDN CONNECTIVITY REQUEST message THEN the SS transmits an ESM INFORMATION REQUEST message to initiate exchange of protocol configuration options and/or APN.	<--	ESM INFORMATION REQUEST	-	-
7Aa2	The UE transmits an ESM INFORMATION RESPONSE message to transfer protocol configuration options and/or APN.	-->	ESM INFORMATION RESPONSE	-	-
8	The SS sends ATTACH ACCEPT message with the ACTIVATE DEFAULT EPS BEARER CONTEXT REQUEST message.	<--	ATTACH ACCEPT	-	-
9	Void	-	-	-	-
10	Void	-	-	-	-
-	EXCEPTION: Steps 11a1 to 11b3a2 describe behaviour that depends on the UE capability; the "lower case letter" identifies a step sequence that take place if a capability is supported				
11a1	IF the UE is configured in <i>CS/PS mode 1 of operation</i> THEN perform actions specified in Table 9.2.1.2.1b.3.2-2.				
11a2 a1- 11a2 a4	Void	-	-	-	-
11a3 - 11a6	Void	-	-	-	-
11b0	ELSE The UE transmits an ATTACH COMPLETE message.	-->	ATTACH COMPLETE	-	-
11b1	SS releases the RRC connection	-	-	-	-

11b2	Check: Does the UE respond to paging on cell A with S-TMSI in GUTI-2 for PS domain?(Generic Procedure TS36.508 6.4.2.4)	-	-	2	P
-	EXCEPTION: Steps 11b3a1 to 11b3a2 describe behaviour that depends on the UE capability.				
11b3 a1	IF pc_VoLTE THEN an IMS voice call is initiated (see Note 1)	-	-	-	-
11b3 a2	Check: Does the UE send RRC CONNECTION REQUEST message?	-->	RRC CONNECTION REQUEST	3	F
Note 1: The request is assumed to be triggered by AT command D.					

Table 9.2.1.2.1b.3.2-2: CS/PS mode 1 of operation with "IMS voice not available" behaviour

St	Procedure	Message Sequence		TP	Verdict
		U - S	Message		
-	EXCEPTION: Steps 1a1 to 1c2 depend on UE release. IF UE is Release 8, Release 9 or Release 10 steps 1a1 to 1b3 are considered. Steps 1a1 to 1b3 are optional and depend on UE implementation. They shall be executed if the UE sends an ATTACH COMPLETE with the ACTIVATE DEFAULT EPS BEARER CONTEXT ACCEPT message OR a DETACH REQUEST message during [2] seconds. The "lower case letter" identifies a step sequence that takes place if a particular condition specified in the first step is met. Note: UE may also locally release the established NAS signalling connection and start 2G/3G search immediately. ELSE IF UE is Release 11 onward, steps 1c1 and 1c2 are executed.	-	-	-	-
1a1	IF UE sent an ATTACH COMPLETE message with the ACTIVATE DEFAULT EPS BEARER CONTEXT ACCEPT message	-->	ATTACH COMPLETE	-	-
-	EXCEPTION: Steps 1a2a1 to 1a2a2 are optional and depend on UE implementation; the second "lower case letter" identifies a step sequence that takes place if the condition is met.	-	-	-	-
1a2a 1	IF UE sends a DETACH REQUEST message during [2] seconds.	-->	DETACH REQUEST	-	-
1a2a 2	SS sends a DETACH ACCEPT message.	<--	DETACH ACCEPT	-	-
1a3	SS releases the RRC connection	-	-	-	-
1b1	IF UE sent a DETACH REQUEST message.	-->	DETACH REQUEST	-	-
1b2	SS sends a DETACH ACCEPT message. Note: It is not explicitly defined what the network should do if the UE did not send ATTACH COMPLETE.	<--	DETACH ACCEPT	-	-
1b3	SS releases the RRC connection	-	-	-	-
1c1	The UE transmits an ATTACH COMPLETE message with the ACTIVATE DEFAULT EPS BEARER CONTEXT ACCEPT message	-->	ATTACH COMPLETE	-	-
1c2	SS releases the RRC connection	-	-	-	-
2	Void	-	-	-	-
-	The following messages shall be received on Cell 5 or Cell 24	-	-	-	-
-	EXCEPTION: Steps 3a1 to 3a3 describe behaviour that depends on the UE capability; the "lower case letter" identifies a step sequence that take place if a capability is supported	-	-	-	-
3a1	IF pc_UTRA AND px_RATComb_Tested = EUTRA_UTRA THEN Check: Does the UE send RRC CONNECTION REQUEST on Cell 5?	-->	RRC CONNECTION REQUEST	4	P
3a2	The SS transmits an RRC CONNECTION SETUP message on Cell 5.	<--	RRC CONNECTION SETUP	-	-
3a3	Check: Does the UE transmit a RRC CONNECTION SETUP COMPLETE message on Cell 5?	-->	RRC CONNECTION SETUP COMPLETE	4	P
-	EXCEPTION: Steps 4a1 to 4b5 depend on UE implementation; the "lower case letter"	-	-	-	-

	identifies a step sequence that takes place if the condition is met.				
4a1	IF UE did not sent DETACH REQUEST in step 1a2a1 or 1b1 AND UE transmits a ROUTING AREA UPDATE REQUEST message during [2] seconds THEN check contents of ROUTING AREA UPDATE REQUEST	-->	ROUTING AREA UPDATE REQUEST	1	P
-	EXCEPTION: step 4a1Aa1 to 4a1Aa2 take place if pc_GERAN AND px_RATComb_Tested = EUTRA_GERAN		-	-	-
4a1A a1	The SS transmits an AUTHENTICATION AND CIPHERING REQUEST message. from Cell 24	<--	AUTHENTICATION AND CIPHERING REQUEST	-	-
4a1A a2	The UE transmits a AUTHENTICATION AND CIPHERING RESPONSE message on Cell 24	-->	AUTHENTICATION AND CIPHERING RESPONSE	-	-
4a2	The SS transmits a ROUTING AREA UPDATE ACCEPT message.	<--	ROUTING AREA UPDATE ACCEPT	-	-
4a3	The UE transmits a ROUTING AREA UPDATE COMPLETE message.	-->	ROUTING AREA UPDATE COMPLETE	-	-
4b1	ELSE check: Does the UE transmit an ATTACH REQUEST message?.	-->	ATTACH REQUEST	1	P
4b2	The SS transmits an AUTHENTICATION AND CIPHERING REQUEST message.	<--	AUTHENTICATION AND CIPHERING REQUEST	-	-
4b3	The UE transmits a AUTHENTICATION AND CIPHERING RESPONSE message.	-->	AUTHENTICATION AND CIPHERING RESPONSE	-	-
4b4	The SS transmits an ATTACH ACCEPT message.	<--	ATTACH ACCEPT	-	-
4b5	The UE transmits an ATTACH COMPLETE message.	-->	ATTACH COMPLETE	-	-

9.2.1.2.1b.3.3 Specific message contents

Table 9.2.1.2.1b.3.3-1: Message ATTACH REQUEST (step 3, Table 9.2.1.2.1b.3.2-1)

Derivation path: 36.508 table 4.7.2.-4			
Information Element	Value/Remark	Comment	Condition
EPS attach type	'0010'B	"combined EPS/IMSI attach"	
Old GUTI or IMSI	GUTI-1		
Last visited registered TAI	TAI-1		
Old location area identification	LAI-1		
TMSI status	Not Present		

Table 9.2.1.2.1b.3.3-2: Message ATTACH ACCEPT (step 8, Table 9.2.1.2.1b.3.2-1)

Derivation path: 36.508 table 4.7.2-1			
Information Element	Value/Remark	Comment	Condition
EPS attach result	'010'B	"Combined EPS/IMSI attach"	
GUTI	GUTI-2		
EPS network feature support	'0000 0000'B	IMS voice over PS session in S1 mode NOT supported	
Additional update result	'10'B0000	SMS only	

Table 9.2.1.2.1b.3.3-3: Message RRC Connection Request (step 3 a1, Table 9.2.1.2.1b.3.2-2)

Derivation path: 34.108 sub-clause 9.1.1			
Information Element	Value/Remark	Comment	Condition
Pre-redirectio info	Not present OR value as specified below		
> Support of E-UTRA FDD	False	E-UTRA FDD not supported	
> Support of E-UTRA TDD	False	E-UTRA TDD not supported	

Table 9.2.1.2.1b.3.3-4: Message RRC Connection Setup Complete (step 3 a3, Table 9.2.1.2.1b.3.2-2)

Derivation path: 34.108 sub-clause 9.1.1			
Information Element	Value/Remark	Comment	Condition
UE radio access capability		The UE shall not indicate support for E-UTRAN	
>UE multi-mode/multi-RAT capability	Not present OR value as specified below		
>> Multi-RAT capability			
>>> Support of Inter-RAT PS Handover to E-UTRA FDD	Not present		
>>> Support of E-UTRA TDD	Not present		
>>> Support of Inter-RAT PS Handover to E-UTRA TDD	Not present		
>>> EUTRA Feature Group Indicators	Not checked		

Table 9.2.1.2.1b.3.3-5: Message ROUTING AREA UPDATE REQUEST (step4 a1, Table 9.2.1.2.1b.3.2-2)

Derivation path: 36.508 table 4.7B.2-1			
Information Element	Value/Remark	Comment	Condition
MS Radio Access capability		The UE shall not indicate support for E-UTRAN	
MS RA capability value part			
Access capabilities			
E-UTRA FDD support :	'0'B		
E-UTRA TDD support	'0'B		
GERAN to E-UTRA support in GERAN packet transfer mode	'00'B		
UE network capability	Not Present	UE does not support S1 mode any more	

Table 9.2.1.2.1b.3.3-6: Message ATTACH REQUEST (step4 b1, Table 9.2.1.2.1b.3.2-2)

Derivation path: 36.508 table 4.7B.2-6			
Information Element	Value/Remark	Comment	Condition
MS Radio Access capability		The UE shall not indicate support for E-UTRAN	
MS RA capability value part			
Access capabilities			
E-UTRA FDD support :	'0'B		
E-UTRA TDD support	'0'B		
GERAN to E-UTRA support in GERAN packet transfer mode	'00'B		
UE network capability	Not Present	UE does not support S1 mode any more	

9.2.1.2.1c Combined attach procedure / Success / EPS and CS Fallback not preferred

9.2.1.2.1c.1 Test Purpose (TP)

(1)

```
with { UE operating in CS/PS mode 1 in state EMM-REGISTERED-INITIATED}
ensure that {
  when { UE receives ATTACH ACCEPT message with "EPS network feature support" IE indicating that
"IMS voice over PS session in S1 mode NOT supported" and "Additional update result" IE indicating
"CS Fallback not preferred"}
  then { UE attempts to register on UTRAN cell and automatically disables its E-UTRAN capability.}
}
```

(2)

```
with { UE operating in CS/PS mode 1 in OFF state after having its E-UTRAN capability disabled}
ensure that {
  when { UE is switched on }
  then { UE re-enables its E-UTRA capability and registers on the E-UTRAN cell}
}
```

(3)

```
with { UE operating in CS/PS mode 1 }
ensure that {
  when { UE receives ATTACH ACCEPT message with EPS attach result 'combined EPS/IMSI attach' and
Additional update result IE 'CS Fallback not preferred' and with "EPS network feature support" IE
indicating that "IMS voice over PS session in S1 mode NOT supported"}
  then { UE does not set the E-UTRA support bit in the relevant NAS and AS messages}
}
```

9.2.1.2.1c.2 Conformance requirements

References: The conformance requirements covered in the present TC are specified in: 3GPP TS 24.301 clauses 4.3.1, 4.5 and 5.5.1.3.4.2.

[TS 24.301 clause 4.3.1]

The behaviour of the UE in CS/PS mode 1 of operation, upon failure to access the CS domain or upon reception of a "CS fallback not preferred" or "SMS only" indication, will depend on the availability of voice over IMS. In the present document, "IMS voice not available" refers to one of the following conditions:

- the UE is not configured to use IMS;
- the UE is not configured to use IMS voice, i.e. when the voice domain preference for E-UTRAN, as defined in 3GPP TS 24.167 [13B], indicates that voice communication services are allowed to be invoked only over the CS domain;
- the UE is configured to use IMS voice, but the network indicates in the ATTACH ACCEPT message or the TRACKING AREA UPDATE ACCEPT message that IMS voice over PS sessions are not supported; or
- the UE is configured to use IMS voice, the network indicates in the ATTACH ACCEPT message or the TRACKING AREA UPDATE ACCEPT message that IMS voice over PS sessions are supported, but the upper layers indicate that the UE is not available for voice calls in the IMS.

[TS 24.301 clause 4.5]

When the UE supporting the A/Gb and/or Iu mode together with the S1 mode needs to stay in A/Gb or Iu mode, in order to prevent unwanted handover or cell reselection from UTRAN/GERAN to E-UTRAN, the UE shall disable the E-UTRA capability.

- The UE shall not set the E-UTRA support bits of the MS Radio Access capability IE (see 3GPP TS 24.008 [13], subclause 10.5.5.12a), the E-UTRA support bits of Mobile Station Classmark 3 IE (see 3GPP TS 24.008 [13], subclause 10.5.1.7) and the ISR support bit of the MS network capability IE (see 3GPP TS 24.008 [13], subclause 10.5.5.12) in the ATTACH REQUEST message and the ROUTING AREA UPDATE REQUEST message after it selects GERAN or UTRAN; and
- the UE NAS layer shall indicate the access stratum layer(s) of disabling of the E-UTRA capability.

NOTE: The UE can only disable the E-UTRAN capabilities when in EMM-IDLE mode.

The UE shall enable the E-UTRA capability again in the following cases:

- the UE mode of operation changes from CS/PS mode 1 of operation to CS/PS mode 2 of operation;
- the UE mode of operation changes from PS mode 1 of operation to PS mode 2 of operation;
- the UE powers off and powers on again; or
- for the PLMN selection purpose.

[TS 24.301 clause 5.5.1.3.4.2]

If the UE requested "SMS only" in the Additional update type IE, the network shall indicate "SMS only" in the Additional update result IE.

If the ATTACH ACCEPT message includes the Additional update result IE with value "SMS only" or "CS Fallback not preferred", a UE operating in CS/PS mode 1 with "IMS voice not available" shall attempt to select GERAN or UTRAN radio access technology rather than E-UTRAN for the selected PLMN or equivalent PLMN. The UE shall disable the E-UTRA capability (see subclause 4.5). If the UE is in the EMM-CONNECTED mode, the UE shall locally release the established NAS signalling connection and enter the EMM-IDLE mode before selecting GERAN or UTRAN radio access technology.

If the ATTACH ACCEPT message includes the Additional update result IE with value "SMS only", a UE operating in CS/PS mode 2 shall not attempt to use CS fallback for mobile originating services.

If the ATTACH ACCEPT message includes the Additional update result IE with value "CS Fallback not preferred", this indicates to a UE operating in CS/PS mode 2 that it is attached for EPS and non-EPS services and that it can use CS fallback.

9.2.1.2.1c.3 Test description

9.2.1.2.1c.3.1 Pre-test conditions

System Simulator:

- cell A and cell 5 and both belong to PLMN1;
- System information combination 4 as defined in TS 36.508[18] clause 4.4.3.1 is used in E-UTRA cells.

UE:

- the UE is configured to initiate combined EPS/IMSI attach;
- the UE is configured to be voice centric
- The HPLMN is PLMN1
- the UE is previously registered on E-UTRAN, and when on E-UTRAN, the UE is last authenticated and registered on cell A using default message contents according to TS 36.508 [18].

Preamble:

- the UE is in state Switched OFF (state 1) according to TS 36.508 [18].

9.2.1.2.1c.3.2 Test procedure sequence

Table 9.2.1.2.1c.3.2-1: Main Behaviour

St	Procedure	Message Sequence		TP	Verdict
		U – S	Message		
-	Cell A is set to "Serving cell" and Cell 5 is set to "Non suitable cell"	-	-	-	-
-	The following messages are to be observed on Cell A unless explicitly stated otherwise.	-	-	-	-
1	The UE is powered up or switched on.	-	-	-	-
2	UE sends RRCConnectionRequest message	-	-	-	-
3	SS sends RRCConnectionSetup message	-	-	-	-
4	Set the cell type of cell 5 to "Suitable neighbour cell".	-	-	-	-
5	UE sends ATTACH REQUEST message with a PDN CONNECTIVITY REQUEST message to request PDN connectivity to the default PDN. EPS attach type = "combined EPS/IMSI attach".	-->	ATTACH REQUEST	-	-
5	UE sends ATTACH REQUEST message with a PDN CONNECTIVITY REQUEST message to request PDN connectivity to the default PDN. EPS attach type = "combined EPS/IMSI attach".	-->	ATTACH REQUEST	-	-
6	The SS starts an authentication procedure	<--	AUTHENTICATION REQUEST	-	-
7	The UE responds properly to the authentication procedure	-->	AUTHENTICATION RESPONSE	-	-
8	The SS starts a NAS security mode command procedure to perform NAS integrity protection.	<--	SECURITY MODE COMMAND	-	-
9	The UE responds properly to the NAS security mode command procedure	-->	SECURITY MODE COMPLETE	-	-
-	EXCEPTION: Steps 9a1 to 9a2 describe behaviour that depends on UE configuration; the "lower case letter" identifies a step sequence that take place if the UE has ESM information which needs to be transferred.	-	-	-	-
9a1	IF the UE sets the ESM information transfer flag in the last PDN CONNECTIVITY REQUEST message THEN the SS transmits an ESM INFORMATION REQUEST message to initiate exchange of protocol configuration options and/or APN.	<--	ESM INFORMATION REQUEST	-	-
9a2	The UE transmits an ESM INFORMATION RESPONSE message to transfer protocol configuration options and/or APN.	-->	ESM INFORMATION RESPONSE	-	-
10	The SS sends ATTACH ACCEPT message with the ACTIVATE DEFAULT EPS BEARER CONTEXT REQUEST message.	<--	ATTACH ACCEPT	-	-
11	Perform actions specified in Table 9.2.1.2.1c.3.2-2	-	-	-	-
-	If possible (see ICS) switch off is performed or the USIM is removed. Otherwise the power is removed.	-	-	-	-
-	EXCEPTION: Step 12 describes behaviour that depends on the UE capability.	-	-	-	-
12a	If pc_SwitchOnOff or pc_USIM_Removal	-->	DETACH REQUEST	-	-

	then the UE transmits a DETACH REQUEST.				
13	Set the cell type of cell 5 to "Non suitable".				
14	The UE is brought back to operation or the USIM is inserted .	-	-		
15	Check: Does the UE send <i>RRConnectionRequest</i> on Cell A?	-	-	2	P
16-30	Steps 3-17 of the registration procedure described in TS 36.508 table 4.5.2.3-1 are performed.	-	-	-	-

Table 9.2.1.2.1c.3.2-2: CS/PS mode 1 of operation with "IMS voice not available" behaviour

St	Procedure	Message Sequence		TP	Verdict
		U - S	Message		
-	EXCEPTION: Step 1a1 to 1d3 are optional and depend on UE implementation. The "lower case letter" identifies a step sequence that takes place if a particular condition specified in the first step is met within [2] seconds.	-	-	-	-
1a1	IF UE sent an ATTACH COMPLETE message with the ACTIVATE DEFAULT EPS BEARER CONTEXT ACCEPT message	-->	ATTACH COMPLETE	-	-
-	EXCEPTION: Steps 1a2a1 to 1a2a2 are optional and depend on UE implementation; the second "lower case letter" identifies a step sequence that takes place if the condition is met..	-	-	-	-
1a2a1	IF UE sends a DETACH REQUEST message during [2] seconds.	-->	DETACH REQUEST	-	-
1a2a2	SS sends a DETACH ACCEPT message.	<--	DETACH ACCEPT	-	-
1a3	SS releases the RRC connection	-	-	-	-
1a4	Check: Does the UE send RRC CONNECTION REQUEST on Cell 5?	-	-	1,3	P
1a5	The SS sends RRC CONNECTION SETUP	-	-	-	-
1a6	The UE sends RRC CONNECTION SETUP COMPLETE	-	-	3	-
1a7	Perform actions specified in Table 9.2.1.2.1c.3.2-3				
1b1	IF UE sent a DETACH REQUEST message.	-->	DETACH REQUEST	-	-
1b2	SS sends a DETACH ACCEPT message. Note: It is not explicitly defined what the network should do if the UE did not send ATTACH COMPLETE.	<--	DETACH ACCEPT	-	-
1b3	SS releases the RRC connection	-	-	-	-
1b4	Check: Does the UE send RRC CONNECTION REQUEST on Cell 5?	-	-	1,3	P
1b5	The SS sends RRC CONNECTION SETUP	-	-	-	-
1b6	The UE sends RRC CONNECTION SETUP COMPLETE	-	-	3	-
1b7	Perform actions specified in Table 9.2.1.2.1c.3.2-3				
1c1	IF the UE moved straight to UTRAN and sent an RRC CONNECTION REQUEST message on cell 5.	-	-	3	P
1c2	The SS sends RRC CONNECTION SETUP	-	-	-	-
1c3	The UE sends RRC CONNECTION SETUP COMPLETE	-	-	3	-
1c4	Perform actions specified in Table 9.2.1.2.1c.3.2-3				

Table 9.2.1.2.1c.3.2-3: Registration on UTRAN cell behaviour

St	Procedure	Message Sequence		TP	Verdict
		U - S	Message		
-	EXCEPTION: Steps 1a1 to 1b5 depend on UE implementation; the "lower case letter" identifies a step sequence that takes place if the condition is met..	-	-	-	-
1a1	IF UE did not sent DETACH REQUEST in step 1a2a1 or 1b1 in Table 9.2.1.2.1c.3.2-2 AND UE transmits a ROUTING AREA UPDATE REQUEST message during [2] seconds THEN check contents of ROUTING AREA UPDATE REQUEST	-->	ROUTING AREA UPDATE REQUEST	3	P
1a2	The SS transmits a ROUTING AREA UPDATE ACCEPT message.	<--	ROUTING AREA UPDATE ACCEPT	-	-
1a3	The UE transmits a ROUTING AREA UPDATE COMPLETE message.	-->	ROUTING AREA UPDATE COMPLETE	-	-
1b1	ELSE check: Does the UE transmit an ATTACH REQUEST message?.	-->	ATTACH REQUEST	3	P
1b2	The SS transmits an AUTHENTICATION AND CIPHERING REQUEST message.	<--	AUTHENTICATION AND CIPHERING REQUEST	-	-
1b3	The UE transmits a AUTHENTICATION AND CIPHERING RESPONSE message.	-->	AUTHENTICATION AND CIPHERING RESPONSE	-	-
1b4	The SS transmits an ATTACH ACCEPT message.	<--	ATTACH ACCEPT	-	-
1b5	The UE transmits an ATTACH COMPLETE message.	-->	ATTACH COMPLETE	-	-

9.2.1.2.1c.3.3 Specific message contents

Table 9.2.1.2.1c.3.3-1: Message ATTACH ACCEPT (step 10, Table 9.2.1.2.1c.3.2-1)

Derivation path: 36.508 table 4.7.2-1			
Information Element	Value/Remark	Comment	Condition
EPS attach result	'010'B	"Combined EPS/IMSI attach"	
ESM message container	ACTIVATE DEFAULT EPS BEARER CONTEXT REQUEST message to activate the default bearer	There is no message piggybacked in it.	
EPS network feature support	'0000 0000'B	IMS voice over PS session in S1 mode NOT supported	
Additional update result	'01'b	"CS Fallback not preferred"	

Table 9.2.1.2.1c.3.3-2: Message RRC Connection Request (steps 1a4, 1b4 and 1c1 Table 9.2.1.2.1c.3.2-2)

Derivation path: 34.108 sub-clause 9.1.1			
Information Element	Value/Remark	Comment	Condition
Pre-redirectio n info		Optional IE, but if transmitted it should have the below values	
> Support of E-UTRA FDD	False	E-UTRA FDD not supported	
> Support of E-UTRA TDD	False	E-UTRA TDD not supported	

Table 9.2.1.2.1c.3.3-3: Message RRC Connection Setup Complete (steps 1b6 and 1c3 Table 9.2.1.2.1c.3.2-2)

Derivation path: 34.108 sub-clause 9.1.1			
Information Element	Value/Remark	Comment	Condition
UE radio access capability		The UE shall not indicate support for E-UTRAN	
>UE multi-mode/multi-RAT capability			
>> Multi-RAT capability			
>>> Support of Inter-RAT PS Handover to E-UTRA FDD	Not present		
>>> Support of E-UTRA TDD	Not present		
>>> Support of Inter-RAT PS Handover to E-UTRA TDD	Not present		
>>> EUTRA Feature Group Indicators	Not checked		

Table 9.2.1.2.1c.3.3-4: Message ROUTING AREA UPDATE REQUEST (step 1a1, Table 9.2.1.2.1c.3.2-3)

Derivation path: 24.008 table 9.4.14			
Information Element	Value/Remark	Comment	Condition
MS Radio Access capability		The UE shall not indicate support for E-UTRAN	
MS RA capability value part			
Access capabilities			
E-UTRA FDD support :	'0'B		
E-UTRA TDD support	'0'B		
GERAN to E-UTRA support in GERAN packet transfer mode	'00'B		
UE network capability	Not Present	UE does not support S1 mode any more	

Table 9.2.1.2.1c.3.3-5: Message ATTACH REQUEST (step 1b1, Table 9.2.1.2.1c.3.2-3)

Derivation path: 24.008 table 9.4.1			
Information Element	Value/Remark	Comment	Condition
MS Radio Access capability		The UE shall not indicate support for E-UTRAN	
MS RA capability value part			
Access capabilities			
E-UTRA FDD support :	'0'B		
E-UTRA TDD support	'0'B		
UE network capability	Not Present	UE does not support S1 mode any more	
GERAN to E-UTRA support in GERAN packet transfer mode	'00'B		

9.2.1.2.1d Combined attach procedure / Success / EPS and CS Fallback not preferred/data centric UE

9.2.1.2.1d.1 Test Purpose (TP)

(1)

```

with { UE operating in CS/PS mode 2 in state EMM-REGISTERED-INITIATED}
ensure that {
  when { UE receives ATTACH ACCEPT message with "EPS network feature support" IE indicating that
"IMS voice over PS session in S1 mode NOT supported" and "Additional update result" IE indicating
"CS Fallback not preferred"}
  then { UE stays on the E-UTRAN cell}
}

```

(2)

```

with { UE operating in CS/PS mode 2 }
ensure that {
  when receives a TRACKING AREA UPDATE ACCEPT message with "EPS network feature support" IE
  indicating that "IMS voice over PS session in S1 mode NOT supported" and "Additional update result"
  IE indicating "CS Fallback not preferred" }
  then { The UE is able to initiate an MO-CS fallback call }
}

```

(3)

```

with { UE operating in CS/PS mode 2 }
ensure that {
  when receives a ATTACH ACCEPT message with "EPS network feature support" IE indicating that "IMS
  voice over PS session in S1 mode NOT supported" and "Additional update result" IE indicating "CS
  Fallback not preferred" }
  then { The UE is able to receive MT CS fallback call }
}

```

9.2.1.2.1d.2 Conformance requirements

References: The conformance requirements covered in the present TC are specified in: 3GPP TS 24.301 clauses 4.3.1, 4.5 and 5.5.1.3.4.2.

[TS 24.301 clause 4.3.1]

The behaviour of the UE in CS/PS mode 1 of operation, upon failure to access the CS domain or upon reception of a "CS fallback not preferred" or "SMS only" indication, will depend on the availability of voice over IMS. In the present document, "IMS voice not available" refers to one of the following conditions:

- the UE is not configured to use IMS;
- the UE is not configured to use IMS voice, i.e. when the voice domain preference for E-UTRAN, as defined in 3GPP TS 24.167 [13B], indicates that voice communication services are allowed to be invoked only over the CS domain;
- the UE is configured to use IMS voice, but the network indicates in the ATTACH ACCEPT message or the TRACKING AREA UPDATE ACCEPT message that IMS voice over PS sessions are not supported; or
- the UE is configured to use IMS voice, the network indicates in the ATTACH ACCEPT message or the TRACKING AREA UPDATE ACCEPT message that IMS voice over PS sessions are supported, but the upper layers indicate that the UE is not available for voice calls in the IMS.

[TS 24.301 clause 4.5]

The UE shall enable the E-UTRA capability again in the following cases:

- the UE mode of operation changes from CS/PS mode 1 of operation to CS/PS mode 2 of operation;
- the UE mode of operation changes from PS mode 1 of operation to PS mode 2 of operation;
- the UE powers off and powers on again; or
- for the PLMN selection purpose.

[TS 24.301 clause 5.5.1.3.4.2]

If the UE requested "SMS only" in the Additional update type IE, the network shall indicate "SMS only" in the Additional update result IE.

If the ATTACH ACCEPT message includes the Additional update result IE with value "SMS only" or "CS Fallback not preferred", a UE operating in CS/PS mode 1 with "IMS voice not available" shall attempt to select GERAN or UTRAN radio access technology rather than E-UTRAN for the selected PLMN or equivalent PLMN. The UE shall disable the E-UTRA capability (see subclause 4.5). If the UE is in the EMM-CONNECTED mode, the UE shall locally release the established NAS signalling connection and enter the EMM-IDLE mode before selecting GERAN or UTRAN radio access technology.

If the ATTACH ACCEPT message includes the Additional update result IE with value "SMS only", a UE operating in CS/PS mode 2 shall not attempt to use CS fallback for mobile originating services.

If the ATTACH ACCEPT message includes the Additional update result IE with value "CS Fallback not preferred", this indicates to a UE operating in CS/PS mode 2 that it is attached for EPS and non-EPS services and that it can use CS fallback.

9.2.1.2.1d.3 Test description

9.2.1.2.1d.3.1 Pre-test conditions

System Simulator:

- cell A and cell 5

UE:

- the UE is configured to initiate combined EPS/IMSI attach;
- the UE is configured to be data centric
- the UE is previously registered on E-UTRAN, and when on E-UTRAN, the UE is last authenticated and registered on cell A using default message contents according to TS 36.508 [18].

Table 9.2.1.2.1d.3.1–1: Void

Preamble:

- the UE is in state Switched OFF (state 1) according to TS 36.508 [18].

9.2.1.2.1d.3.2 Test procedure sequence

Table 9.2.1.2.1d.3.2-1: Void

Table 9.2.1.2.1d.3.2-2: Void

Table 9.2.1.2.1d.3.2-3: Main Behaviour

St	Procedure	Message Sequence		TP	Verdict
		U - S	Message		
-	The following messages are to be observed on Cell A unless explicitly stated otherwise. Cell A is configured as the Serving Cell and Cell 5 is configured as a Non-Suitable Cell	-	-	-	-
1	The UE is powered up or switched on.			-	-
2-16	Steps 2-16 of the registration procedure described in TS 36.508 table 4.5.2.3-1 are performed.			-	-
16A	Cell 5 is configured as a Suitable Neighbour Cell	-	-	-	-
17	Check: Does the UE try to access the UTRAN cell (cell 5) in the next 90s?			1	F
18	The SS transmits a <i>Paging</i> message to the UE on Cell A using S-TMSI with CN domain indicator set to "CS"	-	-	-	-
-	EXCEPTION: Step 19a1 describes behaviour that depends on the UE capability; the "lower case letter" identifies a step sequence that takes place if a capability is supported.	-	-	-	-
19a1	IF the UE needs to request upper layer input before accepting the CS fallback, the incoming CS call is accepted at the UE through MMI or AT command.	-	-	-	-
20	The UE transmits an <i>RRConnectionRequest</i> message on Cell A.	-	-	-	-
21	The SS transmits an <i>RRConnectionSetup</i> message on Cell A.	-	-	-	-
22	Check: Does the UE transmit an <i>RRConnectionSetupComplete</i> message containing an EXTENDED SERVICE REQUEST?	-->	EXTENDED SERVICE REQUEST	3	P
23	The SS transmits an <i>RRConnectionRelease</i> message on Cell 1 with IE <i>redirectionInformation</i> including <i>UTRA-CarrierFreq</i> of Cell 5.	-	-	-	-
23A	Cell A is configured as the Non-Suitable Cell	-	-	-	-
24-42	Steps 1-19 of the procedure described in TS 36.508 table 6.4.3.7.1-1 TS 36.508. A CS call is set up in the UTRAN cell.	-		-	-
42A-42F	The CS call is terminated. CC Disconnect procedure described in TS 36.5.23-3 table 10.1.3.1-1	-	-	-	-
42G	Cell A is configured as the Serving Cell	-	-	-	-
43-48	Steps 2-7 of the tracking area updating procedure on cell A as described in TS 36.508 table 4.5A.2.1-1 are performed				
-	A CS call is initiated.	-	-	-	-
49	The UE transmits an <i>RRConnectionRequest</i> message on Cell A.	-	-	-	-
50	The SS transmits an <i>RRConnectionSetup</i> message on Cell	-	-	-	-

	A.				
51	Check: Does the UE transmit an <i>RRConnectionSetupComplete</i> message containing an EXTENDED SERVICE REQUEST message?	-->	EXTENDED SERVICE REQUEST	2	P
52	The SS transmits an <i>RRConnectionRelease</i> message on Cell 1 with IE <i>redirectionInformation</i> including <i>UTRA-CarrierFreq</i> of Cell 5.	-	-	-	-
53-71	Steps 1-19 of the procedure described in TS 36.508 table 6.4.3.7.2-1. A CS call is set up in the UTRAN cell.	-	-	-	-

9.2.1.2.1d.3.3 Specific message contents

Table 9.2.1.2.1d.3.3-1: Message ATTACH ACCEPT (step 14, Table 9.2.1.2.1d.3.2-3)

Derivation path: 36.508 table 4.7.2-1			
Information Element	Value/Remark	Comment	Condition
EPS attach result	'010'B	"Combined EPS/IMSI attach"	
ESM message container	Empty	There is no message piggybacked in it.	
EPS network feature support	'0000 0000'B	IMS voice over PS session in S1 mode NOT supported	
Additional update result	'01'b	"CS Fallback not preferred"	

Table 9.2.1.2.1d.3.3-2: Message Paging (step 18, Table 9.2.1.2.1d.3.2-3)

Derivation Path: 36.508 clause 4.6.1-7			
Information Element	Value/remark	Comment	Condition
Paging ::= SEQUENCE {			
pagingRecordList SEQUENCE (SIZE (1..maxPageRec)) OF SEQUENCE {	1 entry		
ue-Identity[1] CHOICE {			
s-TMSI	Set to the value of the S-TMSI of the UE		
}			
cn-Domain[1]	cs		
}			
}			

Table 9.2.1.2.1d.3.3-3: RRConnectionRelease (steps 23 and 44 Table 9.2.1.2.1d.3.2-3)

Derivation Path: 36.508 Table 4.6.1-15			
Information Element	Value/remark	Comment	Condition
RRConnectionRelease ::= SEQUENCE {			
criticalExtensions CHOICE {			
c1 CHOICE {			
rrcConnectionRelease-r8 SEQUENCE {			
redirectedCarrierInfo ::= CHOICE {			
utra-FDD	Downlink UARFCN of cell 5		UTRA-FDD
utra-TDD	Downlink UARFCN of cell 5		UTRA-TDD
}			
}			
}			
}			

Table 9.2.1.2.1d.3.3-4: Message TRACKING AREA UPDATE ACCEPT (step 45, Table 9.2.1.2.1d.3.2-3)

Derivation path: 36.508 table 4.7.2-1			
Information Element	Value/Remark	Comment	Condition
EPS update result	'001'B	"Combined TA/LA updating"	
EPS network feature support	'0000 0000'B	IMS voice over PS session in S1 mode NOT supported	
Additional update result	'01'b	"CS Fallback not preferred"	

Table 9.2.1.2.1d.3.3-5: Message TRACKING AREA UPDATE REQUEST (step 44, Table 9.2.1.2.1d.3.2-3)

Derivation path: 36.508 table 4.7.2-27			
Information Element	Value/Remark	Comment	Condition
EPS update type			
EPS update type Value	'010'B	"Combined TA/LA updating with IMSI attach"	
Old P-TMSI Signature	Any Value		
Additional GUTI	Any Value		
Nonce	Any Value		

9.2.1.2.2 Combined attach procedure / Success / EPS services only / IMSI unknown in HSS

9.2.1.2.2.1 Test Purpose (TP)

(1)

```
with { UE in state EMM-DEREGISTERED and is switched off }
ensure that {
  when { the UE is powered up or switched on }
  then { the UE transmits an ATTACH REQUEST message with the EPS attach type set to "combined EPS/IMSI attach" and enters EMM-REGISTERED-INITIATED state }
}
```

(2)

```
with { UE in state EMM-REGISTERED-INITIATED }
ensure that {
  when { the UE receives an ATTACH ACCEPT message with EPS attach result set to "EPS only" and EMM cause set to "IMSI unknown in HSS" }
  then { the UE transmits an ATTACH COMPLETE message, the UE sets the update status to U3 ROAMING NOT ALLOWED, shall delete any TMSI, LAI and ciphering key sequence number and enters EMM-REGISTERED.NORMAL-SERVICE state and MM IDLE state. The USIM shall be considered as invalid for non-EPS services until switching off or the UICC containing the USIM is removed }
}
```

(3)

```
with { UE in E-UTRA EMM-REGISTERED.NORMAL-SERVICE state and MM IDLE state and USIM is invalidated by network for non-EPS services }
ensure that {
  when { SS sends DETACH REQUEST message with the Detach type IE "re-attach required" }
  then { the UE sends DETACH ACCEPT message, and then the UE sends ATTACH REQUEST message with EPS attach type set to 'EPS attach', including the value in 'Last visited registered TAI' and the valid GUTI and initiates an attach procedure }
}
```

(4)

```
with { UE in EMM-REGISTERED.NORMAL-SERVICE state and MM IDLE state and USIM is invalidated by network for non-EPS services }
ensure that {
  when { the UE is switch off and then powered up or switched on }
  then { the UE sends ATTACH REQUEST message with EPS attach type IE 'combined EPS/IMSI attach' }
}
```

(5)

```

with { UE in EMM-REGISTERED-INITIATED state }
ensure that {
  when { the UE receives ATTACH ACCEPT message with EPS attach result 'combined EPS/IMSI attach' }
  then { UE sends ATTACH COMPLETE message and enters EMM-REGISTERED.NORMAL-SERVICE state and MM
  IDLE state }
}

```

9.2.1.2.2.2 Conformance requirements

References: The conformance requirements covered in the present TC are specified in: TS 24.301, clauses 4.3, 5.5.1.2.2, 5.5.1.2.4, 5.5.1.3.1, 5.5.1.3.2, 5.5.1.3.4.1, 5.5.1.3.4.2, and 5.5.1.3.4.3.

[TS24.301 clause 4.3]

A UE attached for EPS services may operate in one of the following operation modes:

...

- CS/PS mode 1 of operation: the UE registers to both EPS and non-EPS services, and UE's usage setting is "voice centric"; and
- CS/PS mode 2 of operation: the UE registers to both EPS and non-EPS services, and UE's usage setting is "data centric" or the UE has no CS voice capability.

A UE configured to use CS fallback, shall operate in CS/PS mode 1 or CS/PS mode 2. Such UE may also be configured to use IMS, in which case the voice domain preference as defined in 3GPP TS 24.167 [13B] shall be used for the selection of the domain for originating voice communication services.

...

[TS 24.301, clause 5.5.1.2.2]

In state EMM-DEREGISTERED, the UE initiates the attach procedure by sending an ATTACH REQUEST message to the MME, starting timer T3410 and entering state EMM-REGISTERED-INITIATED (see example in figure 5.5.1.2.2.1). If timer T3402 is currently running, the UE shall stop timer T3402. If timer T3411 is currently running, the UE shall stop timer T3411.

...

- The UE shall include in the ATTACH REQUEST message a valid GUTI together with the last visited registered TAI, if available. If there is no valid GUTI available, the UE shall include the IMSI in the ATTACH REQUEST message.

...

[TS 24.301, clause 5.5.1.2.4]

If the attach request is accepted by the network, the MME shall send an ATTACH ACCEPT message to the UE and start timer T3450. The MME shall send the ATTACH ACCEPT message together with an ACTIVATE DEFAULT EPS BEARER CONTEXT REQUEST message contained in the ESM message container information element to activate the default bearer (see subclause 6.4.1). The network may also initiate the activation of dedicated bearers towards the UE by invoking the dedicated EPS bearer context activation procedure (see subclause 6.4.2).

...

The MME shall assign and include the TAI list the UE is registered to in the ATTACH ACCEPT message. The UE, upon receiving an ATTACH ACCEPT message, shall delete its old TAI list and store the received TAI list.

Upon receiving the ATTACH ACCEPT message, the UE shall stop timer T3410.

The GUTI reallocation may be part of the attach procedure. When the ATTACH REQUEST message includes the IMSI, or the MME considers the GUTI provided by the UE is invalid, or the GUTI provided by the UE was assigned by another MME, the MME shall allocate a new GUTI to the UE. The MME shall include in the ATTACH ACCEPT

message the new assigned GUTI together with the assigned TAI list. In this case the MME shall enter state EMM-COMMON-PROCEDURE-INITIATED as described in subclause 5.4.1.

...

If the ATTACH ACCEPT message contains a GUTI, the UE shall use this GUTI as the new temporary identity. The UE shall delete its old GUTI and store the new assigned GUTI. If no GUTI has been included by the MME in the ATTACH ACCEPT message, the old GUTI, if any available, shall be kept.

If A/Gb mode or Iu mode is supported in the UE, the UE shall set its TIN to "GUTI" when receiving the ATTACH ACCEPT message.

...

When the UE receives the ATTACH ACCEPT message combined with the ACTIVATE DEFAULT EPS BEARER CONTEXT REQUEST message, it shall forward the ACTIVATE DEFAULT EPS BEARER CONTEXT REQUEST message to the ESM sublayer. Upon receipt of an indication from the ESM sublayer that the default EPS bearer context has been activated, the UE shall send an ATTACH COMPLETE message together with an ACTIVATE DEFAULT EPS BEARER CONTEXT ACCEPT message contained in the ESM message container information element to the network.

Additionally, the UE shall reset the attach attempt counter and tracking area updating attempt counter, enter state EMM-REGISTERED and set the EPS update status to EU1 UPDATED.

...

Upon receiving an ATTACH COMPLETE message, the MME shall stop timer T3450, enter state EMM-REGISTERED and consider the GUTI sent in the ATTACH ACCEPT message as valid.

[TS 24.301, clause 5.5.1.3.1]

The combined attach procedure is used by a UE in CS/PS mode 1 or CS/PS mode 2 of operation to attach for both EPS and non-EPS services.

The combined attach procedure is also used by a UE in CS/PS mode 1 or CS/PS mode 2 of operation to attach for EPS services if it is already IMSI attached for non-EPS services.

When the UE initiates a combined attach procedure, the UE shall indicate "combined EPS/IMSI attach" in the EPS attach type IE.

The combined attach procedure follows the attach procedure for EPS described in subclause 5.5.1.2.

[TS 24.301, clause 5.5.1.3.2]

If the UE is in EMM state EMM-DEREGISTERED, the UE initiates the combined attach procedure by sending an ATTACH REQUEST message to the network, starting timer T3410 and entering state EMM-REGISTERED-INITIATED (see example in figure 5.5.1.2.2.1).

The UE shall include the TMSI status IE if no valid TMSI is available. Furthermore, if the UE has stored a valid location area identification, the UE shall include it in the Old location area identification IE in the ATTACH REQUEST message.

[TS 24.301, clause 5.5.1.3.4.1]

Depending on the value of the EPS attach result IE received in the ATTACH ACCEPT message, two different cases can be distinguished:

...

- 2) The EPS attach result IE value indicates "EPS only": attach for EPS services has been successful but attach for non-EPS services has failed.

[TS 24.301, clause 5.5.1.3.4.2]

The description for attach for EPS services as specified in subclause 5.5.1.2.4 shall be followed. In addition, the following description for attach for non-EPS services applies.

...

[TS 24.301, clause 5.5.1.3.4.3]

Apart from the actions on the tracking area updating attempt counter, the description for attach for EPS services as specified in subclause 5.5.1.2.4 shall be followed. In addition, the following description for attach for non-EPS services applies.

The UE receiving the ATTACH ACCEPT message takes one of the following actions depending on the EMM cause value:

#2 (IMSI unknown in HSS)

The UE shall stop T3410 if still running and shall reset the tracking area updating attempt counter. The UE shall set the update status to U3 ROAMING NOT ALLOWED and shall delete any TMSI, LAI and ciphering key sequence number. The UE shall enter state EMM-REGISTERED.NORMAL-SERVICE. The new MM state is MM IDLE. The USIM shall be considered as invalid for non-EPS services until switching off or the UICC containing the USIM is removed.

...

Other EMM cause values and the case that no EMM cause IE was received are considered as abnormal cases. The combined attach procedure shall be considered as failed for EPS and non-EPS services. The behaviour of the UE in those cases is specified in subclause 5.5.1.3.6.

[TS 24.301, clause 5.5.2.3.2]

When receiving the DETACH REQUEST message and the detach type indicates "re-attach required", the UE shall deactivate the EPS bearer context(s) including the default EPS bearer context locally without peer-to-peer signalling between the UE and the MME. The UE shall then send a DETACH ACCEPT message to the network and enter state EMM-DEREGISTERED. Furthermore, the UE shall, after the completion of the detach procedure, and the existing NAS signalling connection has been released, initiate an attach or combined attach or combined attach procedure

NOTE 1: When detach type indicates "re-attach required", user interaction is necessary in some cases when the UE cannot re-activate the EPS bearer(s) automatically.

A UE which receives a DETACH REQUEST message with detach type indicating "re-attach required" or "re-attach not required" and no EMM cause IE, is detached only for EPS services.

...

If the detach type indicates "IMSI detach" or "re-attach required", then the UE shall ignore the EMM cause IE if received.

9.2.1.2.2.3 Test description

9.2.1.2.2.3.1 Pre-test conditions

System Simulator:

- Cell A.

UE:

- the UE is configured to initiate combined EPS/IMSI attach;
- the UE is previously registered on E-UTRAN, and when on E-UTRAN, the UE is last authenticated and registered on cell A using default message contents according to TS 36.508 [18].

Preamble:

- the UE is in state Switched OFF (state 1) according to TS 36.508 [18].

9.2.1.2.2.3.2 Test procedure sequence

Table 9.2.1.2.2.3.2-1: Main behaviour

St	Procedure	Message Sequence		TP	Verdict
		U - S	Message		
1	The UE is powered up or switched on.	-	-	-	-
2	The UE transmits ATTACH REQUEST message with a PDN CONNECTIVITY REQUEST message to request PDN connectivity to the default PDN with EPS attach type set to "combined EPS/IMSI attach"	-->	ATTACH REQUEST	1	P
3	The SS starts an authentication procedure	<--	AUTHENTICATION REQUEST	-	-
4	The UE transmits an AUTHENTICATION RESPONSE message and establishes mutual authentication.	-->	AUTHENTICATION RESPONSE	-	-
5	The SS starts a NAS security mode command procedure to perform NAS integrity protection.	<--	SECURITY MODE COMMAND	-	-
6	The UE transmits a NAS SECURITY MODE COMPLETE message and establishes the initial security configuration.	-->	SECURITY MODE COMPLETE	-	-
-	EXCEPTION: Steps 6Aa1 to 6Aa2 describe behaviour that depends on UE configuration; the "lower case letter" identifies a step sequence that take place if the UE has ESM information which needs to be transferred.	-	-	-	-
6A a1	IF the UE sets the ESM information transfer flag in the last PDN CONNECTIVITY REQUEST message THEN the SS transmits an ESM INFORMATION REQUEST message to initiate exchange of protocol configuration options and/or APN.	<--	ESM INFORMATION REQUEST	-	-
6A a2	The UE transmits an ESM INFORMATION RESPONSE message to transfer protocol configuration options and/or APN.	-->	ESM INFORMATION RESPONSE	-	-
7	The SS transmits ATTACH ACCEPT message with EPS Attach result IE set to "EPS only" and EMM cause set to "IMSI unknown in HSS", including the ACTIVATE DEFAULT EPS BEARER CONTEXT REQUEST message as specified.	<--	ATTACH ACCEPT	-	-
-	EXCEPTION: In parallel to the event described in step 8 below the generic procedure for IP address allocation in the U-plane specified in TS 36.508 subclause 4.5A.1 takes place performing IP address allocation in the U-plane if requested by the UE.	-	-	-	-
8	Check: Does the UE transmit an ATTACH COMPLETE message including an ACTIVATE DEFAULT EPS BEARER CONTEXT ACCEPT message as specified?	-->	ATTACH COMPLETE	2	P
9 - 12	Void	-	-	-	-
13	The SS sends DETACH REQUEST message with Detach Type set to "re-attach required"	<--	DETACH REQUEST	-	-
14	Check: Does the UE send DETACH ACCEPT message?	-->	DETACH ACCEPT	3	P
15	The SS releases the RRC connection.	-	-	-	-
-	EXCEPTION: Step 15a describes a behaviour which depends on the UE capability	-	-	-	-
15a	IF NOT pc_Automatic_Re_Attach, the user initiates an attach by MMI or by AT command.	-	-	-	-
16	Check: Does the UE send ATTACH REQUEST message with EPS attach type set to "EPS attach", including the PDN CONNECTIVITY REQUEST message?	-->	ATTACH REQUEST	3	P

17	The SS sends ATTACH ACCEPT message including the ACTIVATE DEFAULT EPS BEARER CONTEXT REQUEST message	<--	ATTACH ACCEPT	-	-
-	EXCEPTION: In parallel to the event described in step 15 below the generic procedure for IP address allocation in the U-plane specified in TS 36.508 subclause 4.5A.1 takes place performing IP address allocation in the U-plane if requested by the UE.	-	-	-	-
18	Check: Does the UE send ATTACH COMPLETE message?	-->	ATTACH COMPLETE	3	P
19	If possible (see ICS) switch off is performed or the USIM is removed. Otherwise the power is removed.	-	-	-	-
-	EXCEPTION: Step 19a describes behaviour that depends on the UE capability.				
19a	If pc_SwitchOnOff or pc_USIM_Removal then UE sends DETACH REQUEST message	-->	DETACH REQUEST		
20	The UE is brought back to operation or the USIM is inserted.	-	-	-	-
21	Check: Does the UE transmit ATTACH REQUEST message with EPS attach type set to "combined EPS/IMSI attach", including PDN CONNECTIVITY REQUEST message?	-->	ATTACH REQUEST	4	P
22	The SS transmits ATTACH ACCEPT message with EPS Attach result IE set to "combined EPS/IMSI attach", including the ACTIVATE DEFAULT EPS BEARER CONTEXT REQUEST message.	<--	ATTACH ACCEPT	-	-
-	EXCEPTION: In parallel to the event described in step 20 below the generic procedure for IP address allocation in the U-plane specified in TS 36.508 subclause 4.5A.1 takes place performing IP address allocation in the U-plane if requested by the UE.	-	-	-	-
23	Check: Does the UE transmit an ATTACH COMPLETE message including the ACTIVATE DEFAULT EPS BEARER CONTEXT ACCEPT message?	-->	ATTACH COMPLETE	5	P
-	At the end of this test procedure sequence, the UE is in end state E-UTRA connected (E2) according to TS 36.508.	-	-	-	-

NOTE: It is assumed in the test procedure sequence that the UE initially has a valid GUTI, hence it is included in ATTACH REQUEST message in step 2. However, it is not important for the test procedure sequence.

9.2.1.2.2.3.3 Specific message contents

Table 9.2.1.2.2.3.3-1: Message ATTACH REQUEST (step 2, Table 9.2.1.2.2.3.2-1)

Derivation path: 36.508 table 4.7.2-4			
Information Element	Value/Remark	Comment	Condition
Old GUTI or IMSI	GUTI-1		
EPS attach type	010	"combined EPS/IMSI attach"	
ESM message container	PDN CONNECTIVITY REQUEST message		
Last visited registered TAI	TAI-1		
Old location area identification	LAI-1		
TMSI status	Not present		

Table 9.2.1.2.2.3.3-2: Message ATTACH ACCEPT (step 7, Table 9.2.1.2.2.3.2-1)

Derivation path: 36.508 table 4.7.2-1			
Information Element	Value/Remark	Comment	Condition
EPS attach result	001	"EPS only" The SS accepts Combined attach for EPS services only.	
ESM message container	ACTIVATE DEFAULT EPS BEARER CONTEXT REQUEST message		
GUTI	GUTI-2	The SS assigns a new GUTI	
LAI	Not present		
MS identity	Not Present	No TMSI is assigned	
EMM cause	00000010	#2 "IMSI unknown in HSS"	

Table 9.2.1.2.2.3.3-3: Message DETACH REQUEST (step 13, Table 9.2.1.2.2.3.2-1)

Derivation path: 36.508 table 4.7.2-12			
Information Element	Value/Remark	Comment	Condition
Detach type	001	"re-attach required"	

Table 9.2.1.2.2.3.3-4: Message ATTACH REQUEST (step 16, Table 9.2.1.2.2.3.2-1)

Derivation path: 36.508 table 4.7.2-4			
Information Element	Value/Remark	Comment	Condition
Old GUTI or IMSI	GUTI-2		
EPS attach type	001	"EPS attach"	
ESM message container	PDN CONNECTIVITY REQUEST message		
Last visited registered TAI	TAI-1		
Old location area identification	Not present		
TMSI status	Not present		

Table 9.2.1.2.2.3.3-5: Message ATTACH ACCEPT (step 17, Table 9.2.1.2.2.3.2-1)

Derivation path: 36.508 table 4.7.2-1			
Information Element	Value/Remark	Comment	Condition
EPS attach result	001	"EPS only "	
ESM message container	ACTIVATE DEFAULT EPS BEARER CONTEXT REQUEST message		
GUTI	Not present	The SS doesn't assign a new GUTI	

Table 9.2.1.2.2.3.3-6: Message ATTACH REQUEST (step 21, Table 9.2.1.2.2.3.2-1)

Derivation path: 36.508 table 4.7.2-4			
Information Element	Value/Remark	Comment	Condition
Old GUTI or IMSI	GUTI-2		
EPS attach type	010	"combined EPS/IMSI attach"	
ESM message container	PDN CONNECTIVITY REQUEST message		
Last visited registered TAI	TAI-1		
Old location area identification	Not present		
TMSI status	0	no valid TMSI available	

Table 9.2.1.2.2.3.3-7: Message ATTACH ACCEPT (step 22, Table 9.2.1.2.2.3.2-1)

Derivation path: 36.508 table 4.7.2-1			
Information Element	Value/Remark	Comment	Condition
EPS attach result	010	"Combined EPS/IMSI attach"	
ESM message container	ACTIVATE DEFAULT EPS BEARER CONTEXT REQUEST message		
GUTI	Not present	The SS doesn't assign a new GUTI	

9.2.1.2.3 Successful combined attach procedure / EPS service only / MSC temporarily not reachable

9.2.1.2.3.1 Test Purpose (TP)

(1)

```
with { the UE has sent a combined ATTACH REQUEST message }
ensure that {
  when { the UE receives an ATTACH ACCEPT message with EPS attach result set to "EPS only" and EMM reject cause set to "MSC temporarily not reachable" or "Network failure" and including an ACTIVATE DEFAULT EPS BEARER CONTEXT REQUEST message with IE EPS Bearer Identity matching the ATTACH REQUEST message and including a PDN address, an APN and an uplink TFT }
  then { UE transmits an ATTACH COMPLETE message, containing the EPS bearer identity, together with ACTIVATE DEFAULT EPS BEARER CONTEXT ACCEPT message and the UE resets the attach attempt counter and the UE increments tracking area updating attempt counter and starts timer T3411 and enters EMM-REGISTERED.ATTEMPTING-TO-UPDATE-MM state }
}
```

(2)

```
with { the UE is in E-UTRA EMM-REGISTERED.ATTEMPTING-TO-UPDATE-MM state }
ensure that {
  when { timer T3411 expires or timer T3402 expires }
  then { the UE initiates a combined tracking area update procedure indicating "combined TA/LA updating with IMSI attach" }
}
```

(3)

```
with { the UE is in E-UTRA EMM-REGISTERED.ATTEMPTING-TO-UPDATE-MM state }
ensure that {
  when { UE receives a TRACKING AREA UPDATE ACCEPT with EPS update result set to "EPS only" and EMM reject cause set to "MSC temporarily not reachable" or "Network failure" }
  then { UE increments tracking area updating attempt counter unless it was already set to 5 and starts timer T3411 if tracking area updating attempt counter is less than 5 or starts timer T3402 if tracking area updating attempt counter is equal to 5 }
}
```

9.2.1.2.3.2 Conformance requirements

References: The conformance requirements covered in the present TC are specified in: TS 24.301, clauses 5.5.1.2.4, 5.5.1.3.1, 5.5.1.3.2, 5.5.1.3.4.1, 5.5.1.3.4.2, 5.5.1.3.4.3, and 5.5.3.3.4.3.

[TS 24.301, clause 5.5.1.2.4]

If the attach request is accepted by the network, the MME shall send an ATTACH ACCEPT message to the UE and start timer T3450. The MME shall send the ATTACH ACCEPT message together with an ACTIVATE DEFAULT EPS BEARER CONTEXT REQUEST message contained in the ESM message container information element to activate the default bearer (see subclause 6.4.1). The network may also initiate the activation of dedicated bearers towards the UE by invoking the dedicated EPS bearer context activation procedure (see subclause 6.4.2).

If the attach request is accepted by the network, the MME shall delete the stored UE radio capability information, if any.

If the UE has included the UE network capability IE or the MS network capability IE or both in the ATTACH REQUEST message, the MME shall store all octets received from the UE, up to the maximum length defined for the respective information element.

NOTE: This information is forwarded to the new MME during inter-MME handover or to the new SGSN during inter-system handover to A/Gb mode or Iu mode.

The MME shall assign and include the TAI list the UE is registered to in the ATTACH ACCEPT message. The UE, upon receiving an ATTACH ACCEPT message, shall delete its old TAI list and store the received TAI list.

Upon receiving the ATTACH ACCEPT message, the UE shall stop timer T3410.

The GUTI reallocation may be part of the attach procedure. When the ATTACH REQUEST message includes the IMSI, or the MME considers the GUTI provided by the UE is invalid, or the GUTI provided by the UE was assigned by another MME, the MME shall allocate a new GUTI to the UE. The MME shall include in the ATTACH ACCEPT message the new assigned GUTI together with the assigned TAI list. In this case the MME shall enter state EMM-COMMON-PROCEDURE-INITIATED as described in subclause 5.4.1.

...

If the ATTACH ACCEPT message contains a GUTI, the UE shall use this GUTI as the new temporary identity. The UE shall delete its old GUTI and store the new assigned GUTI. If no GUTI has been included by the MME in the ATTACH ACCEPT message, the old GUTI, if any available, shall be kept.

If A/Gb mode or Iu mode is supported in the UE, the UE shall set its TIN to "GUTI" when receiving the ATTACH ACCEPT message.

...

When the UE receives the ATTACH ACCEPT message combined with the ACTIVATE DEFAULT EPS BEARER CONTEXT REQUEST message, it shall forward the ACTIVATE DEFAULT EPS BEARER CONTEXT REQUEST message to the ESM sublayer. Upon receipt of an indication from the ESM sublayer that the default EPS bearer context has been activated, the UE shall send an ATTACH COMPLETE message together with an ACTIVATE DEFAULT EPS BEARER CONTEXT ACCEPT message contained in the ESM message container information element to the network.

Additionally, the UE shall reset the attach attempt counter and tracking area updating attempt counter, enter state EMM-REGISTERED and set the EPS update status to EU1 UPDATED.

...

Upon receiving an ATTACH COMPLETE message, the MME shall stop timer T3450, enter state EMM-REGISTERED and consider the GUTI sent in the ATTACH ACCEPT message as valid.

[TS 24.301, clause 5.5.1.3.1]

The combined attach procedure is used by a UE in CS/PS mode 1 or CS/PS mode 2 of operation to attach for both EPS and non-EPS services.

The combined attach procedure is also used by a UE in CS/PS mode 1 or CS/PS mode 2 of operation to attach for EPS services if it is already IMSI attached for non-EPS services.

When the UE initiates a combined attach procedure, the UE shall indicate "combined EPS/IMSI attach" in the EPS attach type IE.

The combined attach procedure follows the attach procedure for EPS described in subclause 5.5.1.2.

[TS 24.301, clause 5.5.1.3.2]

If the UE is in EMM state EMM-DEREGISTERED, the UE initiates the combined attach procedure by sending an ATTACH REQUEST message to the network, starting timer T3410 and entering state EMM-REGISTERED-INITIATED (see example in figure 5.5.1.2.2.1).

The UE shall include the TMSI status IE if no valid TMSI is available. Furthermore, if the UE has stored a valid location area identification, the UE shall include it in the Old location area identification IE in the ATTACH REQUEST message.

[TS 24.301, clause 5.5.1.3.4.1]

Depending on the value of the EPS attach result IE received in the ATTACH ACCEPT message, two different cases can be distinguished:

- 1) The EPS attach result IE value indicates "combined EPS/IMSI attach": attach for EPS and non-EPS services have been successful.
- 2) The EPS attach result IE value indicates "EPS only": attach for EPS services has been successful but attach for non-EPS services has failed.

[TS 24.301, clause 5.5.1.3.4.2]

The description for attach for EPS services as specified in subclause 5.5.1.2.4 shall be followed. In addition, the following description for attach for non-EPS services applies.

...

[TS 24.301, clause 5.5.1.3.4.3]

Apart from the actions on the tracking area updating attempt counter, the description for attach for EPS services as specified in subclause 5.5.1.2.4 shall be followed. In addition, the following description for attach for non-EPS services applies.

The UE receiving the ATTACH ACCEPT message takes one of the following actions depending on the EMM cause value:

...

#16 (MSC temporarily not reachable);

#17 (Network failure); or

The UE shall stop timer T3410 if still running. The tracking area updating attempt counter shall be incremented, unless it was already set to 5.

If the tracking area updating attempt counter is less than 5:

- the UE shall start timer T3411, shall set the EPS update status to EU1 UPDATED and shall enter state EMM-REGISTERED.ATTEMPTING-TO-UPDATE-MM. When timer T3411 expires the combined tracking area updating procedure indicating "combined TA/LA updating with IMSI attach" is triggered.

If the tracking area updating attempt counter is equal to 5:

- a UE operating in CS/PS mode 2 of operation shall start timer T3402, shall set the EPS update status to EU1 UPDATED and shall enter state EMM-REGISTERED.ATTEMPTING-TO-UPDATE-MM. When timer T3402 expires the combined tracking area updating procedure indicating "combined TA/LA updating with IMSI attach" is triggered;

- a UE operating in CS/PS mode 1 of operation with "IMS voice not available" shall attempt to select GERAN or UTRAN radio access technology and proceed with appropriate MM or GMM specific procedures. The UE shall disable the E-UTRA capability (see subclause 4.5).

NOTE 1: It is up to the UE implementation when to enable E-UTRAN radio access technology selection.

...

Other EMM cause values and the case that no EMM cause IE was received are considered as abnormal cases. The combined attach procedure shall be considered as failed for EPS and non-EPS services. The behaviour of the UE in those cases is specified in subclause 5.5.1.3.6.

[TS 24.301, clause 5.5.3.3.4.3]

Apart from the actions on the tracking area updating attempt counter, the description for tracking area for EPS services as specified in subclause 5.5.3.2.4 shall be followed. In addition, the following description for location updating for non-EPS services applies.

The UE receiving the TRACKING AREA UPDATE ACCEPT message takes one of the following actions depending on the EMM cause value:

...

#16 (MSC temporarily not reachable);

#17 (Network failure); or

The UE shall stop timer T3430 if still running. The tracking area updating attempt counter shall be incremented, unless it was already set to 5.

If the tracking area updating attempt counter is less than 5:

- the UE shall start timer T3411, shall set the EPS update status to EU1 UPDATED and shall enter state EMM-REGISTERED.ATTEMPTING-TO-UPDATE-MM. When timer T3411 expires the combined tracking area updating procedure indicating "combined TA/LA updating with IMSI attach" is triggered again.

If the tracking area updating attempt counter is equal to 5:

- a UE operating in CS/PS mode 2 of operation shall start timer T3402, shall set the EPS update status to EU1 UPDATED and shall enter state EMM-REGISTERED.ATTEMPTING-TO-UPDATE-MM. When timer T3402 expires the combined tracking area updating procedure indicating "combined TA/LA updating with IMSI attach" is triggered again;
- a UE operating in CS/PS mode 1 of operation with "IMS voice not available" shall attempt to select GERAN or UTRAN radio access technology and proceed with appropriate MM or GMM specific procedures. The UE shall disable the E-UTRA capability (see subclause 4.5).

NOTE 1: It is up to the UE implementation when to enable E-UTRAN radio access technology selection.

...

9.2.1.2.3.3 Test description

9.2.1.2.3.3.1 Pre-test conditions

System Simulator:

- cell A.

Note: T3402 is set to default (12 min.).

UE:

- the UE is configured to initiate combined EPS/IMSI attach;

- the UE is previously registered on E-UTRAN, and when on E-UTRAN, the UE is last authenticated and registered on cell A using default message contents according to TS 36.508 [18].

Preamble:

- the UE is in state Switched OFF (state 1) according to TS 36.508 [18].

9.2.1.2.3.3.2 Test procedure sequence

The sequence is executed for execution counter k = 1, 2.

Table 9.2.1.2.3.3.2-1: Main behaviour

St	Procedure	Message Sequence		TP	Verdict
		U - S	Message		
1	The UE is switched on.	-	-	-	-
2	The UE transmits a combined ATTACH REQUEST message including a PDN CONNECTIVITY REQUEST message as specified.	-->	ATTACH REQUEST	-	-
3	The SS transmits an AUTHENTICATION REQUEST message to initiate the EPS authentication and AKA procedure.	<--	AUTHENTICATION REQUEST	-	-
4	The UE transmits an AUTHENTICATION RESPONSE message and establishes mutual authentication.	-->	AUTHENTICATION RESPONSE	-	-
5	The SS transmits a NAS SECURITY MODE COMMAND message to activate NAS security.	<--	SECURITY MODE COMMAND	-	-
6	The UE transmits a NAS SECURITY MODE COMPLETE message and establishes the initial security configuration.	-->	SECURITY MODE COMPLETE	-	-
-	EXCEPTION: Steps 6Aa1 to 6Aa2 describe behaviour that depends on UE configuration; the "lower case letter" identifies a step sequence that take place if the UE has ESM information which needs to be transferred.	-	-	-	-
6A a1	IF the UE sets the ESM information transfer flag in the last PDN CONNECTIVITY REQUEST message THEN the SS transmits an ESM INFORMATION REQUEST message to initiate exchange of protocol configuration options and/or APN.	<--	ESM INFORMATION REQUEST	-	-
6A a2	The UE transmits an ESM INFORMATION RESPONSE message to transfer protocol configuration options and/or APN.	-->	ESM INFORMATION RESPONSE	-	-
7	The SS transmits an ATTACH ACCEPT message with EPS attach result indicating "EPS only" and EMM cause indicating according to specific message contents and with IE EPS Bearer Identity set to default EPS bearer context. The ACTIVATE DEFAULT EPS BEARER CONTEXT REQUEST message is piggybacked in ATTACH ACCEPT. Note 1: SS allocates a PDN address of a PDN type which is compliant with from the PDN type requested by the UE.	<--	ATTACH ACCEPT	-	-
-	EXCEPTION: In parallel to the event described in step 8 below the generic procedure for IP address allocation in the U-plane specified in TS 36.508 subclause 4.5A.1 takes place performing IP address allocation in the U-plane if requested by the UE.	-	-	-	-
8	Check: Does the UE transmit an ATTACH COMPLETE message including a ACTIVATE DEFAULT EPS BEARER CONTEXT ACCEPT message as specified?	-->	ATTACH COMPLETE	1	P
9	The SS releases the RRC connection. Note: Tracking area updating attempt counter=1	-	-	-	-
10	Check1: Does the UE transmit a TRACKING AREA UPDATE REQUEST message with "combined TA/LA updating with IMSI attach"? Check2: Is the time between the previous	-->	TRACKING AREA UPDATE REQUEST	1,2	P

	ATTACH ACCEPT and TRACKING AREA UPDATE REQUEST equal to T3411?				
11	SS transmits a TRACKING AREA UPDATE ACCEPT message with EPS update result indicating "TA updated" and EMM cause indicating according to specific message contents.	<--	TRACKING AREA UPDATE ACCEPT	-	-
11 A	The SS releases the RRC connection. Note: Tracking area updating attempt counter=2	-	-	-	-
12	Check1: Does the UE transmit a TRACKING AREA UPDATE REQUEST message with "combined TA/LA updating with IMSI attach"? Check2: Is the time between the previous TRACKING AREA UPDATE ACCEPT and TRACKING AREA UPDATE REQUEST equal to T3411?	-->	TRACKING AREA UPDATE REQUEST	2,3	P
13	SS transmits a TRACKING AREA UPDATE ACCEPT message with EPS update result indicating "TA updated" and EMM cause indicating according to specific message contents.	<--	TRACKING AREA UPDATE ACCEPT	-	-
13 A	The SS releases the RRC connection. Note: Tracking area updating attempt counter=3	-	-	-	-
14	Check1: Does the UE transmit a TRACKING AREA UPDATE REQUEST message with "combined TA/LA updating with IMSI attach"? Check2: Is the time between the previous TRACKING AREA UPDATE ACCEPT and TRACKING AREA UPDATE REQUEST equal to T3411?	-->	TRACKING AREA UPDATE REQUEST	2,3	P
15	SS transmits a TRACKING AREA UPDATE ACCEPT message with EPS update result indicating "TA updated" and EMM cause indicating according to specific message contents	<--	TRACKING AREA UPDATE ACCEPT	-	-
15 A	The SS releases the RRC connection. Note: Tracking area updating attempt counter=4	-	-	-	-
16	Check1: Does the UE transmit a TRACKING AREA UPDATE REQUEST message with "combined TA/LA updating with IMSI attach"? Check2: Is the time between the previous TRACKING AREA UPDATE ACCEPT and TRACKING AREA UPDATE REQUEST equal to T3411?	-->	TRACKING AREA UPDATE REQUEST	2,3	P
-	EXCEPTION: Steps 17a1 to 17b2 describe behaviour that depends on UE configuration; the "lower case letter" identifies a step sequence that takes place according to UE mode of operation	-	-	-	-
17 a1	IF the UE is configured to operate in CS/PS mode 2, then SS transmits a TRACKING AREA UPDATE ACCEPT message with EPS update result indicating "TA updated" and EMM cause indicating according to specific message contents.	<--	TRACKING AREA UPDATE ACCEPT	-	-
17a 2	The SS releases the RRC connection. Note: Tracking area updating attempt counter=5	-	-	-	-
17a 3	Check1: Does the UE send TRACKING AREA UPDATE REQUEST message with "combined TA/LA updating with IMSI attach"? Check2: Is the time between the previous TRACKING AREA UPDATE ACCEPT and TRACKING AREA UPDATE REQUEST equal to T3402?	-->	TRACKING AREA UPDATE REQUEST	2,3	P

	Note: Tracking area updating attempt counter is reset				
17a 4	SS transmits a TRACKING AREA UPDATE ACCEPT message with EPS update result indicating "combined TA/LA updated " according to default message contents.	<--	TRACKING AREA UPDATE ACCEPT	-	-
17a 5	The UE transmits a TRACKING AREA UPDATE COMPLETE message	-->	TRACKING AREA UPDATE COMPLETE	-	-
17a 6	The SS releases the RRC connection.	-	-	-	-
17a 7	Check: Does the result of test procedure in 36.508 clause 6.4.2.4 indicate that the UE answer to paging with S-TMSI-1 (associated with GUTI-1) for PS domain?	-	-	3	-
-	At the end of this test procedure sequence, the UE is in end state E-UTRA idle (E1) according to TS 36.508.	-	-	-	-
17b 1	ELSE SS transmits a TRACKING AREA UPDATE ACCEPT message with EPS update result indicating "combined TA/LA updated".	<--	TRACKING AREA UPDATE ACCEPT	-	-
17b 2	The UE transmits a TRACKING AREA UPDATE COMPLETE message Note: Tracking area updating attempt counter is reset.	-->	TRACKING AREA UPDATE COMPLETE	-	-
-	At the end of this test procedure sequence, the UE is in end state E-UTRA connected (E2_T3440) according to TS 36.508.	-	-	-	-
18- 20	Void	-	-	-	-

9.2.1.2.3.3.3 Specific message contents

Table 9.2.1.2.3.3.3-1: Message ATTACH REQUEST (step 2, Table 9.2.1.2.3.3.2-1)

Derivation Path: TS 36.508 Table 4.7.2-4			
Information Element	Value/remark	Comment	Condition
EPS attach type	010	"combined EPS/IMSI attach"	
Old GUTI or IMSI	GUTI-1		
Last visited registered TAI	TAI-1		
Old location area identification	LAI-1		
TMSI status	Not present		

Table 9.2.1.2.3.3.3-2: Message ATTACH ACCEPT (step 7, Table 9.2.1.2.3.3.2-1)

Derivation Path: TS 36.508 Table 4.7.2-1			
Information Element	Value/remark	Comment	Condition
EPS attach result	001	"EPS only"	
GUTI	Not present		
Location area identification	Not present	SS doesn't provide LAI	
MS identity	Not Present	SS doesn't provide TMSI	
EMM cause	00010000 for k=1 or 00010001 for k=2	#16 (MSC temporarily not reachable) for k=1 #17 (Network failure) for k=2	

Table 9.2.1.2.3.3.3-3: Message TRACKING AREA UPDATE REQUEST (steps 10-12-14-16-17a3, Table 9.2.1.2.3.3.2-1)

Derivation Path: TS 36.508 Table 4.7.2-27			
Information Element	Value/remark	Comment	Condition
EPS update type	010	"combined TA/LA updating with IMSI attach"	
Old GUTI	GUTI-1		
Old P-TMSI signature	Not present	This IE is included when the UE holds a valid P-TMSI signature.	
Additional GUTI	Not present	TIN = 'GUTI'	
Last visited registered TAI	TAI-1		
Old location area identification	LAI-1		
TMSI status	Not present		

Table 9.2.1.2.3.3.3-4: Message TRACKING AREA UPDATE ACCEPT (steps 11-13-15, Table 9.2.1.2.3.3.2-1)

Derivation Path: TS 36.508 Table 4.7.2-24			
Information Element	Value/remark	Comment	Condition
EPS update result	000	"TA updated" SS accepts Combined TAU for EPS services only.	
GUTI	Not present		
Location area identification	Not present	SS doesn't provide LAI	
MS identity	Not Present	SS doesn't provide TMSI	
EMM cause	00010000 for k=1 or 00010001 for k=2	#16 (MSC temporarily not reachable) for k=1 #17 (Network failure) for k=2	

Table 9.2.1.2.3.3.3-5: Message TRACKING AREA UPDATE ACCEPT (steps 17a1, Table 9.2.1.2.3.3.2-1)

Derivation Path: TS 36.508 Table 4.7.2-24			
Information Element	Value/remark	Comment	Condition
EPS update result	000	"TA updated" SS accepts Combined TAU for EPS services only.	
GUTI	Not present		
Location area identification	Not present	SS doesn't provide LAI	
MS identity	Not Present	SS doesn't provide TMSI	
EMM cause	00010000 for k=1 or 00010001 for k=2	#16 (MSC temporarily not reachable) for k=1 #17 (Network failure) for k=2	
T3402	'000 01111'B	30 seconds	

9.2.1.2.4 Successful combined attach procedure / EPS service only / CS domain not available

9.2.1.2.4.1 Test Purpose (TP)

(1)

```
with { UE is switched-off }
ensure that {
  when { UE is powered on and a valid GUTI is available }
  then { the UE transmits an ATTACH REQUEST message with the EPS attach type set to "combined
EPS/IMSI attach", including GUTI, last visited registered TAI and a PDN CONNECTIVITY REQUEST message
with the request type set to "initial attach" }
}
```

(2)

```
with { UE has sent a combined ATTACH REQUEST message including a PDN CONNECTIVITY REQUEST message }
ensure that {
  when { UE receives an ATTACH ACCEPT message including EPS attach result set to "EPS only" and EMM
reject cause set to "CS domain not available" and including an ACTIVATE DEFAULT EPS BEARER CONTEXT
REQUEST message with IE EPS Bearer Identity matching the PDN CONNECTIVITY REQUEST message }
  then { UE transmits ATTACH COMPLETE message, containing the EPS bearer identity, including an
ACTIVATE DEFAULT EPS BEARER CONTEXT ACCEPT message and sets the update status to U2 NOT UPDATED and
enters EMM-REGISTERED state }
}
```

(3)

```
with { The UE received an ATTACH ACCEPT message with EPS attach result set to "EPS only" and EMM
cause set to "CS domain not available" }
ensure that {
  when { UE enters a TA where it is not registered and which belongs to the PLMN where the UE
received the EMM cause "CS domain not available" }
  then { UE initiates a normal tracking area update procedure indicating "TA updating" without
valid LAI, TMSI, GSM ciphering key, UMTS integrity key, UMTS ciphering key or ciphering key sequence
number }
}
```

(4)

```
with { The UE received an ATTACH ACCEPT message with EPS attach result set to "EPS only" and EMM
cause set to "CS domain not available" }
ensure that {
  when { UE is powered up or switched on }
  then { UE initiates a combined attach procedure indicating "combined EPS/IMSI attach" }
}
```

9.2.1.2.4.2 Conformance requirements

References: The conformance requirements covered in the present TC are specified in: TS 24.301, clauses 5.5.1.2.4, 5.5.1.3.1, 5.5.1.3.2, 5.5.1.3.4.1, 5.5.1.3.4.2 and 5.5.1.3.4.3, and TS 24.008, clause 4.1.2.2.

[TS 24.301, clause 5.5.1.2.4]

If the attach request is accepted by the network, the MME shall send an ATTACH ACCEPT message to the UE and start timer T3450. The MME shall send the ATTACH ACCEPT message together with an ACTIVATE DEFAULT EPS BEARER CONTEXT REQUEST message contained in the ESM message container information element to activate the default bearer (see subclause 6.4.1). The network may also initiate the activation of dedicated bearers towards the UE by invoking the dedicated EPS bearer context activation procedure (see subclause 6.4.2).

If the attach request is accepted by the network, the MME shall delete the stored UE radio capability information, if any.

If the UE has included the UE network capability IE or the MS network capability IE or both in the ATTACH REQUEST message, the MME shall store all octets received from the UE, up to the maximum length defined for the respective information element.

NOTE: This information is forwarded to the new MME during inter-MME handover or to the new SGSN during inter-system handover to A/Gb mode or Iu mode.

The MME shall assign and include the TAI list the UE is registered to in the ATTACH ACCEPT message. The UE, upon receiving an ATTACH ACCEPT message, shall delete its old TAI list and store the received TAI list.

Upon receiving the ATTACH ACCEPT message, the UE shall stop timer T3410.

The GUTI reallocation may be part of the attach procedure. When the ATTACH REQUEST message includes the IMSI, or the MME considers the GUTI provided by the UE is invalid, or the GUTI provided by the UE was assigned by another MME, the MME shall allocate a new GUTI to the UE. The MME shall include in the ATTACH ACCEPT message the new assigned GUTI together with the assigned TAI list. In this case the MME shall enter state EMM-COMMON-PROCEDURE-INITIATED as described in subclause 5.4.1.

...

If the ATTACH ACCEPT message contains a GUTI, the UE shall use this GUTI as the new temporary identity. The UE shall delete its old GUTI and store the new assigned GUTI. If no GUTI has been included by the MME in the ATTACH ACCEPT message, the old GUTI, if any available, shall be kept.

If A/Gb mode or Iu mode is supported in the UE, the UE shall set its TIN to "GUTI" when receiving the ATTACH ACCEPT message.

...

When the UE receives the ATTACH ACCEPT message combined with the ACTIVATE DEFAULT EPS BEARER CONTEXT REQUEST message, it shall forward the ACTIVATE DEFAULT EPS BEARER CONTEXT REQUEST message to the ESM sublayer. Upon receipt of an indication from the ESM sublayer that the default EPS bearer context has been activated, the UE shall send an ATTACH COMPLETE message together with an ACTIVATE DEFAULT EPS BEARER CONTEXT ACCEPT message contained in the ESM message container information element to the network.

Additionally, the UE shall reset the attach attempt counter and tracking area updating attempt counter, enter state EMM-REGISTERED and set the EPS update status to EU1 UPDATED.

...

Upon receiving an ATTACH COMPLETE message, the MME shall stop timer T3450, enter state EMM-REGISTERED and consider the GUTI sent in the ATTACH ACCEPT message as valid.

[TS 24.301, clause 5.5.1.3.1]

The combined attach procedure is used by a UE in CS/PS mode 1 or CS/PS mode 2 of operation to attach for both EPS and non-EPS services.

The combined attach procedure is also used by a UE in CS/PS mode 1 or CS/PS mode 2 of operation to attach for EPS services if it is already IMSI attached for non-EPS services.

When the UE initiates a combined attach procedure, the UE shall indicate "combined EPS/IMSI attach" in the EPS attach type IE.

The combined attach procedure follows the attach procedure for EPS described in subclause 5.5.1.2.

[TS 24.301, clause 5.5.1.3.2]

...

The UE shall include the TMSI status IE if no valid TMSI is available. Furthermore, if the UE has stored a valid location area identification, the UE shall include it in the Old location area identification IE in the ATTACH REQUEST message.

[TS 24.301, clause 5.5.1.3.4.1]

Depending on the value of the EPS attach result IE received in the ATTACH ACCEPT message, two different cases can be distinguished:

- 1) The EPS attach result IE value indicates "combined EPS/IMSI attach": attach for EPS and non-EPS services have been successful.

- 2) The EPS attach result IE value indicates "EPS only": attach for EPS services has been successful but attach for non-EPS services has failed.

[TS 24.301, clause 5.5.1.3.4.2]

The description for attach for EPS services as specified in subclause 5.5.1.2.4 shall be followed. In addition, the following description for attach for non-EPS services applies.

...

[TS 24.301, clause 5.5.1.3.4.3]

Apart from the actions on the tracking area updating attempt counter, the description for attach for EPS services as specified in subclause 5.5.1.2.4 shall be followed. In addition, the following description for attach for non-EPS services applies.

The UE receiving the ATTACH ACCEPT message takes one of the following actions depending on the EMM cause value:

...

#18 (CS domain not available)

The UE shall stop timer T3410 if still running, shall reset the tracking area updating attempt counter, shall set the EPS update status to EU1 UPDATED and shall enter state EMM-REGISTERED.NORMAL-SERVICE.

The UE shall set the update status to U2 NOT UPDATED.

A UE in CS/PS mode 1 of operation with "IMS voice not available" shall attempt to select GERAN or UTRAN radio access technology rather than E-UTRAN for the selected PLMN or equivalent PLMN. The UE shall disable the E-UTRA capability (see subclause 4.5). If the UE is in the EMM-CONNECTED mode, the UE shall locally release the established NAS signalling connection and enter the EMM-IDLE mode before selecting GERAN or UTRAN radio access technology.

A UE in CS/PS mode 2 of operation may provide a notification to the user or the upper layers that the CS domain is not available.

...

The UE shall not attempt combined attach or combined tracking area update procedure with current PLMN until switching off the UE or the UICC containing the USIM is removed.

Other EMM cause values and the case that no EMM cause IE was received are considered as abnormal cases. The combined attach procedure shall be considered as failed for EPS and non-EPS services. The behaviour of the UE in those cases is specified in subclause 5.5.1.3.6.

[TS 24.008, clause 4.1.2.2]

In parallel with the sublayer states described in subclause 4.1.2.1 and which control the MM sublayer protocol, an update status exists.

The update status pertains to a specific subscriber embodied by a SIM/USIM. This status is defined even when the subscriber is not activated (SIM/USIM removed or connected to a switched-off ME). It is stored in a non volatile memory in the SIM/USIM. The update status is changed only as a result of a location updating procedure attempt (with the exception of an authentication failure and of some cases of CM service rejection). In some cases, the update status is changed as a result of a GPRS attach, GPRS routing area update, service request or network initiated GPRS detach procedure.

...

U2 NOT UPDATED

The last location updating attempt made failed procedurally (no significant answer was received from the network, including the cases of failures or congestion inside the network).

For this status, the SIM/USIM does not contain any valid LAI, TMSI, GSM ciphering key, UMTS integrity key, UMTS ciphering key or ciphering key sequence number. For compatibility reasons, all these fields must be set to the "deleted" value at the moment the status is set to NOT UPDATED. However the presence of other values shall not be considered an error by the mobile station. The "Location update status" stored on the SIM/USIM shall be "not updated".

...

9.2.1.2.4.3 Test description

9.2.1.2.4.3.1 Pre-test conditions

System Simulator:

- cell A (TAI-1, home PLMN) and cell B (TAI-2, home PLMN).
- System information combination 3 as defined in TS 36.508[18] clause 4.4.3.1 is used in E-UTRA cells;

UE:

- the UE is configured to initiate combined EPS/IMSI attach;
- the UE is previously registered on E-UTRAN, and when on E-UTRAN, the UE is last authenticated and registered on cell A using default message contents according to TS 36.508 [18].

Preamble:

- the UE is in state Switched OFF (state 1) according to TS.36.508 [18].

9.2.1.2.4.3.2 Test procedure sequence

Table 9.2.1.2.4.3.2-1: Main Behaviour

St	Procedure	Message Sequence		TP	Verdict
		U - S	Message		
1	Set the cell type of cell A to the "Serving cell" Set the cell type of cell B to the "Non-suitable cell"	-	-	-	-
-	The following messages are to be observed on Cell A unless explicitly stated otherwise.	-	-	-	-
2	The UE is switched on.	-	-	-	-
3	Check : Does the UE transmit a combined ATTACH REQUEST message including a PDN CONNECTIVITY REQUEST message?	-->	ATTACH REQUEST	1	P
4	The SS transmits an AUTHENTICATION REQUEST message to initiate the EPS authentication and AKA procedure.	<--	AUTHENTICATION REQUEST	-	-
5	The UE transmits an AUTHENTICATION RESPONSE message and establishes mutual authentication.	-->	AUTHENTICATION RESPONSE	-	-
6	The SS transmits a NAS SECURITY MODE COMMAND message to activate NAS security.	<--	SECURITY MODE COMMAND	-	-
7	The UE transmits a NAS SECURITY MODE COMPLETE message and establishes the initial security configuration.	-->	SECURITY MODE COMPLETE	-	-
-	EXCEPTION: Steps 7Aa1 to 7Aa2 describe behaviour that depends on UE configuration; the "lower case letter" identifies a step sequence that take place if the UE has ESM information which needs to be transferred.	-	-	-	-
7A a1	IF the UE sets the ESM information transfer flag in the last PDN CONNECTIVITY REQUEST message THEN the SS transmits an ESM INFORMATION REQUEST message to initiate exchange of protocol configuration options and/or APN.	<--	ESM INFORMATION REQUEST	-	-
7A a2	The UE transmits an ESM INFORMATION RESPONSE message to transfer protocol configuration options and/or APN.	-->	ESM INFORMATION RESPONSE	-	-
8	SS responds with ATTACH ACCEPT message with IE EPS Bearer Identity set to default EPS bearer context. The ACTIVATE DEFAULT EPS BEARER CONTEXT REQUEST message is piggybacked in ATTACH ACCEPT.	<--	ATTACH ACCEPT	-	-
-	EXCEPTION: In parallel to the event described in step 9 below the generic procedure for IP address allocation in the U-plane specified in TS 36.508 subclause 4.5A.1 takes place performing IP address allocation in the U-plane if requested by the UE.	-	-	-	-
-	EXCEPTION: In parallel to the event described in step 9 below the generic procedure for IMS signalling in the U-plane specified in TS 36.508 subclause 4.5A.3 takes place if requested by the UE	-	-	-	-
9	Check: Does the UE transmit an ATTACH COMPLETE message including a ACTIVATE DEFAULT EPS BEARER CONTEXT ACCEPT message as specified?	-->	ATTACH COMPLETE	2	P
10	The SS releases the RRC connection.	-	-	-	-
10 A	Wait 15 seconds for UE to camp on Cell A (UE might attempt to select GERAN or UTRAN cells)	-	-	-	-
11	Check: Does the test result of generic test procedure in TS 36.508 subclause 6.4.2.2	-	-	2	-

	indicate that the UE is in E-UTRA RRC_IDLE state on Cell A ?				
12	Set the cell type of cell B to the "Serving cell" Set the cell type of cell A to the "Non-suitable cell"	-	-	-	-
-	The following messages are to be observed on Cell B unless explicitly stated otherwise.	-	-	-	-
13	Check: Does the UE transmit TRACKING AREA UPDATE REQUEST message?	-->	TRACKING AREA UPDATE REQUEST	3	P
14	SS responds with TRACKING AREA UPDATE ACCEPT message	<--	TRACKING AREA UPDATE ACCEPT	-	-
15	UE sends TRACKING AREA UPDATE COMPLETE	-->	TRACKING AREA UPDATE COMPLETE	-	-
16	If possible (see ICS) switch off is performed or the USIM is removed. Otherwise the power is removed.	-	-	-	-
-	EXCEPTION: Step 16a describes behaviour that depends on the UE capability.				
16a	If pc_SwitchOnOff or pc_USIM_Removal then UE sends DETACH REQUEST message	-->	DETACH REQUEST		
17	The UE is brought back to operation or the USIM is inserted.	-	-	-	-
18	Check : Does the UE transmit a combined ATTACH REQUEST message including a PDN CONNECTIVITY REQUEST message?	-->	ATTACH REQUEST	4	P
19	SS responds with ATTACH ACCEPT message with IE EPS Bearer Identity set to default EPS bearer context. The ACTIVATE DEFAULT EPS BEARER CONTEXT REQUEST message is piggybacked in ATTACH ACCEPT.	<--	ATTACH ACCEPT	-	-
-	EXCEPTION: In parallel to the event described in step 20 below the generic procedure for IP address allocation in the U-plane specified in TS 36.508 subclause 4.5A.1 takes place performing IP address allocation in the U-plane if requested by the UE.	-	-	-	-
20	Check: Does the UE transmit an ATTACH COMPLETE message including a ACTIVATE DEFAULT EPS BEARER CONTEXT ACCEPT message as specified?	-->	ATTACH COMPLETE	-	-
-	At the end of this test procedure sequence, the UE is in end state E-UTRA connected (E2) according to TS 36.508 but attached for EPS services only.	-	-	-	-

9.2.1.2.4.3.3 Specific message contents

Table 9.2.1.2.4.3.3-1: Message ATTACH REQUEST (step 3, Table 9.2.1.2.4.3.2-1)

Derivation Path: TS 36.508 Table 4.7.2-4			
Information Element	Value/remark	Comment	Condition
EPS attach type	010	"combined EPS/IMSI attach"	
Old GUTI or IMSI	GUTI-1		
Last visited registered TAI	TAI-1		
Old location area identification	LAI-1		
TMSI status	Not present		

Table 9.2.1.2.4.3.3-2: Message ATTACH ACCEPT (step 8, Table 9.2.1.2.4.3.2-1)

Derivation Path: TS 36.508 Table 4.7.2-1			
Information Element	Value/remark	Comment	Condition
EPS attach result	001	"EPS only"	
GUTI	Not Present		
Location area identification	Not present	SS doesn't provide LAI	
MS identity	Not Present	SS doesn't provide TMSI	
EMM cause	00010010	#18 "CS domain not available"	

Table 9.2.1.2.4.3.3-3: Message TRACKING AREA UPDATE REQUEST (step 13, Table 9.2.1.2.4.3.2-1)

Derivation Path: TS 36.508 Table 4.7.2-27			
Information Element	Value/remark	Comment	Condition
EPS update type	000	TA updating	
Old GUTI	GUTI-1		
Last visited registered TAI	TAI-1	If available, the last TAI is included by UE and will be used to establish a good list of TAIs in subsequent ATTACH ACCEPT message.	
Old location area identification	Not present	Entering in U2 NOT UPDATED state, UE deletes LAI	
TMSI status	Not present		

Table 9.2.1.2.4.3.3-4: Message TRACKING AREA UPDATE ACCEPT (step 14, Table 9.2.1.2.4.3.2-1)

Derivation Path: TS 36.508 Table 4.7.2-24			
Information Element	Value/remark	Comment	Condition
EPS update result	000	"TA only"	
GUTI	GUTI-2		
Location area identification	Not present	SS doesn't provide LAI	
MS identity	Not Present	SS doesn't provide TMSI	
EMM cause	00010010	#18 "CS domain not available"	

Table 9.2.1.2.4.3.3-5: Message ATTACH REQUEST (step 18, Table 9.2.1.2.4.3.2-1)

Derivation Path: TS 36.508 Table 4.7.2-4			
Information Element	Value/remark	Comment	Condition
EPS attach type	010	"combined EPS/IMSI attach"	
Old GUTI or IMSI	GUTI-2		
Last visited registered TAI	TAI-2		
Old location area identification	Not present		
TMSI status	0	"no valid TMSI available"	

Table 9.2.1.2.4.3.3-6: Message ATTACH ACCEPT (step 19, Table 9.2.1.2.4.3.2-1)

Derivation Path: TS 36.508 Table 4.7.2-1			
Information Element	Value/remark	Comment	Condition
EPS attach result	010	"Combined EPS/IMSI attach"	
GUTI	GUTI-2		
Location area identification	LAI-2		
MS identity	TMSI-2		

9.2.1.2.5 Combined attach / Rejected / IMSI invalid

9.2.1.2.5.1 Test Purpose (TP)

(1)

```
with { UE has sent an ATTACH REQUEST message }
ensure that {
  when { UE receives an ATTACH REJECT message with the EMM cause set to 'Illegal UE' }
  then { UE deletes GUTI, last visited registered TAI and KSI and considers the USIM as invalid
for EPS services and non-EPS services and enters state EMM-DEREGISTERED }
}
```

(2)

```
with { UE has sent an ATTACH REQUEST message }
ensure that {
  when { UE receives an ATTACH REJECT message with the EMM cause set to 'Illegal UE' }
  then { UE deletes P-TMSI, P-TMSI signature, RAI, GPRS ciphering key sequence number, TMSI, LAI
and ciphering key sequence number }
}
```

9.2.1.2.5.2 Conformance requirements

References: The conformance requirements covered in the present TC are specified in: TS 24.301, clause 5.5.1.3.5 and TS 24.008, clause 4.7.3.2.4.

[TS 24.301, clause 5.5.1.3.5]

Upon receiving the ATTACH REJECT message, the UE shall stop timer T3410, enter MM state MM IDLE, and take the following actions depending on the EMM cause value received.

#3 (Illegal UE);

...

The UE shall set the EPS update status to EU3 ROAMING NOT ALLOWED (and shall store it according to subclause 5.1.3.3) and shall delete any GUTI, last visited registered TAI and eKSI.

The UE shall consider the USIM as invalid for EPS and non-EPS services until switching off or the UICC containing the USIM is removed. Additionally, the UE shall delete the list of equivalent PLMNs and shall enter the state EMM-DEREGISTERED.

If A/Gb mode or Iu mode is supported by the UE, the UE shall in addition handle the MM parameters update status, TMSI, LAI and ciphering key sequence number, and the GMM parameters GMM state, GPRS update status, P-TMSI, P-TMSI signature, RAI and GPRS ciphering key sequence number as specified in 3GPP TS 24.008 [13] for the case when the combined attach procedure is rejected with the GMM cause with the same value.

[TS 24.008, clause 4.7.3.2.4]

The MS shall then take one of the following actions depending upon the reject cause:

3 (Illegal MS);

...

The MS shall set the GPRS update status to GU3 ROAMING NOT ALLOWED (shall store it according to subclause 4.1.3.2) and shall delete any P-TMSI, P-TMSI signature, RAI and GPRS ciphering key sequence number. The new GMM state is GMM-DEREGISTERED. The new MM state is MM IDLE.

The MS shall set the update status to U3 ROAMING NOT ALLOWED, shall delete any TMSI, LAI and ciphering key sequence number. The SIM/USIM shall be considered as invalid for GPRS and non-GPRS services until switching off or the SIM/USIM is removed.

9.2.1.2.5.3 Test description

9.2.1.2.5.3.1 Pre-test conditions

System Simulator:

- cell A and cell B;
- if pc_UTRA AND px_RATComb_Tested = EUTRA_UTRA, cell 5 (, LAI-1 and RAI-1;home PLMN) ;
- if pc_GERAN AND px_RATComb_Tested = EUTRA_GERAN, Cell 24 (, LAI-1 and RAI-1.home PLMN);
- System information combination 10a as defined in TS 36.508[18] clause 4.4.3.1 is used in E-UTRA cells.

Note: Setting px_RATComb_Tested = EUTRA_Only is not allowed.

UE:

- the UE is configured to initiate combined EPS/IMSI attach;
- the UE is previously registered on E-UTRAN, and when on E-UTRAN, the UE is last authenticated and registered on cell A using default message contents according to TS 36.508 [18];
- if pc_UTRA AND px_RATComb_Tested = EUTRA_UTRA, the UE is previously registered on UTRAN cell 5 using default message contents according to TS 36.508 [18].
- if pc_GERAN AND px_RATComb_Tested = EUTRA_GERAN, the UE is previously registered on GERAN cell 24 using default message contents according to TS 36.508 [18].

Preamble:

- the UE is in state Switched OFF (state 1) according to TS 36.508 [18].

9.2.1.2.5.3.2 Test procedure sequence

Table 9.2.1.2.5.3.2-1: Main behaviour

St	Procedure	Message Sequence		TP	Verdict
		U - S	Message		
1	The SS configures: - Cell A as the "Serving cell", - Cell B as a "Non-Suitable cell", - Cell 5 or Cell 24 as a "Non-Suitable cell".	-	-	-	-
-	The following messages are to be observed on Cell A unless explicitly stated otherwise.	-	-	-	-
2	The UE is switched on.	-	-	-	-
3	The UE transmits an ATTACH REQUEST message including a PDN CONNECTIVITY REQUEST message.	-->	ATTACH REQUEST	-	-
4	The SS transmits an ATTACH REJECT message with the EMM cause set to 'Illegal UE'.	<--	ATTACH REJECT	-	-
5	The SS releases the RRC connection.	-	-	-	-
6	The SS configures: - Cell A as a "Non-Suitable cell". - Cell B as the "Serving cell".	-	-	-	-
7	Check: Does the UE transmit an ATTACH REQUEST message in the next 30 seconds on Cell B or on Cell A?	-->	ATTACH REQUEST	1	F
-	EXCEPTION: Steps 8a1 to 8a6 describe behaviour that depends on the UE capability; the "lower case letter" identifies a step sequence that take place if a capability is supported	-	-	-	-
8a1	The SS configures: - Cell B as a "Non-Suitable cell", - Cell 5 (px_RATComb_Tested = EUTRA_UTRA) or Cell 24 (px_RATComb_Tested = EUTRA_GERAN) as the "Serving cell".	-	-	-	-
-	The following messages are to be observed on Cell 5 or Cell 24 unless explicitly stated otherwise.	-	-	-	-
8a2	Void	-	-	-	-
8a3	Check: Does the UE transmit an ATTACH REQUEST message in the next 30 seconds?	-->	ATTACH REQUEST	1	F
8a4	If possible (see ICS) switch off is performed or the USIM is removed. Otherwise the power is removed.	-	-	-	-
8a5	The UE is brought back to operation or the USIM is inserted.	-	-	-	-
-	EXCEPTION: Steps 8a5a1, 8a5a2 describe behaviour that depends on the UE capability; the "lower case letter" identifies a step sequence that take place if pc_AutomaticAttachSwitchON is NOT supported	-	-	-	-
8a5A a1	IF NOT pc_AutomaticAttachSwitchON	-	Registration on CS	-	-
8a5A a2	IF NOT pc_AutomaticAttachSwitchON the user initiates an attach by MMI or by AT command.	-	-	-	-
8a6	Check: Does the UE transmit an ATTACH REQUEST message?	-->	ATTACH REQUEST	2	P
8b1	Void	-	-	-	-
9	Void	-	-	-	-
10	The SS configures: - Cell A as the "Serving cell", - Cell B as a "Non-Suitable cell", - Cell 5 or Cell 24 as a "Cell Off".	-	-	-	-
-	The following messages are to be observed on	-	-	-	-

	Cell A unless explicitly stated otherwise.				
-	Void				
11	Void	-	-	-	-
11a1	Void	-	-	-	-
12	Check: Does the UE transmit an ATTACH REQUEST message?	-->	ATTACH REQUEST	1	P
13-14	Void	-	-	-	-
15a1-15a9	Void	-	-	-	-
16-27	The attach procedure is completed by executing steps 5 to 16 of the UE registration procedure in TS 36.508 sub clause 4.5.2.3.	-	-	-	-
-	At the end of this test procedure sequence, the UE is in end state E-UTRA connected (E2) according to TS 36.508.	-	-	-	-
Note 1: Void.					
Note 2: Switching off, USIM removal, or power removal shall be done before T3310 and T3311 expire (30 seconds) so that the UE does not retransmit ATTACH REQUEST message.					

9.2.1.2.5.3.3 Specific message contents

Table 9.2.1.2.5.3.3-1: Message ATTACH REJECT (step 4, Table 9.2.1.2.5.3.2-1)

Derivation Path: TS 36.508 Table 4.7.2-3			
Information Element	Value/remark	Comment	Condition
EMM cause	'0000 0011'B	Illegal UE	

Table 9.2.1.2.5.3.3-2: Message ATTACH REQUEST (step 12, Table 9.2.1.2.5.3.2-1)

Derivation Path: TS 36.508, Table 4.7.2-4			
Information Element	Value/remark	Comment	Condition
NAS key set identifier			
NAS key set identifier	'111'B	no key is available	
TSC	Any allowed value	TSC does not apply for NAS key set identifier value "111".	
Old GUTI or IMSI	IMSI-1		
Last visited registered TAI	Not present		
Old location area identification	Not present		
TMSI status	'0'B	no valid TMSI available	

Table 9.2.1.2.5.3.3-3: Message ATTACH REQUEST (step 8a6, Table 9.2.1.2.5.3.2-1)

Derivation Path: TS 24.008 , Table 9.4.1			
Information Element	Value/remark	Comment	Condition
MS network capability	Any allowed value		
Attach type	'011'B	Combined GPRS/IMSI attach	
GPRS ciphering key sequence number	'111'B	No key is available (MS to network)	
DRX parameter	Any allowed value		
P-TMSI or IMSI	IMSI-1		
Old routing area identification	All bits of octets 5 and 6 are set to 1, except bit 1 of octet 6 which is set to 0. Other bits are not checked.		
MS Radio Access capability	Any allowed value		
Old P-TMSI signature	Not present		
Requested READY timer value	Not present or any allowed value		
TMSI status	'0'B	no valid TMSI available	
PS LCS Capability	Not present or any allowed value		
Mobile station classmark 2	Not present or any allowed value		
Mobile station classmark 3	Not present or any allowed value		
Supported Codecs	Not present or any allowed value		
UE network capability	Not present or any allowed value		
Additional mobile identity	Not present		
Additional old routing area identification	Not present		

9.2.1.2.6 Combined attach / Rejected / Illegal ME

9.2.1.2.6.1 Test Purpose (TP)

(1)

```
with { UE has sent an ATTACH REQUEST message }
ensure that {
  when { UE receives an ATTACH REJECT message with the EMM cause set to 'Illegal ME' }
  then { UE deletes GUTI, last visited registered TAI and KSI and considers the USIM as invalid
for EPS services and non-EPS services and enters state EMM-DEREGISTERED }
}
```

(2)

```
with { UE has sent an ATTACH REQUEST message }
ensure that {
  when { UE receives an ATTACH REJECT message with the EMM cause set to 'Illegal ME' }
  then { UE deletes P-TMSI, P-TMSI signature, RAI, GPRS ciphering key sequence number, TMSI, LAI
and ciphering key sequence number }
}
```

9.2.1.2.6.2 Conformance requirements

References: The conformance requirements covered in the present TC are specified in: TS 24.301, clause 5.5.1.3.5 and TS 24.008, clause 4.7.3.2.4.

[TS 24.301, clause 5.5.1.3.5]

Upon receiving the ATTACH REJECT message, the UE shall stop timer T3410, enter MM state MM IDLE, and take the following actions depending on the EMM cause value received.

...

#6 (Illegal ME); or

...

The UE shall set the EPS update status to EU3 ROAMING NOT ALLOWED (and shall store it according to subclause 5.1.3.3) and shall delete any GUTI, last visited registered TAI and eKSI.

The UE shall consider the USIM as invalid for EPS and non-EPS services until switching off or the UICC containing the USIM is removed. Additionally, the UE shall delete the list of equivalent PLMNs and shall enter the state EMM-DEREGISTERED.

If A/Gb mode or Iu mode is supported by the UE, the UE shall in addition handle the MM parameters update status, TMSI, LAI and ciphering key sequence number, and the GMM parameters GMM state, GPRS update status, P-TMSI, P-TMSI signature, RAI and GPRS ciphering key sequence number as specified in 3GPP TS 24.008 [13] for the case when the combined attach procedure is rejected with the GMM cause with the same value.

[TS 24.008, clause 4.7.3.2.4]

The MS shall then take one of the following actions depending upon the reject cause:

...

6 (Illegal ME), or

...

The MS shall set the GPRS update status to GU3 ROAMING NOT ALLOWED (shall store it according to subclause 4.1.3.2) and shall delete any P-TMSI, P-TMSI signature, RAI and GPRS ciphering key sequence number. The new GMM state is GMM-DEREGISTERED. The new MM state is MM IDLE.

The MS shall set the update status to U3 ROAMING NOT ALLOWED, shall delete any TMSI, LAI and ciphering key sequence number. The SIM/USIM shall be considered as invalid for GPRS and non-GPRS services until switching off or the SIM/USIM is removed.

9.2.1.2.6.3 Test description

The test description is identical to the one of subclause 9.2.1.2.5 except that the reject cause #3 "illegal UE" is replaced with reject cause #6 "Illegal ME"

9.2.1.2.7 Combined attach / Rejected / EPS services and non-EPS services not allowed

9.2.1.2.7.1 Test Purpose (TP)

(1)

```
with { UE has sent an ATTACH REQUEST message }
ensure that {
  when { UE receives an ATTACH REJECT message with the EMM cause set to 'EPS services and non-EPS
services not allowed' }
  then { UE deletes GUTI, last visited registered TAI and KSI and considers the USIM as invalid
for EPS services and non-EPS services and enters state EMM-DEREGISTERED }
}
```

(2)

```
with { UE has sent an ATTACH REQUEST }
ensure that {
  when { UE receives an ATTACH REJECT message with the EMM cause set to 'EPS services and non-EPS
services not allowed' }
  then { UE deletes P-TMSI, P-TMSI signature, RAI, GPRS ciphering key sequence number, TMSI, LAI
and ciphering key sequence number }
}
```

9.2.1.2.7.2 Conformance requirements

References: The conformance requirements covered in the present TC are specified in: TS 24.301, clause 5.5.1.3.5 and TS 24.008, clause 4.7.3.2.4.

[TS 24.301, clause 5.5.1.3.5]

Upon receiving the ATTACH REJECT message, the UE shall stop timer T3410, enter MM state MM IDLE, and take the following actions depending on the EMM cause value received.

...

#8 (EPS services and non-EPS services not allowed);

The UE shall set the EPS update status to EU3 ROAMING NOT ALLOWED (and shall store it according to subclause 5.1.3.3) and shall delete any GUTI, last visited registered TAI and eKSI.

The UE shall consider the USIM as invalid for EPS and non-EPS services until switching off or the UICC containing the USIM is removed. Additionally, the UE shall delete the list of equivalent PLMNs and shall enter the state EMM-DEREGISTERED.

If A/Gb mode or Iu mode is supported by the UE, the UE shall in addition handle the MM parameters update status, TMSI, LAI and ciphering key sequence number, and the GMM parameters GMM state, GPRS update status, P-TMSI, P-TMSI signature, RAI and GPRS ciphering key sequence number as specified in 3GPP TS 24.008 [13] for the case when the combined attach procedure is rejected with the GMM cause with the same value.

[TS 24.008, clause 4.7.3.2.4]

The MS shall then take one of the following actions depending upon the reject cause:

...

8 (GPRS services and non-GPRS services not allowed);

The MS shall set the GPRS update status to GU3 ROAMING NOT ALLOWED (shall store it according to subclause 4.1.3.2) and shall delete any P-TMSI, P-TMSI signature, RAI and GPRS ciphering key sequence number. The new GMM state is GMM-DEREGISTERED. The new MM state is MM IDLE.

The MS shall set the update status to U3 ROAMING NOT ALLOWED, shall delete any TMSI, LAI and ciphering key sequence number. The SIM/USIM shall be considered as invalid for GPRS and non-GPRS services until switching off or the SIM/USIM is removed.

9.2.1.2.7.3 Test description

The test description is identical to the one of subclause 9.2.1.2.5 except that the reject cause #3 "illegal UE" is replaced with reject cause #8 "EPS services and non-EPS services not allowed"

9.2.1.2.8 Combined attach / Rejected / EPS services not allowed

9.2.1.2.8.1 Test Purpose (TP)

(1)

```
with { UE has sent an ATTACH REQUEST message including a PDN CONNECTIVITY REQUEST message }
ensure that {
  when { UE receives an ATTACH REJECT message with the reject cause set to "EPS services not allowed" }
  then { UE considers the USIM as invalid for EPS services and enters state EMM-DEREGISTERED and UE does not attempt to attach on any other cell }
}
```

9.2.1.2.8.2 Conformance requirements

References: The conformance requirements covered in the present TC are specified in: TS 24.301, clause 5.5.1.3.5.

[TS 24.301, clause 5.5.1.3.5]

Upon receiving the ATTACH REJECT message, the UE shall stop timer T3410, enter MM state MM IDLE, and take the following actions depending on the EMM cause value received.

...

#7 (EPS services not allowed);

The UE shall set the EPS update status to EU3 ROAMING NOT ALLOWED (and shall store it according to subclause 5.1.3.3) and shall delete any GUTI, last visited registered TAI and eKSI. The UE shall consider the USIM as invalid for EPS services until switching off or the UICC containing the USIM is removed. Additionally, the UE shall delete the list of equivalent PLMNs and shall enter the state EMM-DEREGISTERED.

A UE which is not yet IMSI attached for non-EPS services shall select GERAN or UTRAN radio access technology and perform an IMSI attach for non-EPS services, using the MM IMSI attach procedure as described in 3GPP TS 24.008 [13]. The UE shall not reselect E-UTRAN radio access technology until switching off or the UICC containing the USIM is removed.

A UE which is already IMSI attached for non-EPS services is still IMSI attached for non-EPS services in the network. The UE shall select GERAN or UTRAN radio access technology and shall proceed with the appropriate MM specific procedure according to the MM service state. The UE shall not reselect E-UTRAN radio access technology until switching off or the UICC containing the USIM is removed.

NOTE: Some interaction is required with the access stratum to disable E-UTRAN cell reselection.

If A/Gb mode or Iu mode is supported by the UE, the UE shall in addition handle the GMM parameters GMM state, GPRS update status, P-TMSI, P-TMSI signature, RAI and GPRS ciphering key sequence number as specified in 3GPP TS 24.008 [13] for the case when the combined attach procedure is rejected with the GMM cause with the same value.

9.2.1.2.8.3 Test description

9.2.1.2.8.3.1 Pre-test conditions

System Simulator:

- cell A and cell B;
- if pc_UTRA AND px_RATComb_Testcd = EUTRA_UTRA, cell 5 (home PLMN);
- if pc_GERAN AND px_RATComb_Testcd = EUTRA_GERAN, cell 24 (home PLMN);
- System information combination 10a as defined in TS 36.508[18] clause 4.4.3.1 is used in E-UTRA cells.

Note: Setting px_RATComb_Testcd = EUTRA_Only is not allowed.

UE:

- the UE is configured to initiate combined EPS/IMSI attach.
- the UE is previously registered on E-UTRAN, and when on E-UTRAN, the UE is last authenticated and registered on cell A using default message contents according to TS 36.508 [18];
- if pc_UTRA AND px_RATComb_Testcd = EUTRA_UTRA, the UE is previously registered on UTRAN cell 5 using default message contents according to TS 36.508 [18].
- if pc_GERAN AND px_RATComb_Testcd = EUTRA_GERAN, the UE is previously registered on GERAN cell 24 using default message contents according to TS 36.508 [18].

Preamble:

- the UE is in state Switched OFF (state 1) according to TS 36.508 [18].

9.2.1.2.8.3.2 Test procedure sequence

Table 9.2.1.2.8.3.2-1: Main behaviour

St	Procedure	Message Sequence		TP	Verdict
		U - S	Message		
1	The SS configures: - Cell A as the "Serving cell". - Cell B as a "Suitable neighbour cell".	-	-	-	-
-	The following messages are to be observed on Cell A unless explicitly stated otherwise.	-	-	-	-
2	The UE is switched on.	-	-	-	-
3	The UE transmits an ATTACH REQUEST message including a PDN CONNECTIVITY REQUEST message.	-->	ATTACH REQUEST	-	-
4	The SS transmits an ATTACH REJECT message with EMM cause = "EPS services not allowed" as specified.	<--	ATTACH REJECT	-	-
5	The SS releases the RRC connection.	-	-	-	-
5A	The SS configures Cell 5 or Cell 24 as a "Suitable neighbour cell".	-	-	-	-
-	EXCEPTION: Steps 6a1 to 6a5 describe behaviour that depends on the UE capability; the "lower case letter" identifies a step sequence that take place if a capability is supported	-	-	-	-
6a1	The following messages are sent and shall be received on cell 5 or Cell 24.	-	-	-	-
6a2	Check: Does the UE transmit a LOCATION UPDATING REQUEST message on Cell 5 or Cell 24?	-->	LOCATION UPDATING REQUEST	1	P
-	EXCEPTION: The messages in the next two steps are sent only on Cell 24	-	-	-	-
6a2A a1	The UE transmits a <i>Classmark Change</i> message	-->	CLASSMARK CHANGE		
-	EXCEPTION: The next step describes behaviour that depends on UE capability.	-	-	-	-
6a2A a2	IF pc_UTRA THEN the UE transmits a Utran <i>Classmark Change</i> message.	-->	UTRAN CLASSMARK CHANGE.		
6a3	The SS transmits an AUTHENTICATION REQUEST message to initiate the authentication and AKA procedure.	<--	AUTHENTICATION REQUEST	-	-
6a4	The UE transmits an AUTHENTICATION RESPONSE message.	-->	AUTHENTICATION RESPONSE	-	-
6a5	The SS transmits a LOCATION UPDATING ACCEPT message with Location updating type = "IMSI attach" as specified in 3GPP TS 24.008.	<--	LOCATION UPDATING ACCEPT	-	-
7	The SS configures: - Cell 5 or Cell 24 as a "Non-Suitable cell". - Cell A as the "Suitable neighbour cell". - Cell B as the "Suitable neighbour cell".	-	-	-	-
8	Check: Does the UE transmit an ATTACH REQUEST message in the next 30 seconds on Cell A or on Cell B?	-->	ATTACH REQUEST	1	F
-	At the end of this test procedure sequence, the UE is in end state E-UTRA deregistered (E4) according to TS 36.508.	-	-	-	-

9.2.1.2.8.3.3 Specific message contents

Table 9.2.1.2.8.3.3-1: Message ATTACH REJECT (step 4, Table 9.2.1.2.8.3.2-1)

Derivation Path: TS 36.508 Table 4.7.2-3			
Information Element	Value/remark	Comment	Condition
EMM cause	'0000 0111'B	EPS services not allowed	

Table 9.2.1.2.8.3.3-2: LOCATION UPDATING REQUEST (step 6a2, Table 9.2.1.2.8.3.2-1)

Derivation Path: TS 36.508 Table 4.7B.2-4			
Information Element	Value/remark	Comment	Condition
Location updating type	IMSI attach Note 1	Rel8, Rel9, Rel10	
	Normal attach	Note 1	
Note 1: Depending on the Release, one or any of these values is allowed.			

Table 9.2.1.2.8.3.3-3: LOCATION UPDATING ACCEPT (step 6a5, Table 9.2.1.2.8.3.2-1)

Derivation Path: TS 36.508 Table 4.7B.2-5			
Information Element	Value/remark	Comment	Condition
Mobile identity	Not present		

9.2.1.2.9 Combined attach / Rejected / PLMN not allowed

9.2.1.2.9.1 Test Purpose (TP)

(1)

```

with { UE has sent an ATTACH REQUEST message including a PDN CONNECTIVITY REQUEST message }
ensure that {
  when { UE receives an ATTACH REJECT message with the reject cause set to "PLMN not allowed" }
  then { UE deletes the GUTI, the last visited registered TAI and KSI and UE deletes the list of
equivalent PLMNs and UE enters state EMM-DEREGISTERED.PLMN-SEARCH and UE stores the PLMN in the
"forbidden PLMN list" }
}

```

(2)

```

with { UE is switched off and a PLMN is stored in the "forbidden PLMN list" }
ensure that {
  when { UE is powered on this PLMN }
  then { UE does not attempt to attach on the cell }
}

```

(3)

```

with { UE in E-UTRA EMM-DEREGISTERED.PLMN-SEARCH state and a PLMN is stored in the "forbidden PLMN
list" }
ensure that {
  when { UE enters a PLMN which is not in the "forbidden PLMN list" }
  then { UE attempts to attach on the cell }
}

```

(4)

```

with { UE in E-UTRA EMM-DEREGISTERED.PLMN-SEARCH state and a PLMN is stored in the "forbidden PLMN
list" }
ensure that {
  when { the forbidden PLMN is selected manually }
  then { UE attaches to the forbidden PLMN and deletes this PLMN from the forbidden PLMN list on
the USIM }
}

```

9.2.1.2.9.2 Conformance requirements

References: The conformance requirements covered in the present TC are specified in: TS 24.301, clause 5.5.1.3.5.

[TS 24.301, clause 5.5.1.3.5]

...

Upon receiving the ATTACH REJECT message, the UE shall stop timer T3410, enter MM state MM IDLE, and take the following actions depending on the EMM cause value received.

...

#11 (PLMN not allowed);

The UE shall set the EPS update status to EU3 ROAMING NOT ALLOWED (and shall store it according to subclause 5.1.3.3) and shall delete any GUTI, last visited registered TAI, and KSI, and reset the attach attempt counter. The UE shall delete the list of equivalent PLMNs and enter the state EMM-DEREGISTERED.PLMN-SEARCH.

The UE shall store the PLMN identity in the "forbidden PLMN list".

The UE shall perform a PLMN selection according to 3GPP TS 23.122 [6].

If A/Gb mode or Iu mode is supported by the UE, the UE shall in addition handle the MM parameters update status, TMSI, LAI, ciphering key sequence number and location update attempt counter, and the GMM parameters GMM state, GPRS update status, P-TMSI, P-TMSI signature, RAI, GPRS ciphering key sequence number and GPRS attach attempt counter as specified in 3GPP TS 24.008 [13] for the case when the combined attach procedure is rejected with the GMM cause with the same value and no RR connection exists.

...

9.2.1.2.9.3 Test description

9.2.1.2.9.3.1 Pre-test conditions

System Simulator:

- cell G, cell H (VPLMN, same MCC like HPLMN, different TAs) and cell I (VPLMN, different MCC from HPLMN);
- the cells are configured according to Table 6.3.2.2-1 and Table 6.3.2.2-3 in 36.508[18], except replacing f3 with f1;
- if pc_UTRA AND , px_RATComb_Tested = EUTRA_ UTRA N, cell 9 (belongs to RAI-1, same PLMN as cell G, Non-suitable off);
- if pc_GERAN px_RATComb_Tested = EUTRA_ GERAN, cell 24 (belongs to RAI-1, same PLMN as cell G, Non-suitable off); - the cells may not be simultaneously activated.
- System information combination 10 as defined in TS 36.508[18] clause 4.4.3.1 is used in E-UTRA cells.

Note: Setting px_RATComb_Tested = EUTRA_Only is not allowed.

UE:

- the UE is configured to initiate combined EPS/IMSI attach;
- the UE is previously registered on E-UTRAN, and when on E-UTRAN, the UE is last authenticated and registered on cell G using default message contents according to TS 36.508 [18];
- the "forbidden PLMN list" is empty.

Preamble:

- the UE is in state Switched OFF (state 1) according to TS 36.508 [18].

9.2.1.2.9.3.2 Test procedure sequence

Table 9.2.1.2.9.3.2-1: Main behaviour

St	Procedure	Message Sequence		TP	Verdict
		U - S	Message		
1	The SS configures: - Cell G as the "Serving cell". - Cell H as a " Suitable Neighbour cell". - Cell I as a "Non-Suitable Off cell". Note: Cell G and Cell H are in the different TAI – same PLMN.	-	-	-	-
-	The following messages are to be observed on Cell G unless explicitly stated otherwise.	-	-	-	-
2	The UE is switched on.	-	-	-	-
3	The UE transmits an ATTACH REQUEST message including a PDN CONNECTIVITY REQUEST message.	-->	ATTACH REQUEST	-	-
4	The SS transmits an ATTACH REJECT message with EMM cause = "PLMN not allowed".	<--	ATTACH REJECT	-	-
5	The SS releases the RRC connection.	-	-	-	-
6	Check: Does the UE transmit an ATTACH REQUEST message in the next 30 seconds?	-	ATTACH REQUEST	1	F
7	If possible (see ICS) switch off is performed or the USIM is removed. Otherwise the power is removed.	-	-	-	-
8	The UE is brought back to operation or the USIM is inserted. The UE is powered on or switched on.	-	-	-	-
8A	Check: Does the UE transmit an ATTACH REQUEST message in the next 30 seconds?	-->	ATTACH REQUEST	2	F
-	EXCEPTION: Steps 9a1 to 9a3 describe behaviour that depends on the UE capability; the "lower case letter" identifies a step sequence that take place if a capability is supported	-	-	-	-
9a1	The SS configures: - Cell H as a "Non-Suitable off cell". - Cell G as a "Non-Suitable cell". - Cell 9 (px_RATComb_Tested = EUTRA_UTRA) or Cell 24 (px_RATComb_Tested = EUTRA_GERAN) as the "Serving cell". Note: Cell G, Cell 9 and Cell 24 are in the same PLMN.	-	-	-	-
-	The following messages are to be observed on Cell 9 or Cell 24 unless explicitly stated otherwise.	-	-	-	-
9a2	Void	-	-	-	-
9a3	Check: Does the UE transmit an ATTACH REQUEST message in the next 30 seconds?	-->	ATTACH REQUEST	2	F
10	The SS configures: Cell 9 or Cell 24 as a "Non-Suitable off cell". Cell I as a " Serving cell". Note: Cell G belongs to PLMN different from PLMN belonging to Cell I.	-	-	-	-
-	The following messages are to be observed on Cell I unless explicitly stated otherwise.	-	-	-	-
11	Check: Does the UE transmit an ATTACH REQUEST message including a PDN CONNECTIVITY REQUEST message as specified?	-->	ATTACH REQUEST	1,3	P
12-23,	The attach procedure is completed by executing steps 5 to 17 of the UE registration	-	-	-	-

23A	procedure in TS 36.508 sub clause 4.5.2.3.				
24	If possible (see ICS) switch off is performed or the USIM is removed. Otherwise the power is removed.	-	-	-	-
-	EXCEPTION: Step 25 describes behaviour that depends on the UE capability.				
25	If pc_SwitchOnOff or pc_USIM_Removal then the UE transmits a DETACH REQUEST message.	-->	DETACH REQUEST	-	-
26	The SS configures: - Cell G as the "Serving cell" - Cell I as a "Non-suitable cell". Note: Cell G belongs to the forbidden PLMN.	-	-	-	-
27	The UE is brought back to operation or the USIM is inserted	-	-	-	-
28	The following messages are to be observed on Cell G unless explicitly stated otherwise.	-	-	-	-
29	The user sets the UE in manual PLMN selection mode or requests a PLMN search.	-	-	-	-
30	The user selects PLMN of cell G.	-	-	-	-
31	Check: Does the UE transmit an ATTACH REQUEST message including a PDN CONNECTIVITY REQUEST message as specified?	-->	ATTACH REQUEST	4	P
32-44	The attach procedure is completed and the RRC connection is released by executing steps 5 to 17 of the UE registration procedure in TS 36.508 clause 4.5.2.3.	-	-	-	-
-	At the end of this test procedure sequence, the UE is in end state E-UTRA idle (E1) according to TS 36.508.	-	-	-	-

9.2.1.2.9.3.3 Specific message contents

Table 9.2.1.2.9.3.3-1: Message ATTACH REJECT (step 4, Table 9.2.1.2.9.3.2-1)

Derivation Path: TS 36.508 Table 4.7.2-3			
Information Element	Value/remark	Comment	Condition
EMM cause	'0000 1011'B	PLMN not allowed	

Table 9.2.1.2.9.3.3-2: Message ATTACH REQUEST (step 11, Table 9.2.1.2.9.3.2-1)

Derivation Path: TS 36.508 Table 4.7.2-4			
Information Element	Value/remark	Comment	Condition
NAS key set identifier			
NAS key set identifier	'111'B	no key is available	
TSC	Any allowed value	TSC does not apply for NAS key set identifier value "111".	
Old GUTI or IMSI	IMSI1		
Last visited registered TAI	Not present		

Table 9.2.1.2.9.3.3-3: Message ATTACH REQUEST (step 31, Table 9.2.1.1.13.3.2-1)

Derivation path: 36.508 table 4.7.2-4			
Information Element	Value/Remark	Comment	Condition
Old GUTI or IMSI	GUTI allocated in step 21		
Last visited registered TAI	TAI allocated in step 21		

9.2.1.2.10 Combined attach / Rejected / Tracking area not allowed

9.2.1.2.10.1 Test Purpose (TP)

(1)

```

with { UE has sent an ATTACH REQUEST message including a PDN CONNECTIVITY REQUEST message }
ensure that {
  when { UE receives an ATTACH REJECT message with the reject cause set to "Tracking area not
allowed" }
  then { UE deletes the GUTI, last visited registered TAI and KSI, UE enters the state EMM-
DEREGISTERED.LIMITED-SERVICE and UE stores the current TAI in the list of "forbidden tracking areas
for regional provision of service" }
}

```

(2)

```

with { UE is in EMM-DEREGISTERED.LIMITED-SERVICE state and the current TAI in the list of "forbidden
tracking areas for regional provision of service" }
ensure that {
  when { serving cell belongs to TAI where UE was rejected }
  then { UE does not attempt to attach on any cell }
}

```

(3)

```

with { UE is in EMM-DEREGISTERED.LIMITED-SERVICE state and the current TAI in the list of "forbidden
tracking areas for regional provision of service" }
ensure that {
  when { UE re-selects a new cell in the same TAI it was rejected }
  then { UE does not attempt to attach on the cell }
}

```

(4)

```

with { UE is switched off }
ensure that {
  when { UE is powered on in the cell belonging to the TAI which was in the list of "forbidden
tracking areas for regional provision of service" before the UE was switched off }
  then { UE attempts to attach on the cell }
}

```

9.2.1.2.10.2 Conformance requirements

References: The conformance requirements covered in the present TC are specified in: TS 24.301, clause 5.5.1.3.5.

[TS 24.301, clause 5.5.1.3.5]

Upon receiving the ATTACH REJECT message, the UE shall stop timer T3410, enter MM state MM IDLE, and take the following actions depending on the EMM cause value received.

...

#12 (Tracking area not allowed);

The UE shall set the EPS update status to EU3 ROAMING NOT ALLOWED (and shall store it according to subclause 5.1.3.3) and shall delete any GUTI, last visited registered TAI and KSI. The UE shall reset the attach attempt counter and enter the state EMM-DEREGISTERED.LIMITED-SERVICE.

The UE shall store the current TAI in the list of "forbidden tracking areas for regional provision of service".

If A/Gb mode or Iu mode is supported by the UE, the UE shall in addition handle the MM parameters update status, TMSI, LAI, ciphering key sequence number and location update attempt counter, and the GMM parameters GMM state, GPRS update status, P-TMSI, P-TMSI signature, RAI, GPRS ciphering key sequence number and GPRS attach attempt counter as specified in 3GPP TS 24.008 [13] for the case when the combined attach procedure is rejected with the GMM cause with the same value.

9.2.1.2.10.3 Test description

9.2.1.2.10.3.1 Pre-test conditions

System Simulator:

- cell A, cell B and cell M.
- System information combination 3 as defined in TS 36.508[18] clause 4.4.3.1 is used in E-UTRA cells.

UE:

- the UE is configured to initiate combined EPS/IMSI attach;
- the UE is previously registered on E-UTRAN, and when on E-UTRAN, the UE is last authenticated and registered on cell A using default message contents according to TS 36.508 [18].

Preamble:

- the UE is in state Switched OFF (state 1) according to TS 36.508 [18].

9.2.1.2.10.3.2 Test procedure sequence

Table 9.2.1.2.10.3.2-1: Main behaviour

St	Procedure	Message Sequence		TP	Verdict
		U - S	Message		
1	The SS configures: - Cell A as the "Serving cell". - Cell B as a "Suitable neighbour cell". - Cell M as a "Non-Suitable cell".	-	-	-	-
-	The following messages are to be observed on Cell A unless explicitly stated otherwise.	-	-	-	-
2	The UE is switched on.	-	-	-	-
3	The UE transmits an ATTACH REQUEST message including a PDN CONNECTIVITY REQUEST message.	-->	ATTACH REQUEST	-	-
4	The SS transmits an ATTACH REJECT message with EMM cause = "Tracking area not allowed".	<--	ATTACH REJECT	-	-
5	The SS releases the RRC connection.	-	-	-	-
6	Check: Does the UE transmit the ATTACH REQUEST message in the next 30 seconds on Cell A or Cell B?	-	ATTACH REQUEST	1,2	F
7	The SS configures: - Cell A as the "Non-Suitable cell". - Cell B as a "Non-Suitable cell". - Cell M as a "Serving cell".	-	-	-	-
8	Check: Does the UE transmit the ATTACH REQUEST message in the next 30 seconds on Cell M?	-	ATTACH REQUEST	3	F
-	The following messages are to be observed on Cell M unless explicitly stated otherwise.	-	-	-	-
9	If possible (see ICS) switch off is performed or the USIM is removed. Otherwise the power is removed.	-	-	-	-
10	The UE is brought back to operation or the USIM is inserted	-	-	-	-
11	Check: Does the UE transmit an ATTACH REQUEST message including a PDN CONNECTIVITY REQUEST message as specified?	-->	ATTACH REQUEST	1,4	P
12-23	The attach procedure is completed by executing steps 5 to 16 of the UE registration procedure in TS 36.508 sub clause 4.5.2.3.	-	-	-	-
-	At the end of this test procedure sequence, the UE is in end state E-UTRA connected (E2) according to TS 36.508.	-	-	-	-

9.2.1.2.10.3.3 Specific message contents

Table 9.2.1.2.10.3.3-1: Message ATTACH REJECT (step 4, Table 9.2.1.2.10.3.2-1)

Derivation Path: TS 36.508 Table 4.7.2-3			
Information Element	Value/remark	Comment	Condition
EMM cause	'0000 1100'B	Tracking Area not allowed	

Table 9.2.1.2.10.3.3-2: Message ATTACH REQUEST (step 11, Table 9.2.1.2.10.3.2-1)

Derivation Path: TS 36.508 Table 4.7.2-4			
Information Element	Value/remark	Comment	Condition
NAS key set identifier			
NAS key set identifier	'111'B	no key is available	
TSC	Any allowed value	TSC does not apply for NAS key set identifier value "111".	
Old GUTI or IMSI	IMSI1		
Last visited registered TAI	Not present		

9.2.1.2.11 Combined attach / Rejected / Roaming not allowed in this tracking area

9.2.1.2.11.1 Test Purpose (TP)

(1)

```
with { UE has sent an ATTACH REQUEST message }
ensure that {
  when { UE receives an ATTACH REJECT message with the EMM cause set to "Roaming not allowed in this tracking area" }
  then { UE sets the EPS update status to EU3 ROAMING NOT ALLOWED and UE deletes the GUTI, the last visited registered TAI and KSI and UE enters the state EMM-DEREGISTERED.LIMITED-SERVICE or optionally EMM-DEREGISTERED.PLMN-SEARCH and UE stores the current TAI in the list of "forbidden tracking areas for roaming" and deletes the TMSI, the LAI and the ciphering key sequence number }
}
```

(2)

```
with { UE is in EMM-DEREGISTERED.LIMITED-SERVICE or EMM-DEREGISTERED.PLMN-SEARCH state and the current TAI is in the list of "forbidden tracking areas for roaming" }
ensure that {
  when { UE re-selects a new cell in the same TA where it was rejected }
  then { UE does not attempt to attach }
}
```

(3)

```
with { UE is in EMM-DEREGISTERED.LIMITED-SERVICE or EMM-DEREGISTERED.PLMN-SEARCH state and the TAI of the current cell belongs to the list of "forbidden tracking areas for roaming" }
ensure that {
  when { UE enters a cell belonging to a tracking area not in the list of "forbidden tracking areas for roaming" }
  then { UE attempts to attach with IMSI }
}
```

(4)

```
with { UE is in EMM-DEREGISTERED.LIMITED-SERVICE or EMM-DEREGISTERED.PLMN-SEARCH state and the list of "forbidden tracking areas for roaming" contains more than one TAI }
ensure that {
  when { UE selects a cell belonging to one of the TAIs in the list of "forbidden tracking areas for roaming" }
  then { UE does not attempt to attach }
}
```

(5)

```
with { UE has sent an ATTACH REQUEST message }
ensure that {
  when { UE receives an ATTACH REJECT message with the EMM cause set to "Roaming not allowed in this tracking area" }
  then { UE deletes RAI, P-TMSI, P-TMSI signature and GPRS ciphering key sequence number and sets the GPRS update status to GU3 ROAMING NOT ALLOWED }
}
```

(6)

```

with { UE is switched off or the UICC containing the USIM is removed }
ensure that {
  when { UE is powered on in the cell belonging to the TAI which was in the list of "forbidden
tracking areas for roaming" before UE was switched off or the USIM is inserted again on that cell }
  then { UE performs registration on that cell }
}

```

(7)

```

with { a cell of the HPLMN is available }
ensure that {
  when { UE performs a PLMN selection }
  then { UE returns to a cell of the HPLMN }
}

```

9.2.1.2.11.2 Conformance requirements

References: The conformance requirements covered in the present TC are specified in: TS 24.301, clause 5.3.2 and 5.5.1.3.5 and TS 24.008, clause 4.7.3.2.4.

[TS 24.301, clause 5.3.2]

The UE shall store a list of "forbidden tracking areas for roaming", as well as a list of "forbidden tracking areas for regional provision of service". These lists shall be erased when the UE is switched off or when the UICC containing the USIM is removed, and periodically (with a period in the range 12 to 24 hours). One or more tracking areas is removed from the list of "forbidden tracking areas for roaming" in the UE, as well as the list of "forbidden tracking areas for regional provision of service" if, after a subsequent procedure e.g. attach procedure, tracking area updating procedure and GUTI reallocation procedure, one or more tracking areas in the lists is received from the network.

In S1 mode, the UE shall update the suitable list whenever an ATTACH REJECT, TRACKING AREA UPDATE REJECT, SERVICE REJECT or DETACH REQUEST message is received with the EMM cause #12 "tracking area not allowed", #13 "roaming not allowed in this tracking area", or #15 "no suitable cells in tracking area".

Each list shall accommodate 40 or more TAIs. When the list is full and a new entry has to be inserted, the oldest entry shall be deleted.

[TS 24.301, clause 5.5.1.3.5]

If the attach request can neither be accepted by the network for EPS nor for non-EPS services, the MME shall send an ATTACH REJECT message to the UE including an appropriate EMM cause value. If the attach procedure fails due to a default EPS bearer setup failure or an ESM procedure failure, the MME shall combine the ATTACH REJECT message with a PDN CONNECTIVITY REJECT message. In this case the EMM cause value in the ATTACH REJECT message shall be set to #19, "ESM failure".

Upon receiving the ATTACH REJECT message, the UE shall stop timer T3410, enter MM state MM IDLE, and take the following actions depending on the EMM cause value received.

...

#13 (Roaming not allowed in this tracking area);

The UE shall set the EPS update status to EU3 ROAMING NOT ALLOWED (and shall store it according to subclause 5.1.3.3) and shall delete any GUTI, last visited registered TAI and KSI. The UE shall delete the list of equivalent PLMNs and reset the attach attempt counter. Additionally the UE enter the state EMM-DEREGISTERED.LIMITED-SERVICE or optionally EMM-DEREGISTERED.PLMN-SEARCH.

The UE shall store the current TAI in the list of "forbidden tracking areas for roaming".

The UE shall perform a PLMN selection according to 3GPP TS 23.122 [6].

If A/Gb mode or Iu mode is supported by the UE, the UE shall in addition handle the MM parameters update status, TMSI, LAI, ciphering key sequence number and location update attempt counter, and the GMM parameters GMM state, GPRS update status, P-TMSI, P-TMSI signature, RAI, GPRS ciphering key sequence number and GPRS attach attempt counter as specified in 3GPP TS 24.008 [13] for the case when the combined attach procedure is rejected with the GMM cause with the same value.

...

[TS 24.008, clause 4.7.3.2.4]

If the attach request can neither be accepted by the network for GPRS nor for non-GPRS services, an ATTACH REJECT message is transferred to the MS. The MS receiving the ATTACH REJECT message stops timer T3310, and for all causes except #12, #14, #15 and #25 deletes the list of "equivalent PLMNs".

The MS shall then take one of the following actions depending upon the reject cause:

...

13 (Roaming not allowed in this location area);

The MS shall delete any RAI, P-TMSI, P-TMSI signature and GPRS ciphering key sequence number, shall set the GPRS update status to GU3 ROAMING NOT ALLOWED (and shall store it according to clause 4.1.3.2) and shall reset the GPRS attach attempt counter. The state is changed to GMM-DEREGISTERED.LIMITED-SERVICE or optionally to GMM-DEREGISTERED.PLMN-SEARCH.

The MS shall set the update status to U3 ROAMING NOT ALLOWED, reset the location update attempt counter and shall delete any TMSI, LAI and ciphering key sequence number. The new MM state is MM IDLE.

...

9.2.1.2.11.3 Test description

9.2.1.2.11.3.1 Pre-test conditions

System Simulator:

- cell I and cell K (visited PLMN, same TA);
- cell L (same visited PLMN, another TA);
- cell C (home PLMN);
- the cells are configured according to Table 6.3.2.2-1 and Table 6.3.2.2-3 in 36.508[18], except replacing f3 with f2;
- if pc_UTRA AND px_RATComb_Tested = EUTRA_UTRA, cell 9 (only active when stated):
 - same PLMN like visited PLMN above;
 - RAI-1 (RAC & LAC values chosen by SS);
 - System information indicate that NMO 1 is used;
- if pc_GERAN AND px_RATComb_Tested = EUTRA_GERAN, cell 24 (only active when stated):
 - same PLMN like visited PLMN above;
 - RAC-1 (RAC & LAC values chosen by SS);
- System information combination 10 as defined in TS 36.508[18] clause 4.4.3.1 is used in E-UTRA cells.

NOTE 1: Setting px_RATComb_Tested = EUTRA_Only is not allowed.

NOTE 2: Cell K is present to confirm that UE does not attempt attach to the cell in same TAI after reject from the SS.

NOTE 3: Cell C is present to confirm that UE does attempt attach to the cell in HPLMN after reject from the SS.

NOTE 4: The requirement in 3GPP TS 24.301 to store at least 40 entries in the list of "forbidden tracking areas for roaming" is not fully tested.

NOTE 5: Different types of UE may use different methods to periodically clear the list of forbidden areas (e.g. every day at 12 am) for roaming. If the list is cleared while the test is being run, it may be necessary to re-run the test.

UE:

- the UE is configured to initiate combined EPS/IMSI attach;
- the UE is previously registered on E-UTRAN, and when on E-UTRAN, the UE is last authenticated and registered on cell I using default message contents according to TS 36.508 [18];
- if pc_UTRA AND $px_RATComb_Tested = EUTRA_UTRA$, the UE is previously registered on UTRAN cell 9 using default message contents according to TS 36.508 [18].
- if pc_GERAN AND $px_RATComb_Tested = EUTRA_GERAN$, the UE is previously registered on GERAN cell 24 using default message contents according to TS 36.508 [18].

Preamble:

- the UE is in state Switched OFF (state 1) according to TS 36.508 [18].

9.2.1.2.11.3.2 Test procedure sequence

Table 9.2.1.2.11.3.2-1: Main behaviour

St	Procedure	Message Sequence		TP	Verdict
		U - S	Message		
1	The SS configures: Cell I as the "Serving cell". Cell K as a "Non-Suitable cell", Cell L as a "Non-Suitable "off" cell", Cell C as a "Non-Suitable cell".	-	-	-	-
-	The following messages are to be observed on Cell I unless explicitly stated otherwise.	-	-	-	-
2	The UE is switched on.	-	-	-	-
3	The UE transmits an ATTACH REQUEST message including a PDN CONNECTIVITY REQUEST message.	-->	ATTACH REQUEST	-	-
4	The SS transmits an ATTACH REJECT message with the EMM cause set to "Roaming not allowed in this tracking area" on Cell I. (The list of "forbidden tracking areas for roaming" in the UE should now contain TAI-9)	<--	ATTACH REJECT	-	-
5	The SS releases the RRC connection.	-	-	-	-
6	Check: Does the UE transmit an ATTACH REQUEST message in the next 30 seconds on Cell I?	-->	ATTACH REQUEST	1,4	F
7	The SS reconfigures: Cell I as a "Suitable cell", Cell K as the "Serving cell", Cell L as a "Non-Suitable "off" cell", Cell C as a "Non-Suitable cell".	-	-	-	-
8	Check: Does the UE transmit an ATTACH REQUEST message in the next 30 seconds on any cell?	-->	ATTACH REQUEST	2	F
9	The SS reconfigures: Cell I as a "Non-Suitable "off" cell", Cell K as a "Suitable cell", Cell L as the "Serving cell", Cell C as a "Non-Suitable cell".	-	-	-	-
10	Check: Does the UE transmit an ATTACH REQUEST message including a PDN CONNECTIVITY REQUEST message on Cell L?	-->	ATTACH REQUEST	3	P
11	The SS transmits an ATTACH REJECT message with the EMM cause set to "Roaming not allowed in this tracking area" on Cell L. (The list of "forbidden tracking areas for roaming" in the UE should now contain TAI-9 and TAI-11)	<--	ATTACH REJECT	-	-
12	The SS releases the RRC connection.	-	-	-	-
13	Check: Does the UE transmit an ATTACH REQUEST message in the next 30 seconds on Cell L or Cell K?	-->	ATTACH REQUEST	1,4	F
14	The SS reconfigures: Cell I as a "Serving cell", Cell K as a " Non-Suitable "off" cell", Cell L as a "Suitable cell", Cell C as the "Non-Suitable cell".	-	-	-	-
15	Check: Does the UE transmit an ATTACH REQUEST message in the next 30 seconds on any cell?	-->	ATTACH REQUEST	2,4	F
-	EXCEPTION: Steps 16a1 to 16a2 describe behaviour that depends on the UE capability; the "lower case letter" identifies a step sequence that take place if a capability is supported	-	-	-	-
16a1	The SS reconfigures: Cell I as "Serving cell",	-	-	-	-

	Cell L as "Non-suitable "off" cell", Cell 9 (px_RATComb_Tested = EUTRA_UTRA) or Cell 24 (px_RATComb_Tested = EUTRA_GERAN) as "Suitable cell".				
16a2	Check: Does the UE transmit an ATTACH REQUEST message without P-TMSI, P-TMSI signature, RAI, TMSI on Cell 9 or Cell 24?	-->	ATTACH REQUEST	5	P
16a3	The SS transmits an ATTACH REJECT message with the GMM cause set to "Roaming not allowed in this location area" on Cell 9 or Cell 24.	<--	ATTACH REJECT	-	-
17	If possible (see ICS) switch off is performed or the USIM is removed. Otherwise the power is removed.	-	-	-	-
18	The SS reconfigures: Cell I as the "Serving cell", Cell K as a "Non-Suitable cell", Cell 9 or Cell 24 as a "Non-Suitable "off" cell", Cell C as a "Non-Suitable cell".	-	-	-	-
19	The UE is brought back to operation or the USIM is inserted.	-	-	-	-
20	Check: Does the UE transmit an ATTACH REQUEST message including a PDN CONNECTIVITY REQUEST message on Cell I?	-->	ATTACH REQUEST	6	P
21	The SS transmits an ATTACH REJECT message with the EMM cause set to "Roaming not allowed in this tracking area" on Cell I. (The list of "forbidden tracking areas for roaming" in the UE should now contain TAI-9)	<--	ATTACH REJECT	-	-
21A	The SS releases the RRC connection.	-	-	-	-
22	The SS reconfigures: Cell I as the "Serving cell", Cell K as a "Non-Suitable cell", Cell C as a "Suitable cell".	-	-	-	-
-	The following messages are to be observed on Cell C unless explicitly stated otherwise.	-	-	-	-
23	Check: Does the UE transmit an ATTACH REQUEST message including a PDN CONNECTIVITY REQUEST message?	-->	ATTACH REQUEST	7	P
24- 35	The attach procedure is completed by executing steps 5 to 16 of the UE registration procedure in TS 36.508 sub clause 4.5.2.3.	-	-	-	-
-	At the end of this test procedure sequence, the UE is in end state E-UTRA connected (E2) according to TS 36.508.	-	-	-	-

9.2.1.2.11.3.3 Specific message contents

Table 9.2.1.2.11.3.3-1: Message ATTACH REJECT (step 4, step 11 and step 21, Table 9.2.1.2.11.3.2-1)

Derivation Path: TS 36.508, Table 4.7.2-3			
Information Element	Value/remark	Comment	Condition
EMM cause	'0000 1101'B	Roaming not allowed in this tracking area	

Table 9.2.1.2.11.3.3-2: Message ATTACH REQUEST (step 10, step 20 and step23, Table 9.2.1.2.11.3.2-1)

Derivation Path: TS 36.508, Table 4.7.2-4			
Information Element	Value/remark	Comment	Condition
NAS key set identifier			
NAS key set identifier	'111'B	no key is available	
TSC	Any allowed value	TSC does not apply for NAS key set identifier value "111".	
Old GUTI or IMSI	IMSI-1		
Last visited registered TAI	Not present		
Old location area identification	Not present		
TMSI status	'0'B	no valid TMSI available	

Table 9.2.1.2.11.3.3-3: Message ATTACH REQUEST (step 16a2, Table 9.2.1.2.11.3.2-1)

Derivation Path: TS 24.008 , Table 9.4.1			
Information Element	Value/remark	Comment	Condition
MS network capability	Any allowed value		
Attach type	'011'B	Combined GPRS/IMSI attach	
GPRS ciphering key sequence number	'111'B	No key is available (MS to network)	
DRX parameter	Any allowed value		
P-TMSI or IMSI	IMSI-1		
Old routing area identification	All bits of octets 5 and 6 are set to 1, except bit 1 of octet 6 which is set to 0. Other bits are not checked.		
MS Radio Access capability	Any allowed value		
Old P-TMSI signature	Not present		
Requested READY timer value	Not present or any allowed value		
TMSI status	'0'B	no valid TMSI available	
PS LCS Capability	Not present or any allowed value		
Mobile station classmark 2	Not present or any allowed value		
Mobile station classmark 3	Not present or any allowed value		
Supported Codecs	Not present or any allowed value		
UE network capability	Not present or any allowed value		
Additional mobile identity	Not present		
Additional old routing area identification	Not present		

Table 9.2.1.2.11.3.3-4: Message ATTACH REJECT (step 16a3, Table 9.2.1.2.11.3.2-1)

Derivation Path: TS 24.008 , Table 9.4.4			
Information Element	Value/remark	Comment	Condition
GMM cause	'0000 1101'B	Roaming not allowed in this location area	
T3302 value	Not present		

9.2.1.2.12 Combined attach / Rejected / EPS services not allowed in this PLMN

9.2.1.2.12.1 Test Purpose (TP)

(1)

```

with { UE has sent an ATTACH REQUEST message including a PDN CONNECTIVITY REQUEST message }
ensure that {
  when { UE receives an ATTACH REJECT message with the reject cause set to "EPS services not allowed
in this PLMN" }
    then { UE deletes any GUTI, last visited registered TAI, KSI and enters EMM-DEREGISTERED.PLMN-
SEARCH state}
}

```

(2)

```

with { UE in E-UTRA EMM-DEREGISTERED.PLMN-SEARCH state, and a PLMN is stored in the "forbidden PLMNs
for GPRS service list" }
ensure that {
  when { UE detects a cell which belongs to a PLMN which is in the "forbidden PLMNs for GPRS service
list" }
    then { UE doesn't perform an attach procedure }
}

```

(3)

```

with { UE in E-UTRA EMM-DEREGISTERED.PLMN-SEARCH state, and a PLMN is stored in the "forbidden PLMNs
for GPRS service list" }
ensure that {
  when { UE detects a cell which belongs to a PLMN which is not in the "forbidden PLMNs for GPRS
service list" }
    then { UE performs an attach procedure }
}

```

(4)

```

with { UE is switched off when a PLMN is stored in the "forbidden PLMNs for GPRS service list" }
ensure that {
  when { UE is powered on a cell which belongs to this PLMN }
    then { UE performs an attach procedure }
}

```

(5)

```

with { UE in E-UTRA EMM-DEREGISTERED.PLMN-SEARCH state, and a PLMN is stored in the "forbidden PLMNs
for GPRS service list" }
ensure that {
  when { UE is in the cell which belongs to the rejected PLMN and when that PLMN is selected
manually }
    then { UE performs an attach procedure }
}

```

9.2.1.2.12.2 Conformance requirements

References: The conformance requirements covered in the current TC are specified in: TS 24.301, clause 5.4.4.3.

[TS 24.301, clause 5.5.1.3.5]

If the attach request can neither be accepted by the network for EPS nor for non-EPS services, the MME shall send an ATTACH REJECT message to the UE including an appropriate EMM cause value. If the attach procedure fails due to a default EPS bearer setup failure or an ESM procedure failure, the MME shall combine the ATTACH REJECT message with a PDN CONNECTIVITY REJECT message. In this case the EMM cause value in the ATTACH REJECT message shall be set to #19, "ESM failure".

Upon receiving the ATTACH REJECT message, the UE shall stop timer T3410, enter MM state MM IDLE, and take the following actions depending on the EMM cause value received.

...

#14 (EPS services not allowed in this PLMN);

The UE shall set the EPS update status to EU3 ROAMING NOT ALLOWED (and shall store it according to subclause 5.1.3.3) and shall delete any GUTI, last visited registered TAI and KSI. Additionally the UE shall reset the attach attempt counter and enter the state EMM-DEREGISTERED.PLMN-SEARCH.

The UE shall store the PLMN identity in the "forbidden PLMNs for GPRS service" list.

A UE operating in CS/PS mode 1 which is not yet IMSI attached for non-EPS services may select GERAN or UTRAN radio access technology and perform an IMSI attach for non-EPS services, using the MM IMSI attach procedure as described in 3GPP TS 24.008 [13]. In this case the UE shall not reselect E-UTRAN radio access technology for the duration the UE is on the PLMN or an equivalent PLMN.

A UE operating in CS/PS mode 1 which is already IMSI attached for non-EPS services in the network is still IMSI attached for non-EPS services in the network. The UE may select GERAN or UTRAN radio access technology and proceed with the appropriate MM specific procedure according to the MM service state. In this case the UE shall not reselect E-UTRAN radio access technology for the duration the UE is on the PLMN or an equivalent PLMN.

A UE in CS/PS mode 1 of operation may perform a PLMN selection according to 3GPP TS 23.122 [6].

A UE operating in CS/PS mode 2 which is already IMSI attached for non-EPS services in the network is still IMSI attached for non-EPS services in the network.

A UE operating in CS/PS mode 2 of operation shall perform a PLMN selection according to 3GPP TS 23.122 [6].

If A/Gb mode or Iu mode is supported by the UE, the UE shall in addition handle the GMM parameters GMM state, GPRS update status, P-TMSI, P-TMSI signature, RAI, GPRS ciphering key sequence number and GPRS attach attempt counter as specified in 3GPP TS 24.008 [13] for the case when the combined attach procedure is rejected with the GMM cause with the same value.

9.2.1.2.12.3 Test description

9.2.1.2.12.3.1 Pre-test conditions

System Simulator:

- cell G, Cell H and cell I are configured according to Table 6.3.2.2-1 in; [18].
- cell G and Cell H with MCC-1/MNC-2 (visited PLMN, different TAs)
- Cell I with MCC-2/MNC-101 (visited PLMN);
- the cells are configured according to Table 6.3.2.2-1 and Table 6.3.2.2-3 in 36.508 [18], except replacing f3 with f1
- the cells may not be simultaneously activated.

UE:

- the UE is configured to initiate Combined attach;
- the UE is previously registered on E-UTRAN, and when on E-UTRAN, the UE is last authenticated and registered on cell G using default message contents according to TS 36.508 [18];
- the "forbidden PLMNs for GPRS service list" is empty.
- the different cells may not be simultaneously activated (at most 2 cells are active simultaneously).

Preamble:

- the UE is in state Switched OFF (state 1) according to TS 36.508 [18].

9.2.1.2.12.3.2 Test procedure sequence

Table 9.2.1.2.12.3.2-1: Main behaviour

St	Procedure	Message Sequence		TP	Verdict
		U - S	Message		
1	The SS configures: - Cell G as the "Serving cell". - Cell H as a "Non-Suitable cell". - Cell I as a "Non-Suitable off cell".	-	-	-	-
-	The following messages are to be observed on Cell G unless explicitly stated otherwise.	-	-	-	-
2	The UE is switched on.	-	-	-	-
3	The UE transmits an ATTACH REQUEST message including a PDN CONNECTIVITY REQUEST message.	-->	ATTACH REQUEST	-	-
4	The SS transmits an ATTACH REJECT message including EMM cause = "EPS services not allowed in this PLMN".	<--	ATTACH REJECT	-	-
5	The SS releases the RRC connection.	-	-	-	-
6	Check: Does the UE transmit an ATTACH REQUEST message in the next 90 seconds?	-->	ATTACH REQUEST	1	F
7	The SS configures: Cell G as a "Non-Suitable cell". Cell H as the "Serving cell". Note: Cell G and Cell H are in the different TAI – same PLMN.	-	-	-	-
-	The following messages are to be observed on Cell H unless explicitly stated otherwise.	-	-	-	-
8	Check: Does the UE transmit an ATTACH REQUEST message in the next 90 seconds?	-->	ATTACH REQUEST	2	F
9	The SS configures: Cell H as a "Non-Suitable off cell". Cell I as the "Serving cell". Note: Cell G and Cell I are different PLMNs.	-	-	-	-
-	The following messages are to be observed on Cell I unless explicitly stated otherwise.	-	-	-	-
10	Check: Does the UE transmit an ATTACH REQUEST message including a PDN CONNECTIVITY REQUEST message as specified?	-->	ATTACH REQUEST	1,3	P
11-23	The SS completes the attach procedure successfully and then releases the RRC - connection by executing steps 5 to 17 of UE registration procedure in TS 36.508 clause 4.5.2.3.				
24	If possible (see ICS) switch off is performed or the USIM is removed. Otherwise the power is removed.	-	-	-	-
25	The SS configures - Cell I as a "Non-Suitable cell". - Cell G as the "Serving cell".	-	-	-	-
-	The following messages are to be observed on Cell G unless explicitly stated otherwise.	-	-	-	-
26	The UE is brought back to operation or the USIM is inserted.				
27	Check: Does the UE transmit an ATTACH REQUEST message including a PDN CONNECTIVITY REQUEST message?	-->	ATTACH REQUEST	4	P
28	The SS transmits an ATTACH REJECT message including EMM cause = "EPS services not allowed in this PLMN".	<--	ATTACH REJECT	-	-
29	SS releases the RRC connection.	-	-	-	-
30	The user sets the UE in manual PLMN selection mode or requests a PLMN search.				

	The user selects PLMN (MCC-1/MNC-2)				
31	Check: Does the UE transmit an ATTACH REQUEST message including a PDN CONNECTIVITY REQUEST message as specified?	-->	ATTACH REQUEST	5	P
32-44	The attach procedure is completed and the RRC connection released by executing steps 5 to 17 of the UE registration procedure in TS 36.508 clause 4.5.2.3.	-	-	-	-
45	At the end of this test procedure sequence, the UE is in end state E-UTRA idle (E1) according to TS 36.508.	-	-	-	-

9.2.1.2.12.3.3 Specific message contents

Table 9.2.1.2.12.3.3-1: Message ATTACH REQUEST (step 3, Table 9.2.1.2.12.3.2-1)

Derivation path: 36.508 table 4.7.2-4			
Information Element	Value/Remark	Comment	Condition
Old GUTI or IMSI Last visited registered TAI Old location area identification TMSI status	GUTI-1 TAI-1 LAI-1 Not Present		

Table 9.2.1.2.12.3.3-2: Message ATTACH REJECT (step 4 and 28, Table 9.2.1.2.12.3.2-1)

Derivation path: 36.508 table 4.7.2-3 (Plain NAS message)			
Information Element	Value/Remark	Comment	Condition
EMM cause	00001110	#14 "EPS services not allowed in this PLMN "	
ESM message container	Not present		

Table 9.2.1.2.12.3.3-3: Message ATTACH REQUEST (step 10 and step 31, Table 9.2.1.2.12.3.2-1)

Derivation path: 36.508 table 4.7.2-4			
Information Element	Value/Remark	Comment	Condition
NAS key set identifier			
NAS key set identifier	'111'B	no key is available	
TSC	Any allowed value	TSC does not apply for NAS key set identifier value "111".	
Old GUTI or IMSI	IMSI-1	GUTI has been deleted after receiving ATTACH REJECT at step 5 and step28; only IMSI is available.	
Last visited registered TAI	Not present	TAI has been deleted after receiving ATTACH REJECT at step 5 and step29.	

9.2.1.2.13 Combined attach / Rejected / No suitable cells in tracking area

9.2.1.2.13.1 Test Purpose (TP)

(1)

```
with { UE has sent an ATTACH REQUEST message }
ensure that {
  when { UE receives an ATTACH REJECT message with the EMM cause set to 'No Suitable Cells In
tracking area' }
    then { UE sets the EPS update status to EU3 ROAMING NOT ALLOWED, deletes any GUTI, last visited
registered TAI and KSI, resets the attach attempt counter, enters the state EMM-
DEREGISTERED.LIMITED-SERVICE and stores the current TAI in the list of "forbidden tracking areas for
roaming" }
}
```

(2)

```
with { UE is in EMM-DEREGISTERED.LIMITED-SERVICE state and the current TAI is in the list of
"forbidden tracking areas for roaming" }
ensure that {
  when { UE re-selects a cell that belongs to the TAI where UE was rejected }
    then { UE does not attempt to attach }
}
```

(3)

```
with { UE is in EMM-DEREGISTERED.LIMITED-SERVICE state and the current TAI is in the list of
"forbidden tracking areas for roaming" and KSI was deleted }
ensure that {
  when { in the same PLMN, UE enters a cell which provides normal service and belongs to the
tracking area not in the list of "forbidden tracking areas for roaming" }
    then { UE attempts to attach with IMSI indicated that no key is available }
}
```

(4)

```
with { UE is in EMM-DEREGISTERED.LIMITED-SERVICE state and the current TAI is in the list of
"forbidden tracking areas for roaming" }
ensure that {
  when { there are cells in the same PLMN and other PLMN that provide normal service and belong to
the tracking area not in the list of "forbidden tracking areas for roaming" }
    then { UE attempts to attach to the cell in the same PLMN }
}
```

(5)

```
with { UE is in EMM-DEREGISTERED.LIMITED-SERVICE state and the list of "forbidden tracking areas for
roaming" contains more than one TAI }
ensure that {
  when { UE re-selects a cell that belongs to one of the TAIs in the list of "forbidden tracking
areas for roaming" }
    then { UE does not attempt to attach }
}
```

(6)

```
with { UE has sent an ATTACH REQUEST message }
ensure that {
  when { UE receives an ATTACH REJECT message with the EMM cause set to 'No Suitable Cells In
tracking area' }
    then { UE deletes RAI, P-TMSI, P-TMSI signature, GPRS ciphering key sequence number, TMSI, LAI
and ciphering key sequence number }
}
```

(7)

```
with { UE is switched off }
ensure that {
  when { UE is powered on in the cell belonging to the TAI which was in the list of "forbidden
tracking areas for roaming" before UE was switched off }
    then { UE attempts to attach }
}
```

}

9.2.1.2.13.2 Conformance requirements

References: The conformance requirements covered in the present TC are specified in: TS 24.301, clause 5.3.2 and 5.5.1.3.5 and TS 24.008, clause 4.7.3.2.4.

[TS 24.301, clause 5.3.2]

The UE shall store a list of "forbidden tracking areas for roaming", as well as a list of "forbidden tracking areas for regional provision of service". These lists shall be erased when the UE is switched off or when the UICC containing the USIM is removed, and periodically (with a period in the range 12 to 24 hours). One or more tracking areas is removed from the list of "forbidden tracking areas for roaming" in the UE, as well as the list of "forbidden tracking areas for regional provision of service" if, after a subsequent procedure e.g. attach procedure, tracking area updating procedure and GUTI reallocation procedure, one or more tracking areas in the lists is received from the network.

In S1 mode, the UE shall update the suitable list whenever an ATTACH REJECT, TRACKING AREA UPDATE REJECT, SERVICE REJECT or DETACH REQUEST message is received with the EMM cause #12 "tracking area not allowed", #13 "roaming not allowed in this tracking area", or #15 "no suitable cells in tracking area".

Each list shall accommodate 40 or more TAIs. When the list is full and a new entry has to be inserted, the oldest entry shall be deleted.

[TS 24.301, clause 5.5.1.3.5]

If the attach request can neither be accepted by the network for EPS nor for non-EPS services, the MME shall send an ATTACH REJECT message to the UE including an appropriate EMM cause value. If the attach procedure fails due to a default EPS bearer setup failure or an ESM procedure failure, the MME shall combine the ATTACH REJECT message with a PDN CONNECTIVITY REJECT message. In this case the EMM cause value in the ATTACH REJECT message shall be set to #19, "ESM failure".

Upon receiving the ATTACH REJECT message, the UE shall stop timer T3410, enter MM state MM IDLE, and take the following actions depending on the EMM cause value received.

...

#15 (No suitable cells in tracking area);

The UE shall set the EPS update status to EU3 ROAMING NOT ALLOWED (and shall store it according to subclause 5.1.3.3) and shall delete any GUTI, last visited registered TAI and KSI. Additionally the UE shall reset the attach attempt counter and enter the state EMM-DEREGISTERED.LIMITED-SERVICE.

The UE shall store the current TAI in the list of "forbidden tracking areas for roaming".

The UE shall search for a suitable cell in another tracking area or in another location area in the same PLMN according to 3GPP TS 36.304 [21].

If A/Gb mode or Iu mode is supported by the UE, the UE shall in addition handle the MM parameters update status, TMSI, LAI, ciphering key sequence number and location update attempt counter, and the GMM parameters GMM state, GPRS update status, P-TMSI, P-TMSI signature, RAI, GPRS ciphering key sequence number and GPRS attach attempt counter as specified in 3GPP TS 24.008 [13] for the case when the combined attach procedure is rejected with the GMM cause with the same value.

...

[TS 24.008, clause 4.7.3.2.4]

...

The MS shall then take one of the following actions depending upon the reject cause:

...

15 (No Suitable Cells In Location Area);

The MS shall delete any RAI, P-TMSI, P-TMSI signature and GPRS ciphering key sequence number, shall set the GPRS update status to GU3 ROAMING NOT ALLOWED (and shall store it according to clause 4.1.3.2) and shall reset the GPRS attach attempt counter. The state is changed to GMM-DEREGISTERED.LIMITED-SERVICE.

The MS shall set the update status to U3 ROAMING NOT ALLOWED, reset the location update attempt counter and shall delete any TMSI, LAI and ciphering key sequence number. The new MM state is MM IDLE.

...

9.2.1.2.13.3 Test description

9.2.1.2.13.3.1 Pre-test conditions

System Simulator:

- cell I and cell K (visited PLMN, same TA);
- cell E (same visited PLMN, another TA);
- cell J (another VPLMN);
- if pc_UTRA AND px_RATComb_Tested = EUTRA_UTRA, cell 8 (only active when stated):
 - same PLMN like visited PLMN above;
 - RAI-1 (RAC & LAC values chosen by SS);
 - system information indicates that NMO 1 is used;
- if pc_GERAN AND px_RATComb_Tested = EUTRA_GERAN, cell 24 (only active when stated):
 - same PLMN like visited PLMN above;
 - RAC-1 (RAC & LAC values chosen by SS);
 - system information indicates that NMO 1 is used;
 - maximum 3 cells are simultaneously active.
- System information combination 10 as defined in TS 36.508 [18] clause 4.4.3.1 is used in E-UTRA cells.
- the cells are configured according to Table 6.3.2.2-1 and Table 6.3.2.2-3 in 36.508 [18], except replacing f4 with f1.

NOTE 1: Setting px_RATComb_Tested = EUTRA_Only is not allowed.

NOTE 2: Cell E is present to confirm that UE searches in the same PLMN after reject from the SS.

NOTE 3: Cell K is present to confirm that UE shall not attempt attach to the cell in same TAI it was once rejected from.

NOTE 4: The requirement in 3GPP TS 24.301 to store at least 40 entries in the list of "forbidden tracking areas for roaming" is not fully tested.

NOTE 5: Different types of UE may use different methods to periodically clear the list of forbidden areas (e.g. every day at 12 am) for roaming. If the list is cleared while the test is being run, it may be necessary to re-run the test.

UE:

- the UE is configured to initiate combined EPS/IMSI attach;
- the UE is previously registered on E-UTRAN, and when on E-UTRAN, the UE is last authenticated and registered on cell I using default message contents according to TS 36.508 [18];
- if pc_UTRA AND px_RATComb_Tested = EUTRA_UTRA, the UE is previously registered on UTRAN cell 8 using default message contents according to TS 36.508 [18].

- if pc_GERAN AND px_RATComb_Tested = EUTRA_GERAN, the UE is previously registered on GERAN cell 24 using default message contents according to TS 36.508 [18].

Preamble:

- the UE is in state Switched OFF (state 1) according to TS 36.508 [18].

9.2.1.2.13.3.2 Test procedure sequence

Table 9.2.1.2.13.3.2-1: Main behaviour

St	Procedure	Message Sequence		TP	Verdict
		U - S	Message		
1	The SS configures: Cell I as the "Serving cell", Cell K as a "Suitable cell", Cell E as a "Non-Suitable cell", Cell J as a "Non-Suitable" off" cell".	-	-	-	-
-	The following messages are to be observed on Cell I unless explicitly stated otherwise.	-	-	-	-
2	The UE is switched on.	-	-	-	-
3	The UE transmits an ATTACH REQUEST message including a PDN CONNECTIVITY REQUEST message.	-->	ATTACH REQUEST	-	-
4	The SS transmits an ATTACH REJECT message with the EMM cause set to 'No suitable cells in tracking area' on Cell I. (The list of "forbidden tracking areas for roaming" in the UE should now contain TAI-9)	<--	ATTACH REJECT	-	-
5	The SS releases the RRC connection.	-	-	-	-
6	The SS reconfigures: Cell I as a "Suitable cell", Cell K as the "Serving cell", Cell E as a "Non-Suitable cell", Cell J as a "Non-Suitable" off" cell".	-	-	-	-
7	Check: Does the UE transmit an ATTACH REQUEST message in the next 30 seconds on Cell K or Cell I?	-->	ATTACH REQUEST	2	F
7A	If possible (see ICS) switch off is performed or the USIM is removed. Otherwise the power is removed.	-	-	-	-
7B	The SS configures: Cell I as the "Serving cell", Cell K as a "Suitable cell",	-	-	-	-
7C	The UE is brought back to operation or the USIM is inserted.	-	-	-	-
-	The following messages are to be observed on Cell I unless explicitly stated otherwise.	-	-	-	-
7D	The UE transmits an ATTACH REQUEST message including a PDN CONNECTIVITY REQUEST message.	-->	ATTACH REQUEST	-	-
7E	The SS transmits an ATTACH REJECT message with the EMM cause set to 'No suitable cells in tracking area' on Cell I. (The list of "forbidden tracking areas for roaming" in the UE should now contain TAI-9)	<--	ATTACH REJECT	-	-
8	The SS reconfigures: Cell K as a "Non-Suitable "off" cell", Cell E as a "Suitable cell", Cell J as a "Suitable cell".	-	-	-	-
8A	The SS releases the RRC connection.	-	-	-	-
9	Check: Does the UE transmit an ATTACH REQUEST message including a PDN CONNECTIVITY REQUEST message on Cell E? Note: Cell J is present to ensure the UE doesn't attempt to attach in a cell with a different PLMN	-->	ATTACH REQUEST	1, 3, 4, 6	P
9A	The SS reconfigures: Cell J as a "Non-Suitable "off" cell".	-	-	-	-
10	The SS transmits an ATTACH REJECT message with the EMM cause set to 'No suitable cells in tracking area' on Cell E. (The list of "forbidden tracking areas for	<--	ATTACH REJECT	-	-

	roaming" in the UE should now contain TAI-9 and TAI-12)				
11	The SS releases the RRC connection	-	-	-	-
12	The SS reconfigures: Cell I as the "Serving cell". Cell K as a "Non-Suitable cell", Cell E as a "Suitable cell".	-	-	-	-
13	Check: Does the UE transmit the ATTACH REQUEST message in the next 30 seconds on Cell I?	-->	ATTACH REQUEST	5	F
-	EXCEPTION: Steps 14a1 to 14a4 describe behaviour that depends on the UE capability; the "lower case letter" identifies a step sequence that take place if a capability is supported	-	-	-	-
14a1	The SS configures: Cell I as a "Non-Suitable cell", Cell E as a "Non-Suitable cell", Cell J and Cell K as a "Non-Suitable "off" cell". Cell 8 (px_RATComb_Tested = EUTRA_UTRA) or Cell 24 (px_RATComb_Tested = EUTRA_GERAN) as the "Serving cell".	-	-	-	-
-	The following messages are to be observed on Cell 8 or Cell 24 unless explicitly stated otherwise.	-	-	-	-
14a2	Void	-	-	-	-
14a3	Check: Does the UE transmit an ATTACH REQUEST message?	-->	ATTACH REQUEST	6	P
14a4	The SS transmits an ATTACH REJECT message with the GMM cause set to 'No Suitable Cells In Location Area'.	<--	ATTACH REJECT	-	-
14a5	The SS releases the RRC connection	-	-	-	-
14A	If possible (see ICS) switch off is performed or the USIM is removed. Otherwise the power is removed.	-	-	-	-
15	The SS reconfigures: Cell I as the "Serving cell". Cell K as a "Non-Suitable "off" cell", Cell E as a "Non-Suitable cell", Cell J as a "Non-Suitable "off" cell", Cell 8 or Cell 24 as the "Non-Suitable cell".	-	-	-	-
-	The following messages are to be observed on Cell I unless explicitly stated otherwise.	-	-	-	-
16	Void	-	-	-	-
17	The UE is brought back to operation or the USIM is inserted.	-	-	-	-
18	Check: Does the UE transmit an ATTACH REQUEST message including a PDN CONNECTIVITY REQUEST message?	-->	ATTACH REQUEST	7	P
19-30	The attach procedure is completed by executing steps 5 to 16 of the UE registration procedure in TS 36.508 sub clause 4.5.2.3.	-	-	-	-
-	At the end of this test procedure sequence, the UE is in end state E-UTRA connected (E2) according to TS 36.508.	-	-	-	-

9.2.1.2.13.3.3 Specific message contents

Table 9.2.1.2.13.3.3-1: Message ATTACH REJECT (step 4 and step 10, Table 9.2.1.2.13.3.2-1)

Derivation Path: TS 36.508, Table 4.7.2-3			
Information Element	Value/remark	Comment	Condition
EMM cause	'0000 1111'B	No Suitable Cells In tracking area	

Table 9.2.1.2.13.3.3-2: Message ATTACH REQUEST (step 9 and step 18, Table 9.2.1.2.13.3.2-1)

Derivation Path: TS 36.508, Table 4.7.2-4			
Information Element	Value/remark	Comment	Condition
NAS key set identifier			
NAS key set identifier	'111'B	no key is available	
TSC	Any allowed value	TSC does not apply for NAS key set identifier value "111".	
Old GUTI or IMSI	IMSI-1		
Last visited registered TAI	Not present		
Old location area identification	Not present		
TMSI status	'0'B	no valid TMSI available	

Table 9.2.1.2.13.3.3-3: Message ATTACH REQUEST (step 14a3, Table 9.2.1.2.13.3.2-1)

Derivation Path: TS 24.008 , Table 9.4.1			
Information Element	Value/remark	Comment	Condition
MS network capability	Any allowed value		
Attach type	'011'B	Combined GPRS/IMSI attach	
GPRS ciphering key sequence number	'111'B	No key is available (MS to network)	
DRX parameter	Any allowed value		
P-TMSI or IMSI	IMSI-1		
Old routing area identification	All bits of octets 5 and 6 are set to 1, except bit 1 of octet 6 which is set to 0. Other bits are not checked.		
MS Radio Access capability	Any allowed value		
Old P-TMSI signature	Not present		
Requested READY timer value	Not present or any allowed value		
TMSI status	'0'B	no valid TMSI available	
PS LCS Capability	Not present or any allowed value		
Mobile station classmark 2	Not present or any allowed value		
Mobile station classmark 3	Not present or any allowed value		
Supported Codecs	Not present or any allowed value		
UE network capability	Not present or any allowed value		
Additional mobile identity	Not present		
Additional old routing area identification	Not present		

Table 9.2.1.2.13.3.3-4: Message ATTACH REJECT (step 14a4, Table 9.2.1.2.13.3.2-1)

Derivation Path: TS 24.008 , Table 9.4.4			
Information Element	Value/remark	Comment	Condition
GMM cause	'0000 1111'B	No Suitable Cells In Location Area	
T3302 value	Not present		

9.2.1.2.14 Combined attach / Rejected / Not authorized for this CSG

9.2.1.2.14.1 Test Purpose (TP)

(1)

```
with { UE has sent an ATTACH REQUEST message including a PDN CONNECTIVITY REQUEST message on a CSG cell }
ensure that {
  when { UE receives an ATTACH REJECT message with the reject cause set to "Not authorized for this CSG" and without integrity protection }
  then { UE discards this message }
}
```

(2)

```
with { UE has sent an ATTACH REQUEST message including a PDN CONNECTIVITY REQUEST message on a CSG cell which is contained in the Allowed CSG list }
ensure that {
  when { UE receives an ATTACH REJECT message with the reject cause set to "Not authorized for this CSG" and with integrity protection }
  then { UE removes the CSG ID from the Allowed CSG list }
}
```

(3)

```
with { UE has sent an ATTACH REQUEST message including a PDN CONNECTIVITY REQUEST message on a CSG cell }
ensure that {
  when { UE receives an ATTACH REJECT message with the reject cause set to "Not authorized for this CSG" and with integrity protection }
  then { UE searches for a suitable cell in the same PLMN }
}
```

9.2.1.2.14.2 Conformance requirements

References: The conformance requirements covered in the current TC are specified in: TS 24.301, clause 5.5.1.2.5.

[TS 24.301, clause 5.5.1.2.5]

...

#25 (Not authorized for this CSG);

Cause #25 is only applicable when received from a CSG cell. Cause #25 received from a non-CSG cell is considered as an abnormal case and the behaviour of the UE is specified in subclause 5.5.1.2.6.

If the ATTACH REJECT message with cause #25 was received without integrity protection, then the UE shall discard the message.

The UE shall set the EPS update status to EU3 ROAMING NOT ALLOWED (and shall store it according to subclause 5.1.3.3). Additionally, the UE shall reset the attach attempt counter and shall enter the state EMM-DEREGISTERED.LIMITED-SERVICE.

The UE shall remove the CSG ID of the cell where the UE has sent the ATTACH REQUEST message from the Allowed CSG list.

The UE shall search for a suitable cell in the same PLMN according to 3GPP TS 36.304 [21].

If A/Gb mode or Iu mode is supported by the UE, the UE shall in addition handle the GMM parameters GMM state, GPRS update status and GPRS attach attempt counter as specified in 3GPP TS 24.008 [13] for the case when the normal attach procedure is rejected with the GMM cause with the same value.

9.2.1.2.14.3 Test description

9.2.1.2.14.3.1 Pre-test conditions

System Simulator:

- cell A (TAC-1, frequency 1, not a CSG cell);

- cell B (TAC-2, frequency 1, a CSG cell whose CSG Identity is included in Allowed CSG list);
- cell G (another PLMN, frequency 2 and not a CSG cell).
- System information combination 7 as defined in TS 36.508[18] clause 4.4.3.1 is used in E-UTRA cells.

UE:

- the UE is configured to initiate combined EPS/IMSI attach;
- the UE is previously registered on cell B using manual CSG selection (so the allowed CSG list includes CSG ID of cell B);
- the UE is previously registered on E-UTRAN, and when on E-UTRAN, the UE is last authenticated and registered on cell A using default message contents according to TS 36.508 [18].

Preamble:

- the UE is in state Switched OFF (state 1) according to TS 36.508 [18].

9.2.1.2.14.3.2 Test procedure sequence

Table 9.2.1.2.14.3.2-1: Main behaviour

St	Procedure	Message Sequence		TP	Verdict
		U - S	Message		
1	The SS configures: - Cell A as a "Not Suitable cell". - Cell B as a "Serving cell". - Cell G as a "Not Suitable cell".	-	-	-	-
2	The UE is switched on.	-	-	-	-
3	UE initiates attach procedure and sends ATTACH REQUEST including a PDN CONNECTIVITY REQUEST message on cell B.	-->	ATTACH REQUEST	-	-
4	The SS transmits an ATTACH REJECT message with EMM cause = "Not authorized for this CSG" without integrity protection.	<--	ATTACH REJECT	-	-
5	The SS releases the RRC connection.	-	-	-	-
6	Check: Does the UE transmit an ATTACH REQUEST message on Cell B after the expiry of timer T3410 and T3411? Note 1: IF UE initiate ATTACH procedure again, it can prove that this UE has discard the unprotected ATTACH REJECT message. Note 2: Default value of T3410 is 15s; default value of T3411 is 10s. In this TC, the network will wait for total 30 seconds.	-->	ATTACH REQUEST	1	P
7	The SS transmits an ATTACH REJECT message with EMM cause = ""Not authorized for this CSG" with integrity protection.	<--	ATTACH REJECT	-	-
8	The SS releases the RRC connection.	-	-	-	-
9	If possible (see ICS) switch off is performed or the USIM is removed. Otherwise the power is removed. The UE is brought back to operation or the USIM is inserted .	-	-	-	-
10	Check: Does the UE transmit an ATTACH REQUEST message on Cell B in the next 90 seconds?	-->	ATTACH REQUEST	2	F
11	The SS configures: - Cell B as a "Not Suitable cell". - Cell G as a "Serving cell". - Cell A as a "Suitable cell".				
12	Check: Does the UE transmit an ATTACH REQUEST message on Cell A?	-->	ATTACH REQUEST	3	P
13-24	The attach procedure is completed by executing steps 5 to 16 of the UE registration procedure in TS 36.508 sub clause 4.5.2.3.	-	-	-	-
-	At the end of this test procedure sequence, the UE is in end state E-UTRA connected (E2) according to TS 36.508.	-	-	-	-

9.2.1.2.14.3.3 Specific message contents

Table 9.2.1.2.14.3.3-1: Message ATTACH REQUEST (step 3, step 6, step 12, Table 9.2.1.2.14.3.2-1)

Derivation Path: TS 36.508 Table 4.7.2-4			
Information Element	Value/remark	Comment	Condition
Old GUTI or IMSI	GUTI-1		
Last visited registered TAI	TAI-1		
Old location area identification	LAI-1		
TMSI status	Not present		

Table 9.2.1.2.14.3.3-2: Message ATTACH REJECT (step 4, Table 9.2.1.2.14.3.2-1)

Derivation path: 36.508 table 4.7.2-3			
Information Element	Value/Remark	Comment	Condition
Security header type	'0000'B	" Plain NAS message, not security protected "	
EMM cause	'00011001'B	#25 " Not authorized for this CSG"	

Table 9.2.1.2.14.3.3-3: Message ATTACH REJECT (step 7, Table 9.2.1.2.14.3.2-1)

Derivation path: 36.508 table 4.7.2-3			
Information Element	Value/Remark	Comment	Condition
EMM cause	'00011001'B	#25 " Not authorized for this CSG"	

Table 9.2.1.2.14.3.3-4: SystemInformationBlockType1 for Cell A, B, G (Pre-test conditions and all steps in Table 9.2.1.2.14.3.2-1)

Derivation Path: 36.508 clause 4.4.3.2			
Information Element	Value/remark	Comment	Condition
SystemInformationBlockType1 ::= SEQUENCE {			
cellAccessRelatedInfo SEQUENCE {			
csg-Indication	TRUE		Cell B
	FALSE		Cell G
	FALSE		Cell A
csg-Identity	Not present		Cell A
	'000 0000 0000 0000 0000 0000 0010'B		Cell B
	Not present		Cell G

9.2.1.2.15 Combined attach / Abnormal case / Handling of the EPS attach attempt counter

9.2.1.2.15.1 Test Purpose (TP)

(1)

```
with { UE has detected T3410 expiry after sending an ATTACH REQUEST message and has the attach attempt counter set to the value less than five }
ensure that {
  when { UE detects T3411 expiry }
  then { UE restarts the attach procedure }
}
```

(2)

```
with { UE has sent an ATTACH REQUEST message and has the attach attempt counter set to five }
ensure that {
  when { UE detects T3410 expiry }
  then { UE deletes GUTI, TAI list, last visited registered TAI and KSI }
}
```

(3)

```
with { UE has sent an ATTACH REQUEST message and has the attach attempt counter set to five }
ensure that {
  when { UE detects T3410 expiry }
  then { UE deletes LAI, TMSI, ciphering key sequence number, RAI, P-TMSI, P-TMSI signature, and GPRS ciphering key sequence number }
}
```

9.2.1.2.15.2 Conformance requirements

References: The conformance requirements covered in the present TC are specified in: TS 24.301, clause 5.5.1.1, 5.5.1.2.6 and 5.5.1.3.6 and TS 24.008, clause 4.7.3.1.5.

[TS 24.301, clause 5.5.1.1]

...

An attach attempt counter is used to limit the number of subsequently rejected attach attempts. The attach attempt counter shall be incremented as specified in subclause 5.5.1.2.6. Depending on the value of the attach attempt counter, specific actions shall be performed. The attach attempt counter shall be reset when:

- the UE is powered on;
- a USIM is inserted;
- an attach or combined attach procedure is successfully completed;
- a combined attach procedure is completed for EPS services only with cause #2, #16, #17, #18 or #22;
- an attach or combined attach procedure is rejected with cause #11, #12, #13, #14, #15 or #25; or
- a network initiated detach procedure is completed with cause #11, #12, #13, #14, #15 or #25.

Additionally the attach attempt counter shall be reset when the UE is in sub state EMM-DEREGISTERED.ATTEMPTING-TO-ATTACH and:

- a new tracking area is entered; or
- T3402 expires.

[TS 24.301, clause 5.5.1.3.2]

If the UE is in EMM state EMM-DEREGISTERED, the UE initiates the combined attach procedure by sending an ATTACH REQUEST message to the network, starting timer T3410 and entering state EMM-REGISTERED-INITIATED (see example in figure 5.5.1.2.2.1).

The UE shall include the TMSI status IE if no valid TMSI is available. Furthermore, if the UE has stored a valid location area identification, the UE shall include it in the Old location area identification IE in the ATTACH REQUEST message.

If the UE initiates a combined attach procedure for EPS services and "SMS only", the UE shall indicate "SMS only" in the Additional update type IE.

[TS 24.301, clause 5.5.1.3.6]

...

If the attach attempt counter is incremented according to subclause 5.5.1.2.6 the next actions depend on the value of the attach attempt counter:

- if the update status is U1 UPDATED and the attach attempt counter is less than 5, then the UE shall keep the update status to U1 UPDATED, the new MM state is MM IDLE sub state NORMAL SERVICE;
- if the attach attempt counter is less than 5 and, additionally, the update status is different from U1 UPDATED, then the UE shall delete any LAI, TMSI, ciphering key sequence number and list of equivalent PLMNs and set the update status to U2 NOT UPDATED. The MM state remains MM LOCATION UPDATING PENDING; or
- if the attach attempt counter is equal to 5, then the UE shall delete any LAI, TMSI, ciphering key sequence number and list of equivalent PLMNs and set the update status to U2 NOT UPDATED. A UE operating in CS/PS mode 1 of operation shall select GERAN or UTRAN radio access technology and proceed with appropriate MM or GMM specific procedures.

NOTE: It is up to the UE implementation when to enable E-UTRAN radio access technology selection.

[TS 24.008, clause 4.7.3.1.5]

...

If the GPRS attach attempt counter is greater than or equal to 5:

- the MS shall delete any RAI, P-TMSI, P-TMSI signature, list of equivalent PLMNs, and GPRS ciphering key sequence number, shall set the GPRS update status to GU2 NOT UPDATED, shall start timer T3302. The state is changed to GMM-DEREGISTERED. ATTEMPTING-TO-ATTACH or optionally to GMM-DEREGISTERED.PLMN-SEARCH (see subclause 4.2.4.1.2) in order to perform a PLMN selection according to 3GPP TS 23.122 [14].

...

9.2.1.2.15.3 Test description

9.2.1.2.15.3.1 Pre-test conditions

System Simulator:

- cell A;
- if pc_UTRA AND px_RATComb_Tested = EUTRA_UTRA, cell 5 (only active when stated):
 - same PLMN like visited PLMN above;
 - RAI-1 (RAC & LAC values chosen by SS);
 - System information indicates that NMO 1 is used;
- if pc_GERAN AND px_RATComb_Tested = EUTRA_GERAN, cell 24 (only active when stated):
 - same PLMN like visited PLMN above;
 - RAC-1 (RAC & LAC values chosen by SS);
 - System information indicates that NMO 1 is used;
- System information combination 10 as defined in TS 36.508[18] clause 4.4.3.1 is used in E-UTRA cells.

NOTE: Setting px_RATComb_Tested = EUTRA_Only is not allowed.

UE:

- the UE is configured to initiate combined EPS/IMSI attach.
- the UE is previously registered on E-UTRAN, and when on E-UTRAN, the UE is last authenticated and registered on cell A using default message contents according to TS 36.508 [18];
- if pc_UTRA AND px_RATComb_Tested = EUTRA_UTRA, the UE is previously registered on UTRAN cell 5 using default message contents according to TS 36.508 [18].
- if pc_GERAN AND px_RATComb_Tested = EUTRA_GERAN, the UE is previously registered on GERAN cell 24 using default message contents according to TS 36.508 [18].

Preamble:

- the UE is in state Switched OFF (state 1) according to TS 36.508 [18].

9.2.1.2.15.3.2 Test procedure sequence

Table 9.2.1.2.15.3.2-1: Main behaviour

St	Procedure	Message Sequence		TP	Verdict
		U - S	Message		
1	The SS reconfigures: Cell A as "Serving cell", Cell 5 or Cell 24 as "Non-Suitable cell".	-	-	-	-
-	The following messages are to be observed on Cell A unless explicitly stated otherwise.	-	-	-	-
2	The UE is powered on or switched on.	-	-	-	-
3	The UE transmits an ATTACH REQUEST message including a PDN CONNECTIVITY REQUEST message.	-->	ATTACH REQUEST	-	-
4	Wait for 25s to ensure that T3410 and T3411 expire and the UE releases locally the NAS signalling connection. NOTE 1: The attach attempt counter is 1.	-	-	-	-
5	Check: Does the UE transmit an ATTACH REQUEST message including a PDN CONNECTIVITY REQUEST message?	-->	ATTACH REQUEST	1	P
6	Wait for 25s to ensure that T3410 and T3411 expire and the UE releases locally the NAS signalling connection. NOTE 2: The attach attempt counter is 2.	-	-	-	-
7	The UE transmits an ATTACH REQUEST message including a PDN CONNECTIVITY REQUEST message.	-->	ATTACH REQUEST	-	-
8	Wait for 25s to ensure that T3410 and T3411 expire and the UE releases locally the NAS signalling connection. NOTE 3: The attach attempt counter is 3.	-	-	-	-
9	The UE transmits an ATTACH REQUEST message including a PDN CONNECTIVITY REQUEST message.	-->	ATTACH REQUEST	-	-
10	Wait for 25s to ensure that T3410 and T3411 expire and the UE releases locally the NAS signalling connection. NOTE 4: The attach attempt counter is 4.	-	-	-	-
11	The UE transmits an ATTACH REQUEST message including a PDN CONNECTIVITY REQUEST message.	-->	ATTACH REQUEST	-	-
12	Wait for 15s to ensure that T3410 expire and the UE releases locally the NAS signalling connection. NOTE 5: The attach attempt counter is 5.	-	-	-	-
-	EXCEPTION: Steps 13a1 to 13a2 describe behaviour that depends on the UE capability; the "lower case letter" identifies a step sequence that take place if a capability is supported	-	-	-	-
13a1	The SS reconfigures: Cell A as "Non-suitable cell", Cell 5 (px_RATComb_Tested = EUTRA_UTRA) or Cell 24 (px_RATComb_Tested = EUTRA_GERAN) as "Serving cell".	-	-	-	-
13a2	Check: Does the UE transmit an ATTACH REQUEST message without P-TMSI, P-TMSI signature, RAI, TMSI on Cell 5 or Cell 24?	-->	ATTACH REQUEST	3	P
13A1	If possible (see ICS) switch off is performed or the USIM is removed. Otherwise the power is removed.	-	-	-	-
	EXCEPTION: Step 13Aa1 describes behaviour that depends on the UE capability.				
13Aa 1	If pc_SwitchOnOff or pc_USIM_Removal then the UE transmits a DETACH REQUEST	-->	DETACH REQUEST	-	-

	message				
14	The SS reconfigures: Cell A as "Serving cell", Cell 5 or Cell 24 as "Non-Suitable Off cell".	-	-	-	-
-	The following messages are to be observed on Cell A unless explicitly stated otherwise.	-	-	-	-
15	Void	-	-	-	-
16	The UE is brought back to operation or the USIM is inserted. NOTE 6: The attach attempt counter is reset.	-	-	-	-
17- 26	Void	-	-	-	-
27	Check: Does the UE transmit an ATTACH REQUEST message including a PDN CONNECTIVITY REQUEST?	-->	ATTACH REQUEST	2	P
28- 49	The attach procedure is completed by executing steps 5 to 16 of the UE registration procedure in TS 36.508 sub clause 4.5.2.3.	-	-	-	-
-	At the end of this test procedure sequence, the UE is in end state E-UTRA connected (E2) according to TS 36.508.	-	-	-	-

9.2.1.2.15.3.3 Specific message contents

Table 9.2.1.2.15.3.3-1: Message ATTACH REQUEST (step 13a2, Table 9.2.1.2.15.3.2-1)

Derivation Path: TS 24.008 , Table 9.4.1			
Information Element	Value/remark	Comment	Condition
MS network capability	Any allowed value		
Attach type	'011'B	Combined GPRS/IMSI attach	
GPRS ciphering key sequence number	'111'B	No key is available (MS to network)	
DRX parameter	Any allowed value		
P-TMSI or IMSI	IMSI-1		
Old routing area identification	All bits of octets 5 and 6 are set to 1, except bit 1 of octet 6 which is set to 0. Other bits are not checked.		
MS Radio Access capability	Any allowed value		
Old P-TMSI signature	Not present		
Requested READY timer value	Not present or any allowed value		
TMSI status	'0'B	no valid TMSI available	
PS LCS Capability	Not present or any allowed value		
Mobile station classmark 2	Not present or any allowed value		
Mobile station classmark 3	Not present or any allowed value		
Supported Codecs	Not present or any allowed value		
UE network capability	Not present or any allowed value		
Additional mobile identity	Not present		
Additional old routing area identification	Not present		

Table 9.2.1.2.15.3.3-2: Message ATTACH REQUEST (step 27, Table 9.2.1.2.15.3.2-1)

Derivation Path: TS 36.508, Table 4.7.2-4			
Information Element	Value/remark	Comment	Condition
NAS key set identifier			
NAS key set identifier	'111'B	no key is available	
TSC	Any allowed value	TSC does not apply for NAS key set identifier value "111".	
Old GUTI or IMSI	IMSI-1		
Last visited registered TAI	Not present		
Old location area identification	Not present		
TMSI status	'0'B	no valid TMSI available	

9.2.2 Detach procedure

9.2.2.1 UE initiated detach procedure

9.2.2.1.1 UE initiated detach / UE switched off

9.2.2.1.1.1 Test Purpose (TP)

(1)

```
with { UE in EMM-REGISTERED state }
ensure that {
  when { the UE is switched off }
  then { the UE establishes the RRC connection with the RRC establishmentCause set to 'mo-Signalling' and sends DETACH REQUEST message, keeps the native security context, and deactivates the EPS bearer context(s) locally }
}
```

9.2.2.1.1.2 Conformance requirements

References: The conformance requirements covered in the present TC are specified in: 3GPP TS 24.301 clauses 5.3.1.1, 5.5.2.2.1, 5.5.2.2.2 and Annex D and TS 36.331 clause 5.3.3.3.

[TS 24.301 clause 5.3.1.1]

When the UE is in EMM-IDLE mode and needs to transmit an initial NAS message, the UE shall request the lower layer to establish a NAS signalling connection. In this request to the lower layer the NAS shall provide to the lower layer the RRC establishment cause and the call type as specified in annex D of this specification.

[TS24.301 clause 5.5.2.2.1]

The detach procedure is initiated by the UE by sending a DETACH REQUEST message. The Detach type IE included in the message indicates whether detach is due to a "switch off" or not. The Detach type IE also indicates whether the detach is for EPS services only, for non-EPS services only, or for both. If the UE has a mapped EPS security context as the current EPS security context, the UE shall set the type of security context flag to "mapped security context". Otherwise, the UE shall set the type of security context flag to "native security context".

...

If the UE is to be switched off, the UE shall try for a period of 5 seconds to send the DETACH REQUEST message. During this period, the UE may be switched off as soon as the DETACH REQUEST message has been sent.

After the last DETACH REQUEST message is sent, the UE shall proceed as follows:

- if the current EPS security context is a native EPS security context, then the UE shall store the current EPS security context as specified in annex C and mark it as valid;
- else if the current EPS security context is a mapped EPS security context and a non-current full native EPS security context exists, then the UE shall store the non-current EPS security context as specified in annex C and mark it as valid, and finally the UE shall delete any mapped EPS security context or partial native EPS security context.

[TS24.301 clause 5.5.2.2.2]

When the DETACH REQUEST message is received by the network, the network shall send a DETACH ACCEPT message to the UE and store the current EPS security context, if the Detach type IE does not indicate "switch off". Otherwise, the procedure is completed when the network receives the DETACH REQUEST message. On reception of a DETACH REQUEST message indicating "switch off", the MME shall delete the current EPS security context, if it is a mapped EPS security context.

The network and the UE shall deactivate the EPS bearer context(s) for this UE locally without peer-to-peer signalling between the UE and the MME.

The UE, when receiving the DETACH ACCEPT message, shall stop timer T3421.

The UE is marked as inactive in the network for EPS services. State EMM-DEREGISTERED is entered in the network.

The UE in PS mode of operation shall enter the EMM-DEREGISTERED state.

The UE in CS/PS mode 1 or CS/PS mode 2 of operation shall set the update status to U2 NOT UPDATED, disable E-UTRAN and select GERAN or UTRAN access technology and enter the EMM-NULL state.

[TS 24.301, Annex D]

...

Table D.1.1: Mapping of NAS procedure to establishment cause and call type

NAS procedure	RRC establishment cause (according 3GPP TS 36.331 [22])	Call type
...		
Detach	MO signalling (See Note 1)	"originating signalling"
...		
Note 1: For these NAS procedures initiated by UEs of access class 12, 13 or 14 in their home country, the RRC establishment cause will be set to "High priority access AC 11 – 15". For this purpose the home country is defined as the country of the MCC part of the IMSI, see 3GPP TS 22.011 [1A]. For these NAS procedures initiated by UE of access class 11 or 15 in their HPLMN or EHPLMN, the RRC establishment cause will be set to "High priority access AC 11 – 15".		

[TS 36.331, clause 5.3.3.3]

...

The UE shall set the contents of *RRConnectionRequest* message as follows:

- 1> set the *ue-Identity* as follows:
 - 2> if upper layers provide an S-TMSI:
 - 3> set the *ue-Identity* to the value received from upper layers;
 - 2> else
 - 3> draw a random value and set the *ue-Identity* to this value;

NOTE 1: Upper layers provide the S-TMSI if the UE is registered in the TA of the current cell.

- 1> Set the *establishmentCause* in accordance with the information received from upper layers;

9.2.2.1.1.3 Test description

9.2.2.1.1.3.1 Pre-test conditions

System Simulator:

- cell A (HPLMN).

UE:

none.

Preamble:

- the UE is in state Registered, Idle mode (State 2) according to TS 36.508 [18].

9.2.2.1.1.3.2 Test procedure sequence

Table 9.2.2.1.1.3.2-1: Main behaviour

St	Procedure	Message Sequence		TP	Verdict
		U - S	Message		
1	Cause switch off	-	-	-	-
2	Check: Does the UE transmit an <i>RRCCoalitionRequest</i> message with <i>establishmentCause</i> set to 'mo-Signalling' followed by a DETACH REQUEST with the Detach Type IE indicating "switch off"?	-->	DETACH REQUEST	1	P
2A	The SS releases the RRC connection.	-	-	-	-
3-7	Void	-	-	-	-
8	The UE is switched on	-	-	-	-
9	Check: Does the UE transmit ATTACH REQUEST message using KSI _{ASME} of the previously allocated EPS native security context?	-->	ATTACH REQUEST	1	P
10-21	The attach procedure is completed by executing steps 5 to 16 of the UE registration procedure in TS 36.508 sub clause 4.5.2.3.	-	-	-	-
-	At the end of this test procedure sequence, the UE is in end state E-UTRA connected (E2) according to TS 36.508.	-	-	-	-

9.2.2.1.1.3.3 Specific message contents

Table 9.2.2.1.1.3.3-1: Message *RRCCoalitionRequest* (step 2, Table 9.2.2.1.1.3.2-1)

Derivation path: 36.508 table 4.6.1-16			
Information Element	Value/Remark	Comment	Condition
<i>RRCCoalitionRequest</i> ::= SEQUENCE {			
<i>criticalExtensions</i> CHOICE {			
<i>rrcCoalitionRequest-r8</i> SEQUENCE {			
<i>establishmentCause</i>	mo-Signalling		
}			
}			
}			

Table 9.2.2.1.1.3.3-2: Message ATTACH REQUEST (step 9, Table 9.2.2.1.1.3.2-1)

Derivation path: 36.508 table 4.7.2-4 (Security protected NAS message)			
Information Element	Value/Remark	Comment	Condition
NAS key set identifier TSC	native security context (for KSI _{ASME})		

9.2.2.1.2 UE initiated detach / USIM removed from the UE

9.2.2.1.2.1 Test Purpose (TP)

(1)

```

with { UE in EMM-REGISTERED }
ensure that {
  when { the USIM is removed from the UE }
  then { the UE sends DETACH REQUEST message and indicates that the detach is for both EPS services
and non-EPS services or for EPS services depending on the EPS attach type used }
}

```

9.2.2.1.2.2 Conformance requirements

References: The conformance requirements covered in the present TC are specified in: 3GPP TS 24.301 clauses 5.5.2.2.1 and 5.5.2.2.3.

[TS24.301 clause 5.5.2.2.1]

The detach procedure is initiated by the UE by sending a DETACH REQUEST message. The Detach type IE included in the message indicates whether detach is due to a "switch off" or not. The Detach type IE also indicates whether the detach is for EPS services only, for non-EPS services only, or for both. If the UE has a mapped EPS security context as the current EPS security context, the UE shall set the type of security context flag to "mapped security context". Otherwise, the UE shall set the type of security context flag to "native security context".

If the UE has a valid GUTI, the UE shall populate the GUTI or IMSI IE with the valid GUTI. If the UE does not have a valid GUTI, the UE populates the GUTI or IMSI IE with its IMSI.

If the detach is not due to switch off and the UE is in the state EMM-REGISTERED or EMM-REGISTERED-INITIATED, timer T3421 shall be started in the UE after the DETACH REQUEST message has been sent. If the detach type indicates that the detach is for non-EPS services only the UE shall enter the state EMM-REGISTERED.IMSI-DETACH-INITIATED, otherwise the UE shall enter the state EMM-DEREGISTERED-INITIATED. If the detach type indicates that the detach is for non-EPS services or both EPS and non-EPS services, the UE shall enter the state MM IMSI DETACH PENDING.

[TS24.301 clause 5.5.2.2.3]

When the DETACH REQUEST message is received by the network, a DETACH ACCEPT message shall be sent to the UE, if the Detach type IE value indicates that the detach request has not been sent due to switching off. Depending on the value of the Detach type IE the following applies:

- combined EPS/IMSI detach:

The UE is marked as inactive in the network for EPS and for non-EPS services. The states EMM-DEREGISTERED and MM-NULL are entered in both the UE and the network.

9.2.2.1.2.3 Test description

9.2.2.1.2.3.1 Pre-test conditions

System Simulator:

- cell A (HPLMN).

UE:

none.

Preamble:

- the UE is in state Registered, Idle mode (State 2) according to TS 36.508 [18]

9.2.2.1.2.3.2 Test procedure sequence

Table 9.2.2.1.2.3.2-1: Main behaviour

St	Procedure	Message Sequence		TP	Verdict
		U - S	Message		
1	Cause removal of USIM from the UE without powering down	-	-	-	-
2	Check: Does the UE transmit a DETACH REQUEST with the Detach Type IE indicating "normal detach" or "power off" detach and "combined EPS/IMSI detach" or "EPS detach" depending on the UE configuration?	-->	DETACH REQUEST	1	P
-	EXCEPTION: Step 2a describe behaviour that depends on the UE implementation	-	-	-	-
2a	If in step 2 normal detach is performed SS responds with DETACH ACCEPT message	<--	DETACH ACCEPT	-	-
3	Check: Does the test result of generic procedure in TS 36.508 subclause 6.4.2.5 indicate that the UE does not respond to paging when paged with S-TMSI included in GUTI-1 and with CN domain indicator set to "PS"?	-	-	1	-

9.2.2.1.2.3.3 Specific message contents

Table 9.2.2.1.2.3.3-1: DETACH REQUEST (step 2, Table 9.2.2.1.2.3.2-1)

Derivation Path: 36.508, Table 4.7.2-11			
Information Element	Value/remark	Comment	Condition
Detach type			
Type of detach	001	EPS detach	EPSONlyAttach
	011	combined EPS/IMSI detach	CombinedAttach
Switch off	Not checked		
GUTI or IMSI	GUTI-1		

9.2.2.1.3 UE initiated detach / EPS capability of the UE is disabled

9.2.2.1.3.1 Test Purpose (TP)

(1)

```
with { CS/PS mode 1 UE or CS/PS mode 2 UE in EMM-REGISTERED state }
ensure that {
  when { EPS capability of the UE is disabled by disabling it's EPS services }
  then { UE sends the DETACH REQUEST message on the cell registered and indicates that the detach
is for EPS services }
}
```

(2)

```
with { CS/PS mode 1 UE or CS/PS mode 2 UE }
ensure that {
  when { EPS capability of the UE is disabled by disabling it's EPS services }
  then { UE selects GERAN or UTRAN radio access technology in order to enable the UE to continue to
obtain CS services }
}
```

9.2.2.1.3.2 Conformance requirements

References: The conformance requirement covered in the present TC is specified in: 3GPP TS 24.301 clause 5.5.2.1 and clauses 5.5.2.2

[TS 24.301, clause 5.5.2.1]

...

The detach procedure with appropriate detach type shall be invoked by the UE if the UE is switched off, the USIM card is removed from the UE or the UE has disabled EPS services or the UE wishes to detach for non-EPS services.

...

If the detach procedure for EPS services is performed, the EPS bearer context(s) for this particular UE are deactivated locally without peer-to-peer signalling between the UE and the MME.

Upon successful completion of the detach procedure, if the UE and the MME enter the EMM-DEREGISTERED state, the UE and the MME shall delete any mapped EPS security context or partial native EPS security context.

If the UE supports A/Gb mode or Iu mode, the UE shall store the TIN in the non-volatile memory in the ME, as described in annex C, for a subsequent attach procedure.

[TS 24.301, clause 5.5.2.2.1]

The detach procedure is initiated by the UE by sending a DETACH REQUEST message. The Detach type IE included in the message indicates whether detach is due to a "switch off" or not. The Detach type IE also indicates whether the detach is for EPS services only, for non-EPS services only, or for both. If the UE has a mapped EPS security context as the current EPS security context, the UE shall set the type of security context flag to "mapped security context". Otherwise, the UE shall set the type of security context flag to "native security context".

If the UE has a valid GUTI, the UE shall populate the GUTI or IMSI IE with the valid GUTI. If the UE does not have a valid GUTI, the UE populates the GUTI or IMSI IE with its IMSI.

If the detach is not due to switch off and the UE is in the state EMM-REGISTERED or EMM-REGISTERED-INITIATED, timer T3421 shall be started in the UE after the DETACH REQUEST message has been sent. If the detach type indicates that the detach is for non-EPS services only the UE shall enter the state EMM-REGISTERED.IMSI-DETACH-INITIATED, otherwise the UE shall enter the state EMM-DEREGISTERED-INITIATED. If the detach type indicates that the detach is for non-EPS services or both EPS and non-EPS services, the UE shall enter the state MM IMSI DETACH PENDING.

...

[TS 24.301, clause 5.5.2.2.2]

...

The network and the UE shall deactivate the EPS bearer context(s) for this UE locally without peer-to-peer signalling between the UE and the MME.

The UE, when receiving the DETACH ACCEPT message, shall stop timer T3421.

The UE is marked as inactive in the network for EPS services. State EMM-DEREGISTERED is entered in the network.

The UE in PS mode of operation shall enter the EMM-DEREGISTERED state.

The UE in CS/PS mode 1 or CS/PS mode 2 of operation shall set the update status to U2 NOT UPDATED, disable E-UTRAN and select GERAN or UTRAN access technology and enter the EMM-NULL state.

9.2.2.1.3.3 Test description

9.2.2.1.3.3.1 Pre-test conditions

System Simulator:

- Cell A.
- if pc_UTRA AND px_RATComb_Tested = EUTRA_UTRA, cell 5 (home PLMN, RAI-1, NMO 1) is set to "Suitable cell";
- if pc_GERAN AND px_RATComb_Tested = EUTRA_GERAN, cell 24 (home PLMN, RAI-1, NMO 1) is set to "Suitable cell";
- System information combination 10 as defined in TS 36.508[18] clause 4.4.3.1 is used in E-UTRA cells.

NOTE: Setting px_RATComb_Tested = EUTRA_Only is not allowed.

UE:

- the UE is configured to initiate combined EPS/IMSI attach .

Preamble:

- the UE is in state Registered, Idle mode (state 2) on cell A according to TS 36.508 [18].

9.2.2.1.3.3.2 Test procedure sequence

Table 9.2.2.1.3.3.2-1: Main behaviour

St	Procedure	Message Sequence		TP	Verdict
		U - S	Message		
1	Cause UE to disable the EPS services.	-	-	-	-
2	Check: Does the UE transmit a DETACH REQUEST message with the Detach type IE indicating "EPS detach" and "normal detach".	-->	DETACH REQUEST	1	P
3	The SS responds the DETACH ACCEPT message.	<--	DETACH ACCEPT	-	-
3A	The SS releases the RRC connection.	-	-	-	-
4	Void	-	-	-	-
-	EXCEPTION: Steps 5a1 to 5b6 describe behaviour that depends on the UE capability; the "lower case letter" identifies a step sequence that takes place if a capability is supported.	-	-	-	-
5a1	IF pc_UTRA AND px_RATComb_Tested = EUTRA_UTRA THEN	-	-	-	-
-	EXCEPTION: The behaviour in table 9.2.2.1.3.3.2-2 may occur in parallel with step 5a2.	-	-	-	-
5a2	Check: Does the UE send RRC CONNECTION REQUEST on Cell 5?	-->	-	1	P
5a3	The SS sends RRC CONNECTION SETUP	<--	-	-	-
5a4	The UE sends RRC CONNECTION SETUP COMPLETE	-->	-	1	P
5a5	Check: Does the UE transmit a LOCATION UPDATING REQUEST on Cell 5?	-->	LOCATION UPDATING REQUEST	2	P
5a6	The SS transmits an AUTHENTICATION AND CIPHERING REQUEST message.	<--	AUTHENTICATION AND CIPHERING REQUEST	-	-
5a7	The UE transmits an AUTHENTICATION AND CIPHERING RESPONSE message.	-->	AUTHENTICATION AND CIPHERING RESPONSE	-	-
5a8	The SS transmits a LOCATION UPDATING ACCEPT message on Cell 5.	<--	LOCATION UPDATING ACCEPT	-	-
5a9	The UE transmits a TMSI REALLOCATION COMPLETE message	-->	TMSI REALLOCATION COMPLETE	-	-
5b1	ELSE IF pc_GERAN AND px_RATComb_Tested = EUTRA_GERAN THEN	-	-	-	-
5b2	Check: Does the UE transmit a LOCATION UPDATING REQUEST on Cell 24?	-->	LOCATION UPDATING REQUEST	2	P
5b2 A	The UE transmits a <i>Classmark Change</i> message	-->	CLASSMARK CHANGE		
-	EXCEPTION: Step 5b2B describes behaviour that depends on UE capability.	-	-	-	-
5b2 B	IF pc_UTRA THEN the UE transmits a <i>Utran Classmark Change</i> message.	-->	UTRAN CLASSMARK CHANGE.		
5b3	The SS transmits an AUTHENTICATION REQUEST message.	<--	AUTHENTICATION REQUEST	-	-
5b4	The UE transmits an AUTHENTICATION RESPONSE message.	-->	AUTHENTICATION RESPONSE	-	-
5b5	The SS transmits a LOCATION UPDATING ACCEPT message on Cell 24.	<--	LOCATION UPDATING ACCEPT	-	-
5b5 A	The UE transmits a TMSI REALLOCATION COMPLETE message	-->	TMSI REALLOCATION COMPLETE	-	-
5b6	Check: Does the UE transmit a ROUTING AREA UPDATE REQUEST on Cell 24?	-->	ROUTING AREA UPDATE REQUEST	2	F

Table: 9.2.2.1.3.3.2-2: Parallel behaviour

St	Procedure	Message Sequence		TP	Verdict
		U - S	Message		
1	Check: Does the UE transmit a ROUTING AREA UPDATE REQUEST on Cell 5?	-->	ROUTING AREA UPDATE REQUEST	2	F

9.2.2.1.3.3.3 Specific message contents

Table 9.2.2.1.3.3.3-1: DETACH REQUEST (steps 2 in Table 9.2.2.1.3.3.2-1)

Derivation Path: 36.508, Table 4.7.2-11			
Information Element	Value/remark	Comment	Condition
Detach type			
Type of detach	001	EPS detach only	
Switch off	0	normal detach	
GUTI or IMSI	GUTI-1		

Table 9.2.2.1.3.3.3-2: Message RRC Connection Request (step 5a2 in Table 9.2.2.1.3.3.2-1)

Derivation path: 34.108 sub-clause 9.1.1			
Information Element	Value/Remark	Comment	Condition
Pre-redirection info		Optional IE, but if transmitted it should have the below values	
> Support of E-UTRA FDD	False	E-UTRA FDD not supported	
> Support of E-UTRA TDD	False	E-UTRA TDD not supported	

Table 9.2.2.1.3.3.3-3: Message RRC Connection Setup Complete (step 5a4 in Table 9.2.2.1.3.3.2-1)

Derivation path: 34.108 sub-clause 9.1.1			
Information Element	Value/Remark	Comment	Condition
UE radio access capability		The UE shall not indicate support for E-UTRAN	
>UE multi-mode/multi-RAT capability			
>> Multi-RAT capability			
>>> Support of Inter-RAT PS Handover to E-UTRA FDD	Not present		
>>> Support of E-UTRA TDD	Not present		
>>> Support of Inter-RAT PS Handover to E-UTRA TDD	Not present		
>>> EUTRA Feature Group Indicators	Not checked		

9.2.2.1.4 UE initiated detach / detach for non-EPS services

9.2.2.1.4.1 Test Purpose (TP)

(1)

```

with { UE in EMM-REGISTERED state }
ensure that {
  when { UE is detached for non-EPS services }
  then { UE sends the DETACH REQUEST message on the cell registered and indicates a IMSI detach }
}

```

9.2.2.1.4.2 Conformance requirements

References: The conformance requirement covered in the present TC is specified in: 3GPP TS 24.301 clauses 5.5.2.1, 5.5.2.2.1 and 5.5.2.2.3.

[TS 24.301, clause 5.5.2.1]

...

The detach procedure with appropriate detach type shall be invoked by the UE if the UE is switched off, the USIM card is removed from the UE or the UE has disabled EPS services or the UE wishes to detach for non-EPS services.

[TS 24.301, clause 5.5.2.2.1]

The detach procedure is initiated by the UE by sending a DETACH REQUEST message (see example in figure 5.5.2.2.1.1). The Detach type IE included in the message indicates whether detach is due to a "switch off" or not. The Detach type IE also indicates whether the detach is for EPS services only, for non-EPS services only, or for both. If the UE has a mapped EPS security context as the current EPS security context, the UE shall set the type of security context flag to "mapped security context". Otherwise, the UE shall set the type of security context flag to "native security context".

If the UE has a valid GUTI, the UE shall populate the GUTI or IMSI IE with the valid GUTI. If the UE does not have a valid GUTI, the UE populates the GUTI or IMSI IE with its IMSI.

If the detach is not due to switch off and the UE is in the state EMM-REGISTERED or EMM-REGISTERED-INITIATED, timer T3421 shall be started in the UE after the DETACH REQUEST message has been sent. If the detach type indicates that the detach is for non-EPS services only the UE shall enter the state EMM-REGISTERED.IMSI-DETACH-INITIATED, otherwise the UE shall enter the state EMM-DEREGISTERED-INITIATED. If the detach type indicates that the detach is for non-EPS services or both EPS and non-EPS services, the UE shall enter the state MM IMSI DETACH PENDING.

[TS 24.301, clause 5.5.2.2.3]

When the DETACH REQUEST message is received by the network, a DETACH ACCEPT message shall be sent to the UE, if the Detach type IE value indicates that the detach request has not been sent due to switching off. Depending on the value of the Detach type IE the following applies:

- combined EPS/IMSI detach:

The UE is marked as inactive in the network for EPS and for non-EPS services. The states EMM-DEREGISTERED and MM-NULL are entered in both the UE and the network.

- IMSI detach:

The UE is marked as inactive in the network for non-EPS services. The states MM-NULL and EMM-REGISTERED are entered in both the UE and the network.

9.2.2.1.4.3 Test description

9.2.2.1.4.3.1 Pre-test conditions

System Simulator:

- Cell A is set to "Serving cell";
- Cell B is set to "Non-Suitable cell"

UE:

- the UE is configured to initiate combined EPS/IMSI attach.

Preamble:

- the UE is in state Registered, Idle mode (state 2) on cell A according to TS 36.508 [18].

9.2.2.1.4.3.2 Test procedure sequence

Table 9.2.2.1.4.3.2-1: Main behaviour

St	Procedure	Message Sequence		TP	Verdict
		U - S	Message		
1	Cause UE to initiate detach for non-EPS services.	-	-	-	-
2	Check: Does the UE transmit a DETACH REQUEST message with the Detach type IE indicating "IMSI detach" and "normal detach".	-->	DETACH REQUEST	1	P
3	The SS responds with DETACH ACCEPT message.	-	DETACH ACCEPT	-	-
3A	The SS releases the RRC Connection.	-	-	-	-
4	Set the cell type of cell A to the "Non-Suitable cell". Set the cell type of cell B to the "Serving cell"	-	-	-	-
5	Check: Does the UE transmit a TRACKING AREA UPDATE REQUEST message?	-->	TRACKING AREA UPDATE REQUEST	1	P
6	The SS transmits a TRACKING AREA UPDATE ACCEPT message.	<--	TRACKING AREA UPDATE ACCEPT	-	-
7	The UE transmits a TRACKING AREA UPDATE COMPLETE message?	-->	TRACKING AREA UPDATE COMPLETE	-	-

9.2.2.1.4.3.3 Specific message contents

Table 9.2.2.1.4.3.3-1: DETACH REQUEST (step 2 in Table 9.2.2.1.4.3.2-1)

Derivation Path: 36.508, Table 4.7.2-11			
Information Element	Value/remark	Comment	Condition
Detach type			
Type of detach	010	IMSI detach	
Switch off	0	normal detach	

Table 9.2.2.1.4.3.3-2: TRACKING AREA UPDATE REQUEST (step 5 in Table 9.2.2.1.4.3.2-1)

Derivation Path: 36.508, Table 4.7.2-27			
Information Element	Value/remark	Comment	Condition
EPS update type			
EPS update type value	'000'B	TA updating	

9.2.2.1.5 Void

9.2.2.1.6 UE initiated detach / Abnormal case / Local detach after 5 attempts due to no network response

9.2.2.1.6.1 Test Purpose (TP)

(1)

```
with { UE in EMM-REGISTERED state }
ensure that {
  when { the UE receives no response to the UE initiated DETACH REQUEST }
  then { the UE re-transmits the DETACH REQUEST up to 4 times on the expiry of timer T3421 }
}
```

(2)

```
with { UE in EMM-REGISTERED state }
ensure that {
  when { the UE receives no response to the UE initiated DETACH REQUEST }
  then { the UE aborts the detach procedure and perform local detach on the 5th expiry of timer T3421 }
}
```

9.2.2.1.6.2 Conformance requirements

References: The conformance requirements covered in the current TC are specified in: TS 24.301, clause 5.5.2.2.

[TS 24.301, clause 5.5.2.2.1]

The detach procedure is initiated by the UE by sending a DETACH REQUEST message. The Detach type IE included in the message indicates whether detach is due to a "switch off" or not. The Detach type IE also indicates whether the detach is for EPS services only, for non-EPS services only, or for both. If the UE has a mapped EPS security context as the current EPS security context, the UE shall set the type of security context flag to "mapped security context". Otherwise, the UE shall set the type of security context flag to "native security context".

If the UE has a valid GUTI, the UE shall populate the GUTI or IMSI IE with the valid GUTI. If the UE does not have a valid GUTI, the UE populates the GUTI or IMSI IE with its IMSI.

If the detach is not due to switch off and the UE is in the state EMM-REGISTERED or EMM-REGISTERED-INITIATED, timer T3421 shall be started in the UE after the DETACH REQUEST message has been sent. If the detach type indicates that the detach is for non-EPS services only the UE shall enter the state EMM-REGISTERED.IMSI-DETACH-INITIATED, otherwise the UE shall enter the state EMM-DEREGISTERED-INITIATED. If the detach type indicates that the detach is for non-EPS services or both EPS and non-EPS services, the UE shall enter the state MM IMSI DETACH PENDING.

[TS 24.301, clause 5.5.2.2.4 c)]

The following abnormal cases can be identified:

...

c) T3421 timeout

On the first four expiries of the timer, the UE shall retransmit the DETACH REQUEST message and shall reset and restart timer T3421. On the fifth expiry of timer T3421, the detach procedure shall be aborted and the UE shall change to state:

- EMM-REGISTERED.NORMAL-SERVICE and MM-NULL if "IMSI detach" was requested;
- EMM-DEREGISTERED if "EPS detach" was requested;
- EMM-DEREGISTERED and MM-NULL if "combined EPS/IMSI detach" was requested.

[TS 24.301, clause 5.1.3.2.2.2]

In the state EMM-DEREGISTERED, no EMM context has been established and the UE location is unknown to an MME and hence it is unreachable by an MME. In order to establish an EMM context, the UE shall start the attach or combined attach procedure (see subclause 5.5.1).

9.2.2.1.6.3 Test description

9.2.2.1.6.3.1 Pre-test conditions

System Simulator:

- cell A (HPLMN).

UE:

none.

Preamble:

- the UE is in state Registered, Idle Mode (State 2) according to TS 36.508 [18].

9.2.2.1.6.3.2 Test procedure sequence

Table 9.2.2.1.6.3.2-1: Main behaviour

St	Procedure	Message Sequence		TP	Verdict
		U - S	Message		
1	Cause UE to initiate detach.	-	-	-	-
2	The UE transmits a DETACH REQUEST message? The UE starts timer T3421.	-->	DETACH REQUEST	-	-
3	The SS does not respond to the DETACH REQUEST message.	-	-	-	-
4	Check: When the timer T3421 expires does the UE re-transmit DETACH REQUEST message. Timer T3421 is re-started (1 st expiry).	-->	DETACH REQUEST	1	P
5	The SS does not respond to the DETACH REQUEST message.	-	-	-	-
6	Check: When the timer T3421 expires does the UE re-transmit DETACH REQUEST message. Timer T3421 is re-started (2 nd expiry).	-->	DETACH REQUEST	1	P
7	The SS does not respond to the DETACH REQUEST message.	-	-	-	-
8	Check: When the timer T3421 expires does the UE re-transmit DETACH REQUEST message. Timer T3421 is re-started (3 rd expiry).	-->	DETACH REQUEST	1	P
9	The SS does not respond to the DETACH REQUEST message.	-	-	-	-
10	Check: When the timer T3421 expires does the UE re-transmit DETACH REQUEST message. Timer T3421 is re-started (4 th expiry).	-->	DETACH REQUEST	1	P
11	The SS does not respond to the DETACH REQUEST message.	-	-	-	-
12	When the timer T3421 expires the UE aborts the detach procedure and performs a local detach (5 th expiry).	-	-	2	P
13	The SS starts the EPS bearer context modification procedure using the previously allocated EPS bearer identity	<--	MODIFY EPS BEARER CONTEXT REQUEST	-	-
14	Check: Does the UE transmit a MODIFY EPS BEARER CONTEXT ACCEPT message within the next 10s?	-->	MODIFY EPS BEARER CONTEXT ACCEPT	2	F
15	Void	-	-	-	-
16a 1	Void	-	-	-	-

Note: T3421 value is specified as 15s in TS 24.301.

9.2.2.1.6.3.3 Specific message contents

Table 9.2.2.1.6.3.3-1: DETACH REQUEST (steps 2, 4, 6, 8 and 10 Table 9.2.2.1.6.3.2-1)

Derivation Path: 36.508, Table 4.7.2-11			
Information Element	Value/remark	Comment	Condition
Detach type			
Type of detach	001 or 011	EPS detach or combined EPS/IMSI detach	
Switch off	0	normal detach	
GUTI or IMSI	GUTI-1		

Table 9.2.2.1.6.3.3-2: Void**9.2.2.1.7 UE initiated detach / Abnormal case / Detach procedure collision****9.2.2.1.7.1 Test Purpose (TP)**

(1)

```

with { UE in EMM-DEREGISTERED-INITIATED state }
ensure that {
  when { the UE receives the DETACH REQUEST message from the network }
  then { the UE aborts the UE initiated detach procedure and completes the network initiated detach procedure }
}

```

(2)

```

with { UE in EMM-DEREGISTERED state }
ensure that {
  when { the UE has completed the network initiated detach procedure with re-attach required and the UE supports re-attach after DETACH collision }
  then { the UE initiates the attach procedure }
}

```

(3)

```

with { UE in EMM-DEREGISTERED state }
ensure that {
  when { the UE has completed the network initiated detach procedure with re-attach required and the UE does not support re-attach after DETACH collision }
  then { the UE does not initiate the attach procedure }
}

```

9.2.2.1.7.2 Conformance requirements

References: The conformance requirements covered in the current TC are specified in: TS 24.301, clause 5.5.2.2.4 and 5.5.2.3.2.

[TS 24.301, clause 5.5.2.2.4]

The following abnormal cases can be identified:

...

d) Detach procedure collision

If the UE receives a DETACH REQUEST message before the UE initiated detach procedure has been completed, it shall treat the message as specified in subclause 5.5.2.3.2 with the following modification: if the DETACH REQUEST message received by the UE contains detach type "re-attach required", and the UE initiated detach procedure is with detach type "EPS detach" or "combined EPS/IMSI detach", the UE need not initiate the attach or combined attach procedure.

[TS 24.301, clause 5.5.2.3.2]

When receiving the DETACH REQUEST message and the detach type indicates "re-attach required", the UE shall deactivate the EPS bearer context(s) including the default EPS bearer context locally without peer-to-peer signalling between the UE and the MME. The UE shall then send a DETACH ACCEPT message to the network and enter state EMM-DEREGISTERED. Furthermore, the UE shall, after the completion of the detach procedure, and the existing NAS signalling connection has been released, initiate an attach or combined attach procedure.

NOTE 1: When detach type indicates "re-attach required", user interaction is necessary in some cases when the UE cannot re-activate the EPS bearer(s) automatically.

9.2.2.1.7.3 Test description

9.2.2.1.7.3.1 Pre-test conditions

System Simulator:

- cell A.

UE:

none.

Preamble:

- the UE is in state Registered, Idle mode (State 2) according to TS 36.508 [18].

9.2.2.1.7.3.2 Test procedure sequence

Table 9.2.2.1.7.3.2-1: Main behaviour

St	Procedure	Message Sequence		TP	Verdict
		U - S	Message		
1	Cause UE to initiate detach.	-	-	-	-
2	The UE transmits a DETACH REQUEST message. The UE starts timer T3421.	-->	DETACH REQUEST	-	-
3	The SS does not respond to the DETACH REQUEST message.	-	-	-	-
4	With T3421 still running the SS shall send DETACH REQUEST message with the Detach type IE indicating "re-attach required".	<--	DETACH REQUEST	-	-
5	Check: Does the UE transmit a DETACH ACCEPT message?	-->	DETACH ACCEPT	1	P
6	The SS releases the RRC connection.	-	-	-	-
-	EXCEPTION: Step 7a1-7b1 describe a behaviour which depends on the UE capability	-	-	-	-
7a1	Void				
7a2	IF pc_Re_Attach_AfterDetachColl THEN Check: Does the UE transmit an ATTACH REQUEST message including a PDN CONNECTIVITY REQUEST message?	-->	ATTACH REQUEST	2	P
7a3-7a14	The attach procedure is completed by executing steps 5 to 16 of the UE registration procedure in TS 36.508 sub clause 4.5.2.3.	-	-	-	-
7a15	Cause UE to initiate detach.	-	-	-	-
7a16	The UE transmits a DETACH REQUEST with the Detach Type IE indicating "normal detach" and "combined EPS/IMSI detach" or "EPS detach" depending on the UE configuration .	-->	DETACH REQUEST	-	-
7a17	The SS responds with DETACH ACCEPT message	<--	DETACH ACCEPT	-	-
7a18	The SS releases the RRC connection	-	-	-	-
7b1	ELSE Check: Does the UE transmit an ATTACH REQUEST message including a PDN CONNECTIVITY REQUEST message in the next 30s?	-->	ATTACH REQUEST	3	F
-	At the end of this test procedure sequence, the UE is in end state E-UTRA deregistered (E4) according to TS 36.508.	-	-	-	-

9.2.2.1.7.3.3 Specific message contents

Table 9.2.2.1.7.3.3-1: DETACH REQUEST (steps 2 and 7a16 Table 9.2.2.1.7.3.2-1)

Derivation Path: 36.508, Table 4.7.2-11			
Information Element	Value/remark	Comment	Condition
Detach type			
Type of detach	001 or 011	EPS detach or combined EPS/IMSI detach	
Switch off	0	normal detach	
GUTI or IMSI	GUTI-1		

Table 9.2.2.1.7.3.3-2: DETACH REQUEST (step 4 Table 9.2.2.1.7.3.2-1)

Derivation Path: 36.508, Table 4.7.2-12			
Information Element	Value/remark	Comment	Condition
Detach type			
Type of detach	001	re-attach required	

Table 9.2.2.1.7.3.3-3: Message ATTACH REQUEST (step 7a2, Table 9.2.2.1.7.3.2-1)

Derivation path: 36.508 table 4.7.2-4			
Information Element	Value/Remark	Comment	Condition
EPS attach type	0001 or 0010	EPS attach or combined EPS/IMSI attach	

9.2.2.1.8 UE initiated detach / Abnormal case / Detach and EMM common procedure collision

9.2.2.1.8.1 Test Purpose (TP)

(1)

```
with { UE in EMM-DEREGISTERED-INITIATED state due to switch off }
ensure that {
  when { the UE receives an EMM common procedure message from the network }
  then { the UE ignores the message and continues the detach procedure }
}
```

(2)

```
with { UE in EMM-DEREGISTERED-INITIATED state due to normal detach }
ensure that {
  when { the UE receives GUTI REALLOCATION COMMAND from the network }
  then { the UE ignores the message and continues the detach procedure }
}
```

(3)

```
with { UE in EMM-DEREGISTERED-INITIATED state due to normal detach }
ensure that {
  when { the UE receives AUTHENTICATION REQUEST, SECURITY MODE COMMAND or IDENTITY REQUEST message from the network }
  then { the UE responds to the message and then continues the detach procedure }
}
```

9.2.2.1.8.2 Conformance requirements

References: The conformance requirements covered in the current TC are specified in: TS 24.301, clause 5.5.2.2.4.

[TS 24.301, clause 5.5.2.2.4]

The following abnormal cases can be identified:

...

e) Detach and EMM common procedure collision

Detach containing cause "switch off":

- If the UE receives a message used in an EMM common procedure before the detach procedure has been completed, this message shall be ignored and the detach procedure shall continue

Detach containing other causes than "switch off":

- If the UE receives a GUTI REALLOCATION COMMAND, an EMM STATUS or an EMM INFORMATION message before the detach procedure is completed, this message shall be ignored and the detach procedure shall continue.
- If the UE receives an AUTHENTICATION REQUEST, SECURITY MODE COMMAND or IDENTITY REQUEST message before the detach procedure has been completed, the UE shall respond to it as described in subclause 5.4.2, 5.4.3 and 5.4.4 respectively and the detach procedure shall continue.

9.2.2.1.8.3 Test description

9.2.2.1.8.3.1 Pre-test conditions

System Simulator:

- cell A.

UE:

none.

Preamble:

- the UE is in state Registered, Idle mode (State 2) according to TS 36.508[18].

9.2.2.1.8.3.2 Test procedure sequence

Table 9.2.2.1.8.3.2-1: Main behaviour

St	Procedure	Message Sequence		TP	Verdict
		U - S	Message		
1	Cause switch off.	-	-	-	-
2	The UE transmits a DETACH REQUEST message with the Detach type IE indicating "switch off".	-->	DETACH REQUEST	-	-
3	The SS transmits a GUTI REALLOCATION COMMAND message.	<--	GUTI REALLOCATION COMMAND	-	-
4	Check: Does the UE transmit an GUTI REALLOCATION COMPLETE message?	-->	GUTI REALLOCATION COMPLETE	1	F
5	Check: Does the test result of generic procedure in TS 36.508 subclause 6.4.2.5 indicate that the UE does not respond to paging when paged with S-TMSI included in GUTI-1 and with CN domain indicator set to "PS"?	-	-	1	-
6	The UE is switched on and performs an ATTACH procedure.	-	-	-	-
7	Cause UE to initiate detach.	-	-	-	-
8	The UE transmits a DETACH REQUEST message? The UE starts timer T3421.	-->	DETACH REQUEST	2	P
9	The SS does not respond to the DETACH REQUEST message.	-	-	-	-
10	With T3421 still running the SS shall send GUTI REALLOCATION COMMAND.	<--	GUTI REALLOCATION COMMAND	-	-
11	Check: Does the UE transmit a GUTI REALLOCATION COMPLETE message?	-->	GUTI REALLOCATION COMPLETE	2	F
12	SS responds with DETACH ACCEPT message.	<--	DETACH ACCEPT	-	-
13	The SS releases the RRC connection.	-	-	-	-
14	Cause UE to initiate attach. The generic procedure in 36.508 clause 4.5.2.3-1 is executed so as to complete the attach procedure (Note).	-	-	-	-
15	Cause UE to initiate detach.	-	-	-	-
16	The UE transmits a DETACH REQUEST message? The UE starts timer T3421.	-->	DETACH REQUEST	-	-
17	The SS does not respond to the DETACH REQUEST message.	-	-	-	-
18	With T3421 still running the SS shall send AUTHENTICATION REQUEST.	<--	AUTHENTICATION REQUEST	-	-
19	Check: Does the UE transmit an AUTHENTICATION RESPONSE message?	-->	AUTHENTICATION RESPONSE	3	P
20	SS responds with DETACH ACCEPT message.	<--	DETACH ACCEPT	-	-
21	The SS releases the RRC connection.	-	-	-	-
22	Cause UE to initiate attach. The generic procedure in 36.508 clause 4.5.2.3-1 is executed so as to complete the attach procedure (Note).	-	-	-	-
23	Cause UE to initiate detach.	-	-	-	-
24	The UE transmits a DETACH REQUEST message? The UE starts timer T3421.	-->	DETACH REQUEST	-	-
25	The SS does not respond to the DETACH REQUEST message.	-	-	-	-
26	With T3421 still running the SS shall send SECURITY MODE COMMAND.	<--	SECURITY MODE COMMAND	-	-
27	Check: Does the UE transmit a SECURITY MODE COMPLETE message?	-->	SECURITY MODE COMPLETE	3	P
28	SS responds with DETACH ACCEPT message.	<--	DETACH ACCEPT	-	-
29	The SS releases the RRC connection.	-	-	-	-
30	Cause UE to initiate attach. The generic	-	-	-	-

	procedure in 36.508 clause 4.5.2.3-1 is executed so as to complete the attach procedure (Note).				
31	Cause UE to initiate detach.	-	-	-	-
32	The UE transmits a DETACH REQUEST message? The UE starts timer T3421.	-->	DETACH REQUEST	-	-
33	The SS does not respond to the DETACH REQUEST message.	-	-	-	-
34	With T3421 still running the SS shall send IDENTITY REQUEST.	<--	IDENTITY REQUEST	-	-
35	Check: Does the UE transmit an IDENTITY RESPONSE message?	-->	IDENTITY RESPONSE	3	P
36	SS responds with DETACH ACCEPT message.	<--	DETACH ACCEPT	-	-
37	The SS releases the RRC connection.	-	-	-	-
Note: The request is triggered by either of the following AT commands, depending on UE capability: - IF pc_KeepEpsBearerParametersAfterNormalDetach THEN AT command AT+CGATT=1, or - ELSE AT command AT+CGDCONT=1,"IP" followed by AT+CGACT=1					

9.2.2.1.8.3.3 Specific message contents

Table 9.2.2.1.8.3.3-1: DETACH REQUEST (steps 8, 16, 24 and 32 Table 9.2.2.1.8.3.2-1)

Derivation Path: 36.508, Table 4.7.2-11			
Information Element	Value/remark	Comment	Condition
Detach type			
Type of detach	001 or 011	EPS detach or combined EPS/IMSI detach	
Switch off	0	normal detach	

Table 9.2.2.1.8.3.3-2: GUTI REALLOCATION COMMAND (step 3 Table 9.2.2.1.8.3.2-1)

Derivation Path: 36.508, Table 4.7.2-15			
Information Element	Value/remark	Comment	Condition
GUTI	GUTI-2		
TAI list	Not present		

Table 9.2.2.1.8.3.3-3: GUTI REALLOCATION COMMAND (step 10 Table 9.2.2.1.8.3.2-1)

Derivation Path: 36.508, Table 4.7.2-15			
Information Element	Value/remark	Comment	Condition
GUTI	GUTI-3		
TAI list	Not present		

Table 9.2.2.1.8.3.3-4: Message ATTACH REQUEST (steps 14, 22 and 30, Table 9.2.2.1.8.3.2-1)

Derivation path: 36.508 table 4.7.2-4			
Information Element	Value/Remark	Comment	Condition
EPS attach type	0001 or 0010	EPS attach or combined EPS/IMSI attach	

9.2.2.1.9 UE initiated detach / Abnormal case / Change of cell into a new tracking area

9.2.2.1.9.1 Test Purpose (TP)

(1)

```

with { UE in EMM-DEREGISTERED-INITIATED state }
ensure that {
  when { the UE changes into a new tracking area that is not in the stored TAI list }
  then { the UE aborts the detach procedure and initiates a Tracking Area Updating procedure }

```

}

(2)

```

with { UE in EMM-TRACKING-AREA-UPDATING-INITIATED state }
ensure that {
  when { the UE receives TRACKING AREA UPDATE ACCEPT message }
  then { the UE re-initiates the detach procedure after completing the Tracking Area Updating
procedure }
}

```

9.2.2.1.9.2 Conformance requirements

References: The conformance requirements covered in the current TC are specified in: TS 24.301, clause 5.5.2.2.4.

[TS 24.301, clause 5.5.2.2.4]

The following abnormal cases can be identified:

...

- b) Lower layer failure or release of the NAS signalling connection before reception of DETACH ACCEPT message

The detach procedure shall be aborted, and the UE shall enter state:

- EMM-REGISTERED.NORMAL-SERVICE and MM-NULL if "IMSI detach" was requested;
- EMM-DEREGISTERED if "EPS detach" was requested;
- EMM-DEREGISTERED and MM-NULL if "combined EPS/IMSI detach" was requested.

...

- f) Change of cell into a new tracking area

If a cell change into a new tracking area that is not in the stored TAI list occurs before the UE initiated detach procedure is completed, the detach procedure shall be aborted and re-initiated after successfully performing a tracking area updating procedure. If the detach procedure was initiated due to removal of the USIM, the UE shall abort the detach procedure and enter the state EMM-DEREGISTERED.

9.2.2.1.9.3 Test description

9.2.2.1.9.3.1 Pre-test conditions

System Simulator:

- cell A belongs to TAI-1 (home PLMN) is set to "Serving cell"
- cell B belongs to TAI-2 (home PLMN) is set to "Non-Suitable cell".
- System information combination 3 as defined in TS 36.508[18] clause 4.4.3.1 is used in E-UTRA cells.

UE:

none.

Preamble:

- the UE is in state Generic RB established (state 3) state Registered, Idle mode (State 2) according to [18].

9.2.2.1.9.3.2 Test procedure sequence

Table 9.2.2.1.9.3.2-1: Main behaviour

St	Procedure	Message Sequence		TP	Verdict
		U - S	Message		
-	The following messages are to be observed on Cell A unless explicitly stated otherwise.	-	-	-	-
1	Cause UE to initiate detach.	-	-	-	-
2	The UE transmits a DETACH REQUEST message. The UE starts timer T3421.	-->	DETACH REQUEST	-	-
3	The SS does not respond to the DETACH REQUEST message.	-	-	-	-
4	Set the cell type of cell A to the "Suitable neighbour cell". Set the cell type of cell B to the "Serving cell". Note: T3421 value is specified as 15s in TS 24.301 and it is assumed that SS can configure cells within this time.	-	-	-	-
4A	The SS transmits an <i>RRCCONNECTIONRECONFIGURATION</i> message on Cell A to order the UE to perform intra frequency handover to Cell B.	<--	-	-	-
4B	The UE transmits an <i>RRCCONNECTIONRECONFIGURATIONCOMPLETE</i> message on Cell B to confirm the successful completion of the intra frequency handover.	-->	-	-	-
-	The following messages are to be observed on Cell B unless explicitly stated otherwise.	-	-	-	-
5	Check: Does the UE transmit a TRACKING AREA UPDATE REQUEST message?	-->	TRACKING AREA UPDATE REQUEST	1	P
6	The SS transmits a TRACKING AREA UPDATE ACCEPT message.	<--	TRACKING AREA UPDATE ACCEPT	-	-
7	Check: Does the UE transmit a TRACKING AREA UPDATE COMPLETE message?	-->	TRACKING AREA UPDATE COMPLETE	-	-
8	The UE transmits a DETACH REQUEST message.	-->	DETACH REQUEST	2	P
9	SS responds with DETACH ACCEPT message	<--	DETACH ACCEPT	-	-
10	Check: Does the test result of generic procedure in TS 36.508 subclause 6.4.2.5 indicate that the UE does not respond to paging when paged with S-TMSI included in GUTI-2 and with CN domain indicator set to "PS"?	-	-	-	-

9.2.2.1.9.3.3 Specific message contents

Table 9.2.2.1.9.3.3-1: DETACH REQUEST (step 2, Table 9.2.2.1.9.3.2-1)

Derivation Path: 36.508, Table 4.7.2-11			
Information Element	Value/remark	Comment	Condition
Detach type			
Type of detach	001 or 011	EPS detach or combined EPS/IMSI detach	
Switch off	0	normal detach	
GUTI or IMSI	GUTI-1		

Table 9.2.2.1.9.3.3-2: Message TRACKING AREA UPDATE ACCEPT (step 6, Table 9.2.2.1.9.3.2-1)

Derivation path: 36.508 table 4.7.2-24			
Information Element	Value/Remark	Comment	Condition
GUTI	GUTI-2		

Table 9.2.2.1.9.3.3-3: RRCConnectionReconfiguration (step 4a, Table 9.2.2.1.9.3.2-1)

Derivation Path: 36.508, Table 4.6.1-8, condition HO			
Information Element	Value/Remark	Comment	Condition
RRCConnectionReconfiguration ::= SEQUENCE {			
criticalExtensions CHOICE {			
c1 CHOICE{			
rrcConnectionReconfiguration-r8 SEQUENCE {			
mobilityControllInfo SEQUENCE {	MobilityControllInfo-HO		
targetPhysCellId	PhysicalCellIdentity of Cell B (see 36.508 clause 4.6.5)		
carrierFreq	Not present		
}			
}			
}			
}			
}			

Table 9.2.2.1.9.3.3-4: Message TRACKING AREA UPDATE REQUEST (step 5, Table 9.2.2.1.9.3.2-1)

Derivation path: 36.508 table 4.7.2-27			
Information Element	Value/Remark	Comment	Condition
EPS update type			
Active Flag	Any allowed value		
EPS bearer context status	Not present or (octet 3 = '00100000'B and octet 4 = '00000000'B) or (octet 3 = '00000000'B and octet 4 = '00000000'B)		

Table 9.2.2.1.9.3.3-5: DETACH REQUEST (step 8, Table 9.2.2.1.9.3.2-1)

Derivation Path: 36.508, Table 4.7.2-11			
Information Element	Value/remark	Comment	Condition
Detach type			
Type of detach	001 or 011	EPS detach or combined EPS/IMSI detach	
Switch off	0	normal detach	
GUTI or IMSI	GUTI-2		

9.2.2.1.10 UE initiated detach / Mapped security context

9.2.2.1.10.1 Test Purpose (TP)

(1)

```
with { UE in EMM-REGISTERED state }
ensure that {
  when { the UE sent the last DETACH REQUEST }
  then { the UE delete the mapped security context }
}
```

9.2.2.1.10.2 Conformance requirements

References: The conformance requirements covered in the current TC are specified in: TS 24.301, clause 5.5.2.1.

[TS 24.301, clause 5.5.2.1]

Upon successful completion of the detach procedure, if the UE and the MME enter the EMM-DEREGISTERED state, the UE and the MME shall delete any mapped EPS security context or partial native EPS security context.

9.2.2.1.10.3 Test description

9.2.2.1.10.3.1 Pre-test conditions

System Simulator:

- Cell A and Cell 5.
- System information combination 4 as defined in TS 36.508[18] clause 4.4.3.1 is used in E-UTRA cell;

UE:

None.

Preamble:

- the UE is in state Switched OFF (state 1) according to TS 36.508 [18].

9.2.2.1.10.3.2 Test procedure sequence

Table 9.2.2.1.10.3.2-1: Main behaviour

St	Procedure	Message Sequence		TP	Verdict
		U -S	Message		
-	The SS configures: - Cell 5 as a "Non-Suitable Off cell". - Cell A as the "Serving cell".	-	-	-	-
1	The UE is switched on.	-	-	-	-
2	The UE transmits an ATTACH REQUEST message including a PDN CONNECTIVITY REQUEST message.	-->	ATTACH REQUEST	-	-
3	The SS transmits an ATTACH REJECT message with EMM cause = "EPS services and non-EPS services not allowed" as specified.	<--	ATTACH REJECT	-	-
4	The SS releases the RRC connection.	-	-	-	-
5	If possible (see ICS) switch off is performed or the USIM is removed. Otherwise the power is removed.	-	-	-	-
6	The SS configures: - Cell A as a "Non-Suitable Off cell". - Cell 5 as the "Serving cell".	-	-	-	-
7	The UE is brought back to operation or the USIM is inserted.	-	-	-	-
8	The UE transmits an ATTACH REQUEST message on Cell 5	-->	ATTACH REQUEST		
9	The SS transmits an AUTHENTICATION AND CIPHERING REQUEST message.	<--	AUTHENTICATION AND CIPHERING REQUEST		
10	The UE transmits an AUTHENTICATION AND CIPHERING RESPONSE message.	-->	AUTHENTICATION AND CIPHERING RESPONSE		
11	SS responds with ATTACH ACCEPT message including P-TMSI-1 and RAI-1.	<--	ATTACH ACCEPT	-	-
12	The UE transmits an ATTACH COMPLETE message.	-->	ATTACH COMPLETE	-	-
13	The activation of a PDP context is triggered by MMI or AT command.	-	-	-	-
14	Generic test procedure in TS 34.108 subclause 7.2.4.2.3 is performed on Cell 5. NOTE: The UE performs Radio Bearer Establishment in a UTRAN cell.	-	-	-	-
15	The SS releases the RRC connection.	-	-	-	-
16	The SS configures: - Cell A as the "Serving cell". - Cell 5 as a "Non-Suitable cell".	-	-	-	-
17 - 24	Generic test procedure in TS 36.508 subclause 6.4.2.7A-1 is performed. (step 1 to 8)	-	-	-	-
25	If possible (see ICS) switch off is performed or the USIM is removed. Otherwise the power is removed.	-	-	-	-
-	EXCEPTION: Step 25 describes behaviour that depends on the UE capability.				
26	If pc_SwitchOnOff or pc_USIM_Removal then UE send DETACH REQUEST message.	-->	DETACH REQUEST	-	-
27	The SS configures: - Cell A as the "Serving cell". - Cell 5 as a "Non-Suitable Off cell".	-	-	-	-
28	The UE is brought back to operation or the USIM is inserted. The following message shall be received on cell A.	-	-	-	-
29	Cause UE to initiate attach Check: Does the UE send ATTACH REQUEST message	-->	ATTACH REQUEST	1	P
30-	The attach procedure is completed by	-	-	-	-

41	executing steps 5 to 16 of the UE registration procedure in TS 36.508 sub clause 4.5.2.3.				
-	At the end of this test procedure sequence, the UE is in end state E-UTRA connected (E2) according to TS 36.508.	-	-	-	-

9.2.2.1.10.3.3 Specific message contents

Table 9.2.1.1.10.3.3-1: Message ATTACH REJECT (steps 3, Table 9.2.2.1.10.3.2-1)

Derivation path: 36.508 table 4.7.2-3			
Information Element	Value/Remark	Comment	Condition
Security header type	0000	" Plain NAS message, not security protected "	
EMM cause	00001000	#8 "EPS services and non-EPS services not allowed"	
ESM message container	Not present		

Table 9.2.2.1.10.3.3-2: ATTACH REQUEST (step 29, Table 9.2.2.1.10.3.2-1)

Information Element	Value/remark	Comment	Condition
NAS key set identifier	'111'	no key is available	

9.2.2.2 Network initiated detach procedure

9.2.2.2.1 NW initiated detach / Re-attach required

9.2.2.2.1.1 Test Purpose (TP)

(1)

```
with { UE in EMM-REGISTERED state }
ensure that {
  when { SS sends DETACH REQUEST message with the Detach type IE "re-attach required" }
  then { UE sends DETACH ACCEPT message and UE initiates an attach procedure with the current EPS security context }
}
```

9.2.2.2.1.2 Conformance requirements

References: The conformance requirement covered in the present TC is specified in: 3GPP TS 24.301 clauses 5.5.2.3.2.

[TS24.301 clause5.5.2.3.2]

When receiving the DETACH REQUEST message and the detach type indicates "re-attach required", the UE shall deactivate the EPS bearer context(s) including the default EPS bearer context locally without peer-to-peer signalling between the UE and the MME. The UE shall then send a DETACH ACCEPT message to the network and enter state EMM-DEREGISTERED. Furthermore, the UE shall, after the completion of the detach procedure, and the existing NAS signalling connection has been released, initiate an attach or combined attach procedure.

NOTE 1: When detach type indicates "re-attach required", user interaction is necessary in some cases when the UE cannot re-activate the EPS bearer(s) automatically.

A UE which receives a DETACH REQUEST message with detach type indicating "re-attach required" or "re-attach not required" and no EMM cause IE, is detached only for EPS services.

...If the detach type indicates "IMSI detach" or "re-attach required" then the UE shall ignore the EMM cause IE if received.

9.2.2.2.1.3 Test description

9.2.2.2.1.3.1 Pre-test conditions

System Simulator:

- cell A.

UE:

none.

Preamble:

- the UE is in state Generic RB established (state 3) on cell A according to TS 36.508 [18].

9.2.2.2.1.3.2 Test procedure sequence

Table 9.2.2.2.1.3.2-1: Main behaviour

St	Procedure	Message Sequence		TP	Verdict
		U - S	Message/PDU/SDU		
1	The SS initiates Detach procedure with the Detach Type IE "re-attach required"	<--	DETACH REQUEST	-	-
2	Check: Does the UE send DETACH ACCEPT message?	-->	DETACH ACCEPT	1	P
3	The SS releases RRC connection.				
-	EXCEPTION: Step 3a describes a behaviour which depends on the UE capability	-	-	-	-
3a	IF NOT pc_Automatic_Re_Attach, the user initiates an attach by MMI or by AT command.	-	-	-	-
4	Check: Does the UE send ATTACH REQUEST message including a PDN CONNECTIVITY REQUEST message?	-->	ATTACH REQUEST	1	P
-	EXCEPTION: Steps 4Aa1 to 4Aa2 describe behaviour that depends on UE configuration; the "lower case letter" identifies a step sequence that take place if the UE has ESM information which needs to be transferred.	-	-	-	-
4Aa1	IF the UE sets the ESM information transfer flag in the last PDN CONNECTIVITY REQUEST message THEN the SS transmits an ESM INFORMATION REQUEST message to initiate exchange of protocol configuration options and/or APN.	<--	ESM INFORMATION REQUEST	-	-
4Aa2	The UE transmits an ESM INFORMATION RESPONSE message to transfer protocol configuration options and/or APN.	-->	ESM INFORMATION RESPONSE	-	-
5	The SS sends ATTACH ACCEPT to assign the new GUTI (GUTI-2). The ACTIVATE DEFAULT EPS BEARER CONTEXT REQUEST message is piggybacked in ATTACH ACCEPT message	<--	ATTACH ACCEPT	-	-
6	Check: Does the UE send ATTACH COMPLETE message including an ACTIVATE DEFAULT EPS BEARER CONTEXT ACCEPT message?	-->	ATTACH COMPLETE	1	P

9.2.2.2.1.3.3 Specific message contents

Table 9.2.2.2.1.3.3-1: Message DETACH REQUEST (step 1, Table 9.2.2.2.1.3.2-1)

Derivation path: 36.508 table 4.7.2-12			
Information Element	Value/Remark	Comment	Condition
Detach type	'001'B	"re-attach required"	

Table 9.2.2.2.1.3.3-2: Message ATTACH REQUEST (step 4, Table 9.2.2.2.1.3.2-1)

Derivation path: 36.508 table 4.7.2-4			
Information Element	Value/Remark	Comment	Condition
NAS key set identifier			
TSC	'0'B	native security context	
NAS key set identifier	The value is a same value to be allocated by SS in Preamble.		
Old GUTI or IMSI	GUTI-1		

NOTE: This message is sent within the SECURITY NAS PROTECTED MESSAGE in Table 9.2.2.2.1.3.3-3.

Table 9.2.2.2.1.3.3-3: Message SECURITY PROTECTED NAS MESSAGE (step 4, Table 9.2.2.2.1.3.2-1)

Derivation Path: 36.508 Table 4.7.1-1			
Information Element	Value/remark	Comment	Condition
Security header type	'0001'B	Integrity protected	
NAS message	'01000001'B	"ATTACH REQUEST"	

Table 9.2.2.2.1.3.3-4: Message ATTACH ACCEPT (step 5, Table 9.2.2.2.1.3.2-1)

Derivation path: 36.508 table 4.7.2-1			
Information Element	Value/Remark	Comment	Condition
TAI list			
Length of tracking area identity list contents	'00000110'B	6 octets	
Number of elements	'00000'B	1 element	
Type of list	'00'B	"list of TACs belonging to one PLMN, with non-consecutive TAC values"	
Partial tracking area identity list	TAI-1		
GUTI	GUTI-2		

9.2.2.2.2 NW initiated detach / IMSI detach

9.2.2.2.2.1 Test Purpose (TP)

(1)

```
with { UE in EMM-REGISTERED state}
ensure that {
  when { UE receives DETACH REQUEST message with the Detach type IE = "IMSI detach" }
  then { UE sends TRACKING AREA UPDATE REQUEST message with EPS update type IE = "Combined TA/LA
updating with IMSI attach" }
}
```

(2)

```
with { UE in EMM-TRACKING-AREA-UPDATING-INITIATED state }
ensure that {
  when { UE receives TRACKING AREA UPDATE ACCEPT message }
  then { UE enters EMM-REGISTERED and enters MM IDLE and sends TRACKING AREA UPDATE COMPLETE
message }
}
```

9.2.2.2.2.2 Conformance requirements

References: The conformance requirement covered in the present TC is specified in: 3GPP TS 24.301 clauses 5.5.2.3.2.

[TS24.301 clause5.5.2.3.2]

...

When receiving the DETACH REQUEST message and the Detach type IE indicates "IMSI detach", the UE shall not deactivate the EPS bearer context(s) including the default EPS bearer context. The UE shall set the MM update status to U2 NOT UPDATED. A UE may send a DETACH ACCEPT message to the network, and shall re-attach to non-EPS services by performing the combined tracking area updating procedure according to subclause 5.5.3.3, sending a TRACKING AREA UPDATE REQUEST message with EPS update type IE indicating "combined TA/LA updating with IMSI attach".

...

If the detach type IE indicates "IMSI detach" or "re-attach required", then the UE shall ignore the EMM cause IE if received.

...

9.2.2.2.2.3 Test description

9.2.2.2.2.3.1 Pre-test conditions

System Simulator:

- cell A.

UE:

- the UE is configured to initiate combined EPS/IMSI attach.

Preamble:

- the UE is in state Generic RB established (state 3) on cell A according to TS 36.508 [18].

9.2.2.2.2.3.2 Test procedure sequence

Table 9.2.2.2.2.3.2-1: Main Behaviour

St	Procedure	Message Sequence		TP	Verdict
		U - S	Message/PDU/SDU		
1	Force the SS to initiate Detach procedure with the Detach Type IE "IMSI detach"	<--	DETACH REQUEST	-	-
2	The UE may send DETACH ACCEPT message.(Optional)	-->	DETACH ACCEPT	-	-
3	Check: Does the UE send TRACKING AREA UPDATE REQUEST message?	-->	TRACKING AREA UPDATE REQUEST	1	P
4	Void	-	-	-	-
5	Void	-	-	-	-

6	The SS sends TRACKING AREA UPDATE ACCEPT message.	<--	TRACKING AREA UPDATE ACCEPT	-	-
7	Check: Does the UE send TRACKING AREA UPDATE COMPLETE message.	-->	TRACKING AREA UPDATE COMPLETE	2	P
8	The SS releases the RRC connection.	-	-	-	-
-	EXCEPTION: Steps 9 to 9E take place only if the UE supports CS fallback (pc_CS_fallback is true)	-	-	-	-
9	Check: Does the UE respond to paging on cell A with S-TMSI2 for CS domain?	-	-	-	-
-	EXCEPTION: Step 9Aa1 describes behaviour that depends on the UE capability; the "lower case letter" identifies a step sequence that takes place if a capability is supported.	-	-	-	-
9Aa1	IF the UE needs to request upper layer input before accepting the CS fallback (see ICS), the incoming CS call is accepted at the UE through MMI or AT command.	-	-	-	-
9B	The UE sends EXTENDED SERVICE REQUEST message?	-->	EXTENDED SERVICE REQUEST	-	-
9C	The SS transmits SERVICE REJECT with cause #39 'CS domain temporarily not available' with T3442 = 60s.	<--	SERVICE REJECT	-	-
9D	The SS releases the RRC connection.	-	-	-	-
-	EXCEPTION: The behaviour in table 9.2.2.2.3.2-2 may occur in parallel with step 9E.	-	-	-	-
9E	The SS waits for 60 seconds (T3442)	-	-	-	-
10	Check: Does the UE respond to paging on cell A with S-TMSI2 for PS domain? Generic Procedure (TS36.508 subclause 6.4.2.4)	-	-	2	-

Table 9.2.2.2.3.2-2: Parallel Behaviour

St	Procedure	Message Sequence		TP	Verdict
		U - S	Message/PDU/SDU		
1	The UE transmits a TRACKING AREA UPDATE REQUEST message.	-->	TRACKING AREA UPDATE REQUEST	-	-
2	The SS transmits a TRACKING AREA UPDATE ACCEPT message.	<--	TRACKING AREA UPDATE ACCEPT	-	-
3	The SS releases the RRC connection.	-	-	-	-

9.2.2.2.3.3 Specific message contents

Table 9.2.2.2.3.3-1: Message DETACH REQUEST (step 1, Table 9.2.2.2.3.2-1)

Derivation path: 36.508 table 4.7.2-12			
Information Element	Value/Remark	Comment	Condition
Detach type	'011'B	"IMSI detach"	
EMM cause	Not present		

Table 9.2.2.2.3.3-2: Message TRACKING AREA UPDATE REQUEST (step 3, Table 9.2.2.2.3.2-1)

Derivation path: 36.508 table 4.7.2-27			
Information Element	Value/Remark	Comment	Condition
EPS update type			
EPS update type value	'010'B	"Combined TA/LA updating with IMSI attach"	
Old GUTI	GUTI-1		
Last visited registered TAI	TAI-1		

Table 9.2.2.2.3.3-3: Message TRACKING AREA UPDATE ACCEPT (step 6, Table 9.2.2.2.3.2-1)

Derivation path: 36.508 table 4.7.2-24			
Information Element	Value/Remark	Comment	Condition
GUTI	GUTI-2		
TAI list			
Length of tracking area identity list contents	'00000110'B		
Number of elements	'00000'B		
Type of list	'00'B	"list of TACs belonging to one PLMN, with non-consecutive TAC values"	
Partial tracking area identity list			
MCC MNC TAC 1	TAI-1		
Location area identification	LAI-1		
MS identity	TMSI-1		

Table 9.2.2.2.3.3-4: Message EXTENDED SERVICE REQUEST (step 9B, Table 9.2.2.2.3.2-1)

Derivation Path: 36.508 table 4.7.2.-14A			
Information Element	Value/remark	Comment	Condition
M-TMSI	M-TMSI1	"M-TMSI1 is a part of GUTI-1"	

Table 9.2.2.2.3.3-5: Message SERVICE REJECT (step 9C, Table 9.2.2.2.3.2-1)

Derivation Path: 36.508 table 4.7.2-22			
Information Element	Value/remark	Comment	Condition
EMM cause	'0010 0111'B	#39 'CS domain temporarily not available'	
T3442 value	'0010 0001'B	1 minute	

Table 9.2.2.2.3.3-6 Message TRACKING AREA UPDATE ACCEPT (step 2, Table 9.2.2.2.3.2-2)

Derivation path: 36.508 table 4.7.2-24			
Information Element	Value/Remark	Comment	Condition
GUTI	Not present		
MS identity	Not present		

9.2.2.2.3 to 9.2.2.2.13 Void

9.2.2.2.14 NW initiated detach / Abnormal case / EMM cause not included

9.2.2.2.14.1 Test Purpose (TP)

(1)

```

with { UE in EMM-REGISTERED state }
ensure that {
  when { UE receives a DETACH REQUEST message with the Detach type IE "re-attach not required" and
with no EMM cause IE included }
  then { UE delete any GUTI, TAI list, last visited registered TAI, list of equivalent PLMNs, KSI,
set the update status to EU2 NOT UPDATED and start timer T3402. when T3402 expired, the UE attempts
to attach again }
}

```

9.2.2.2.14.2 Conformance requirements

References: The conformance requirement covered in the present TC is specified in: 3GPP TS 24.301 clauses 5.5.2.3.4.

[TS24.301 clause 5.5.2.3.4]

The following abnormal cases can be identified:

...

- b) DETACH REQUEST, other EMM cause values than those treated in subclause 5.5.2.3.2 or no EMM cause IE is included, and the Detach type IE indicates "re-attach not required".

The UE shall delete any GUTI, TAI list, last visited registered TAI, list of equivalent PLMNs, KSI, shall set the update status to EU2 NOT UPDATED and shall start timer T3402. The UE may enter the state EMM-DEREGISTERED.PLMN-SEARCH in order to perform a PLMN selection according to 3GPP TS 23.122 [6]; otherwise the UE shall enter the state EMM-DEREGISTERED.ATTEMPTING-TO-ATTACH.

9.2.2.2.14.3 Test description

9.2.2.2.14.3.1 Pre-test conditions

System Simulator:

- cell I (VPLMN and set as a serving cell) configured according to table 6.3.2.2-3 in TS 36.508 [18].

UE:

None.

Preamble:

- the UE is in state Generic RB established (state 3) on cell I according to TS 36.508 [18];
- T3402 in the UE is set to 2 minutes.

9.2.2.2.14.3.2 Test procedure sequence

Table 9.2.2.2.14.3.2-1: Main behaviour

St	Procedure	Message Sequence		TP	Verdict
		U - S	Message/PDU/SDU		
1	SS initiates Detach procedure with the Detach Type IE "re-attach not required" and no EMM cause IE included	<--	DETACH REQUEST	-	-
2	The UE transmits a DETACH ACCEPT message on Cell I. Note: Now UE should start timer T3402	-->	DETACH ACCEPT	-	-
3	The SS releases the RRC connection.	-	-	-	-
4	Check: When the timer T3402 expires does the UE transmit ATTACH REQUEST message on cell I?	-->	ATTACH REQUEST	1	P
5-16	The attach procedure is completed by executing steps 5 to 16 of the UE registration procedure in TS 36.508 sub clause 4.5.2.3.	-	-	-	-
-	At the end of this test procedure sequence, the UE is in end state E-UTRA connected (E2) according to TS 36.508.	-	-	-	-

9.2.2.2.14.3.3 Specific message contents

Table 9.2.2.2.14.3.3-1: Message DETACH REQUEST (step 1, Table 9.2.2.2.14.3.2-1)

Derivation path: 36.508 table 4.7.2-12			
Information Element	Value/Remark	Comment	Condition
Detach type	'010'B	"re-attach not required"	
EMM cause	Not present		

Table 9.2.2.2.14.3.3-2: Message ATTACH REQUEST (step 4, Table 9.2.2.2.14.3.2-1)

Derivation Path: TS 36.508 Table 4.7.2-4			
Information Element	Value/remark	Comment	Condition
NAS key set identifier			
NAS key set identifier	'111'B	no key is available	
TSC	Any allowed value	TSC does not apply for NAS key set identifier value "111".	
Old GUTI or IMSI	IMSI1		
Last visited registered TAI	Not present		

Table 9.2.2.2.14.3.3-3: Message ATTACH ACCEPT (preamble, 9.2.2.2.14.3.1)

Derivation path: 36.508 table 4.7.2-1			
Information Element	Value/Remark	Comment	Condition
T3402 value	2 minute	The default value is 12 minutes, use 2 minute to shorten the whole TC execute time	

9.2.3 Tracking area updating procedure (S1 mode only)

9.2.3.1 Normal and periodic tracking area updating

9.2.3.1.1 Normal tracking area update / Accepted

9.2.3.1.1.1 Test Purpose (TP)

(1)

```
with { UE in state EMM-REGISTERED and EMM-IDLE mode }
ensure that {
  when { UE detects entering a new tracking area already included in the TAI list }
  then { UE does not send TRACKING AREA UPDATE REQUEST message }
}
```

(2)

```
with { UE in state EMM-REGISTERED and EMM-IDLE mode }
ensure that {
  when { UE detects entering a new tracking area not included in the TAI list }
  then { UE sends TRACKING AREA UPDATE REQUEST message with 'EPS update type = TA updating' }
}
```

(3)

```
with { UE in state EMM-REGISTERED and EMM-IDLE mode and has a valid TAI value }
ensure that {
  when { UE detects entering a new tracking area not included in the TAI list }
  then { UE sends TRACKING AREA UPDATE REQUEST message with the TAI value in 'Last visited registered TAI' IE }
}
```

9.2.3.1.1.2 Conformance requirements

References: The conformance requirements covered in the present TC are specified in: 3GPP TS 24.301 clauses 5.5.3.1, 5.5.3.2.2 and 5.5.3.2.4.

[TS24.301 clause5.5.3.1]

The tracking area updating procedure is always initiated by the UE and is used for the following purposes:

- normal tracking area updating to update the registration of the actual tracking area of a UE in the network;

...

[TS24.301 clause 5.5.3.2.2]

The UE in state EMM-REGISTERED shall initiate the tracking area updating procedure by sending a TRACKING AREA UPDATE REQUEST message to the MME,

- a) when the UE detects entering a tracking area that is not in the list of tracking areas that the UE previously registered in the MME;

...

After sending the TRACKING AREA UPDATE REQUEST message to the MME, the UE shall start timer T3430 and enter state EMM-TRACKING-AREA-UPDATING-INITIATED (see example in figure 5.5.3.2.2). If timer T3402 is currently running, the UE shall stop timer T3402. If timer T3411 is currently running, the UE shall stop timer T3411. If timer T3442 is currently running, the UE shall stop timer T3442.

If the UE supports A/Gb mode or Iu mode, the UE shall handle the Old GUTI IE as follows:

- If the TIN indicates "P-TMSI" and the UE holds a valid P-TMSI and RAI, the UE shall map the P-TMSI and RAI into the Old GUTI IE. Additionally, if the UE holds a valid GUTI, the UE shall indicate the GUTI in the Additional GUTI IE.

NOTE: The mapping of the P-TMSI and RAI to the GUTI is specified in 3GPP TS 23.003 [2].

- If the TIN indicates "GUTI" or "RAT-related TMSI" and the UE holds a valid GUTI, the UE shall indicate the GUTI in the Old GUTI IE.

...

[TS24.301 clause 5.5.3.2.4]

...

Upon receiving a TRACKING AREA UPDATE ACCEPT message, the UE shall stop timer T3430, reset the routing area updating attempt counter, enter state EMM-REGISTERED and set the EPS update status to EU1 UPDATED. If the message contains a GUTI, the UE shall use this GUTI as new temporary identity for EPS services and shall store the new GUTI. If no GUTI was included by the MME in the TRACKING AREA UPDATE ACCEPT message, the old GUTI shall be used. If the UE receives a new TAI list in the TRACKING AREA UPDATE ACCEPT message, the UE shall consider the new TAI list as valid and the old TAI list as invalid; otherwise, the UE shall consider the old TAI list as valid.

...

If the TRACKING AREA UPDATE ACCEPT message contained a GUTI, the UE shall return a TRACKING AREA UPDATE COMPLETE message to the MME to acknowledge the received GUTI.

9.2.3.1.1.3 Test description

9.2.3.1.1.3.1 Pre-test conditions

System Simulator:

- cell A (belongs to TAI-1, home PLMN) is set to "Serving cell";
- cell B (belongs to TAI-2, home PLMN) is set to "Non- Suitable cell";
- cell D (belongs to TAI-4, home PLMN) is set to "Non- Suitable cell".

UE:

- the UE is configured to initiate EPS attach.

Preamble:

- the UE is in state Registered, Idle Mode (state 2) on cell A according to TS 36.508 [18].

9.2.3.1.1.3.2 Test procedure sequence

Table 9.2.3.1.1.3.2-1: Main behaviour

St	Procedure	Message Sequence		TP	Verdict
		U - S	Message		
	The following messages are sent and shall be received on cell B.	-	-	-	-
1	Set the cell type of cell A to the "Non-Suitable cell". Set the cell type of cell B to the " Serving cell"	-	-	-	-
2	Check: Does the UE transmit a TRACKING AREA UPDATE REQUEST message?	-->	TRACKING AREA UPDATE REQUEST	2, 3	P
3	The SS transmits a TRACKING AREA UPDATE ACCEPT message.	<--	TRACKING AREA UPDATE ACCEPT	-	-
4	Check: Does the UE transmit a TRACKING AREA UPDATE COMPLETE message?	-->	TRACKING AREA UPDATE COMPLETE	2	P
5	The SS releases the RRC connection.			-	-
6	Check: Does the test result of generic test procedure in TS 36.508 subclause 6.4.2.4 indicate that the UE is in EMM-REGISTERED state on cell B with Paging UE-Identity =S-TMSI2 and with CN domain indicator set to "PS"?	-	-	2	-
7	Set the cell type of cell B to the "Non-Suitable cell ". Set the cell type of cell D to the " Serving cell"	-	-	-	-
8	Check: Does the UE transmit a TRACKING AREA UPDATE REQUEST message in the next 30 seconds?	-	-	1	F
9	Check: Does the test result of generic test procedure in TS 36.508 subclause 6.4.2.4 indicate that the UE is in EMM-REGISTERED state on cell D with Paging UE-Identity =S-TMSI1 and with CN domain indicator set to "PS"?	-	-	1	-
	The following messages are sent and shall be received on cell A.	-	-	-	-
10	Set the cell type of cell D to the "Non-Suitable cell". Set the cell type of cell A to the " Serving cell"	-	-	-	-
11	Check: Does the UE transmit a TRACKING AREA UPDATE REQUEST message?	-->	TRACKING AREA UPDATE REQUEST	2, 3	P
12	The SS transmits a TRACKING AREA UPDATE ACCEPT message.	<--	TRACKING AREA UPDATE ACCEPT	-	-
13	The UE transmits a TRACKING AREA UPDATE COMPLETE message?	-->	TRACKING AREA UPDATE COMPLETE	-	-
14	The SS releases the RRC connection.	-	-	-	-

9.2.3.1.1.3.3 Specific message contents

Table 9.2.3.1.1.3.3-1: Message TRACKING AREA UPDATE REQUEST (step 2, Table 9.2.3.1.1.3.2-1)

Derivation path: 36.508 table 4.7.2-27			
Information Element	Value/Remark	Comment	Condition
Old GUTI	GUTI-1	"Old GUTI is included by UE if valid, IMSI otherwise"	
Last visited registered TAI TAI	1		

Table 9.2.3.1.1.3.3-2: Message TRACKING AREA UPDATE ACCEPT (step 3, Table 9.2.3.1.1.3.2-1)

Derivation path: 36.508 table 4.7.2-24			
Information Element	Value/Remark	Comment	Condition
GUTI	GUTI-2		
TAI list			
Length of tracking area identity list contents	'00001000'B		
Partial tracking area identity list			
Number of elements	'00001'B		
Type of list	'00'B	"list of TACs belonging to one PLMN, with non-consecutive TAC values"	
MCC MNC TAC 1	PLMN= MCC/MNC TAC 1=2 TAC 2=4	"PLMN is set to the same MCC/MNC stored in EF _{IMSI} " "TAI-2" "TAI-4"	

Table 9.2.3.1.1.3.3-3: Message TRACKING AREA UPDATE REQUEST (step 11, Table 9.2.3.1.1.3.2-1)

Derivation path: 36.508 table 4.7.2-27			
Information Element	Value/Remark	Comment	Condition
Old GUTI	GUTI-2		
Last visited registered TAI	TAI-4		

Table 9.2.3.1.1.3.3-4: Message TRACKING AREA UPDATE ACCEPT (step 12, Table 9.2.3.1.1.3.2-1)

Derivation path: 36.508 table 4.7.2-24			
Information Element	Value/Remark	Comment	Condition
GUTI	GUTI-3		
TAI list			
Length of tracking area identity list contents	'00001000'B		
Partial tracking area identity list			
Number of elements	'00001'B		
Type of list	'00'B	"list of TACs belonging to one PLMN, with non-consecutive TAC values"	
MCC MNC TAC 1	PLMN= MCC/MNC TAC 1=1 TAC 2=2	"PLMN is set to the same MCC/MNC stored in EF _{IMSI} " "TAI-1" "TAI-2"	

9.2.3.1.2 Void

9.2.3.1.3 Void

9.2.3.1.4 Normal tracking area update / List of equivalent PLMNs in the TRACKING AREA UPDATE ACCEPT message

9.2.3.1.4.1 Test Purpose (TP)

(1)

```

with { UE in EMM-TRACKING-AREA-UPDATING-INITIATED state }
ensure that {
  when { the UE receives TRACKING AREA UPDATE ACCEPT message including a list of equivalent PLMNs }
  then { the UE stores correctly the list and considers a forbidden PLMN if the forbidden PLMN is
included in the equivalent list }

```

```
}
```

(2)

```
with { UE in EMM-TRACKING-AREA-UPDATING-INITIATED state }  
ensure that {  
  when { the UE receives TRACKING AREA UPDATE ACCEPT message without a list of equivalent PLMNs }  
  then { the UE deletes the stored list and applies a normal PLMN selection process }  
}
```

9.2.3.1.4.2 Conformance requirements

References: The conformance requirements covered in the current TC are specified in: TS 24.301, clause 5.5.3.2.4.

[TS 24.301, clause 5.5.3.2.4]

The MME may also include of list of equivalent PLMNs in the TRACKING AREA UPDATE ACCEPT message. Each entry in the list contains a PLMN code (MCC+MNC). The UE shall store the list as provided by the network, after having removed from the list any PLMN code that is already in the list of forbidden PLMNs. In addition, the UE shall add to the stored list the PLMN code of the registered PLMN that sent the list. The UE shall replace the stored list on each receipt of the TRACKING AREA UPDATE ACCEPT message. If the TRACKING AREA UPDATE ACCEPT message does not contain a list, then the UE shall delete the stored list.

9.2.3.1.4.3 Test description

9.2.3.1.4.3.1 Pre-test conditions

System Simulator:

- cell A (belongs to TAI-1, PLMN1);
- cell B (belongs to TAI-2, PLMN1);
- cell C (belongs to TAI-3, PLMN2);
- cell D (belongs to TAI-4, PLMN3);
- system information combination 2 as defined in TS 36.508[18] clause 4.4.3.1 is used in E-UTRA cell B and C.

UE:

- the UE is previously registered on E-UTRAN, and when on E-UTRAN, the UE last attempted to register on cell D and received reject cause "forbidden PLMN" (so the "forbidden PLMN list" contains PLMN3).

Preamble:

- the UE is in state Registered, Idle Mode (state 2) on cell A according to TS 36.508[18].

9.2.3.1.4.3.2 Test procedure sequence

Table 9.2.3.1.4.3.2-1: Main behaviour

St	Procedure	Message Sequence		TP	Verdict
		U - S	Message		
1	Set the cell type of cell A to the "Non-Suitable cell". Set the cell type of cell B to the "Serving cell". Set the cell type of cell C to the " Non-Suitable off cell". Set the cell type of cell D to the " Non-Suitable off cell".	-	-	-	-
2	The UE transmits a TRACKING AREA UPDATE REQUEST message.	-->	TRACKING AREA UPDATE REQUEST	-	-
3	Void	-	-	-	-
4	Void	-	-	-	-
5	SS responds with a TRACKING AREA UPDATE ACCEPT message including PLMN2 and PLMN3 in the list of equivalent PLMNs.	<--	TRACKING AREA UPDATE ACCEPT	-	-
6	The UE transmits a TRACKING AREA UPDATE COMPLETE message	-->	TRACKING AREA UPDATE COMPLETE	-	-
6A	SS Releases the RRC Connection.	-	-	-	-
7	Set the cell type of cell A to the "Non-Suitable off cell". Set the cell type of cell B to the "Non-Suitable cell". Set the cell type of cell C to the " Suitable cell".	-	-	-	-
8	Check: Does the UE transmit a TRACKING AREA UPDATE REQUEST message on cell C (PLMN2)?	-->	TRACKING AREA UPDATE REQUEST	1	P
9	Void.	-	-	-	-
10	Void.	-	-	-	-
11	The SS transmits a TRACKING AREA UPDATE ACCEPT message including PLMN1 and PLMN3 in the list of equivalent PLMNs.	<--	TRACKING AREA UPDATE ACCEPT	-	-
12	The UE transmits a TRACKING AREA UPDATE COMPLETE message.	-->	TRACKING AREA UPDATE COMPLETE	-	-
12 A	SS Releases the RRC Connection.	-	-	-	-
13	Set the cell type of cell C to the "Non-Suitable cell". Set the cell type of cell D to the " Serving cell". Note: Cell D (PLMN3) belongs to the forbidden PLMN.	-	-	-	-
14	Check: Does the UE transmit a TRACKING AREA UPDATE REQUEST message on cell D (PLMN3) in next 30 seconds?	-->	TRACKING AREA UPDATE REQUEST	1	F
15	The UE is switched to manual PLMN selection mode and is made to select PLMN3 in order to remove PLMN3 in the forbidden PLMN list in the UE.	-	-	-	-
16	The UE transmits a TRACKING AREA UPDATE REQUEST message on cell D (PLMN3).	-->	TRACKING AREA UPDATE REQUEST	-	-
17	Void	-	-	-	-
18	Void	-	-	-	-
19	The SS transmits a TRACKING AREA UPDATE ACCEPT message without the list of equivalent PLMNs.	<--	TRACKING AREA UPDATE ACCEPT	-	-
20	Check: Does the UE transmit a TRACKING AREA UPDATE COMPLETE message?	-->	TRACKING AREA UPDATE COMPLETE	1	P
20 A	SS releases the RRC connection	-	-	-	-
21	The UE is switched back to automatic PLMN selection mode.	-	-	-	-
21	SS waits for 5 minutes to allow UE to complete	-	-	-	-

A	automatic PLMN search				
22	Set the cell type of cell D to "Non-Suitable cell". Set the cell type of cell B to "Serving cell". Set the cell type of cell C to "Suitable neighbour intra-frequency cell".	-	-	-	-
23	Void	-	-	-	-
24	Void	-	-	-	-
24 A	Void	-	-	-	-
25	Check: Does the UE transmit a TRACKING AREA UPDATE REQUEST message on Cell B (PLMN1)?	-->	TRACKING AREA UPDATE REQUEST	2	P
26	Void	-	-	-	-
27	SS responds with TRACKING AREA UPDATE ACCEPT message	<--	TRACKING AREA UPDATE ACCEPT	-	-
28	The UE transmits a TRACKING AREA UPDATE COMPLETE message	-->	TRACKING AREA UPDATE COMPLETE	-	-
-	At the end of this test procedure sequence, the UE is in end state E-UTRA connected (E2_T3440) according to TS 36.508.	-	-	-	-

9.2.3.1.4.3.3 Specific message contents

Table 9.2.3.1.4.3.3-1: Void**Table 9.2.3.1.4.3.3-2: Void****Table 9.2.3.1.4.3.3-3: Message TRACKING AREA UPDATE ACCEPT (step 5, Table 9.2.3.1.4.3.2-1)**

Derivation path: 36.508 table 4.7.2-24			
Information Element	Value/Remark	Comment	Condition
Equivalent PLMNs	-	Includes MCC and MNC digits for PLMN2 and PLMN3.	

Table 9.2.3.1.4.3.3-4: Message TRACKING AREA UPDATE ACCEPT (step 11, Table 9.2.3.1.4.3.2-1)

Derivation path: 36.508 table 4.7.2-24			
Information Element	Value/Remark	Comment	Condition
Equivalent PLMNs	-	Includes MCC and MNC digits for PLMN1 and PLMN3.	

Table 9.2.3.1.4.3.3-5: Void**Table 9.2.3.1.4.3.3-6: Void**

9.2.3.1.5 Periodic tracking area update / Accepted

9.2.3.1.5.1 Test Purpose (TP)

(1)

```
with { UE in state EMM-REGISTERED and EMM-IDLE mode }
ensure that {
  when { the periodic tracking area updating timer T3412 expires }
  then { UE sends TRACKING AREA UPDATE REQUEST message with EPS update type = 'Periodic updating ' }
}
```

(2)

```
with { UE in 'out of E-UTRAN coverage' and the periodic tracking area updating timer T3412 expires }
```

```

ensure that {
  when { the UE enters E-UTRAN coverage }
  then { UE configured for EPS attach sends TRACKING AREA UPDATE REQUEST message with EPS update
type = 'Periodic updating' and the UE configured for combined EPS / IMSI attach sends TRACKING AREA
UPDATE REQUEST message with EPS update type = 'combined TA/LA updating with IMSI attach' }
}

```

9.2.3.1.5.2 Conformance requirements

References: The conformance requirements covered in the present TC are specified in: 3GPP TS23.401 clause 4.3.5.2 and TS 24.301 clauses 5.3.5, 5.5.3.2.1, 5.5.3.2.2 and 5.5.3.2.4.

[TS23.401 clause 4.3.5.2]

...

An EMM-REGISTERED UE performs periodic Tracking Area Updates with the network after the expiry of the periodic TAU timer.

If the UE is out of E-UTRAN coverage (including the cases when the UE is camped on 2G/3G cells) when its periodic TAU update timer expires, and ISR is activated the UE shall start the E-UTRAN Deactivate ISR timer. After the E-UTRAN Deactivate ISR timer expires the UE shall deactivate ISR by setting its TIN to "P-TMSI". The EMM-REGISTERED UE shall remember it has to perform a Tracking Area Update when it next returns to E-UTRAN coverage.

[TS24.301 clause5.3.5]

Periodic tracking area updating is used to periodically notify the availability of the UE to the network. The procedure is controlled in the UE by the periodic tracking area update timer (timer T3412). The value of timer T3412 is sent by the network to the UE in the ATTACH ACCEPT message and can be sent in the TRACKING AREA UPDATE ACCEPT message. The UE shall apply this value in all tracking areas of the list of tracking areas assigned to the UE, until a new value is received.

The timer T3412 is reset and started with its initial value, when the UE goes from EMM-CONNECTED to EMM-IDLE mode. The timer T3412 is stopped when the UE enters EMM-CONNECTED mode or EMM-DEREGISTERED state.

When timer T3412 expires, the periodic tracking area updating procedure shall be started and the timer shall be set to its initial value for the next start.

...

If the UE is attached to both EPS and non-EPS services, and if timer T3412 expires or timer T3423 expires when the UE is in EMM-REGISTERED.NO-CELL-AVAILABLE state, then the UE shall initiate the combined tracking area updating procedure indicating "combined TA/LA updating with IMSI attach" when the UE returns to EMM-REGISTERED.NORMAL-SERVICE state.

...

If the UE is in another state than EMM-REGISTERED.NORMAL-SERVICE when the timer expires the periodic tracking area updating procedure is delayed until the UE returns to EMM-REGISTERED.NORMAL-SERVICE.

...

The mobile reachable timer shall be reset and started with its initial value, when the MME releases the NAS signalling connection for the UE. The mobile reachable timer shall be stopped when a NAS signalling connection is established for the UE.

....

[TS24.301 clause5.5.3.2.1]

The periodic tracking area updating procedure is controlled in the UE by timer T3412. When timer T3412 expires, the periodic tracking area updating procedure is started. Start and reset of timer T3412 is described in subclause 5.5.3.2.

[TS24.301 clause5.5.3.2.2]

The UE in state EMM-REGISTERED shall initiate the tracking area updating procedure by sending a TRACKING AREA UPDATE REQUEST message to the MME,

...

- b) when the periodic tracking area updating timer T3412 expires;

...

After sending the TRACKING AREA UPDATE REQUEST message to the MME, the UE shall start timer T3430 and enter state EMM-TRACKING-AREA-UPDATING-INITIATED (see example in figure 5.5.3.2.2). If timer T3402 is currently running, the UE shall stop timer T3402. If timer T3411 is currently running, the UE shall stop timer T3411. If timer T3442 is currently running, the UE shall stop timer T3442.

If the UE supports A/Gb mode or Iu mode, the UE shall handle the Old GUTI IE as follows:

- If the TIN indicates "P-TMSI" and the UE holds a valid P-TMSI and RAI, the UE shall map the P-TMSI and RAI into the Old GUTI IE. Additionally, if the UE holds a valid GUTI, the UE shall indicate the GUTI in the Additional GUTI IE.

NOTE: The mapping of the P-TMSI and RAI to the GUTI is specified in 3GPP TS 23.003 [2].

- If the TIN indicates "GUTI" or "RAT-related TMSI" and the UE holds a valid GUTI, the UE shall indicate the GUTI in the Old GUTI IE.

...

When the tracking area updating procedure is initiated in EMM-IDLE mode, the UE may also include an EPS bearer context status IE in the TRACKING AREA UPDATE REQUEST message, indicating which EPS bearer contexts are active in the UE.

[TS24.301 clause 5.5.3.2.4]

...

Upon receiving a TRACKING AREA UPDATE ACCEPT message, the UE shall stop timer T3430, reset the routing area updating attempt counter, enter state EMM-REGISTERED and set the EPS update status to EU1 UPDATED. If the message contains a GUTI, the UE shall use this GUTI as new temporary identity for EPS services and shall store the new GUTI. If no GUTI was included by the MME in the TRACKING AREA UPDATE ACCEPT message, the old GUTI shall be used. If the UE receives a new TAI list in the TRACKING AREA UPDATE ACCEPT message, the UE shall consider the new TAI list as valid and the old TAI list as invalid; otherwise, the UE shall consider the old TAI list as valid.

...

If the TRACKING AREA UPDATE ACCEPT message contained a GUTI, the UE shall return a TRACKING AREA UPDATE COMPLETE message to the MME to acknowledge the received GUTI.

9.2.3.1.5.3 Test description

9.2.3.1.5.3.1 Pre-test conditions

System Simulator:

- cell A.

UE:

none.

Preamble:

- the UE is in state Switched OFF (state 1) according to TS 36.508 [18].

9.2.3.1.5.3.2 Test procedure sequence

Table 9.2.3.1.5.3.2-1: Main behaviour

St	Procedure	Message Sequence		TP	Verdict
		U - S	Message		
1	The UE is powered up or switched on.	-		-	-
2	The UE transmits an ATTACH REQUEST message with a PDN CONNECTIVITY REQUEST message to request PDN connectivity to the default PDN	-->	ATTACH REQUEST	-	-
3	The SS starts an authentication procedure	<--	AUTHENTICATION REQUEST	-	-
4	The UE responds to the authentication procedure	-->	AUTHENTICATION RESPONSE	-	-
5	The SS starts a NAS security mode command procedure to perform NAS integrity protection.	<--	SECURITY MODE COMMAND	-	-
6	The UE responds to the NAS security mode command procedure	-->	SECURITY MODE COMPLETE	-	-
-	EXCEPTION: Steps 6Aa1 to 6Aa2 describe behaviour that depends on UE configuration; the "lower case letter" identifies a step sequence that take place if the UE has ESM information which needs to be transferred.	-	-	-	-
6A a1	IF the UE sets the ESM information transfer flag in the last PDN CONNECTIVITY REQUEST message THEN the SS transmits an ESM INFORMATION REQUEST message to initiate exchange of protocol configuration options and/or APN.	<--	ESM INFORMATION REQUEST	-	-
6A a2	The UE transmits an ESM INFORMATION RESPONSE message to transfer protocol configuration options and/or APN.	-->	ESM INFORMATION RESPONSE	-	-
7	The SS transmits an ATTACH ACCEPT message with GUTI-1 and with the ACTIVATE DEFAULT EPS BEARER CONTEXT REQUEST message.	<--	ATTACH ACCEPT	-	-
8	The UE transmits an ATTACH COMPLETE message with the ACTIVATE DEFAULT EPS BEARER CONTEXT ACCEPT message	-->	ATTACH COMPLETE	-	-
9	The SS releases the RRC connection.			-	-
10	The SS waits 6minutes. (Expire of T3412)	-			
11	Check: Does the UE send TRACKING AREA UPDATE REQUEST message.	-->	TRACKING AREA UPDATE REQUEST	1	P
12	The SS sends TRACKING AREA UPDATE ACCEPT.	<--	TRACKING AREA UPDATE ACCEPT	-	-
13	The UE sends TRACKING AREA UPDATE COMPLETE message .	-->	TRACKING AREA UPDATE COMPLETE	-	-
14	The SS releases the RRC connection.			-	-
15	Check: Does the test result of generic test procedure in TS 36.508 subclause 6.4.2.4 indicate that the UE is in EMM-REGISTERED state on cell A with PagingUE-Identity = S-TMSI2 and with CN domain indicator set to "PS"?	-		1	-
16	Set the cell type of cell A to the "non-Suitable cell".	-		-	-
17	The SS waits 8minutes.	-		-	-
18	Set the cell type of cell A to the "Serving cell".	-		-	-
19	Check: Does the UE send TRACKING AREA UPDATE REQUEST message?	-->	TRACKING AREA UPDATE REQUEST	2	P
20	The SS sends TRACKING AREA UPDATE ACCEPT.	<--	TRACKING AREA UPDATE ACCEPT	-	-
21	The UE sends TRACKING AREA UPDATE COMPLETE message .	-->	TRACKING AREA UPDATE COMPLETE	-	-
22	The SS releases the RRC connection.	-	-	-	-
23	Check: Does the test result of generic test	-	-	2	-

	procedure in TS 36.508 subclause 6.4.2.4 indicate that the UE is in EMM-REGISTERED state in cell A with PagingUE-Identity = S-TMSI3 and with CN domain indicator set to "PS"?				
--	---	--	--	--	--

9.2.3.1.5.3.3 Specific message contents

Table 9.2.3.1.5.3.3-1: Message ATTACH ACCEPT (step 7, Table 9.2.3.1.5.3.2-1)

Derivation path: 36.508 table 4.7.2-1			
Information Element	Value/Remark	Comment	Condition
T3412 value			
Unit	'010'	"value is incremented in multiples of decihours"	
Timer value	'00001'	"6 minutes"	
TAI list			
Length of tracking area identity list contents	'00000110'B		
Partial tracking area identity list			
Number of elements	'00000'B		
Type of list	'00'B	"list of TACs belonging to one PLMN, with non-consecutive TAC values"	
MCC MNC TAC 1	TAI-1		
GUTI	GUTI-1		

Table 9.2.3.1.5.3.3-2: Message TRACKING AREA UPDATE REQUEST (step 11, Table 9.2.3.1.5.3.2-1)

Derivation path: 36.508 table 4.7.2-27			
Information Element	Value/Remark	Comment	Condition
EPS update type EPS update type value	'011'B	"Periodic updating"	
Old GUTI	GUTI-1		

Table 9.2.3.1.5.3.3-3: Message TRACKING AREA UPDATE ACCEPT (step 12, Table 9.2.3.1.5.3.2-1)

Derivation path: 36.508 table 4.7.2-24 with condition TA_only.			
Information Element	Value/Remark	Comment	Condition
T3412 value			
Unit	'010'	"value is incremented in multiples of decihours"	
Timer value	'00001'	"6 minutes"	
GUTI	GUTI-2		
TAI list			
Length of tracking area identity list contents	'00000110'B		
Partial tracking area identity list			
Number of elements	'00000'B		
Type of list	'00'B	"list of TACs belonging to one PLMN, with non-consecutive TAC values"	
MCC MNC TAC 1	TAI-1		

Table 9.2.3.1.5.3.3-4: Message TRACKING AREA UPDATE REQUEST (step 19, Table 9.2.3.1.5.3.2-1)

Derivation path: 36.508 table 4.7.2-27			
Information Element	Value/Remark	Comment	Condition
EPS update type			
EPS update type value	'011'B	"Periodic updating"	TA_only
	'010'B	"combined TA/LA updating with IMSI attach"	combined_TA_LA
Old GUTI	GUTI-2		

Table 9.2.3.1.5.3.3-5: Message TRACKING AREA UPDATE ACCEPT (step 20, Table 9.2.3.1.5.3.2-1)

Derivation path: 36.508 table 4.7.2-24			
Information Element	Value/Remark	Comment	Condition
GUTI	GUTI-3		
TAI list			
Length of tracking area identity list contents	'00000110'B		
Partial tracking area identity list			
Number of elements	'00000'B		
Type of list	'00'B	"list of TACs belonging to one PLMN, with non-consecutive TAC values"	
MCC MNC TAC 1	TAI-1		

9.2.3.1.5a Periodic tracking area update / Accepted / Per-device timer

9.2.3.1.5a.1 Test Purpose (TP)

(1)

with { UE in state EMM-REGISTERED and EMM-IDLE mode with timer T3412 'normal' and extended values being allocated by the NWK during attach procedure }
ensure that {

```

when { timer T3412 extended value expires }
then { UE sends TRACKING AREA UPDATE REQUEST message with EPS update type = 'Periodic updating' }
}

```

(2)

```

with { UE in state EMM-REGISTERED and EMM-IDLE mode with timer T3412 'normal' and extended values
being allocated by the NWK during TAU procedure }
ensure that {
when { timer T3412 extended value expires }
then { UE sends TRACKING AREA UPDATE REQUEST message with EPS update type = 'Periodic updating' }
}

```

9.2.3.1.5a.2 Conformance requirements

References: The conformance requirements covered in the present TC are specified in: 3GPP TS 24.301 clauses 5.3.5, 5.5.1.2.4 and 5.5.3.2.4.

[TS 24.301 clause 5.3.5]

Periodic tracking area updating is used to periodically notify the availability of the UE to the network. The procedure is controlled in the UE by the periodic tracking area update timer (timer T3412). The value of timer T3412 is sent by the network to the UE in the ATTACH ACCEPT message and can be sent in the TRACKING AREA UPDATE ACCEPT message. The UE shall apply this value in all tracking areas of the list of tracking areas assigned to the UE, until a new value is received.

The UE indicates in the MS network feature support IE whether it supports the T3412 extended value.

...

When a UE is not attached for emergency bearer services, and timer T3412 expires, the periodic tracking area updating procedure shall be started and the timer shall be set to its initial value for the next start.

...

If the network includes T3412 extended value IE in the ATTACH ACCEPT message or TRACKING AREA UPDATE ACCEPT message, the network shall use T3412 extended value IE as the value of timer T3412.

[TS 24.301 clause 5.5.1.2.4]

If the attach request is accepted by the network, the MME shall send an ATTACH ACCEPT message to the UE and start timer T3450. The MME shall send the ATTACH ACCEPT message together with an ACTIVATE DEFAULT EPS BEARER CONTEXT REQUEST message contained in the ESM message container information element to activate the default bearer (see subclause 6.4.1). The network may also initiate the activation of dedicated bearers towards the UE by invoking the dedicated EPS bearer context activation procedure (see subclause 6.4.2).

...

If the ATTACH ACCEPT message contains a T3412 extended value IE, then the UE shall use the value in T3412 extended value IE as periodic tracking area update timer (T3412). If the ATTACH ACCEPT message does not contain T3412 extended value IE, then the UE shall use the value in T3412 value IE as periodic tracking area update timer (T3412).

[TS24.301 clause 5.5.3.2.4]

If the tracking area update request has been accepted by the network, the MME shall send a TRACKING AREA UPDATE ACCEPT message to the UE. If the MME assigns a new GUTI for the UE, a GUTI shall be included in the TRACKING AREA UPDATE ACCEPT message. In this case, the MME shall start timer T3450 and enter state EMM-COMMON-PROCEDURE-INITIATED as described in subclause 5.4.1. The MME may include a new TAI list for the UE in the TRACKING AREA UPDATE ACCEPT message.

...

If the TRACKING AREA UPDATE ACCEPT message contains T3412 extended value IE, then the UE shall use the T3412 extended value IE as periodic tracking area update timer (T3412). If the TRACKING AREA UPDATE ACCEPT contains T3412 value IE, but not T3412 extended value IE, then the UE shall use value in T3412 value IE as periodic tracking area update timer (T3412). If neither T3412 value IE nor T3412 extended value IE is included, the UE

shall use the value currently stored, e.g. from a prior ATTACH ACCEPT or TRACKING AREA UPDATE ACCEPT message.

9.2.3.1.5a.3 Test description

9.2.3.1.5a.3.1 Pre-test conditions

System Simulator:

- cell A.

UE:

None.

Preamble:

- the UE is in state Switched OFF (state 1) according to TS 36.508 [18].

9.2.3.1.5a.3.2 Test procedure sequence

Table 9.2.3.1.5a.3.2-1: Main behaviour

St	Procedure	Message Sequence		TP	Verdict
		U - S	Message		
1	The UE is powered up or switched on.	-		-	-
2	The UE transmits an ATTACH REQUEST message with a PDN CONNECTIVITY REQUEST message to request PDN connectivity to the default PDN	-->	ATTACH REQUEST	-	-
3	The SS starts an authentication procedure	<--	AUTHENTICATION REQUEST	-	-
4	The UE responds to the authentication procedure	-->	AUTHENTICATION RESPONSE	-	-
5	The SS starts a NAS security mode command procedure to perform NAS integrity protection.	<--	SECURITY MODE COMMAND	-	-
6	The UE responds to the NAS security mode command procedure	-->	SECURITY MODE COMPLETE	-	-
-	EXCEPTION: Steps 6Aa1 to 6Aa2 describe behaviour that depends on UE configuration; the "lower case letter" identifies a step sequence that take place if the UE has ESM information which needs to be transferred.	-	-	-	-
6A a1	IF the UE sets the ESM information transfer flag in the last PDN CONNECTIVITY REQUEST message THEN the SS transmits an ESM INFORMATION REQUEST message to initiate exchange of protocol configuration options and/or APN.	<--	ESM INFORMATION REQUEST	-	-
6A a2	The UE transmits an ESM INFORMATION RESPONSE message to transfer protocol configuration options and/or APN.	-->	ESM INFORMATION RESPONSE	-	-
7	The SS transmits an ATTACH ACCEPT message with GUTI-1 and with the ACTIVATE DEFAULT EPS BEARER CONTEXT REQUEST message. SS assigns both a "normal" and an extended values for the T3412 timer.	<--	ATTACH ACCEPT	-	-
8	The UE transmits an ATTACH COMPLETE message with the ACTIVATE DEFAULT EPS BEARER CONTEXT ACCEPT message	-->	ATTACH COMPLETE	-	-
9	The SS releases the RRC connection.			-	-
10	The SS waits 6minutes. (Expire of T3412 extended value)	-			
11	Check: Does the UE send TRACKING AREA UPDATE REQUEST message.	-->	TRACKING AREA UPDATE REQUEST	1	P
12	The SS sends TRACKING AREA UPDATE ACCEPT. SS assigns both a "normal" and an extended values for the T3412 timer.	<--	TRACKING AREA UPDATE ACCEPT	-	-
13	The UE sends TRACKING AREA UPDATE COMPLETE message .	-->	TRACKING AREA UPDATE COMPLETE	-	-
14	The SS releases the RRC connection.			-	-
15	The SS waits 8 minutes. (Expire of T3412 extended value)	-		-	-
16	Check: Does the UE send TRACKING AREA UPDATE REQUEST message.	-->	TRACKING AREA UPDATE REQUEST	2	P
17	The SS sends TRACKING AREA UPDATE ACCEPT. The SS assigns T3412 'normal' and extended values. the extended value is different to the one assigned in the ATTACH ACCEPT message in step 7.	<--	TRACKING AREA UPDATE ACCEPT	-	-
18	The UE sends TRACKING AREA UPDATE COMPLETE message .	-->	TRACKING AREA UPDATE COMPLETE	-	-
19	The SS releases the RRC connection.			-	-

9.2.3.1.5a.3.3 Specific message contents

Table 9.2.3.1.5a.3.3-1: Message ATTACH ACCEPT (step 7, Table 9.2.3.1.5a.3.2-1)

Derivation path: 36.508 table 4.7.2-1			
Information Element	Value/Remark	Comment	Condition
T3412 value			
Unit	'010'B	value is incremented in multiples of 1 minute	
Timer value	'00100'B	"4 minutes"	
TAI list			
Length of tracking area identity list contents	'00000110'B		
Partial tracking area identity list			
Number of elements	'00000'B		
Type of list	'00'B	"list of TACs belonging to one PLMN, with non-consecutive TAC values"	
MCC MNC TAC 1	TAI-1		
GUTI	GUTI-1		
T3412 extended value			
Unit	'010'B	value is incremented in multiples of 1 minute	
Timer value	'00110'B	"6 minutes"	

Table 9.2.3.1.5a.3.3-2: Message TRACKING AREA UPDATE REQUEST (steps 11 and 16, Table 9.2.3.1.5a.3.2-1)

Derivation path: 36.508 table 4.7.2-27			
Information Element	Value/Remark	Comment	Condition
EPS update type EPS update type value	'011'B	"Periodic updating"	
Old GUTI	GUTI-1		

Table 9.2.3.1.5a.3.3-3: Message TRACKING AREA UPDATE ACCEPT (steps 12 and 17, Table 9.2.3.1.5a.3.2-1)

Derivation path: 36.508 table 4.7.2-24 with condition TA_only.			
Information Element	Value/Remark	Comment	Condition
T3412 value			
Unit	'010'B	value is incremented in multiples of 1 minute	
Timer value	'00100'B	"4 minutes"	
GUTI	GUTI-2		
TAI list			
Length of tracking area identity list contents	'00000110'B		
Partial tracking area identity list			
Number of elements	'00000'B		
Type of list	'00'B	"list of TACs belonging to one PLMN, with non-consecutive TAC values"	
MCC MNC TAC 1	TAI-1		
T3412 extended value			
Unit	'010'B	value is incremented in multiples of 1 minute	
Timer value	'01000'B	"8 minutes"	

9.2.3.1.6 Normal tracking area update / UE with ISR active moves to E-UTRAN

9.2.3.1.6.1 Test Purpose (TP)

(1)

```
with { ISR activated UE in state EMM-REGISTERED and ECM_IDLE mode }
ensure that {
  when { ISR activated UE reselects from E-UTRAN to UTRAN/GERAN cell belonging to the RA where the
  UE is registered }
  then { UE does not send ROUTING AREA UPDATE REQUEST message }
}
```

(2)

```
with { ISR activated UE in state EMM-REGISTERED and ECM_IDLE mode }
ensure that {
  when { ISR activated UE reselects from E-UTRAN to UTRAN/GERAN cell belonging to a RA which is not
  the RA where the UE is registered }
  then { UE sends ROUTING AREA UPDATE REQUEST message }
}
```

(3)

```
with { ISR activated UE in state GMM-REGISTERED and PMM_IDLE mode }
ensure that {
  when { ISR activated UE reselects from UTRAN/GERAN to E-UTRAN cell belonging to one of the TAs of
  the list of TAs where the UE is registered }
  then { UE does not send TRACKING AREA UPDATE REQUEST message }
}
```

(4)

```
with { ISR activated UE in state GMM-REGISTERED and PMM_IDLE mode }
ensure that {
  when { ISR activated UE reselects from UTRAN/GERAN to E-UTRAN cell belonging to a TA which is not
  in the list of TAs where the UE is registered }
  then { UE sends TRACKING AREA UPDATE REQUEST message }
}
```

}

(5)

```

with { ISR activated UE has a stored TIN value = "RAT-related TMSI" }
ensure that {
  when { SS sends a Paging with "P-TMSI" to ISR activated UE on UTRAN/GERAN cell }
  then { UE responds to the paging message }
}

```

(6)

```

with { ISR activated UE has a stored TIN value = "RAT-related TMSI" }
ensure that {
  when { SS sends a Paging with "GUTI" to ISR activated UE on E-UTRAN cell }
  then { UE responds to the paging message }
}

```

9.2.3.1.6.2 Conformance requirements

References: The conformance requirements covered in the present TC are specified in: 3GPP TS23.401 clause 4.3.5.6, 3GPP TS24.008 clauses 4.7.5.1.1 and 4.7.5.1.3 and 3GPP TS 24.301 clauses 5.5.3.2.2 and 5.5.3.2.4.

[TS23.401 clause 4.3.5.6]

The Idle mode Signalling Reduction (ISR) function provides a mechanism to limit signalling during inter-RAT cell-reselection in idle mode (ECM-IDLE, PMM-IDLE, GPRS STANDBY states).

NOTE: The Idle mode Signalling Reduction function is mandatory for E-UTRAN UEs that support GERAN and/or UTRAN and optional for core network. The UE's ISR capability in the UE Network Capability element is for test purpose.

ISR is activated by decision of the CN nodes and shall be explicitly signalled to the UE as "ISR activation" in the RAU and TAU signalling. The UE may have valid MM parameters both from MME and from SGSN. The "Temporary Identity used in Next update" (TIN) is a parameter of the UE's MM context, which identifies the UE identity that the UE shall indicate in the next RAU Request or TAU Request message. The TIN also identifies the status of ISR activation in the UE.

The TIN can take one of the three values, "P-TMSI", "GUTI" or "RAT-related TMSI". The UE shall set the TIN when receiving an Attach Accept, a TAU Accept or RAU Accept message according to the rules in table 4.3.5.6-1.

Table 4.3.5.6-1: Setting of the TIN

Message received by UE	Current TIN value stored by UE	TIN value to be set by the UE when receiving message
Attach Accept via E-UTRAN (never indicates ISR activation)	Any value	GUTI
Attach Accept via GERAN/UTRAN (never indicates ISR activation)	Any value	P-TMSI
TAU Accept not indicating ISR	Any value	GUTI
TAU Accept indicating ISR	GUTI P-TMSI or RAT-related TMSI	GUTI RAT-related TMSI
RAU Accept not indicating ISR	Any value	P-TMSI
RAU Accept indicating ISR	P-TMSI GUTI or RAT-related TMSI	P-TMSI RAT-related TMSI

When ISR activation is indicated by the RAU/TAU Accept message but the UE shall not set the TIN to "RAT-related TMSI" is a special situation. Here the UE has deactivated ISR due to special situation handling. By maintaining the old TIN value the UE remembers to use the RAT specific TMSI indicated by the TIN when updating with the CN node of the other RAT.

Only if the TIN is set to "RAT-related TMSI" ISR behaviour is enabled for the UE, i.e. the UE can change between all registered areas and RATs without any update signalling and it listens for paging on the RAT it is camped on. If the TIN is set to "RAT-related TMSI", the UE's P-TMSI and RAI as well as its GUTI and TAI(s) shall remain registered with the network and shall remain valid in the UE.

Table 4.3.5.6-1: Old temporary UE Identity that the UE shall indicate in TAU/RAU Request (as old GUTI or as old P-TMSI/RAI)

Message to be sent by UE	TIN value: P-TMSI	TIN value: GUTI	TIN value: RAT-related TMSI
TAU Request	GUTI mapped from P-TMSI/RAI	GUTI	GUTI
RAU Request	P-TMSI/RAI	P-TMSI/RAI mapped from GUTI	P-TMSI/RAI
Attach Request via E-UTRAN	GUTI mapped from P-TMSI/RAI	GUTI	GUTI
Attach Request via GERAN/UTRAN	P-TMSI/RAI	P-TMSI/RAI mapped from GUTI	P-TMSI/RAI

Table 4.3.5.2-1 shows which temporary identity the UE shall indicate in a Tracking or Routing Area Update Request of in an Attach Request message, when the UE stores these as valid parameters.

Situations may occur that cause unsynchronized state information in the UE, MME and SGSN. Such special situations trigger a deactivation of ISR locally in the UE.

...

[TS24.008 clause 4.7.5.1.1]

...

If the MS supports S1 mode, the MS shall handle the P-TMSI IE as follows:

- If the TIN indicates "GUTI" and the MS holds a valid GUTI, the MS shall map the GUTI into a P-TMSI, P-TMSI signature and RAI as specified in 3GPP TS 23.003 [4]. The MS shall include the mapped RAI in the Old routing area identification IE and the mapped P-TMSI signature in the P-TMSI signature IE. When the routing area updating procedure is initiated in Iu mode, the MS shall also include the mapped P-TMSI in the P-TMSI IE. Additionally, in Iu mode and A/Gb mode, if the MS holds a valid P-TMSI and RAI, the MS shall indicate the P-TMSI in the Additional mobile identity IE and the RAI in the Additional old routing area identification IE.
- If the TIN indicates "P-TMSI" or "RAT-related TMSI" and the MS holds a valid P-TMSI and RAI, the MS shall indicate the RAI in the Old routing area identification IE. When the routing area updating procedure is initiated in Iu mode, the MS shall also include the P-TMSI in the P-TMSI IE.

...

[TS24.008 clause 4.7.5.1.3]

...

In order to indicate to the MS that the GUTI and TAI list assigned to the MS remain registered with the network and are valid in the MS, the network shall indicate in the Update result IE in the ROUTING AREA UPDATE ACCEPT message that ISR is activated.

If the ROUTING AREA UPDATE ACCEPT message contains

- i) no indication that ISR is activated, an MS supporting S1 mode shall set the TIN to "P-TMSI"; or
- ii) an indication that ISR is activated, the MS shall regard the available GUTI and TAI list as valid and registered with the network. If the TIN currently indicates "GUTI", the MS shall set the TIN to "RAT-related TMSI".

[TS24.301 clause 5.5.3.2.2]

The UE in state EMM-REGISTERED shall initiate the tracking area updating procedure by sending a TRACKING AREA UPDATE REQUEST message to the MME,

...

If the UE supports neither A/Gb mode nor Iu mode, the UE shall include a valid GUTI in the Old GUTI IE in the TRACKING AREA UPDATE REQUEST message.

If the UE supports A/Gb mode or Iu mode, the UE shall handle the Old GUTI IE as follows:

- If the TIN indicates "P-TMSI" and the UE holds a valid P-TMSI and RAI, the UE shall map the P-TMSI and RAI into the Old GUTI IE. Additionally, if the UE holds a valid GUTI, the UE shall indicate the GUTI in the Additional GUTI IE.

NOTE: The mapping of the P-TMSI and RAI to the GUTI is specified in 3GPP TS 23.003 [2].

- If the TIN indicates "GUTI" or "RAT-related TMSI" and the UE holds a valid GUTI, the UE shall indicate the GUTI in the Old GUTI IE.

...

[TS24.301 clause 5.5.3.2.4]

The network may also indicate in the EPS update result IE in the TRACKING AREA UPDATE ACCEPT message that ISR is active. If the TRACKING AREA UPDATE ACCEPT message contains:

- i) no indication that ISR is activated, the UE shall set the TIN to "GUTI";
- ii) an indication that ISR is activated, the UE shall regard a previously assigned P-TMSI and RAI as valid and registered with the network. If the TIN currently indicates "P-TMSI", the UE shall set the TIN to "RAT-related TMSI".

9.2.3.1.6.3 Test description

9.2.3.1.6.3.1 Pre-test conditions

System Simulator:

- cell A (belongs to TAI-1, home PLMN) is set to "Non- Suitable cell";
- cell B (belongs to TAI-2, home PLMN) is set to "Non- Suitable cell";
- if pc_UTRA AND px_RATComb_Tested = EUTRA_UTRA, cell 5 and cell 7 (belong to RAI-1, home PLMN) are configured;
- if pc_GERAN AND px_RATComb_Tested = EUTRA_GERAN, cell 24 and cell 25 are configured;
- cell 5 / cell 24 belong to RAI-1 (home PLMN) as specified TS34.123-1 clause 12 and is set to "Serving cell";
- cell 7 / cell 25 belong to RAI-2 (home PLMN) as specified TS34.123-1 clause 12 and is set to "Non- Suitable "off" cell";
- system information indicate that NMO 1 is used.
- System information combination 10a as defined in TS 36.508[18] clause 4.4.3.1 is used in E-UTRA cells.

Note: Setting px_RATComb_Tested = EUTRA_Only is not allowed.

UE:

none.

Preamble:

- the UE is in state Switched OFF (state 1) according to TS 36.508 [18].

9.2.3.1.6.3.2 Test procedure sequence

Table 9.2.3.1.6.3.2-1: Main behaviour

St	Procedure	Message Sequence		TP	Verdict
		U – S	Message		
1	The UE is switched on.	-	-	-	-
-	The following messages are sent on Cell 5 or 24	-	-	-	-
2	The UE transmits an ATTACH REQUEST message on Cell 5 or 24	-->	ATTACH REQUEST	-	-
3	The SS transmits an AUTHENTICATION AND CIPHERING REQUEST message.	<--	AUTHENTICATION AND CIPHERING REQUEST	-	-
4	The UE transmits an AUTHENTICATION AND CIPHERING RESPONSE message.	-->	AUTHENTICATION AND CIPHERING RESPONSE	-	-
5	SS responds with ATTACH ACCEPT message including P-TMSI-1 (TIN set to P-TMSI) and RAI-1.	<--	ATTACH ACCEPT	-	-
6	The UE transmits an ATTACH COMPLETE message.	-->	ATTACH COMPLETE	-	-
7	The UE transmits an ACTIVATE PDP CONTEXT REQUEST message	-->	ACTIVATE PDP CONTEXT REQUEST	-	-
8	The SS responds with an ACTIVATE PDP CONTEXT ACCEPT message	<--	ACTIVATE PDP CONTEXT ACCEPT	-	-
9	Set the cell type of cell 5 or 24 to the "Non-Suitable cell". Set the cell type of cell A to the "Serving cell".	-	-	-	-
10	The UE sends TRACKING AREA UPDATE REQUEST message.	-->	TRACKING AREA UPDATE REQUEST	-	-
11	The SS sends TRACKING AREA UPDATE ACCEPT including GUTI-1(TIN set to RAT-related TMSI) and TAI-1.	<--	TRACKING AREA UPDATE ACCEPT	-	-
12	The UE sends TRACKING AREA UPDATE COMPLETE message.	-->	TRACKING AREA UPDATE COMPLETE	-	-
12 A	The SS releases the RRC connection.	-	-	-	-
13	Set the cell type of cell A to the "Non-Suitable cell". Set the cell type of cell 5 or 24 to the "Serving cell".	-	-	-	-
14	Check: Does the UE transmit a ROUTING AREA UPDATE REQUEST message in the next 90 seconds on cell 5 or 24?	-->	ROUTING AREA UPDATE REQUEST	1	F
15	SS transmits Paging for PS domain on Cell 5/24.	<--	<i>Paging</i>	-	-
15 A	Check: Does the UE transmit a Paging response?	-->	<i>RRCCConnectionRequest</i>	5	P
15 B	SS sends RRCCConnectionReject	<--	<i>RRCCConnectionReject</i>	-	-
16	Set the cell type of cell 5 or 24 to the "Non-Suitable cell". Set the cell type of cell A to the "Serving cell".	-	-	-	-
17	Check: Does the UE send TRACKING AREA UPDATE REQUEST message in the next 90 seconds.	-->	TRACKING AREA UPDATE REQUEST	3	F
18	Check: Does the test result of generic test procedure in TS 36.508 subclause 6.4.2.4 indicate that the UE is in EMM-REGISTERED state on cell A with PagingUE-Identity = S-TMSI1 and with CN domain indicator set to "PS"?	-	-	3, 6	-
18 A	Set the cell type of cell A to the "Non-Suitable cell". Set the cell type of cell 5 or 24 to the "Serving cell".	-	-	-	-
18 B	Check: Does the UE transmit a ROUTING AREA UPDATE REQUEST message in the	-->	ROUTING AREA UPDATE REQUEST	1	F

	next 90 seconds on cell 5 or 24?				
19	Set the cell type of cell 5 or 24 to the "Non-Suitable off cell". Set the cell type of cell B to the "Serving cell".	-	-	-	-
20	Check: Does the UE send TRACKING AREA UPDATE REQUEST message.	-->	TRACKING AREA UPDATE REQUEST	4	P
21	The SS sends TRACKING AREA UPDATE ACCEPT including GUTI-2 and TAI-2.	<--	TRACKING AREA UPDATE ACCEPT	-	-
22	The UE sends TRACKING AREA UPDATE COMPLETE message.	-->	TRACKING AREA UPDATE COMPLETE	-	-
22 A	The SS releases the RRC connection.	-	-	-	-
23	Check: Does the test result of generic test procedure in TS 36.508 subclause 6.4.2.4 indicate that the UE is in EMM-REGISTERED state on cell B with PagingUE-Identity = S-TMSI2 and with CN domain indicator set to "PS"?	-	-	6	-
24	Set the cell type of cell A to the "Non-Suitable "off" cell". Set the cell type of cell B to the "Non-Suitable cell". Set the cell type of cell 7 or 25 to the "Serving cell".	-	-	-	-
25	Check: Does the UE transmit a ROUTING AREA UPDATE REQUEST message with P-TMSI and RAI on cell 7 or 25?	-->	ROUTING AREA UPDATE REQUEST	2	P
26	The SS sends ROUTING AREA UPDATE ACCEPT message with P-TMSI-2 and RAI-2.	<--	ROUTING AREA UPDATE ACCEPT	-	-
27	The UE sends ROUTING AREA UPDATE COMPLETE message.	-->	ROUTING AREA UPDATE COMPLETE	-	-

9.2.3.1.6.3.3 Specific message contents

Table 9.2.3.1.6.3.3-1: Message TRACKING AREA UPDATE REQUEST (step 10, Table 9.2.3.1.6.3.2-1)

Derivation path: 36.508 table 4.7.2-27			
Information Element	Value/Remark	Comment	Condition
Old GUTI	Mapped from the P-TMSI and RAI allocated in step 5		
Old P-TMSI signature	Any allowed value		
Nonce _{UE}	Any allowed value		

Table 9.2.3.1.6.3.3-2: Message TRACKING AREA UPDATE ACCEPT (step 11, Table 9.2.3.1.6.3.2-1)

Derivation path: 36.508 table 4.7.2-24			
Information Element	Value/Remark	Comment	Condition
EPS update result	'100'B	"TA updated and ISR activated"	TA only
	'101'B	"combined TA/LA updated and ISR activated"	combined_TA_LA
T3412 value	Not present	(Note)	
GUTI	GUTI-1		
TAI list			
Length of tracking area identity list contents	'00000110'B		
Partial tracking area identity list			
Number of elements	'00000'B		
Type of list	'00'B	"list of TACs belonging to one PLMN, with non-consecutive TAC values"	
MCC MNC TAC 1	TAI-1		
Note: This is to allow the UE to apply the default timer, and avoid Rel-10 and higher releases impact on the UE behaviour which is not part of the TPs			

Table 9.2.3.1.6.3.3-3: Message TRACKING AREA UPDATE REQUEST (step 20, Table 9.2.3.1.6.3.2-1)

Derivation path: 36.508 table 4.7.2-27			
Information Element	Value/Remark	Comment	Condition
Old GUTI	GUTI-1		

Table 9.2.3.1.6.3.3-4: Message TRACKING AREA UPDATE ACCEPT (step 21, Table 9.2.3.1.6.3.2-1)

Derivation path: 36.508 table 4.7.2-24			
Information Element	Value/Remark	Comment	Condition
EPS update result	'001'B	"TA updated and ISR activated"	TA only
	'101'B	"combined TA/LA updated and ISR activated"	combined_TA_LA
T3412 value	Not present	(Note)	
GUTI	GUTI-2		
TAI list			
Length of tracking area identity list contents	'00000110'B		
Partial tracking area identity list			
Number of elements	'00000'B		
Type of list	'00'B	"list of TACs belonging to one PLMN, with non-consecutive TAC values"	
MCC MNC TAC 1	TAI-2		
Note: This is to allow the UE to apply the default timer, and avoid Rel-10 and higher releases impact on the UE behaviour which is not part of the TPs			

Table 9.2.3.1.6.3.3-5: Message ROUTING AREA UPDATE ACCEPT (step 26, Table 9.2.3.1.6.3.2-1)

Derivation path: 36.508, table 4.7B.2-2			
Information Element	Value/remark	Comment	Condition
Update result	100	"RA updated and ISR activated"	TA_only
	101	"combined RA/LA updated and ISR activated"	combined_TA_LA
Periodic RA update timer	'01001001'B	Activated with default T3312 value of 54 min as TS 24.008, Table 11.3a (Note)	
Note: The timer is specified to avoid Rel-10 and higher releases impact on the UE behaviour which is not part of the TPs			

Table 9.2.3.1.6.3.3-6: Message ATTACH ACCEPT (step 5, Table 9.2.3.1.6.3.2-1)

Derivation path: 36.508, table 4.7B.2-7			
Information Element	Value/Remark	Comment	Condition
Periodic RA update timer	'01001001'B	Activated with default T3312 value of 54 min as TS 24.008, Table 11.3a (Note)	
Note: The timer is specified to avoid Rel-10 and higher releases impact on the UE behaviour which is not part of the TPs			

9.2.3.1.7 Void

9.2.3.1.8 UE receives an indication that the RRC connection was released with cause "load balancing TAU required"

9.2.3.1.8.1 Test Purpose (TP)

(1)

```
with { UE in state EMM-REGISTERED and EMM-CONNECTED mode}
ensure that {
  when { UE receives RRC CONNECTION RELEASE message with cause "load balancing TAU required" and
  enters EMM-REGISTERED and EMM-IDLE mode}
  then { UE sends TRACKING AREA UPDATE REQUEST message with EPS update type = "TA updating"}
```

(2)

```
with { UE in state EMM-REGISTERED and EMM-CONNECTED mode}
ensure that {
  when { UE receives RRC CONNECTION RELEASE message with cause "load balancing TAU required" and
  enters EMM-REGISTERED and EMM-IDLE mode}
  then { the UE encodes the RRC parameters in the RRC Connection Establishment messages correctly
  (i.e. in the RRCConnectionRequest message, the ue-Identity is set random-Value; and, in the
  RRCConnectionSetupComplete message the registeredMME is not included) }
```

9.2.3.1.8.2 Conformance requirements

References: The conformance requirements covered in the present TC are specified in: 3GPP TS 23.401 clause 4.3.7.3, 3GPP TS 24.301 clauses 5.3.1.1, 5.5.3.1, 5.5.3.2.2 and 5.5.3.2.4, and 3G PP TS 36.331 clauses and 5.3.3.3 and 5.3.3.4].

[TS 23.401 clause 4.3.7.3]

...

To off-load ECM-CONNECTED mode UEs, the MME initiates the S1 Release procedure with release cause "load balancing TAU required" (clause 5.3.5). The S1 and RRC connections are released and the UE initiates a TAU but provides neither the S-TMSI nor the GUMMEI to eNodeB in the RRC establishment.

...

[TS 24.301 clause 5.3.1.1]

...

When the UE is registered in the tracking area of the current cell during the NAS signalling connection establishment, the UE NAS shall provide the lower layers with the S-TMSI, but shall not provide the registered MME identifier to the lower layers. Exceptionally, when the UE in EMM-IDLE mode initiates a tracking area updating or combined tracking area updating procedure for load balancing purposes, the UE NAS shall provide the lower layers with neither S-TMSI nor registered MME identifier.

...

[TS24.301 clause5.5.3.1]

The tracking area updating procedure is always initiated by the UE and is used for the following purposes:

...

- MME load balancing;

...

[TS24.301 clause 5.5.3.2.2]

The UE in state EMM-REGISTERED shall initiate the tracking area updating procedure by sending a TRACKING AREA UPDATE REQUEST message to the MME,

...

- e) when the UE receives an indication from the lower layers that the RRC connection was released with cause "load balancing TAU required";

...

...

[TS24.301 clause 5.5.3.2.4]

If the tracking area update request has been accepted by the network, the MME shall send a TRACKING AREA UPDATE ACCEPT message to the UE. If the MME assigns a new GUTI for the UE, a GUTI shall be included in the TRACKING AREA UPDATE ACCEPT message. In this case, the MME shall start timer T3450 and enter state EMM-COMMON-PROCEDURE-INITIATED as described in subclause 5.4.1. The MME may include a new TAI list for the UE in the TRACKING AREA UPDATE ACCEPT message.

...

Upon receiving a TRACKING AREA UPDATE ACCEPT message, the UE shall stop timer T3430, reset the tracking area updating attempt counter, enter state EMM-REGISTERED and set the EPS update status to EU1 UPDATED. If the message contains a GUTI, the UE shall use this GUTI as new temporary identity for EPS services and shall store the new GUTI. If no GUTI was included by the MME in the TRACKING AREA UPDATE ACCEPT message, the old GUTI shall be used. If the UE receives a new TAI list in the TRACKING AREA UPDATE ACCEPT message, the UE shall consider the new TAI list as valid and the old TAI list as invalid; otherwise, the UE shall consider the old TAI list as valid.

...

If the TRACKING AREA UPDATE ACCEPT message contained a GUTI, the UE shall return a TRACKING AREA UPDATE COMPLETE message to the MME to acknowledge the received GUTI.

[TS 36.331 clause 5.3.3.3]

The UE shall set the contents of *RRCCConnectionRequest* message as follows:

1> set the *ue-Identity* as follows:

2> if upper layers provide an S-TMSI:

3> set the *ue-Identity* to the value received from upper layers;

2> else:

3> draw a random value in the range $0 \dots 2^{40}-1$ and set the *ue-Identity* to this value;

...

[TS 36.331 clause 5.3.3.4]

...

1> set the content of *RRCCConnectionSetupComplete* message as follows:

...

2> if upper layers provide the 'Registered MME', include and set the *registeredMME* as follows:

3> if the PLMN identity of the 'Registered MME' is different from the PLMN selected by the upper layers:

4> include the *plmnIdentity* in the *registeredMME* and set it to the value of the PLMN identity in the 'Registered MME' received from upper layers;

3> set the *mmegi* and the *mmec* to the value received from upper layers;

2> if upper layers provided the 'Registered MME':

3> include and set the *gummei-Type* to the value provided by the upper layers;

...

9.2.3.1.8.3 Test description

9.2.3.1.8.3.1 Pre-test conditions

System Simulator:

- cell A.

UE:

none.

Preamble:

- the UE is in state Generic RB established (state 3) on cell A according to TS 36.508 [18].

9.2.3.1.8.3.2 Test procedure sequence

Table 9.2.3.1.8.3.2-1: Main behaviour

St	Procedure	Message Sequence		TP	Verdict
		U - S	Message		
1	The SS transmits <i>RRCCConnectionRelease</i> with cause "load balancing TAU required".	-	-	-	-
1A	Check: Does the UE send an <i>RRCCConnectionRequest</i> with the <i>ue-Identity</i> set to "random-Value"?	-->	<i>RRCCConnectionRequest</i>	1	P
1B	The SS responds with <i>RRCCConnectionSetup</i> .	<--	<i>RRCCConnectionSetup</i>	-	-
1C	Check: Does the UE send an <i>RRCCConnectionSetupComplete</i> without the <i>registeredMME IE</i> ?	-->	<i>RRCCConnectionSetupComplete</i>	1	P
2	Check: Does the UE send TRACKING AREA UPDATE REQUEST message.	-->	TRACKING AREA UPDATE REQUEST	1	P
3	The SS sends TRACKING AREA UPDATE ACCEPT. (Note 1)	<--	TRACKING AREA UPDATE ACCEPT	-	-
4	The UE sends TRACKING AREA UPDATE COMPLETE message.	-->	TRACKING AREA UPDATE COMPLETE	-	-
-	At the end of this test procedure sequence, the UE is in end state E-UTRA connected (E2_T3440) according to TS 36.508.	-	-	-	-

Note 1: The SS assigns a different MME Identifier (MMEI) value in a GUTI.

9.2.3.1.8.3.3 Specific message contents

Table 9.2.3.1.8.3.3-1: Message TRACKING AREA UPDATE ACCEPT (step 3, Table 9.2.3.1.8.3.2-1)

Derivation path: 36.508 table 4.7.2-24			
Information Element	Value/Remark	Comment	Condition
GUTI	GUTI-2		

Table 9.2.3.1.8.3.3-2: Message RRCCConnectionRequest (step 1A, Table 9.2.3.1.8.3.2-1)

Derivation path: 36.508 table 4.6.1-16			
Information Element	Value/Remark	Comment	Condition
<i>RRCCConnectionRequest</i> ::= SEQUENCE {			
criticalExtensions CHOICE {			
<i>rrcConnectionRequest-r8</i> SEQUENCE {			
ue-Identity CHOICE {			
random-Value	Any allowed value		
}			
establishmentCause	Mo-Signalling		
}			
}			

Table 9.2.3.1.8.3.3-3: Message RRCConnectionSetupComplete (step 1C, Table 9.2.3.1.8.3.2-1)

Derivation path: 36.508 table 4.6.1-18			
Information Element	Value/Remark	Comment	Condition
RRCConnectionSetupComplete ::= SEQUENCE {			
criticalExtensions CHOICE {			
c1 CHOICE {			
rrcConnectionSetupComplete-r8 SEQUENCE {			
selectedPLMN-Identity	1		
registeredMME	Not present		
dedicatedInfoNAS	See table 9.2.3.1.8.3.3-3		
nonCriticalExtension SEQUENCE {}			
}			
}			
}			
}			

9.2.3.1.9 Normal tracking area update / Correct handling of CSG list

9.2.3.1.9.1 Test Purpose (TP)

(1)

```
with { UE in state EMM-REGISTERED and EMM-IDLE mode}
ensure that {
  when { Manual CSG ID selection is requested }
  then { UE sends TRACKING AREA UPDATE REQUEST message with 'EPS update type = TA updating' }
}
```

(2)

```
with { UE in state EMM-REGISTERED and EMM-IDLE mode; and UE's Allowed CSG list is not empty }
ensure that {
  when { UE detects suitable E-UTRAN CSG cell previously visited }
  then { UE reselects the suitable previously visited E-UTRAN CSG cell and sends TRACKING AREA
UPDATE REQUEST message with 'EPS update type = TA updating' }
}
```

9.2.3.1.9.2 Conformance requirements

References: The conformance requirements covered in the current TC are specified in: TS24.301, clauses 5.5.3.1, 5.5.3.2.2 and 5.5.3.2.4.

[TS 24.301, clause 5.5.3.1]

The tracking area updating procedure is always initiated by the UE and is used for the following purposes:

- normal tracking area updating to update the registration of the actual tracking area of a UE in the network;
- ...
- to indicate to the network that the UE has selected a CSG cell whose CSG identity is not included in the UE's Allowed CSG list.

[TS 24.301, clause 5.5.3.2.2]

The UE in state EMM-REGISTERED shall initiate the tracking area updating procedure by sending a TRACKING AREA UPDATE REQUEST message to the MME,

- a) when the UE detects entering a tracking area that is not in the list of tracking areas that the UE previously registered in the MME;
- ...
- k) when due to manual CSG selection the UE has selected a CSG cell whose CSG identity is not included in the UE's Allowed CSG list;

...

After sending the TRACKING AREA UPDATE REQUEST message to the MME, the UE shall start timer T3430 and enter state EMM-TRACKING-AREA-UPDATING-INITIATED (see example in figure 5.5.3.2.2). If timer T3402 is currently running, the UE shall stop timer T3402. If timer T3411 is currently running, the UE shall stop timer T3411. If timer T3442 is currently running, the UE shall stop timer T3442.

If the UE supports neither A/Gb mode nor Iu mode, the UE shall include a valid GUTI in the Old GUTI IE in the TRACKING AREA UPDATE REQUEST message.

If the UE supports A/Gb mode or Iu mode, the UE shall handle the Old GUTI IE as follows:

- If the TIN indicates "P-TMSI" and the UE holds a valid P-TMSI and RAI, the UE shall map the P-TMSI and RAI into the Old GUTI IE. If a P-TMSI signature is associated with the P-TMSI, the UE shall include it in the Old P-TMSI signature IE. Additionally, if the UE holds a valid GUTI, the UE shall indicate the GUTI in the Additional GUTI IE.

NOTE: The mapping of the P-TMSI and RAI to the GUTI is specified in 3GPP TS 23.003 [2].

- If the TIN indicates "GUTI" or "RAT-related TMSI" and the UE holds a valid GUTI, the UE shall indicate the GUTI in the Old GUTI IE.

.....

[TS 24.301, clause 5.5.3.2.4]

If the tracking area update request has been accepted by the network, the MME shall send a TRACKING AREA UPDATE ACCEPT message to the UE. If the MME assigns a new GUTI for the UE, a GUTI shall be included in the TRACKING AREA UPDATE ACCEPT message. In this case, the MME shall start timer T3450 and enter state EMM-COMMON-PROCEDURE-INITIATED as described in subclause 5.4.1. The MME may include a new TAI list for the UE in the TRACKING AREA UPDATE ACCEPT message.

...

Upon receiving a TRACKING AREA UPDATE ACCEPT message, the UE shall stop timer T3430, reset the tracking area updating attempt counter, enter state EMM-REGISTERED and set the EPS update status to EU1 UPDATED. If the message contains a GUTI, the UE shall use this GUTI as new temporary identity for EPS services and shall store the new GUTI. If no GUTI was included by the MME in the TRACKING AREA UPDATE ACCEPT message, the old GUTI shall be used. If the UE receives a new TAI list in the TRACKING AREA UPDATE ACCEPT message, the UE shall consider the new TAI list as valid and the old TAI list as invalid; otherwise, the UE shall consider the old TAI list as valid.

...

If the UE has initiated the tracking area updating procedure due to manual CSG selection and receives a TRACKING AREA UPDATE ACCEPT message, the UE shall check if the CSG ID of the cell where the UE has sent the TRACKING AREA UPDATE REQUEST message is contained in the Allowed CSG list. If not, the UE shall add that CSG ID to the Allowed CSG list.

If the TRACKING AREA UPDATE ACCEPT message contained a GUTI, the UE shall return a TRACKING AREA UPDATE COMPLETE message to the MME to acknowledge the received GUTI.

Upon receiving a TRACKING AREA UPDATE COMPLETE message, the MME shall stop timer T3450, and shall consider the GUTI sent in the TRACKING AREA UPDATE ACCEPT message as valid.

...

9.2.3.1.9.3 Test description

9.2.3.1.9.3.1 Pre-test conditions

System Simulator:

- Cell A (belongs to TAI-1, home PLMN, not a CSG cell) is set to "Serving cell";
- Cell B (belongs to TAI-3, home PLMN, is a CSG cell) is set to "Non- Suitable cell";

- Cell D (belongs to TAI-4, home PLMN, not a CSG cell) is set to "Non- Suitable cell".
- System information combination 2 as defined in TS 36.508[18] clause 4.4.3.1 is used in E-UTRA cells A and D
- System information combination 7 as defined in TS 36.508[18] clause 4.4.3.1 is used in cell B;

UE:

- the UE is configured to initiate EPS attach;
- pc_Allowed_CSG_list, the UE's Allowed CSG list is empty.

Preamble:

- the UE is in state Registered, Idle Mode (state 2) on Cell A according to TS 36.508 [18].

9.2.3.1.9.3.2 Test procedure sequence

Table 9.2.3.1.9.3.2-1: Main behaviour

St	Procedure	Message Sequence		TP	Verdict
		U - S	Message		
1	The SS configures: - Cell A as a "Not Suitable cell". - Cell B as a "Serving cell". - Cell D as a "Not Suitable "Off" cell".	-	-	-	-
2	The UE performs manual CSG ID selection and CSG Identity ('000 0000 0000 0000 0000 0000 0010'B) is selected manually.	-	-	-	-
3	Check: Does the UE transmit a TRACKING AREA UPDATE REQUEST message on Cell B?	-->	TRACKING AREA UPDATE REQUEST	1	P
4	The SS transmits a TRACKING AREA UPDATE ACCEPT message. NOTE: UE shall add the selected CSG ID as indicate in step 2 to UE's Allowed CSG list.	<--	TRACKING AREA UPDATE ACCEPT	-	-
5	Check: Does the UE transmit a TRACKING AREA UPDATE COMPLETE message on Cell B?	-->	TRACKING AREA UPDATE COMPLETE	1	P
6	The SS releases the RRC connection.	-	-	-	-
7	The SS configures: - Cell A as a "Not Suitable "Off" cell". - Cell B as a "Not Suitable cell". - Cell D as a "Serving cell".	-	-	-	-
8	The UE transmits a TRACKING AREA UPDATE REQUEST message on Cell D.	-->	TRACKING AREA UPDATE REQUEST	-	-
9	The SS transmits a TRACKING AREA UPDATE ACCEPT message.	<--	TRACKING AREA UPDATE ACCEPT	-	-
10	The UE transmits a TRACKING AREA UPDATE COMPLETE message on Cell D.	-->	TRACKING AREA UPDATE COMPLETE	-	-
11	The SS releases the RRC connection.	-	-	-	-
12	The SS configures: - Cell B as a "Serving cell". - Cell D as a "Not Suitable cell".	-	-	-	-
13	Check: Does the UE camped on Cell B within 6 min and transmits a TRACKING AREA UPDATE REQUEST message?	-->	TRACKING AREA UPDATE REQUEST	2	P
14	The SS transmits a TRACKING AREA UPDATE ACCEPT message.	<--	TRACKING AREA UPDATE ACCEPT	-	-
15	Check: Does the UE transmit a TRACKING AREA UPDATE COMPLETE message on Cell C?	-->	TRACKING AREA UPDATE COMPLETE	2	P

9.2.3.1.9.3.3 Specific message contents

Table 9.2.3.1.9.3.3-1: Message TRACKING AREA UPDATE REQUEST (step 3, Table 9.2.3.1.9.3.2-1)

Derivation path: 36.508 table 4.7.2-27			
Information Element	Value/Remark	Comment	Condition
Old GUTI	GUTI-1	"Old GUTI is included by UE if valid, IMSI otherwise"	
Last visited registered TAI	TAI-1		

Table 9.2.3.1.9.3.3-2: Message TRACKING AREA UPDATE ACCEPT (step 4, Table 9.2.3.1.9.3.2-1)

Derivation path: 36.508 table 4.7.2-24			
Information Element	Value/Remark	Comment	Condition
GUTI	GUTI-2		
TAI list			
Length of tracking area identity list contents	'00000110'B		
Partial tracking area identity list			
Number of elements	'00000'B		
Type of list	'00'B	"list of TACs belonging to one PLMN, with non-consecutive TAC values"	
MCC MNC TAC 1	PLMN= MCC/MNC TAC 1=2	"PLMN is set to the same MCC/MNC stored in EF _{IMSI} " "TAI-2"	

Table 9.2.3.1.9.3.3-3: Message TRACKING AREA UPDATE REQUEST (step 8, Table 9.2.3.1.9.3.2-1)

Derivation path: 36.508 table 4.7.2-27			
Information Element	Value/Remark	Comment	Condition
Old GUTI	GUTI-2	"Old GUTI is included by UE if valid, IMSI otherwise"	
Last visited registered TAI	TAI-2		

Table 9.2.3.1.9.3.3-4: Message TRACKING AREA UPDATE ACCEPT (step 9, Table 9.2.3.1.9.3.2-1)

Derivation Path: TS 36.508, Table 4.7.2-24			
Information Element	Value/remark	Comment	Condition
GUTI	GUTI-3		
TAI list			
Length of tracking area identity list contents	'00000110'B		
Partial tracking area identity list			
Number of elements	'00000'B		
Type of list	'00'B	"list of TACs belonging to one PLMN, with non-consecutive TAC values"	
MCC MNC TAC 1	PLMN= MCC/MNC TAC 1=4	"PLMN is set to the same MCC/MNC stored in EF _{IMSI} " "TAI-4"	

Table 9.2.3.1.9.3.3-5: Message TRACKING AREA UPDATE REQUEST (step 13, Table 9.2.3.1.9.3.2-1)

Derivation path: 36.508 table 4.7.2-27			
Information Element	Value/Remark	Comment	Condition
Old GUTI	GUTI-3		
Last visited registered TAI	TAI-4		

Table 9.2.3.1.9.3.3-6: Message TRACKING AREA UPDATE ACCEPT (step 14, Table 9.2.3.1.9.3.2-1)

Derivation path: 36.508 table 4.7.2-24			
Information Element	Value/Remark	Comment	Condition
GUTI	GUTI-2		
TAI list			
Length of tracking area identity list contents	'00000110'B		
Partial tracking area identity list			
Number of elements	'00000'B		
Type of list	'00'B	"list of TACs belonging to one PLMN, with non-consecutive TAC values"	
MCC MNC TAC 1	PLMN= MCC/MNC TAC 1=2	"PLMN is set to the same MCC/MNC stored in EF _{IMSI} " "TAI-2"	

9.2.3.1.9a Normal tracking area update / NAS signalling connection recovery

9.2.3.1.9a.1 Test Purpose (TP)

(1)

```
with { UE in state EMM-REGISTERED and EMM-CONNECTED }
ensure that {
  when { UE receives an indication of "RRC Connection failure" from the lower layers }
  then { UE initiates the tracking area updating procedure }
}
```

9.2.3.1.9a.2 Conformance requirements

References: The conformance requirements covered in the present TC are specified in: TS 24.301, clause 5.5.3.1, 5.5.3.2.2 and 5.5.3.3.2 and TS 36.331, clause 5.3.7.8 and 5.3.12.

[TS 24.301, clause 5.5.3.1]

The tracking area updating procedure is always initiated by the UE and is used for the following purposes:

...

- recovery from certain error cases (for details see subclauses 5.5.3.2.2 and subclause 5.5.3.3.2);

[TS 24.301, clause 5.5.3.2.2]

The UE in state EMM-REGISTERED shall initiate the tracking area updating procedure by sending a TRACKING AREA UPDATE REQUEST message to the MME,

...

- i) when the UE receives an indication of "RRC Connection failure" from the lower layers and has no signalling or user uplink data pending (i.e. when the lower layer requests NAS signalling connection recovery);

...

For all cases except case b, the UE shall set the EPS update type IE to "TA updating". For case b, the UE shall set the EPS update type IE to "periodic updating".

[TS 24.301, clause 5.5.3.3.2]

The UE operating in CS/PS mode 1 or CS/PS mode 2, in state EMM-REGISTERED, shall initiate the combined tracking area updating procedure:

...

- j) when the UE receives an indication of "RRC Connection failure" from the lower layers and has no signalling or user uplink data pending (i.e. when the lower layer requests NAS signalling connection recovery);

...

To initiate a combined tracking area updating procedure the UE sends the message TRACKING AREA UPDATE REQUEST to the network, starts timer T3430 and changes to state EMM-TRACKING-AREA-UPDATING-INITIATED. The value of the EPS update type IE in the message shall indicate "combined TA/LA updating" unless explicitly specified otherwise.

[TS 36.331, clause 5.3.7.8]

Upon receiving the *RRCConnectionReestablishmentReject* message, the UE shall:

- 1> perform the actions upon leaving RRC_CONNECTED as specified in 5.3.12, with release cause 'RRC connection failure';

[TS 36.331, clause 5.3.12]

Upon leaving RRC_CONNECTED, the UE shall:

...

- 1> indicate the release of the RRC connection to upper layers together with the release cause;

9.2.3.1.9a.3 Test description

9.2.3.1.9a.3.1 Pre-test conditions

System Simulator:

- cell A and cell B (same TA); Cell B is configured to belong to TAI-1;
- cell A is "Serving cell" and cell B is "non-Suitable cell".

UE:

none.

Preamble:

- the UE is in state Generic RB Established (state 3) on cell A according to TS 36.508 [18].

9.2.3.1.9a.3.2 Test procedure sequence

Table 9.2.3.1.9a.3.2-1: Main behaviour

St	Procedure	Message Sequence		TP	Verdict
		U - S	Message		
1	Set the cell type of Cell A to the "Non-Suitable "Off" cell". Set the cell type of Cell B to the "Serving cell".	-	-	-	-
-	The following messages are to be observed on Cell B unless explicitly stated otherwise.	-	-	-	-
2	The UE transmits an <i>RRCCONNECTIONREESTABLISHMENTREQUEST</i> .	-	-	-	-
3	The SS transmits an <i>RRCCONNECTIONREESTABLISHMENTREJECT</i> .	-	-	-	-
4	Check: Does the UE transmit a TRACKING AREA UPDATE REQUEST with the EPS update type set to 'TA updating' or 'combined TA/LA updating' in the next 10 seconds?	-->	TRACKING AREA UPDATE REQUEST	1	P
5	The SS transmits a TRACKING AREA UPDATE ACCEPT message.	<--	TRACKING AREA UPDATE ACCEPT	-	-
-	At the end of this test procedure sequence, the UE is in end state E-UTRA connected (E2_T3440) according to TS 36.508.	-	-	-	-

9.2.3.1.9a.3.3 Specific message contents

Table 9.2.3.1.9a.3.3-1: Message TRACKING AREA UPDATE REQUEST (step 4, Table 9.2.3.1.9a.3.2-1)

Derivation Path: TS 36.508, Table 4.7.2-27			
Information Element	Value/remark	Comment	Condition
Old GUTI	GUTI-1		
Last visited registered TAI	TAI-1		

Table 9.2.3.1.9a.3.3-2: Message TRACKING AREA UPDATE ACCEPT (step 5, Table 9.2.3.1.9a.3.2-1)

Derivation Path: TS 36.508, Table 4.7.2-24			
Information Element	Value/remark	Comment	Condition
GUTI	Not present		
MS identity	Not present		

9.2.3.1.10 Normal tracking area update / Rejected / IMSI invalid

9.2.3.1.10.1 Test Purpose (TP)

(1)

```
with { UE has sent a TRACKING AREA UPDATE REQUEST message }
ensure that {
  when { UE receives a TRACKING AREA UPDATE REJECT message with the reject cause set to 'Illegal UE' }
  then { UE considers the USIM as invalid for EPS services and non-EPS services and enters state EMM-DEREGISTERED }
}
```

(2)

```
with { The UE is in the state EMM-DEREGISTERED }
ensure that {
  when { UE is powered up }
  then { UE send ATTACH REQUEST message with Old GUTI or IMSI IE = 'IMSI' }
```

9.2.3.1.10.2 Conformance requirements

References: The conformance requirements covered in the present TC are specified in: 3GPP TS 24.301 clauses 5.5.3.2.5.

[TS24.301 clause 5.5.3.2.5]

If the tracking area updating cannot be accepted by the network, the MME sends a TRACKING AREA UPDATE REJECT message to the UE including an appropriate EMM cause value.

Upon receiving the TRACKING AREA UPDATE REJECT message, the UE shall stop timer T3430, stop any transmission of user data, and take the following actions depending on the EMM cause value received.

#3 (Illegal UE); or

....

The UE shall set the EPS update status to EU3 ROAMING NOT ALLOWED (and shall store it according to subclause 5.1.3.3) and shall delete any GUTI, last visited registered TAI, TAI list and KSI. The UE shall consider the USIM as invalid for EPS services until switching off or the UICC containing the USIM is removed. The UE shall delete the list of equivalent PLMNs and shall enter the state EMM-DEREGISTERED.

If A/Gb mode or Iu mode is supported by the UE, the UE shall handle the GMM parameters GMM state, GPRS update status, P-TMSI, P-TMSI signature, RAI and GPRS ciphering key sequence number and the MM parameters update status, TMSI, LAI and ciphering key sequence number as specified in 3GPP TS 24.008 [13] for the case when the normal routing area updating procedure is rejected with the GMM cause with the same value. The USIM shall be considered as invalid also for non-EPS services until switching off or the UICC containing the USIM is removed.

9.2.3.1.10.3 Test description

9.2.3.1.10.3.1 Pre-test conditions

System Simulator:

- cell A (belongs to TAI-1, home PLMN) is set to "Serving cell";
- cell B (belongs to TAI-2, home PLMN) is set to "Non-suitable cell";
- If (px_SinglePLMN_Test = Multi PLMN) cell G (belongs to TAI-7, visited PLMN) is set to "Non-suitable cell";
- If (px_RATComb_Test = EUTRA_UTRA OR px_RATComb_Test = EUTRA_GERAN);
- if pc_UTRA AND px_RATComb_Test = EUTRA_UTRA, cell 9 (UTRAN, belong to RAI-1) is set to "Non-suitable "off" cell";
- if pc_GERAN AND px_RATComb_Test = EUTRA_GERAN, cell 24 (GERAN, belong to RAI-1) is set to "Non-suitable "off" cell";
- system information combination 10 as defined in TS 36.508[18] clause 4.4.3.1 is applied in E-UTRA cells;
- If (px_RATComb_Test = EUTRA_Only):
 - neither cell 9 nor cell 24 is configured;
 - system information combination 1 as defined in TS 36.508[18] clause 4.4.3.1 is applied in E-UTRA cells.

UE:

- the UE is configured to initiate EPS attach;
- if pc_UTRA AND px_RATComb_Test = EUTRA_UTRA, the UE is previously registered on UTRAN cell 5 using default message contents according to TS 36.508 [18].
- if pc_GERAN AND px_RATComb_Test = EUTRA_GERAN, the UE is previously registered on GERAN cell 24 using default message contents according to TS 36.508 [18].

Preamble:

- the UE is in state Registered, Idle Mode (state 2) on cell A according to TS 36.508 [18].

9.2.3.1.10.3.2 Test procedure sequence

Table 9.2.3.1.10.3.2-1: Main behaviour

St	Procedure	Message Sequence		TP	Verdict
		U - S	Message		
1	Set the cell type of cell A to the "Non-Suitable cell". Set the cell type of cell B to the "Serving cell".	-	-	-	-
2	The UE transmits a TRACKING AREA UPDATE REQUEST on Cell B.	-->	TRACKING AREA UPDATE REQUEST	-	-
3	The SS transmits a TRACKING AREA UPDATE REJECT message with EMM cause = "Illegal UE" as specified.	<--	TRACKING AREA UPDATE REJECT	-	-
4	The SS releases the RRC connection.	-	-	-	-
5	Set the cell type of cell A to the "Serving cell". Set the cell type of cell B to the "Non-Suitable cell".	-	-	-	-
6	Check: Does the UE transmit an ATTACH REQUEST message in the next 90 seconds on cell A? Note: Cell A belongs to the same PLMN where the UE was rejected but a different TAC	-->	ATTACH REQUEST	1	F
7	The user initiates an attach by MMI or by AT command.	-	-	-	-
8	Check: Does the UE transmit an ATTACH REQUEST message in the next 90 seconds on cell A?	-->	ATTACH REQUEST	1	F
-	EXCEPTION: Steps 9a to 12a describe behaviour that depends on the network capability / preference; the "lower case letter" identifies a step sequence that takes place if the network is capable or prefers.	-	-	-	-
9a	Set the cell type of cell A to the " Non-Suitable cell". Set the cell type of cell G to the "Serving cell".	-	-	-	-
10a	If (px_SinglePLMN_Testcd = Multi PLMN) Check: Does the UE transmit an ATTACH REQUEST message in the next 90 seconds on cell G? Note: Cell G belongs to a PLMN which is not the same like the one on which the UE was rejected.	-->	ATTACH REQUEST	1	F
11a	The user initiates an attach by MMI or by AT command.	-	-	-	-
12a	Check: Does the UE transmit an ATTACH REQUEST message in the next 90 seconds on cell G?	-->	ATTACH REQUEST	1	F
13	If present, set the cell type of cell G to the "Non-Suitable "off" cell". If present, set the cell type of cell 9 or 24 to the "Serving cell".				
	EXCEPTION: Steps 14a1 to 14a2 describe behaviour that depends on the UE capability; the "lower case letter" identifies a step sequence that take place if a capability is supported				
14a1	IF pc_UTRA AND px_RATComb_Testcd = EUTRA_UTRA OR pc_GERAN AND px_RATComb_Testcd = EUTRA_GERAN THEN the user initiates an attach by MMI or by AT command.	-	-	-	-

14a2	Check: Does the UE transmit an ATTACH REQUEST message in the next 90 seconds on cell 9 or 24?	-->	ATTACH REQUEST	1	F
15	If possible (see ICS) switch off is performed or the USIM is removed. Otherwise the power is removed.	-	-	-	-
16	Set the cell type of cell A to the "Serving cell". If present, set the cell type of cell G to the "Non-Suitable cell". If present, set the cell type of cell 9 or 24 to the "Non-Suitable "off" cell".	-	-	-	-
17	The UE is brought back to operation or the USIM is inserted.	-	-	-	-
18	Check: Does the UE transmit an ATTACH REQUEST message on cell A?	-->	ATTACH REQUEST	2	P
19-30	The attach procedure is completed by executing steps 5 to 16 of the UE registration procedure in TS 36.508 sub clause 4.5.2.3.	-	-	-	-
-	At the end of this test procedure sequence, the UE is in end state E-UTRA connected (E2) according to TS 36.508.	-	-	-	-

9.2.3.1.10.3.3 Specific message contents

Table 9.2.3.1.10.3.3-1: Void

Table 9.2.3.1.10.3.3-2: Message TRACKING AREA UPDATE REJECT (step 3, Table 9.2.3.1.10.3.2-1)

Derivation path: 36.508 table 4.7.2-24			
Information Element	Value/Remark	Comment	Condition
EMM cause	00000011	#3 "Illegal UE"	

Table 9.2.3.1.10.3.3-3: Message ATTACH REQUEST (step 18, Table 9.2.3.1.10.3.2-1)

Derivation path: 36.508 table 4.7.2-4			
Information Element	Value/Remark	Comment	Condition
Old GUTI or IMSI	IMSI		

9.2.3.1.11 Normal tracking area update / Rejected / Illegal ME

9.2.3.1.11.1 Test Purpose (TP)

(1)

```
with { UE has sent a TRACKING AREA UPDATE REQUEST message}
ensure that {
  when { UE receives a TRACKING AREA UPDATE REJECT message with the reject cause set to "Illegal ME"
}
  then { UE considers the USIM as invalid for EPS services and non-EPS services and enters state EMM-DEREGISTERED }
```

(2)

```
with { The UE is in the state EMM-DEREGISTERED }
ensure that {
  when { UE is powered up }
  then { UE send ATTACH REQUEST message with Old GUTI or IMSI IE = ''IMSI'' }
```

9.2.3.1.11.2 Conformance requirements

References: The conformance requirements covered in the present TC are specified in: 3GPP TS 24.301 clauses 5.5.3.2.5.

[TS24.301 clause5.5.3.2.5]

If the tracking area updating cannot be accepted by the network, the MME sends a TRACKING AREA UPDATE REJECT message to the UE including an appropriate EMM cause value.

Upon receiving the TRACKING AREA UPDATE REJECT message, the UE shall stop timer T3430, stop any transmission of user data, and take the following actions depending on the EMM cause value received.

...

#6 (Illegal ME);

The UE shall set the EPS update status to EU3 ROAMING NOT ALLOWED (and shall store it according to subclause 5.1.3.3) and shall delete any GUTI, last visited registered TAI, TAI list and KSI. The UE shall consider the USIM as invalid for EPS services until switching off or the UICC containing the USIM is removed. The UE shall delete the list of equivalent PLMNs and shall enter the state EMM-DEREGISTERED.

If A/Gb mode or Iu mode is supported by the UE, the UE shall handle the GMM parameters GMM state, GPRS update status, P-TMSI, P-TMSI signature, RAI and GPRS ciphering key sequence number and the MM parameters update status, TMSI, LAI and ciphering key sequence number as specified in 3GPP TS 24.008 [13] for the case when the normal routing area updating procedure is rejected with the GMM cause with the same value. The USIM shall be considered as invalid also for non-EPS services until switching off or the UICC containing the USIM is removed.

9.2.3.1.11.3 Test description

The test description is identical to the one of subclause 9.2.3.1.10 except that the reject cause #3 "Illegal UE" is replaced with the reject cause #6 "Illegal ME".

9.2.3.1.12 Normal tracking area update / Rejected / EPS service not allowed

9.2.3.1.12.1 Test Purpose (TP)

(1)

```
with { UE has sent a TRACKING AREA UPDATE REQUEST message }
ensure that {
  when { UE receives a TRACKING AREA UPDATE REJECT message with the reject cause set to 'EPS
service not allowed' }
    then { UE considers the USIM as invalid for EPS services and enters state EMM-DEREGISTERED }
```

(2)

```
with { The UE is in the state EMM-DEREGISTERED }
ensure that {
  when { UE is powered up or switched on }
    then { UE sends ATTACH REQUEST message with 'Old GUTI or IMSI IE = 'IMSI'' }
```

9.2.3.1.12.2 Conformance requirements

References: The conformance requirements covered in the present TC are specified in: 3GPP TS 24.301 clauses 5.5.3.2.5.

[TS24.301 clause5.5.3.2.5]

If the tracking area updating cannot be accepted by the network, the MME sends a TRACKING AREA UPDATE REJECT message to the UE including an appropriate EMM cause value.

Upon receiving the TRACKING AREA UPDATE REJECT message, the UE shall stop timer T3430, stop any transmission of user data, and take the following actions depending on the EMM cause value received.

...

#7 (EPS services not allowed);

The UE shall set the EPS update status to EU3 ROAMING NOT ALLOWED (and shall store it according to subclause 5.1.3.3) and shall delete any GUTI, last visited registered TAI, TAI list and KSI. The UE shall

consider the USIM as invalid for EPS services until switching off or the UICC containing the USIM is removed. The UE shall delete the list of equivalent PLMNs and shall enter the state EMM-DEREGISTERED.

If A/Gb mode or Iu mode is supported by the UE, the UE shall handle the GMM parameters GMM state, GPRS update status, P-TMSI, P-TMSI signature, RAI and GPRS ciphering key sequence number as specified in 3GPP TS 24.008 [13] for the case when the normal routing area updating procedure is rejected with the GMM cause with the same value.

9.2.3.1.12.3 Test description

The test description is identical to the one of subclause 9.2.3.1.10 except that the reject cause #3 “illegal UE” is replaced with reject cause #7 “EPS services not allowed”.

9.2.3.1.12.3.2 Test procedure sequence

Same test procedure as in clause 9.2.3.1.10.3.2 with the following exception:

Depending on UE capabilities the behaviour in table 9.2.3.1.12.3.2-1 occurs in parallel with step 14a2

Table 9.2.3.1.12.3.2-1: Parallel behaviour

St	Procedure	Message Sequence		TP	Verdict
		U - S	Message		
-	EXCEPTION: Steps 1a1-1a 5 describe a behaviour which depends on the UE capability; the "lower case letter" identifies a step sequence that take place if a capability is supported.	-	-	-	-
1a1	IF pc_CS THEN the UE transmits a LOCATION UPDATING REQUEST message.	-->	LOCATION UPDATING REQUEST	-	-
-	EXCEPTION: The messages in the next two steps are sent only IF pc_GERAN AND px_RATComb_Tested = EUTRA_GERAN	-	-	-	-
1a2a 1	The UE transmits a <i>Classmark Change</i> message	-->	CLASSMARK CHANGE	-	-
1a2a 2	IF pc_UTRA THEN the UE transmits a <i>Utran Classmark Change</i> message.	-->	UTRAN CLASSMARK CHANGE.	-	-
1a3	The SS transmits an AUTHENTICATION REQUEST message to initiate the authentication and AKA procedure.	<--	AUTHENTICATION REQUEST	-	-
1a4	The UE transmits an AUTHENTICATION RESPONSE message.	-->	AUTHENTICATION RESPONSE	-	-
1a5	The SS transmits a LOCATION UPDATING ACCEPT message including IMSI-1	<--	LOCATION UPDATING ACCEPT	-	-

9.2.3.1.12.3.3 Specific message contents

Table 9.2.3.1.12.3.3-1: LOCATION UPDATING ACCEPT (step 5, Table 9.2.3.1.12.3.2-1)

Derivation Path: TS 36.508 Table 4.7B.2-5			
Information Element	Value/remark	Comment	Condition
Mobile identity			
IMSI	IMSI-1		

9.2.3.1.13 Normal tracking area update / Rejected / UE identity cannot be derived by the network

9.2.3.1.13.1 Test Purpose (TP)

(1)

```
with { UE has sent a TRACKING AREA UPDATE REQUEST message}
ensure that {
  when { UE receives a TRACKING AREA UPDATE REJECT message with the reject cause set to 'UE
identity cannot be derived by the network' }
}
```

then { UE deletes any GUTI, last visited registered TAI, TAI list and KSI and enters the state EMM-DEREGISTERED and subsequently, UE automatically initiates the attach procedure}

9.2.3.1.13.2 Conformance requirements

References: The conformance requirements covered in the present TC are specified in: 3GPP TS 24.301 clauses 5.5.3.2.5.

[TS24.301 clause5.5.3.2.5]

If the tracking area updating cannot be accepted by the network, the MME sends a TRACKING AREA UPDATE REJECT message to the UE including an appropriate EMM cause value.

Upon receiving the TRACKING AREA UPDATE REJECT message, the UE shall stop timer T3430, stop any transmission of user data, and take the following actions depending on the EMM cause value received.

...

#9 (UE identity cannot be derived by the network);

The UE shall set the EPS update status to EU2 NOT UPDATED (and shall store it according to subclause 5.1.3.3) and shall delete any GUTI, last visited registered TAI, TAI list and KSI. The UE shall delete the list of equivalent PLMNs and shall enter the state EMM-DEREGISTERED.

Subsequently, the UE shall automatically initiate the attach procedure.

NOTE 2: User interaction is necessary in some cases when the UE cannot re-activate the EPS bearer(s) automatically.

If A/Gb mode or Iu mode is supported by the UE, the UE shall handle the GMM parameters GMM state, GPRS update status, P-TMSI, P-TMSI signature, RAI and GPRS ciphering key sequence number as specified in 3GPP TS 24.008 [13] for the case when the normal routing area updating procedure is rejected with the GMM cause with the same value.

9.2.3.1.13.3 Test description

9.2.3.1.13.3.1 Pre-test conditions

System Simulator:

- cell A (belongs to TAI-1, home PLMN) is set to "Serving cell";
- cell B (belongs to TAI-2, home PLMN) is set to "Non-suitable cell";
- System information combination 3 as defined in TS 36.508[18] clause 4.4.3.1 is used in E-UTRA cells.

UE:

- the UE is configured to initiate EPS attach.

Preamble:

- the UE is in state Registered, Idle Mode (state 2) on cell A according to TS 36.508 [18].

9.2.3.1.13.3.2 Test procedure sequence

Table 9.2.3.1.13.3.2-1: Main behaviour

St	Procedure	Message Sequence		TP	Verdict
		U - S	Message		
1	Set the cell type of cell A to the "Non-Suitable cell". Set the cell type of cell B to the "Serving cell".	-	-	-	-
2	The UE transmits a TRACKING AREA UPDATE REQUEST on Cell B.	-->	TRACKING AREA UPDATE REQUEST	-	-
3	The SS transmits a TRACKING AREA UPDATE REJECT message with EMM cause = " UE identity cannot be derived by the network " as specified.	<--	TRACKING AREA UPDATE REJECT	-	-
-	EXCEPTION: Steps 4-17-4a1 describes the behaviour that depends on UE behaviour (Note 1).	-	-	-	-
4	The SS releases the RRC connection.	-	-	-	-
-	EXCEPTION: Step 4a1 describes a behaviour which depends on the UE capability	-	-	-	-
4a1	IF NOT pc_Automatic_EPS_Re_Attach , the user initiates an attach by MMI or by AT command.	-	-	-	-
5	Check: Does the UE transmit an ATTACH REQUEST message on cell B?	-->	ATTACH REQUEST	1	P
6-17	The attach procedure is completed by executing steps 5 to 16 of the UE registration procedure in TS 36.508 sub clause 4.5.2.3.	-	-	-	-
-	At the end of this test procedure sequence, the UE is in end state E-UTRA connected (E2) according to TS 36.508.	-	-	-	-

Note 1: SS waits for 1 second to receive the Attach Request on the existing RRC Connection. In case Attach Request is not received within 1 second then the existing RRC Connection is released.

9.2.3.1.13.3.3 Specific message contents

Table 9.2.3.1.13.3.3-1: Message TRACKING AREA UPDATE REQUEST (step 2, Table 9.2.3.1.13.3.2-1)

Derivation path: 36.508 table 4.7.2-27			
Information Element	Value/Remark	Comment	Condition
Old GUTI	GUTI-1		
Old P-TMSI signature	Absent or any allowed value		

Table 9.2.3.1.13.3.3-2: Message TRACKING AREA UPDATE REJECT (step 3, Table 9.2.3.1.13.3.2-1)

Derivation path: 36.508 table 4.7.2-24			
Information Element	Value/Remark	Comment	Condition
EMM cause	'00001001'B	#9 "UE identity cannot be derived by the network"	

Table 9.2.3.1.13.3.3-3: Message ATTACH REQUEST (step 5, Table 9.2.3.1.13.3.2-1)

Derivation path: 36.508 table 4.7.2-4			
Information Element	Value/Remark	Comment	Condition
Old GUTI or IMSI	IMSI		
Old P-TMSI signature	Not present		
Last visited registered TAI	Not present		

Table 9.2.3.1.13.3.3-4: Message ATTACH REJECT (step 6, Table 9.2.3.1.13.3.2-1)

Derivation Path: 36.508 table 4.7.2-3			
Information Element	Value/remark	Comment	Condition
EMM cause	'0000 1111'B	#15 "No suitable cells in tracking area"	

9.2.3.1.14 Normal tracking area update / Rejected / UE implicitly detached

9.2.3.1.14.1 Test Purpose (TP)

(1)

```
with { UE has sent a TRACKING AREA UPDATE REQUEST message}
ensure that {
  when { UE receives a TRACKING AREA UPDATE REJECT message with the reject cause set to 'UE
implicitly detached' }
  then { UE enters the state EMM-DEREGISTERED.NORMAL-SERVICE and sends ATTACH REQUEST message}
```

9.2.3.1.14.2 Conformance requirements

References: The conformance requirements covered in the present TC are specified in: 3GPP TS 24.301 clauses 5.5.3.2.5.

[TS24.301 clause5.5.3.2.5]

If the tracking area updating cannot be accepted by the network, the MME sends a TRACKING AREA UPDATE REJECT message to the UE including an appropriate EMM cause value.

Upon receiving the TRACKING AREA UPDATE REJECT message, the UE shall stop timer T3430, stop any transmission of user data, and take the following actions depending on the EMM cause value received.

...

#10 (Implicitly detached);

The UE shall delete the list of equivalent PLMNs and shall enter the state EMM-DEREGISTERED.NORMAL-SERVICE. The UE shall delete any mapped EPS security context or partial native EPS security context. The UE shall perform a new attach procedure.

NOTE 3: User interaction is necessary in some cases when the UE cannot re-activate the EPS bearer(s) automatically.

If A/Gb mode or Iu mode is supported by the UE, the UE shall handle the GMM state as specified in 3GPP TS 24.008 [13] for the case when the normal routing area updating procedure is rejected with the GMM cause with the same value.

9.2.3.1.14.3 Test description

9.2.3.1.14.3.1 Pre-test conditions

System Simulator:

- cell A belongs to TAI-1, home PLMN) is set to "Serving cell";
- cell B belongs to TAI-2, home PLMN is set to "Non- Suitable cell";
- System information combination 3 as defined in TS 36.508[18] clause 4.4.3.1 is used in E-UTRA cells.

UE:

- the UE is configured to initiate EPS attach.

Preamble:

- the UE is in state Registered, Idle Mode (state 2) on cell A according to TS 36.508 [18].

9.2.3.1.14.3.2 Test procedure sequence

Table 9.2.3.1.14.3.2-1: Main behaviour

St	Procedure	Message Sequence		TP	Verdict
		U - S	Message		
1	Set the cell type of cell A to the "Non-Suitable cell". Set the cell type of cell B to the "Serving cell".	-	-	-	-
2	The UE transmits a TRACKING AREA UPDATE REQUEST on Cell B.	-->	TRACKING AREA UPDATE REQUEST	-	-
3	The SS transmits a TRACKING AREA UPDATE REJECT message with EMM cause = "UE implicitly detached" as specified.	<--	TRACKING AREA UPDATE REJECT	-	-
-	EXCEPTION: Steps 3a1-3a2 describes the behaviour that depends on UE behaviour (Note 1).	-	-	-	-
3a1	The SS releases the RRC connection.	-	-	-	-
-	EXCEPTION: Step 3a2 describes a behaviour which depends on the UE capability	-	-	-	-
3a2	IF NOT pc_Automatic_EPS_Re_Attach , the user initiates an attach by MMI or by AT command.	-	-	-	-
4	Check: Does the UE transmit an ATTACH REQUEST message on cell B?	-->	ATTACH REQUEST	1	P
5-16	The attach procedure is completed by executing steps 5 to 16 of the UE registration procedure in TS 36.508 sub clause 4.5.2.3.	-	-	-	-
-	At the end of this test procedure sequence, the UE is in end state E-UTRA connected (E2) according to TS 36.508.	-	-	-	-
Note 1: SS waits for 1 second to receive the Attach Request on the existing RRC Connection. In case Attach Request is not received within 1 second, existing RRC Connection is released.					

9.2.3.1.14.3.3 Specific message contents

Table 9.2.3.1.14.3.3-1: Void**Table 9.2.3.1.14.3.3-2: Message TRACKING AREA UPDATE REJECT (step 3, Table 9.2.3.1.14.3.2-1)**

Derivation path: 36.508 table 4.7.2-24			
Information Element	Value/Remark	Comment	Condition
EMM cause	'00001010'B	#10 "UE implicitly detached"	

Table 9.2.3.1.14.3.3-3: Message ATTACH REQUEST (step 4, Table 9.2.3.1.14.3.2-1)

Derivation path: 36.508 table 4.7.2-4			
Information Element	Value/Remark	Comment	Condition
Old GUTI or IMSI	GUTI-1		
Last visited registered TAI	TAI-1		

9.2.3.1.15 Normal tracking area update / Rejected / PLMN not allowed

9.2.3.1.15.1 Test Purpose (TP)

(1)

```

with { UE has sent a TRACKING AREA UPDATE REQUEST message }
ensure that {
  when { UE receives a TRACKING AREA UPDATE REJECT message with the reject cause set to "PLMN not allowed" }

```



```

    then { UE deletes the GUTI, the last visited registered TAI and KSI and UE deletes the list of
    equivalent PLMNs and UE enters state EMM-DEREGISTERED.PLMN-SEARCH and UE stores the PLMN in the
    "forbidden PLMN list" }
  }

```

(2)

```

with { UE is switched off having a PLMN stored in the "forbidden PLMN list" }
ensure that {
  when { UE is powered up on this PLMN }
  then { UE doesn't perform an attach procedure }
}

```

(3)

```

with { UE in EMM-DEREGISTERED.PLMN-SEARCH state having a PLMN stored in the "forbidden PLMN list" }
ensure that {
  when { UE enters a cell which is not in the "forbidden PLMN list" }
  then { UE initiates an attach procedure }
}

```

(4)

```

with { UE in E-UTRA EMM-DEREGISTERED.PLMN-SEARCH state having a PLMN stored in the "forbidden PLMN
list" }
ensure that {
  when { UE is in a forbidden PLMN cells and when the PLMN is selected manually }
  then { UE initiates an attach procedure }
}

```

9.2.3.1.15.2 Conformance requirements

References: The conformance requirements covered in the present TC are specified in: 3GPP TS 24.301 clauses 5.5.3.2.5.

[TS24.301 clause 5.5.3.2.5]

If the tracking area updating cannot be accepted by the network, the MME sends a TRACKING AREA UPDATE REJECT message to the UE including an appropriate EMM cause value.

Upon receiving the TRACKING AREA UPDATE REJECT message, the UE shall stop timer T3430, stop any transmission of user data, and take the following actions depending on the EMM cause value received.

...

#11 (PLMN not allowed);

The UE shall set the EPS update status to EU3 ROAMING NOT ALLOWED (and shall store it according to subclause 5.1.3.3) and shall delete any GUTI, last visited registered TAI, TAI list and KSI. The UE shall reset the tracking area updating attempt counter, delete the list of equivalent PLMNs and enter the state EMM-DEREGISTERED.PLMN-SEARCH.

The UE shall store the PLMN identity in the "forbidden PLMN list".

The UE shall perform a PLMN selection according to 3GPP TS 23.122 [6].

If A/Gb mode or Iu mode is supported by the UE, the UE shall handle the GMM parameters GMM state, GPRS update status, P-TMSI, P-TMSI signature, RAI, GPRS ciphering key sequence number and routing area updating attempt counter and the MM parameters update status, TMSI, LAI, ciphering key sequence number and the location update attempt counter as specified in 3GPP TS 24.008 [13] for the case when the normal routing area updating procedure is rejected with the GMM cause with the same value and no RR connection exists.

9.2.3.1.15.3 Test description

9.2.3.1.15.3.1 Pre-test conditions

System Simulator:

- cell G (belongs to TAI-7, visited PLMN) and is set to "Serving cell";
- cell H (belongs to TAI-8, visited PLMN) is set to "Non-suitable cell";
- cell I (belongs to TAI-9, visited PLMN) is set to "Non-suitable "off" cell";
- the cells are configured according to Table 6.3.2.2-1 and Table 6.3.2.2-3 in 36.508[18], except replacing f3 with f1;
- If (px_RATComb_Tested = EUTRA_UTRA OR px_RATComb_Tested = EUTRA_GERAN);
- if pc_UTRA AND px_RATComb_Tested = EUTRA_UTRA, cell 9 (UTRAN, belongs to RAI-1) is set to "Non-suitable "off" cell";
- if pc_GERAN AND px_RATComb_Tested = EUTRA_GERAN, cell 24 (GERAN, belongs to RAI-1) is set to "Non-suitable "off" cell".
- system information combination 10 as defined in TS 36.508[18] clause 4.4.3.1 is applied in E-UTRA cells;
- If (px_RATComb_Tested = EUTRA_Only):
 - neither cell 9 nor cell 24 is configured;
 - system information combination 1 as defined in TS 36.508[18] clause 4.4.3.1 is applied in E-UTRA cells;

UE:

- the UE is configured to initiate EPS attach.

Preamble:

- the UE is in state Registered, Idle Mode (state 2) on cell G according to TS 36.508 [18].

9.2.3.1.15.3.2 Test procedure sequence

Table 9.2.3.1.15.3.2-1: Main behaviour

St	Procedure	Message Sequence		TP	Verdict
		U - S	Message		
1	Set the cell type of cell G to the "Non-Suitable cell". Set the cell type of cell H to the "Serving cell". Note: cell G and cell H are in the same PLMN.	-	-	-	-
2	The UE transmits a TRACKING AREA UPDATE REQUEST on Cell H.	-->	TRACKING AREA UPDATE REQUEST	-	-
3	The SS transmits a TRACKING AREA UPDATE REJECT message with EMM cause = "PLMN not allowed".	<--	TRACKING AREA UPDATE REJECT	-	-
4	The SS releases the RRC connection.	-	-	-	-
5	Check: Does the UE transmit an ATTACH REQUEST message in the next 30 seconds on cell H?	-->	ATTACH REQUEST	1	F
6	If possible (see ICS) switch off is performed or the USIM is removed. Otherwise the power is removed.	-	-	-	-
7	Set the cell type of cell G to the "Serving cell". Set the cell type of cell H to the "Non-Suitable cell". Note: cell G and cell H are in the same PLMN.	-	-	-	-
8	The UE is brought back to operation or the USIM is inserted.	-	-	-	-
9	Check: Does the UE transmit an ATTACH REQUEST message in the next 90 seconds on cell G?	-->	ATTACH REQUEST	2	F
10	The user initiates an attach by MMI or by AT command.	-	-	-	-
11	Check: Does the UE transmit an ATTACH REQUEST message in the next 30 seconds on cell G?	-->	ATTACH REQUEST	2	F
12	Set the cell type of cell G to the "Non-Suitable cell". If px_RATComb_Tested = EUTRA_UTRA set the cell type of cell 9 to the "Serving cell" or if px_RATComb_Tested = EUTRA_GERAN set cell 24 to the "Serving cell". Note: Cell G and Cell 9 or 24 are in the same PLMN.	-	-	-	-
-	EXCEPTION: Steps 13a1 to 13a2 describe behaviour that depends on the UE capability; the "lower case letter" identifies a step sequence that take place if a capability is supported	-	-	-	-
13a 1	IF pc_UTRA AND px_RATComb_Tested = EUTRA_UTRA OR pc_GERAN AND px_RATComb_Tested = EUTRA_GERAN THEN the user initiates an attach by MMI or by AT command.	-	-	-	-
13a 2	Check: Does the UE transmit an ATTACH REQUEST message in the next 30 seconds on cell 9 or 24?	-->	ATTACH REQUEST	1	F
14	The following messages are sent and shall be received on cell I.	-	-	-	-
15	If px_RATComb_Tested = EUTRA_UTRA set the cell type of cell 9 to the "Non-Suitable cell" or if px_RATComb_Tested = EUTRA_GERAN set cell 24 to the "Non-Suitable cell". Set the cell type of cell I to the "Serving cell", Set the cell type of cell H to the "Non-Suitable "off" cell".	-	-	-	-

	Note: cell 9 or 24 and cell I are in different PLMNs.				
16	Check: Does the UE transmit ATTACH REQUEST message with a PDN CONNECTIVITY REQUEST message to request PDN connectivity to the default PDN?	-->	ATTACH REQUEST	3	P
17	The SS starts an authentication procedure	<--	AUTHENTICATION REQUEST	-	-
18	The UE responds properly to the authentication procedure	-->	AUTHENTICATION RESPONSE	-	-
19	The SS starts a NAS security mode command procedure to perform NAS integrity protection.	<--	SECURITY MODE COMMAND	-	-
20	The UE responds properly to the NAS security mode command procedure	-->	SECURITY MODE COMPLETE	-	-
-	EXCEPTION: Steps 20Aa1 to 20Aa2 describe behaviour that depends on UE configuration; the "lower case letter" identifies a step sequence that take place if the UE has ESM information which needs to be transferred.	-	-	-	-
20 Aa 1	IF the UE sets the ESM information transfer flag in the last PDN CONNECTIVITY REQUEST message THEN the SS transmits an ESM INFORMATION REQUEST message to initiate exchange of protocol configuration options and/or APN.	<--	ESM INFORMATION REQUEST	-	-
20 Aa 2	The UE transmits an ESM INFORMATION RESPONSE message to transfer protocol configuration options and/or APN.	-->	ESM INFORMATION RESPONSE	-	-
21	The SS sends ATTACH ACCEPT message with the ACTIVATE DEFAULT EPS BEARER CONTEXT REQUEST message.	<--	ATTACH ACCEPT	-	-
22	The UE transmits an ATTACH COMPLETE message including an ACTIVATE DEFAULT EPS BEARER CONTEXT ACCEPT message.	-->	ATTACH COMPLETE	-	-
23	The SS releases the RRC connection.	-	-	-	-
24	If possible (see ICS) switch off is performed or the USIM is removed. Otherwise the power is removed.	-	-	-	-
-	EXCEPTION: Step 25 describes behaviour that depends on the UE capability.				
25	If pc_SwitchOnOff or pc_USIM_Removal then the UE transmit a DETACH REQUEST.	-->	DETACH REQUEST	-	-
26	The following messages are sent and shall be received on cell G.	-	-	-	-
27	Set the cell type of cell G to the " Serving cell". Set the cell type of cell I to the " Non-Suitable cell". Note: Cell G belongs to the forbidden PLMN.	-	-	-	-
28	The UE is brought back to operation or the USIM is inserted.	-	-	-	-
29	The UE is switched to manual PLMN selection mode and is made to select the forbidden PLMN.	-	-	-	-
30	Check: Does the UE transmit ATTACH REQUEST message with a PDN CONNECTIVITY REQUEST message to request PDN connectivity to the default PDN?	-->	ATTACH REQUEST	4	P
31-42	The attach procedure is completed by executing steps 5 to 16 of the UE registration procedure in TS 36.508 sub clause 4.5.2.3.	-	-	-	-
-	At the end of this test procedure sequence, the UE is in end state E-UTRA connected (E2) according to TS 36.508.	-	-	-	-

9.2.3.1.15.3.3 Specific message contents

Table 9.2.3.1.15.3.3-1: Message TRACKING AREA UPDATE REQUEST (step 2, Table 9.2.3.1.15.3.2-1)

Derivation path: 36.508 table 4.7.2-27			
Information Element	Value/Remark	Comment	Condition
Old GUTI	GUTI-7		

Table 9.2.3.1.15.3.3-2: Message TRACKING AREA UPDATE REJECT (step 3, Table 9.2.3.1.15.3.2-1)

Derivation path: 36.508 table 4.7.2-24			
Information Element	Value/Remark	Comment	Condition
EMM cause	'00001011'B	#11 " PLMN not allowed "	

Table 9.2.3.1.15.3.3-3: Message ATTACH REQUEST (step 16, Table 9.2.3.1.15.3.2-1)

Derivation path: 36.508 table 4.7.2-4			
Information Element	Value/Remark	Comment	Condition
Old GUTI or IMSI	IMSI		
Old P-TMSI signature	Not present		
Last visited registered TAI	Not present		

Table 9.2.3.1.15.3.3-4: Message ATTACH ACCEPT (step 21, Table 9.2.3.1.15.3.2-1)

Derivation path: 36.508 table 4.7.2-1			
Information Element	Value/Remark	Comment	Condition
TAI list			
Number of elements	'00000'B		
Type of list	'00'B	"list of TACs belonging to one PLMN, with non-consecutive TAC values"	
MCC	'002'B	"TAI-9"	
MNC	'101'B	"TAI-9"	
TAC 1	'1'B	"TAI-9"	
GUTI	GUTI-9		

Table 9.2.3.1.15.3.3-5: Message ATTACH REQUEST (step 30, Table 9.2.3.1.15.3.2-1)

Derivation path: 36.508 table 4.7.2-4			
Information Element	Value/Remark	Comment	Condition
Old GUTI or IMSI	GUTI-9		
Last visited registered TAI	TAI-9		

9.2.3.1.15a Normal tracking area update / Rejected / PLMN not allowed / Single Frequency operation

9.2.3.1.15a.1 Test Purpose (TP)

Same test purpose as in clause 9.2.3.1.15.1

9.2.3.1.15a.2 Conformance requirements

Same conformance requirements as in clause 9.2.3.1.15.2

9.2.3.1.15a.3 Test description

9.2.3.1.15a.3.1 Pre-test conditions

System Simulator:

- Three intra-frequency E-UTRA cells Cell A, Cell B, and Cell C;
- cell A (belongs to TAI-7, visited PLMN, MCC = MCC in USIM MNC=02) and is set to "Serving cell";
- cell B (belongs to TAI-8, visited PLMN, MCC = MCC in USIM MNC=02) is set to "Non-suitable cell";
- cell C (belongs to TAI-9, visited PLMN, MCC=002 MNC=101) is set to "Non-suitable "off" cell";
- If (px_RATComb_Tested = EUTRA_UTRA OR px_RATComb_Tested = EUTRA_GERAN);
- if pc_UTRA AND px_RATComb_Tested = EUTRA_UTRA, cell 5 (UTRAN, belongs to RAI-1) is set to "Non-suitable "off" cell";
- if pc_GERAN AND px_RATComb_Tested = EUTRA_GERAN, cell 24 (GERAN, belongs to RAI-1) is set to "Non-suitable "off" cell".
- system information combination 10 as defined in TS 36.508[18] clause 4.4.3.1 is applied in E-UTRA cells;
- If (px_RATComb_Tested = EUTRA_Only):
- neither cell 5 nor cell 24 is configured;
- system information combination 1 as defined in TS 36.508[18] clause 4.4.3.1 is applied in E-UTRA cells;

UE:

- the UE is configured to initiate EPS attach.

Preamble:

- the UE is in state Registered, Idle Mode (state 2) on cell A according to TS 36.508 [18].

9.2.3.1.15a.3.2 Test procedure sequence

Table 9.2.3.1.15a.3.2-1: Main behaviour

St	Procedure	Message Sequence		TP	Verdict
		U - S	Message		
1	Set the cell type of cell A to the "Non-Suitable cell". Set the cell type of cell B to the "Serving cell". Note: cell A and cell B are in the same PLMN.	-	-	-	-
2	The UE transmits a TRACKING AREA UPDATE REQUEST on Cell B.	-->	TRACKING AREA UPDATE REQUEST	-	-
3	The SS transmits a TRACKING AREA UPDATE REJECT message with EMM cause = "PLMN not allowed".	<--	TRACKING AREA UPDATE REJECT	-	-
4	The SS releases the RRC connection.	-	-	-	-
5	Check: Does the UE transmit an ATTACH REQUEST message in the next 90 seconds on cell B?	-->	ATTACH REQUEST	1	F
6	If possible (see ICS) switch off is performed or the USIM is removed. Otherwise the power is removed.	-	-	-	-
7	Set the cell type of cell A to the "Serving cell". Set the cell type of cell B to the "Non-Suitable cell". Note: cell A and cell B are in the same PLMN.	-	-	-	-
8	The UE is brought back to operation or the USIM is inserted.	-	-	-	-
9	Check: Does the UE transmit an ATTACH REQUEST message in the next 90 seconds on cell A?	-->	ATTACH REQUEST	2	F
10	The user initiates an attach by MMI or by AT command.	-	-	-	-
11	Check: Does the UE transmit an ATTACH REQUEST message in the next 90 seconds on cell A?	-->	ATTACH REQUEST	2	F
12	Set the cell type of cell A to the "Non-Suitable cell". If px_RATComb_Tested = EUTRA_UTRA set the cell type of cell 5 to the "Serving cell" or if px_RATComb_Tested = EUTRA_GERAN set cell 24 to the "Serving cell". Note: Cell A and Cell 5 or 24 are in the same PLMN.	-	-	-	-
-	EXCEPTION: Steps 13a1 to 13a2 describe behaviour that depends on the UE capability; the "lower case letter" identifies a step sequence that take place if a capability is supported	-	-	-	-
13a 1	IF pc_UTRA AND px_RATComb_Tested = EUTRA_UTRA OR pc_GERAN AND px_RATComb_Tested = EUTRA_GERAN THEN the user initiates an attach by MMI or by AT command.	-	-	-	-
13a 2	Check: Does the UE transmit an ATTACH REQUEST message in the next 30 seconds on cell 5 or 24?	-->	ATTACH REQUEST	1	F
14	The following messages are sent and shall be received on cell C.	-	-	-	-
15	If px_RATComb_Tested = EUTRA_UTRA set the cell type of cell 5 to the "Non-Suitable cell" or if px_RATComb_Tested = EUTRA_GERAN set cell 24 to the "Non-Suitable cell". Set the cell type of cell C to the "Serving cell", Set the cell type of cell B to the "Non-Suitable "off" cell".	-	-	-	-

	Note: cell 5 or 24 and cell C are in different PLMNs.				
16	Check: Does the UE transmit ATTACH REQUEST message with a PDN CONNECTIVITY REQUEST message to request PDN connectivity to the default PDN?	-->	ATTACH REQUEST	3	P
17	The SS starts an authentication procedure	<--	AUTHENTICATION REQUEST	-	-
18	The UE responds properly to the authentication procedure	-->	AUTHENTICATION RESPONSE	-	-
19	The SS starts a NAS security mode command procedure to perform NAS integrity protection.	<--	SECURITY MODE COMMAND	-	-
20	The UE responds properly to the NAS security mode command procedure	-->	SECURITY MODE COMPLETE	-	-
-	EXCEPTION: Steps 20Aa1 to 20Aa2 describe behaviour that depends on UE configuration; the "lower case letter" identifies a step sequence that take place if the UE has ESM information which needs to be transferred.	-	-	-	-
20 Aa 1	IF the UE sets the ESM information transfer flag in the last PDN CONNECTIVITY REQUEST message THEN the SS transmits an ESM INFORMATION REQUEST message to initiate exchange of protocol configuration options and/or APN.	<--	ESM INFORMATION REQUEST	-	-
20 Aa 2	The UE transmits an ESM INFORMATION RESPONSE message to transfer protocol configuration options and/or APN.	-->	ESM INFORMATION RESPONSE	-	-
21	The SS sends ATTACH ACCEPT message with the ACTIVATE DEFAULT EPS BEARER CONTEXT REQUEST message.	<--	ATTACH ACCEPT	-	-
22	The UE transmits an ATTACH COMPLETE message including an ACTIVATE DEFAULT EPS BEARER CONTEXT ACCEPT message.	-->	ATTACH COMPLETE	-	-
23	The SS releases the RRC connection.	-	-	-	-
24	If possible (see ICS) switch off is performed or the USIM is removed. Otherwise the power is removed.	-	-	-	-
-	EXCEPTION: Step 25 describes behaviour that depends on the UE capability.				
25	If pc_SwitchOnOff or pc_USIM_Removal then the UE transmit a DETACH REQUEST.	-->	DETACH REQUEST	-	-
26	The following messages are sent and shall be received on cell A.	-	-	-	-
27	Set the cell type of cell A to the " Serving cell". Set the cell type of cell C to the " Non-Suitable cell". Note: Cell A belongs to the forbidden PLMN.	-	-	-	-
28	The UE is brought back to operation or the USIM is inserted.	-	-	-	-
29	The UE is switched to manual PLMN selection mode and is made to select the forbidden PLMN.	-	-	-	-
30	Check: Does the UE transmit ATTACH REQUEST message with a PDN CONNECTIVITY REQUEST message to request PDN connectivity to the default PDN?	-->	ATTACH REQUEST	4	P
31-42	The attach procedure is completed by executing steps 5 to 16 of the UE registration procedure in TS 36.508 sub clause 4.5.2.3.	-	-	-	-
-	At the end of this test procedure sequence, the UE is in end state E-UTRA connected (E2) according to TS 36.508.	-	-	-	-

9.2.3.1.15a.3.3 Specific message contents

Same specific message contents as in clause 9.2.3.1.15.3.3

9.2.3.1.16 Normal tracking area update / Rejected / Tracking area not allowed

9.2.3.1.16.1 Test Purpose (TP)

(1)

```
with { UE has sent a TRACKING AREA UPDATE REQUEST message}
ensure that {
  when { UE receives a TRACKING AREA UPDATE REJECT message with the reject cause set to 'Tracking
area not allowed ' ' }
  then { shall delete any GUTI, last visited registered TAI, TAI list and KSI. The UE shall reset
the tracking area updating attempt counter and shall enter the state EMM-DEREGISTERED.LIMITED-
SERVICE and store the current TAI in the list of "forbidden tracking areas for regional provision of
service" }
```

(2)

```
with { UE is in EMM-DEREGISTERED.LIMITED-SERVICE state and has a TAI in the list of "forbidden
tracking areas for regional provision of service"}
ensure that {
  when { UE is in the serving cell which the UE is rejected }
  then { UE does not attempt an attach procedure on any other cell}
}
```

(3)

```
with { UE is in EMM-DEREGISTERED.LIMITED-SERVICE state and the current TAI in the list of "forbidden
tracking areas for regional provision of service"}
ensure that {
  when { UE enters a new cell in the same TAI it was rejected }
  then { UE does not initiate an attach procedure}
}
```

(4)

```
with { UE is in EMM-DEREGISTERED.LIMITED-SERVICE state and the current TAI in the list of "forbidden
tracking areas for regional provision of service"}
ensure that {
  when { UE enters a new cell with different TAI without in the list of "forbidden tracking areas
for regional provision of service"}
  then { UE initiates attach procedure with IMSI }
}
```

(5)

```
with { UE is switched off }
ensure that {
  when { UE is powered on and enters the cell with "forbidden tracking areas for regional provision
of service" before the UE was switched off }
  then { UE initiates attach procedure on the cell }
```

9.2.3.1.16.2 Conformance requirements

References: The conformance requirements covered in the present TC are specified in: 3GPP TS 24.301 clauses 5.5.3.2.5.

[TS24.301 clause5.5.3.2.5]

If the tracking area updating cannot be accepted by the network, the MME sends a TRACKING AREA UPDATE REJECT message to the UE including an appropriate EMM cause value.

Upon receiving the TRACKING AREA UPDATE REJECT message, the UE shall stop timer T3430, stop any transmission of user data, and take the following actions depending on the EMM cause value received.

...

#12 (Tracking area not allowed);

The UE shall set the EPS update status to EU3 ROAMING NOT ALLOWED (and shall store it according to subclause 5.1.3.3) and shall delete any GUTI, last visited registered TAI, TAI list and KSI. The UE shall reset the tracking area updating attempt counter and shall enter the state EMM-DEREGISTERED.LIMITED-SERVICE.

The UE shall store the current TAI in the list of "forbidden tracking areas for regional provision of service".

If A/Gb mode or Iu mode is supported by the UE, the UE shall handle the GMM parameters GMM state, GPRS update status, P-TMSI, P-TMSI signature, RAI, GPRS ciphering key sequence number and routing area updating attempt counter as specified in 3GPP TS 24.008 [13] for the case when the normal routing area updating procedure is rejected with the GMM cause with the same value.

9.2.3.1.16.3 Test description

9.2.3.1.16.3.1 Pre-test conditions

System Simulator:

- cell A (belong to TAI-1, home PLMN) are set to "Non-suitable cell";
- cell B (belongs to TAI-2, home PLMN) is set to "Serving cell";
- cell C (belongs to TAI-3, visited PLMN) is set to "Non-suitable cell";
- cell M (belongs to TAI-1, home PLMN) are set to "Non-suitable "off" cell"

UE:

- The UE is configured to initiate EPS attach.

Preamble:

- the UE is in state Registered, Idle Mode (state 2) on cell B according to TS 36.508 [18].

9.2.3.1.16.3.2 Test procedure sequence

Table 9.2.3.1.16.3.2-1: Main behaviour

St	Procedure	Message Sequence		TP	Verdict
		U - S	Message		
1	Set the cell type of cell A to "Serving cell". Set the cell type of cell B to "Non-Suitable cell". Set the cell type of cell C to "Suitable neighbour intra-frequency cell".	-	-	-	-
2	The UE transmits a TRACKING AREA UPDATE REQUEST on Cell A.	-->	TRACKING AREA UPDATE REQUEST	-	-
3	The SS transmits a TRACKING AREA UPDATE REJECT message with EMM cause = "Tracking area not allowed" as specified.	<--	TRACKING AREA UPDATE REJECT	-	-
4	The SS releases the RRC connection.	-	-	-	-
5	Check: Does the UE transmit an ATTACH REQUEST message in the next 90 seconds on cell C?	-->	ATTACH REQUEST	2	F
5A	Set the cell type of cell B to the "Non-Suitable "off" cell". Set the cell type of cell M to the " Non-Suitable cell ". Set the cell type of cell C to the " Non-Suitable cell ".				
6	The user initiates an attach by MMI or by AT command.	-	-	-	-
7	Check: Does the UE transmit an ATTACH REQUEST message in the next 90 seconds on cell A?	-->	ATTACH REQUEST	1	F
8	Set the cell type of cell A to the " Non-Suitable cell ". Set the cell type of cell M to the "Serving cell".	-	-	-	-
9	Check: Does the UE transmit an ATTACH REQUEST message in the next 90 seconds on cell M?	-->	ATTACH REQUEST	3	F
10	Set the cell type of cell C to the "Serving cell". Set the cell type of cell M to the "Non-Suitable cell ".	-	-	-	-
11	Check: Does the UE transmit an ATTACH REQUEST on cell C including a PDN CONNECTIVITY REQUEST message including a PDN CONNECTIVITY REQUEST message?	-->	ATTACH REQUEST	4	P
12	The SS starts an authentication procedure	<--	AUTHENTICATION REQUEST	-	-
13	The UE responds properly to the authentication procedure	-->	AUTHENTICATION RESPONSE	-	-
14	The SS starts a NAS security mode command procedure to perform NAS integrity protection.	<--	SECURITY MODE COMMAND	-	-
15	The UE responds properly to the NAS security mode command procedure	-->	SECURITY MODE COMPLETE	-	-
-	EXCEPTION: Steps 15Aa1 to 15Aa2 describe behaviour that depends on UE configuration; the "lower case letter" identifies a step sequence that take place if the UE has ESM information which needs to be transferred.	-	-	-	-
15 Aa 1	IF the UE sets the ESM information transfer flag in the last PDN CONNECTIVITY REQUEST message THEN the SS transmits an ESM INFORMATION REQUEST message to initiate exchange of protocol configuration options and/or APN.	<--	ESM INFORMATION REQUEST	-	-
15 Aa 2	The UE transmits an ESM INFORMATION RESPONSE message to transfer protocol configuration options and/or APN.	-->	ESM INFORMATION RESPONSE	-	-

16	The SS sends ATTACH ACCEPT message with the ACTIVATE DEFAULT EPS BEARER CONTEXT REQUEST message.	<--	ATTACH ACCEPT	-	-
17	The UE transmits an ATTACH COMPLETE message including an ACTIVATE DEFAULT EPS BEARER CONTEXT ACCEPT message.	-->	ATTACH COMPLETE	-	-
18	The SS releases the RRC connection.	-	-	-	-
19	If possible (see ICS) switch off is performed or the USIM is removed. Otherwise the power is removed.	-	-	-	-
-	EXCEPTION: Step 20 describes behaviour that depends on the UE capability.				
20	If pc_SwitchOnOff or pc_USIM_Removal then the UE transmit a DETACH REQUEST.	-->	DETACH REQUEST	-	-
21	The following messages are sent and shall be received on cell A.	-	-	-	-
22	Set the cell type of cell A to the " Serving cell". Set the cell type of cell C to the " Non-Suitable cell".	-	-	-	-
23	The UE is brought back to operation or the USIM is inserted.	-	-	-	-
24	The UE transmits ATTACH REQUEST message with a PDN CONNECTIVITY REQUEST message to request PDN connectivity to the default PDN.	-->	ATTACH REQUEST	5	P
25-36	The attach procedure is completed executing steps 5 to 16 of the UE registration procedure in TS 36.508 clause 4.5.2.3	-	-	-	-
-	At the end of this test procedure sequence, the UE is in end state E-UTRA connected (E2) according to TS 36.508.	-	-	-	-

9.2.3.1.16.3.3 Specific message contents

Table 9.2.3.1.16.3.3-1: Message TRACKING AREA UPDATE REQUEST (step 2, Table 9.2.3.1.16.3.2-1)

Derivation path: 36.508 table 4.7.2-27			
Information Element	Value/Remark	Comment	Condition
Old GUTI	GUTI-7		

Table 9.2.3.1.16.3.3-2: Message TRACKING AREA UPDATE REJECT (step 3, Table 9.2.3.1.16.3.2-1)

Derivation path: 36.508 table 4.7.2-24			
Information Element	Value/Remark	Comment	Condition
EMM cause	'00001100'B	#12 "Tracking area not allowed"	

Table 9.2.3.1.16.3.3-3: Message ATTACH REQUEST (step 11, Table 9.2.3.1.16.3.2-1)

Derivation path: 36.508 table 4.7.2-4			
Information Element	Value/Remark	Comment	Condition
Old GUTI or IMSI	IMSI		
Last visited registered TAI	Not present		

Table 9.2.3.1.16.3.3-4: Message ATTACH ACCEPT (step 16, Table 9.2.3.1.16.3.2-1)

Derivation path: 36.508 table 4.7.2-1			
Information Element	Value/Remark	Comment	Condition
TAI list			
Number of elements	'00000'B		
Type of list	'00'B	"list of TACs belonging to one PLMN, with non-consecutive TAC values"	
MCC MNC TAC 1	PLMN= MCC/02 TAC 1=1	"MCC is set to the same MCC stored in EF _{IMSI} " "TAI-7"	
GUTI	GUTI-7		

Table 9.2.3.1.16.3.3-5: Message ATTACH REQUEST (step 24, Table 9.2.3.1.16.3.2-1)

Derivation path: 36.508 table 4.7.2-4			
Information Element	Value/Remark	Comment	Condition
Old GUTI or IMSI	GUTI-7		
Last visited registered TAI	TAI-7		

9.2.3.1.17 Normal tracking area update / Rejected / Roaming not allowed in this tracking area

9.2.3.1.17.1 Test Purpose (TP)

(1)

```
with { the UE has sent TRACKING AREA UPDATE REQUEST message }
ensure that {
  when { the UE receives TRACKING AREA UPDATE REJECT message with the reject cause set to "roaming not allowed in this tracking area" }
  then { the UE sets the EPS update status to EUI3 ROAMING NOT ALLOWED and the UE deletes the last visited registered TAI and the UE enters the state EMM-REGISTERED.PLMN-SEARCH and the UE stores the current TAI in the list of "forbidden tracking areas for roaming" }
}
```

(2)

```
with { the UE is in EMM-REGISTERED.PLMN-SEARCH state and the current TAI in the list of "forbidden tracking areas for roaming" }
ensure that {
  when { the serving cell belongs to TAI where UE was rejected }
  then { the UE does not attempt to send TRACKING AREA UPDATE REQUEST message }
}
```

(3)

```
with { the UE is in EMM-REGISTERED.PLMN-SEARCH state and the TAI of the current cell belongs to the list of "forbidden tracking areas for roaming" }
ensure that {
  when { the UE enters a cell belonging to same PLMN and TAI not in the list of "forbidden tracking areas for roaming" }
  then { the UE sends TRACKING AREA UPDATE REQUEST message }
}
```

(4)

```
with { the UE is in EMM-REGISTERED.PLMN-SEARCH state and the TAI of the current cell belongs to the list of "forbidden tracking areas for roaming" }
ensure that {
  when { the UE enters a cell belonging to another PLMN }
  then { the UE sends TRACKING AREA UPDATE REQUEST message }
}
```

(5)

```

with { the UE, which A/Gb mode or Iu mode is supported by the UE, in EMM-DEREGISTERED.PLMN-SEARCH
state and the list of "forbidden tracking areas for roaming" contains more than one TAI }
ensure that {
  when { the UE move to UTRAN or GERAN cell }
  then { the UE sends ROUTING AREA UPDATE REQUEST message }

```

9.2.3.1.17.2 Conformance requirements

References: The conformance requirements covered in the present TC are specified in: TS 24.301, clause 5.5.3.2.5.

[TS 24.301, clause 5.5.3.2.5]

If the tracking area updating cannot be accepted by the network, the MME sends a TRACKING AREA UPDATE REJECT message to the UE including an appropriate EMM cause value.

Upon receiving the TRACKING AREA UPDATE REJECT message, the UE shall stop timer T3430, stop any transmission of user data, and take the following actions depending on the EMM cause value received.

...

#13 (Roaming not allowed in this tracking area);

The UE shall set the EPS update status to EU3 ROAMING NOT ALLOWED (and shall store it according to subclause 5.1.3.3) and shall delete the list of equivalent PLMNs. The UE shall reset the tracking area updating attempt counter and shall change to state EMM-REGISTERED.PLMN-SEARCH.

The UE shall store the current TAI in the list of "forbidden tracking areas for roaming" and shall remove the current TAI from the stored TAI list if present.

The UE shall perform a PLMN selection according to 3GPP TS 23.122 [6].

If A/Gb mode or Iu mode is supported by the UE, the UE shall handle the GMM parameters GMM state, GPRS update status and routing area updating attempt counter as specified in 3GPP TS 24.008 [13] for the case when the normal routing area updating procedure is rejected with the GMM cause with the same value.

...

9.2.3.1.17.3 Test description

9.2.3.1.17.3.1 Pre-test conditions

System Simulator:

- cell K(belongs to TAI-9, visited PLMN) is set to "Serving cell";
- cell L(belongs to TAI-11, same visited PLMN) is set to "Non-suitable cell";
- If (px_SinglePLMN_Test = Multi PLMN) cell J (belongs to TAI-10, another visited PLMN) is set to "Non-suitable "off" cell";
- If (px_RATComb_Test = EUTRA_UTRA OR px_RATComb_Test = EUTRA_GERAN) ;
- if pc_UTRA AND px_RATComb_Test = EUTRA_UTRA, cell 9 (belongs to TAI-8, visited PLMN) is set to "Non-suitable "off" cell";
- if pc_GERAN AND px_RATComb_Test = EUTRA_GERAN, cell 24 (belongs to TAI-8, visited PLMN) is set to "Non-suitable "off" cell";
- system information indicate that NMO 1 is used;
 - system information combination 10 as defined in TS 36.508[18] clause 4.4.3.1 is applied in E-UTRA cells;
- If (px_RATComb_Test = EUTRA_Only):
 - neither cell 9 nor cell 24 is configured;

- system information combination 1 as defined in TS 36.508[18] clause 4.4.3.1 is applied in E-UTRA cells;

UE:

- the UE is configured to initiate EPS attach.

Preamble:

- the UE is in state Registered, Idle Mode (state 2) on cell K according to TS 36.508 [18].

9.2.3.1.17.3.2 Test procedure sequence

Table 9.2.3.1.17.3.2-1: Main behaviour

St	Procedure	Message Sequence		TP	Verdict
		U - S	Message		
1	Set the cell type of cell K to the " Suitable neighbour intra-frequency cell ". Set the cell type of cell L to the "Serving cell".	-	-	-	-
2	The UE transmits TRACKING AREA UPDATE REQUEST on Cell L.	-->	TRACKING AREA UPDATE REQUEST	-	-
3	The SS transmits a TRACKING AREA UPDATE REJECT message with EMM cause = "Roaming not allowed in this tracking area" as specified.	<--	TRACKING AREA UPDATE REJECT	-	-
4	The SS releases the RRC connection.				
5	Set the cell type of cell K to the "Serving cell". Set the cell type of cell L to the "Suitable neighbour intra-frequency cell".	-	-	-	-
6	Void	-	-	-	-
7	Check: Does the UE transmit TRACKING AREA UPDATE REQUEST message on cell K?	-->	TRACKING AREA UPDATE REQUEST	1, 3	P
8	The SS transmits TRACKING AREA UPDATE REJECT message with EMM cause = "Roaming not allowed in this tracking area" as specified.	<--	TRACKING AREA UPDATE REJECT	-	-
9	The SS releases the RRC connection.				
10	Set the cell type of cell K to the "Non-Suitable cell". If present, set the cell type of cell 9 or 24 to the "Serving cell". Note: Cell K and cell 9 or 24 are in the same PLMN.	-	-	-	-
	EXCEPTION: Steps 11a1 to 11a3 describe behaviour that depends on the UE capability; the "lower case letter" identifies a step sequence that take place if a capability is supported				
11a 1	Check: Does the UE transmit ROUTING AREA UPDATE REQUEST message on cell 9 or 24?	-->	ROUTING AREA UPDATE REQUEST	5	P
11a 2	The SS transmits a ROUTING AREA UPDATE REJECT message with cause = " Roaming not allowed in this tracking area " as specified.	<--	ROUTING AREA UPDATE REJECT	-	-
11a 3	The SS releases the RRC connection.	-	-	-	-
-	EXCEPTION: Steps 12a1 to 12a4 describe behaviour that depends on the network capability / preference; the "lower case letter" identifies a step sequence that takes place if the network is capable or prefers.	-	-	-	-
12 a1	If (px_SinglePLMN_Tested = Multi PLMN) If present, set the cell type of cell 9 or 24 to the " Non-Suitable cell". Set the cell type of cell L to the "Non-Suitable "off" cell". Set the cell type of cell J to the "Serving cell". Note: cell 9 or 24 and cell J are in different PLMNs.	-	-	-	-
12a 2	Check: Does the UE transmit TRACKING AREA REQUEST message on cell J?	-->	TRACKING AREA UPDATE REQUEST	1, 4	P
12a 3	The SS sends TRACKING AREA ACCEPT message.	<--	TRACKING AREA UPDATE ACCEPT	-	-
12a 4	The UE transmits TRACKING AREA COMPLETE message.	-->	TRACKING AREA UPDATE COMPLETE	-	-

-	If (px_SinglePLMN_Test = Multi PLMN): At the end of this test procedure sequence, the UE is in end state E-UTRA connected (E2_T3440) according to TS 36.508. Else: At the end of this test procedure sequence, the UE is in end state E-UTRA deregistered (E4) according to TS 36.508.	-	-	-	-
---	--	---	---	---	---

9.2.3.1.17.3.3 Specific message contents

Table 9.2.3.1.17.3.3-1: Message TRACKING AREA UPDATE REQUEST (step 2, 7 and 12a2, Table 9.2.3.1.17.3.2-1)

Derivation path: 36.508 table 4.7.2-27			
Information Element	Value/Remark	Comment	Condition
Old GUTI	GUTI-9		

Table 9.2.3.1.17.3.3-2: TRACKING AREA UPDATE REJECT (step 3 and 8, Table 9.2.3.1.17.3.2-1)

Derivation Path: 36.508, Table 4.7.2-26			
Information Element	Value/remark	Comment	Condition
EMM cause	'0000 1101'B	Roaming not allowed in this tracking area	

9.2.3.1.18 Normal tracking area update / Rejected / EPS services not allowed in this PLMN

9.2.3.1.18.1 Test Purpose (TP)

(1)

```
with { UE has sent a TRACKING AREA UPDATE REQUEST message }
ensure that {
  when { UE receives a TRACKING AREA UPDATE REJECT message with the reject cause set to 'EPS
services not allowed in this PLMN' }
  then { UE deletes the GUTI, the last visited registered TAI and KSI and UE deletes the list of
equivalent PLMNs and UE enters state EMM-DEREGISTERED.PLMN-SEARCH and UE stores the PLMN in the
"forbidden PLMNs for GPRS service" }
```

(2)

```
with { UE in E-UTRA EMM-DEREGISTERED.PLMN-SEARCH state and a PLMN is stored in the "forbidden PLMNs
for GPRS service" }
ensure that {
  when { UE enters a cell which is in the "forbidden PLMNs for GPRS service" }
  then { UE doesn't perform an attach procedure }
```

(3)

```
with { UE in EMM-DEREGISTERED.PLMN-SEARCH state and a PLMN is stored in the "forbidden PLMNs for
GPRS service" }
ensure that {
  when { UE enters a cell which is not in the "forbidden PLMNs for GPRS service" }
  then { UE initiates an attach procedure }
```

(4)

```
with { UE is switched off and a PLMN is stored in the 'forbidden PLMNs for GPRS service' }
ensure that {
  when { UE is power ON in a cell with forbidden PLMNs for GPRS service }
  then { UE initiates an attach procedure }
```

9.2.3.1.18.2 Conformance requirements

References: The conformance requirements covered in the present TC are specified in: TS 24.301, clause 5.5.3.2.5.

[TS 24.301, clause 5.5.3.2.5]

If the tracking area updating cannot be accepted by the network, the MME sends a TRACKING AREA UPDATE REJECT message to the UE including an appropriate EMM cause value.

Upon receiving the TRACKING AREA UPDATE REJECT message, the UE shall stop timer T3430, stop any transmission of user data, and take the following actions depending on the EMM cause value received.

...

#14 (EPS services not allowed in this PLMN);

The UE shall set the EPS update status to EU3 ROAMING NOT ALLOWED (and shall store it according to subclause 5.1.3.3). Furthermore the UE shall delete any GUTI, last visited registered TAI, TAI list and KSI. The UE shall reset the tracking area updating attempt counter and shall enter the state EMM-DEREGISTERED.PLMN-SEARCH.

The UE shall store the PLMN identity in the "forbidden PLMNs for GPRS service" list.

The UE shall perform a PLMN selection according to 3GPP TS 23.122 [6].

If A/Gb mode or Iu mode is supported by the UE, the UE shall handle the GMM parameters GMM state, GPRS update status, P-TMSI, P-TMSI signature, RAI, GPRS ciphering key sequence number and routing area updating attempt counter as specified in 3GPP TS 24.008 [13] for the case when the normal routing area updating procedure is rejected with the GMM cause with the same value.

...

9.2.3.1.18.3 Test description

9.2.3.1.18.3.1 Pre-test conditions

System Simulator:

- cell G belongs to TAI-7(visited PLMN) and is set to "Serving cell";
- cell H belongs to TAI-8(visited PLMN, another TAC) and is set to "Non-suitable cell";
- cell I belongs to TAI-9(visited PLMN, another PLMN) and is set to "Non-suitable "off" cell";
- the cells are configured according to Table 6.3.2.2-1 and Table 6.3.2.2-3 in 36.508[18], except replacing f3 with f1;
- If (px_RATComb_Tested = EUTRA_UTRA OR px_RATComb_Tested = EUTRA_GERAN);
- if pc_UTRA AND px_RATComb_Tested = EUTRA_UTRA, cell 9 (belongs to TAI-8, visited PLMN) is set to "Non-suitable "off" cell";
- if pc_GERAN AND px_RATComb_Tested = EUTRA_GERAN, cell 24 (belongs to TAI-8, visited PLMN) is set to "Non-suitable "off" cell";
- system information combination 10 as defined in TS 36.508[18] clause 4.4.3.1 is applied in E-UTRA cells;
 - system information indicate that NMO 1 is used;
- If (px_RATComb_Tested = EUTRA_Only):
 - neither cell 9 nor cell 24 is configured;
 - system information combination 1 as defined in TS 36.508[18] clause 4.4.3.1 is applied in E-UTRA cells;

UE:

- the UE is configured to initiate EPS attach.

Preamble:

- the UE is in state Registered, Idle Mode (state 2) on cell G according to TS 36.508 [18].

9.2.3.1.18.3.2 Test procedure sequence

Table 9.2.3.1.18.3.2-1: Main behaviour

St	Procedure	Message Sequence		TP	Verdict
		U - S	Message		
1	Set the cell type of cell G to the "Non-Suitable cell". Set the cell type of cell H to the "Serving cell".	-	-	-	-
2	The UE transmits a TRACKING AREA UPDATE REQUEST on Cell H.	-->	TRACKING AREA UPDATE REQUEST	-	-
3	The SS transmits a TRACKING AREA UPDATE REJECT message with EMM cause = "EPS services not allowed in this PLMN" as specified.	<--	TRACKING AREA UPDATE REJECT	-	-
4	The SS releases the RRC connection.	-	-	-	-
5	Check: Does the UE transmit an ATTACH REQUEST message in the next 30 seconds on cell H?	-->	ATTACH REQUEST	1	F
6	Set the cell type of cell G to the "Serving cell". Set the cell type of cell H to the "Non-Suitable cell". Note: cell G and cell H are in the same PLMN.	-	-	-	-
7	The user initiates an attach by MMI or by AT command.	-	-	-	-
8	Check: Does the UE transmit an ATTACH REQUEST message in the next 30 seconds on cell G?	-->	ATTACH REQUEST	2	F
9	Set the cell type of cell G to the "Non-Suitable cell". Set the cell type of cell H to the "Non-Suitable "off" cell". If px_RATComb_Tested = EUTRA_UTRA set the cell type of cell 9 to the "Serving cell" or if px_RATComb_Tested = EUTRA_GERAN set cell 24 to the "Serving cell". Note: Cell G and Cell 9 or 24 are in the same PLMN.	-	-	-	-
-	EXCEPTION: Steps 10a1 to 10a2 describe behaviour that depends on the UE capability; the "lower case letter" identifies a step sequence that take place if a capability is supported	-	-	-	-
10a 1	IF pc_UTRA AND px_RATComb_Tested = EUTRA_UTRA OR pc_GERAN AND px_RATComb_Tested = EUTRA_GERAN THEN the user initiates an attach by MMI or by AT command.	-	-	-	-
-	EXCEPTION: Depending on UE capabilities the behaviour in table 9.2.3.1.18.3.2-2 occurs in parallel with step 10a2.	-	-	-	-
10a 2	Check: Does the UE transmit an ATTACH REQUEST message in the next 30 seconds on cell 9 or 24?	-->	ATTACH REQUEST	1	F
-	The following messages are sent and shall be received on cell I.	-	-	-	-
11	If px_RATComb_Tested = EUTRA_UTRA set the cell type of cell 9 to the "Non-Suitable cell" or if px_RATComb_Tested = EUTRA_GERAN set cell 24 to the "Non-Suitable cell". Set the cell type of cell I to the "Serving cell". Note: cell 9 or 24 and cell I are in different PLMNs.	-	-	-	-
12	Check: Does the UE send ATTACH REQUEST message with a PDN CONNECTIVITY REQUEST message to	-->	ATTACH REQUEST	3	P

	request PDN connectivity to the default PDN?				
13	The SS starts an authentication procedure	<--	AUTHENTICATION REQUEST	-	-
14	The UE responds properly to the authentication procedure	-->	AUTHENTICATION RESPONSE	-	-
15	The SS starts a NAS security mode command procedure to perform NAS integrity protection.	<--	SECURITY MODE COMMAND	-	-
16	The UE responds properly to the NAS security mode command procedure	-->	SECURITY MODE COMPLETE	-	-
-	EXCEPTION: Steps 17a1 to 17a2 describe behaviour that depends on UE configuration; the "lower case letter" identifies a step sequence that take place if the UE has ESM information which needs to be transferred.	-	-	-	-
17a 1	IF the UE sets the ESM information transfer flag in the last PDN CONNECTIVITY REQUEST message THEN the SS transmits an ESM INFORMATION REQUEST message to initiate exchange of protocol configuration options and/or APN.	<--	ESM INFORMATION REQUEST	-	-
17a 2	The UE transmits an ESM INFORMATION RESPONSE message to transfer protocol configuration options and/or APN.	-->	ESM INFORMATION RESPONSE	-	-
18	The SS sends ATTACH ACCEPT message with the ACTIVATE DEFAULT EPS BEARER CONTEXT REQUEST message.	<--	ATTACH ACCEPT	-	-
-	EXCEPTION: In parallel to the event described in step 19 below the generic procedure for IP address allocation in the U-plane specified in TS 36.508 subclause 4.5A.1 takes place performing IP address allocation in the U-plane if requested by the UE.	-	-	-	-
19	The UE transmits an ATTACH COMPLETE message.	-->	ATTACH COMPLETE	-	-
20	The SS releases the RRC connection.	-	-	-	-
21	If possible (see ICS) switch off is performed or the USIM is removed. Otherwise the power is removed.	-	-	-	-
-	EXCEPTION: Step 22 describes behaviour that depends on the UE capability.	-	-	-	-
22	If pc_SwitchOnOff or pc_USIM_Removal then the UE transmit a DETACH REQUEST.	-->	DETACH REQUEST	-	-
-	The following messages are sent and shall be received on cell G.	-	-	-	-
23	Set the cell type of cell G to the " Serving cell". Set the cell type of cell I to the " Non-Suitable cell". Note: Cell G belongs to the forbidden PLMNs for GPRS service.	-	-	-	-
24	The UE is brought back to operation or the USIM is inserted.	-	-	-	-
25	Check: Does the UE send ATTACH REQUEST message with a PDN CONNECTIVITY REQUEST message to request PDN connectivity to the default PDN?	-->	ATTACH REQUEST	4	P
26- 37	The attach procedure is completed by executing steps 5 to 16 of the UE registration procedure in TS 36.508 sub clause 4.5.2.3.	-	-	-	-
-	At the end of this test procedure sequence, the UE is in end state E-UTRA connected (E2) according to TS 36.508.	-	-	-	-

Table 9.2.3.1.18.3.2-2: Parallel behaviour

St	Procedure	Message Sequence		TP	Verdict
		U - S	Message		
-	EXCEPTION: Steps 1a1-1a 5 describe a behaviour which depends on the UE capability; the "lower case letter" identifies a step sequence that take place if a capability is supported.	-	-	-	-
1a1	IF pc_CS THEN the UE transmits a LOCATION UPDATING REQUEST message.	-->	LOCATION UPDATING REQUEST	-	-
-	EXCEPTION: The messages in the next two steps are sent only IF pc_GERAN AND px_RATComb_Tested = EUTRA_GERAN	-	-	-	-
1a2a 1	The UE transmits a <i>Classmark Change</i> message	-->	CLASSMARK CHANGE	-	-
1a2a 2	IF pc_UTRA THEN the UE transmits a <i>Utran Classmark Change</i> message.	-->	UTRAN CLASSMARK CHANGE.	-	-
1a3	The SS transmits an AUTHENTICATION REQUEST message to initiate the authentication and AKA procedure.	<--	AUTHENTICATION REQUEST	-	-
1a4	The UE transmits an AUTHENTICATION RESPONSE message.	-->	AUTHENTICATION RESPONSE	-	-
1a5	The SS transmits a LOCATION UPDATING ACCEPT message including IMSI-1	<--	LOCATION UPDATING ACCEPT	-	-

9.2.3.1.18.3.3 Specific message contents

Table 9.2.3.1.18.3.3-1: Void

Table 9.2.3.1.18.3.3-2: Message TRACKING AREA UPDATE REJECT (step 3, Table 9.2.3.1.18.3.2-1)

Derivation path: 36.508 table 4.7.2-24			
Information Element	Value/Remark	Comment	Condition
EMM cause	'0000 1110'B	#14 "EPS services not allowed in this PLMN"	

Table 9.2.3.1.18.3.3-3: Message ATTACH REQUEST (step 12, Table 9.2.3.1.18.3.2-1)

Derivation path: 36.508 table 4.7.2-4			
Information Element	Value/Remark	Comment	Condition
Old GUTI or IMSI	IMSI		
Last visited registered TAI	Not present		

Table 9.2.3.1.18.3.3-4: Message ATTACH ACCEPT (step 18, Table 9.2.3.1.18.3.2-1)

Derivation path: 36.508 table 4.7.2-1			
Information Element	Value/Remark	Comment	Condition
TAI list			
Number of elements	'00000'B		
Type of list	'00'B	"list of TACs belonging to one PLMN, with non-consecutive TAC values"	
MCC MNC TAC 1	PLMN= 002/101 TAC 1=1	"TAI-9"	
GUTI	GUTI-9		

Table 9.2.3.1.18.3.3-5: Message ATTACH REQUEST (step 25, Table 9.2.3.1.18.3.2-1)

Derivation path: 36.508 table 4.7.2-4			
Information Element	Value/Remark	Comment	Condition
Old GUTI or IMSI	GUTI-9		
Last visited registered TAI	TAI-9		

Table 9.2.3.1.18.3.3-6: LOCATION UPDATING ACCEPT (step 5, Table 9.2.3.1.18.3.2-2)

Derivation Path: TS 36.508 Table 4.7B.2-5			
Information Element	Value/remark	Comment	Condition
Mobile identity			
IMSI	IMSI-1		

9.2.3.1.18a Normal tracking area update / Rejected / EPS services not allowed in this PLMN / Single Frequency operation

9.2.3.1.18a.1 Test Purpose (TP)

Same test purpose as in clause 9.2.3.1.18.1

9.2.3.1.18a.2 Conformance requirements

Same conformance requirements as in clause 9.2.3.1.18.2

9.2.3.1.18a.3 Test description

9.2.3.1.18a.3.1 Pre-test conditions

System Simulator:

- Three intra-frequency E-UTRA cells Cell A, Cell B, and Cell C;
- cell A belongs to TAI-7(visited PLMN, MCC = MCC in USIM MNC=02) and is set to "Serving cell";
- cell B belongs to TAI-8(visited PLMN, MCC = MCC in USIM MNC=02 another TAC) and is set to "Non-suitable cell";
- cell C belongs to TAI-9(visited PLMN, MCC=002 MNC=101) and is set to "Non-suitable "off" cell";
- if pc_UTRA AND px_RATComb_Tested = EUTRA_UTRA, cell 5 (belongs to RAI-8, visited PLMN) is set to "Non-suitable "off" cell";
- if pc_GERAN AND px_RATComb_Tested = EUTRA_GERAN, cell 24 (belongs to RAI-8, visited PLMN) is set to "Non-suitable "off" cell";
- system information combination 10 as defined in TS 36.508[18] clause 4.4.3.1 is applied in E-UTRA cells;
- system information indicate that NMO 1 is used;
- If (px_RATComb_Tested = EUTRA_Only):
- neither cell 5 nor cell 24 is configured;
- system information combination 1 as defined in TS 36.508[18] clause 4.4.3.1 is applied in E-UTRA cells;

UE:

- the UE is configured to initiate EPS attach.

Preamble:

- the UE is in state Registered, Idle Mode (state 2) on cell A according to TS 36.508 [18].

9.2.3.1.18a.3.2 Test procedure sequence

Table 9.2.3.1.18a.3.2-1: Main behaviour

St	Procedure	Message Sequence		TP	Verdict
		U - S	Message		
1	Set the cell type of cell A to the "Non-Suitable cell". Set the cell type of cell B to the "Serving cell".	-	-	-	-
2	The UE transmits a TRACKING AREA UPDATE REQUEST on Cell B.	-->	TRACKING AREA UPDATE REQUEST	-	-
3	The SS transmits a TRACKING AREA UPDATE REJECT message with EMM cause = "EPS services not allowed in this PLMN" as specified.	<--	TRACKING AREA UPDATE REJECT	-	-
4	The SS releases the RRC connection.				
5	Check: Does the UE transmit an ATTACH REQUEST message in the next 90 seconds on cell B?	-->	ATTACH REQUEST	1	F
6	Set the cell type of cell A to the "Serving cell". Set the cell type of cell B to the "Non-Suitable cell". Note: cell A and cell B are in the same PLMN.	-	-	-	-
7	The user initiates an attach by MMI or by AT command.	-	-	-	-
8	Check: Does the UE transmit an ATTACH REQUEST message in the next 90 seconds on cell A?	-->	ATTACH REQUEST	2	F
9	Set the cell type of cell A to the "Non-Suitable cell". Set the cell type of cell B to the "Non-Suitable "off" cell". If px_RATComb_Tested = EUTRA_UTRA set the cell type of cell 5 to the "Serving cell" or if px_RATComb_Tested = EUTRA_GERAN set cell 24 to the "Serving cell". Note: Cell A and Cell 5 or 24 are in the same PLMN.	-	-	-	-
	EXCEPTION: Steps 10a1 to 10a2 describe behaviour that depends on the UE capability; the "lower case letter" identifies a step sequence that take place if a capability is supported				
10a 1	IF pc_UTRA AND px_RATComb_Tested = EUTRA_UTRA OR pc_GERAN AND px_RATComb_Tested = EUTRA_GERAN THEN the user initiates an attach by MMI or by AT command.	-	-	-	-
-	EXCEPTION: Depending on UE capabilities the behaviour in table 9.2.3.1.18a.3.2-2 occurs in parallel with step 10a2				
10a 2	Check: Does the UE transmit an ATTACH REQUEST message in the next 30 seconds on cell 5 or 24?	-->	ATTACH REQUEST	1	F
	The following messages are sent and shall be received on cell C.	-	-	-	-
11	If px_RATComb_Tested = EUTRA_UTRA set the cell type of cell 5 to the "Non-Suitable cell" or if px_RATComb_Tested = EUTRA_GERAN set cell 24 to the "Non-Suitable cell". Set the cell type of cell C to the "Serving cell". Note: cell 5 or 24 and cell C are in different PLMNs.	-	-	-	-
12	Check: Does the UE send ATTACH REQUEST message with a PDN CONNECTIVITY REQUEST message to	-->	ATTACH REQUEST	3	P

	request PDN connectivity to the default PDN?				
13	The SS starts an authentication procedure	<--	AUTHENTICATION REQUEST	-	-
14	The UE responds properly to the authentication procedure	-->	AUTHENTICATION RESPONSE	-	-
15	The SS starts a NAS security mode command procedure to perform NAS integrity protection.	<--	SECURITY MODE COMMAND	-	-
16	The UE responds properly to the NAS security mode command procedure	-->	SECURITY MODE COMPLETE	-	-
-	EXCEPTION: Steps 17a1 to 17a2 describe behaviour that depends on UE configuration; the "lower case letter" identifies a step sequence that take place if the UE has ESM information which needs to be transferred.	-	-	-	-
17a 1	IF the UE sets the ESM information transfer flag in the last PDN CONNECTIVITY REQUEST message THEN the SS transmits an ESM INFORMATION REQUEST message to initiate exchange of protocol configuration options and/or APN.	<--	ESM INFORMATION REQUEST	-	-
17a 2	The UE transmits an ESM INFORMATION RESPONSE message to transfer protocol configuration options and/or APN.	-->	ESM INFORMATION RESPONSE	-	-
18	The SS sends ATTACH ACCEPT message with the ACTIVATE DEFAULT EPS BEARER CONTEXT REQUEST message.	<--	ATTACH ACCEPT	-	-
-	EXCEPTION: In parallel to the event described in step 19 below the generic procedure for IP address allocation in the U-plane specified in TS 36.508 subclause 4.5A.1 takes place performing IP address allocation in the U-plane if requested by the UE.				
19	The UE transmits an ATTACH COMPLETE message.	-->	ATTACH COMPLETE	-	-
20	The SS releases the RRC connection.	-	-	-	-
21	If possible (see ICS) switch off is performed or the USIM is removed. Otherwise the power is removed.	-	-	-	-
-	EXCEPTION: Step 22 describes behaviour that depends on the UE capability.				
22	If pc_SwitchOnOff or pc_USIM_Removal then the UE transmit a DETACH REQUEST.	-->	DETACH REQUEST	-	-
	The following messages are sent and shall be received on cell A.				
23	Set the cell type of cell A to the " Serving cell". Set the cell type of cell C to the " Non-Suitable cell". Note: Cell A belongs to the forbidden PLMNs for GPRS service.				
24	The UE is brought back to operation or the USIM is inserted.	-	-	-	-
25	Check: Does the UE send ATTACH REQUEST message with a PDN CONNECTIVITY REQUEST message to request PDN connectivity to the default PDN?	-->	ATTACH REQUEST	4	P
26- 37	The attach procedure is completed by executing steps 5 to 16 of the UE registration procedure in TS 36.508 sub clause 4.5.2.3.	-	-	-	-
-	At the end of this test procedure sequence, the UE is in end state E-UTRA connected (E2) according to TS 36.508.	-	-	-	-

Table 9.2.3.1.18a.3.2-2: Parallel behaviour

St	Procedure	Message Sequence		TP	Verdict
		U - S	Message		
-	EXCEPTION: Steps 1a1-1a 5 describe a behaviour which depends on the UE capability; the "lower case letter" identifies a step sequence that take place if a capability is supported.	-	-	-	-
1a1	IF pc_CS THEN the UE transmits a LOCATION UPDATING REQUEST message.	-->	LOCATION UPDATING REQUEST	-	-
-	EXCEPTION: Steps 1a2a1 to 1a2a2 describe behaviour that depends on the UE capability; the "lower case letter" identifies a step sequence that take place if a capability is supported	-	-	-	-
1a2a 1	IF pc_GERAN AND px_RATComb_Tested = EUTRA_GERAN THEN the UE transmits a <i>Classmark Change</i> message	-->	CLASSMARK CHANGE	-	-
-	EXCEPTION: Step 1a2a2 describes behaviour that depends on the UE capability.	-	-	-	-
1a2a 2	IF pc_UTRA THEN the UE transmits a <i>Utran Classmark Change</i> message.	-->	UTRAN CLASSMARK CHANGE.	-	-
1a3	The SS transmits an AUTHENTICATION REQUEST message to initiate the authentication and AKA procedure.	<--	AUTHENTICATION REQUEST	-	-
1a4	The UE transmits an AUTHENTICATION RESPONSE message.	-->	AUTHENTICATION RESPONSE	-	-
1a5	The SS transmits a LOCATION UPDATING ACCEPT message including IMSI-1	<--	LOCATION UPDATING ACCEPT	-	-

9.2.3.1.18a.3.3 Specific message contents

Same specific message contents as in clause 9.2.3.1.18.3.3

Table 9.2.3.1.18a.3.3-1: LOCATION UPDATING ACCEPT (step 1a5, Table 9.2.3.1.18.3.2-2)

Derivation Path: TS 36.508 Table 4.7B.2-5			
Information Element	Value/remark	Comment	Condition
Mobile identity			
IMSI	IMSI-1		

9.2.3.1.19 Normal tracking area update / Rejected / No suitable cells in tracking Area

9.2.3.1.19.1 Test Purpose (TP)

(1)

```

with { UE is sending a TRACKING AREA UPDATE REQUEST message}
ensure that {
  when { UE receives a TRACKING AREA UPDATE REJECT message with the EMM cause set to 'No Suitable
Cells In tracking area' }
  then { UE selects a suitable cell in another tracking area in the same PLMN and performs the
tracking area updating procedure and UE does not select a suitable cell in another PLMN}
}

```

9.2.3.1.19.2 Conformance requirements

References: The conformance requirements covered in the present TC are specified in: TS 24.301, clause 5.5.3.2.5.

[TS 24.301, clause 5.5.3.2.5]

If the tracking area updating cannot be accepted by the network, the MME sends a TRACKING AREA UPDATE REJECT message to the UE including an appropriate EMM cause value.

Upon receiving the TRACKING AREA UPDATE REJECT message, the UE shall stop timer T3430, stop any transmission of user data, and take the following actions depending on the EMM cause value received.

...

#15 (No suitable cells in tracking area);

The UE shall set the EPS update status to EU3 ROAMING NOT ALLOWED (and shall store it according to subclause 5.1.3.3). The UE shall reset the tracking area updating attempt counter and shall enter the state EMM-REGISTERED.LIMITED-SERVICE.

The UE shall store the current TAI in the list of "forbidden tracking areas for roaming" and shall remove the current TAI from the stored TAI list if present.

The UE shall search for a suitable cell in another tracking area or in another location area in the same PLMN according to 3GPP TS 36.304 [21].

If A/Gb mode or Iu mode is supported by the UE, the UE shall handle the GMM parameters GMM state, GPRS update status and routing area updating attempt counter as specified in 3GPP TS 24.008 [13] for the case when the normal routing area updating procedure is rejected with the GMM cause with the same value.

...

9.2.3.1.19.3 Test description

9.2.3.1.19.3.1 Pre-test conditions

System Simulator:

- cell A (belongs to TAI-1, home PLMN) is set to "Serving cell";
- cell B (belongs to TAI-2, home PLMN) is set to "Non-suitable cell";
- If (px_SinglePLMN_Tested = Multi PLMN) cell G (belongs to TAI-7, visited PLMN) is set to "Non-suitable cell".

UE:

- the UE is configured to initiate EPS attach.

Preamble:

- the UE is in state Registered, Idle mode (state 2) on cell A according to TS 36.508 [18].

9.2.3.1.19.3.2 Test procedure sequence

Table 9.2.3.1.19.3.2-1: Main behaviour

St	Procedure	Message Sequence		TP	Verdict
		U - S	Message		
1	Set the cell type of Cell A to the "non-Suitable cell". Set the cell type of Cell B to the "Serving cell". If present, set the cell type of Cell G to the "Serving cell".	-	-	-	-
-	The following messages are sent and shall be received on Cell B.	-	-	-	-
2	The UE transmits a TRACKING AREA UPDATE REQUEST message.	-->	TRACKING AREA UPDATE REQUEST	-	-
3	The SS transmits a TRACKING AREA UPDATE REJECT message with the EMM cause set to 'No Suitable Cells In tracking area'.	<--	TRACKING AREA UPDATE REJECT	-	-
3A	Set the cell type of Cell A to the "Serving cell". Set the cell type of Cell B to the "Suitable neighbour Intra Frequency cell".				
4	The SS releases the RRC connection.	-	-	-	-
4A	Void				
-	The following messages are sent and shall be received on Cell A.	-	-	-	-
5	Check: Does the UE transmit a TRACKING AREA UPDATE REQUEST message?	-->	TRACKING AREA UPDATE REQUEST	1	P
6	The SS transmits a TRACKING AREA UPDATE ACCEPT message.	<--	TRACKING AREA UPDATE ACCEPT	-	-
7	The UE transmits a TRACKING AREA UPDATE COMPLETE message.	-->	TRACKING AREA UPDATE COMPLETE	-	-
-	At the end of this test procedure sequence, the UE is in end state E-UTRA connected (E2_T3440) according to TS 36.508.	-	-	-	-

9.2.3.1.19.3.3 Specific message contents

Table 9.2.3.1.19.3.3-1: TRACKING AREA UPDATE REJECT (step 3, Table 9.2.3.1.19.3.2-1)

Derivation Path: 36.508, Table 4.7.2-26			
Information Element	Value/remark	Comment	Condition
EMM cause	'0000 1111'B	No Suitable Cells In tracking area	

Table 9.2.3.1.19.3.3-2: Message TRACKING AREA UPDATE REQUEST (step 5, Table 9.2.3.1.19.3.2-1)

Derivation path: 36.508 table 4.7.2-27			
Information Element	Value/Remark	Comment	Condition
Old GUTI	GUTI-1		

9.2.3.1.20 Normal tracking area update / Rejected / Not authorized for this CSG

9.2.3.1.20.1 Test Purpose (TP)

(1)

```

with { UE has sent a TRACKING AREA UPDATE REQUEST message }
ensure that {
  when { UE receives a TRACKING AREA UPDATE REJECT message with the reject cause set to "Not
authorized for this CSG" and with integrity protection }
  then { UE removes the CSG ID from the Allowed CSG list }
}
    
```

(2)

```

with { UE has sent a TRACKING AREA UPDATE REQUEST message }
ensure that {
  when { UE receives a TRACKING AREA UPDATE REJECT message with the reject cause set to "Not
authorized for this CSG" and with integrity protection }
  then { UE searches for a suitable cell in the same PLMN and sent a TRACKING AREA UPDATE REQUEST
message }
}

```

9.2.3.1.20.2 Conformance requirements

References: The conformance requirements covered in the current TC are specified in: TS 24.301, clause 5.5.3.3.5.

[TS 24.301, clause 5.5.3.2.5]

#25 (Not authorized for this CSG);

EMM cause #25 is only applicable when received from a CSG cell. EMM cause #25 received from a non-CSG cell is considered as an abnormal case and the behaviour of the UE is specified in subclause 5.5.3.2.6.

If the TRACKING AREA UPDATE REJECT message with EMM cause #25 was received without integrity protection, then the UE shall discard the message.

The UE shall set the EPS update status to EU3 ROAMING NOT ALLOWED (and shall store it according to subclause 5.1.3.3). The UE shall reset the tracking area updating attempt counter and shall enter the state EMM-REGISTERED.LIMITED-SERVICE.

If the CSG ID of the cell where the UE has sent the TRACKING AREA UPDATE REQUEST message is contained in the Allowed CSG list, the UE shall remove the entry corresponding to this CSG ID from the Allowed CSG list.

If the CSG ID of the cell where the UE has sent the TRACKING AREA UPDATE REQUEST message is contained in the Operator CSG list, the UE shall apply the procedures defined in 3GPP TS 23.122 [6] subclause 3.1A.

The UE shall search for a suitable cell in the same PLMN according to 3GPP TS 36.304 [21].

If A/Gb mode or Iu mode is supported by the UE, the UE shall handle the GMM parameters GMM state, GPRS update status and routing area updating attempt counter as specified in 3GPP TS 24.008 [13] for the case when the normal routing area updating procedure is rejected with the GMM cause with the same value.

9.2.3.1.20.3 Test description

9.2.3.1.20.3.1 Pre-test conditions

System Simulator:

- cell A (TAI-1, frequency 1, HPLMN, not a CSG cell) is set to "Serving cell";
- cell B (TAI-2, frequency 1, HPLMN, is a CSG cell) is set to "Non-suitable off cell";
- cell D (TAI-4, frequency 1, HPLMN, not a CSG cell) is set to "Non-suitable off cell".
- System information combination 1 as defined in TS 36.508[18] clause 4.4.3.1 is used in Cell A and Cell D.
- System information combination 7 as defined in TS 36.508[18] clause 4.4.3.1 is used in Cell B.

UE:

- the UE is previously registered on cell B using manual CSG selection (so the allowed CSG list includes CSG ID of cell B).

Preamble:

- the UE is in state Registered, Idle mode (state 2) on cell A according to TS 36.508 [18]

9.2.3.1.20.3.2 Test procedure sequence

Table 9.2.3.1.20.3.2-1: Main behaviour

St	Procedure	Message Sequence		TP	Verdict
		U - S	Message		
1	The SS configures: - Cell A as a "Not Suitable cell". - Cell B as a "Serving cell".	-	-	-	-
2	The UE transmits a TRACKING AREA UPDATE REQUEST message.	-->	TRACKING AREA UPDATE REQUEST	-	-
3	The SS transmits an TRACKING AREA UPDATE REJECT message with EMM cause = "Not authorized for this CSG" with integrity protection.	<--	TRACKING AREA UPDATE REJECT	-	-
4	The SS releases the RRC connection.	-	-	-	-
5	Check: Does the UE transmit an TRACKING AREA UPDATE REQUEST message on Cell B in the next 30 seconds?	-->	TRACKING AREA UPDATE REQUEST	1	F
6	The SS configures: - Cell A as a "Not Suitable off cell". - Cell B as a "Not Suitable cell". - Cell D as a "Suitable cell".	-	-	-	-
7	Check: Does the UE transmit an TRACKING AREA UPDATE REQUEST message in the next 30 seconds on Cell D?	-->	TRACKING AREA UPDATE REQUEST	2	P
8	The SS transmits a TRACKING AREA UPDATE ACCEPT message.	<--	TRACKING AREA UPDATE ACCEPT	-	-
9	The UE transmits a TRACKING AREA UPDATE COMPLETE message.	-->	TRACKING AREA UPDATE COMPLETE	-	-
9A	The SS releases the RRC connection.	-	-	-	-
10	The SS configures: - Cell A as a "Not Suitable off cell". - Cell B as a "Serving cell". - Cell D as a "Not Suitable cell".	-	-	-	-
11	Check: Does the UE transmit an TRACKING AREA UPDATE REQUEST message in the next 30 seconds on Cell B?	-->	TRACKING AREA UPDATE REQUEST	1	F

9.2.3.1.20.3.3 Specific message contents

Table 9.2.3.1.20.3.3-1: TRACKING AREA UPDATE REQUEST (step 2, Table 9.2.3.1.20.3.2-1)

Derivation path: 36.508 table 4.7.2-27			
Information Element	Value/Remark	Comment	Condition
Old GUTI	GUTI-1		
Old P-TMSI signature	P-TMSI Signature-1		

Table 9.2.3.1.20.3.3-2: Message TRACKING AREA UPDATE REJECT (step 3, Table 9.2.3.1.20.3.2-1)

Derivation Path: 36.508, Table 4.7.2-26			
Information Element	Value/remark	Comment	Condition
EMM cause	'00011001'B	#25 " Not authorized for this CSG"	

Table 9.2.3.1.20.3.3-3: Message TRACKING AREA UPDATE REQUEST (step 7, Table 9.2.3.1.20.3.2-1)

Derivation path: 36.508 table 4.7.2-27			
Information Element	Value/Remark	Comment	Condition
Old GUTI	GUTI-1		
Old P-TMSI signature	P-TMSI Signature-1		

Table 9.2.3.1.20.3.3-4: SystemInformationBlockType1 for Cell A, B, CD (Pre-test conditions and all steps in Table 9.2.3.1.20.3.2-1)

Derivation Path: 36.508 clause 4.4.3.2			
Information Element	Value/remark	Comment	Condition
SystemInformationBlockType1 ::= SEQUENCE {			
cellAccessRelatedInfo SEQUENCE {			
csg-Indication	TRUE		Cell B
	FALSE		Cell A
	FALSE		Cell CD
csg-Identity	Not present		Cell A
	'000 0000 0000 0000 0000 0000 0010'B		Cell B
	Not present		Cell CD
}			
}			

Table 9.2.3.1.20.3.3-5: Message TRACKING AREA UPDATE ACCEPT (step 8, Table 9.2.3.1.20.3.2-1)

Derivation path: 36.508 table 4.7.2-24			
Information Element	Value/Remark	Comment	Condition
GUTI	GUTI-2		

Table 9.2.3.1.20.3.3-6: SystemInformationBlockType4 for cell B (Pre-test conditions and all steps, Table 9.2.3.1.20.3.2-1)

Derivation Path: 36.508 clause 4.4.3.3, Table 4.4.3.3-3			
Information Element	Value/remark	Comment	Condition
SystemInformationBlockType4 ::= SEQUENCE {			
csg-PhysCellIdRange ::= SEQUENCE {			
Start	2		
Range	Not present	The UE shall apply value 1 in case the field is absent, in which case only the physical cell identity value indicated by start applies.	
}			
}			

9.2.3.1.21 Void

9.2.3.1.22 Normal tracking area update / Abnormal case / access barred due to access class control or NAS signalling connection establishment rejected by the network

9.2.3.1.22.1 Test Purpose (TP)

(1)

```
with { The UE is in the state EMM-REGISTERED }
ensure that {
  when { Access is barred for signalling in the cell UE is camping [Access Class barred in System
information] }
  then { the UE will not initiate the tracking area updating procedure on the current cell }
}
```

(2)

```
with { The UE is in the state EMM-REGISTERED }
ensure that {
```

```

when { Access is barred for signalling in the cell UE is camping [T302 running due to
RRCConnectionReject message reception] }
  then { the UE will not initiate the tracking area updating procedure on the current cell }
}

```

(3)

```

with { The UE is in the state EMM-REGISTERED }
ensure that {
  when { Access is not barred for signalling in the cell UE is camping }
    then { the UE will initiate the tracking area updating procedure on the current cell }
}

```

(4)

```

with { The UE is in the state EMM-REGISTERED }
ensure that {
  when { Access was barred for signalling in the cell and UE has reselected an new cell where access
for "signalling" is granted }
    then { the UE will initiate the tracking area updating procedure on the new cell }
}

```

9.2.3.1.22.2 Conformance requirements

References: The conformance requirements covered in the current TC are specified in: TS 24.301, clause 5.5.3.2.6 and TS 36.331, clause 5.3.3.2

[TS 24.301, clause 5.5.3.2.6]

The following abnormal cases can be identified:

- a) Access barred because of access class barring or NAS signalling connection establishment rejected by the network

If access is barred for "signalling" (see 3GPP TS 36.331 [22]), the tracking area updating procedure shall not be started. The UE stays in the current serving cell and applies the normal cell reselection process. The tracking area updating procedure is started as soon as possible and if still necessary, e.g. when access for "signalling" is granted on the current cell or when the UE moves to a cell where access for "signalling" is granted.

[TS 36.331, clause 5.3.3.2]

...

- 1> else (the UE is establishing the RRC connection for mobile originating signalling):
 - 2> if timer T302 or T305 is running:
 - 3> consider access to the cell as barred;
 - 2> else if *SystemInformationBlockType2* includes the *ac-BarringInfo* and the *ac-BarringForMO-Signalling* is present:
 - 3> if the UE has one or more Access Classes, as stored on the USIM, with a value in the range 11..15, which is valid for the UE to use according to TS 22.011 [10] and TS 23.122 [11], and
 - 3> for at least one of these Access Classes the corresponding bit in the *ac-BarringForSpecialAC* contained in *ac-BarringForMO-Signalling* is set to zero:
 - 4> consider access to the cell as not barred;
 - 3> else:
 - 4> draw a random number '*rand*' uniformly distributed in the range: $0 \leq rand < 1$;
 - 4> if '*rand*' is lower than the value indicated by *ac-BarringFactor* included in *ac-BarringForMO-Signalling*:
 - 5> consider access to the cell as not barred;

4> else:

5> consider access to the cell as barred;

2> else:

3> consider access to the cell as not barred;

9.2.3.1.22.3 Test description

9.2.3.1.22.3.1 Pre-test conditions

System Simulator:

- cell A and cell B are configured according to table 6.3.2.2-1 in TS 36.508 [18].
- cell A belongs to TAI-1 (home PLMN)
- cell B belongs to TAI-2 (home PLMN)
- cell D belongs to TAI-4 (home PLMN)

UE:

None;

Preamble:

- the UE is in state Registered, Idle Mode (state 2) on cell B according to TS 36.508 [18].

9.2.3.1.22.3.2 Test procedure sequence

Table 9.2.3.1.22.3.2-1: Main behaviour

St	Procedure	Message Sequence		TP	Verdict
		U - S	Message		
1	The SS sets the cell type of cell A to the "Serving cell", sets the cell type of cell B to the " Non-Suitable cell", and sets SystemInformationBlockType2 parameters as described below.	-	-	-	-
-	The following messages are to be observed on Cell A unless explicitly stated otherwise.	-	-	-	-
2	Check: for 60 seconds if UE initiates the tracking area updating procedure on cell A?	-	-	1	F
3	The SS transmits a Paging message including systemInfoModification.	-	-	-	-
4	The SS changes SystemInformationBlockType2 parameters to default parameters defined in [18].	-	-	-	-
5	The UE transmits RRC Connection Request	-	-	-	-
6	SS responds with <i>RRCConnectionReject</i> message with IE <i>waitTime</i> set to 10 seconds(Max Value).	-	-	-	-
7	Check: for 10 seconds if UE initiates the tracking area updating procedure and hence transmits RRC Connection Request?	-	-	2	F
8	Check: Does the UE transmit a TRACKING AREA UPDATE REQUEST?	-->	TRACKING AREA UPDATE REQUEST	3	P
9	The SS transmits a TRACKING AREA UPDATE ACCEPT message.	<--	TRACKING AREA UPDATE ACCEPT	-	-
10	The UE sends TRACKING AREA UPDATE COMPLETE message.	-->	TRACKING AREA UPDATE COMPLETE	-	-
10 A	The SS releases the RRC connection.	-	-	-	-
11	The SS set SystemInformationBlockType1 and SystemInformationBlockType2 parameters as described below.	-	-	-	-
12	Void	-	-	-	-
13	The SS sets the cell type of cell B to the "serving cell", cell A to "non-suitable off Cell" , and cell D to "Suitable neighbour intra-frequency cell".	-	-	-	-
13 A	Check: For 60 seconds if the UE initiates the tracking area update procedure on Cell B?	-	-	1	F
13 B	The SS sets the cell type of cell B to "Suitable neighbour intra-frequency cell" and cell D to "serving cell"	-	-	-	-
-	The following messages are to be observed on Cell D unless explicitly stated otherwise.	-	-	-	-
14	Check: Does the UE transmit a TRACKING AREA UPDATE REQUEST?	-->	TRACKING AREA UPDATE REQUEST	4	P
15	The SS transmits a TRACKING AREA UPDATE ACCEPT message.	<--	TRACKING AREA UPDATE ACCEPT	-	-
16	The UE sends TRACKING AREA UPDATE COMPLETE message.	-->	TRACKING AREA UPDATE COMPLETE	-	-
-	At the end of this test procedure sequence, the UE is in end state E-UTRA connected (E2_T3440) according to TS 36.508	-	-	-	-

9.2.3.1.22.3.3 Specific message contents

Table 9.2.3.1.22.3.3-1: SystemInformationBlockType2 for Cell A (step 1, Table 9.2.3.1.22.3.2-1)

Derivation Path: 36.508, Table 4.4.3.3-1			
Information Element	Value/remark	Comment	Condition
SystemInformationBlockType2 ::= SEQUENCE {			
accessBarringInformation SEQUENCE {			
accessBarringForEmergencyCalls	FALSE		
accessBarringForSignalling SEQUENCE {			
accessProbabilityFactor	p00		
accessBarringTime	s4		
accessClassBarringList SEQUENCE (SIZE (maxAC)) OF SEQUENCE {	5 entries		
accessClassBarring[1]	TRUE		
accessClassBarring[2]	TRUE		
accessClassBarring[3]	TRUE		
accessClassBarring[4]	TRUE		
accessClassBarring[5]	TRUE		
}			
}			
accessBarringForOriginatingCalls	Not present		
}			
}			

Table 9.2.3.1.22.3.3-2: SystemInformationBlockType2 for Cell B (step 11, Table 9.2.3.1.22.3.2-1)

Derivation Path: 36.508, Table 4.4.3.3-1			
Information Element	Value/remark	Comment	Condition
SystemInformationBlockType2 ::= SEQUENCE {			
accessBarringInformation SEQUENCE {			
accessBarringForEmergencyCalls	FALSE		
accessBarringForSignalling SEQUENCE {			
accessProbabilityFactor	p00		
accessBarringTime	s4		
accessClassBarringList SEQUENCE (SIZE (maxAC)) OF SEQUENCE {	5 entries		
accessClassBarring[1]	TRUE		
accessClassBarring[2]	TRUE		
accessClassBarring[3]	TRUE		
accessClassBarring[4]	TRUE		
accessClassBarring[5]	TRUE		
}			
}			
accessBarringForOriginatingCalls	Not present		
}			
}			

Table 9.2.3.1.22.3.3-3: SystemInformationBlockType1 for Cell B (step 11, Table 9.2.3.1.22.3.2-1)

Derivation Path: 36.508, Table 4.4.3.2-3			
Information Element	Value/remark	Comment	Condition
SystemInformationBlockType1 ::= SEQUENCE {			
cellAccessRelatedInfo SEQUENCE {			
intraFreqReselection	allowed		
}			
}			

9.2.3.1.23 Normal tracking area update / Abnormal case / Success after several attempts due to no network response / TA belongs to TAI list and status is UPDATED / TA does not belong to TAI list or status is not UPDATED

9.2.3.1.23.1 Test Purpose (TP)

(1)

```
with { UE has sent a TRACKING AREA UPDATE REQUEST message with EPS update type set to 'Periodic updating' and has the tracking area updating attempt counter set to the value less than four, the TAI of the current serving cell is included in the TAI list and the update status is equal to EU1 UPDATED }
ensure that {
  when { UE detects release of the NAS signalling connection }
  then { UE keeps the update status to EU1 UPDATED, enters state EMM-REGISTERED.NORMAL-SERVICE and starts timer T3411 }
}
```

(2)

```
with { UE has sent a TRACKING AREA UPDATE REQUEST message with EPS update type set to 'Periodic updating', has the tracking area updating attempt counter set to the value less than four, has detected T3430 expiry, the TAI of the current serving cell is included in the TAI list and the update status is equal to EU1 UPDATED }
ensure that {
  when { UE detects T3411 expiry }
  then { UE initiates the tracking area updating procedure }
}
```

(3)

```
with { UE has sent a TRACKING AREA UPDATE REQUEST message with EPS update type set to 'TA updating' or 'combined TA/LA updating' and has the tracking area updating attempt counter set to the value less than four and the TAI of the current serving cell is not included in the TAI list or the update status is different to EU1 UPDATED }
ensure that {
  when { UE detects release of the NAS signalling connection }
  then { UE starts timer T3411, sets the update status to EU2 NOT UPDATED and changes to state EMM-REGISTERED.ATTEMPTING-TO-UPDATE }
}
```

(4)

```
with { UE has sent a TRACKING AREA UPDATE REQUEST message with EPS update type set to 'TA updating' or 'combined TA/LA updating', has the tracking area updating attempt counter set to the value less than four, has detected T3430 expiry and the TAI of the current serving cell is not included in the TAI list or the update status is different to EU1 UPDATED }
ensure that {
  when { UE detects T3411 expiry }
  then { UE initiates the tracking area updating procedure }
}
```

9.2.3.1.23.2 Conformance requirements

References: The conformance requirements covered in the present TC are specified in: TS 24.301, clause 5.5.3.1, 5.5.3.2.6 and 5.5.3.3.6.

[TS 24.301, clause 5.5.3.1]

A tracking area updating attempt counter is used to limit the number of subsequently rejected tracking area update attempts. The tracking area updating attempt counter shall be incremented as specified in subclause 5.5.3.2.6. Depending on the value of the tracking area updating attempt counter, specific actions shall be performed. The tracking area updating attempt counter shall be reset when:

- an attach or combined attach procedure is successfully completed;
- a normal or periodic tracking area updating or a combined tracking area updating procedure is successfully completed; or

- a normal or periodic tracking area updating or a combined tracking area updating procedure is rejected with EMM cause #11, #12, #13, #14, #15 or #25.

Additionally the tracking area updating attempt counter shall be reset when the UE is in substate EMM-REGISTERED.ATTEMPTING-TO-UPDATE or EMM-REGISTERED.ATTEMPTING-TO-UPDATE-MM, and:

- a new tracking area is entered; or
- timer T3402 expires.

[TS 24.301, clause 5.5.3.2.6]

The following abnormal cases can be identified:

...

- b) Lower layer failure or release of the NAS signalling connection before the TRACKING AREA UPDATE ACCEPT or TRACKING AREA UPDATE REJECT message is received

The tracking area updating procedure shall be aborted, and the UE shall proceed as described below.

- c) T3430 timeout

The UE shall abort the procedure and proceed as described below. The NAS signalling connection shall be released locally.

...

For the cases b, c, d, e, and f, the UE shall stop any ongoing transmission of user data.

For the cases b, c and d the UE shall proceed as follows:

Timer T3430 shall be stopped if still running. The tracking area updating attempt counter shall be incremented, unless it was already set to 5.

If the tracking area updating attempt counter is less than 5, and the TAI of the current serving cell is included in the TAI list and the EPS update status is equal to EU1 UPDATED:

- the UE shall keep the EPS update status to EU1 UPDATED and enter state EMM-REGISTERED.NORMAL-SERVICE. The UE shall start timer T3411.

If in addition the TRACKING AREA UPDATE REQUEST indicated "periodic updating", the timer T3411 may be stopped when the UE enters EMM-CONNECTED mode.

If timer T3411 expires the tracking area updating procedure is triggered again.

If the tracking area updating attempt counter is less than 5, and the TAI of the current serving cell is not included in the TAI list or the EPS update status is different to EU1 UPDATED:

- the UE shall start timer T3411, shall set the EPS update status to EU2 NOT UPDATED and change to state EMM-REGISTERED.ATTEMPTING-TO-UPDATE. When timer T3411 expires the tracking area updating procedure is triggered again.

If A/Gb mode or Iu mode is supported by the UE, the UE shall in addition handle the GPRS update status as specified in 3GPP TS 24.008 [13] for the abnormal case when a normal or periodic routing area updating procedure fails and the routing area updating attempt counter is less than 5 and the GPRS update status is different from GU1 UPDATED.

[TS 24.301, clause 5.5.3.3.6]

If the tracking area updating attempt counter is incremented according to subclause 5.5.3.2.6 the next actions depend on the value of the tracking area updating attempt counter.

- if the update status is U1 UPDATED and the tracking area updating attempt counter is less than 5, then the UE shall keep the update status to U1 UPDATED, the new MM state is MM IDLE substate NORMAL SERVICE;

- if the tracking area updating attempt counter is less than 5 and, additionally, the update status is different from U1 UPDATED UE shall delete any LAI, TMSI, ciphering key sequence number and list of equivalent PLMNs and set the update status to U2 NOT UPDATED. The MM state remains MM LOCATION UPDATING PENDING; or
- if the tracking area updating attempt counter is equal to 5, the UE shall delete any LAI, TMSI, ciphering key sequence number and list of equivalent PLMNs and set the update status to U2 NOT UPDATED. A UE operating in CS/PS mode 1 of operation shall select GERAN or UTRAN radio access technology and proceed with appropriate MM or GMM specific procedures.

9.2.3.1.23.3 Test description

9.2.3.1.23.3.1 Pre-test conditions

System Simulator:

- cell A and cell B
- System information combination 3 as defined in TS 36.508[18] clause 4.4.3.1 is used in E-UTRA cells.

UE:

none.

Preamble:

- the UE is in state Switched OFF (state 1) according to TS 36.508 [18].

9.2.3.1.23.3.2 Test procedure sequence

Table 9.2.3.1.23.3.2-1: Main behaviour

St	Procedure	Message Sequence		TP	Verdict
		U - S	Message		
1	Set the cell type of Cell A to the "Serving cell". Set the cell type of Cell B to the "Suitable neighbour intra-frequency cell".	-	-	-	-
-	The following messages are to be observed on Cell A unless explicitly stated otherwise.	-	-	-	-
2	The UE is powered on or switched on.	-	-	-	-
3	The UE transmits an ATTACH REQUEST message. The PDN CONNECTIVITY REQUEST message is piggybacked in ATTACH REQUEST message.	-->	ATTACH REQUEST	-	-
4	The SS transmits an AUTHENTICATION REQUEST message to initiate the EPS authentication and AKA procedure.	<--	AUTHENTICATION REQUEST	-	-
5	The UE transmits an AUTHENTICATION RESPONSE message and establishes mutual authentication.	-->	AUTHENTICATION RESPONSE	-	-
6	The SS transmits a NAS SECURITY MODE COMMAND message to activate NAS security.	<--	SECURITY MODE COMMAND	-	-
7	The UE transmits a NAS SECURITY MODE COMPLETE message and establishes the initial security configuration.	-->	SECURITY MODE COMPLETE	-	-
-	EXCEPTION: Steps 8a1 to 8a2 describe behaviour that depends on UE configuration; the "lower case letter" identifies a step sequence that take place if the UE has ESM information which needs to be transferred after NAS SECURITY MODE COMPLETE message.	-	-	-	-
8a1	IF the UE sets the ESM information transfer flag in the last PDN CONNECTIVITY REQUEST message THEN the SS transmits an ESM INFORMATION REQUEST message to initiate exchange of protocol configuration options and/or APN.	<--	ESM INFORMATION REQUEST	-	-
8a2	The UE transmits an ESM INFORMATION RESPONSE message to transfer protocol configuration options and/or APN.	-->	ESM INFORMATION RESPONSE	-	-
8A	The SS activates UE radio bearer test mode.	-	-	-	-
9	The SS responds with an ATTACH ACCEPT message with the T3412 value indicating 6 min. The ACTIVATE DEFAULT EPS BEARER CONTEXT REQUEST message is piggybacked in ATTACH ACCEPT message	<--	ATTACH ACCEPT	-	-
-	EXCEPTION: In parallel to the event described in step 10 below the generic procedure for IP address allocation in the U-plane specified in TS 36.508 subclause 4.5A.1 takes place performing IP address allocation in the U-plane if requested by the UE.	-	-	-	-
10	The UE transmits an ATTACH COMPLETE message including an ACTIVATE DEFAULT EPS BEARER CONTEXT ACCEPT message. NOTE: The tracking area updating attempt counter is reset.	-->	ATTACH COMPLETE	-	-
11	The SS releases the RRC connection.	-	-	-	-
12	Wait for 6 min to ensure that T3412 expires.	-	-	-	-
13	The UE transmits a TRACKING AREA UPDATE REQUEST message with the EPS update type value set to 'Periodic updating'.	-->	TRACKING AREA UPDATE REQUEST	-	-
14	The SS releases the RRC connection. NOTE: The tracking area updating attempt counter is 1.	-	-	-	-

15	The SS pages the UE using S-TMSI with CN domain indicator set to "PS".	-	-	-	-
16	Check: Does the UE transmit a SERVICE REQUEST message?	-->	SERVICE REQUEST	1	P
17	The SS transmits a SERVICE REJECT message with EMM cause set to "Congestion".	<--	SERVICE REJECT	-	-
18	The SS releases the RRC connection.	-	-	-	-
19	Wait for 10s after step 14 to ensure that T3411 expires.	-	-	-	-
-	EXCEPTION: Steps 19Aa1 to 19Aa4 describes behaviour depending on UE behaviour; the "lower case letter" identifies a step sequence that take place if the UE does not transmit any TRACKING AREA UPDATE REQUEST message	-	-	-	-
19Aa1	IF the UE does not transmit any TRACKING AREA UPDATE REQUEST message THEN wait for 6 min to ensure that T3412 expires.	-	-	-	-
19Aa2	The UE transmits a TRACKING AREA UPDATE REQUEST message with the EPS update type value set to 'Periodic updating'.	-->	TRACKING AREA UPDATE REQUEST	-	-
19Aa3	The SS releases the RRC connection.	-	-	-	-
19Aa4	Wait for 10s after step 19Aa3 to ensure that T3411 expires.	-	-	-	-
20	Check: Does the UE transmit a TRACKING AREA UPDATE REQUEST message with the EPS update type value set to 'Periodic updating'?	-->	TRACKING AREA UPDATE REQUEST	2	P
21	The SS transmits a TRACKING AREA UPDATE ACCEPT message. NOTE: The tracking area updating attempt counter is reset.	<--	TRACKING AREA UPDATE ACCEPT	-	-
22	The SS releases the RRC connection.	-	-	-	-
22A	Generic test procedure in TS 36.508 subclause 4.5.3A.3 is performed. NOTE: The UE performs the establishment of the new data radio bearer associated with the default EPS bearer context.	-	-	-	-
22B	Generic test procedure in TS 36.508 subclause 4.5.4.3 is performed. NOTE: The UE enters the UE test loop mode.	-	-	-	-
22C	The SS transmits one IP packet to the UE on the DRB associated with the default EPS bearer context.	-	-	-	-
22D	Wait for 1 s after the IP packet has been transmitted in step 22C. (Note 1)	-	-	-	-
22E	The SS releases the RRC connection.	-	-	-	-
23	Set the cell type of Cell A to the "non-Suitable cell". Set the cell type of Cell B to the "Serving cell".	-	-	-	-
-	The following messages are to be observed on Cell B unless explicitly stated otherwise.	-	-	-	-
24	The UE transmits a TRACKING AREA UPDATE REQUEST message with the EPS update type value set to 'TA updating' or 'combined TA/LA updating'.	-->	TRACKING AREA UPDATE REQUEST	-	-
24A	Wait for 15s after step 24 to ensure that T3430 expires.	-	-	-	-
25	The SS releases the RRC connection. NOTE: The tracking area updating attempt counter is 1.	-	-	-	-
26	Void	-	-	-	-
27	Check: Does the UE transmit a SERVICE REQUEST message within 5s?	-->	SERVICE REQUEST	3	F
28	Wait for 10s after step 25 to ensure that T3411 expires.	-	-	-	-

29	Check: Does the UE transmit a TRACKING AREA UPDATE REQUEST message with the EPS update type value set to 'TA updating' or 'combined TA/LA updating'?	-->	TRACKING AREA UPDATE REQUEST	4	P
30	The SS transmits a TRACKING AREA UPDATE ACCEPT message.	<--	TRACKING AREA UPDATE ACCEPT	-	-
-	EXCEPTION: Step 31 and Step 32a1 can occur in any order.	-	-	-	-
31	The UE transmits a TRACKING AREA UPDATE COMPLETE message. NOTE: The tracking area updating attempt counter is reset.	-->	TRACKING AREA UPDATE COMPLETE	-	-
-	EXCEPTION: Step 32a1 describes behaviour that depends on UE implementation; the "lower case letter" identifies a step sequence that takes place if the UE has user data pending.	-	-	-	-
32a1	IF the UE has user data pending THEN the UE loop backs the IP packet received in step 22C on the DRB associated with the default EPS bearer context on Cell B within 5s.	-	-	-	-
-	At the end of this test procedure sequence, the UE is in end state E-UTRA connected (E2_T3440) according to TS 36.508.	-	-	-	-
Note 1: The 1 second delay is used to secure that the UE have received and forwarded the IP Packet transmitted by the SS in step 22C to the UE test loop function before the <i>RRConnectionRelease</i> message is sent by the SS in step 22E.					

9.2.3.1.23.3.3 Specific message contents

Table 9.2.3.1.23.3.3-0: ACTIVATE TEST MODE (step 8A, Table 9.2.3.1.23.3.2-1)

Derivation Path: 36.508, Table 4.7A-1, condition UE TEST LOOP MODE B

Table 9.2.3.1.23.3.3-1: Message ATTACH ACCEPT (step 9, Table 9.2.3.1.23.3.2-1)

Derivation Path: 36.508, Table 4.7.2-1			
Information Element	Value/remark	Comment	Condition
T3412 value		6 minutes	
Timer value	'0 0001'B		
Unit	'010'B	value is incremented in multiples of decihours	
GUTI	GUTI-1		

Table 9.2.3.1.23.3.3-2: Message TRACKING AREA UPDATE REQUEST (step 13, step 19Aa2 and step 20, Table 9.2.3.1.23.3.2-1)

Derivation Path: 36.508, Table 4.7.2-27			
Information Element	Value/remark	Comment	Condition
EPS update type			
EPS update type Value	'011'B	Periodic updating	
Old GUTI	GUTI-1		
Last visited registered TAI	TAI-1		

Table 9.2.3.1.23.3.3-3: Message TRACKING AREA UPDATE ACCEPT (step 21, Table 9.2.3.1.23.3.2-1)

Derivation Path: 36.508, Table 4.7.2-24			
Information Element	Value/remark	Comment	Condition
GUTI	Not present		
MS identity	Not present		

Table 9.2.3.1.23.3.3-3A: CLOSE UE TEST LOOP (step 22B, Table 9.2.3.1.23.3.2-1)

Derivation Path: 36.508, Table 4.7A-3, condition UE TEST LOOP MODE B			
Information Element	Value/remark	Comment	Condition
UE test loop mode B LB setup			
IP PDU delay	'0001 0100'B	20seconds	

Table 9.2.3.1.23.3.3-4: Message TRACKING AREA UPDATE REQUEST (step 24, Table 9.2.3.1.23.3.2-1)

Derivation Path: 36.508, Table 4.7.2-27			
Information Element	Value/remark	Comment	Condition
Old GUTI	GUTI-1		
Last visited registered TAI	TAI-1		

Table 9.2.3.1.23.3.3-5: Message TRACKING AREA UPDATE REQUEST (step 29, Table 9.2.3.1.23.3.2-1)

Derivation Path: 36.508, Table 4.7.2-27			
Information Element	Value/remark	Comment	Condition
EPS update type			
"Active" flag	Any allowed value	The UE may set this flag due to failing SERVICE REQUEST procedure.	
Old GUTI	GUTI-1		
Last visited registered TAI	TAI-1		

Table 9.2.3.1.23.3.3-6: Message TRACKING AREA UPDATE ACCEPT (step 30, Table 9.2.3.1.23.3.2-1)

Derivation Path: 36.508, Table 4.7.2-24			
Information Element	Value/remark	Comment	Condition
GUTI	GUTI-2		

9.2.3.1.24 Void

9.2.3.1.25 Normal tracking area update / Abnormal case / Failure after 5 attempts due to no network response

9.2.3.1.25.1 Test Purpose (TP)

(1)

```

with { UE has sent a TRACKING AREA UPDATE REQUEST message and has the tracking area updating attempt
counter set to four }
ensure that {
  when { UE detects release of the NAS signalling connection }
  then { UE starts timer T3402, sets the update status to EMM NOT UPDATED, changes to state EMM-
REGISTERED.ATTEMPTING-TO-UPDATE or optionally to EMM-REGISTERED.PLMN-SEARCH in order to perform a
PLMN selection }
}

```

9.2.3.1.25.2 Conformance requirements

References: The conformance requirements covered in the present TC are specified in: TS 24.301, clause 5.5.3.1 and 5.5.3.2.6.

[TS 24.301, clause 5.5.3.1]

A tracking area updating attempt counter is used to limit the number of subsequently rejected tracking area update attempts. The tracking area updating attempt counter shall be incremented as specified in subclause 5.5.3.2.6.

Depending on the value of the tracking area updating attempt counter, specific actions shall be performed. The tracking area updating attempt counter shall be reset when:

- an attach or combined attach procedure is successfully completed;
- a normal or periodic tracking area updating or a combined tracking area updating procedure is successfully completed; or
- a normal or periodic tracking area updating or a combined tracking area updating procedure is rejected with EMM cause #11, #12, #13, #14, #15 or #25.

Additionally the tracking area updating attempt counter shall be reset when the UE is in substate EMM-REGISTERED.ATTEMPTING-TO-UPDATE or EMM-REGISTERED.ATTEMPTING-TO-UPDATE-MM, and:

- a new tracking area is entered; or
- timer T3402 expires.

[TS 24.301, clause 5.5.3.2.6]

The following abnormal cases can be identified:

...

- b) Lower layer failure or release of the NAS signalling connection before the TRACKING AREA UPDATE ACCEPT or TRACKING AREA UPDATE REJECT message is received

The tracking area updating procedure shall be aborted, and the UE shall proceed as described below.

...

For the cases b, c, d, e, and f, the UE shall stop any ongoing transmission of user data.

For the cases b, c and d the UE shall proceed as follows:

Timer T3430 shall be stopped if still running. The tracking area updating attempt counter shall be incremented, unless it was already set to 5.

...

If the tracking area updating attempt counter is equal to 5:

- the UE shall start timer T3402, shall set the EPS update status to EU2 NOT UPDATED, shall delete the list of equivalent PLMNs and shall change to state EMM-REGISTERED.ATTEMPTING-TO-UPDATE or optionally to EMM-REGISTERED.PLMN-SEARCH in order to perform a PLMN selection according to 3GPP TS 23.122 [6].

If A/Gb mode or Iu mode is supported by the UE, the UE shall in addition handle the GPRS update status as specified in 3GPP TS 24.008 [13] for the abnormal case when a normal or periodic routing area updating procedure fails and the routing area updating attempt counter is equal to 5.

9.2.3.1.25.3 Test description

9.2.3.1.25.3.1 Pre-test conditions

System Simulator:

- cell A (belongs to TAI-1, PLMN1);
- cell B (belongs to TAI-2, PLMN1);
- cell C (belongs to TAI-7, PLMN2);

UE:

- the UE is configured to initiate EPS attach;

Preamble:

- the UE is in state Switched OFF (state 1) according to TS 36.508 [18].

9.2.3.1.25.3.2 Test procedure sequence

Table 9.2.3.1.25.3.2-1: Main behaviour

St	Procedure	Message Sequence		TP	Verdict
		U - S	Message		
1	Set the cell type of Cell A to the "Serving cell". Set the cell type of Cell B to the "non-Suitable cell". Set the cell type of Cell C to the "non-Suitable cell".	-	-	-	-
-	The following messages are to be observed on Cell A unless explicitly stated otherwise.	-	-	-	-
2	The UE is powered on or switched on.	-	-	-	-
3	The UE transmits an ATTACH REQUEST message. The PDN CONNECTIVITY REQUEST message is piggybacked in ATTACH REQUEST message.	-->	ATTACH REQUEST	-	-
4	The SS transmits an AUTHENTICATION REQUEST message to initiate the EPS authentication and AKA procedure.	<--	AUTHENTICATION REQUEST	-	-
5	The UE transmits an AUTHENTICATION RESPONSE message and establishes mutual authentication.	-->	AUTHENTICATION RESPONSE	-	-
6	The SS transmits a NAS SECURITY MODE COMMAND message to activate NAS security.	<--	SECURITY MODE COMMAND	-	-
7	The UE transmits a NAS SECURITY MODE COMPLETE message and establishes the initial security configuration.	-->	SECURITY MODE COMPLETE	-	-
-	EXCEPTION: Steps 8a1 to 8a2 describe behaviour that depends on UE configuration; the "lower case letter" identifies a step sequence that take place if the UE has ESM information which needs to be transferred after NAS SECURITY MODE COMPLETE message.	-	-	-	-
8a1	IF the UE sets the ESM information transfer flag in the last PDN CONNECTIVITY REQUEST message THEN the SS transmits an ESM INFORMATION REQUEST message to initiate exchange of protocol configuration options and/or APN.	<--	ESM INFORMATION REQUEST	-	-
8a2	The UE transmits an ESM INFORMATION RESPONSE message to transfer protocol configuration options and/or APN.	-->	ESM INFORMATION RESPONSE	-	-
9	SS responds with ATTACH ACCEPT message. The ACTIVATE DEFAULT EPS BEARER CONTEXT REQUEST message is piggybacked in ATTACH ACCEPT message	<--	ATTACH ACCEPT	-	-
-	EXCEPTION: In parallel to the event described in step 10 below the generic procedure for IP address allocation in the U-plane specified in TS 36.508 subclause 4.5A.1 takes place performing IP address allocation in the U-plane if requested by the UE.	-	-	-	-
10	The UE transmit an ATTACH COMPLETE message including an ACTIVATE DEFAULT EPS BEARER CONTEXT ACCEPT message. NOTE 1: The tracking area updating attempt counter is reset.	-->	ATTACH COMPLETE	-	-
11	The SS releases the RRC connection.	-	-	-	-
12	Wait for 6 min to ensure that T3412 expires.	-	-	-	-
13	The UE transmits a TRACKING AREA UPDATE REQUEST message with the EPS update type value set to 'Periodic updating'.	-->	TRACKING AREA UPDATE REQUEST	-	-
14	Wait for T3430 and T3411 (25s) expiry. NOTE 2: The tracking area updating attempt counter is 1.	-	-	-	-

15	The UE transmits a TRACKING AREA UPDATE REQUEST message with the EPS update type value set to 'Periodic updating'.	-->	TRACKING AREA UPDATE REQUEST	-	-
16	Wait for T3430 and T3411 (25s) expiry. NOTE 3: The tracking area updating attempt counter is 2.	-	-	-	-
17	The UE transmits a TRACKING AREA UPDATE REQUEST message with the EPS update type value set to 'Periodic updating'.	-->	TRACKING AREA UPDATE REQUEST	-	-
18	Wait for T3430 and T3411 (25s) expiry. NOTE 4: The tracking area updating attempt counter is 3.	-	-	-	-
19	The UE transmits a TRACKING AREA UPDATE REQUEST message with the EPS update type value set to 'Periodic updating'.	-->	TRACKING AREA UPDATE REQUEST	-	-
20	Wait for T3430 and T3411 (25s) expiry. NOTE 5: The tracking area updating attempt counter is 4.	-	-	-	-
21	The UE transmits a TRACKING AREA UPDATE REQUEST message with the EPS update type value set to 'Periodic updating'.	-->	TRACKING AREA UPDATE REQUEST	-	-
22	The SS releases the RRC connection. NOTE 6: The tracking area updating attempt counter is 5.	-	-	-	-
23	Wait for 12 min to ensure that T3402 expires.	-	-	-	-
24	Check: Does the UE transmit a TRACKING AREA UPDATE REQUEST message with the EPS update type value set to 'TA updating'? NOTE 7: The tracking area updating attempt counter is reset.	-->	TRACKING AREA UPDATE REQUEST	1	P
25	The SS transmits a TRACKING AREA UPDATE ACCEPT message.	<--	TRACKING AREA UPDATE ACCEPT	-	-
26	Set the cell type of Cell A to the "non-Suitable cell". Set the cell type of Cell B to the "Serving cell".	-	-	-	-
-	The following messages are to be observed on Cell B unless explicitly stated otherwise.	-	-	-	-
27	The UE transmits a TRACKING AREA UPDATE REQUEST message with the EPS update type value set to 'TA updating'. NOTE 8: The tracking area updating attempt counter is reset.	-->	TRACKING AREA UPDATE REQUEST	-	-
28	Wait for T3430 and T3411 (25s) expiry. NOTE 9: The tracking area updating attempt counter is 1.	-	-	-	-
29	The UE transmits a TRACKING AREA UPDATE REQUEST message with the EPS update type value set to 'TA updating'.	-->	TRACKING AREA UPDATE REQUEST	-	-
30	Wait for T3430 and T3411 (25s) expiry. NOTE 10: The tracking area updating attempt counter is 2.	-	-	-	-
31	The UE transmits a TRACKING AREA UPDATE REQUEST message with the EPS update type value set to 'TA updating'.	-->	TRACKING AREA UPDATE REQUEST	-	-
32	Wait for T3430 and T3411 (25s) expiry. NOTE 11: The tracking area updating attempt counter is 3.	-	-	-	-
33	The UE transmits a TRACKING AREA UPDATE REQUEST message with the EPS update type value set to 'TA updating'.	-->	TRACKING AREA UPDATE REQUEST	-	-
34	Wait for T3430 and T3411 (25s) expiry. NOTE 12: The tracking area updating attempt counter is 4.	-	-	-	-
35	The UE transmits a TRACKING AREA UPDATE REQUEST message with the EPS update type value set to 'TA updating'.	-->	TRACKING AREA UPDATE REQUEST	-	-
36	The SS releases the RRC connection.	-	-	-	-

	NOTE 13: The tracking area updating attempt counter is 5 and reset.				
37	Set the cell type of Cell B to the "non-Suitable cell". Set the cell type of Cell C to the "Serving cell".	-	-	-	-
-	The following messages are to be observed on Cell C unless explicitly stated otherwise.	-	-	-	-
38	Check: Does the UE transmit a TRACKING AREA UPDATE REQUEST message with the EPS update type value set to 'TA updating'?	-->	TRACKING AREA UPDATE REQUEST	1	P
39	The SS transmits a TRACKING AREA UPDATE ACCEPT message.	<--	TRACKING AREA UPDATE ACCEPT	-	-
40	The UE transmits a TRACKING AREA UPDATE COMPLETE message.	-->	TRACKING AREA UPDATE COMPLETE	-	-
-	At the end of this test procedure sequence, the UE is in end state E-UTRA connected (E2_T3440) according to TS 36.508.	-	-	-	-

9.2.3.1.25.3.3 Specific message contents

Table 9.2.3.1.25.3.3-1: Message ATTACH ACCEPT (step 9, Table 9.2.3.1.25.3.2-1)

Derivation Path: 36.508, Table 4.7.2-1			
Information Element	Value/remark	Comment	Condition
T3412 value		6 minutes	
Timer value	'0 0001'B		
Unit	'010'B	value is incremented in multiples of decihours	
GUTI	GUTI-1		

Table 9.2.3.1.25.3.3-2: Message TRACKING AREA UPDATE REQUEST (step 13, step 15, step 17, step 19 and step 21, Table 9.2.3.1.25.3.2-1)

Derivation Path: 36.508, Table 4.7.2-27			
Information Element	Value/remark	Comment	Condition
EPS update type			
EPS update type Value	'011'B	Periodic updating	
Old GUTI	GUTI-1		
Last visited registered TAI	TAI-1		

Table 9.2.3.1.25.3.3-3: Message TRACKING AREA UPDATE REQUEST (step 24, step 27, step 29, step 31, step 33, step 35 and step 38, Table 9.2.3.1.25.3.2-1)

Derivation Path: 36.508, Table 4.7.2-27			
Information Element	Value/remark	Comment	Condition
EPS update type			
EPS update type value	'000'B	TA updating	
Old GUTI	GUTI-1		
Last visited registered TAI	TAI-1		

Table 9.2.3.1.25.3.3-4: Message TRACKING AREA UPDATE ACCEPT (step 25, Table 9.2.3.1.25.3.2-1)

Derivation Path: 36.508, Table 4.7.2-24			
Information Element	Value/remark	Comment	Condition
GUTI	Not present		

Table 9.2.3.1.25.3.3-5: Message TRACKING AREA UPDATE ACCEPT (step 39, Table 9.2.3.1.25.3.2-1)

Derivation Path: 36.508, Table 4.7.2-24			
Information Element	Value/remark	Comment	Condition
GUTI	GUTI-3		

9.2.3.1.26 Normal tracking area update / Abnormal case / TRACKING AREA UPDATE REJECT

9.2.3.1.26.1 Test Purpose (TP)

(1)

```
with { UE has sent a TRACKING AREA UPDATE REQUEST message}
ensure that {
  when { UE receives a TRACKING AREA UPDATE REJECT message with reject cause #95"semantically
incorrect message" }
  then { the UE sets the tracking area updating attempt counter to 5, starts timer T3402, and
performs tracking area updating on the expiry of timers T3402}
```

(2)

```
with { UE has sent a TRACKING AREA UPDATE REQUEST message}
ensure that {
  when { UE receives a TRACKING AREA UPDATE REJECT message with reject cause #96" invalid mandatory
information" }
  then { the UE sets the tracking area updating attempt counter to 5, starts timer T3402, and
performs tracking area updating on the expiry of timers T3402}
```

(3)

```
with { UE has sent a TRACKING AREA UPDATE REQUEST message}
ensure that {
  when { UE receives a TRACKING AREA UPDATE REJECT message with reject cause #97"message type non-
existent or not implemented" }
  then { the UE sets the tracking area updating attempt counter to 5, starts timer T3402, and
performs tracking area updating on the expiry of timers T3402}
```

(4)

```
with { UE has sent a TRACKING AREA UPDATE REQUEST message}
ensure that {
  when { UE receives a TRACKING AREA UPDATE REJECT message with reject cause #99"information element
non-existent or not implemented" }
  then { the UE sets the tracking area updating attempt counter to 5, starts timer T3402, and
performs tracking area updating on the expiry of timers T3402}
```

(5)

```
with { UE has sent a TRACKING AREA UPDATE REQUEST message}
ensure that {
  when { UE receives a TRACKING AREA UPDATE REJECT message with reject cause #111"protocol error,
unspecified" }
  then { the UE sets the tracking area updating attempt counter to 5, starts timer T3402, and
performs tracking area updating on the expiry of timers T3402}
```

9.2.3.1.26.2 Conformance requirements

References: The conformance requirements covered in the present TC are specified in: 3GPP TS 24.301 clauses 5.5.3.2.6.

[TS24.301 clause5.5.3.2.6]

...

d) TRACKING AREA UPDATE REJECT, other causes than those treated in subclause 5.5.3.2.5

Upon reception of the EMM causes #95, #96, #97, #99 and #111 the UE should set the tracking area updating attempt counter to 5. The UE shall proceed as described below.

If the tracking area updating attempt counter is equal to 5:

- the UE shall start timer T3402, shall set the EPS update status to EU2 NOT UPDATED, shall delete the list of equivalent PLMNs and shall change to state EMM-REGISTERED.ATTEMPTING-TO-UPDATE or optionally to EMM-REGISTERED.PLMN-SEARCH in order to perform a PLMN selection according to 3GPP TS 23.122 [6].

9.2.3.1.26.3 Test description

9.2.3.1.26.3.1 Pre-test conditions

System Simulator:

- cell A.

UE:

- the UE is configured to initiate EPS attach.

Preamble:

- the UE is in state Registered, Idle Mode (state 2) on cell A according to TS 36.508 [18] except for those shown in table 9.2.3.1.26.3.3-6;

9.2.3.1.26.3.2 Test procedure sequence

Table 9.2.3.1.26.3.2-1: Main behaviour

St	Procedure	Message Sequence		TP	Verdict
		U – S	Message		
1	The SS waits for T3412 to elapse.	-	-	-	-
2	The UE transmits a TRACKING AREA UPDATE REQUEST on Cell A.	-->	TRACKING AREA UPDATE REQUEST	-	-
3	The SS transmits a TRACKING AREA UPDATE REJECT message with EMM cause #95"semantically incorrect message" as specified.(Note)	<--	TRACKING AREA UPDATE REJECT	-	-
4	The SS releases the RRC connection.	-	-	-	-
5	Check: When the timer T3402 expires does the UE re-transmit TRACKING AREA UPDATE REQUEST message on cell A?	-->	TRACKING AREA UPDATE REQUEST	1	P
6	The SS transmits a TRACKING AREA UPDATE ACCEPT message.	<--	TRACKING AREA UPDATE ACCEPT	-	-
7	The UE transmits a TRACKING AREA UPDATE COMPLETE message.	-->	TRACKING AREA UPDATE COMPLETE	-	-
7A	The SS releases the RRC connection.	-	-	-	-
8	The SS waits for T3412 to elapse.	-	-	-	-
9	The UE transmits a TRACKING AREA UPDATE REQUEST on Cell A.	-->	TRACKING AREA UPDATE REQUEST	-	-
10	The SS transmits a TRACKING AREA UPDATE REJECT message with EMM cause #96" invalid mandatory information" as specified. (Note)	<--	TRACKING AREA UPDATE REJECT	-	-
11	The SS releases the RRC connection.	-	-	-	-
12	Check: When the timer T3402 expires does the UE re-transmit TRACKING AREA UPDATE REQUEST message on cell A?	-->	TRACKING AREA UPDATE REQUEST	2	P
13	The SS transmits a TRACKING AREA UPDATE ACCEPT message.	<--	TRACKING AREA UPDATE ACCEPT	-	-
14	The UE transmits a TRACKING AREA UPDATE COMPLETE message.	-->	TRACKING AREA UPDATE COMPLETE	-	-
14A	The SS releases the RRC connection.	-	-	-	-
15	The SS waits for T3412 to elapse	-	-	-	-
16	The UE transmits a TRACKING AREA UPDATE REQUEST on Cell A.	-->	TRACKING AREA UPDATE REQUEST	-	-
17	The SS transmits a TRACKING AREA UPDATE REJECT message with EMM cause #97"message type non-existent or not implemented".(Note)	<--	TRACKING AREA UPDATE REJECT	-	-
18	The SS releases the RRC connection.	-	-	-	-
19	Check: When the timer T3402 expires does the UE re-transmit TRACKING AREA UPDATE REQUEST message on cell A?	-->	TRACKING AREA UPDATE REQUEST	3	P
20	The SS transmits a TRACKING AREA UPDATE ACCEPT message.	<--	TRACKING AREA UPDATE ACCEPT	-	-
21	The UE transmits a TRACKING AREA UPDATE COMPLETE message.	-->	TRACKING AREA UPDATE COMPLETE	-	-
21A	The SS releases the RRC connection.	-	-	-	-
22	The SS waits for T3412 to elapse.	-	-	-	-
23	The UE transmits a TRACKING AREA UPDATE REQUEST on Cell A.	-->	TRACKING AREA UPDATE REQUEST	-	-
24	The SS transmits a TRACKING AREA UPDATE REJECT message with EMM cause #99"information element non-existent or not implemented" as specified. (Note)	<--	TRACKING AREA UPDATE REJECT	-	-
25	The SS releases the RRC connection.	-	-	-	-
26	Check: When the timer T3402 expires does the UE re-transmit TRACKING AREA UPDATE REQUEST message on cell A?	-->	TRACKING AREA UPDATE REQUEST	4	P

27	The SS transmits a TRACKING AREA UPDATE ACCEPT message.	<--	TRACKING AREA UPDATE ACCEPT	-	-
28	The UE transmits a TRACKING AREA UPDATE COMPLETE message.	-->	TRACKING AREA UPDATE COMPLETE	-	-
28A	The SS releases the RRC connection.	-	-	-	-
29	The SS waits for T3412 to elapse.	-	-	-	-
30	The UE transmits a TRACKING AREA UPDATE REQUEST on Cell A.	-->	TRACKING AREA UPDATE REQUEST	-	-
31	The SS transmits a TRACKING AREA UPDATE REJECT message with EMM cause #111"protocol error, unspecified" as specified. (Note)	<--	TRACKING AREA UPDATE REJECT	-	-
32	The SS releases the RRC connection.	-	-	-	-
33	Check: When the timer T3402 expires does the UE re-transmit TRACKING AREA UPDATE REQUEST message on cell A?	-->	TRACKING AREA UPDATE REQUEST	5	P
34	The SS transmits a TRACKING AREA UPDATE ACCEPT message.	<--	TRACKING AREA UPDATE ACCEPT	-	-
35	the UE transmit a TRACKING AREA UPDATE COMPLETE message.	-->	TRACKING AREA UPDATE COMPLETE	-	-
-	At the end of this test procedure sequence, the UE is in end state E-UTRA connected (E2_T3440) according to TS 36.508.	-	-	-	-
Note: Upon reception of TRACKING AREA UPDATE REJECT message with EMM causes #95, #96, #97, #99 and #111, timer T3402 shall be started.					

9.2.3.1.26.3.3 Specific message contents

Table 9.2.3.1.26.3.3-1: Message TRACKING AREA UPDATE REJECT (step 3, Table 9.2.3.1.26.3.2-1)

Derivation path: 36.508 table 4.7.2-24			
Information Element	Value/Remark	Comment	Condition
EMM cause	01011111	#95 "semantically incorrect message "	

Table 9.2.3.1.26.3.3-2: Message TRACKING AREA UPDATE REJECT (step 10, Table 9.2.3.1.26.3.2-1)

Derivation path: 36.508 table 4.7.2-24			
Information Element	Value/Remark	Comment	Condition
EMM cause	01100000	#96 " invalid mandatory information "	

Table 9.2.3.1.26.3.3-3: Message TRACKING AREA UPDATE REJECT (step 17, Table 9.2.3.1.26.3.2-1)

Derivation path: 36.508 table 4.7.2-24			
Information Element	Value/Remark	Comment	Condition
EMM cause	01100001	#97 " message type non-existent or not implemented "	

Table 9.2.3.1.26.3.3-4: Message TRACKING AREA UPDATE REJECT (step 24, Table 9.2.3.1.26.3.2-1)

Derivation path: 36.508 table 4.7.2-24			
Information Element	Value/Remark	Comment	Condition
EMM cause	01100011	#99 " information element non-existent or not implemented "	

Table 9.2.3.1.26.3.3-5: Message TRACKING AREA UPDATE REJECT (step 31, Table 9.2.3.1.26.3.2-1)

Derivation path: 36.508 table 4.7.2-24			
Information Element	Value/Remark	Comment	Condition
EMM cause	01101111	#111 " protocol error, unspecified "	

Table 9.2.3.1.26.3.3-6: Message ATTACH ACCEPT (For the UE registration procedure in TS 36.508 clause 4.5.2.3)

Derivation path: 36.508 table 4.7.2-1			
Information Element	Value/Remark	Comment	Condition
T3412 value		1 minute	
Timer value	'00001'B		
Unit	'001'B		
T3402 value		30 seconds	
Timer value	'01111'B		
Unit	'000'B		

Table 9.2.3.1.26.3.3-7: Message TRACKING AREA UPDATE ACCEPT (steps 6,13,20,27,34, Table 9.2.3.1.26.3.2-1)

Derivation path: 36.508 table 4.7.2-1			
Information Element	Value/Remark	Comment	Condition
T3412 value		1 minute	
Timer value	'00001'B		
Unit	'001'B		
T3402 value		30 seconds	
Timer value	'01111'B		
Unit	'000'B		

Table 9.2.3.1.26.3.3-8: Message TRACKING AREA UPDATE REQUEST (steps 2,9,16,23,30 Table 9.2.3.1.26.3.2-1)

Derivation Path: 36.508, Table 4.7.2-27			
Information Element	Value/remark	Comment	Condition
EPS update type			
EPS update type Value	'011'B	Periodic updating	

9.2.3.1.27 Normal tracking area update / Abnormal case / Change of cell into a new tracking area

9.2.3.1.27.1 Test Purpose (TP)

(1)

```
with { UE has sent a TRACKING AREA UPDATE REQUEST message}
ensure that {
  when { cell change into a new tracking area occurs before the tracking area updating procedure is completed }
  then { UE aborts the tracking area updating procedure and re-initiates it in the new tracking area immediately }
}
```

9.2.3.1.27.2 Conformance requirements

References: The conformance requirements covered in the present TC are specified in: 3GPP TS 24.301 clauses 5.5.3.2.6, and 5.5.3.3.6.

[TS 24.301 clause 5.5.3.2.6]

The following abnormal cases can be identified:

...

e) Change of cell into a new tracking area

If a cell change into a new tracking area occurs before the tracking area updating procedure is completed, the tracking area updating procedure shall be aborted and re-initiated immediately. The UE shall set the EPS update status to EU2 NOT UPDATED.

[TS 24.301 clause 5.5.3.3.6]

The UE shall proceed as follows:

...

- otherwise, the abnormal cases specified in subclause 5.5.3.2.6 apply with the following modification.

If the tracking area updating attempt counter is incremented according to subclause 5.5.3.2.6 the next actions depend on the value of the tracking area updating attempt counter.

9.2.3.1.27.3 Test description

9.2.3.1.27.3.1 Pre-test conditions

System Simulator:

- cell A, cell B.

UE:

None.

Preamble:

- the UE is in state Registered, Idle Mode (state 2) on cell A according to 36.508 [18].

9.2.3.1.27.3.2 Test procedure sequence

Table 9.2.3.1.27.3.2-1: Main behaviour

St	Procedure	Message Sequence		TP	Verdict
		U - S	Message		
1	Set the cell type of cell A to the "Non-Suitable cell". Set the cell type of cell B to the "Serving cell".	-	-	-	-
2	The UE transmits a TRACKING AREA UPDATE REQUEST on Cell B (Note 1).	-->	TRACKING AREA UPDATE REQUEST	-	-
3	SS does not send TRACKING AREA UPDATE ACCEPT to the UE and update TAC value in <i>SystemInformationBlockType1</i> .	-	-	-	-
4	The SS transmits a <i>Paging</i> message paging occasion including a <i>systemInfoModification</i> .	<--	<i>Paging</i>	-	-
5	From the beginning of the next modification period the SS transmits a modified <i>SystemInformationBlockType1</i> as specified.	-	-	-	-
6	Check: Does the UE transmit TRACKING AREA UPDATE REQUEST message on cell B in the next 12 seconds? Note: Wait time is more than 2.1* modification period for the UE to receive system information and inferior to T3430.	-->	TRACKING AREA UPDATE REQUEST	1	P
7	SS responds with TRACKING AREA UPDATE ACCEPT message	<--	TRACKING AREA UPDATE ACCEPT	-	-
8	UE sends TRACKING AREA UPDATE COMPLETE	-->	TRACKING AREA UPDATE COMPLETE	-	-
-	At the end of this test procedure sequence, the UE is in end state E-UTRA connected (E2_T3440) according to TS 36.508.	-	-	-	-
Note 1: Any type of tracking area update is acceptable.					

9.2.3.1.27.3.3 Specific message contents

Table 9.2.3.1.27.3.3-1: Message TRACKING AREA UPDATE REQUEST (step 2, step 6, Table 9.2.3.1.27.3.2-1)

Derivation path: 36.508 table 4.7.2-27			
Information Element	Value/Remark	Comment	Condition
Old GUTI	GUTI-1		
Last visited registered TAI	TAI-1		

Table 9.2.3.1.27.3.3-2: Message TRACKING AREA UPDATE ACCEPT (step 7, 9.2.3.1.27.3.2-1)

Derivation path: 36.508 table 4.7.2-24			
Information Element	Value/Remark	Comment	Condition
GUTI	GUTI-3		
TAI list			
Length of tracking area identity list contents	'00000110'B		
Partial tracking area identity list			
Number of elements	'00000'B		
Type of list	'00'B	"list of TACs belonging to one PLMN, with non-consecutive TAC values"	
MCC MNC TAC 1	TAC =4	"PLMN is set to the same MCC/MNC stored in EF _{IMSI} " "TAI-4"	

Table 9.2.3.1.27.3.3-3: SystemInformationBlockType1 for Cell B (From step 3 in Table 9.2.3.1.27.3.2-1)

Derivation Path: 36.508 clause 4.4.3.2-3			
Information Element	Value/remark	Comment	Condition
SystemInformationBlockType1 ::= SEQUENCE {			
cellAccessRelatedInfo SEQUENCE {			
trackingAreaCode	TAC =4		
}			
}			
}			

Table 9.2.3.1.27.3.3-4: Paging (step 4, Table 9.2.3.1.27.3.2-1)

Derivation Path: 36.508 Table 4.6.1-7			
Information Element	Value/remark	Comment	Condition
Paging ::= SEQUENCE {			
pagingRecordList	Not present		
systemInfoModification	true		
}			

9.2.3.1.28 Normal tracking area update / Abnormal case / Tracking area updating and detach procedure collision

9.2.3.1.28.1 Test Purpose (TP)

(1)

```
with { UE has sent a TRACKING AREA UPDATE REQUEST message}
ensure that {
    when { UE receives a DETACH REQUEST message before the tracking area updating procedure has been completed }
    then { the tracking area updating procedure shall be aborted and the detach procedure shall be progressed }
}
```

9.2.3.1.28.2 Conformance requirements

References: The conformance requirements covered in the present TC are specified in: 3GPP TS 24.301 clauses 5.5.3.2.6 and 5.5.3.3.6.

[TS24.301 clause5.5.3.2.6]

The following abnormal cases can be identified:

...

f) Tracking area updating and detach procedure collision

If the UE receives a DETACH REQUEST message before the tracking area updating procedure has been completed, the tracking area updating procedure shall be aborted and the detach procedure shall be progressed.

[TS 24.301 clause 5.5.3.3.6]

The UE shall proceed as follows:

...

- otherwise, the abnormal cases specified in subclause 5.5.3.2.6 apply with the following modification.

If the tracking area updating attempt counter is incremented according to subclause 5.5.3.2.6 the next actions depend on the value of the tracking area updating attempt counter.

9.2.3.1.28.3 Test description

9.2.3.1.28.3.1 Pre-test conditions

System Simulator:

- cell A, cell B.
- System information combination 3 as defined in TS 36.508[18] clause 4.4.3.1 is used in E-UTRA cells.

UE:

None.

Preamble:

- the UE is in state Registered, Idle Mode (state 2) on Cell A according to 36.508 [18].

9.2.3.1.28.3.2 Test procedure sequence

Table 9.2.3.1.28.3.2-1: Main behaviour

St	Procedure	Message Sequence		TP	Verdict
		U - S	Message		
1	Set the cell type of cell A to the "Non-Suitable cell". Set the cell type of cell B to the "Serving cell".	-	-	-	-
2	The UE transmits a TRACKING AREA UPDATE REQUEST on Cell B (Note 1).	-->	TRACKING AREA UPDATE REQUEST	-	-
3	SS does not send TRACKING AREA UPDATE ACCEPT to the UE.	-	-	-	-
4	The SS transmits a DETACH REQUEST message with Detach type = 're-attach not required' on Cell B. Note: this message should be sent before timer T3430 expired.	<--	DETACH REQUEST	-	-
5	Check: Does the UE transmit a DETACH ACCEPT message on Cell B in the next 6 seconds? Note: the default value for timer T3422 is 6 seconds	-->	DETACH ACCEPT	1	P
6	The SS releases the RRC connection.	-	-	-	-
7	Check: Does the test result of CALL generic procedure "Test procedure for no response to paging (for NAS testing)" defined in clause 6.4.2.5 of TS36.508 indicates that the UE does not respond to paging when paged with S-TMSI1 and with CN domain indicator set to "PS" on Cell B?	-	-	1	-

Note 1: Any type of tracking area update is acceptable.

9.2.3.1.28.3.3 Specific message contents

Table 9.2.3.1.28.3.3-1: Message DETACH REQUEST (step 4, Table 9.2.3.1.28.3.2-1)

Derivation path: 36.508 table 4.7.2-12			
Information Element	Value/Remark	Comment	Condition
Detach type	'010'B	"re-attach not required"	
EMM cause	'00001100'B	"Tracking area not allowed"	

9.2.3.2 Combined tracking area updating

9.2.3.2.1 Combined tracking area update / Successful

9.2.3.2.1.1 Test Purpose (TP)

(1)

```
with { a combined EPS/IMSI attached UE in state EMM-REGISTERED and EMM-IDLE mode}
ensure that {
  when { UE enters a tracking area included in the TAI list }
  then { UE does not transmit a TRACKING AREA UPDATE REQUEST message }
}
```

(2)

```
with { a combined EPS/IMSI attached UE in state EMM-REGISTERED and EMM-IDLE mode}
ensure that {
  when { UE enters a tracking area not included in the TAI list }
  then { UE transmits a TRACKING AREA UPDATE REQUEST message with "EPS update type = combined TA/LA updating" }
}
```

(3)

```
with { UE has sent a combined TRACKING AREA UPDATE REQUEST message }
ensure that {
  when { UE receives a TRACKING AREA UPDATE ACCEPT message containing a GUTI and/or a mobile identity }
  then { UE transmits a TRACKING AREA UPDATE COMPLETE message and enters EMM-REGISTERED state }
}
```

9.2.3.2.1.2 Conformance requirements

References: The conformance requirements covered in the present TC are specified in: TS 24.301, clauses 5.5.3.1, 5.5.3.2.2, 5.5.3.2.4, 5.5.3.3.1, 5.5.3.3.2, 5.5.3.3.4.1 and 5.5.3.3.4.2.

[TS24.301 clause 5.5.3.1]

The tracking area updating procedure is always initiated by the UE and is used for the following purposes:

- ...- combined tracking area updating to update the registration of the actual tracking area for a UE in CS/PS mode 1 or CS/PS mode 2 of operation;

...

[TS24.301 clause 5.5.3.2.2]

The UE in state EMM-REGISTERED shall initiate the tracking area updating procedure by sending a TRACKING AREA UPDATE REQUEST message to the MME,

- a) when the UE detects entering a tracking area that is not in the list of tracking areas that the UE previously registered in the MME;

...

After sending the TRACKING AREA UPDATE REQUEST message to the MME, the UE shall start timer T3430 and enter state EMM-TRACKING-AREA-UPDATING-INITIATED (see example in figure 5.5.3.2.2). If timer T3402 is currently running, the UE shall stop timer T3402. If timer T3411 is currently running, the UE shall stop timer T3411. If timer T3442 is currently running, the UE shall stop timer T3442.

...

If the UE supports A/Gb mode or Iu mode, the UE shall handle the Old GUTI IE as follows:

...

- If the TIN indicates "GUTI" or "RAT-related TMSI" and the UE holds a valid GUTI, the UE shall indicate the GUTI in the Old GUTI IE.

...

If a UE has uplink user data pending when it initiates the tracking area updating procedure, or uplink signalling not related to the tracking area updating procedure, it may also set an "active" flag in the TRACKING AREA UPDATE REQUEST message to indicate the request to establish the user plane to the network and to keep the NAS signalling connection after the completion of the tracking area updating procedure.

If the UE has a current EPS security context, the UE shall include the eKSI (either KSI_{ASME} or KSI_{SGSN}) in the NAS Key Set Identifier IE in the TRACKING AREA UPDATE REQUEST message. Otherwise, the UE shall set the NAS Key Set Identifier IE to the value "no key is available". If the UE has a current EPS security context, the UE shall integrity protect the TRACKING AREA UPDATE REQUEST message with the current EPS security context. Otherwise the UE shall not integrity protect the TRACKING AREA UPDATE REQUEST message.

...

When the tracking area updating procedure is initiated in EMM-IDLE mode, the UE may also include an EPS bearer context status IE in the TRACKING AREA UPDATE REQUEST message, indicating which EPS bearer contexts are active in the UE.

...

[TS24.301 clause 5.5.3.2.4]

...

Upon receiving a TRACKING AREA UPDATE ACCEPT message, the UE shall stop timer T3430, reset the routing area updating attempt counter, enter state EMM-REGISTERED and set the EPS update status to EU1 UPDATED. If the message contains a GUTI, the UE shall use this GUTI as new temporary identity for EPS services and shall store the new GUTI. If no GUTI was included by the MME in the TRACKING AREA UPDATE ACCEPT message, the old GUTI shall be used. If the UE receives a new TAI list in the TRACKING AREA UPDATE ACCEPT message, the UE shall consider the new TAI list as valid and the old TAI list as invalid; otherwise, the UE shall consider the old TAI list as valid.

...

If the TRACKING AREA UPDATE ACCEPT message contained a GUTI, the UE shall return a TRACKING AREA UPDATE COMPLETE message to the MME to acknowledge the received GUTI.

...

[TS24.301 clause 5.5.3.3.1]

Within a combined tracking area updating procedure the messages TRACKING AREA UPDATE ACCEPT and TRACKING AREA UPDATE COMPLETE carry information for the tracking area updating and the location area updating.

The combined attach procedure basically follows the normal tracking area updating procedure described in subclause 5.5.3.2.

[TS24.301 clause 5.5.3.3.2]

...

To initiate a combined tracking area updating procedure the UE sends the message TRACKING AREA UPDATE REQUEST to the network, starts timer T3430 and changes to state EMM-TRACKING-AREA-UPDATING-INITIATED. The value of the EPS update type IE in the message shall indicate "combined TA/LA updating" unless explicitly specified otherwise.

The UE shall include the TMSI status IE if no valid TMSI is available. Furthermore, if the UE has stored a valid location area identification, the UE shall include it in the Old location area identification IE in the TRACKING AREA UPDATE REQUEST message.

[TS24.301 clause 5.5.3.3.4.1]

Depending on the value of the EPS update result IE received in the TRACKING AREA UPDATE ACCEPT message, two different cases can be distinguished:

- 1) The EPS update result IE value indicates "combined TA/LA updated": Tracking and location area updating is successful;

...

A TRACKING AREA UPDATE COMPLETE message shall be returned to the network if the TRACKING AREA UPDATE ACCEPT message contains a GUTI and/or a mobile identity.

[TS24.301 clause 5.5.3.3.4.2]

The description for normal tracking area update as specified in subclause 5.5.3.2.4 shall be followed. In addition, the following description for location area updating applies.

The TMSI reallocation may be part of the combined tracking area updating procedure. The TMSI allocated is then included in the TRACKING AREA UPDATE ACCEPT message together with the location area identification (LAI). In this case the MME shall change to state EMM-COMMON-PROCEDURE-INITIATED and shall start the timer T3450 as described in subclause 5.4.1. The LAI may be included in the TRACKING AREA UPDATE ACCEPT message without TMSI.

The UE, receiving a TRACKING AREA UPDATE ACCEPT message, stores the received location area identification, resets the location update attempt counter, sets the update status to U1 UPDATED and enters MM state MM IDLE.

...

How to handle the old TMSI stored in the UE depends on the mobile identity included in the TRACKING AREA UPDATE ACCEPT message.

- If the TRACKING AREA UPDATE ACCEPT message contains an IMSI, the UE is not allocated any TMSI, and shall delete any old TMSI accordingly.
- If the TRACKING AREA UPDATE ACCEPT message contains a TMSI, the UE shall use this TMSI as new temporary identity. The UE shall delete its old TMSI and shall store the new TMSI. In this case, a TRACKING AREA UPDATE COMPLETE message is returned to the network to confirm the received TMSI.
- If neither a TMSI nor an IMSI has been included by the network in the TRACKING AREA UPDATE ACCEPT message, the old TMSI, if any is available, shall be kept.

...

9.2.3.2.1.3 Test description

9.2.3.2.1.3.1 Pre-test conditions

System Simulator:

- cell A, cell C and cell D (HPLMN, different TAs);
- at most 2 cells are active simultaneously.
- System information combination 3 as defined in TS 36.508[18] clause 4.4.3.1 is used in E-UTRA cells.

UE:

- the UE is configured to initiate combined EPS/IMSI attach.

Preamble:

- the UE is in state Registered, Idle Mode (state 2) on cell A according to TS 36.508 [18].

9.2.3.2.1.3.2 Test procedure sequence

Table 9.2.3.2.1.3.2-1: Main Behaviour

St	Procedure	Message Sequence		TP	Verdict
		U - S	Message		
	The following messages are sent and shall be received on cell C.	-	-	-	-
1-13	Void	-	-	-	-
14	Set the cell type of cell A to the "non-Suitable neighbour cell ". Set the cell type of cell C to the " Serving cell"	-	-	-	-
15	Check: Does the UE transmit a combined TRACKING AREA UPDATE REQUEST message as specified?	-->	TRACKING AREA UPDATE REQUEST	2	P
16	The SS sends TRACKING AREA UPDATE ACCEPT message including GUTI, TMSI and LAI. The TAI list includes TAI for cell C and cell D.	<--	TRACKING AREA UPDATE ACCEPT	-	-
17	Check: Does the UE transmit a TRACKING AREA UPDATE COMPLETE message?	-->	TRACKING AREA UPDATE COMPLETE	2,3	P
18	The SS releases the RRC connection.	-	-	-	-
19	Check: Does the test results of generic procedure in TS 36.508 [18] subclause 6.4.2.4 indicate that the UE is in E-UTRA EMM-REGISTERED state on cell C with PagingUE-Identity = S-TMSI2?	-	-	2	-
	The following messages are sent and shall be received on cell D.	-	-	-	-
20	Set the cell type of cell A to the "non-Suitable off cell ". Set the cell type of cell C to the "Suitable neighbour cell". Set the cell type of cell D to the " Serving cell"	-	-	-	P
20 A	Check: Does the UE transmit a TRACKING AREA UPDATE REQUEST message in the next 30 seconds?	-->	TRACKING AREA UPDATE REQUEST	1	F
20 B	Check: Does the test results of generic procedure in TS 36.508 [18] subclause 6.4.2.4 indicate that the UE is in E-UTRA EMM-REGISTERED state on cell D with PagingUE-Identity = S-TMSI2?	-	-	1	
20 C	Set the cell type of cell A to the "Serving cell". Set the cell type of cell C to the "Non-suitable off cell". Set the cell type of cell D to the "Suitable neighbour cell".				
	The following messages are sent and shall be received on cell A.				
21	Check: Does the UE transmit a combined TRACKING AREA UPDATE REQUEST message?	-->	TRACKING AREA UPDATE REQUEST	2	P
22	The SS sends TRACKING AREA UPDATE ACCEPT message. Note: GUTI not present and MS identity present	<--	TRACKING AREA UPDATE ACCEPT	-	-
23	Check: Does the UE send TRACKING AREA UPDATE COMPLETE message?	-->	TRACKING AREA UPDATE COMPLETE	2,3	P
-	At the end of this test procedure sequence, the UE is in end state E-UTRA connected (E2_T3440) according to TS 36.508.	-	-	-	-

NOTE 1: It is assumed in the test procedure sequence that the UE initially has a valid GUTI.

NOTE 2: NAS security procedures are not checked in this TC.

9.2.3.2.1.3.3 Specific message contents

Table 9.2.3.2.1.3.3-1: Message TRACKING AREA UPDATE REQUEST (step 15, Table 9.2.3.2.1.3.2-1)

Derivation path: 36.508 table 4.7.2-27			
Information Element	Value/Remark	Comment	Condition
NAS key set identifier	KSI sent during the test case preamble in step 7.		
TSC	'0'B	native security context (for KSI _{ASME})	
Old GUTI	GUTI-1	GUTI-1 was allocated in cell A during the preamble	
Last visited registered TAI	TAI-1	TAI of cell A	
Old location area identification	LAI-1	LAI received in the ATTACH ACCEPT message in the preamble	
TMSI status	Not Present	Valid TMSI available	

Table 9.2.3.2.1.3.3-2: Message TRACKING AREA UPDATE ACCEPT (step 16, Table 9.2.3.2.1.3.2-1)

Derivation path: 36.508 table 4.7.2-24			
Information Element	Value/Remark	Comment	Condition
GUTI	GUTI-2		
TAI list			
Length of tracking area identity list contents	'00001000'B	8 octets	
Type of list	'00'B	"list of TACs belonging to one PLMN, with non-consecutive TAC values"	
Number of elements	'00001' B	2 elements	
Partial tracking area identity list	PLMN = MCC/MNC stored in EF _{IMSI} TAC 1 = 3 TAC 2 = 4	TAI-3 and TAI-4	

Table 9.2.3.2.1.3.3-3: Message TRACKING AREA UPDATE REQUEST (step 21, Table 9.2.3.2.1.3.2-1)

Derivation path: 36.508 table 4.7.2-27			
Information Element	Value/Remark	Comment	Condition
Old GUTI	GUTI-2		
Last visited registered TAI	TAI-4		
Old location area identification	LAI-2		
TMSI status	Not present	Valid TMSI available	

Table 9.2.3.2.1.3.3-4: Message TRACKING AREA UPDATE ACCEPT (step 22, Table 9.2.3.2.1.3.2-1)

Derivation path: 36.508 table 4.7.2-24			
Information Element	Value/Remark	Comment	Condition
GUTI	Not present	The SS doesn't assign a new GUTI	
TAI list			
Length of tracking area identity list contents	'00000110'B	6 octets	
Type of list	'00'B	One PLMN with non-consecutive TACs	
Number of elements	'00000'B	1 element	
Partial tracking area identity list	PLMN = MCC/MNC stored in EF _{IMSI} TAC 1 = TAC-1	TAI-1	
LAI	LAI-1		
MS identity	TMSI-3	SS provides a new TMSI	

9.2.3.2.1a Combined tracking area update / Successful / Check of last visited TAI and handling of TAI list, LAI and TMSI

9.2.3.2.1a.1 Test Purpose (TP)

(1)

```
with { a combined EPS/IMSI attached UE has sent a combined TRACKING AREA UPDATE REQUEST message with
EPS update type set to 'Combined TA/LA updating', including a last visited registered TAI }
ensure that {
  when { the UE receives a TRACKING AREA UPDATE ACCEPT message containing a new TAI list, a location
area information(LAI) and a TMSI as the mobile identity }
  then { the UE shall delete its old TMSI and shall store the new TMSI and transmits a TRACKING
AREA UPDATE COMPLETE message and enters EMM-REGISTERED state }
}
```

(2)

Void

(3)

```
with { UE in state GMM-REGISTERED mode }
ensure that {
  when { the UE receives a Paging message including an ue-Identity set to an unmatched TMSI i.e.
other than the one allocated to the UE at the UE registration procedure }
  then { the UE doesn't establish an RRC connection to answer the paging }
}
```

(4)

```
with { UE in state GMM-REGISTERED mode }
ensure that {
  when { the UE receives a Paging message including an ue-Identity set to the TMSI which was
allocated to the UE }
  then { the UE establishes an RRC connection to answer the paging and the TMSI and the location
area information(LAI) as Initial UE Identity are included in RRCConnectionRequest message }
}
```

(5)

```
with { a combined EPS/IMSI attached UE has sent a combined TRACKING AREA UPDATE REQUEST message with
EPS update type set to 'Combined TA/LA updating with IMSI attach ', including a last visited
registered TAI }
ensure that {
  when { the UE receives a TRACKING AREA UPDATE ACCEPT message containing a new TAI list, a location
area information(LAI) (Neither a TMSI nor an IMSI as the mobile identity is included) }
  then { the UE shall keep the old TMSI if any available and enters EMM-REGISTERED state }
}
```

(6)

Void

(7)

Void

(8)

```

with { a combined EPS/IMSI attached UE has sent a combined TRACKING AREA UPDATE REQUEST message with
EPS update type set to 'Combined TA/LA updating with IMSI attach ', including a last visited
registered TAI }
ensure that {
  when { the UE receives a TRACKING AREA UPDATE ACCEPT message containing a new TAI list, a location
area information(LAI) and an IMSI as the mobile identity }
  then { the UE shall delete any old TMSI and enters EMM-REGISTERED state }
}

```

(9)

Void

(10)

```

with { UE in state GMM-REGISTERED mode }
ensure that {
  when { the UE receives a Paging message including an ue-Identity set to a TMSI }
  then { the UE doesn't establish an RRC connection to answer the paging }
}

```

9.2.3.2.1a.2 Conformance requirements

References: The conformance requirements covered in the present TC are specified in: TS 24.301, clauses 5.5.3.3.1, 5.5.3.3.2, 5.5.3.3.4.1 and 5.5.3.3.4.2; TS 24.008, clause 4.4.1.

[TS24.301 clause 5.5.3.3.1]

Within a combined tracking area updating procedure the messages TRACKING AREA UPDATE ACCEPT and TRACKING AREA UPDATE COMPLETE carry information for the tracking area updating and the location area updating.

The combined tracking area updating procedure follows the normal tracking area updating procedure described in subclause 5.5.3.2.

[TS24.301 clause 5.5.3.3.2]

The UE operating in CS/PS mode 1 or CS/PS mode 2, in state EMM-REGISTERED, shall initiate the combined tracking area updating procedure:

- a) when the UE that is attached for both EPS and non-EPS services detects entering a tracking area that is not in the list of tracking areas that the UE previously registered in the MME;
- b) when the UE that is attached for EPS services wants to perform an attach for non-EPS services. In this case the EPS update type IE shall be set to "Combined TA/LA updating with IMSI attach";
- c) when the UE performs an intersystem change from A/Gb mode to S1 mode and the EPS services were previously suspended in A/Gb mode;
- d) when the UE performs an intersystem change from A/Gb or Iu mode to S1 mode and the UE previously performed a location area update procedure in A/Gb or Iu mode, in order to re-establish the SGs association;
- e) when the UE enters EMM-REGISTERED.NORMAL-SERVICE and the UE's TIN indicates "P-TMSI";
- f) when the UE receives an indication from the lower layers that the RRC connection was released with cause "load balancing TAU required";
- g) when the UE deactivated EPS bearer context(s) locally while in EMM-REGISTERED.NO-CELL-AVAILABLE, and then returns to EMM-REGISTERED.NORMAL-SERVICE;
- h) when the UE changes the UE core network capability information or the UE specific DRX parameter or both;
- i) when the UE receives an indication of "RRC Connection failure" from the lower layers and has no user uplink data pending; or

- j) when the UE has selected a CSG cell whose CSG identity is not included in the UE's Allowed CSG list.

To initiate a combined tracking area updating procedure the UE sends the message TRACKING AREA UPDATE REQUEST to the network, starts timer T3430 and changes to state EMM-TRACKING-AREA-UPDATING-INITIATED. The value of the EPS update type IE in the message shall indicate "combined TA/LA updating" unless explicitly specified otherwise.

The UE shall include the TMSI status IE if no valid TMSI is available. Furthermore, if the UE has stored a valid location area identification, the UE shall include it in the Old location area identification IE in the TRACKING AREA UPDATE REQUEST message.

[TS24.301 clause 5.5.3.3.4.1]

Depending on the value of the EPS update result IE received in the TRACKING AREA UPDATE ACCEPT message, two different cases can be distinguished:

- 1) The EPS update result IE value indicates "combined TA/LA updated": Tracking and location area updating is successful;
- 2) The EPS update result IE value indicates "TA updated": Tracking area updating is successful, but location area updating is not successful.

A TRACKING AREA UPDATE COMPLETE message shall be returned to the network if the TRACKING AREA UPDATE ACCEPT message contains a GUTI or a mobile identity or both.

[TS24.301 clause 5.5.3.3.4.2]

The description for normal tracking area update as specified in subclause 5.5.3.2.4 shall be followed. In addition, the following description for location area updating applies.

The TMSI reallocation may be part of the combined tracking area updating procedure. The TMSI allocated is then included in the TRACKING AREA UPDATE ACCEPT message together with the location area identification (LAI). In this case the MME shall change to state EMM-COMMON-PROCEDURE-INITIATED and shall start the timer T3450 as described in subclause 5.4.1. The LAI may be included in the TRACKING AREA UPDATE ACCEPT message without TMSI.

The UE, receiving a TRACKING AREA UPDATE ACCEPT message, stores the received location area identification, resets the location update attempt counter, sets the update status to U1 UPDATED and enters MM state MM IDLE.

How to handle the old TMSI stored in the UE depends on the mobile identity included in the TRACKING AREA UPDATE ACCEPT message.

- If the TRACKING AREA UPDATE ACCEPT message contains an IMSI, the UE is not allocated any TMSI, and shall delete any old TMSI accordingly.
- If the TRACKING AREA UPDATE ACCEPT message contains a TMSI, the UE shall use this TMSI as new temporary identity. The UE shall delete its old TMSI and shall store the new TMSI. In this case, a TRACKING AREA UPDATE COMPLETE message is returned to the network to confirm the received TMSI.
- If neither a TMSI nor an IMSI has been included by the network in the TRACKING AREA UPDATE ACCEPT message, the old TMSI, if any is available, shall be kept.

The network receiving a TRACKING AREA UPDATE COMPLETE message stops timer T3450, changes to state EMM-REGISTERED and considers the new TMSI as valid.

[TS 24.008 clause 4.4.1]

The location updating procedure is a general procedure which is used for the following purposes:

.....

- indicating to the network that the MS, configured to use CS fallback and SMS over SGs, or SMS over SGs only, has entered a GERAN or UTRAN cell in NMO II or III, after intersystem change from S1 mode to Iu or A/Gb mode, the TIN indicates "GUTI" and the location area of the current cell is the same as the stored location area;
or

NOTE 1: The location updating procedure can be delayed when the intersystem change is due to CS fallback. In this case, the MS has to remember that it has to perform a location updating procedure after the RR connection is released, if the MS is still in GERAN/UTRAN.

.....

The normal location updating procedure shall also be started if the MS is configured to use CS fallback and SMS over SGs, or SMS over SGs only, and the TIN indicates "RAT-related TMSI",

- when the periodic tracking area update timer T3412 expires and the network operates in network operation mode II or III; or
- when the MS enters a GERAN or UTRAN cell in network operation mode II or III and the E-UTRAN deactivate ISR timer T3423 is running.

NOTE 2: The timers T3412 and T3423 are specified in 3GPP TS 24.301 [120].

The normal location updating procedure shall also be started when the MS, configured to use CS fallback and SMS over SGs, or SMS over SGs only, enters a GERAN or UTRAN cell in network operation mode II or III and the E-UTRAN deactivate ISR timer T3423 has expired.

If the MS, configured to use CS fallback and SMS over SGs, enters a GERAN or UTRAN cell in network operation mode II or III, after intersystem change from S1 mode to Iu or A/Gb mode due to CS fallback, and the location area of the current cell is not available, the MS should initiate the location updating procedure.

.....

In the case that the mobile station is initiating an emergency call but, due to cell re-selection or redirection by the network, it moves to a different LAI then the mobile station may delay the location updating procedure in the new LA until after the emergency call is completed.

9.2.3.2.1a.3 Test description

9.2.3.2.1a.3.1 Pre-test conditions

System Simulator:

- cell A (belongs to TAI-1) is set to "Serving cell";
- cell B (belongs to TAI-2) is set to "Non-suitable cell";
- System information combination 9 as defined in TS 36.508[18] clause 4.4.3.1 is used in E-UTRA cells.
 - cell 5 (UTRA FDD or UTRA TDD, belongs to LAI-3) is set to "Non-suitable "off" cell".
 - cell 7 (UTRA FDD or UTRA TDD, as exception contains LAI-4) is set to "Non-suitable cell".
 - UTRAN is NOT using Gs interface. (NMO in System Information Block 1 indicates NMO II).

UE:

- the UE is configured to initiate combined EPS/IMSI attach.

Preamble:

- the UE is in state Registered, Idle mode (state 2) with condition CombinedAttach on Cell A according to [18].

9.2.3.2.1a.3.2 Test procedure sequence

Table 9.2.3.2.1a.3.2-1: Main behaviour

St	Procedure	Message Sequence		TP	Verdict
		U - S	Message		
-	The following messages are sent and shall be received on Cell B.	-	-	-	-
1	Set cell type of Cell A to the "non-Suitable cell" Set cell type of Cell B to the "Serving cell".	-	-	-	-
2	Check: Does the UE transmit a combined TRACKING AREA UPDATE REQUEST message with Last visited registered TAI set to TAI-1?	-->	TRACKING AREA UPDATE REQUEST	1	P
3	The SS sends TRACKING AREA UPDATE ACCEPT message including with LAI set to LAI-2, including a new TMSI (TMSI-2) as MS identity.	<--	TRACKING AREA UPDATE ACCEPT	-	-
4	Check: Does the UE send TRACKING AREA UPDATE COMPLETE message.	-->	TRACKING AREA UPDATE COMPLETE	1	P
5	The SS releases the RRC connection.	-	-	-	-
-	The following messages are sent and shall be received on Cell 7.	-	-	-	-
6	Set cell type of Cell B to the "non-Suitable cell" Set cell type of Cell 7 to the "Serving cell".	-	-	-	-
7	The UE performs Cell Reselection from Cell B (E-UTRAN cell) to Cell 7 (UTRAN cell).	-	-	-	-
8	Void	-	-	-	-
-	EXCEPTION: The behaviour in table 9.2.3.2.1a.3.2-2 occurs in parallel with steps 9-9B.	-	-	-	-
9	Check: Does the UE transmit a ROUTING AREA UPDATE REQUEST message?	-->	ROUTING AREA UPDATE REQUEST	-	-
9A	The SS transmits a ROUTING AREA UPDATE ACCEPT message	<--	ROUTING AREA UPDATE ACCEPT	-	-
9B	The UE transmits a ROUTING AREA UPDATE COMPLETE message	-->	ROUTING AREA UPDATE COMPLETE	-	-
10	The SS send Paging message including an unmatched identity.	<--	<i>Paging</i>	-	-
11	Check: Does the UE transmit <i>RRConnectionRequest</i> to answer the Paging?	-->	<i>RRConnectionRequest</i>	3	F
12	The SS send Paging message including a matched identity (<i>UE Identity</i> = TMSI-2).	<--	<i>Paging</i>	-	-
13	Check: Does the test results of Mobile terminated establishment of Radio Resource Connection [5] indicate that the UE transmit <i>RRConnectionRequest</i> with Initial UE identity set to TMSI-2 and LAI-2 to answers on Paging message?	-	-	4	P
13a	The UE sends a PAGING RESPONSE message	-->	PAGING RESPONSE	-	-
14	The SS releases the RRC connection.	-	-	-	-
-	The following messages are sent and shall be received on Cell A.	-	-	-	-
15	Set cell type of Cell 7 to the "non-Suitable cell" Set cell type of Cell A to the "Serving cell".	-	-	-	-
16	The UE performs Cell Reselection from Cell 7 (UTRAN cell) to Cell A (E-UTRAN cell).	-	-	-	-
17	Check: Does the UE transmit a combined TRACKING AREA UPDATE REQUEST message with Last visited registered TAI set to TAI-2?	-->	TRACKING AREA UPDATE REQUEST	5	P
18	The SS sends TRACKING AREA UPDATE ACCEPT message with LAI set to LAI-1, not including MS identity.	<--	TRACKING AREA UPDATE ACCEPT	-	-
19	The SS releases the RRC connection.	-	-	-	-

-	The following messages are sent and shall be received on Cell 5.	-	-	-	-
20	Set cell type of Cell A to the "non-Suitable cell". Set cell type of Cell 7 to the "non-Suitable "off" cell". Set cell type of Cell 5 to the "Serving cell".	-	-	-	-
21	The UE performs Cell Reselection from Cell A (E-UTRAN cell) to Cell 5(UTRAN cell).	-	-	-	-
22	Void	-	-	-	-
-	EXCEPTION: The behaviour in table 9.2.3.2.1a.3.2-3 occurs in parallel with steps 23-23B.	-	-	-	-
23	Check: Does the UE transmit a ROUTING AREA UPDATE REQUEST message?	-->	ROUTING AREA UPDATE REQUEST	-	-
23 A	The SS transmits a ROUTING AREA UPDATE ACCEPT message	<--	ROUTING AREA UPDATE ACCEPT	-	-
23 B	The UE transmits a ROUTING AREA UPDATE COMPLETE message	-->	ROUTING AREA UPDATE COMPLETE	-	-
24	The SS send Paging message including a matched identity (<i>UE Identity</i> = TMSI-2).	<--	<i>Paging</i>	-	-
25	Check: Does the test results of Mobile terminated establishment of Radio Resource Connection [5] indicate that the UE transmit <i>RRConnectionRequest</i> with Initial UE identity set to TMSI-2 and LAI-1 to answers on Paging message?	-	-	4	P
25a	The UE sends a PAGING RESPONSE message	-->	PAGING RESPONSE	-	-
26	The SS releases the RRC connection.	-	-	-	-
-	The following messages are sent and shall be received on Cell B.	-	-	-	-
27	Set cell type of Cell 5 to the "non-Suitable cell" Set cell type of Cell B to the "Serving cell".	-	-	-	-
28	The UE performs Cell Reselection from Cell 5(UTRAN cell) to Cell B (E-UTRAN cell).	-	-	-	-
29	Check: Does the UE transmit a combined TRACKING AREA UPDATE REQUEST message with Last visited registered TAI set to TAI-1?	-->	TRACKING AREA UPDATE REQUEST	8	P
30	The SS sends TRACKING AREA UPDATE ACCEPT message with LAI set to LAI-2, including the IMSI as MS identity.	<--	TRACKING AREA UPDATE ACCEPT	-	-
-	EXCEPTION: Step 30a is optional for Release 8 to Release 10 UE implementation, from release 11 onwards, UE shall not send this message.	-	-	-	-
30a	The UE sends a TRACKING AREA UPDATE COMPLETE message	-->	TRACKING AREA UPDATE COMPLETE	-	-
31	The SS releases the RRC connection.	-	-	-	-
-	The following messages are sent and shall be received on Cell 7.	-	-	-	-
32	Set cell type of Cell B to the "non-Suitable cell". Set cell type of Cell A to the "non-Suitable "off" cell". Set cell type of Cell 7 to the "Serving cell".	-	-	-	-
33	The UE performs Cell Reselection from Cell B (E-UTRAN cell) to Cell 7 (UTRAN cell).	-	-	-	-
34	Void	-	-	-	-
-	EXCEPTION: The behaviour in table 9.2.3.2.1a.3.2-3 occurs in parallel with steps 35-35B.	-	-	-	-
35	Check: Does the UE transmit a ROUTING AREA UPDATE REQUEST message?	-->	ROUTING AREA UPDATE REQUEST	-	-
35 A	The SS transmits a ROUTING AREA UPDATE ACCEPT message	<--	ROUTING AREA UPDATE ACCEPT	-	-
35 B	The UE transmits a ROUTING AREA UPDATE COMPLETE message	-->	ROUTING AREA UPDATE COMPLETE	-	-

36	The SS sends Paging message including a TMSI.	<--	<i>Paging</i>	-	-
37	Check: Does the UE transmit <i>RRConnectionRequest</i> to answer the Paging?	-->	<i>RRConnectionRequest</i>	10	F

Table: 9.2.3.2.1a.3.2-2: Parallel behaviour

St	Procedure	Message Sequence		TP	Verdict
		U - S	Message		
1	Check: Does UE perform Location updating procedure?	-->	LOCATION UPDATING REQUEST	-	-
2	The SS transmits an AUTHENTICATION REQUEST message.	<--	AUTHENTICATION REQUEST	-	-
3	The UE transmits an AUTHENTICATION RESPONSE message.	-->	AUTHENTICATION RESPONSE	-	-
4	The SS transmits a LOCATION UPDATING ACCEPT message.	<--	LOCATION UPDATING ACCEPT	-	-

Table: 9.2.3.2.1a.3.2-3: Parallel behaviour

St	Procedure	Message Sequence		TP	Verdict
		U - S	Message		
1	Check: Does UE perform Location updating procedure?	-->	LOCATION UPDATING REQUEST	-	-
2	The SS transmits a LOCATION UPDATING ACCEPT message.	<--	LOCATION UPDATING ACCEPT	-	-

9.2.3.2.1a.3.3 Specific message contents

Table 9.2.3.2.1a.3.3-1: Message TRACKING AREA UPDATE REQUEST (step 2, Table 9.2.3.2.1a.3.2-1)

Derivation path: 36.508 table 4.7.2-27			
Information Element	Value/Remark	Comment	Condition
Old GUTI	GUTI-1	Old GUTI is included by UE if valid, IMSI otherwise.	
Last visited registered TAI	TAI-1	If available, the last TAI is included by UE and will be used to establish a good list of TAIs in subsequent ATTACH ACCEPT message.	
Old LAI	LAI-1		
TMSI status	Not present		

Table 9.2.3.2.1a.3.3-2: Message TRACKING AREA UPDATE ACCEPT (step 3, Table 9.2.3.2.1a.3.2-1)

Derivation path: 36.508 table 4.7.2-24			
Information Element	Value/Remark	Comment	Condition
T3412 value	Not present		
GUTI	Not present	This IE may be included to assign a new GUTI	
TAI list			
Length of tracking area identity list contents	00000110	6 octets	
Number of elements	00000	1 element	
Type of list	00	One PLMN with non-consecutive TACs	
MCC MNC TAC 1	TAI-2		
LAC	2 (LAI-2)		
MS identity	TMSI-2		
T3402 value	Not present		
Equivalent PLMNs	Not present		
EMM cause	Not present		

Table 9.2.3.2.1a.3.3-3: Message PAGING TYPE 1 (step 10, Table 9.2.3.2.1a.3.2-1)

Derivation path: 34.108 sec 7.1.2.4.1			
Information Element	Value/Remark	Comment	Condition
Paging record list			
Paging record			
CN originator			
Paging cause CN domain identity UE identity	Terminating Speech Call CS domain TMSI other than TMSI-2		

Table 9.2.3.2.1a.3.3-4: Message PAGING TYPE 1 (step 12, Table 9.2.3.2.1a.3.2-1)

Derivation path: 34.108 sec 7.1.2.4.1			
Information Element	Value/Remark	Comment	Condition
Paging record list			
Paging record			
CN originator			
Paging cause CN domain identity UE identity	Terminating Speech Call CS domain TMSI-2		

Table 9.2.3.2.1a.3.3-5: Message RRC CONNECTION REQUEST (step 13, Table 9.2.3.2.1a.3.2-1)

Derivation path: 34.108 sec 9.1.1			
Information Element	Value/Remark	Comment	Condition
Initial UE identity			
TMSI(GSM-MAP) LAI (GSM-MAP)	TMSI-2 LAI-4		
Establishment cause	Terminating Conversational Call		

Table 9.2.3.2.1a.3.3-6 Message TRACKING AREA UPDATE REQUEST (step 17, Table 9.2.3.2.1a.3.2-1)

Derivation path: 36.508 table 4.7.2-27			
Information Element	Value/Remark	Comment	Condition
Old GUTI	GUTI-1	Old GUTI is included by UE calculated by using UTRAN P-TMSI.	
Last visited registered TAI	TAI-2	If available, the last TAI is included by UE and will be used to establish a good list of TAIs in subsequent ATTACH ACCEPT message.	
Old LAI	LAI-4		
TMSI status	Not present		
EPS update type	010	combined TA/LA updating with IMSI attach	
Nonce _{UE}	Any allowed value		
Old P-TMSI signature	Present		
Additional GUTI	GUTI-1		

Table 9.2.3.2.1a.3.3-7: Message TRACKING AREA UPDATE ACCEPT (step 18, Table 9.2.3.2.1a.3.2-1)

Derivation path: 36.508 table 4.7.2-24			
Information Element	Value/Remark	Comment	Condition
T3412 value	Not present		
GUTI	Not present	This IE may be included to assign a new GUTI	
TAI list			
Length of tracking area identity list contents	00000110	6 octets	
Number of elements	00000	1 element	
Type of list	00	One PLMN with non-consecutive TACs	
MCC MNC TAC 1	TAI-1		
LAC	1 (LAI-1)		
MS identity	Not present		
T3402 value	Not present		
Equivalent PLMNs	Not present		
EMM cause	Not present		

Table 9.2.3.2.1a.3.3-8: Message PAGING TYPE 1 (step 24, Table 9.2.3.2.1a.3.2-1)

Derivation path: 34.108 sec 7.1.2.4.1			
Information Element	Value/Remark	Comment	Condition
Paging record list			
Paging record			
CN originator			
Paging cause CN domain identity UE identity	Terminating Speech Call CS domain TMSI-2		

Table 9.2.3.2.1a.3.3-9: Message RRC CONNECTION REQUEST (step 25, Table 9.2.3.2.1a.3.2-1)

Derivation path: 34.108 sec 9.1.1			
Information Element	Value/Remark	Comment	Condition
Initial UE identity			
TMSI(GSM-MAP) LAI (GSM-MAP)	TMSI-2 LAI-3		
Establishment cause	Terminating Conversational Call		

Table 9.2.3.2.1a.3.3-10: Message TRACKING AREA UPDATE REQUEST (step 29, Table 9.2.3.2.1a.3.2-1)

Derivation path: 36.508 table 4.7.2-27			
Information Element	Value/Remark	Comment	Condition
Old GUTI	GUTI-1	Old GUTI is included by UE calculated by using UTRAN P-TMSI.	
Last visited registered TAI	TAI-1	If available, the last TAI is included by UE and will be used to establish a good list of TAIs in subsequent ATTACH ACCEPT message.	
Old LAI	LAI-3		
TMSI status	Not present		
EPS update type	010	combined TA/LA updating with IMSI attach	
Nonce _{UE}	Any allowed value		
Old P-TMSI signature	Present		
Additional GUTI	GUTI-1		

Table 9.2.3.2.1a.3.3-11: Message TRACKING AREA UPDATE ACCEPT (step 30, Table 9.2.3.2.1a.3.2-1)

Derivation path: 36.508 table 4.7.2-24			
Information Element	Value/Remark	Comment	Condition
EPS update result	001	"combined TA/LA"	
T3412 value	Not present		
GUTI	Not present	This IE may be included to assign a new GUTI	
TAI list			
Length of tracking area identity list contents	00000110	6 octets	
Number of elements	00000	1 element	
Type of list	00	One PLMN with non-consecutive TACs	
MCC MNC TAC 1	TAI-2		
LAC	2(LAI-2)		
MS identity	IMSI		
T3402 value	Not present		
Equivalent PLMNs	Not present		
EMM cause	Not present		

Table 9.2.3.2.1a.3.3-12: Message PAGING TYPE 1 (step 36, Table 9.2.3.2.1a.3.2-1)

Derivation path: 34.108 sec 7.1.2.4.1			
Information Element	Value/Remark	Comment	Condition
Paging record list			
Paging record			
CN originator			
Paging cause CN domain identity UE identity	Terminating Speech Call CS domain TMSI (any value)		

Table 9.2.3.2.1a.3.3-13: LOCATION UPDATING REQUEST (step 1, Table 9.2.3.2.1a.3.2-2 and step 1, Table 9.2.3.2.1a.3.2-3)

Derivation Path: TS 36.508 Table 4.7B.2-4			
Information Element	Value/remark	Comment	Condition
Location updating type	Normal location updating		

Table 9.2.3.2.1a.3.3-14: LOCATION UPDATING ACCEPT (step 4, Table 9.2.3.2.1a.3.2-2 and step 2, Table 9.2.3.2.1a.3.2-3)

Derivation Path: TS 36.508 Table 4.7B.2-5			
Information Element	Value/remark	Comment	Condition
Mobile identity	Not present		

9.2.3.2.1b Combined tracking area update / Success / SMS only**9.2.3.2.1b.1 Test Purpose (TP)**

(1)

```
with { UE, operating in CS/PS mode 1, has sent a combined TRACKING AREA UPDATE REQUEST message }
ensure that {
  when { UE receives a TRACKING AREA UPDATE ACCEPT message containing a GUTI and/or a mobile
identity and Additional update result IE 'SMS only' }
  then { UE automatically disable the E-UTRAN capability and performs a registration to UTRAN cell
or GERAN cell(depending on the UE capability) }
}
```

(2)

```
with { UE, operating in CS/PS mode 2, in state EMM-REGISTERED and state MM-IDLE }
ensure that {
  when { UE receives TRACKING AREA UPDATE ACCEPT message with EPS attach result 'combined EPS/IMSI
attach' and Additional update result IE 'SMS only' and SS sends Paging message with PS domain }
  then { UE sends SERVICE REQUEST message }
}
```

(3)

```
with { UE operating in CS/PS mode 2 and configured to use IMS voice, in state EMM-REGISTERED and
state MM-IDLE }
ensure that {
  when { UE receives TRACKING AREA UPDATE ACCEPT message with EPS attach result 'combined EPS/IMSI
attach' and Additional update result IE 'SMS only' and the user initiates an IMS voice call }
  then { UE does not initiate an IMS voice call }
```

(4)

```
with { UE operating in CS/PS mode 1 }
ensure that {
  when { UE receives TRACKING AREA UPDATE ACCEPT message with EPS updatereult 'combined EPS/IMSI
attach' and Additional update result IE 'SMS only' }
  then { UE does not set the E-UTRA support bit in the relevant NAS and AS messages }
```

9.2.3.2.1b.2 Conformance requirements

References: The conformance requirements covered in the present TC are specified in: TS 24.301, clauses 4.3.1, 4.5, 4.3.1, 4.5, 5.5.3.3.1, 5.5.3.3.2, 5.5.3.3.4.1, 5.5.3.3.4.2 and 5.6.2.4.

[TS 24.301 clause 4.3.1]

The behaviour of the UE in CS/PS mode 1 of operation, upon failure to access the CS domain or upon reception of a "CS fallback not preferred" or "SMS only" indication, will depend on the availability of voice over IMS. In the present document, "IMS voice not available" refers to one of the following conditions:

- the UE is not configured to use IMS;
- the UE is not configured to use IMS voice, i.e. when the voice domain preference for E-UTRAN, as defined in 3GPP TS 24.167 [13B], indicates that voice communication services are allowed to be invoked only over the CS domain;
- the UE is configured to use IMS voice, but the network indicates in the ATTACH ACCEPT message or the TRACKING AREA UPDATE ACCEPT message that IMS voice over PS sessions are not supported; or
- the UE is configured to use IMS voice, the network indicates in the ATTACH ACCEPT message or the TRACKING AREA UPDATE ACCEPT message that IMS voice over PS sessions are supported, but the upper layers indicate that the UE is not available for voice calls in the IMS.

[TS24.301 clause 4.5]

When the UE supporting the A/Gb and/or Iu mode together with the S1 mode needs to stay in A/Gb or Iu mode, in order to prevent unwanted handover or cell reselection from UTRAN/GERAN to E-UTRAN, the UE shall disable the E-UTRA capability.

- The UE shall not set the E-UTRA support bits of the MS Radio Access capability IE (see 3GPP TS 24.008 [13], subclause 10.5.5.12a), the E-UTRA support bits of Mobile Station Classmark 3 IE (see 3GPP TS 24.008 [13], subclause 10.5.1.7) and the ISR support bit of the MS network capability IE (see 3GPP TS 24.008 [13], subclause 10.5.5.12) in the ATTACH REQUEST message and the ROUTING AREA UPDATE REQUEST message after it selects GERAN or UTRAN; and
- the UE NAS layer shall indicate the access stratum layer(s) of disabling of the E-UTRA capability.

NOTE: The UE can only disable the E-UTRAN capabilities when in EMM-IDLE mode.

The UE shall enable the E-UTRA capability again in the following cases:

- the UE mode of operation changes from CS/PS mode 1 of operation to CS/PS mode 2 of operation;
- the UE mode of operation changes from PS mode 1 of operation to PS mode 2 of operation;
- the UE powers off and powers on again; or
- for the PLMN selection purpose.

[TS24.301 clause 5.5.3.3.1]

Within a combined tracking area updating procedure the messages TRACKING AREA UPDATE ACCEPT and TRACKING AREA UPDATE COMPLETE carry information for the tracking area updating and the location area updating.

The combined tracking area updating procedure follows the normal tracking area updating procedure described in subclause 5.5.3.2.

[TS24.301 clause 5.5.3.3.2]

...

To initiate a combined tracking area updating procedure the UE sends the message TRACKING AREA UPDATE REQUEST to the network, starts timer T3430 and changes to state EMM-TRACKING-AREA-UPDATING-INITIATED. The value of the EPS update type IE in the message shall indicate "combined TA/LA updating" unless explicitly specified otherwise.

If the UE initiates the combined tracking area updating procedure for EPS services and "SMS only", the UE shall indicate "SMS only" in the Additional update Type IE.

The UE shall include the TMSI status IE if no valid TMSI is available. Furthermore, if the UE has stored a valid location area identification, the UE shall include it in the Old location area identification IE in the TRACKING AREA UPDATE REQUEST message.

[TS24.301 clause 5.5.3.3.4.1]

Depending on the value of the EPS update result IE received in the TRACKING AREA UPDATE ACCEPT message, the following different cases can be distinguished:

- 1) The EPS update result IE value indicates "combined TA/LA updated": Tracking and location area updating is successful for EPS and non-EPS services, or for EPS services and "SMS only";

...

A TRACKING AREA UPDATE COMPLETE message shall be returned to the network if the TRACKING AREA UPDATE ACCEPT message contains a GUTI or a mobile identity or both.

[TS24.301 clause 5.5.3.3.4.2]

The description for normal tracking area update as specified in subclause 5.5.3.2.4 shall be followed. In addition, the following description for location area updating applies.

The TMSI reallocation may be part of the combined tracking area updating procedure. The TMSI allocated is then included in the TRACKING AREA UPDATE ACCEPT message together with the location area identification (LAI). In this case the MME shall change to state EMM-COMMON-PROCEDURE-INITIATED and shall start the timer T3450 as described in subclause 5.4.1. The LAI may be included in the TRACKING AREA UPDATE ACCEPT message without TMSI.

The UE, receiving a TRACKING AREA UPDATE ACCEPT message, stores the received location area identification, resets the location update attempt counter, sets the update status to U1 UPDATED and enters MM state MM IDLE.

...

If the UE requested "SMS only" in the Additional update type IE, the network shall indicate "SMS only" in the Additional update result IE.

If the TRACKING AREA UPDATE ACCEPT message includes the Additional update result IE with value "SMS only" or "CS Fallback not preferred", a UE operating in CS/PS mode 1 with "IMS voice not available" shall attempt to select GERAN or UTRAN radio access technology rather than E-UTRAN for the selected PLMN or equivalent PLMN. The UE shall disable the E-UTRA capability (see subclause 4.5). If the UE is in the EMM-CONNECTED mode, the UE shall locally release the established NAS signalling connection and enter the EMM-IDLE mode before selecting GERAN or UTRAN radio access technology.

If the TRACKING AREA UPDATE ACCEPT message includes the Additional update result IE with value "SMS only", a UE operating in CS/PS mode 2 shall not attempt to use CS fallback for mobile originating services.

...

[TS24.301 clause 5.6.2.4]

The network shall initiate the paging procedure when it receives an incoming mobile terminating SMS to the UE that is IMSI attached for non-EPS services or for "SMS only", and no NAS signalling connection exists.

To initiate the procedure for SMS when no NAS signalling connection exists, the EMM entity in the network requests the lower layer to start paging (see 3GPP TS 36.413 [23]). The paging message shall include a CN domain indicator set to "PS". The paging procedure is performed according to subclause 5.6.2.2.1. The MME shall not start timer T3413 for this procedure.

9.2.3.2.1b.3 Test description

9.2.3.2.1b.3.1 Pre-test conditions

System Simulator:

- Cell A and Cell B are configured according to Table 6.3.2.2-1 in [18].
- Cell A belongs to TAI-1(home PLMN) is set to "Serving Cell".
- Cell B belongs to TAI-2(home PLMN and another TAC) is set to "Non-Suitable cell"
- if pc_UTRA AND px_RATComb_Tested = EUTRA_UTRA, cell 5 (belongs to LAI-1 and RAI-1, home PLMN) is set to the " Non-Suitable cell";
- if pc_GERAN AND px_RATComb_Tested = EUTRA_GERAN, cell 24 (belongs to LAI-1 and RAI-1, home PLMN); is set to the " Non-Suitable cell";
- System information combination 10a as defined in TS 36.508[18] clause 4.4.3.1 is used in E-UTRA cells.

NOTE: Setting px_RATComb_Tested = EUTRA_Only is not allowed.

UE:

- The UE is configured to initiate combined EPS/IMSI attach.

Preamble:

- The UE is in state Registered, Idle Mode (state 2) on cell A according to [18].

9.2.3.2.1b.3.2 Test procedure sequence

Table 9.2.3.2.1b.3.2-1: Main Behaviour

St	Procedure	Message Sequence		TP	Verdict
		U - S	Message		
	The following messages are sent and shall be received on Cell B	-	-	-	-
1	Set the cell type of cell A to the "Non-Suitable cell". Set the cell type of cell B to the "Serving cell". Set the cell type of cell 5 or cell 24 to "Suitable neighbour cell".				
2	UE transmits a combined TRACKING AREA UPDATE REQUEST message.	-->	TRACKING AREA UPDATE REQUEST	-	-
3	The SS sends TRACKING AREA UPDATE ACCEPT message including GUTI, TMSI and LAI. The TAI list includes TAI for cell C and cell D.	<--	TRACKING AREA UPDATE ACCEPT	-	-
4	Void			-	-
5	Void			-	-
-	EXCEPTION: Steps 6a1 to 6b4 describe behaviour that depends on the UE capability; the "lower case letter" identifies a step sequence that take place if a capability is supported	-	-	-	-
6a1	IF <i>CS/PS mode 1 of operation is configured</i> on the UE THEN perform actions specified in Table 9.2.3.2.1b.3.2-2.				
6a2-6a6	Void				
6b1	ELSE the UE transmits a TRACKING AREA UPDATE COMPLETE message.	-->	TRACKING AREA UPDATE COMPLETE	-	-
6b1A1	The SS releases the RRC connection.	-	-	-	-
6b2	Check: Does the UE respond to paging on cell B with S-TMSI in GUTI-2 for PS domain?(Generic Procedure TS36.508 6.4.2.4)	-	-	2	-
-	EXCEPTION: Steps 6b3a1 to 6b3a2 describe behaviour that depends on the UE capability.	-	-	-	-
6b3a1	IF <i>pc_VoLTE</i> THEN an IMS voice call is initiated (see Note 1)	-	-	-	-
6b3a2	Check: Does the UE send RRC CONNECTION REQUEST message?	-->	RRC CONNECTION REQUEST	3	F
Note 1: The request may be triggered by AT command D.					

Table 9.2.3.2.1b.3.2-2: CS/PS mode 1 of operation behaviour

St	Procedure	Message Sequence		TP	Verdict
		U - S	Message		
-	EXCEPTION: Step 1a1 to 1b2 are optional and depend on UE implementation. They shall be executed if the UE sends a TRACKING AREA UPDATE COMPLETE or a DETACH REQUEST message during [2] seconds. The "lower case letter" identifies a step sequence that takes place if a particular condition specified in the first step is met.	-	-	-	-
1a1	IF UE sent a TRACKING AREA UPDATE COMPLETE message	-->	TRACKING AREA UPDATE COMPLETE	-	-
-	EXCEPTION: Steps 1a2a1 to 1a2a2 are optional and depend on UE implementation; the second "lower case letter" identifies a step sequence that takes place if the condition is met..	-	-	-	-
1a2a1	IF UE sends a DETACH REQUEST message during [2] seconds.	-->	DETACH REQUEST	-	-
1a2a2	SS sends a DETACH ACCEPT message.	<--	DETACH ACCEPT	-	-
1b1	IF UE sent a DETACH REQUEST message.	-->	DETACH REQUEST	-	-
1b2	SS sends a DETACH ACCEPT message.	<--	DETACH ACCEPT	-	-
2	The SS releases the RRC connection.				
-	The following messages are to be observed on Cell 5 or Cell 24 unless explicitly stated otherwise.	-	-	-	-
-	EXCEPTION: Step 3a1 to 3b5 are optional and depend on UE implementation. The "lower case letter" identifies a step sequence that takes place if a particular condition specified in the first step is met.				
3a1	IF UE did not sent DETACH REQUEST in step 1a2a1 or 1b1 AND UE transmits a ROUTING AREA UPDATE REQUEST message during [2] seconds THEN check contents of ROUTING AREA UPDATE REQUEST	-->	ROUTING AREA UPDATE REQUEST	1,4	P
-	EXCEPTION: step 3a1Aa1 to 3a1Aa2 take place if pc_GERAN AND px_RATComb_Tested = EUTRA_GERAN	-	-	-	-
3a1Aa1	The SS transmits an AUTHENTICATION AND CIPHERING REQUEST message from Cell 24	<--	AUTHENTICATION AND CIPHERING REQUEST	-	-
3a1Aa2	The UE transmits a AUTHENTICATION AND CIPHERING RESPONSE message on Cell 24	-->	AUTHENTICATION AND CIPHERING RESPONSE	-	-
3a2	The SS transmits a ROUTING AREA UPDATE ACCEPT message.	<--	ROUTING AREA UPDATE ACCEPT	-	-
3a3	The UE transmits a ROUTING AREA UPDATE COMPLETE message.	-->	ROUTING AREA UPDATE COMPLETE	-	-
3b1	ELSE check: Does the UE transmit an ATTACH REQUEST message?	-->	ATTACH REQUEST	1,4	P
-	EXCEPTION: Step 3b2 to 3b3 are performed if UE sent a DETACH REQUEST in step 1a2a1 or 1b1	-	-	-	-
3b2	The SS transmits an AUTHENTICATION	<--	AUTHENTICATION AND	-	-

	AND CIPHERING REQUEST message.		CIPHERING REQUEST		
3b3	The UE transmits a AUTHENTICATION AND CIPHERING RESPONSE message.	-->	AUTHENTICATION AND CIPHERING RESPONSE	-	-
3b4	The SS transmits an ATTACH ACCEPT message.	<--	ATTACH ACCEPT	-	-
3b5	The UE transmits an ATTACH COMPLETE message.	-->	ATTACH COMPLETE	-	-

9.2.3.2.1b.3.3 Specific message contents

Table 9.2.3.2.1b.3.3-1: Message TRACKING AREA UPDATE REQUEST (step 2, Table 9.2.3.2.1b.3.2-1)

Derivation path: 36.508 table 4.7.2-27 with condition CombinedAttach			
Information Element	Value/Remark	Comment	Condition
Old GUTI	GUTI-1	GUTI-1 was allocated in cell A during the preamble	
Last visited registered TAI	TAI-1	TAI of cell A	
Old location area identification	LAI-1	LAI received in the ATTACH ACCEPT message in the preamble	
TMSI status	0	no valid TMSI available	

Table 9.2.3.2.1b.3.3-2: Message TRACKING AREA UPDATE ACCEPT (step 3, Table 9.2.3.2.1b.3.2-1)

Derivation path: 36.508 table 4.7.2-24 with condition CombinedAttach			
Information Element	Value/Remark	Comment	Condition
GUTI	GUTI-2		
TAI list			
Length of tracking area identity list contents	'00000110'B	6 octets	
Type of list	'B0"list of TACs belonging to one PLMN, with non-consecutive TAC values"0		
Number of elements	'00000'	1 elements	
Partial tracking area identity list	PLMN = MCC/MNC stored in EF _{IMSI} TAC 1 = 2	TAI-2	
Additional update result	'10'B	SMS only	

Table 9.2.3.2.1b.3.3-3: Void

Table 9.2.3.2.1b.3.3-4: Message ROUTING AREA UPDATE REQUEST (step 3a1, Table 9.2.3.2.1b.3.2-2)

Derivation path: 36.508 table 4.7B.2-1			
Information Element	Value/Remark	Comment	Condition
MS Radio Access capability		The UE shall not indicate support for E-UTRAN	
MS RA capability value part			
Access capabilities			
E-UTRA FDD support :	'0'B		
E-UTRA TDD support	'0'B		
GERAN to E-UTRA support in GERAN packet transfer mode	'00'B		
UE network capability	Not Present	UE does not support S1 mode any more	

Table 9.2.3.2.1b.3.3-5: Message ATTACH REQUEST (step 3b1, Table 9.2.3.2.1b.3.2-2)

Derivation path: 36.508 table 4.7B.2-6			
Information Element	Value/Remark	Comment	Condition
MS Radio Access capability		The UE shall not indicate support for E-UTRAN	
MS RA capability value part			
Access capabilities			
E-UTRA FDD support :	'0'B		
E-UTRA TDD support	'0'B		
GERAN to E-UTRA support in GERAN packet transfer mode	'00'B		
UE network capability	Not Present	UE does not support S1 mode any more	

9.2.3.2.1c Combined tracking area update / Success / CS Fallback not preferred**9.2.3.2.1c.1 Test Purpose (TP)**

(1)

```

with { UE operating in CS/PS mode 2 in state EMM-REGISTERED-INITIATED}
ensure that {
  when { UE receives a TRACKING AREA UPDATE ACCEPT message with "EPS network feature support" IE
indicating that "IMS voice over PS session in S1 mode NOT supported" and "Additional update result"
IE indicating "CS Fallback not preferred" }
  then { UE stays on the E-UTRAN cell.}
}

```

(2)

```

with { UE operating in CS/PS mode 2}
ensure that {
  when receives a TRACKING AREA UPDATE ACCEPT message with "EPS network feature support" IE
indicating that "IMS voice over PS session in S1 mode NOT supported" and "Additional update result"
IE indicating "CS Fallback not preferred" }
  then { The UE is able to initiate an MO-CS fallback call}
}

```

(3)

```

with { UE operating in CS/PS mode 2}
ensure that {
  when receives a TRACKING AREA UPDATE ACCEPT message with "EPS network feature support" IE
indicating that "IMS voice over PS session in S1 mode NOT supported" and "Additional update result"
IE indicating "CS Fallback not preferred" }
  then { The UE is able to receive MT CS fallback call}
}

```

9.2.3.2.1c.2 Conformance requirements

References: The conformance requirements covered in the present TC are specified in: 3GPP TS 24.301 clauses 4.3.1 and 5.5.3.3.4.2.

[TS 24.301 clause 4.3.1]

The behaviour of the UE in CS/PS mode 1 of operation, upon failure to access the CS domain or upon reception of a "CS fallback not preferred" or "SMS only" indication, will depend on the availability of voice over IMS. In the present document, "IMS voice not available" refers to one of the following conditions:

- the UE is not configured to use IMS;
- the UE is not configured to use IMS voice, i.e. when the voice domain preference for E-UTRAN, as defined in 3GPP TS 24.167 [13B], indicates that voice communication services are allowed to be invoked only over the CS domain;
- the UE is configured to use IMS voice, but the network indicates in the ATTACH ACCEPT message or the TRACKING AREA UPDATE ACCEPT message that IMS voice over PS sessions are not supported; or
- the UE is configured to use IMS voice, the network indicates in the ATTACH ACCEPT message or the TRACKING AREA UPDATE ACCEPT message that IMS voice over PS sessions are supported, but the upper layers indicate that the UE is not available for voice calls in the IMS.

[TS 24.301 clause 5.5.3.3.4.2]

If the TRACKING AREA UPDATE ACCEPT message includes the Additional update result IE with value "SMS only" or "CS Fallback not preferred", a UE operating in CS/PS mode 1 with "IMS voice not available" shall attempt to select GERAN or UTRAN radio access technology rather than E-UTRAN for the selected PLMN or equivalent PLMN. The UE shall disable the E-UTRA capability (see subclause 4.5). If the UE is in the EMM-CONNECTED mode, the UE shall locally release the established NAS signalling connection and enter the EMM-IDLE mode before selecting GERAN or UTRAN radio access technology.

If the TRACKING AREA UPDATE ACCEPT message includes the Additional update result IE with value "SMS only", a UE operating in CS/PS mode 2 shall not attempt to use CS fallback for mobile originating services.

If the TRACKING AREA UPDATE ACCEPT message includes the Additional update result IE with value "CS Fallback not preferred", this indicates to a UE operating in CS/PS mode 2 that it is attached for EPS and non-EPS services and that it can use CS fallback.

9.2.3.2.1c.3 Test description

9.2.3.2.1c.3.1 Pre-test conditions

System Simulator:

- cell A, cell B and cell 5;

System information combination 9 as defined in TS 36.508[18] clause 4.4.3.1 is used in E-UTRA cells

UE:

- the UE is configured to initiate combined EPS/IMSI attach;
- the UE is configured to be data centric.
- the UE is previously registered on cell 5.
- the UE is previously registered on E-UTRAN, and when on E-UTRAN, the UE is last authenticated and registered on cell A using default message contents according to TS 36.508 [18].

Preamble:

- if possible, the UE is configured to operate in CS/PS mode 2
- The UE is in state Registered, Idle mode (state 2) on Cell A (serving cell) according to [18].

9.2.3.2.1c.3.2 Test procedure sequence

Table 9.2.3.2.1c.3.2-1 illustrates the downlink power levels and other changing parameters to be applied for the cells at various time instants of the test execution. Configurations marked "T1" is applied at the point indicated in the Main behaviour description in Table 9.2.3.2.1c.3.2-2.

Table 9.2.3.2.1c.3.2-1: instances of cell power level and parameter changes

	Parameter name	Unit	Cell A	Cell B	Cell 5
T1	RS EPRE	dBm/15kHz	-91	-85	
	CPICH_Ec	dBm/3.84 MHz			-70
	P-CCPCH	dBm/1.28 MHz			-70
T2	RS EPRE	dBm/15kHz	-115	-115	
	CPICH_Ec	dBm/3.84 MHz			-70
	P-CCPCH	dBm/1.28 MHz			-70
T3	RS EPRE	dBm/15kHz	-91	-85	
	CPICH_Ec	dBm/3.84 MHz			-70
	P-CCPCH	dBm/1.28 MHz			-70
T4	RS EPRE	dBm/15kHz	OFF	OFF	
	CPICH_Ec	dBm/3.84 MHz			-70
	P-CCPCH	dBm/1.28 MHz			-70

Table 9.2.3.2.1c.3.2-2: Main Behaviour

St	Procedure	Message Sequence		TP	Verdict
		U - S	Message		
1	SS adjust the cell power levels according to row T1 in table 9.2.3.2.1c.3.2-1.			-	-
2-7	Steps 2-7 of the tracking area updating procedure on cell B as described in TS 36.508 table 4.5A.2.1-1 are performed.			-	-
8	Check: Does the UE try to access the UTRAN cell (cell 5) in the next 90s?			1	F
10-13	Steps 1-4 of the procedure in table 13.1.4.3.2-2 are performed.	-	-	-	-
-	The UE accepts CS fallback	-	-	-	-
14	Check: Does the UE transmit an <i>RRConnectionSetupComplete</i> message containing an EXTENDED SERVICE REQUEST with message content set the same as in step 5 table 13.1.4.3.2-2?	-->	<i>RRConnectionSetupComplete</i> NAS: EXTENDED SERVICE REQUEST	3	P
15-26	Steps 5A-19 of the procedure described in table 13.1.4.3.2-2 are performed. SS then adjusts the cell power levels according to row T2 in table 9.2.3.2.1c.3.2-1.	-	-	-	-
26A	CS disconnect procedure defined in TS 36.523-3 table 10.1.3.1-1 is performed. SS then adjusts the cell power levels according to row T3 in table 9.2.3.2.1c.3.2-1 so ensure UE reselects cell B.	-	-	-	-
26B-26G	Steps 2-7 of the tracking area updating procedure on cell B as described in TS 36.508 table 4.5A.2.1-1 are performed.	-	-	-	-
27-27B	Steps 1-3 of the procedure in table 13.1.2.3.2-1. (A CS call is initiated) are performed	-	-	-	-
28	Check: Does the UE transmit EXTENDED SERVICE REQUEST message with the content set as in step 4 of table 13.1.2.3.2-1?	-->	EXTENDED SERVICE REQUEST	2	P
29-33	Steps 8-12 of the procedure in table 13.1.2.3.2-1 are performed.	-	-	-	-
34	SS adjusts cell levels according to row T4 of table 9.2.3.2.1c.3.2-1.				
-	The UE is in end state UTRA CS fallback (U4).	-	-	-	-

9.2.3.2.1c.3.3 Specific message contents

Table 9.2.3.2.1c.3.3-1: Message TRACKING AREA UPDATE ACCEPT (steps 5 and 26C, Table 9.2.3.2.1c.3.2-2)

Derivation path: 36.508 table 4.7.2-1			
Information Element	Value/Remark	Comment	Condition
EPS update result	'001'B	"combined TA/LA updated"	
EPS network feature support	'0000 0000'B	IMS voice over PS session in S1 mode NOT supported	
Additional update result	'01'b	"CS Fallback not preferred"	

Table 9.2.3.2.1c.3.3-2: Message TRACKING AREA UPDATE REQUEST (step 26B, Table 9.2.3.2.1c.3.2-2)

Derivation path: 36.508 table 4.7.2-27			
Information Element	Value/Remark	Comment	Condition
EPS update type			
EPS update type Value	'010'B	"Combined TA/LA updating with IMSI attach"	
Old P-TMSI Signature	Any Value		
Additional GUTI	Any Value		
Nonce	Any Value		

9.2.3.2.2 Combined tracking area update / Successful for EPS services only / IMSI unknown in HSS

9.2.3.2.2.1 Test Purpose (TP)

(1)

```
with { UE has sent a combined TRACKING AREA UPDATE REQUEST message with EPS update type set to
'Combined TA/LA updating' }
ensure that {
  when { UE receives a TRACKING AREA UPDATE ACCEPT message with EPS update result set to "TA
updated" and EMM cause set to "IMSI unknown in HSS" }
  then { UE considers the USIM as invalid for non-EPS services and enters EMM-REGISTERED.NORMAL-
SERVICE state and MM idle state }
}
```

9.2.3.2.2.2 Conformance requirements

References: The conformance requirements covered in the present TC are specified in: TS 24.301, clauses 5.5.3.3.4.3.

[TS24.301 clause 5.5.3.3.4.3]

Apart from the actions on the tracking area updating attempt counter, the description for tracking area for EPS services as specified in subclause 5.5.3.2.4 shall be followed. In addition, the following description for location updating for non-EPS services applies.

The UE receiving the TRACKING AREA UPDATE ACCEPT message takes one of the following actions depending on the EMM cause value:

#2 (IMSI unknown in HSS)

The UE shall stop T3430 if still running and shall reset the tracking area updating attempt counter. The UE shall set the update status to U3 ROAMING NOT ALLOWED and shall delete any TMSI, LAI and ciphering key sequence number. The UE shall enter state EMM-REGISTERED.NORMAL-SERVICE. The new MM state is MM IDLE. The USIM shall be considered as invalid for non-EPS services until switching off or the UICC containing the USIM is removed.

...

9.2.3.2.2.3 Test description

9.2.3.2.2.3.1 Pre-test conditions

System Simulator:

- cell A (belongs to TAI-1) is set to "Serving cell";
- cell B (belongs to TAI-2) is set to "Non-suitable cell".
- System information combination 3 as defined in TS 36.508[18] clause 4.4.3.1 is used in E-UTRA cells.

UE:

- the UE is configured to initiate combined attach

Preamble:

- the UE is in state Registered, Idle mode (state 2) on cell A according to TS 36.508 [18].

9.2.3.2.2.3.2 Test procedure sequence

Table 9.2.3.2.2.3.2-1: Main Behaviour

St	Procedure	Message Sequence		TP	Verdict
		U - S	Message		
1	Set the cell type of cell A to the "non-Suitable cell". Set the cell type of cell B to the "Serving cell".	-	-	-	-
-	The following messages are sent and shall be received on cell B.				
2	The UE transmits a combined TRACKING AREA UPDATE REQUEST message.	-->	TRACKING AREA UPDATE REQUEST	-	-
3	The SS transmits a TRACKING AREA UPDATE ACCEPT message with EPS update result set to "TA updated" and EMM cause set to "IMSI unknown in HSS"	<--	TRACKING AREA UPDATE ACCEPT	-	-
3A	The UE transmits a TRACKING AREA UPDATE COMPLETE message	-->	TRACKING AREA UPDATE COMPLETE	-	-
4	The SS releases the RRC connection.	-	-	-	-
5	The SS pages the UE using S-TMSI with CN domain indicator set to "PS".	<--	-	-	-
6	The UE transmits a SERVICE REQUEST message.	-->	SERVICE REQUEST	-	-
7	The SS transmits a DETACH REQUEST message with Detach Type set to "re-attach required"	<--	DETACH REQUEST	-	-
8	The UE sends a DETACH ACCEPT message.	-->	DETACH ACCEPT	-	-
9	The SS releases the RRC connection.	-	-	-	-
-	EXCEPTION: Step 9a describes a behaviour which depends on the UE capability	-	-	-	-
9a	IF NOT pc_Automatic_Re_Attach, the user initiates an attach by MMI or by AT command.	-	-	-	-
10	Check: Does the UE send ATTACH REQUEST message with EPS attach type set to "EPS attach", including a PDN CONNECTIVITY REQUEST message ?	-->	ATTACH REQUEST	1	P
11-22	The attach procedure is completed by executing steps 5 to 16 of the UE registration procedure in TS 36.508 sub clause 4.5.2.3. NOTE: For the content of the ATTACH ACCEPT message to be used in the UE registration procedure in TS 36.508 clause 4.5.2.3 see Table 9.2.3.2.2.3.3-5 below	-	-	-	-
-	At the end of this test procedure sequence, the UE is in end state E-UTRA connected (E2) according to TS 36.508.	-	-	-	-

9.2.3.2.2.3.3 Specific message contents

Table 9.2.3.2.2.3.3-1: Message TRACKING AREA UPDATE REQ (step 2, Table 9.2.3.2.2.3.2-1)

Derivation path: 36.508 table 4.7.2-27			
Information Element	Value/Remark	Comment	Condition
EPS update type	001	"combined TA/LA updating"	
Old GUTI	GUTI-1	Old GUTI is included by UE if valid, IMSI otherwise.	
Last visited registered TAI	TAI-1	If available, the last TAI is included by UE and will be used to establish a good list of TAIs in subsequent ATTACH ACCEPT message.	
Old P-TMSI signature	Not present		
Old LAI	LAI-1		
TMSI status	Not present		

Table 9.2.3.2.2.3.3-2: Message TRACKING AREA UPDATE ACCEPT (step 3, Table 9.2.3.2.2.3.2-1)

Derivation path: 36.508 table 4.7.2-24			
Information Element	Value/Remark	Comment	Condition
EPS update result	000	"TA updated"	
T3412 value	Not present		
GUTI	GUTI-2		
TAI list			
Length of tracking area identity list contents	00000110	6 octets	
Number of elements	00000	1 element	
Type of list	00	One PLMN with non-consecutive TACs	
MCC MNC TAC 1	TAI-2		
LAC	Not present		
MS identity	Not present		
T3402 value	Not present		
Equivalent PLMNs	Not present		
EMM cause	00000010	"IMSI unknown in HSS"	

Table 9.2.3.2.2.3.3-3: Message DETACH REQUEST (step 7, Table 9.2.3.2.2.3.2-1)

Derivation path: 36.508 table 4.7.2-12			
Information Element	Value/Remark	Comment	Condition
Detach type	001	"re-attach required"	

Table 9.2.3.2.2.3.3-4: Message ATTACH REQUEST (step 10, Table 9.2.3.2.2.3.2-1)

Derivation path: 36.508 table 4.7.2-4			
Information Element	Value/Remark	Comment	Condition
EPS attach type	001	"EPS attach"	

Table 9.2.3.2.2.3.3-5: Message ATTACH ACCEPT (For the UE registration procedure in TS 36.508 clause 4.5.2.3)

Derivation path: 36.508 table 4.7.2-1			
Information Element	Value/Remark	Comment	Condition
EPS attach result	'001'B	"EPS only"	

9.2.3.2.3 Combined tracking area update / Successful for EPS services only / MSC temporarily not reachable

9.2.3.2.3.1 Test Purpose (TP)

(1)

```
with { UE having sent a TRACKING AREA UPDATE REQUEST message with EPS update type set to 'Combined TA/LA updating' or 'Combined TA/LA updating with IMSI attach' and having the tracking area updating attempt counter set to the value less than four }
ensure that {
  when { UE receives a TRACKING AREA UPDATE ACCEPT message with the EPS update result set to 'TA updated' and the EMM cause set to 'MSC temporarily not reachable' or 'Network failure' }
  then { UE sends TRACKING AREA UPDATE REQUEST message after T3411 expiry }
}
```

(2)

```
with { UE having sent a TRACKING AREA UPDATE REQUEST message with EPS update type set to 'Combined TA/LA updating with IMSI attach', having the tracking area updating attempt counter set to four and operating in CS/PS mode 2 of operation }
ensure that {
  when { UE receives a TRACKING AREA UPDATE ACCEPT message with the EPS update result set to 'TA updated' and the EMM cause set to 'MSC temporarily not reachable' or 'Network failure' }
  then { UE sends TRACKING AREA UPDATE REQUEST message after T3402 expiry }
}
```

(3)

```
with { UE having sent a TRACKING AREA UPDATE REQUEST message with EPS update type set to 'Combined TA/LA updating with IMSI attach', having the tracking area updating attempt counter set to four and operating in CS/PS mode 1 of operation }
ensure that {
  when { UE receives a TRACKING AREA UPDATE ACCEPT message with the EPS update result set to 'TA updated' and the EMM cause set to 'MSC temporarily not reachable' or 'Network failure' }
  then { UE attempts to select GERAN or UTRAN radio access technology }
}
```

9.2.3.2.3.2 Conformance requirements

References: The conformance requirements covered in the present TC are specified in: TS 24.301, clause 5.5.3.3.4.3, TS 24.301, clause 4.5.

[TS 24.301, clause 5.5.3.3.4.3]

Apart from the actions on the tracking area updating attempt counter, the description for tracking area for EPS services as specified in subclause 5.5.3.2.4 shall be followed. In addition, the following description for location updating for non-EPS services applies.

...

#16 (MSC temporarily not reachable); or

#17 (Network failure)

The UE shall stop timer T3430 if still running. The tracking area updating attempt counter shall be incremented, unless it was already set to 5.

If the tracking area updating attempt counter is less than 5:

- the UE shall start timer T3411, shall set the EPS update status to EU1 UPDATED and shall enter state EMM-REGISTERED.ATTEMPTING-TO-UPDATE-MM. When timer T3411 expires the combined tracking area updating procedure indicating "combined TA/LA updating with IMSI attach" is triggered again.

If the tracking area updating attempt counter is equal to 5:

- a UE operating in CS/PS mode 2 of operation shall start timer T3402, shall set the EPS update status to EU1 UPDATED and shall enter state EMM-REGISTERED.ATTEMPTING-TO-UPDATE-MM. When timer T3402 expires the combined tracking area updating procedure indicating "combined TA/LA updating with IMSI attach" is triggered again;
- a UE operating in CS/PS mode 1 of operation with "IMS voice not available" shall attempt to select GERAN or UTRAN radio access technology and proceed with appropriate MM or GMM specific procedures. The UE shall disable the E-UTRA capability (see subclause 4.5).

...

[TS 24.301, clause 4.5]

When the UE supporting the A/Gb and/or Iu mode together with the S1 mode needs to stay in A/Gb or Iu mode, in order to prevent unwanted handover or cell reselection from UTRAN/GERAN to E-UTRAN, the UE shall disable the E-UTRA capability.

- The UE shall not set the E-UTRA support bits of the MS Radio Access capability IE (see 3GPP TS 24.008 [13], subclause 10.5.5.12a), the E-UTRA support bits of Mobile Station Classmark 3 IE (see 3GPP TS 24.008 [13], subclause 10.5.1.7) and the ISR support bit of the MS network capability IE (see 3GPP TS 24.008 [13], subclause 10.5.5.12) in the ATTACH REQUEST message and the ROUTING AREA UPDATE REQUEST message after it selects GERAN or UTRAN;
- the UE shall use the same value of the EPC capability bit of the MS network capability IE (see 3GPP TS 24.008 [13], subclause 10.5.5.12) in the ATTACH REQUEST message and the ROUTING AREA UPDATE REQUEST message;
- the UE NAS layer shall indicate the access stratum layer(s) of disabling of the E-UTRA capability ; and
- the UE shall change the MS network capability IE (see 3GPP TS 24.008 [13], subclause 10.5.5.12) in the ATTACH REQUEST message and the ROUTING AREA UPDATE REQUEST message after it selects GERAN or UTRAN if any capability bit is subject to change after disabling of the UE's E-UTRA capability. NOTE: The UE can only disable the E-UTRAN capabilities when in EMM-IDLE mode.

The UE shall enable the E-UTRA capability again in the following cases:

- the UE mode of operation changes from CS/PS mode 1 of operation to CS/PS mode 2 of operation;
- the UE mode of operation changes from PS mode 1 of operation to PS mode 2 of operation; or
- the UE powers off and powers on again.

...

9.2.3.2.3.3 Test description

9.2.3.2.3.3.1 Pre-test conditions

System Simulator:

- cell A and cell B;
- if pc_UTRA AND px_RATComb_Tested = EUTRA_UTRA, cell 5 (belongs to LAI-1 and RAI-1, home PLMN) is configured;
- if pc_GERAN AND px_RATComb_Tested = EUTRA_GERAN, cell 24 (belongs to LAI-1 and RAI-1, home PLMN) is configured;
- System information combination 10a as defined in TS 36.508[18] clause 4.4.3.1 is used in E-UTRA cells.

NOTE: Setting px_RATComb_Tested = EUTRA_Only is not allowed.

UE:

- the UE is configured to initiate combined EPS/IMSI attach.

Preamble:

- the UE is in state Switched OFF (state 1) according to TS 36.508 [18].

9.2.3.2.3.3.2 Test procedure sequence

The sequence is executed for execution counter k = 1, 2.

Table 9.2.3.2.3.3.2-1: Main behaviour

St	Procedure	Message Sequence		TP	Verdict
		U - S	Message		
0	Set the cell type of Cell A to the "Serving cell". Set the cell type of Cell B to the "non-Suitable cell". Set the cell type of Cell 5 or Cell 24 to the "non-Suitable cell".	-	-	-	-
-	The following messages are to be observed on Cell A unless explicitly stated otherwise.	-	-	-	-
0A	The UE is switched on or the USIM is inserted or the UE is powered on.	-	-	-	-
0B	Generic test procedure in TS 36.508 subclause 4.5.2.3 is performed. NOTE: The UE performs an ATTACH procedure and the RRC connection is released.	-	-	-	-
1	Set the cell type of Cell A to the "non-Suitable cell". Set the cell type of Cell B to the "Serving cell".	-	-	-	-
-	The following messages are to be observed on Cell B unless explicitly stated otherwise.	-	-	-	-
2	Check: Does the UE transmit a TRACKING AREA UPDATE REQUEST message?	-->	TRACKING AREA UPDATE REQUEST	-	-
3	Void	-	-	-	-
4	Void	-	-	-	-
5	The SS transmits a TRACKING AREA UPDATE ACCEPT message. Note: T3411 is started on the UE	<--	TRACKING AREA UPDATE ACCEPT	-	-
6	The UE transmits a TRACKING AREA UPDATE COMPLETE message.	-->	TRACKING AREA UPDATE COMPLETE	-	-
7	The SS releases the RRC connection.	-	-	-	-
-	EXCEPTION: The step 8 to 13 shall be repeated 3 times.	-	-	-	-
8	Wait for 10s for T3411 to expire.	-	-	-	-
9	Check: Does the UE transmit a TRACKING AREA UPDATE REQUEST message at the time when T3411 expired?	-->	TRACKING AREA UPDATE REQUEST	1	P
10	Void	-	-	-	-
11	Void	-	-	-	-
12	The SS transmits a TRACKING AREA UPDATE ACCEPT message.	<--	TRACKING AREA UPDATE ACCEPT	-	-
13	The SS releases the RRC connection.	-	-	-	-
13A1	Set the cell type of cell 5 or cell 24 to "Suitable neighbour cell" and wait for 10s for T3411 to expire.	-	-	-	-
13A2	Check: Does the UE transmit a TRACKING AREA UPDATE REQUEST message at the time when T3411 expired?	-->	TRACKING AREA UPDATE REQUEST	1	P
13A3	The SS transmits a TRACKING AREA UPDATE ACCEPT message.	<--	TRACKING AREA UPDATE ACCEPT	-	-
14-19	Void	-	-	-	-
-	EXCEPTION: Steps 20a1 to 20b17 describe behaviour that depends on UE configuration; the "lower case letter" identifies a step sequence that takes place according to UE mode of operation.	-	-	-	-
20a1	IF the UE is configured to operate in CS/PS mode 2 THEN the SS releases the RRC connection. Note: T3402 is started on the UE.	-	-	-	-
20a2	The SS waits for 30 sec for T3402 to expire.	-	-	-	-
20a3	Check: Does the UE transmit a TRACKING AREA UPDATE REQUEST message?	-->	TRACKING AREA UPDATE REQUEST	2	P
20a4	The SS transmits a TRACKING AREA	<--	TRACKING AREA UPDATE	-	-

	UPDATE ACCEPT message.		ACCEPT		
20a5	The UE transmits a TRACKING AREA UPDATE COMPLETE message.	-->	TRACKING AREA UPDATE COMPLETE	-	-
20a6	The SS releases the RRC connection.	-	-	-	-
20a7	If possible (see ICS) switch off is performed or the USIM is removed. Otherwise the power is removed.	-	-	-	-
-	EXCEPTION: Step 20a8 describes behaviour that depends on the UE capability.				
20a8	If pc_SwitchOnOff or pc_USIM_Removal then the UE transmits a DETACH REQUEST message.	-->	DETACH REQUEST	-	-
20b1 - 20b1 6	Void	-	-	-	-
20b1 7	IF the UE is configured in CS/PS mode 1 of operation with "IMS voice not available" THEN perform actions specified in Table 9.2.3.2.3.3.2-2	-	-	-	-
21	Void	-	-	-	-

Table 9.2.3.2.3.3.2-2: CS/PS mode 1 of operation behaviour

-	EXCEPTION: Step 1a1 to 1a2 are optional and depend on UE implementation. They shall be executed if the UE sends a DETACH REQUEST message during [2] seconds. The "lower case letter" identifies a step sequence that takes place if a particular condition specified is met.	-	-	-	-
1a1	UE sends a DETACH REQUEST message.	-->	DETACH REQUEST	-	-
1a2	The SS transmits a DETACH COMPLETE message.	<--	DETACH COMPLETE	-	-
2	The SS releases the RRC connection.	-	-	-	-
-	The following messages are to be observed on Cell 5 or Cell 24 unless explicitly stated otherwise.	-	-	-	-
-	EXCEPTION: Step 3a1 to 3b5 are optional and depend on UE implementation. The "lower case letter" identifies a step sequence that takes place if a particular condition specified in the first step is met.	-	-	-	-
3a1	IF UE has not sent a DETACH REQUEST in step 1a1 AND sends a ROUTING AREA UPDATE REQUEST message during [2] seconds THEN check contents of ROUTING AREA UPDATE REQUEST.	-->	ROUTING AREA UPDATE REQUEST	3	P
-	EXCEPTION: step 3a1Aa1 to 3a1Aa2 take place if pc_GERAN AND px_RATComb_Tested = EUTRA_GERAN	-	-	-	-
3a1 Aa1	The SS transmits an AUTHENTICATION AND CIPHERING REQUEST message on Cell 24	<--	AUTHENTICATION AND CIPHERING REQUEST	-	-
3a1 Aa2	The UE transmits an AUTHENTICATION AND CIPHERING RESPONSE message on Cell 24	-->	AUTHENTICATION AND CIPHERING RESPONSE	-	-
3a2	The SS transmits a ROUTING AREA UPDATE ACCEPT message.	<--	ROUTING AREA UPDATE ACCEPT	-	-
3a3	The UE transmits a ROUTING AREA UPDATE COMPLETE message.	-->	ROUTING AREA UPDATE COMPLETE	-	-
3b1	ELSE Check: Does the UE transmit an ATTACH REQUEST message?	-->	ATTACH REQUEST	3	P
-	EXCEPTION: Step 3b2 to 3b3 are performed if UE sent a DETACH REQUEST in step 1a1	-	-	-	-
3b2	The SS transmits an AUTHENTICATION AND CIPHERING REQUEST message.	<--	AUTHENTICATION AND CIPHERING REQUEST	-	-
3b3	The UE transmits a AUTHENTICATION AND CIPHERING RESPONSE message.	-->	AUTHENTICATION AND CIPHERING RESPONSE	-	-
3b4	The SS transmits an ATTACH ACCEPT message.	<--	ATTACH ACCEPT	-	-
3b5	The UE transmits an ATTACH COMPLETE message.	-->	ATTACH COMPLETE	-	-
4	The SS releases the RRC connection.	-	-	-	-
5	If possible (see ICS) switch off is performed or the USIM is removed. Otherwise the power is removed.	-	-	-	-
-	EXCEPTION: Step 6 describes behaviour that depends on the UE capability.	-	-	-	-
6	If pc_SwitchOnOff or pc_USIM_Removal then the UE transmits a DETACH REQUEST message	-->	DETACH REQUEST	-	-

9.2.3.2.3.3.3 Specific message contents

Table 9.2.3.2.3.3.3-1: TRACKING AREA UPDATE ACCEPT (step 5, Table 9.2.3.2.3.3.2-1)

Derivation Path: 36.508, Table 4.7.2-24			
Information Element	Value/remark	Comment	Condition
GUTI	GUTI-2		
EPS update result	000	"TA updated"	
EMM cause	'0001 0000'B for k=1 or '0001 0001'B for k=2	MSC temporarily not reachable for k=1 Network failure for k=2	

Table 9.2.3.2.3.3.3-2: TRACKING AREA UPDATE REQUEST (step 9 and 20a3, Table 9.2.3.2.3.3.2-1)

Derivation Path: 36.508, Table 4.7.2-27			
Information Element	Value/remark	Comment	Condition
EPS update type			
EPS update type value	'010'B	Combined TA/LA updating with IMSI attach	

Table 9.2.3.2.3.3.3-3: TRACKING AREA UPDATE ACCEPT (step 12, and 13A3 Table 9.2.3.2.3.3.2-1)

Derivation Path: 36.508, Table 4.7.2-24			
Information Element	Value/remark	Comment	Condition
EPS update result	000	"TA updated"	
GUTI	Not present		
EMM cause	'0001 0000'B for k=1 or '0001 0001'B for k=2	MSC temporarily not reachable for k=1 Network failure for k=2	
T3402	'000 01111'B	30 seconds	
EPS network feature support	0000 0000'B	IMS voice over PS session in S1 mode not supported	

Table 9.2.3.2.3.3.3-4: TRACKING AREA UPDATE ACCEPT (step 20a4, Table 9.2.3.2.3.3.2-1)

Derivation Path: 36.508, Table 4.7.2-24			
Information Element	Value/remark	Comment	Condition
GUTI	Not present		
Location area identification	LAI-1		
MS identity	TMSI-1		

Table 9.2.3.2.3.3.3-5: Message ROUTING AREA UPDATE REQUEST (step 3a1, Table 9.2.3.2.3.3.2-2)

Derivation path: 36.508 table 4.7B.2-1			
Information Element	Value/Remark	Comment	Condition
UE network capability	Not Present	UE does not support S1 mode any more	

Table 9.2.3.2.3.3.3-6: Message ATTACH REQUEST (step 3b1, Table 9.2.3.2.3.3.2-2)

Derivation path: 36.508 table 4.7B.2-6			
Information Element	Value/Remark	Comment	Condition
UE network capability	Not Present	UE does not support S1 mode any more	

Table 9.2.3.2.3.3.3-7: DETACH REQUEST (step 1a1, Table 9.2.3.2.3.3.2-2)

Derivation path: 36.508 table 4.7.2-11, condition EPS_only			
--	--	--	--

9.2.3.2.4 Combined tracking area update / Successful for EPS services only / CS domain not available

9.2.3.2.4.1 Test Purpose (TP)

(1)

```
with { UE having sent a TRACKING AREA UPDATE REQUEST message with EPS update type set to 'Combined
TA/LA updating' }
ensure that {
  when { UE receives a TRACKING AREA UPDATE ACCEPT message with the EPS update result set to 'TA
updated' and the EMM cause set to 'CS domain not available' }
  then { UE transmits TRACKING AREA UPDATE COMPLETE message and set the update status to U2 NOT
UPDATED and enters EMM-REGISTERED state }
}
```

(2)

```
with { UE receives a TRACKING AREA UPDATE ACCEPT message with the EPS update result set to 'TA
updated' and the EMM cause set to 'CS domain not available' }
ensure that {
  when { UE enters a new tracking area }
  then { UE initiates the tracking area updating procedure with EPS update type as "TA updating" }
}
```

9.2.3.2.4.2 Conformance requirements

References: The conformance requirements covered in the present TC are specified in: TS 24.301, clause 5.5.3.3.4.3.

[TS 24.301, clause 5.5.3.3.4.3]

...

#18 (CS domain not available)

The UE shall stop timer T3430 if still running, shall reset the tracking area updating attempt counter, shall set the EPS update status to EU1 UPDATED and shall enter state EMM-REGISTERED.NORMAL-SERVICE.

The UE shall set the update status to U2 NOT UPDATED.

A UE in CS/PS mode 1 of operation with "IMS voice not available" shall attempt to select GERAN or UTRAN radio access technology rather than E-UTRAN for the selected PLMN or equivalent PLMN. The UE shall disable the E-UTRA capability (see subclause 4.5). If the UE is in the EMM-CONNECTED mode, the UE shall locally release the established NAS signalling connection and enter the EMM-IDLE mode before selecting GERAN or UTRAN radio access technology.

A UE in CS/PS mode 2 of operation may provide a notification to the user or the upper layers that the CS domain is not available.

The UE shall not attempt combined attach or combined tracking area updating procedure with current PLMN until switching off the UE or the UICC containing the USIM is removed.

9.2.3.2.4.3 Test description

9.2.3.2.4.3.1 Pre-test conditions

System Simulator:

- cell A (belongs to TAI-1, home PLMN) is set to "Serving cell"
- cell B (belongs to TAI-2, home PLMN) is set to "Non-suitable cell'."
- System information combination 3 as defined in TS 36.508[18] clause 4.4.3.1 is used in E-UTRA cells.

UE:

- the UE is configured to initiate combined attach

Preamble:

- the UE is in state Registered, Idle mode (state 2) on cell A according to TS 36.508 [18].

9.2.3.2.4.3.2 Test procedure sequence

Table 9.2.3.2.4.3.2-1: Main behaviour

St	Procedure	Message Sequence		TP	Verdict
		U - S	Message		
1	Set the cell type of Cell B to the "Serving cell". Set the cell type of Cell A to the "non-Suitable cell".	-	-	-	-
-	The following messages are sent and shall be received on Cell B.	-	-	-	-
2	The UE transmits a TRACKING AREA UPDATE REQUEST message.	-->	TRACKING AREA UPDATE REQUEST	-	-
3	The SS transmits a TRACKING AREA UPDATE ACCEPT message.	<--	TRACKING AREA UPDATE ACCEPT	-	-
4	Check: Does the UE transmit a TRACKING AREA UPDATE COMPLETE message.	-->	TRACKING AREA UPDATE COMPLETE	1	P
5	The SS releases the RRC connection.	-	-	-	-
5A	Wait 15 seconds for UE to camp on Cell B (UE might attempt to select GERAN or UTRAN cells)	-	-	-	-
6	Void	-	-	-	-
6A	Void	-	-	-	-
7	Check: Does the test result of generic test procedure in TS 36.508 subclause 6.4.2.2 indicate that the UE is in state Registered, Idle Mode on Cell B?	-	-	1	P
8	Set the cell type of Cell A to the "Serving cell". Set the cell type of Cell B to the "non-Suitable cell".	-	-	-	-
9	Check: Does the UE transmit a TRACKING AREA UPDATE REQUEST message with EPS update type as "TA updating"?	-->	TRACKING AREA UPDATE REQUEST	2	P
10	The SS transmits a TRACKING AREA UPDATE ACCEPT message.	<--	TRACKING AREA UPDATE ACCEPT	-	-
11	The UE transmits a TRACKING AREA UPDATE COMPLETE message.	-->	TRACKING AREA UPDATE COMPLETE	-	-
-	At the end of this test procedure sequence, the UE is PS attached in end state E-UTRA connected (E2_T3440) according to TS 36.508.	-	-	-	-

9.2.3.2.4.3.3 Specific message contents

Table 9.2.3.2.4.3.3-1: Message TRACKING AREA UPDATE REQUEST (step 2, Table 9.2.3.2.4.3.2-1)

Derivation path: 36.508 table 4.7.2-27			
Information Element	Value/Remark	Comment	Condition
EPS update type			
EPS update type Value	'001'B	"combined TA/LA updating"	

Table 9.2.3.2.4.3.3-2: TRACKING AREA UPDATE ACCEPT (step 3, Table 9.2.3.2.4.3.2-1)

Derivation Path: 36.508, Table 4.7.2-24			
Information Element	Value/remark	Comment	Condition
GUTI	GUTI-2		
EMM cause	'00010010'B	"CS domain not available"	
EPS update result	'000'B	"TA updated"	

Table 9.2.3.2.4.3.3-3: Message TRACKING AREA UPDATE REQUEST (step 9, Table 9.2.3.2.4.3.2-1)

Derivation path: 36.508 table 4.7.2-27 with condition TA_only.			
--	--	--	--

Table 9.2.3.2.4.3.3-4: TRACKING AREA UPDATE ACCEPT (step 10, Table 9.2.3.2.4.3.2-1)

Derivation Path: 36.508, Table 4.7.2-24 with condition TA_only.			
Information Element	Value/remark	Comment	Condition
GUTI	GUTI-1		

9.2.3.2.5 Combined tracking area update / Rejected / IMSI invalid

9.2.3.2.5.1 Test Purpose (TP)

(1)

```

with { UE having sent a TRACKING AREA UPDATE REQUEST message with EPS update type set to 'Combined TA/LA updating' }
ensure that {
  when { UE receives a TRACKING AREA UPDATE REJECT message with the EMM cause set to 'Illegal UE' }
  then { UE considers the USIM as invalid for EPS services and non-EPS services and enters state EMM-DEREGISTERED }
}

```

(2)

```

with { The UE is in the state EMM-DEREGISTERED }
ensure that {
  when { UE is powered up }
  then { UE send ATTACH REQUEST message with Old GUTI or IMSI IE = ''IMSI'' }
}

```

9.2.3.2.5.2 Conformance requirements

References: The conformance requirements covered in the present TC are specified in: TS 24.301, clause 5.5.3.3.5.

[TS 24.301, clause 5.5.3.3.5]

If the combined tracking area updating cannot be accepted by the network, the MME shall send a TRACKING AREA UPDATE REJECT message to the UE including an appropriate EMM cause value.

Upon receiving the TRACKING AREA UPDATE REJECT message, the UE shall stop timer T3430, stop any transmission of user data, enter state MM IDLE, and take the following actions depending on the EMM cause value received.

#3 (Illegal UE);

...

The UE shall set the EPS update status to EU3 ROAMING NOT ALLOWED (and shall store it according to subclause 5.1.3.3) and shall delete any GUTI, last visited registered TAI, TAI List and eKSI.

The UE shall consider the USIM as invalid for EPS and non-EPS services until switching off or the UICC containing the USIM is removed. Additionally, the UE shall delete the list of equivalent PLMNs and shall enter the state EMM-DEREGISTERED.

If A/Gb mode or Iu mode is supported by the UE, the UE shall handle the MM parameters update status, TMSI, LAI and ciphering key sequence number, and the GMM parameters GMM state, GPRS update status, P-TMSI, P-TMSI signature, RAI and GPRS ciphering key sequence number as specified in 3GPP TS 24.008 [13] for the case when the combined routing area updating procedure is rejected with the GMM cause with the same value.

9.2.3.2.5.3 Test description

9.2.3.2.5.3.1 Pre-test conditions

System Simulator:

- cell A, cell B and cell C;
- if pc_UTRA AND px_RATComb_Tested = EUTRA_UTRA, cell 9 (belongs to LAI-1 and RAI-1, home PLMN) is configured;
- if pc_GERAN AND px_RATComb_Tested = EUTRA_GERAN, cell 24 (belongs to LAI-1 and RAI-1, home PLMN) is configured;
- cell A is "Serving cell" and cell B, cell C, cell 9 and cell 24 are "Non-suitable "off" cell".
- System information combination 10a as defined in TS 36.508[18] clause 4.4.3.1 is used in E-UTRA cells.

NOTE: Setting px_RATComb_Tested = EUTRA_Only is not allowed.

UE:

- the UE is configured to initiate combined EPS/IMSI attach.

Preamble:

- the UE is in state Registered, Idle mode (state 2) on cell A according to TS 36.508 [18].

9.2.3.2.5.3.2 Test procedure sequence

Table 9.2.3.2.5.3.2-1: Main behaviour

St	Procedure	Message Sequence		TP	Verdict
		U - S	Message		
1	Set the cell type of Cell A to the "non-Suitable "off" cell". Set the cell type of Cell B to the "Serving cell".	-	-	-	-
-	The following messages are to be observed on Cell B unless explicitly stated otherwise.	-	-	-	-
2	The UE transmits a TRACKING AREA UPDATE REQUEST message.	-->	TRACKING AREA UPDATE REQUEST	-	-
3	The SS transmits a TRACKING AREA UPDATE REJECT message with the EMM cause set to 'Illegal UE'.	<--	TRACKING AREA UPDATE REJECT	-	-
4	The SS releases the RRC connection.	-	-	-	-
5	Set the cell type of Cell B to the "non-Suitable "off" cell". Set the cell type of Cell C to the "Serving cell".	-	-	-	-
-	The following messages are to be observed on Cell C unless explicitly stated otherwise.	-	-	-	-
6	Check: Does the UE transmit an ATTACH REQUEST message in the next 30 seconds?	-->	ATTACH REQUEST	1	F
-	EXCEPTION: Steps 7a1 to 7a2 describe behaviour that depends on the UE capability; the "lower case letter" identifies a step sequence that take place if a capability is supported	-	-	-	-
7a1	The SS sets the cell type of the cell other than Cell 9 and Cell 24 to the "non-Suitable "off" cell" and sets the cell type of Cell 9 (px_RATComb_Tested = EUTRA_UTRA) or Cell 24 (px_RATComb_Tested = EUTRA_GERAN) to the "Serving cell".	-	-	-	-
-	The following messages are to be observed on Cell 9 or Cell 24 unless explicitly stated otherwise.	-	-	-	-
7a2	Check: Does the UE transmit an ATTACH REQUEST message in the next 30 seconds?	-->	ATTACH REQUEST	1	F
8	Set the cell type of the cell other than Cell A to the "non-Suitable "off" cell". Set the cell type of Cell A to the "Serving cell".	-	-	-	-
-	The following messages are to be observed on Cell A unless explicitly stated otherwise.	-	-	-	-
9	Check: Does the UE transmit an ATTACH REQUEST message in the next 30 seconds?	-->	ATTACH REQUEST	1	F
10	If possible (see ICS) switch off is performed or the USIM is removed. Otherwise the power is removed.	-	-	-	-
11	The UE is brought back to operation or the USIM is inserted.	-	-	-	-
12	Check: Does the UE transmit an ATTACH REQUEST message on cell A?	-->	ATTACH REQUEST	2	P
13-24	The attach procedure is completed by executing steps 5 to 16 of the UE registration procedure in TS 36.508 sub clause 4.5.2.3.	-	-	-	-
-	At the end of this test procedure sequence, the UE is in end state E-UTRA connected (E2) according to TS 36.508.	-	-	-	-

9.2.3.2.5.3.3 Specific message contents

Table 9.2.3.2.5.3.3-1: TRACKING AREA UPDATE REJECT (step 3, Table 9.2.3.2.5.3.2-1)

Derivation Path: 36.508, Table 4.7.2-26			
Information Element	Value/remark	Comment	Condition
EMM cause	'0000 0011'B	Illegal UE	

Table 9.2.3.2.5.3.3-2: Message ATTACH REQUEST (step 12, Table 9.2.3.2.5.3.2-1)

Derivation Path: TS 36.508, Table 4.7.2-4			
Information Element	Value/remark	Comment	Condition
Old GUTI or IMSI	IMSI		

9.2.3.2.6 Combined tracking area update / Rejected / Illegal ME

9.2.3.2.6.1 Test Purpose (TP)

(1)

```

with { UE having sent a TRACKING AREA UPDATE REQUEST message with EPS update type set to 'Combined
TA/LA updating' }
ensure that {
  when { UE receives a TRACKING AREA UPDATE REJECT message with the EMM cause set to 'Illegal ME' }
    then { UE considers the USIM as invalid for EPS services and non-EPS services and enters state
EMM-DEREGISTERED }
}

```

(2)

```

with { The UE is in the state EMM-DEREGISTERED }
ensure that {
  when { UE is powered up }
    then { UE send ATTACH REQUEST message with Old GUTI or IMSI IE = ''IMSI'' }
}

```

9.2.3.2.6.2 Conformance requirements

References: The conformance requirements covered in the present TC are specified in: TS 24.301, clause 5.5.3.3.5.

[TS 24.301, clause 5.5.3.3.5]

If the combined tracking area updating cannot be accepted by the network, the MME shall send a TRACKING AREA UPDATE REJECT message to the UE including an appropriate EMM cause value.

Upon receiving the TRACKING AREA UPDATE REJECT message, the UE shall stop timer T3430, stop any transmission of user data, enter state MM IDLE, and take the following actions depending on the EMM cause value received.

...

#6 (Illegal ME); or

...

The UE shall set the EPS update status to EU3 ROAMING NOT ALLOWED (and shall store it according to subclause 5.1.3.3) and shall delete any GUTI, last visited registered TAI, TAI List and eKSI.

The UE shall consider the USIM as invalid for EPS and non-EPS services until switching off or the UICC containing the USIM is removed. Additionally, the UE shall delete the list of equivalent PLMNs and shall enter the state EMM-DEREGISTERED.

If A/Gb mode or Iu mode is supported by the UE, the UE shall handle the MM parameters update status, TMSI, LAI and ciphering key sequence number, and the GMM parameters GMM state, GPRS update status, P-TMSI, P-TMSI signature, RAI and GPRS ciphering key sequence number as specified in 3GPP TS 24.008 [13] for the case when the combined routing area updating procedure is rejected with the GMM cause with the same value.

9.2.3.2.6.3 Test description

The test description is identical to the one of subclause 9.2.3.2.5 except that the reject cause #3 "Illegal UE" is replaced with the reject cause #6 "Illegal ME".

9.2.3.2.7 Combined tracking area update / Rejected / EPS services and non-EPS services not allowed

9.2.3.2.7.1 Test Purpose (TP)

(1)

```
with { UE having sent a TRACKING AREA UPDATE REQUEST message with EPS update type set to 'Combined
TA/LA updating' }
ensure that {
  when { UE receives a TRACKING AREA UPDATE REJECT message with the EMM cause set to 'EPS services
and non-EPS services not allowed' }
    then { UE considers the USIM as invalid for EPS services and non-EPS services and enters state
EMM-DEREGISTERED }
}
```

(2)

```
with { The UE is in the state EMM-DEREGISTERED }
ensure that {
  when { UE is powered up }
    then { UE send ATTACH REQUEST message with Old GUTI or IMSI IE = ''IMSI'' }
```

9.2.3.2.7.2 Conformance requirements

References: The conformance requirements covered in the current TC are specified in: TS 24.301, clause 5.5.3.3.5.

[TS 24.301, clause 5.5.3.3.5]

...

#3 (Illegal UE);

#6 (Illegal ME); or

#8 (EPS services and non-EPS services not allowed);

The UE shall set the EPS update status to EU3 ROAMING NOT ALLOWED (and shall store it according to subclause 5.1.3.3) and shall delete any GUTI, last visited registered TAI, TAI List and KSI.

The UE shall consider the USIM as invalid for EPS and non-EPS services until switching off or the UICC containing the USIM is removed. Additionally, the UE shall delete the list of equivalent PLMNs and shall enter the state EMM-DEREGISTERED.

If A/Gb mode or Iu mode is supported by the UE, the UE shall handle the MM parameters update status, TMSI, LAI and ciphering key sequence number, and the GMM parameters GMM state, GPRS update status, P-TMSI, P-TMSI signature, RAI and GPRS ciphering key sequence number as specified in 3GPP TS 24.008 [13] for the case when the combined routing area updating procedure is rejected with the GMM cause with the same value.

...

9.2.3.2.7.3 Test description

The test description is identical to the one of subclause 9.2.3.2.5 except that the reject cause #3 "Illegal UE" is replaced with the reject cause #8 "EPS services and non-EPS services not allowed".

9.2.3.2.8 Combined tracking area update / Rejected / EPS services not allowed

9.2.3.2.8.1 Test Purpose (TP)

(1)

```
with { UE having sent a TRACKING AREA UPDATE REQUEST message with EPS update type set to 'Combined
TA/LA updating' }
```

```

ensure that {
  when { UE receives a TRACKING AREA UPDATE REJECT message with the EMM cause set to 'EPS services
not allowed' }
    then { UE considers the USIM as invalid for EPS services and enters state EMM-DEREGISTERED }
}

```

(2)

```

with { UE in CS/PS mode 1 or CS/PS mode 2 of operation and have been IMSI attached for non-EPS
services }
ensure that {
  when { UE sends a TRACKING AREA UPDATE REQUEST message with EPS update type set to 'Combined TA/LA
updating' and receives a TRACKING AREA UPDATE REJECT message with the EMM cause set to 'EPS services
not allowed' }
    then { The UE shall still IMSI attached for non-EPS services }
}

```

9.2.3.2.8.2 Conformance requirements

References: The conformance requirements covered in the present TC are specified in: TS 24.301, clause 5.5.3.3.5.

[TS 24.301, clause 5.5.3.3.5]

If the combined tracking area updating cannot be accepted by the network, the MME shall send a TRACKING AREA UPDATE REJECT message to the UE including an appropriate EMM cause value.

Upon receiving the TRACKING AREA UPDATE REJECT message, the UE shall stop timer T3430, stop any transmission of user data, enter state MM IDLE, and take the following actions depending on the EMM cause value received.

...

#7 (EPS services not allowed);

The UE shall set the EPS update status to EU3 ROAMING NOT ALLOWED (and shall store it according to subclause 5.1.3.3) and shall delete any GUTI, last visited registered TAI, TAI List and KSI. The UE shall consider then USIM as invalid for EPS services until switching off or the UICC containing the USIM is removed. The UE shall delete the list of equivalent PLMNs and shall enter the state EMM-DEREGISTERED.

A UE in CS/PS mode 1 or CS/PS mode 2 of operation is still IMSI attached for non-EPS services. The UE shall set the update status to U2 NOT UPDATED, shall select GERAN or UTRAN radio access technology and proceed with appropriate MM specific procedure according to the MM service state. The UE shall not reselect E-UTRAN radio access technology until switching off or the UICC containing the USIM is removed.

NOTE: Some interaction is required with the access stratum to disable E-UTRAN cell reselection.

If A/Gb mode or Iu mode is supported by the UE, the UE shall in addition handle the GMM parameters GMM state, GPRS update status, P-TMSI, P-TMSI signature, RAI and GPRS ciphering key sequence number as specified in 3GPP TS 24.008 [13] for the case when the combined routing area updating procedure is rejected with the GMM cause with the same value.

9.2.3.2.8.3 Test description

9.2.3.2.8.3.1 Pre-test conditions

System Simulator:

- cell A (belongs to TAI-1, home PLMN) is set to "Serving cell";
- cell B (belongs to TAI-2(, home PLMN) is set to "Non-suitable cell";
- cell G (belongs to TAI-7, visited PLMN) is set to "Non-suitable off cell";
- if pc_UTRA AND px_RATComb_Testcd = EUTRA_UTRA, cell 9 (belongs to LAI-1 and RAI-1, home PLMN) is configured;
- if pc_GERAN AND px_RATComb_Testcd = EUTRA_GERAN, cell 24 (belongs to LAI-1 and RAI-1, home PLMN) is configured;

- Set the cell type of cell 9 or cell 24 to the " Non-Suitable off cell ".
- the different cells may not be simultaneously activated.
- System information combination 10 as defined in TS 36.508[18] clause 4.4.3.1 is used in E-UTRA cells.

NOTE: Setting px_RATComb_Tested = EUTRA_Only is not allowed.

UE:

- the UE is configured to initiate combined EPS/IMSI attach.

Preamble:

- the UE is in state Registered, Idle Mode (state 2) on cell A according to TS 36.508 [18].

9.2.3.2.8.3.2 Test procedure sequence

Table 9.2.3.2.8.3.2-1: Main behaviour

St	Procedure	Message Sequence		TP	Verdict
		U - S	Message		
1	The SS configures: Cell A as the "non-Suitable cell". Cell B as the "Serving cell".	-	-	-	-
2	The UE transmits a TRACKING AREA UPDATE REQUEST on Cell B.	-->	TRACKING AREA UPDATE REQUEST	-	-
3	The SS transmits a TRACKING AREA UPDATE REJECT message with the EMM cause set to as "EPS services not allowed" as specified.	<--	TRACKING AREA UPDATE REJECT	-	-
4	The SS releases the RRC connection.	-	-	-	-
5	The SS configures: Cell A as the "Serving cell". Cell B as the "non-Suitable cell".	-	-	-	-
6	Check: Does the UE transmit an ATTACH REQUEST message in the next 30 seconds on cell A? Note: Cell A belongs to the same PLMN where the UE was rejected but a different TAI	-->	ATTACH REQUEST	1	F
7	The user initiates an attach by MMI or by AT command.	-	-	-	-
8	Check: Does the UE transmit an ATTACH REQUEST message in the next 30 seconds on cell A?	-->	ATTACH REQUEST	1	F
9	The SS configures: Cell A as the "non-Suitable cell", Cell B as the "non-Suitable "off" cell". Cell G as the "Serving cell".	-	-	-	-
10	Check: Does the UE transmit an ATTACH REQUEST message in the next 30 seconds on cell G? Note: Cell G belongs to a PLMN which is not the same like the one on which the UE was rejected.	-->	ATTACH REQUEST	1	F
11	The user initiates an attach by MMI or by AT command.	-	-	-	-
12	Check: Does the UE transmit an ATTACH REQUEST message in the next 30 seconds on cell G?	-->	ATTACH REQUEST	1	F
13	The SS configures: Cell G as the "Serving cell". Cell 9 or 24 as the "Suitable cell".	-	-	-	-
	EXCEPTION: Steps 14a1 to 14a5 describe behaviour that depends on the UE capability; the "lower case letter" identifies a step sequence that take place if a capability is supported				
14a1	The following messages are sent and shall be received on Cell 9 (px_RATComb_Tested = EUTRA_UTRA) or 24 (px_RATComb_Tested = EUTRA_GERAN).	-	-	-	-
14a2	Check: Does the UE transmit a LOCATION UPDATING REQUEST message on Cell 9 or 24?	-->	LOCATION UPDATING REQUEST	2	P
-	EXCEPTION: The messages in the next two steps are sent only on Cell 24	-	-	-	-
14a2 Aa1	The UE transmits a <i>Classmark Change</i> message	-->	CLASSMARK CHANGE		

-	EXCEPTION: The next step describes behaviour that depends on UE capability.	-	-	-	-
14a2 Aa2	IF pc_UTRA THEN the UE transmits a <i>Utran Classmark Change</i> message.	-->	UTRAN CLASSMARK CHANGE.		
14a3	The SS transmits an AUTHENTICATION REQUEST message to initiate the authentication and AKA procedure.	<--	AUTHENTICATION REQUEST	-	-
14a4	The UE transmits an AUTHENTICATION RESPONSE message.	-->	AUTHENTICATION RESPONSE	-	-
14a5	The SS transmits a LOCATION UPDATING ACCEPT message with Location updating type = "IMSI attach" as specified in 3GPP TS 24.008.	<--	LOCATION UPDATING ACCEPT	-	-
15	The SS configures: Cell G as the "Serving cell". Cell 9 or 24 as the "non-Suitable cell".	-	-	-	-
16	The user initiates attach by MMI or by AT command.	-	-	-	-
17	Check: Does the UE transmit an ATTACH REQUEST message in the next 30 seconds on cell G?	-->	ATTACH REQUEST	1	F

9.2.3.2.8.3.3 Specific message contents

Table 9.2.3.2.8.3.3-1: Message TRACKING AREA UPDATE REQUEST (step 2, Table 9.2.3.2.8.3.2-1)

Derivation path: 36.508 table 4.7.2-27			
Information Element	Value/Remark	Comment	Condition
EPS update type			
EPS update type Value	'001'B	" combined TA/LA updating "	
Old GUTI	GUTI-1		

Table 9.2.3.2.8.3.3-2: Message TRACKING AREA UPDATE REJECT (step 3, Table 9.2.3.2.8.3.2-1)

Derivation path: 36.508 table 4.7.2-24			
Information Element	Value/Remark	Comment	Condition
EMM cause	'00000111'B	"EPS services not allowed"	

Table 9.2.3.2.8.3.3-3: LOCATION UPDATING REQUEST (step 14a2, Table 9.2.3.2.8.3.2-1)

Derivation Path: TS 36.508 Table 4.7B.2-4			
Information Element	Value/remark	Comment	Condition
Location updating type	IMSI attach		

Table 9.2.3.2.8.3.3-4: LOCATION UPDATING ACCEPT (step 14a5, Table 9.2.3.2.8.3.2-1)

Derivation Path: TS 36.508 Table 4.7B.2-5			
Information Element	Value/remark	Comment	Condition
Mobile identity	Not present		

9.2.3.2.9 Combined tracking area update / Rejected / UE identity cannot be derived by the network

9.2.3.2.9.1 Test Purpose (TP)

(1)

with { UE has sent a TRACKING AREA UPDATE REQUEST message with EPS update type set to 'Combined TA/LA updating' }

```

ensure that {
  when { UE receives a TRACKING AREA UPDATE REJECT message with the EMM cause set to 'UE identity
cannot be derived by the network' }
    then { UE deletes GUTI, last visited registered TAI, TAI list and KSI, enters the state EMM-
DEREGISTERED, subsequently, automatically initiates the attach procedure and is still IMSI attached
for non-EPS services }
}

```

(2)

```

with { UE has sent a TRACKING AREA UPDATE REQUEST message with EPS update type set to 'Combined
TA/LA updating' }
ensure that {
  when { UE receives a TRACKING AREA UPDATE REJECT message with the EMM cause set to 'UE identity
cannot be derived by the network' }
    then { UE deletes P-TMSI, P-TMSI signature, RAI and GPRS ciphering key sequence number }
}

```

9.2.3.2.9.2 Conformance requirements

References: The conformance requirements covered in the present TC are specified in: TS 24.301, clause 5.5.3.3.5 and TS 24.008, clause 4.7.5.2.4.

[TS 24.301, clause 5.5.3.3.5]

If the combined tracking area updating cannot be accepted by the network, the MME shall send a TRACKING AREA UPDATE REJECT message to the UE including an appropriate EMM cause value.

Upon receiving the TRACKING AREA UPDATE REJECT message, the UE shall stop timer T3430, stop any transmission of user data, enter state MM IDLE, and take the following actions depending on the EMM cause value received.

...

#9 (UE identity cannot be derived by the network);

The UE shall set the EPS update status to EU2 NOT UPDATED (and shall store it according to subclause 5.1.3.3) and shall delete any GUTI, last visited registered TAI, TAI List and eKSI. The UE shall delete the list of equivalent PLMNs and enter the state EMM-DEREGISTERED.

Subsequently, the UE shall automatically initiate the attach procedure.

NOTE 2: User interaction is necessary in some cases when the UE cannot re-activate the EPS bearer(s) automatically.

If A/Gb mode or Iu mode is supported by the UE, the UE shall in addition handle the GMM parameters GMM state, GPRS update status, P-TMSI, P-TMSI signature, RAI and GPRS ciphering key sequence number as specified in 3GPP TS 24.008 [13] for the case when the combined routing area updating procedure is rejected with the GMM cause with the same value.

A UE in CS/PS mode 1 or CS/PS mode 2 of operation is still IMSI attached for non-EPS services. The UE shall set the update status to U2 NOT UPDATED.

[TS 24.008, clause 4.7.5.2.4]

The MS shall then take different actions depending on the received reject cause:

...

9 (MS identity cannot be derived by the network);

The MS shall set the GPRS update status to GU2 NOT UPDATED (and shall store it according to subclause 4.1.3.2), enter the state GMM-DEREGISTERED, and shall delete any P-TMSI, P-TMSI signature, RAI and GPRS ciphering key sequence number. Subsequently, the MS may automatically initiate the GPRS attach procedure.

9.2.3.2.9.3 Test description

9.2.3.2.9.3.1 Pre-test conditions

System Simulator:

- cell A (belongs to TAI-1, home PLMN) is set to "Serving cell";
- cell B (belongs to TAI-2, home PLMN) is set to "Non-suitable cell";
- if pc_UTRA AND px_RATComb_Tested = EUTRA_UTRA, cell 5 (belongs to TAI-1, home PLMN) is set to "Non-Suitable cell";
- if pc_GERAN AND px_RATComb_Tested = EUTRA_GERAN, cell 24 (belongs to TAI-1, home PLMN) is set to "Non-Suitable cell";
- System information combination 10a as defined in TS 36.508[18] clause 4.4.3.1 is used in E-UTRA cells.

NOTE: Setting px_RATComb_Tested = EUTRA_Only is not allowed.

UE:

- the UE is configured to initiate combined EPS/IMSI attach.
- if pc_UTRA AND px_RATComb_Tested = EUTRA_UTRA, the UE is previously registered on UTRAN cell 5 using default message contents according to TS 36.508 [18].
- if pc_GERAN AND px_RATComb_Tested = EUTRA_GERAN, the UE is previously registered on GERAN cell 24 using default message contents according to TS 36.508 [18].

Preamble:

- the UE is in state Registered, Idle mode (state 2) on cell A according to TS 36.508 [18].

9.2.3.2.9.3.2 Test procedure sequence

Table 9.2.3.2.9.3.2-1: Main behaviour

St	Procedure	Message Sequence		TP	Verdict
		U - S	Message		
1	Set the cell type of Cell A to the "Non-Suitable cell". Set the cell type of Cell B to the "Serving cell".	-	-	-	-
-	The following messages are to be observed on Cell B unless explicitly stated otherwise.	-	-	-	-
2	The UE transmits a TRACKING AREA UPDATE REQUEST.	-->	TRACKING AREA UPDATE REQUEST	-	-
3	The SS transmits a TRACKING AREA UPDATE REJECT message with EMM cause set to "UE identity cannot be derived by the network".	<--	TRACKING AREA UPDATE REJECT	-	-
-	EXCEPTION: Steps 3a1-3a2 describes the behaviour that depends on UE behaviour (Note 2).	-	-	-	-
3a1	The SS releases the RRC connection.	-	-	-	-
-	EXCEPTION: Step 3a2 describes a behaviour which depends on the UE capability	-	-	-	-
3a2	IF NOT pc_Automatic_EPS_Re_Attach , the user initiates an attach by MMI or by AT command.	-	-	-	-
4	Check: Does the UE transmit an ATTACH REQUEST message in the next 30 seconds?	-->	ATTACH REQUEST	1	P
4Aa1 - 4Aa1 3	Void	-	-	-	-
-	EXCEPTION: Steps 5a1 to 5a28 describe behaviour that depends on the UE capability; the "lower case letter" identifies a step sequence that take place if a capability is supported	-	-	-	-
5a1	The SS sets the cell type of Cell B to the "non-Suitable cell" and sets the cell type of Cell 5 (px_RATComb_Tested = EUTRA_UTRA) or Cell 24 (px_RATComb_Tested = EUTRA_GERAN) to the "Serving cell".	-	-	-	-
-	The following messages are to be observed on Cell 5 or Cell 24 unless explicitly stated otherwise.	-	-	-	-
5a2	Void	-	-	-	-
5a3	Check: Does the UE transmit an ATTACH REQUEST message?	-->	ATTACH REQUEST	2	P
5a4- 5a24	Void	-	-	-	-
5a25 - 5a28	Void	-	-	-	-
5a29	The SS transmits an ATTACH REJECT message	<--	ATTACH REJECT	-	-
-	At the end of this test procedure sequence, the UE is in end state UTRA deregistered (U6) or GERAN deregistered (G5) according to TS 36.508.	-	-	-	-
Note 2: SS waits for 1 second to receive the Attach Request on the existing RRC Connection. In case Attach Request is not received within 1 second, existing RRC Connection is released.					

9.2.3.2.9.3.3 Specific message contents

Table 9.2.3.2.9.3.3-1: Message TRACKING AREA UPDATE REQUEST (step 2, Table 9.2.3.2.9.3.2-1)

Derivation Path: TS 36.508, Table 4.7.2-27			
Information Element	Value/remark	Comment	Condition
Old GUTI	GUTI-1		
Old location area identification	LAI-1		
TMSI status	Not present		

Table 9.2.3.2.9.3.3-2: Message TRACKING AREA UPDATE REJECT (step 3, Table 9.2.3.2.9.3.2-1)

Derivation Path: TS 36.508, Table 4.7.2-26			
Information Element	Value/remark	Comment	Condition
EMM cause	'0000 1001'B	UE identity cannot be derived by the network	

Table 9.2.3.2.9.3.3-3: Message ATTACH REQUEST (step 4, Table 9.2.3.2.9.3.2-1)

Derivation Path: TS 36.508, Table 4.7.2-4			
Information Element	Value/remark	Comment	Condition
NAS key set identifier			
NAS key set identifier	'111'B	no key is available	
TSC	Any allowed value	TSC does not apply for NAS key set identifier value "111".	
Old GUTI or IMSI	IMSI		
Old P-TMSI signature	Not present		
Last visited registered TAI	Not present		
Old location area identification	Not Present or LAI-1		
TMSI status	Not present or any allowed value		

Table 9.2.3.2.9.3.3-4: Message ATTACH REQUEST (step 5a3, Table 9.2.3.2.9.3.2-1)

Derivation Path: TS 24.008 , Table 9.4.1			
Information Element	Value/remark	Comment	Condition
MS network capability	Any allowed value		
Attach type	'011'B	Combined GPRS/IMSI attach	
GPRS ciphering key sequence number	'111'B	No key is available (MS to network)	
DRX parameter	Any allowed value		
P-TMSI or IMSI	IMSI-1		
Old routing area identification	All bits of octets 5 and 6 are set to 1, except bit 1 of octet 6 which is set to 0. Other bits are not checked.		
MS Radio Access capability	Any allowed value		
Old P-TMSI signature	Not present		
Requested READY timer value	Not present or any allowed value		
TMSI status	Not present or any allowed value		
PS LCS Capability	Not present or any allowed value		
Mobile station classmark 2	Not present or any allowed value		
Mobile station classmark 3	Not present or any allowed value		
Supported Codecs	Not present or any allowed value		
UE network capability	Not present or any allowed value		
Additional mobile identity	Not present		
Additional old routing area identification	Not present		

Table 9.2.3.2.9.3.3-5: Message ATTACH REJECT (step 5a29, Table 9.2.3.2.9.3.2-1)

Derivation Path: TS 24.008 , Table 9.4.4			
Information Element	Value/remark	Comment	Condition
GMM cause	'00001000'B	GPRS services and non-GPRS services not allowed	

9.2.3.2.10 Combined tracking area update / Rejected / UE implicitly detached

9.2.3.2.10.1 Test Purpose (TP)

(1)

```

with { UE having sent a TRACKING AREA UPDATE REQUEST message with EPS update type set to 'Combined TA/LA updating' }
ensure that {
  when { UE receives a TRACKING AREA UPDATE REJECT message with the EMM cause set to 'Implicitly detached' }
  then { UE sends an ATTACH REQUEST message }
}

```

9.2.3.2.10.2 Conformance requirements

References: The conformance requirements covered in the present TC are specified in: TS 24.301, clause 5.5.3.3.5.

[TS 24.301, clause 5.5.3.3.5]

If the combined tracking area updating cannot be accepted by the network, the MME shall send a TRACKING AREA UPDATE REJECT message to the UE including an appropriate EMM cause value.

Upon receiving the TRACKING AREA UPDATE REJECT message, the UE shall stop timer T3430, stop any transmission of user data, enter state MM IDLE, and take the following actions depending on the EMM cause value received.

...

#10 (Implicitly detached);

The UE shall delete the list of equivalent PLMNs and shall enter the state EMM-DEREGISTERED.NORMAL-SERVICE. The UE shall perform a new attach procedure.

NOTE 3: User interaction is necessary in some cases when the UE cannot re-activate the EPS bearer(s) automatically.

...

9.2.3.2.10.3 Test description

9.2.3.2.10.3.1 Pre-test conditions

System Simulator:

- cell A and cell B;
- cell A is set to the "Serving cell" and cell B is set to the "non-Suitable cell".
- System information combination 3 as defined in TS 36.508[18] clause 4.4.3.1 is used in E-UTRA cells.

UE:

- the UE is configured to initiate combined EPS/IMSI attach.

Preamble:

- the UE is in state Registered, Idle mode (state 2) on cell A according to 36.508 [18].

9.2.3.2.10.3.2 Test procedure sequence

Table 9.2.3.2.10.3.2-1: Main behaviour

St	Procedure	Message Sequence		TP	Verdict
		U - S	Message		
1	Set the cell type of Cell A to the "non-Suitable cell". Set the cell type of Cell B to the "Serving cell".	-	-	-	-
-	The following messages are to be observed on Cell B unless explicitly stated otherwise.	-	-	-	-
2	The UE transmits a TRACKING AREA UPDATE REQUEST message.	-->	TRACKING AREA UPDATE REQUEST	-	-
3	The SS transmits a TRACKING AREA UPDATE REJECT message with the EMM cause set to 'Implicitly detached'.	<--	TRACKING AREA UPDATE REJECT	-	-
-	EXCEPTION: Steps 3a1-3a2 describes the behaviour that depends on UE behaviour (Note 1).	-	-	-	-
3a1	The SS releases the RRC connection.	-	-	-	-
-	EXCEPTION: Step 3a2 describes a behaviour which depends on the UE capability	-	-	-	-
3a2	IF NOT pc_Automatic_EPS_Re_Attach , the user initiates an attach by MMI or by AT command.	-	-	-	-
4	Check: Does the UE transmit an ATTACH REQUEST message including a PDN CONNECTIVITY REQUEST message?	-->	ATTACH REQUEST	1	P
5-16	The attach procedure is completed by executing steps 5 to 16 of the UE registration procedure in TS 36.508 sub clause 4.5.2.3.	-	-	-	-
-	At the end of this test procedure sequence, the UE is in end state E-UTRA connected (E2) according to TS 36.508.	-	-	-	-
Note 1: SS waits for 1 second to receive the Attach Request on the existing RRC Connection. In case Attach Request is not received within 1 second, existing RRC Connection is released.					

9.2.3.2.10.3.3 Specific message contents

Table 9.2.3.2.10.3.3-1: TRACKING AREA UPDATE REJECT (step 3, Table 9.2.3.2.10.3.2-1)

Derivation Path: TS 36.508 Table 4.7.2-26			
Information Element	Value/remark	Comment	Condition
EMM cause	'0000 1010'B	Implicitly detached	

9.2.3.2.11 Combined tracking area update / Rejected / PLMN not allowed

9.2.3.2.11.1 Test Purpose (TP)

(1)

```

with { UE has sent a TRACKING AREA UPDATE REQUEST message }
ensure that {
  when { UE receives a TRACKING AREA UPDATE REJECT message with the EMM cause set to 'PLMN not allowed' }
  then { UE deletes GUTI, last visited registered TAI, TAI list and KSI, enters the state EMM-DEREGISTERED.PLMN-SEARCH, stores the PLMN identity in the "forbidden PLMN list" }
}

```

(2)

```

with { UE has sent a TRACKING AREA UPDATE REQUEST message }
ensure that {
  when { UE receives a TRACKING AREA UPDATE REJECT message with the EMM cause set to 'PLMN not allowed' }
  then { UE deletes P-TMSI, P-TMSI signature, TMSI, RAI, LAI, ciphering key sequence number GPRS ciphering key sequence number }
}

```

```
    }
```

(3)

```
with { UE is switched off and a PLMN is stored in the "forbidden PLMN list" }
ensure that {
  when { UE is powered on this PLMN }
  then { UE doesn't perform an attach procedure }
}
```

(4)

```
with { UE in EMM-DEREGISTERED.PLMN-SEARCH state and a PLMN is stored in the "forbidden PLMN list" }
ensure that {
  when { UE enters a cell belonging to a PLMN which is not in the "forbidden PLMN list" }
  then { UE initiates an attach procedure }
}
```

(5)

```
with { UE in EMM-DEREGISTERED.PLMN-SEARCH state and a PLMN is stored in the "forbidden PLMN list" }
ensure that {
  when { UE is in a forbidden PLMN cells and when the PLMN is selected manually }
  then { UE initiates an attach procedure }
}
```

9.2.3.2.11.2 Conformance requirements

References: The conformance requirements covered in the present TC are specified in: TS 24.301, clause 5.5.3.3.5, TS 24.008, clause 4.7.5.2.4, and TS 23.122, clause 4.4.3.1.2.

[TS 24.301, clause 5.5.3.3.5]

If the combined tracking area updating cannot be accepted by the network, the MME shall send a TRACKING AREA UPDATE REJECT message to the UE including an appropriate EMM cause value.

Upon receiving the TRACKING AREA UPDATE REJECT message, the UE shall stop timer T3430, stop any transmission of user data, enter state MM IDLE, and take the following actions depending on the EMM cause value received.

...

#11 (PLMN not allowed);

The UE shall set the EPS update status to EU3 ROAMING NOT ALLOWED (and shall store it according to subclause 5.1.3.3) and shall delete any GUTI, last visited registered TAI, TAI List and eKSI, and reset the tracking area updating attempt counter. The UE shall delete the list of equivalent PLMNs and enter the state EMM-DEREGISTERED.PLMN-SEARCH.

The UE shall store the PLMN identity in the "forbidden PLMN list".

The UE shall then perform a PLMN selection according to 3GPP TS 23.122 [6].

If A/Gb mode or Iu mode is supported by the UE, the UE shall handle and the MM parameters update status, TMSI, LAI, ciphering key sequence number and the location update attempt counter, and the GMM parameters GMM state, GPRS update status, P-TMSI, P-TMSI signature, RAI, GPRS ciphering key sequence number and routing area updating attempt counter as specified in 3GPP TS 24.008 [13] for the case when the combined routing area updating procedure is rejected with the GMM cause with the same value and no RR connection exists.

[TS 24.008, clause 4.7.5.2.4]

11 (PLMN not allowed);

The MS shall set the GPRS update status to GU3 ROAMING NOT ALLOWED and the update status to U3 ROAMING NOT ALLOWED (and shall store it according to subclause 4.1.3.2) and enter the state GMM-DEREGISTERED. Furthermore, it shall delete any P-TMSI, P-TMSI signature, TMSI, RAI, LAI, ciphering key

sequence number GPRS ciphering key sequence number, and reset the routing area updating attempt counter and the location update attempt counter.

[TS 23.122, clause 4.4.3.1.2]

The user may select his desired PLMN and the MS then initiates registration on this PLMN using the access technology chosen by the user for that PLMN or using the highest priority available access technology for that PLMN, if the associated access technologies have a priority order. (This may take place at any time during the presentation of PLMNs). For such a registration, the MS shall ignore the contents of the "forbidden LAs for roaming", "forbidden TAs for roaming", "forbidden LAs for regional provision of service", "forbidden TAs for regional provision of service", "forbidden PLMNs for GPRS service" and "forbidden PLMNs" lists.

9.2.3.2.11.3 Test description

9.2.3.2.11.3.1 Pre-test conditions

System Simulator:

- cell G (belongs to TAI-7, visited PLMN) is set to "Serving cell";
- cell H (belongs to TAI-8, visited PLMN) is set to "Non-suitable cell";
- cell I (belongs to TAI-9, visited PLMN, another PLMN) is set to "Non-suitable off cell";
- the cells are configured according to Table 6.3.2.2-1 and Table 6.3.2.2-3 in 36.508[18], except replacing f3 with f1;
- if `pc_UTRA AND px_RATComb_Tested = EUTRA_UTRA`, cell 9 (belongs to LAI-1 and RAI-1, visited PLMN) is configured;
- if `pc_GERAN AND px_RATComb_Tested = EUTRA_GERAN`, cell 24 (belongs to LAI-1 and RAI-1, visited PLMN) is configured;
- Set the cell type of cell 5 or cell 24 to the " Non-Suitable cell ".
- cell G, cell 9 and cell 24 are in same PLMN.
- System information combination 10 as defined in TS 36.508[18] clause 4.4.3.1 is used in E-UTRA cells.

NOTE: Setting `px_RATComb_Tested = EUTRA_Only` is not allowed.

UE:

- the UE is configured to initiate combined EPS/IMSI attach.
- the UE is previously registered on E-UTRAN, and when on E-UTRAN, the UE is last authenticated and registered on cell G using default message contents according to TS 36.508 [18];

Preamble:

- UE is in state Registered, Idle Mode (state 2) on Cell G according to [18].

9.2.3.2.11.3.2 Test procedure sequence

Table 9.2.3.2.11.3.2-1: Main behaviour

St	Procedure	Message Sequence		TP	Verdict
		U - S	Message		
1	Set the cell type of Cell G to the "Non-Suitable cell". Set the cell type of Cell H to the "Serving cell".	-	-	-	-
-	The following messages are to be observed on Cell H unless explicitly stated otherwise.	-	-	-	-
2	The UE transmits a TRACKING AREA UPDATE REQUEST message.	-->	TRACKING AREA UPDATE REQUEST	-	-
3	The SS transmits a TRACKING AREA UPDATE REJECT message with the EMM cause set to 'PLMN not allowed'.	<--	TRACKING AREA UPDATE REJECT	-	-
4	The SS releases the RRC connection.	-	-	-	-
5	Check: Does the UE transmit an ATTACH REQUEST message in the next 30 seconds?	-->	ATTACH REQUEST	1	F
6	If possible (see ICS) switch off is performed or the USIM is removed. Otherwise the power is removed.	-	-	-	-
7	Set the cell type of Cell G to the "Serving cell". Set the cell type of Cell H to the "Non-Suitable cell". NOTE: Cell G and Cell H are in the same PLMN.	-	-	-	-
-	The following messages are to be observed on Cell G unless explicitly stated otherwise.	-	-	-	-
8	The UE is brought back to operation or the USIM is inserted.	-	-	-	-
9	Check: Does the UE transmit an ATTACH REQUEST message in the next 90 seconds?	-->	ATTACH REQUEST	3	F
-	EXCEPTION: Steps 10a1 to 10a2 describe behaviour that depends on the UE capability; the "lower case letter" identifies a step sequence that takes place if a capability is supported	-	-	-	-
10a1	The cell type of Cell G and Cell I to the "non-Suitable cell", the cell type of Cell H to "non-Suitable "off" cell" and sets the cell type of Cell 9 (px_RATComb_Tested = EUTRA_UTRA) or Cell 24 (px_RATComb_Tested = EUTRA_GERAN) to the "Serving cell".	-	-	-	-
-	The following messages are to be observed on Cell 9 or Cell 24 unless explicitly stated otherwise.	-	-	-	-
10a2	Check: Does the UE transmit an ATTACH REQUEST message in the next 30 seconds?	-->	ATTACH REQUEST	1	F
11	Set the cell type of Cell I to the "Serving cell". Set the cell type of Cell 9 or Cell 24 to the "non-Suitable cell".	-	-	-	-
-	The following messages are to be observed on Cell I unless explicitly stated otherwise.	-	-	-	-
12	Check: Does the UE transmit an ATTACH REQUEST message including a PDN CONNECTIVITY REQUEST message?	-->	ATTACH REQUEST	1, 2, 4	P
13-21	Steps 5 to 13 of the generic test procedure in TS 36.508 subclause 4.5.2.3 are performed. NOTE: The UE performs an ATTACH procedure.	-	-	-	-
22	The SS responds with an ATTACH ACCEPT message. The ACTIVATE DEFAULT EPS BEARER CONTEXT REQUEST message is piggybacked in ATTACH ACCEPT message.	<--	ATTACH ACCEPT	-	-
-	EXCEPTION: In parallel to the event described in step 23 below the generic procedure for IP	-	-	-	-

	address allocation in the U-plane specified in TS 36.508 subclause 4.5A.1 takes place performing IP address allocation in the U-plane if requested by the UE.				
23	The UE transmits an ATTACH COMPLETE message including an ACTIVATE DEFAULT EPS BEARER CONTEXT ACCEPT message.	-->	ATTACH COMPLETE	-	-
24	The SS releases the RRC connection.	-	-	-	-
25	If possible (see ICS) switch off is performed or the USIM is removed. Otherwise the power is removed.	-	-	-	-
26	The UE transmits a DETACH REQUEST message.	-->	DETACH REQUEST	-	-
26A	The SS releases the RRC connection.	-	-	-	-
27	Set the cell type of Cell G to the "Serving cell". Set the cell type of Cell I to the "Non-Suitable cell".	-	-	-	-
-	The following messages are to be observed on Cell G unless explicitly stated otherwise.	-	-	-	-
28	The UE is brought back to operation or the USIM is inserted.	-	-	-	-
29	The UE is switched to manual PLMN selection mode and is made to select the forbidden PLMN cell.	-	-	-	-
30	Check: Does the UE transmit an ATTACH REQUEST message including a PDN CONNECTIVITY REQUEST message?	-->	ATTACH REQUEST	5	P
31-43	Steps 5 to 17 of the generic test procedure in TS 36.508 subclause 4.5.2.3 are performed. NOTE: The UE performs an ATTACH procedure and the RRC connection is released.	-	-	-	-
-	At the end of this test procedure sequence, the UE is in end state E-UTRA idle (E1) according to TS 36.508.	-	-	-	-

9.2.3.2.11.3.3 Specific message contents

Table 9.2.3.2.11.3.3-1: Message TRACKING AREA UPDATE REQUEST (step 2, Table 9.2.3.2.11.3.2-1)

Derivation Path: TS 36.508, Table 4.7.2-27			
Information Element	Value/remark	Comment	Condition
Old GUTI	GUTI-7		
Old location area identification	LAI-1		
TMSI status	Not present		

Table 9.2.3.2.11.3.3-2: Message TRACKING AREA UPDATE REJECT (step 3, Table 9.2.3.2.11.3.2-1)

Derivation Path: TS 36.508, Table 4.7.2-26			
Information Element	Value/remark	Comment	Condition
EMM cause	'0000 1011'B	PLMN not allowed	

Table 9.2.3.2.11.3.3-3: Message ATTACH REQUEST (step 12, Table 9.2.3.2.11.3.2-1)

Derivation Path: TS 36.508, Table 4.7.2-4			
Information Element	Value/remark	Comment	Condition
NAS key set identifier			
NAS key set identifier	'111'B	no key is available	
TSC	Any allowed value	TSC does not apply for NAS key set identifier value "111".	
Old GUTI or IMSI	IMSI-1		
Old P-TMSI signature	Not present		
Additional GUTI	Not present		
Last visited registered TAI	Not present		
Old location area identification	Not present		
TMSI status	'0'B	no valid TMSI available	

Table 9.2.3.2.11.3.3-4: Message ATTACH ACCEPT (step 22, Table 9.2.3.2.11.3.2-1)

Derivation Path: TS 36.508, Table 4.7.2-1			
Information Element	Value/remark	Comment	Condition
GUTI	GUTI-9		
Location area identification	LAI-9		
MS identity	TMSI-9		

Table 9.2.3.2.11.3.3-5: Message ATTACH REQUEST (step 30, Table 9.2.3.2.11.3.2-1)

Derivation Path: TS 36.508, Table 4.7.2-4			
Information Element	Value/remark	Comment	Condition
Old GUTI or IMSI	GUTI-9		
Old P-TMSI signature	Not present		
Additional GUTI	Not present		
Last visited registered TAI	TAI-9		
Old location area identification	LAI-9		
TMSI status	Not present		

9.2.3.2.12 Combined tracking area update / Rejected / Tracking area not allowed

9.2.3.2.12.1 Test Purpose (TP)

(1)

```
with { UE having sent a TRACKING AREA UPDATE REQUEST message with EPS update type set to 'Combined TA/LA updating' }
ensure that {
  when { UE receives a TRACKING AREA UPDATE REJECT message with the EMM cause set to 'Tracking Area not allowed' }
  then { UE sets the EPS update status to EU3 ROAMING NOT ALLOWED, deletes any GUTI, last visited registered TAI, TAI List and KSI, enters the state EMM-DEREGISTERED.LIMITED-SERVICE and stores the current TAI in the list of "forbidden tracking areas for regional provision of service" }
}
```

(2)

```
with { UE in EMM-DEREGISTERED.LIMITED-SERVICE state having the list of "forbidden tracking areas for regional provision of service" }
ensure that {
  when { serving cell belongs to TAI where UE was rejected }
  then { UE does not attempt to attach }
}
```

(3)

```
with { UE in EMM-DEREGISTERED.LIMITED-SERVICE state having the list of "forbidden tracking areas for regional provision of service" }
```

```

ensure that {
  when { UE reselects a new cell which belongs to the TAI in the list of "forbidden tracking areas
for regional provision of service" }
    then { UE does not attempt to attach }
}

```

(4)

```

with { UE is powered off or switched off }
ensure that {
  when { UE is powered on or switched on in the cell belonging to the TAI which was in the list of
"forbidden tracking areas for regional provision of service" before the UE was powered off or
switched off }
    then { UE attempts to attach }
}

```

(5)

```

with { UE is in EMM-DEREGISTERED.LIMITED-SERVICE state and the current TAI in the list of "forbidden
tracking areas for regional provision of service"}
ensure that {
  when { UE reselects a new cell which does not belong to any of the TAI in the list of "forbidden
tracking areas for regional provision of service"}
    then { UE initiates attach procedure with IMSI }
}

```

9.2.3.2.12.2 Conformance requirements

References: The conformance requirements covered in the present TC are specified in: TS 24.301, clause 5.5.3.3.5.

[TS 24.301, clause 5.5.3.3.5]

If the combined tracking area updating cannot be accepted by the network, the MME shall send a TRACKING AREA UPDATE REJECT message to the UE including an appropriate EMM cause value.

Upon receiving the TRACKING AREA UPDATE REJECT message, the UE shall stop timer T3430, stop any transmission of user data, enter state MM IDLE, and take the following actions depending on the EMM cause value received.

...

#12 (Tracking area not allowed);

The UE shall set the EPS update status to EU3 ROAMING NOT ALLOWED (and shall store it according to subclause 5.1.3.3) and shall delete any GUTI, last visited registered TAI, TAI List and KSI. The UE shall reset the tracking area updating attempt counter and shall enter the state EMM-DEREGISTERED.LIMITED-SERVICE.

The UE shall store the current TAI in the list of "forbidden tracking areas for regional provision of service".

If A/Gb mode or Iu mode is supported by the UE, the UE shall handle the MM parameters update status, TMSI, LAI, ciphering key sequence number and the location update attempt counter, and the GMM parameters GMM state, GPRS update status, P-TMSI, P-TMSI signature, RAI, GPRS ciphering key sequence number and routing area updating attempt counter as specified in 3GPP TS 24.008 [13] for the case when the combined routing area updating procedure is rejected with the GMM cause with the same value.

...

9.2.3.2.12.3 Test description

9.2.3.2.12.3.1 Pre-test conditions

System Simulator:

- cell A, cell B and cell M;
- cell A is set to the "Non-suitable", and cell B set to the "Serving cell" and cell M is set to the "non-Suitable cell".
- System information combination 3 as defined in TS 36.508[18] clause 4.4.3.1 is used in E-UTRA cells.

UE:

- the UE is configured to initiate combined EPS/IMSI attach.

Preamble:

- the UE is in state Registered, Idle mode (state 2) on cell B according to TS 36.508 [18].

9.2.3.2.12.3.2 Test procedure sequence

Table 9.2.3.2.12.3.2-1: Main behaviour

St	Procedure	Message Sequence		TP	Verdict
		U - S	Message		
1	Set the cell type of Cell B to the "Non-suitable". Set the cell type of Cell A to the "Serving cell".	-	-	-	-
-	The following messages are to be observed on Cell A unless explicitly stated otherwise.	-	-	-	-
2	The UE transmits a TRACKING AREA UPDATE REQUEST message.	-->	TRACKING AREA UPDATE REQUEST	-	-
3	The SS transmits a TRACKING AREA UPDATE REJECT message with the EMM cause set to 'Tracking Area not allowed'.	<--	TRACKING AREA UPDATE REJECT	-	-
4	The SS releases the RRC connection.	-	-	-	-
4A	The user initiates an attach by MMI or by AT command.	-	-	-	-
5	Check: Does the UE transmit an ATTACH REQUEST message in the next 90 seconds on Cell A?	-->	ATTACH REQUEST	1,2	F
6	Set the cell type of Cell A to the "non-Suitable cell". Set the cell type of Cell M to the "Serving cell".	-	-	-	-
-	The following messages are to be observed on Cell M unless explicitly stated otherwise.	-	-	-	-
7	Check: Does the UE transmit an ATTACH REQUEST message in the next 90 seconds?	-->	ATTACH REQUEST	3	F
8	Set the cell type of Cell B to the "Serving cell". Set the cell type of Cell M to the "non-Suitable cell".	-	-	-	-
-	The following messages are to be observed on Cell B unless explicitly stated otherwise.	-	-	-	-
8A	Check: Does the UE transmit an ATTACH REQUEST message on cell B including a PDN CONNECTIVITY REQUEST message?	-->	ATTACH REQUEST	1,5	P
8B-8N	The attach procedure is completed by executing steps 5 to 16 of the UE registration procedure in TS 36.508 sub clause 4.5.2.3.	-	-	-	-
9	Void	-	-	-	-
10	If possible (see ICS) switch off is performed or the USIM is removed. Otherwise the power is removed.	-	-	-	-
	EXCEPTION: Step 10Aa1 describes behaviour that depends on the UE capability.				
10Aa1	If pc_SwitchOnOff or pc_USIM_Removal then UE sends DETACH REQUEST message	-->	DETACH REQUEST	-	-
	Set the cell type of cell A to the "Serving cell". Set the cell type of cell B to the "Non-Suitable cell".				
11	The UE is brought back to operation or the USIM is inserted.	-	-	-	-
12	Check: Does the UE transmit an ATTACH REQUEST message including a PDN CONNECTIVITY REQUEST message?	-->	ATTACH REQUEST	4	P
13-24	The attach procedure is completed by executing steps 5 to 16 of the UE registration procedure in TS 36.508 sub clause 4.5.2.3.	-	-	-	-
-	At the end of this test procedure sequence, the UE is in end state E-UTRA connected (E2) according to TS 36.508.	-	-	-	-

9.2.3.2.12.3.3 Specific message contents

Table 9.2.3.2.12.3.3-1: TRACKING AREA UPDATE REJECT (step 3, Table 9.2.3.2.12.3.2-1)

Derivation Path: 36.508, Table 4.7.2-26			
Information Element	Value/remark	Comment	Condition
EMM cause	'0000 1100'B	Tracking Area not allowed	

Table 9.2.3.2.12.3.3-2: ATTACH REQUEST (step 8A, Table 9.2.3.2.12.3.2-1)

Derivation Path: 36.508, Table 4.7.2-4			
Information Element	Value/remark	Comment	Condition
NAS key set identifier			
NAS key set identifier	'111'B	no key is available	
TSC	Any allowed value	TSC does not apply for NAS key set identifier value "111".	
Old GUTI or IMSI	IMSI of the UE		
Last visited registered TAI	Not present		

Table 9.2.3.2.12.3.3-3: ATTACH REQUEST (step 12, Table 9.2.3.2.12.3.2-1)

Derivation Path: 36.508, Table 4.7.2-4			
Information Element	Value/remark	Comment	Condition
Old GUTI or IMSI	GUTI-2		
Last visited registered TAI	TAI-2		

Note: GUTI-2 and TAI-2 are GUTI and TAI allocated when the UE registered at Cell B in the preamble.

9.2.3.2.13 Combined tracking area update / Rejected / Roaming not allowed in this tracking area

9.2.3.2.13.1 Test Purpose (TP)

(1)

```
with { UE having sent a TRACKING AREA UPDATE REQUEST message with EPS update type set to 'Combined TA/LA updating' }
ensure that {
  when { the UE receives TRACKING AREA UPDATE REJECT message with the reject cause set to "roaming not allowed in this tracking area" }
  then { the UE sets the EPS update status to EU3 ROAMING NOT ALLOWED and the UE deletes the last visited registered TAI and the UE enters the state EMM-REGISTERED.PLMN-SEARCH and the UE stores the current TAI in the list of "forbidden tracking areas for roaming" }
}
```

(2)

```
with { the UE is in EMM-REGISTERED.PLMN-SEARCH state and the current TAI in the list of "forbidden tracking areas for roaming" }
ensure that {
  when { the serving cell belongs to TAI where UE was rejected }
  then { the UE does not attempt to send TRACKING AREA UPDATE REQUEST message }
}
```

(3)

```
with { the UE is in EMM-REGISTERED.PLMN-SEARCH state and the TAI of the current cell belongs to the list of "forbidden tracking areas for roaming" }
ensure that {
  when { the UE enters a cell belonging to same PLMN and TAI not in the list of "forbidden tracking areas for roaming" }
  then { the UE sends TRACKING AREA UPDATE REQUEST message with EPS update type set to "combined TA/LA updating with IMSI attach" }
}
```

(4)

```

with { the UE is in EMM-REGISTERED.PLMN-SEARCH state and the TAI of the current cell belongs to the
list of "forbidden tracking areas for roaming" }
ensure that {
  when { the UE enters a cell belonging to another PLMN }
  then { the UE sends TRACKING AREA UPDATE REQUEST message with EPS update type set to "combined
TA/LA updating with IMSI attach" }
}

```

(5)

```

with { the UE, which A/Gb mode or Iu mode is supported by the UE, in EMM-DEREGISTERED.PLMN-SEARCH
state and the list of "forbidden tracking areas for roaming" contains more than one TAI }
ensure that {
  when { the UE move to UTRAN or GERAN cell }
  then { the UE sends ROUTING AREA UPDATE REQUEST message }
}

```

9.2.3.2.13.2 Conformance requirements

References: The conformance requirements covered in the present TC are specified in: TS 24.301, clause 5.5.3.3.5

[TS 24.301, clause 5.5.3.3.5]

If the combined tracking area updating cannot be accepted by the network, the MME shall send a TRACKING AREA UPDATE REJECT message to the UE including an appropriate EMM cause value.

Upon receiving the TRACKING AREA UPDATE REJECT message, the UE shall stop timer T3430, stop any transmission of user data, enter state MM IDLE, and take the following actions depending on the EMM cause value received.

...

#13 (Roaming not allowed in this tracking area);

The UE shall set the EPS update status to EU3 ROAMING NOT ALLOWED (and shall store it according to subclause 5.1.3.3) and shall delete the list of equivalent PLMNs. The UE shall reset the tracking area updating attempt counter and shall change to state EMM-REGISTERED.PLMN-SEARCH.

The UE shall store the current TAI in the list of "forbidden tracking areas for roaming" and shall remove the current TAI from the stored TAI list if present.

The UE shall perform a PLMN selection according to 3GPP TS 23.122 [6].

The UE shall indicate the Update type IE "combined TA/LA updating with IMSI attach" when performing the tracking area updating procedure following the PLMN selection.

If A/Gb mode or Iu mode is supported by the UE, the UE shall handle the MM parameters update status and the location update attempt counter, and the GMM parameters GMM state, GPRS update status and routing area updating attempt counter as specified in 3GPP TS 24.008 [13] for the case when the combined routing area updating procedure is rejected with the GMM cause with the same value.

...

9.2.3.2.13.3 Test description

9.2.3.2.13.3.1 Pre-test conditions

System Simulator:

- cell E (belongs to TAI-12, visited PLMN) is set to "Serving cell";
- cell I (belongs to TAI-9, same visited PLMN) is set to "Non-suitable cell";
- cell B (belongs to TAI-2, another visited PLMN) is set to "Non-suitable off cell";
- the cells are configured according to Table 6.3.2.2-1 and Table 6.3.2.2-3 in 36.508[18], except that cell E and cell I are on different frequencies;

- if pc_UTRA AND px_RATComb_Tested = EUTRA_UTRA, cell 9 (belongs to RAI-8, visited PLMN) is set to "Non-suitable cell";
- if pc_GERAN AND px_RATComb_Tested = EUTRA_GERAN, cell 24 (belongs to RAI-8, visited PLMN) is set to "Non-suitable cell";
- system information indicate that NMO 1 is used.
- System information combination 10 a as defined in TS 36.508[18] clause 4.4.3.1 is used in E-UTRA cells.

NOTE: Setting px_RATComb_Tested = EUTRA_Only is not allowed.

UE:

- The UE is configured to initiate combined EPS/IMSI attach.

Preamble:

- the UE is in state Registered, Idle Mode (state 2) on cell E according to TS 36.508 [18].

9.2.3.2.13.3.2 Test procedure sequence

Table 9.2.3.2.13.3.2-1: Main behaviour

St	Procedure	Message Sequence		TP	Verdict
		U - S	Message		
1	Set the cell type of Cell E to the "Suitable cell". Set the cell type of Cell I to the "Serving cell".	-	-	-	-
2	The UE transmits TRACKING AREA UPDATE REQUEST on Cell I.	-->	TRACKING AREA UPDATE REQUEST	-	-
3	The SS transmits a TRACKING AREA UPDATE REJECT message with EMM cause = "Roaming not allowed in this tracking area" as specified.	<--	TRACKING AREA UPDATE REJECT	-	-
4	The SS releases the RRC connection.				
5	Void	-	-	-	-
6	Void	-	-	-	-
7	Check: Does the UE transmit TRACKING AREA UPDATE REQUEST message on cell E?	-->	TRACKING AREA UPDATE REQUEST	1, 3	P
8	The SS transmits TRACKING AREA UPDATE REJECT message with EMM cause = "Roaming not allowed in this tracking area" as specified.	<--	TRACKING AREA UPDATE REJECT	-	-
9	The SS releases the RRC connection.				
10	Set the cell type of Cell E and Cell B to the "Non-Suitable cell", set the cell type of cell I to the "Non-Suitable "off" cell". Set the cell type of cell 9 or 24 to the "Serving cell". Note: Cell E and Cell 9 or 24 are in the same PLMN.	-	-	-	-
	EXCEPTION: Steps 11a1 to 11a3 describe behaviour that depends on the UE capability; the "lower case letter" identifies a step sequence that take place if a capability is supported				
11a 1	Check: Does the UE transmit ROUTING AREA UPDATE REQUEST message on cell 9 or 24?	-->	ROUTING AREA UPDATE REQUEST	5	P
11a 2	The SS transmits a ROUTING AREA UPDATE REJECT message with cause = " Roaming not allowed in this routing area " as specified.	<--	ROUTING AREA UPDATE REJECT	-	-
11a 3	The SS releases the RRC connection.				
12	Set the cell type of cell 9 or 24 to the " Non-Suitable cell". Set the cell type of cell B to the "Serving cell". Note: cell 9 or 24 and cell B are in different PLMNs.	-	-	-	-
13	Check: Does the UE transmit TRACKING AREA REQUEST message on cell B?	-->	TRACKING AREA UPDATE REQUEST	1, 4	P
14	The SS sends TRACKING AREA ACCEPT message.	<--	TRACKING AREA UPDATE ACCEPT	-	-
15	The UE transmits TRACKING AREA COMPLETE message.	-->	TRACKING AREA UPDATE COMPLETE	-	-
-	At the end of this test procedure sequence, the UE is in end state E-UTRA connected (E2_T3440) according to TS 36.508.	-	-	-	-

9.2.3.2.13.3.3 Specific message contents

Table 9.2.3.2.13.3.3-1: Message TRACKING AREA UPDATE REQUEST (step 2, Table 9.2.3.2.13.3.2-1)

Derivation path: 36.508 table 4.7.2-27			
Information Element	Value/Remark	Comment	Condition
Old GUTI	GUTI-7		

Table 9.2.3.2.13.3.3-2: TRACKING AREA UPDATE REJECT (step 3 and 8, Table 9.2.3.2.13.3.2-1)

Derivation Path: 36.508, Table 4.7.2-26			
Information Element	Value/remark	Comment	Condition
EMM cause	'0000 1101'B	Roaming not allowed in this tracking area	

Table 9.2.3.2.13.3.3-3: Message TRACKING AREA UPDATE REQUEST (step 7 and 13, Table 9.2.3.2.13.3.2-1)

Derivation Path: 36.508, Table 4.7.2-27			
Information Element	Value/remark	Comment	Condition
EPS update type			
EPS update type value	'010'B	Combined TA/LA updating with IMSI attach	

Table 9.2.3.2.13.3.3-4: Message ROUTING AREA UPDATE REQUEST (step 11a1, Table 9.2.3.2.13.3.2-1)

Derivation Path: 36.508, Table 4.7B.2-1			
Information Element	Value/remark	Comment	Condition
Update type	'010'B	Combined RA/LA updating with IMSI attach	

9.2.3.2.14 Combined tracking area update / Rejected / EPS services not allowed in the PLMN

9.2.3.2.14.1 Test Purpose (TP)

(1)

```

with { UE having sent a TRACKING AREA UPDATE REQUEST message with EPS update type set to 'Combined TA/LA updating' }
ensure that {
  when { UE receives a TRACKING AREA UPDATE REJECT message with the EMM cause set to 'EPS services not allowed in this PLMN' }
  then { UE deletes any GUTI, last visited registered TAI, TAI List and eKSI, and UE stores the PLMN identity in the "forbidden PLMNs for GPRS service" list }
}

```

(2)

```

with { UE is in EMM-DEREGISTERED.PLMN-SEARCH state }
ensure that {
  when { UE detects a E-UTRAN cell which belongs to the same PLMN which is stored in the "forbidden PLMNs for GPRS service" list }
  then { UE does not attempt to access on this cell }
}

```

(3)

```

with { UE is IMSI attached for non-EPS services and is in EMM-DEREGISTERED.PLMN-SEARCH state and one PLMN stored in the "forbidden PLMNs for GPRS service" list }

```

```

ensure that {
  when { UE update status is U2 NOT UPDATED and detects a new GERAN or UTRAN cell which belongs to
the PLMN }
  then { UE initiates location update procedure in this GERAN or UTRAN cell }
}

```

(4)

```

with { UE is in EMM-DEREGISTERED.PLMN-SEARCH state }
ensure that {
  when { UE detects a E-UTRAN cell which belongs to another PLMN which is not stored in the
"forbidden PLMNs for GPRS service" list }
  then { UE attempts to access on this cell }
}

```

9.2.3.2.14.2 Conformance requirements

References: The conformance requirements covered in the present TC are specified in: TS 24.301, clause 5.5.3.3.5.

[TS 24.301, clause 5.5.3.3.5]

If the combined tracking area updating cannot be accepted by the network, the MME shall send a TRACKING AREA UPDATE REJECT message to the UE including an appropriate EMM cause value.

Upon receiving the TRACKING AREA UPDATE REJECT message, the UE shall stop timer T3430, stop any transmission of user data, enter state MM IDLE, and take the following actions depending on the EMM cause value received.

...

#14 (EPS services not allowed in this PLMN);

The UE shall set the EPS update status to EU3 ROAMING NOT ALLOWED (and shall store it according to subclause 5.1.3.3). Furthermore the UE shall delete any GUTI, last visited registered TAI, TAI List and eKSI. The UE shall reset the tracking area updating attempt counter and shall enter the state EMM-DEREGISTERED.PLMN-SEARCH.

The UE shall store the PLMN identity in the "forbidden PLMNs for GPRS service" list.

The UE operating in CS/PS mode 1 or CS/PS mode 2 of operation is still IMSI attached for non-EPS services and shall set the update status to U2 NOT UPDATED.

A UE operating in CS/PS mode 1 of operation may select GERAN or UTRAN radio access technology and proceed with the appropriate MM specific procedure according to the MM service state. In this case the UE shall not reselect E-UTRAN radio access technology for the duration the UE is on the PLMN or equivalent PLMN.

A UE in CS/PS mode 1 of operation may perform a PLMN selection according to 3GPP TS 23.122 [6].

A UE operating in CS/PS mode 2 of operation shall perform a PLMN selection according to 3GPP TS 23.122 [6].

If A/Gb mode or Iu mode is supported by the UE, the UE shall handle the GMM parameters GMM state, GPRS update status, P-TMSI, P-TMSI signature, RAI, GPRS ciphering key sequence number and routing area updating attempt counter as specified in 3GPP TS 24.008 [13] for the case when the combined routing area updating procedure is rejected with the GMM cause with the same value.

9.2.3.2.14.3 Test description

9.2.3.2.14.3.1 Pre-test conditions

System Simulator:

- cell G (visited PLMN) is set to "Serving cell";
- cell H (visited PLMN,) is set to "Non-suitable cell";
- cell I (another visited PLMN) is set to "Non-suitable off cell";

- the cells are configured according to Table 6.3.2.2-1 and Table 6.3.2.2-3 in 36.508[18], except replacing f3 with f1 for cell J, and replacing f3 with f1 for cell I in Table 6.3.2.2-3 in 36.508[18];
- if pc_UTRA AND px_RATComb_Tested = EUTRA_UTRA, cell 9 (visited PLMN) is set to "Non-Suitable cell";
- if pc_GERAN AND px_RATComb_Tested = EUTRA_GERAN, cell 24 (visited PLMN) is set to "Non-Suitable cell";
- System information combination 10 as defined in TS 36.508[18] clause 4.4.3.1 is used in E-UTRA cells.

NOTE: Setting px_RATComb_Tested = EUTRA_Only is not allowed.

UE:

- the UE is configured to initiate combined attach

Preamble:

- the UE is in state Registered, Idle Mode (state 2) on cell G according to TS 36.508 [18].

9.2.3.2.14.3.2 Test procedure sequence

Table 9.2.3.2.14.3.2-1: Main behaviour

St	Procedure	Message Sequence		TP	Verdict
		U - S	Message		
1	The SS configures: Cell G as the "non-Suitable cell". Cell H as the "Serving cell".	-	-	-	-
2	The UE transmits a TRACKING AREA UPDATE REQUEST on Cell H.	-->	TRACKING AREA UPDATE REQUEST	-	-
3	The SS transmits a TRACKING AREA UPDATE REJECT message with the EMM cause set to as "EPS services not allowed in this PLMN" as specified.	<--	TRACKING AREA UPDATE REJECT	-	-
4	The SS releases the RRC connection.	-	-	-	-
5	The SS configures: Cell H as the "non-Suitable cell". Cell G as the "Serving cell".	-	-	-	-
6	Check: Does the UE transmit an ATTACH REQUEST message in the next 30 seconds on cell G?	-->	ATTACH REQUEST	1, 2	F
7	The SS configures: Cell G and Cell I as a "non-Suitable cell". Cell H as "non-Suitable "off" cell" Cell 9 or 24 as the "Serving cell".	-	-	-	-
	EXCEPTION: Steps 8a1 to 8a4 describe behaviour that depends on the UE capability; the "lower case letter" identifies a step sequence that takes place if a capability is supported.	-	-	-	-
8a1	The following messages are sent and shall be received on Cell 9 or 24. Check: Does the UE transmit a LOCATION UPDATING REQUEST message on Cell 9 or cell 24?	-->	LOCATION UPDATING REQUEST	3	P
-	EXCEPTION: The messages in the next two steps are sent only on Cell 24	-	-	-	-
8a1A a1	The UE transmits a <i>Classmark Change</i> message	-->	CLASSMARK CHANGE		
-	EXCEPTION: The next step describes behaviour that depends on UE capability.	-	-	-	-
8a1A a2	IF pc_UTRA THEN the UE transmits a <i>Utran Classmark Change</i> message.	-->	UTRAN CLASSMARK CHANGE.		
8a2	The SS transmits an AUTHENTICATION REQUEST message to initiate the authentication and AKA procedure.	<--	AUTHENTICATION REQUEST	-	-
8a3	The UE transmits an AUTHENTICATION RESPONSE message.	-->	AUTHENTICATION RESPONSE	-	-
8a4	The SS transmits a LOCATION UPDATING ACCEPT message.	<--	LOCATION UPDATING ACCEPT	-	-
9	The SS configures: Cell I as the "Serving cell". Cell 9 or 24 as the "non-Suitable cell".	-	-	-	-
10	Check: Does the UE transmit ATTACH REQUEST message with a PDN CONNECTIVITY REQUEST message to request PDN connectivity to the default PDN on cell I?	-->	ATTACH REQUEST	1, 4	P
11- 22	The attach procedure is completed by executing steps 5 to 16 of the UE registration procedure in TS 36.508 sub clause 4.5.2.3.	-	-	-	-
-	At the end of this test procedure sequence, the UE is in end state E-UTRA connected (E2) according to TS 36.508.	-	-	-	-

9.2.3.2.14.3.3 Specific message contents

Table 9.2.3.2.14.3.3-1: Message TRACKING AREA UPDATE REQUEST (step 2, Table 9.2.3.2.14.3.2-1)

Derivation path: 36.508 table 4.7.2-27			
Information Element	Value/Remark	Comment	Condition
EPS update type			
EPS update type Value	'001'B	"combined TA/LA updating "	
Old GUTI	GUTI-7		

Table 9.2.3.2.14.3.3-2: Message TRACKING AREA UPDATE REJECT (step 3, Table 9.2.3.2.14.3.2-1)

Derivation path: 36.508 table 4.7.2-24			
Information Element	Value/Remark	Comment	Condition
EMM cause	'00001110'B	" EPS services not allowed in this PLMN "	

Table 9.2.3.2.14.3.3-3: Message ATTACH REQUEST (step 10, Table 9.2.3.2.14.3.2-1)

Derivation path: 36.508 table 4.7.2-4			
Information Element	Value/Remark	Comment	Condition
Old GUTI or IMSI	IMSI		
Last visited registered TAI	Not present		

Table 9.2.3.2.14.3.3-4: LOCATION UPDATING REQUEST (step 8a1, Table 9.2.3.2.14.3.2-1)

Derivation Path: TS 36.508 Table 4.7B.2-4			
Information Element	Value/remark	Comment	Condition
Location updating type	Normal update		

Table 9.2.3.2.14.3.3-5: LOCATION UPDATING ACCEPT (step 8a4, Table 9.2.3.2.14.3.2-1)

Derivation Path: TS 36.508 Table 4.7B.2-5			
Information Element	Value/remark	Comment	Condition
Mobile identity	Not present		

9.2.3.2.15 Combined tracking area update / Rejected / No suitable cells in tracking area

9.2.3.2.15.1 Test Purpose (TP)

(1)

```

with { UE having sent a TRACKING AREA UPDATE REQUEST message with EPS update type set to 'Combined
TA/LA updating' }
ensure that {
  when { UE receives a TRACKING AREA UPDATE REJECT message with the EMM cause set to 'No Suitable
Cells In tracking area' }
  then { UE selects a suitable cell in another tracking area in the same PLMN and performs the
tracking area updating procedure with EPS update type set to 'combined TA/LA updating with IMSI
attach' }
}

```

9.2.3.2.15.2 Conformance requirements

References: The conformance requirements covered in the present TC are specified in: TS 24.301, clause 5.5.3.3.5.

[TS 24.301, clause 5.5.3.3.5]

If the combined tracking area updating cannot be accepted by the network, the MME shall send a TRACKING AREA UPDATE REJECT message to the UE including an appropriate EMM cause value.

Upon receiving the TRACKING AREA UPDATE REJECT message, the UE shall stop timer T3430, stop any transmission of user data, enter state MM IDLE, and take the following actions depending on the EMM cause value received.

...

#15 (No suitable cells in tracking area);

The UE shall set the EPS update status to EU3 ROAMING NOT ALLOWED (and shall store it according to subclause 5.1.3.3). The UE shall reset the tracking area updating attempt counter and shall enter the state EMM-REGISTERED.LIMITED-SERVICE.

The UE shall store the current TAI in the list of "forbidden tracking areas for roaming" and shall remove the current TAI from the stored TAI list if present.

The UE shall search for a suitable cell in another tracking area or in another location area in the same PLMN according to 3GPP TS 36.304 [21].

The UE shall indicate the Update type IE "combined TA/LA updating with IMSI attach" when performing the tracking area updating procedure.

If A/Gb mode or Iu mode is supported by the UE, the UE shall handle the MM parameters update status and the location update attempt counter, and the GMM parameters GMM state, GPRS update status and routing area updating attempt counter as specified in 3GPP TS 24.008 [13] for the case when the combined routing area updating procedure is rejected with the GMM cause with the same value.

9.2.3.2.15.3 Test description

9.2.3.2.15.3.1 Pre-test conditions

System Simulator:

- cell A, cell B and cell C;
- cell A is set to the "Serving cell" and cell B and cell C is set to the "Non-suitable cell".
- System information combination 3 as defined in TS 36.508[18] clause 4.4.3.1 is used in E-UTRA cells.

UE:

- the UE is configured to initiate combined EPS/IMSI attach.

Preamble:

- the UE is in state Registered, Idle mode (state 2) on cell A according to TS 36.508 [18].

9.2.3.2.15.3.2 Test procedure sequence

Table 9.2.3.2.15.3.2-1: Main behaviour

St	Procedure	Message Sequence		TP	Verdict
		U - S	Message		
1	Set the cell type of Cell A to the "non-Suitable cell". Set the cell type of Cell B to the "Serving cell". Set the cell type of Cell C to the "Suitable neighbour cell".	-	-	-	-
-	The following messages are to be observed on Cell B unless explicitly stated otherwise.	-	-	-	-
2	The UE transmits a TRACKING AREA UPDATE REQUEST message.	-->	TRACKING AREA UPDATE REQUEST	-	-
3	The SS transmits a TRACKING AREA UPDATE REJECT message with the EMM cause set to 'No Suitable Cells In tracking area'.	<--	TRACKING AREA UPDATE REJECT	-	-
4	The SS releases the RRC connection.	-	-	-	-
-	The following messages are to be observed on Cell C unless explicitly stated otherwise.	-	-	-	-
5	Check: Does the UE transmit a TRACKING AREA UPDATE REQUEST message with EPS update type set to 'combined TA/LA updating with IMSI attach'?	-->	TRACKING AREA UPDATE REQUEST	1	P
6	The SS transmits a TRACKING AREA UPDATE ACCEPT message.	<--	TRACKING AREA UPDATE ACCEPT	-	-
7	The UE transmits a TRACKING AREA UPDATE COMPLETE message.	-->	TRACKING AREA UPDATE COMPLETE	-	-
-	At the end of this test procedure sequence, the UE is in end state E-UTRA connected (E2_T3440) according to TS 36.508.	-	-	-	-

9.2.3.2.15.3.3 Specific message contents

Table 9.2.3.2.15.3.3-1: TRACKING AREA UPDATE REJECT (step 3, Table 9.2.3.2.15.3.2-1)

Derivation Path: 36.508, Table 4.7.2-26			
Information Element	Value/remark	Comment	Condition
EMM cause	'0000 1111'B	No Suitable Cells In tracking area	

Table 9.2.3.2.15.3.3-2: TRACKING AREA UPDATE REQUEST (step 5, Table 9.2.3.2.15.3.2-1)

Derivation Path: 36.508, Table 4.7.2-27			
Information Element	Value/remark	Comment	Condition
EPS update type			
EPS update type value	'010'B	Combined TA/LA updating with IMSI attach	

9.2.3.2.16 Combined tracking area update / Rejected / Not authorized for this CSG

9.2.3.2.16.1 Test Purpose (TP)

(1)

```

with { UE has sent a TRACKING AREA UPDATE REQUEST message with EPS update type set to 'Combined
TA/LA updating' }
ensure that {
  when { UE receives a TRACKING AREA UPDATE REJECT message with the reject cause set to "Not
authorized for this CSG" and with integrity protection }
    then { UE removes the CSG ID from the Allowed CSG list }
}

```

(2)

```

with { UE has sent a TRACKING AREA UPDATE REQUEST message with EPS update type set to 'Combined
TA/LA updating' }
ensure that {
  when { UE receives a TRACKING AREA UPDATE REJECT message with the reject cause set to "Not
authorized for this CSG" and with integrity protection }
  then { UE searches for a suitable cell in the same PLMN and sent a TRACKING AREA UPDATE REQUEST
message with EPS update type set to ' combined TA/LA updating with IMSI attach ' }
}

```

9.2.3.2.16.2 Conformance requirements

References: The conformance requirements covered in the current TC are specified in: TS 24.301, clause 5.5.3.3.5.

[TS 24.301, clause 5.5.3.3.5]

#25 (Not authorized for this CSG);

Cause #25 is only applicable when received from a CSG cell. Cause #25 received from a non-CSG cell is considered as an abnormal case and the behaviour of the UE is specified in subclause 5.5.3.3.6.

If the TRACKING AREA UPDATE REJECT message with cause #25 was received without integrity protection, then the UE shall discard the message.

The UE shall set the EPS update status to EU3 ROAMING NOT ALLOWED (and shall store it according to subclause 5.1.3.3). The UE shall reset the tracking area updating attempt counter and shall enter the state EMM-REGISTERED.LIMITED-SERVICE.

If the CSG ID of the cell where the UE has sent the TRACKING AREA UPDATE REQUEST message is contained in the Allowed CSG list, the UE shall remove the CSG ID from the Allowed CSG list.

If the CSG ID of the cell where the UE has sent the TRACKING AREA UPDATE REQUEST message is contained in the Operator CSG list, the UE shall apply the procedures defined in 3GPP TS 23.122 [6] subclause 3.1A.

The UE shall search for a suitable cell in the same PLMN according to 3GPP TS 36.304 [21].

The UE shall indicate the Update type IE "combined TA/LA updating with IMSI attach" when performing the tracking area updating procedure.

If A/Gb mode or Iu mode is supported by the UE, the UE shall handle the MM parameters update status and the location update attempt counter, and the GMM parameters GMM state, GPRS update status and routing area updating attempt counter as specified in 3GPP TS 24.008 [13] for the case when the combined routing area updating procedure is rejected with the GMM cause with the same value.

9.2.3.2.16.3 Test description

9.2.3.2.16.3.1 Pre-test conditions

System Simulator:

- cell A (TAI-1, frequency 1, HPLMN, not a CSG cell) is set to "Serving cell";
- cell B (TAI-2, frequency 1, HPLMN, is a CSG cell) is set to "Non-suitable cell";
- cell C (TAI-3, frequency 1, HPLMN, not a CSG cell) is set to "Non-suitable off cell".
- System information combination 3 as defined in TS 36.508[18] clause 4.4.3.1 is used in E-UTRA cells.

UE:

- the UE is previously registered on cell B using manual CSG selection (so the allowed CSG list includes CSG ID of cell B).

Preamble:

- the UE is in state Registered, Idle mode (state 2) with condition CombinedAttach on cell A according to TS 36.508 [18]

9.2.3.2.16.3.2 Test procedure sequence

Table 9.2.3.2.16.3.2-1: Main behaviour

St	Procedure	Message Sequence		TP	Verdict
		U - S	Message		
1	The SS configures: - Cell A as a "Not Suitable cell". - Cell B as a "Serving cell".	-	-	-	-
2	The UE transmits a TRACKING AREA UPDATE REQUEST message.	-->	TRACKING AREA UPDATE REQUEST	-	-
3	The SS transmits a TRACKING AREA UPDATE REJECT message with EMM cause = "Not authorized for this CSG" with integrity protection.	<--	TRACKING AREA UPDATE REJECT	-	-
4	The SS releases the RRC connection.	-	-	-	-
5	Check: Does the UE transmit an TRACKING AREA UPDATE REQUEST message on Cell B in the next 30 seconds?	-->	TRACKING AREA UPDATE REQUEST	1	F
6	The SS configures: - Cell A as a "Not Suitable off cell". - Cell B as a "Not Suitable cell". - Cell C as a "Suitable cell".	-	-	-	-
7	Check: Does the UE transmit an TRACKING AREA UPDATE REQUEST message on Cell C?	-->	TRACKING AREA UPDATE REQUEST	2	P
8	The SS transmits a TRACKING AREA UPDATE ACCEPT message.	<--	TRACKING AREA UPDATE ACCEPT	-	-
9	The UE transmits a TRACKING AREA UPDATE COMPLETE message.	-->	TRACKING AREA UPDATE COMPLETE	-	-
9A	The SS releases the RRC connection.	-	-	-	-
10	The SS configures: - Cell A as a "Not Suitable off cell". - Cell B as a "Serving cell". - Cell C as a "Not Suitable cell".	-	-	-	-
11	Check: Does the UE transmit an TRACKING AREA UPDATE REQUEST message in the next 30 seconds on Cell B?	-->	TRACKING AREA UPDATE REQUEST	1	F

9.2.3.2.16.3.3 Specific message contents

Table 9.2.3.2.16.3.3-1: Message TRACKING AREA UPDATE REQUEST (step 2, Table 9.2.3.2.16.3.2-1)

Derivation path: 36.508 table 4.7.2-27			
Information Element	Value/Remark	Comment	Condition
EPS update type	'001'B	"combined TA/LA updating"	

Table 9.2.3.2.16.3.3-2: Message TRACKING AREA UPDATE REJECT (step 3, Table 9.2.3.2.16.3.2-1)

Derivation Path: 36.508, Table 4.7.2-26			
Information Element	Value/remark	Comment	Condition
EMM cause	'00011001'B	#25 " Not authorized for this CSG"	

Table 9.2.3.2.16.3.3-3: Message TRACKING AREA UPDATE REQUEST (step 7, Table 9.2.3.2.16.3.2-1)

Derivation path: 36.508 table 4.7.2-27			
Information Element	Value/Remark	Comment	Condition
EPS update type	'010'B	" combined TA/LA updating with IMSI attach "	

Table 9.2.3.2.16.3.3-4: SystemInformationBlockType1 for Cell A, B, C (Pre-test conditions and all steps in Table 9.2.3.2.16.3.2-1)

Derivation Path: 36.508 clause 4.4.3.2			
Information Element	Value/remark	Comment	Condition
SystemInformationBlockType1 ::= SEQUENCE {			
cellAccessRelatedInfo SEQUENCE {			
csg-Indication	TRUE		Cell B
	FALSE		Cell A
	FALSE		Cell C
csg-Identity	Not present		Cell A
	'000 0000 0000 0000 0000 0000 0010'B		Cell B
	Not present		Cell C
}			
}			

9.2.3.2.17 Combined tracking area update / Abnormal case / handling of the EPS tracking area updating attempt counter

9.2.3.2.17.1 Test Purpose (TP)

(1)

```
with { UE has initiated combined tracking area updating procedure and has the tracking area updating attempt counter less than 5 }
ensure that {
  when { UE detects release of the NAS signalling connection and in a EPS update status different to EU1 UPDATED and update status is U1 UPDATED }
  then { UE starts timer T3411, does not delete any LAI, TMSI, ciphering key sequence number and list of equivalent PLMNs and set the update status to U2 NOT UPDATED }
}
```

(2)

```
with { UE has initiated combined tracking area updating procedure and has the tracking area updating attempt counter equal to 5 }
ensure that {
  when { UE detects release of the NAS signalling connection }
  then { UE starts timer T3402, deletes any LAI, TMSI, ciphering key sequence number and list of equivalent PLMNs and set the update status to U2 NOT UPDATED }
}
```

9.2.3.2.17.2 Conformance requirements

References: The conformance requirements covered in the current TC are specified in: TS 24.301, clause 5.5.3.1, clause 5.5.3.2.6 and clause 5.5.3.3.6.

[TS 24.301, clause 5.5.3.1]

...

A tracking area updating attempt counter is used to limit the number of subsequently rejected tracking area update attempts. The tracking area updating attempt counter shall be incremented as specified in subclause 5.5.3.2.6. Depending on the value of the tracking area updating attempt counter, specific actions shall be performed. The tracking area updating attempt counter shall be reset when:

- an attach or combined attach procedure is successfully completed;
- a normal or periodic tracking area updating or a combined tracking area updating procedure is successfully completed; or
- a normal or periodic tracking area updating or a combined tracking area updating procedure is rejected with EMM cause #11, #12, #13, #14, #15 or #25.

Additionally the tracking area updating attempt counter shall be reset when the UE is in substate EMM-REGISTERED.ATTEMPTING-TO-UPDATE or EMM-REGISTERED.ATTEMPTING-TO-UPDATE-MM, and:

- a new tracking area is entered; or
- timer T3402 expires.

[TS 24.301, clause 5.5.3.2.6]

The following abnormal cases can be identified:

...

c) T3430 timeout

The UE shall abort the procedure and proceed as described below. The NAS signalling connection shall be released locally.

...

For the cases b, c and d the UE shall proceed as follows:

Timer T3430 shall be stopped if still running. The tracking area updating attempt counter shall be incremented, unless it was already set to 5.

If the tracking area updating attempt counter is less than 5, and the TAI of the current serving cell is included in the TAI list and the EPS update status is equal to EU1 UPDATED:

- the UE shall keep the EPS update status to EU1 UPDATED and enter state EMM-REGISTERED.NORMAL-SERVICE. The UE shall start timer T3411. When timer T3411 expires the tracking area updating procedure is triggered again.

If the tracking area updating attempt counter is less than 5, and the TAI of the current serving cell is not included in the TAI list or the EPS update status is different to EU1 UPDATED:

- the UE shall start timer T3411, shall set the EPS update status to EU2 NOT UPDATED and change to state EMM-REGISTERED.ATTEMPTING-TO-UPDATE. When timer T3411 expires the tracking area updating procedure is triggered again.

If A/Gb mode or Iu mode is supported by the UE, the UE shall in addition handle the GPRS update status as specified in 3GPP TS 24.008 [13] for the abnormal case when a normal or periodic routing area updating procedure fails and the routing area updating attempt counter is less than 5 and the GPRS update status is different from GU1 UPDATED.

If the tracking area updating attempt counter is equal to 5:

- the UE shall start timer T3402, shall set the EPS update status to EU2 NOT UPDATED, shall delete the list of equivalent PLMNs and shall change to state EMM-REGISTERED.ATTEMPTING-TO-UPDATE or optionally to EMM-REGISTERED.PLMN-SEARCH in order to perform a PLMN selection according to 3GPP TS 23.122 [6].

If A/Gb mode or Iu mode is supported by the UE, the UE shall in addition handle the GPRS update status as specified in 3GPP TS 24.008 [13] for the abnormal case when a normal or periodic routing area updating procedure fails and the routing area updating attempt counter is equal to 5.

[TS 24.301, clause 5.5.3.3.6]

...

If the tracking area updating attempt counter is incremented according to subclause 5.5.3.2.6 the next actions depend on the value of the tracking area updating attempt counter.

- if the update status is U1 UPDATED and the tracking area updating attempt counter is less than 5, then the UE shall keep the update status to U1 UPDATED, the new MM state is MM IDLE substate NORMAL SERVICE;
- if the tracking area updating attempt counter is less than 5 and, additionally, the update status is different from U1 UPDATED UE shall delete any LAI, TMSI, ciphering key sequence number and list of equivalent PLMNs and set the update status to U2 NOT UPDATED. The MM state remains MM LOCATION UPDATING PENDING; or
- if the tracking area updating attempt counter is equal to 5, the UE shall delete any LAI, TMSI, ciphering key sequence number and list of equivalent PLMNs and set the update status to U2 NOT UPDATED. A UE operating in CS/PS mode 1 of operation shall select GERAN or UTRAN radio access technology and proceed with appropriate MM or GMM specific procedures.

9.2.3.2.17.3 Test description

9.2.3.2.17.3.1 Pre-test conditions

System Simulator:

- cell A and cell B.
- System information combination 3 as defined in TS 36.508[18] clause 4.4.3.1 is used in E-UTRA cells.

UE:

- the UE is configured to initiate combined attach in DATA Centric mode

Preamble:

- the UE is in state Registered, Idle Mode (state 2) on cell A according to TS 36.508 [18].

9.2.3.2.17.3.2 Test procedure sequence

Table 9.2.3.2.17.3.2-1: Main behaviour

St	Procedure	Message Sequence		TP	Verdict
		U - S	Message		
1	Set the cell type of Cell A to the "non-Suitable cell". Set the cell type of Cell B to the "Serving cell".	-	-	-	-
-	The following messages are sent and shall be received on Cell B.	-	-	-	-
2	Check: Does the UE transmit a TRACKING AREA UPDATE REQUEST message?	-->	TRACKING AREA UPDATE REQUEST	1	P
3	Wait for 25s to ensure that T3430 and T3411 expire. NOTE 1: The tracking area updating attempt counter is 1.	-	-	-	-
4	Check: Does the UE transmit a TRACKING AREA UPDATE REQUEST message?	-->	TRACKING AREA UPDATE REQUEST	1	P
5	Wait for 25s to ensure that T3430 and T3411 expire. NOTE 2: The tracking area updating attempt counter is 2.	-	-	-	-
6	Check: Does the UE transmit a TRACKING AREA UPDATE REQUEST message?	-->	TRACKING AREA UPDATE REQUEST	1	P
7	Wait for 25s to ensure that T3430 and T3411 expire. NOTE 3: The tracking area updating attempt counter is 3.	-	-	-	-
8	Check: Does the UE transmit a TRACKING AREA UPDATE REQUEST message?	-->	TRACKING AREA UPDATE REQUEST	1	P
9	Wait for 25s to ensure that T3430 and T3411 expire. NOTE 4: The tracking area updating attempt counter is 4.	-	-	-	-
10	Check: Does the UE transmit a TRACKING AREA UPDATE REQUEST message?	-->	TRACKING AREA UPDATE REQUEST	1	P
11	The SS releases the RRC connection. NOTE 5: The tracking area updating attempt counter is 5 and reset.	-	-	-	-
12	Wait for 12 min to ensure that T3402 expires.	-	-	-	-
13	Check: Does the UE transmit a TRACKING AREA UPDATE REQUEST message?	-->	TRACKING AREA UPDATE REQUEST	2	P
14	The SS transmits a TRACKING AREA UPDATE ACCEPT message.	<--	TRACKING AREA UPDATE ACCEPT	-	-
15	The UE transmits a TRACKING AREA UPDATE COMPLETE message.	-->	TRACKING AREA UPDATE COMPLETE	-	-
-	At the end of this test procedure sequence, the UE is in end state E-UTRA connected (E2_T3440) according to TS 36.508.	-	-	-	-

9.2.3.2.17.3.3 Specific message contents

Table 9.2.3.2.17.3.3-1: Message TRACKING AREA UPDATE REQUEST (step 2, step 4, step 6, step 8, step 10, Table 9.2.3.2.17.3.2-1)

Derivation Path: 36.508, Table 4.7.2-27			
Information Element	Value/remark	Comment	Condition
EPS update type			
EPS update type Value	'001'B	"combined TA/LA updating"	
Old GUTI	GUTI-1		
Last visited registered TAI	TAI-1		
Old LAI	LAI-1		
TMSI Status	Not Present		

Table 9.2.3.2.17.3.3-2: Message TRACKING AREA UPDATE REQUEST (step 13, Table 9.2.3.2.17.3.2-1)

Derivation Path: 36.508, Table 4.7.2-27			
Information Element	Value/remark	Comment	Condition
EPS update type			
EPS update type Value	'001'B	"combined TA/LA updating"	
Old GUTI	GUTI-1		
Old location area identification	Not present		
TMSI status	0	no valid TMSI available	

Table 9.2.3.2.17.3.3-3: Message TRACKING AREA UPDATE ACCEPT (step 14, Table 9.2.3.2.17.3.2-1)

Derivation Path: 36.508, Table 4.7.2-24			
Information Element	Value/remark	Comment	Condition
GUTI	GUTI-2		

9.2.3.3 lu mode to S1 mode inter-system change in idle mode

9.2.3.3.1 First lu mode to S1 mode inter-system change after attach

9.2.3.3.1.1 Test Purpose (TP)

(1)

```
with { the UE is powered on in UTRAN with a USIM containing valid EPS identities and EPS security context and has attached in UTRAN and activated a PDP context }
ensure that {
  when { the UE reselects a E-UTRAN cell }
  then { the UE transmits a TRACKING AREA UPDATE REQUEST message including eKSI stored in the USIM, old GUTI mapped from RAI and P-TMSI, GPRS ciphering sequence number, nonceUE and the UE radio capability information update needed IE, the message is integrity protected using the EPS security context stored in the USIM and encapsulated in an RRCConnectionSetupComplete message with registeredMME set to the MME part of the mapped GUTI }
```

(2)

```
with { the UE has performed a TAU procedure in EUTRAN after initial registration at power on in UTRAN }
ensure that {
  when { the UE reselects a UTRAN cell }
  then { the UE transmits a ROUTING AREA UPDATE REQUEST message including P-TMSI and P-TMSI signature mapped from GUTI, previously allocated P-TMSI as additional mobile identity, RAI where P-TMSI was allocated as additional old routing area identification, eKSI allocated in UTRAN as GPRS ciphering key sequence number, the message is encapsulated in an INITIAL DIRECT TRANSFER message including IDNSS mapped from P-TMSI }
```

(3)

```
with { the UE has performed a TAU procedure in EUTRAN after initial registration at power on in UTRAN and has transmitted a ROUTING AREA UPDATE REQUEST message and received an AUTHENTICATION AND CIPHERING REQUEST message }
ensure that {
  when { the UE receives a SECURITY MODE COMMAND message }
  then { the UE transmits a SECURITY MODE COMPLETE and starts performing ciphering an integrity protection using new CK and IK }
```

(4)

```
with { the UE has performed initial registration at power on in UTRAN and has EPS security context }
ensure that {
  when { UE performs a TAU procedure in E-UTRAN }
  then { the UE starts performing ciphering an integrity protection using EPS security context }
```

NOTE: ISR considered not in the scope of this test case, so it is never activated.

9.2.3.3.1.2 Conformance requirements

References: The conformance requirements covered in the current TC are specified in: TS 23.003 clause 2.8.2.1, 2.8.2.2, TS 23.401 clauses 5.3.1.1, 5.3.3.1, 5.3.3.3 and Annex D; TS 25.331 clauses 8.1.8.2 and 10.3.1.6 (on IDNNS); TS 24.008 [NAS message contents]; TS 24.301 clause 5.5.3.2.2; and TS 36.331 clauses 5.3.3.3 and 5.3.3.4.

[TS 23.003, clause 2.8.2.1]

The mapping of the GUTI shall be done to the combination of RAI of GERAN / UTRAN and the P-TMSI:

E-UTRAN <MCC> maps to GERAN/UTRAN <MCC>

E-UTRAN <MNC> maps to GERAN/UTRAN <MNC>

E-UTRAN <MME Group ID> maps to GERAN/UTRAN <LAC>

E-UTRAN <MME Code> maps to GERAN/UTRAN <RAC> and is also copied into the 8 most significant bits of the NRI field within the P-TMSI;

E-UTRAN <M-TMSI> maps as follows:

- 6 bits of the E-UTRAN <M-TMSI> starting at bit 29 and down to bit 24 are mapped into bit 29 and down to bit 24 of the GERAN/UTRAN <P-TMSI>;
- 16 bits of the E-UTRAN <M-TMSI> starting at bit 15 and down to bit 0 are mapped into bit 15 and down to bit 0 of the GERAN/UTRAN <P-TMSI>;
- and the remaining 8 bits of the E-UTRAN <M-TMSI> are mapped into the 8 MBS bits of the <P-TMSI signature> field.

For UTRAN, the 10-bit long NRI bits are masked out from the P-TMSI and also supplied to the RAN node as IDNNS (Intra Domain NAS Node Selector). However, the RAN configured NRI length should not exceed 8 bits.

[TS 23.003, clause 2.8.2.2]

The mapping of P-TMSI (TLLI) and RAI in GERAN/UTRAN to GUTI in E-UTRAN shall be performed as follows:

GERAN/UTRAN <MCC> maps to E-UTRAN <MCC>

GERAN/UTRAN <MNC> maps to E-UTRAN <MNC>

GERAN/UTRAN <LAC> maps to E-UTRAN <MME Group ID>

GERAN/UTRAN <RAC> maps into bit 23 and down to bit 16 of the M-TMSI

The 8 most significant bits of GERAN/UTRAN <NRI> map to the MME code.

GERAN/UTRAN <P-TMSI> maps as follows:

- 6 bits of the GERAN/UTRAN <P-TMSI> starting at bit 29 and down to bit 24 are mapped into bit 29 and down to bit 24 of the E-UTRAN <M-TMSI>;
- 16 bits of the GERAN/UTRAN <P-TMSI> starting at bit 15 and down to bit 0 are mapped into bit 15 and down to bit 0 of the E-UTRAN <M-TMSI>.

The values of <LAC> and <MME group id> shall be disjoint, so that they can be differentiated. The most significant bit of the <LAC> shall be set to zero; and the most significant bit of <MME group id> shall be set to one. Based on this definition, the most significant bit of the <MME group id> can be used to distinguish the node type, i.e. whether it is an MME or SGSN.

[TS 24.301 clause 5.3.1.1]

When the UE is in EMM-IDLE mode and needs to transmit an initial NAS message, the UE shall request the lower layer to establish a RRC connection. In this request to the lower layer the NAS shall provide to the lower layer the RRC establishment cause and the call type as specified in annex D of this specification.

...

[TS 23.401, clause 5.3.3.1, step 2, "Tracking Area Update procedure with Serving GW change"]

...

If the UE's TIN indicates "P-TMSI" and the UE holds a valid P-TMSI and related RAI then these two elements are indicated as the old GUTI.

...

[TS 23.401, clause 5.3.3.3, step 2, "Routeing Area Update with MME interaction and without S-GW change"]

...

If the UE's internal TIN indicates "GUTI" and the UE holds a valid GUTI then the UE indicates the GUTI as the old P-TMSI and old RAI

...

[TS 24.301, clause 5.5.3.2.2 "Normal and periodic tracking area updating procedure initiation"]

...

If the UE supports A/Gb mode or Iu mode, the UE shall handle the GUTI as follows:

- if the TIN indicates "P-TMSI" and the UE holds a valid P-TMSI and RAI, the UE shall map the P-TMSI and RAI into the old GUTI IE. If a P-TMSI signature is associated with the P-TMSI, the UE shall include it in the Old P-TMSI signature IE. Additionally, if the UE holds a valid GUTI, the UE shall indicate the GUTI in the Additional GUTI IE.

NOTE: Mapping the P-TMSI and RAI to the GUTI is specified in Annex H of 3GPP TS 23.401 [10].

- if the TIN indicates "GUTI" or "RAT-related TMSI" and the UE holds a valid GUTI, the UE shall indicate the GUTI in the Old GUTI IE.

...

If the UE has a current EPS security context, the UE shall include the eKSI (either KSI_{ASME} or KSI_{SGSN}) in the NAS Key Set Identifier IE in the TRACKING AREA UPDATE REQUEST message. Otherwise, the UE shall set the NAS Key Set Identifier IE to the value "no key is available". If the UE has a current EPS security context, the UE shall integrity protect the TRACKING AREA UPDATE REQUEST message with the current EPS security context. Otherwise the UE shall not integrity protect the TRACKING AREA UPDATE REQUEST message.

...

When the tracking area updating procedure is initiated in EMM-IDLE mode to perform an inter-system change from A/Gb mode or Iu mode to S1 mode and the TIN is set to "P-TMSI", the UE shall include the GPRS ciphering key sequence number applicable for A/Gb mode or Iu mode and a $nonce_{UE}$ in the TRACKING AREA UPDATE REQUEST message.

...

If the UE initiates the first tracking area updating procedure following an attach in A/Gb mode or Iu mode, the UE shall include a UE radio capability information update needed IE in the TRACKING AREA UPDATE REQUEST message.

...[TS 24.301, Annex D]

...

Table D.1.1: Mapping of NAS procedure to establishment cause and call type

NAS procedure	RRC establishment cause (according 3GPP TS 36.331 [22])	Call type
Tracking Area Update	MO signalling (See Note 1)	"originating signalling"
Note 1:	For these NAS procedures initiated by UEs of access class 12, 13 or 14 in their home country, the RRC establishment cause will be set to "High priority access AC 11 – 15". For this purpose the home country is defined as the country of the MCC part of the IMSI, see 3GPP TS 22.011 [1A]. For these NAS procedures initiated by UE of access class 11 or 15 in their HPLMN or EHPLMN, the RRC establishment cause will be set to "High priority access AC 11 – 15".	

[TS 36.331, clause 5.3.3.3]

The UE shall set the contents of *RRCCONNECTIONREQUEST* message as follows:

- 1> set the *ue-Identity* as follows:
 - 2> if upper layers provide an S-TMSI:
 - 3> set the *ue-Identity* to the value received from upper layers;
 - 2> else
 - 3> draw a random value in the range $0 \dots 2^{40}-1$ and set the *ue-Identity* to this value;

NOTE 1 Upper layers provide the S-TMSI if the UE is registered in the TA of the current cell.

- 1> Set the *establishmentCause* in accordance with the information received from upper layers;

[TS 36.331, clause 5.3.3.4]

...

- 1> set the content of *RRCCONNECTIONSETUPCOMPLETE* message as follows:
 - 2> set the *selectedPLMN-Identity* to the PLMN selected by upper layers (see TS 23.122 [11], TS 24.301 [35]) from the PLMN(s) included in the *plmn-IdentityList* in *SystemInformationBlockType1*;
 - 2> if upper layers provide the 'Registered MME', set the *registeredMME* as follows:
 - 3> if the PLMN identity of the 'Registered MME' is different from the PLMN selected by the upper layers:
 - 4> include the *plmnIdentity* in the *registeredMME* and set it to the value of the PLMN identity in the 'Registered MME' received from upper layers;
 - 3> set the *mmegi* and the *mmec* to the value received from upper layers;
 - 2> set the *dedicatedInfoNAS* to include the information received from upper layers;

...

[TS 24.008, clause 4.7.5]

This procedure is used for:

...

- S1 mode to Iu mode or S1 mode to A/Gb mode intersystem change and ISR is not activated;

...

[TS 24.008, clause 4.7.5.1.1]

To initiate the normal routing area updating procedure, the MS sends the message ROUTING AREA UPDATE REQUEST to the network, starts timer T3330 and changes to state GMM-ROUTING-AREA-UPDATING-INITIATED.

If the MS supports S1 mode, the MS shall handle the P-TMSI IE as follows:

- If the TIN indicates "GUTI" and the MS holds a valid GUTI, the MS shall map the GUTI into a P-TMSI, P-TMSI signature and RAI as specified in 3GPP TS 23.003 [4]. The MS shall include the mapped RAI in the Old routing area identification IE and the mapped P-TMSI signature in the P-TMSI signature IE. When the routing area updating procedure is initiated in Iu mode, the MS shall also include the mapped P-TMSI in the P-TMSI IE. Additionally, in Iu mode and A/Gb mode, if the MS holds a valid P-TMSI and RAI, the MS shall indicate the P-TMSI in the Additional mobile identity IE and the RAI in the Additional old routing area identification IE.

...

If the routing area updating procedure is initiated by the MS due to an S1 mode to Iu mode or S1 mode to A/Gb mode inter-system change in idle mode and the TIN indicates "GUTI", the MS shall derive a UMTS security context for the PS domain from the current EPS security context as described in the subclause 4.7.7.10. The ROUTING AREA UPDATE REQUEST message shall include a P-TMSI signature filled with a NAS token as specified in 3GPP TS 33.401 [119]. Furthermore, the MS shall indicate the eKSI value, which is associated with the derived UMTS security keys, in the CKSN field of the GPRS GSM ciphering key sequence number IE in the ROUTING AREA UPDATE REQUEST message.

NOTE: When the MS includes a P-TMSI signature filled with a NAS token, 8 bits of the NAS token will be filled with bits from the M-TMSI (see 3GPP TS 23.003 [4]).

If the routing area updating procedure is initiated by the MS due to the S1 mode to Iu mode or S1 mode to A/Gb mode inter-system change in connected mode, the MS shall derive a UMTS security context for the PS domain from the current EPS security context as described in the subclause 4.7.7.10. Furthermore, the MS shall indicate the eKSI value, which is associated with the derived UMTS security keys, in the CKSN field of the GPRS GSM ciphering key sequence number IE in the ROUTING AREA UPDATE REQUEST message.

[TS 25.331, clause 8.1.8.2]

...

The UE shall, in the INITIAL DIRECT TRANSFER message:

- 1> set the IE "NAS message" as received from upper layers; and
- 1> set the IE "CN domain identity" as indicated by the upper layers; and
- 1> set the IE "Intra Domain NAS Node Selector" as follows:
 - 2> derive the IE "Intra Domain NAS Node Selector" from TMSI/PTMSI, IMSI, or IMEI; and
 - 2> provide the coding of the IE "Intra Domain NAS Node Selector" according to the following priorities:
 1. derive the routing parameter for IDNNS from TMSI (CS domain) or PTMSI (PS domain) whenever a valid TMSI/PTMSI is available;
 2. base the routing parameter for IDNNS on IMSI when no valid TMSI/PTMSI is available;
 3. base the routing parameter for IDNNS on IMEI only if no (U)SIM is inserted in the UE.
- 1> if the UE, on the existing RRC connection, has received a dedicated RRC message containing the IE "Primary PLMN Identity" in the IE "CN Information Info":
 - 2> set the IE "PLMN identity" in the INITIAL DIRECT TRANSFER message to the latest PLMN information received via dedicated RRC signalling. If NAS has indicated the PLMN towards which a signalling connection is requested, and this PLMN is not in agreement with the latest PLMN information received via dedicated RRC signalling, then the initial direct transfer procedure shall be aborted, and NAS shall be informed.
- 1> if the UE, on the existing RRC connection, has not received a dedicated RRC message containing the IE "CN Information Info" , and if the IE "Multiple PLMN List" was broadcast in the cell where the current RRC connection was established:

- 2> set the IE "PLMN identity" in the INITIAL DIRECT TRANSFER message to the PLMN chosen by higher layers [5, 25] amongst the PLMNs in the IE "Multiple PLMN List" broadcast in the cell where the RRC connection was established.
- 1> if the IE "Activated service list" within variable MBMS_ACTIVATED_SERVICES includes one or more MBMS services with the IE "Service type" set to "Multicast" and;
- 1> if the IE "CN domain identity" as indicated by the upper layers is set to "CS domain" and;
- 1> if the variable ESTABLISHED_SIGNALLING_CONNECTIONS does not include the CN domain identity 'PS domain':
 - 2> include the IE "MBMS joined information";
 - 2> include the IE "P-TMSI" within the IE "MBMS joined information" if a valid PTMSI is available.
- 1> if the UE is in CELL_FACH state and the IE "CN domain identity" as indicated by the upper layers is set to "CS domain":
 - 2> if the value of the variable ESTABLISHMENT_CAUSE is set to "Originating Conversational Call" or "Emergency Call":
 - 3> set the value of the IE "Call type" to "speech", "video" or "other" according to the call being initiated.
- 1> if the variable ESTABLISHMENT_CAUSE is initialised:
 - 2> set the IE "Establishment cause" to the value of the variable ESTABLISHMENT_CAUSE;
 - 2> clear the variable ESTABLISHMENT_CAUSE.
- 1> calculate the START according to subclause 8.5.9 for the CN domain as set in the IE "CN Domain Identity"; and
- 1> include the calculated START value for that CN domain in the IE "START".

9.2.3.3.1.3 Test description

9.2.3.3.1.3.1 Pre-test conditions

System Simulator:

- cell A, cell B and cell 5 (UTRA cell in LAI-1/RAI-1);
- cell 5 is configured as Serving cell, cell A as Non-Suitable cell.
- System information combination 4 as defined in TS 36.508[18] clause 4.4.3.1 is used in E-UTRA cells.

NOTE: For Cell 5, power levels are defined in TS 34.108 subclause 6.1.5 (FDD) or 6.1.6 (TDD).

UE:

- the UE is previously registered on E-UTRAN, and when on E-UTRAN, the UE is last authenticated and registered on cell B using default message contents according to TS 36.508 [18].

Note: Cell B belongs to TAI-2 (unlike cell A).

Preamble:

- the UE is in state Switched OFF (state 1) according to TS 36.508 [18].

9.2.3.3.1.3.2 Test procedure sequence

Table 9.2.3.3.1.3.2-1: Main behaviour

St	Procedure	Message Sequence		TP	Verdict
		U – S	Message		
1	The UE is switched on.	-	-	-	-
2	The UE transmits an ATTACH REQUEST message on Cell 5	-->	ATTACH REQUEST	-	-
3	The SS transmits an AUTHENTICATION AND CIPHERING REQUEST message.	<--	AUTHENTICATION AND CIPHERING REQUEST	-	-
4	The UE transmits an AUTHENTICATION AND CIPHERING RESPONSE message.	-->	AUTHENTICATION AND CIPHERING RESPONSE	-	-
5	Void	-	-	-	-
6	Void	-	-	-	-
7	Void	-	-	-	-
8	SS responds with ATTACH ACCEPT message including P-TMSI-1 and RAI-1.	<--	ATTACH ACCEPT	-	-
9	The UE transmits an ATTACH COMPLETE message.	-->	ATTACH COMPLETE	-	-
10	The activation of a PDP context is triggered by MMI or AT command.	-	-	-	-
11	Void	-	-	-	-
12	The SS establishes a radio bearer associated with the requested PDP context.	-	-	-	-
13	The SS releases the RRC connection.	-	-	-	-
14	Cell A is configured as the Serving Cell, Cell 5 is configured as a Suitable Neighbour Cell.	-	-	-	-
15	Check: Does the UE transmit an RRCConnectionRequest with the <i>InitialUE-Identity</i> set to "randomValue" and the <i>establishmentCause</i> set to <i>MO-signalling</i> ?	-	-	1	P
16	The SS responds with RRCConnectionSetup.	-	-		
17	Check: Does the UE transmit an RRCConnectionSetupComplete message with the <i>mmegi</i> and <i>mmec</i> are set to the values derived from the mapped RAI and P-TMSI, and containing a TRACKING AREA UPDATE REQUEST message as described in the specific message contents? Check2: Does the UE transmit a TRACKING AREA UPDATE REQUEST message integrity protected using IK derived from K_{ASME} ?	-->	TRACKING AREA UPDATE REQUEST	1, 4	P
18	The SS responds with a TRACKING AREA UPDATE ACCEPT allocating a new GUTI and TAI list. This message is ciphered and integrity protected using CK and IK derived from K_{ASME} .	<--	TRACKING AREA UPDATE ACCEPT	-	-
18 A	Check: Does the UE transmit a TRACKING AREA UPDATE COMPLETE message ciphered and integrity protected using CK and IK derived from K_{ASME} .	-->	TRACKING AREA UPDATE COMPLETE	4	P
19	The SS releases the RRC connection	-	-	-	-
20	Void	-	-	-	-
21	Cell 5 is configured as the Serving Cell and Cell A is configured as a Non-Suitable Cell as defined in table 6.2.2.1-1 of TS 36.508 [18].	-	-	-	-
22	Void	-	-	-	-
23	Check: Does the UE transmit a ROUTING AREA UPDATE REQUEST message as specified in the specific message contents included in an INITIAL DIRECT TRANSFER message with <i>intraDomainNasNodeSelector</i> mapped from GUTI allocated in step 18?	-->	ROUTING AREA UPDATE REQUEST	2	P
23 AA	The SS sends an AUTHENTICATION AND CIPHERING REQUEST message to perform a UMTS AKA procedure.	<--	AUTHENTICATION AND CIPHERING REQUEST	-	-

23 AB	The UE sends an AUTHENTICATION AND CIPHERING RESPONSE message.	-->	AUTHENTICATION AND CIPHERING RESPONSE	-	-
23 A	The SS sends a SECURITY MODE COMMAND message to activate integrity protection and ciphering. This message is integrity protected using new IK.	-	-	-	-
23 B	Check: Does the UE transmit a SECURITY MODE COMPLETE message integrity protected using new IK?	-	-	3	P
24	The SS transmits a ROUTING AREA UPDATE ACCEPT message (no new P-TMSI nor RAI). This message is ciphered and integrity protected using CK and IK derived at step 23AA.	<--	ROUTING AREA UPDATE ACCEPT	-	-
25	After the activation time indicated at step 23A, the SS transmits a UE CAPABILITY ENQUIRY message requesting the UE E-UTRAN capability. This message is ciphered and integrity protected using CK and IK derived at step 23AA.	-	-	-	-
26	Check: Does the UE transmit a UE CAPABILITY INFORMATION message? Note: the purpose of this message is to show that the UE uses CK and IK derived at step 23AA, and not the CK and IK allocated at step 4.	-	-	3	P
27	The SS transmits a UE CAPABILITY INFORMATION CONFIRM message.	-	-	-	-
28	The SS releases the RRC connection	-	-	-	-

9.2.3.3.1.3.3 Specific message contents

Table 9.2.3.3.1.3.3-1: Message RRCConnectionRequest (step 15, Table 9.2.3.3.1.3.2-1)

Derivation path: 36.508 table 4.6.1-16			
Information Element	Value/Remark	Comment	Condition
RRCConnectionRequest ::= SEQUENCE {			
criticalExtensions CHOICE {			
rrcConnectionRequest-r8 SEQUENCE {			
ue-Identity CHOICE {			
random-Value	Any allowed value		
}			
establishmentCause	Mo-Signalling		
}			
}			
}			

Table 9.2.3.3.1.3.3-2: Message RRCConnectionSetupComplete (step 17, Table 9.2.3.3.1.3.2-1)

Derivation path: 36.508 table 4.6.1-18			
Information Element	Value/Remark	Comment	Condition
RRCConnectionSetupComplete ::= SEQUENCE {			
criticalExtensions CHOICE {			
c1 CHOICE {			
rrcConnectionSetupComplete-r8 SEQUENCE {			
selectedPLMN-Identity	1		
registeredMME {			
plmn-Identity	Not present		
mmegi	LAC sent to the UE in step 8		
mmec	Bit 23 to bit 16 of P-TMSI sent to the UE in step 8		
}			
dedicatedInfoNAS	See table 9.2.3.3.1.3.3-3		
nonCriticalExtension SEQUENCE {}			
}			
}			
}			
}			
Details to be added			

Table 9.2.3.3.1.3.3-3: Message TRACKING AREA UPDATE REQUEST (step 17, Table 9.2.3.3.1.3.2-1)

Derivation path: 36.508 table 4.7.2-24 with condition UNCIPHERED (the message is integrity protected using the key stored in the USIM).			
Information Element	Value/Remark	Comment	Condition
EPS update type	000 or 001	'TA updating' or 'combined TA/LA updating'	
NAS key set identifier			
NAS key set identifier	The valid NAS key set identifier stored in the USIM		
TSC	'0'B	native security context (for KSI _{ASME})	
Old GUTI or IMSI			
Type of identity	110	GUTI	
MNC/MCC	Mobile Country Code and Mobile Network Code stored in EF _{IMSI} on the test USIM		
MME Group ID	LAI allocated at step 8		
MME Code	Bit 23 to bit 16 of P-TMSI allocated at step 8		
M-TMSI	Value is specified bit by bit below: - bit 31 and bit 30: FFS - bit 29 to bit 24: bit 29 to bit 24 of P-TMSI allocated at step 8 - bit 23 to bit 16: RAC allocated at step 8 - bit 15 to bit 0: bit 15 to bit 0 of P-TMSI allocated at step 8		
GPRS ciphering key sequence number	GPRS ciphering key sequence number allocated at step 3		
Old P-TMSI signature	P-TMSI signature allocated at step 8		
Additional GUTI	GUTI-1		
Nonce _{UE}	Any allowed value (must be present)		
UE network capability	Any allowed value (must be present)		
Last visited registered TAI	TAI stored in the test USIM		
UE radio capability information update needed	1	UE radio capability information update needed	
MS network capability	Any allowed value (must be present)		
Old location area identification	Not present if "EPS update type" is 'TA updating', LAI-1 is "EPS update type" is 'combined TA/LA updating'		
TMSI status	Not present		

Table 9.2.3.3.1.3.3-4: INITIAL DIRECT TRANSFER (step 23, Table 9.2.3.3.1.3.2-1)

Derivation path: 34.108 clause 9.1.1			
Information Element	Value/Remark	Comment	Condition
InitialDirectTransfer ::= SEQUENCE {			
cn-DomainIdentity	ps-domain		
intraDomainNasNodeSelector SEQUENCE {			
version CHOICE {			
release99 SEQUENCE {			
gsm-Map-IDNNS SEQUENCE {			
routingbasis CHOICE {			
tMSIofsamePLMN {			
routingparameter	bit 23 to bit 14 of P-TMSI mapped from GUTI allocated to UE in step 18		
}			
}			
}			
}			
}			
}			
nas-Message	See table 9.2.3.3.1.3.3-5		
}			

Table 9.2.3.3.1.3.3-5: Message ROUTING AREA UPDATE REQUEST (step 23, Table 9.2.3.3.1.3.2-1)

Derivation path: 24.008 table 9.4.14			
Information Element	Value/Remark	Comment	Condition
Update type	000 or 001	RA updating or Combined RA/LA updating	
GPRS ciphering key sequence number	eKSI stored on the test USIM		
Old routing area identification	GUTI-1 right shifted by 32bits		
MS Radio Access capability	Not checked		
Old P-TMSI signature	Value is specified bit by bit below: - bit 23 to bit 16: bit 23 to bit 16 of M-TMSI allocated in step 18 - bit 15 to bit 0: FFS		
Requested READY timer value	Not checked		
DRX parameter	Not checked		
TMSI status	Not present		
P-TMSI	Value is specified bit by bit below: - bit 31 and bit 30: 1 - bit 29 to bit 24: bit 29 to bit 24 of M-TMSI allocated in step 18 - bit 23 to bit 16: MME code allocated in step 18 - bit 15 to bit 0: bit 15 to bit 0 of M-TMSI allocated in step 18		
MS network capability	Not checked		
PDP context status	Not checked		
PS LCS Capability	Not checked		
MBMS context status	Not checked		
UE network capability	Any allowed value		
Additional mobile identity	P-TMSI allocated in step 8		
Additional old routing area identification	RAI-1		
Mobile station classmark 2	Not checked		
Mobile station classmark 3	Not checked		
Supported Codecs	Not checked		

9.2.3.3.2 Iu mode to S1 mode intersystem change / ISR is active / Expiry of T3312 in E-UTRAN or T3412 in UTRAN and further intersystem change

9.2.3.3.2.1 Test Purpose (TP)

(1)

```
with { the UE is camped on a E-UTRAN cell, ISR is active, T3312 has expired, T3323 hasn't expired }
ensure that {
  when { UE enters a UTRAN cell belonging to the RA where the UE was last updated }
  then { the UE performs a RAU procedure including the UE P-TMSI and RAI }
}
```

(2)

```
with { the UE is camped on a E-UTRAN cell, ISR is active, T3312 and T3323 have expired }
ensure that {
  when { UE enters a UTRAN cell belonging to the RA where the UE was last updated }
  then { the UE performs a RAU procedure including mapped identities from E-UTRAN and additional P-TMSI and old RAI }
}
```

(3)

```

with { the UE operating in PS mode 1 or PS mode 2, is camped on a UTRAN cell, ISR is active, T3412
has expired, T3423 hasn't expired }
ensure that {
  when { UE enters a E-UTRAN cell in a TA belonging to the current TA list }
  then { the UE performs a TAU procedure including the UE GUTI and last visited TAI }
}

```

(4)

```

with { the UE operating in PS mode 1 or PS mode 2, is camped on a UTRAN cell, ISR is active, T3412
and T3423 have expired }
ensure that {
  when { the UE enters a E-UTRAN cell in a TA belonging to the current TA list }
  then { the UE performs a TAU procedure including mapped GUTI from UTRAN, P-TMSI signature and
additional GUTI }
}

```

9.2.3.3.2.2 Conformance requirements

References: The conformance requirements covered in the present TC are specified in: TS 24.301 clauses 5.3.5 and 5.5.3.2.2 and TS 24.008 clauses 4.7.2.2 and 4.7.5.1.1.

[24.301, clause 5.3.5]

If ISR is activated, the UE shall keep both the periodic tracking area update timer (timer T3412) and the periodic routing area update timer (timer T3312). The two separate timers run in the UE for updating MME and SGSN independently. If the periodic tracking area update timer expires and the UE cannot initiate the tracking area updating procedure, as it is in state EMM-REGISTERED.NO-CELL-AVAILABLE, the UE shall start the E-UTRAN deactivate ISR timer T3423. The UE shall initiate the tracking area updating procedure and stop the timer T3423 when it enters state EMM-REGISTERED.NORMAL-SERVICE before timer T3423 expires. After expiry of timer T3423 the UE shall set its TIN to "P-TMSI" in order to initiate the tracking area updating procedure when it returns to state EMM-REGISTERED.NORMAL-SERVICE.

If the UE is attached to both EPS and non-EPS services, and if timer T3412 expires or timer T3423 expires when the UE is in EMM-REGISTERED.NO-CELL-AVAILABLE state, then the UE shall initiate the combined tracking area updating procedure indicating "combined TA/LA updating with IMSI attach" when the UE returns to EMM-REGISTERED.NORMAL-SERVICE state.

[24.301, clause 5.5.3.2.2]

If the UE supports neither A/Gb mode nor Iu mode, the UE shall include a valid GUTI in the Old GUTI IE in the TRACKING AREA UPDATE REQUEST message.

If the UE supports A/Gb mode or Iu mode, the UE shall handle the Old GUTI IE as follows:

- If the TIN indicates "P-TMSI" and the UE holds a valid P-TMSI and RAI, the UE shall map the P-TMSI and RAI into the Old GUTI IE. If a P-TMSI signature is associated with the P-TMSI, the UE shall include it in the Old P-TMSI signature IE. Additionally, if the UE holds a valid GUTI, the UE shall indicate the GUTI in the Additional GUTI IE.

NOTE: The mapping of the P-TMSI and RAI to the GUTI is specified in 3GPP TS 23.003 [2].

- If the TIN indicates "GUTI" or "RAT-related TMSI" and the UE holds a valid GUTI, the UE shall indicate the GUTI in the Old GUTI IE.

[24.008, clause 4.7.2.2]

If ISR is activated, the MS shall keep both the periodic tracking area update timer (timer T3412) and the periodic routing area update timer (timer T3312). The two separate timers run in the MS for updating MME and SGSN independently. If the periodic routing area update timer expires and the MS is in state GMM-REGISTERED.NO-CELL-AVAILABLE, the MS shall set its TIN to "RAT-related TMSI" and start the GERAN/UTRAN Deactivate ISR timer T3323. The MS shall initiate the routing area updating procedure and stop the timer T3323 when the MS enters the state GMM-REGISTERED.NORMAL-SERVICE before timer T3323 expires. After expiry of timer T3323 the MS shall deactivate ISR by setting its TIN to "GUTI" and initiate the routing area updating procedure when the MS enters the state GMM-REGISTERED.NORMAL-SERVICE.

...

If the MS is both IMSI attached for GPRS and non-GPRS services, and if the MS lost coverage of the registered PLMN and timer T3312 expires or timer T3323 expires, then:

- a) if the MS returns to coverage in a cell that supports GPRS and that indicates that the network is in network operation mode I, then the MS shall either perform the combined routing area update procedure indicating "combined RA/LA updating with IMSI attach"; or
- b) if the MS returns to coverage in a cell in the same RA that supports GPRS and that indicates that the network is in network operation mode II or III, then the MS shall perform the periodic routing area updating procedure indicating "Periodic updating"; or
- c) if the MS was both IMSI attached for GPRS and non-GPRS services in network operation mode I and the MS returns to coverage in a cell in the same LA that does not support GPRS, then the MS shall perform the periodic location updating procedure. In addition, the MS shall perform a combined routing area update procedure indicating "combined RA/LA updating with IMSI attach" when the MS enters a cell that supports GPRS and that indicates that the network is in network operation mode I; or
- d) if the MS returns to coverage in a new RA the description given in subclause 4.7.5 applies.

If the MS is both IMSI attached for GPRS and non-GPRS services in a network that operates in network operation mode I, and if the MS has camped on a cell that does not support GPRS, and timer T3312 expires or timer T3323 expires, then the MS shall start an MM location updating procedure. In addition, the MS shall perform a combined routing area update procedure indicating "combined RA/LA updating with IMSI attach" when the MS enters a cell that supports GPRS and indicates that the network is in operation mode I.

If timer T3312 expires or timer T3323 expires during an ongoing CS connection, then a MS operating in MS operation mode B shall treat the expiry of T3312 when the MM state MM-IDLE is entered, analogous to the descriptions for the cases when the timer expires out of coverage or in a cell that does not support GPRS.

In A/Gb mode, timer T3312 and timer T3323 shall not be stopped when a GPRS MS enters state GMM-REGISTERED.SUSPENDED.

[24.008, clause 4.7.5.1.1]

If the MS supports S1 mode, the MS shall handle the P-TMSI IE as follows:

- If the TIN indicates "GUTI" and the MS holds a valid GUTI, the MS shall map the GUTI into a P-TMSI, P-TMSI signature and RAI as specified in 3GPP TS 23.003 [4]. The MS shall include the mapped RAI in the Old routing area identification IE and the mapped P-TMSI signature in the P-TMSI signature IE. When the routing area updating procedure is initiated in Iu mode, the MS shall also include the mapped P-TMSI in the P-TMSI IE. Additionally, in Iu mode and A/Gb mode, if the MS holds a valid P-TMSI and RAI, the MS shall indicate the P-TMSI in the Additional mobile identity IE and the RAI in the Additional old routing area identification IE.
- If the TIN indicates "P-TMSI" or "RAT-related TMSI" and the MS holds a valid P-TMSI and RAI, the MS shall indicate the RAI in the Old routing area identification IE. When the routing area updating procedure is initiated in Iu mode, the MS shall also include the P-TMSI in the P-TMSI IE.

9.2.3.3.2.3 Test description

9.2.3.3.2.3.1 Pre-test conditions

System Simulator:

- cell A and cell 5 (HPLMN);
- cell 5 indicates NMO I .
- System information combination 4 as defined in TS 36.508[18] clause 4.4.3.1 is used in E-UTRA cells.

UE:

none.

Preamble:

- the UE is in state Registered, Idle Mode (state 2) on cell A according to TS 36.508 [18] and with M-TMSI = 9a26319c (arbitrary value chosen for this test case).

9.2.3.3.2.3.2 Test procedure sequence

Table 9.2.3.3.2.3.2-1: Main behaviour

St	Procedure	Message Sequence		TP	Verdict
		U - S	Message		
1	The SS sets the cell type of Cell 5 to "Serving Cell" and the cell type of Cell A to "Non-suitable cell".	-	-	-	-
2	The UE transmits a ROUTING AREA UPDATE message on cell 5.	-->	ROUTING AREA UPDATE REQUEST	-	-
3	The SS transmits a ROUTING AREA UPDATE ACCEPT message on Cell 5 with T3312 set to 1 minute and T3323 set to 2 minutes.	<--	ROUTING AREA UPDATE ACCEPT	-	-
4	The UE transmits a ROUTING AREA UPDATE COMPLETE message on Cell 5.	-->	ROUTING AREA UPDATE COMPLETE	-	-
4A	The SS releases the RRC connection.	-	-	-	-
5	The SS sets the cell type of Cell A to "Serving cell" and the cell type of Cell 5 to "Non-suitable cell".	-	-	-	-
-	EXCEPTION: Steps 5Aa1 to 5Aa4 describe behaviour that depends on the UE capability; the "lower case letter" identifies a step sequence that take place according to UE mode of operation.	-	-	-	-
5A a1	IF CS/PS mode 1 or CS/PS mode 2 of operation is configured on the UE and px_AttachTypeTested is set to COMBINED_ATTACH THEN the UE transmits a TRACKING AREA UPDATE REQUEST message on Cell A.	-->	TRACKING AREA UPDATE REQUEST	-	-
5A a2	The SS transmits a TRACKING AREA UPDATE ACCEPT message on Cell A.	<--	TRACKING AREA UPDATE ACCEPT	-	-
5A a3	The UE transmits a TRACKING AREA UPDATE COMPLETE message on Cell A.	-->	TRACKING AREA UPDATE COMPLETE	-	-
5A a4	The SS releases the RRC connection.	-	-	-	-
6	90s after step 3, the SS sets the cell type of Cell 5 to "Serving Cell" and the cell type of Cell A to "Non-suitable cell".	-	-	-	-
7	Check: Does the UE transmit a ROUTING AREA UPDATE REQUEST message on Cell 5 in the time period between expiry of T3312 – started upon RRC Connection Release after step 4A – and before expiry of T3323 – which was started when T3312 expired?	-->	ROUTING AREA UPDATE REQUEST	1	P
8	The SS transmits a ROUTING AREA UPDATE ACCEPT message on Cell 5 with T3312 set to 1 minute and T3323 set to 1 minute.	<--	ROUTING AREA UPDATE ACCEPT	-	-
8A	The SS releases the RRC connection.	-	-	-	-
9	The SS sets the cell type of Cell A to "Serving cell" and the cell type of Cell 5 to "Non-suitable cell".	-	-	-	-
-	EXCEPTION: Steps 9Aa1 to 9Aa4 describe behaviour that depends on the UE capability; the "lower case letter" identifies a step sequence that take place according to UE mode of operation.	-	-	-	-
9A a1	IF CS/PS mode 1 or CS/PS mode 2 of operation is configured on the UE and px_AttachTypeTested is set to COMBINED_ATTACH THEN the UE transmits a TRACKING AREA UPDATE REQUEST message on Cell A.	-->	TRACKING AREA UPDATE REQUEST	-	-
9A a2	The SS transmits a TRACKING AREA UPDATE ACCEPT message on Cell A.	<--	TRACKING AREA UPDATE ACCEPT	-	-
9A	The UE transmits a TRACKING AREA	-->	TRACKING AREA UPDATE	-	-

a3	UPDATE COMPLETE message on Cell A.		COMPLETE		
9A a4	The SS releases the RRC connection.	-	-	-	-
10	150s after step 8, the SS sets the cell type of Cell 5 to "Serving Cell" and the cell type of Cell A to "Non-suitable cell".	-	-	-	-
11	Check: Does the UE transmit a ROUTING AREA UPDATE REQUEST message on Cell 5 after both timers expired, T3312 which was started after step 8A and T3323 which was started upon expiry of T3312?	-->	ROUTING AREA UPDATE REQUEST	2	P
12	The SS transmits a ROUTING AREA UPDATE ACCEPT message on Cell 5.	<--	ROUTING AREA UPDATE ACCEPT	-	-
12 A	The SS releases the RRC connection.	-	-	-	-
13	The SS sets the cell type of Cell A to "Serving cell" and the cell type of Cell 5 to "Non-suitable cell".	-	-	-	-
14	The UE transmits a TRACKING AREA UPDATE REQUEST message	-->	TRACKING AREA UPDATE REQUEST	-	-
15	The SS transmits a TRACKING AREA UPDATE ACCEPT message with EPS update result indicating that ISR is active, T3412 set to 1 minute and T3423 set to 2 minutes.	<--	TRACKING AREA UPDATE ACCEPT	-	-
16	The UE transmits a TRACKING AREA UPDATE COMPLETE message.	-->	TRACKING AREA UPDATE COMPLETE	-	-
-	EXCEPTION: Steps 16A to 24 describe behaviour that is performed if PS mode 1 or PS mode 2 of operation is configured on the UE.	-	-	-	-
16 A	The SS releases the RRC connection.	-	-	-	-
17	The SS sets the cell type of Cell 5 to "Serving Cell" and the cell type of Cell A to "Non-suitable cell".	-	-	-	-
17 Aa 1	Void	-	-	-	-
17 Aa 2	Void	-	-	-	-
18	90s after step 16, the SS sets the cell type of Cell A to "Serving cell" and the cell type of Cell 5 to "Non-suitable cell".	-	-	-	-
19	Check: Does the UE transmit a TRACKING AREA UPDATE REQUEST message on Cell A in the time period between expiry of T3412 – started upon RRC Connection Release after step 16A – and before expiry of T3423 – which was started when T3412 expired?	-->	TRACKING AREA UPDATE REQUEST	3	P
20	The SS transmits a TRACKING AREA UPDATE ACCEPT message with EPS update result indicating that ISR is active, T3412 set to 1 minute and T3423 set to 1 minute.	<--	TRACKING AREA UPDATE ACCEPT	-	-
20 A	The SS releases the RRC connection.	-	-	-	-
21	The SS sets the cell type of Cell 5 to "Serving Cell" and the cell type of Cell A to "Non-suitable cell".	-	-	-	-
21 Aa 1	Void	-	-	-	-
21 Aa 2	Void	-	-	-	-
22	150s after step 20, the SS sets the cell type of Cell A to "Serving cell" and the cell type of Cell	-	-	-	-

	5 to "Non-suitable cell".				
23	Check: Does the UE transmit a TRACKING AREA UPDATE REQUEST message on Cell A after both timers expired, T3412 which was started after step 20A and T3423 which was started upon expiry of T3412?	-->	TRACKING AREA UPDATE REQUEST	4	P
24	The SS transmits a TRACKING AREA UPDATE ACCEPT message.	<--	TRACKING AREA UPDATE ACCEPT	-	-
-	At the end of this test procedure sequence, the UE is in end state E-UTRA connected (E2_T3440) according to TS 36.508.	-	-	-	-

9.2.3.3.2.3.3 Specific message contents

Table 9.2.3.3.2.3.3-1: Message ROUTING AREA UPDATE ACCEPT (step 3, table 9.2.3.3.2.3.2-1)

Derivation path: 24.008 table 9.4.15			
Information Element	Value/Remark	Comment	Condition
Update result	100	RA updated and ISR activated	TA only
	001	combined RA/LA updated	combined_TA_LA
Periodic RA update timer	00100001	1 minute	
Routing area identification	See 36.508 table 4.4.4-2	RAI of Cell 5	
P-TMSI signature	Not present		
Allocated P-TMSI	efb1ee97	TMSI is an arbitrary value chosen different from M-TMSI in the preamble	
T3323 value	00100010	2 minutes	

Table 9.2.3.3.2.3.3-2: Message ROUTING AREA UPDATE REQUEST (step 7, table 9.2.3.3.2.3.2-1)

Derivation path: 24.008 table 9.4.14			
Information Element	Value/Remark	Comment	Condition
Update type	011	Periodic updating	TA only
	001 or 010	Combined RA/LA updating or combined RA/LA updating with IMSI attach	combined_TA_LA
GPRS ciphering key sequence number	Any allowed value		
Old routing area identification	RAI of Cell 5 according to 36.508 table 4.4.4-2	The UE includes the RAI from UTRAN	
MS Radio Access capability	Any allowed value		
Old P-TMSI signature	Not present		
P-TMSI	Same value like allocated at step 3, see table 9.2.3.3.2.3.3-1	The UE includes the P-TMSI assigned from UTRAN	
UE network capabilities	Not present		Update Type = periodic updating
	Any allowed value		Update Type <> periodic updating
Additional mobile identity	Not present		
Additional old routing area identification	Not present		

Table 9.2.3.3.2.3.3-3: Message ROUTING AREA UPDATE ACCEPT (step 8, table 9.2.3.3.2.3.2-1)

Derivation path: 24.008 table 9.4.15			
Information Element	Value/Remark	Comment	Condition
Update result	100	RA updated and ISR activated	TA only
	001	combined RA/LA updated	combined_TA_LA
Periodic RA update timer	00100001	1 minute	
Routing area identification	See 36.508 table 4.4.4-2	RAI of Cell 5	
P-TMSI signature	Not present		
Allocated P-TMSI	Not present		
T3323 value	00100001	1 minute	

Table 9.2.3.3.2.3.3-4: Message ROUTING AREA UPDATE REQUEST (step 11, table 9.2.3.3.2.3.2-1)

Derivation path: 24.008 table 9.4.14			
Information Element	Value/Remark	Comment	Condition
Update type	000	RA updating	TA only
	010	combined RA/LA updating with IMSI attach	combined_TA_LA
GPRS ciphering key sequence number	Any allowed value		
Old routing area identification	TAI of cell A	The value is the same as the RAI of cell 5	
MS Radio Access capability	Any allowed value		
Old P-TMSI signature	Any allowed value		
P-TMSI	da01319c	Mapped from M-TMSI and MME code assigned in the preamble (start with 11 and MME code in 2 nd most significant byte).	
Additional mobile identity	Same value like allocated at step 3, see table 9.2.3.3.2.3.3-1		
Additional routing area identification	RAI of cell 5	The value is the same as the TAI of cell A	

Table 9.2.3.3.2.3.3-5: Message ROUTING AREA UPDATE ACCEPT (step 12, table 9.2.3.3.2.3.2-1)

Derivation path: 24.008 table 9.4.15			
Information Element	Value/Remark	Comment	Condition
Update result	000	RA updated	TA only
	001	combined RA/LA updated	combined_TA_LA
Periodic RA update timer	01010101	54 minutes	
Routing area identification	See 36.508 table 4.4.4-2	RAI of Cell 5	
P-TMSI signature	Not present		
Allocated P-TMSI	Not present		

Table 9.2.3.3.2.3.3-6: Message TRACKING AREA UPDATE REQUEST (step 14, table 9.2.3.3.2.3.2-1)

Derivation path: 36.508 table 4.7.2-27			
Information Element	Value/Remark	Comment	Condition
EPS update type	Any allowed value		
Additional GUTI	Any allowed value		
Nonce _{UE}	Any allowed value		

Table 9.2.3.3.2.3.3-7: Message TRACKING AREA UPDATE ACCEPT (step 15, table 9.2.3.3.2.3.2-1)

Derivation path: 36.508 table 4.7.2-24			
Information Element	Value/Remark	Comment	Condition
EPS update result	100	TA updated and ISR activated	TA_only
	101	combined TA/LA updated and ISR activated	combined_TA_LA
T3412 value	00100001	1 minute	
T3423 value	00100010	2 minutes	
GUTI			
M-TMSI	9a26319c	Same value like in preamble, different from P-TMSI	

Table 9.2.3.3.2.3.3-8: Message TRACKING AREA UPDATE REQUEST (step 19, table 9.2.3.3.2.3.2-1)

Derivation path: 36.508 table 4.7.2-27			
Information Element	Value/Remark	Comment	Condition
EPS update type	Any allowed value		
Old GUTI	Same GUTI as in step 15 see table 9.2.3.3.2.3.3-7		TA_Only
Last visited registered TAI	RAI of cell 5	The value is the same as the TAI of cell A	
Nonce _{UE}	Not Present		TA_only
Additional GUTI	Not present		TA_only

Table 9.2.3.3.2.3.3-9: Message TRACKING AREA UPDATE ACCEPT (step 20, table 9.2.3.3.2.3.2-1)

Derivation path: 36.508 table 4.7.2-24			
Information Element	Value/Remark	Comment	Condition
EPS update result	100	TA updated and ISR activated	TA_only
T3412 value	00100001	1 minute	
GUTI	Not present		
MS identity	Not present		
T3423 value	00100001	1 minute	

Table 9.2.3.3.2.3.3-10: Message TRACKING AREA UPDATE REQUEST (step 23, table 9.2.3.3.2.3.2-1)

Derivation path: 36.508 table 4.7.2-27			
Information Element	Value/Remark	Comment	Condition
EPS update type	Any allowed value		
Old GUTI			
M-TMSI	ef01ee97	Mapped from P-TMSI assigned in the preamble and RAI of cell 5 (start with 11 and RAI in 2 nd most significant byte).	
Nonce _{UE}	Any allowed value		
Last visited registered TAI	RAI of cell 5		
Additional GUTI	Same GUTI as in step 15 see table 9.2.3.3.2.3.3-7		

Table 9.2.3.3.2.3.3-11: Message TRACKING AREA UPDATE ACCEPT (step 24, table 9.2.3.3.2.3.2-1)

Derivation path: 36.508 table 4.7.2-24			
Information Element	Value/Remark	Comment	Condition
EPS update result	000	TA updated	TA_only
T3412 value	01010101	54 minutes	
GUTI	Not present		
MS identity	Not present		

Table 9.2.3.3.2.3.3-12: Message TRACKING AREA UPDATE REQUEST (steps 5Aa1 and 9Aa1, table 9.2.3.3.2.3.2-1)

Derivation path: 36.508 table 4.7.2-27			
Information Element	Value/Remark	Comment	Condition
EPS Update Type	010	combined RA/LA updating with IMSI attach	Combined TA/LA
GPRS ciphering key sequence number	Any allowed value		
Additional GUTI	Not present or any allowed value		
Nonce _{UE}	Any allowed value		

Table 9.2.3.3.2.3.3-13: Message TRACKING AREA UPDATE ACCEPT (steps 5Aa2 and 9Aa2, table 9.2.3.3.2.3.2-1)

Derivation path: 36.508 table 4.7.2-24			
Information Element	Value/Remark	Comment	Condition
EPS update result	101	combined TA/LA updated and ISR activated	

9.2.3.3.3 Iu mode to S1 mode intersystem change / Periodic TAU and RAU/ ISR activated, T3423 expired

9.2.3.3.3.1 Test Purpose (TP)

(1)

```
with { the UE is camped on a E-UTRAN cell, ISR is active, T3312 has expired }
ensure that {
  when { UE enters a UTRAN cell belonging to the RA where the UE was last updated }
  then { the UE performs a RAU procedure }
}
```

(2)

```
with { the UE is camped on a UTRAN cell, ISR is active, T3412 and T3423 have expired }
ensure that {
  when { the UE enters a E-UTRAN cell in a TA belonging to the current TA list }
  then { the UE performs a TAU procedure including mapped GUTI from UTRAN, P-TMSI signature and additional GUTI }
}
```

9.2.3.3.3.2 Conformance requirements

References: The conformance requirements covered in the present TC are specified in: TS 24.301 clauses 5.3.5 and 5.5.3.2.2 and TS 24.008 clauses 4.7.2.2 and 4.7.5.1.1.

[24.301, clause 5.3.5]

If ISR is activated, the UE shall keep both the periodic tracking area update timer (timer T3412) and the periodic routing area update timer (timer T3312). The two separate timers run in the UE for updating MME and SGSN independently. If the periodic tracking area update timer expires and the UE cannot initiate the tracking area updating procedure, as it is in state EMM-REGISTERED.NO-CELL-AVAILABLE, the UE shall start the E-UTRAN deactivate ISR timer T3423. The UE shall initiate the tracking area updating procedure and stop the timer T3423 when it enters

state EMM-REGISTERED.NORMAL-SERVICE before timer T3423 expires. After expiry of timer T3423 the UE shall set its TIN to "P-TMSI" in order to initiate the tracking area updating procedure when it returns to state EMM-REGISTERED.NORMAL-SERVICE.

If the UE is attached to both EPS and non-EPS services, and if timer T3412 expires or timer T3423 expires when the UE is in EMM-REGISTERED.NO-CELL-AVAILABLE state, then the UE shall initiate the combined tracking area updating procedure indicating "combined TA/LA updating with IMSI attach" when the UE returns to EMM-REGISTERED.NORMAL-SERVICE state.

[24.301, clause 5.5.3.2.2]

...

If the UE supports neither A/Gb mode nor Iu mode, the UE shall include a valid GUTI in the Old GUTI IE in the TRACKING AREA UPDATE REQUEST message.

If the UE supports A/Gb mode or Iu mode, the UE shall handle the Old GUTI IE as follows:

- If the TIN indicates "P-TMSI" and the UE holds a valid P-TMSI and RAI, the UE shall map the P-TMSI and RAI into the Old GUTI IE. If a P-TMSI signature is associated with the P-TMSI, the UE shall include it in the Old P-TMSI signature IE. Additionally, if the UE holds a valid GUTI, the UE shall indicate the GUTI in the Additional GUTI IE.

NOTE: The mapping of the P-TMSI and RAI to the GUTI is specified in 3GPP TS 23.003 [2].

- If the TIN indicates "GUTI" or "RAT-related TMSI" and the UE holds a valid GUTI, the UE shall indicate the GUTI in the Old GUTI IE.

[24.008, clause 4.7.2.2]

If ISR is activated, the MS shall keep both the periodic tracking area update timer (timer T3412) and the periodic routing area update timer (timer T3312). The two separate timers run in the MS for updating MME and SGSN independently. If the periodic routing area update timer expires and the MS is in state GMM-REGISTERED.NO-CELL-AVAILABLE, the MS shall set its TIN to "RAT-related TMSI" and start the GERAN/UTRAN Deactivate ISR timer T3323. The MS shall initiate the routing area updating procedure and stop the timer T3323 when the MS enters the state GMM-REGISTERED.NORMAL-SERVICE before timer T3323 expires. After expiry of timer T3323 the MS shall deactivate ISR by setting its TIN to "GUTI" and initiate the routing area updating procedure when the MS enters the state GMM-REGISTERED.NORMAL-SERVICE.

...

If the MS is both IMSI attached for GPRS and non-GPRS services, and if the MS lost coverage of the registered PLMN and timer T3312 expires or timer T3323 expires, then:

- a) if the MS returns to coverage in a cell that supports GPRS and that indicates that the network is in network operation mode I, then the MS shall either perform the combined routing area update procedure indicating "combined RA/LA updating with IMSI attach"; or
- b) if the MS returns to coverage in a cell in the same RA that supports GPRS and that indicates that the network is in network operation mode II or III, then the MS shall perform the periodic routing area updating procedure indicating "Periodic updating"; or
- c) if the MS was both IMSI attached for GPRS and non-GPRS services in network operation mode I and the MS returns to coverage in a cell in the same LA that does not support GPRS, then the MS shall perform the periodic location updating procedure. In addition, the MS shall perform a combined routing area update procedure indicating "combined RA/LA updating with IMSI attach" when the MS enters a cell that supports GPRS and that indicates that the network is in network operation mode I; or
- d) if the MS returns to coverage in a new RA the description given in subclause 4.7.5 applies.

If the MS is both IMSI attached for GPRS and non-GPRS services in a network that operates in network operation mode I, and if the MS has camped on a cell that does not support GPRS, and timer T3312 expires or timer T3323 expires, then the MS shall start an MM location updating procedure. In addition, the MS shall perform a combined routing area update procedure indicating "combined RA/LA updating with IMSI attach" when the MS enters a cell that supports GPRS and indicates that the network is in operation mode I.

If timer T3312 expires or timer T3323 expires during an ongoing CS connection, then a MS operating in MS operation mode B shall treat the expiry of T3312 when the MM state MM-IDLE is entered, analogous to the descriptions for the cases when the timer expires out of coverage or in a cell that does not support GPRS.

In A/Gb mode, timer T3312 and timer T3323 shall not be stopped when a GPRS MS enters state GMM-REGISTERED.SUSPENDED.

[24.008, clause 4.7.5.1.1]

...

If the MS supports S1 mode, the MS shall handle the P-TMSI IE as follows:

- If the TIN indicates "GUTI" and the MS holds a valid GUTI, the MS shall map the GUTI into a P-TMSI, P-TMSI signature and RAI as specified in 3GPP TS 23.003 [4]. The MS shall include the mapped RAI in the Old routing area identification IE and the mapped P-TMSI signature in the P-TMSI signature IE. When the routing area updating procedure is initiated in Iu mode, the MS shall also include the mapped P-TMSI in the P-TMSI IE. Additionally, in Iu mode and A/Gb mode, if the MS holds a valid P-TMSI and RAI, the MS shall indicate the P-TMSI in the Additional mobile identity IE and the RAI in the Additional old routing area identification IE.
- If the TIN indicates "P-TMSI" or "RAT-related TMSI" and the MS holds a valid P-TMSI and RAI, the MS shall indicate the RAI in the Old routing area identification IE. When the routing area updating procedure is initiated in Iu mode, the MS shall also include the P-TMSI in the P-TMSI IE.

9.2.3.3.3.3 Test description

9.2.3.3.3.3.1 Pre-test conditions

System Simulator:

- cell A and cell 5 (HPLMN);
- cell 5 indicates NMO I.
- System information combination 4 as defined in TS 36.508[18] clause 4.4.3.1 is used in E-UTRA cells.

UE:

none.

Preamble:

- the UE is in state Registered, Idle Mode (state 2) on cell A according to TS 36.508 [18] and with M-TMSI = 9a26319c (arbitrary value chosen for this test case).

9.2.3.3.3.2 Test procedure sequence

Table 9.2.3.3.3.2-1: Main Behaviour

St	Procedure	Message Sequence		TP	Verdict
		U - S	Message		
1	The SS sets the cell type of Cell 5 to "Serving Cell" and the cell type of Cell A to "Non-suitable cell".	-	-	-	-
2	The UE transmits a ROUTING AREA UPDATE message on cell 5.	-->	ROUTING AREA UPDATE REQUEST	-	-
3	The SS transmits a ROUTING AREA UPDATE ACCEPT message on Cell 5 with T3312 set to 1 minute and T3323 set to 2 minutes.	<--	ROUTING AREA UPDATE ACCEPT	-	-
4	The UE transmits a ROUTING AREA UPDATE COMPLETE message on Cell 5.	-->	ROUTING AREA UPDATE COMPLETE	-	-
5	The SS sets the cell type of Cell A to "Serving cell" and the cell type of Cell 5 to "Non-suitable cell".	-	-	-	-
-	EXCEPTION: Steps 5Aa1 to 5Aa4 describe behaviour that depends on the UE capability; the "lower case letter" identifies a step sequence that take place according to UE mode of operation.	-	-	-	-
5A a1	IF CS/PS mode 1 or CS/PS mode 2 of operation is configured on the UE and px_AttachTypeTested is set to COMBINED_ATTACH THEN the UE transmits a TRACKING AREA UPDATE REQUEST message on Cell A.	-->	TRACKING AREA UPDATE REQUEST	-	-
5A a2	The SS transmits a TRACKING AREA UPDATE ACCEPT message on Cell A.	<--	TRACKING AREA UPDATE ACCEPT	-	-
5A a3	The UE transmits a TRACKING AREA UPDATE COMPLETE message on Cell A.	-->	TRACKING AREA UPDATE COMPLETE	-	-
5A a4	The SS releases the RRC connection.	-	-	-	-
6	90s after step 3, the SS sets the cell type of Cell 5 to "Serving Cell" and the cell type of Cell A to "Non-suitable cell".	-	-	-	-
7	Check: After T3312 started after Step 4 expires and before T3323 expires, does the UE transmit a ROUTING AREA UPDATE REQUEST message on Cell 5?	-->	ROUTING AREA UPDATE REQUEST	1	P
8	The SS transmits a ROUTING AREA UPDATE ACCEPT message on Cell 5	<--	ROUTING AREA UPDATE ACCEPT	-	-
9	The SS sets the cell type of Cell A to "Serving cell" and the cell type of Cell 5 to "Non-suitable cell".	-	-	-	-
10	The UE transmits a TRACKING AREA UPDATE REQUEST message	-->	TRACKING AREA UPDATE REQUEST	-	-
11	The SS transmits a TRACKING AREA UPDATE ACCEPT message with EPS update result indicating that ISR is active, T3412 set to 1 minute and T3423 set to 1 minute.	<--	TRACKING AREA UPDATE ACCEPT	-	-
11 A	The SS releases the RRC connection.	-	-	-	-
12	The SS sets the cell type of Cell 5 to "Serving Cell" and the cell type of Cell A to "Non-suitable cell".	-	-	-	-
-	EXCEPTION: Steps 12Aa1 to 12Aa2 describe behaviour that depends on the UE capability; the "lower case letter" identifies a step sequence that take place according to UE mode of operation.	-	-	-	-
12 Aa 1	IF CS/PS mode 1 or CS/PS mode 2 of operation is configured on the UE and px_AttachTypeTested is set to	-->	ROUTING AREA UPDATE REQUEST	-	-

	COMBINED_ATTACH THEN Check: After T3412 started after Step 11A expires and before T3423 expires, does the UE transmit a ROUTING AREA UPDATE REQUEST message on Cell 5?				
12 Aa 2	The SS transmits a ROUTING AREA UPDATE ACCEPT message on Cell 5	<--	ROUTING AREA UPDATE ACCEPT	-	-
13	150s after step 12, the SS sets the cell type of Cell A to "Serving cell" and the cell type of Cell 5 to "Non-suitable cell".	-	-	-	-
14	Check: After T3412 started after Step 11 A and T3423 started at Step 13 expire, does the UE transmit a TRACKING AREA UPDATE REQUEST message on Cell A?	-->	TRACKING AREA UPDATE REQUEST	2	P
15	The SS transmits a TRACKING AREA UPDATE ACCEPT message.	<--	TRACKING AREA UPDATE ACCEPT	-	-
-	The UE is in end state E-UTRA connected (E2_T3440).	-	-	-	-

9.2.3.3.3.3 Specific message contents

Table 9.2.3.3.3.3-1: Void

Table 9.2.3.3.3.3-2: Message ROUTING AREA UPDATE ACCEPT (step 3, table 9.2.3.3.3.2-1)

Derivation path: 24.008 table 9.4.15			
Information Element	Value/Remark	Comment	Condition
Update result	100	RA updated and ISR activated	TA only
	001	combined RA/LA updated	combined_TA_LA
Periodic RA update timer	00100001	1 minute	
Routing area identification	See 36.508 table 4.4.4-2	RAI of Cell 5	
P-TMSI signature	Not present		
Allocated P-TMSI RAI TMSI	See 36.508 table 4.4.4-2 efb1ee97	TMSI is an arbitrary value chosen different from M-TMSI in the preamble	
T3323 value	00100010	2 minutes	

Table 9.2.3.3.3.3-3: Message ROUTING AREA UPDATE REQUEST (step 7 table 9.2.3.3.3.2-1)

Derivation path: 24.008 table 9.4.14			
Information Element	Value/Remark	Comment	Condition
Update type	011	Periodic updating	TA_only
	010	combined RA/LA updating with IMSI attach	combined_TA_LA
GPRS ciphering key sequence number	Any allowed value		
Old routing area identification	RAI of Cell 5 according to 36.508 table 4.4.4-2	The UE includes the RAI from UTRAN	
MS Radio Access capability	Any allowed value		
Old P-TMSI signature	Not present		
P-TMSI	Same value like allocated at step 3, see table 9.2.3.3.3.3-1	The UE includes the P-TMSI assigned from UTRAN	
UE network capability	Not Present		TA_only
Additional mobile identity	Not present		
Additional old routing area identification	Not present		

Table 9.2.3.3.3.3-4: Message ROUTING AREA UPDATE ACCEPT (step 8, table 9.2.3.3.3.2-1)

Derivation path: 24.008 table 9.4.15			
Information Element	Value/Remark	Comment	Condition
Update result	000	RA updated	TA_only
	001	combined RA/LA updated	combined_TA_LA
Periodic RA update timer	01010101	126 minutes	
Routing area identification	See 36.508 table 4.4.4-2	RAI of Cell 5	
P-TMSI signature	Not present		
Allocated P-TMSI	Not present		

Table 9.2.3.3.3.3-5: Message TRACKING AREA UPDATE REQUEST (step 10, table 9.2.3.3.3.2-1)

Derivation path: 36.508 table 4.7.2-27			
Information Element	Value/Remark	Comment	Condition
EPS update type	Any allowed value		
Additional GUTI	Any allowed value		
Nonce _{UE}	Any allowed value		

Table 9.2.3.3.3.3-6: Message TRACKING AREA UPDATE ACCEPT (step 11, table 9.2.3.3.3.2-1)

Derivation path: 36.508 table 4.7.2-24			
Information Element	Value/Remark	Comment	Condition
EPS update result	100	TA updated and ISR activated	TA_only
	101	combined TA/LA updated and ISR activated	combined_TA_LA
T3412 value	00100001	1 minute	
GUTI	Not present		
MS identity	Not present		
T3423 value	00100001	1 minute	

Table 9.2.3.3.3.3-7: Message TRACKING AREA UPDATE REQUEST (step 14, table 9.2.3.3.3.2-1)

Derivation path: 36.508 table 4.7.2-27			
Information Element	Value/Remark	Comment	Condition
EPS update type	Any allowed value		
Old GUTI			
M-TMSI	EFB1EE97	Mapped from P-TMSI assigned in the preamble and RAI of cell 5 (start with 11 and RAI in 2 nd most significant byte).	
Last visited registered TAI	RAI of cell 5		
Additional GUTI	Same GUTI as assigned in the preamble		
Nonce _{UE}	Any allowed value		

Table 9.2.3.3.3.3-8: Message TRACKING AREA UPDATE ACCEPT (step 15, table 9.2.3.3.3.2-1)

Derivation path: 36.508 table 4.7.2-24			
Information Element	Value/Remark	Comment	Condition
EPS update result	000	TA updated	TA_only
	001	combined TA/LA updated	combined_TA_LA
T3412 value	01010101	126 minutes	
GUTI	Not present		
MS identity	Not present		

Table 9.2.3.3.3.3-9: Message TRACKING AREA UPDATE REQUEST (step 5Aa1, table 9.2.3.3.3.2-1)

Derivation path: 36.508 table 4.7.2-27			
Information Element	Value/Remark	Comment	Condition
EPS update type	010	combined TA/LA updating with IMSI attach	
GPRS ciphering key sequence number	Any allowed value		
Additional GUTI	Not present or any allowed value		
Nonce _{UE}	Any allowed value		

Table 9.2.3.3.3.3-10: Message TRACKING AREA UPDATE ACCEPT (step 5Aa2, table 9.2.3.3.3.2-1)

Derivation path: 36.508 table 4.7.2-24			
Information Element	Value/Remark	Comment	Condition
EPS update result	101	combined TA/LA updated and ISR activated	

Table 9.2.3.3.3.3-11: Message ROUTING AREA UPDATE ACCEPT (step 12Aa2, table 9.2.3.3.3.2-1)

Derivation path: 24.008 table 9.4.15			
Information Element	Value/Remark	Comment	Condition
Update result	001	combined RA/LA updated	
Periodic RA update timer	01010101	126 minutes	
Routing area identification	See 36.508 table 4.4.4-2	RAI of Cell 5	
P-TMSI signature	Not present		
Allocated P-TMSI	Not present		

9.2.3.3.4 First S1 mode to lu mode inter-system change after attach

9.2.3.3.4.1 Test Purpose (TP)

(1)

```
with { the UE powered on in E-UTRAN with a USIM containing valid E-UTRAN NAS and Security parameters including a valid GUTI, and has successfully performed a combined EPS/IMSI attach, established PDN connectivity, and performed TRACKING AREA UPDATE REQUEST }
ensure that {
  when { the UE reselects UTRAN configured in MNO=II and TIN is set to the temporary ID belonging to the currently used RAT (i.e. ISR not active) }
  then { the UE transmits a LOCATION UPDATING REQUEST to the MSC/VLR and derives the IDNNS from the MSC/VLR TMSI, and transmits a ROUTING AREA UPDATE REQUEST message including P-TMSI, P-TMSI signature including the NAS token, and RAI mapped from GUTI, the old routing area identification mapped from the RAI, the GPRS ciphering key sequence number indicating the eKSI associated with the EPS security context. Old P-TMSI signature and Old routing area identification are mapped from the GUTI. The message is encapsulated in an INITIAL DIRECT TRANSFER message including IDNSS mapped from GUTI, START value set to 0 and PLMN identity }
```

(2)

```
with { the UE camped on E-UTRAN and has a valid GUTI and P-TMSI }
ensure that {
  when { the UE reselects UTRAN and receives a new P-TMSI as part of the RAU procedure }
  then { the UE uses the new P-TMSI (and not GUTI or old P-TMSI) for subsequent IDNNS network access (e.g. via the Service Request procedure) }
```

(3)

```
with { the UE has performed a RAU procedure in UTRAN after initial registration at power on in E-UTRAN }
ensure that {
  when { the UE reselects a E-UTRAN cell with the same LA as previously selected}
```

```

    then { the UE transmits a TRACKING AREA UPDATE REQUEST message including eKSI stored in the
    USIM, old GUTI mapped from RAI and P-TMSI, GPRS ciphering sequence number, nonceUE. The UE encodes
    the RRC parameters in the RRC Connection Establishment messages correctly (i.e. in the
    RRCConnectionRequest message, the ue-Identity is set to s-TMSI or "Random value" for pre-Rel-12 UE,
    or set to randomValue from Rel-12 and onwards UE. The establishmentCause is set to MO-signalling;
    and, in the RRCConnectionSetupComplete message the selectedPLMN-identity, mmegi and mmec indicate
    the value of the registered MME when ue-Identity is set to randomValue (e.g. as retrieved from the
    USIM at power-on, or, as received in the last TRACKING AREA UPDATE ACCEPT message) }
  }

```

(4)

```

with { the UE has transmitted a ROUTING AREA UPDATE REQUEST message after initial registration at
power on in E-UTRAN }
ensure that {
  when { the UE receives a SECURITY MODE COMMAND message }
  then { the UE transmits a SECURITY MODE COMPLETE and starts performing ciphering an integrity
protection using CK' and IK' derived from KASME and UL NAS COUNT }

```

(5)

```

with { the UE has received an AUTHENTICATION AND CIPHERING REQUSET message after it has performed
ciphering an integrity protection using CK' and IK' derived from KASME and UL NAS COUNT }
ensure that {
  when { the UE receives a SECURITY MODE COMMAND message }
  then { the UE transmits a SECURITY MODE COMPLETE and starts performing ciphering an integrity
protection using new CK and IK }

```

NOTE: ISR considered not in the scope of this test case, so it is never activated.

9.2.3.3.4.2 Conformance requirements

References: The conformance requirements covered in the current TC are specified in: TS 23.003 clause 2.8.2.1, 2.8.2.2, TS 23.401 Annex J.2; TS 24.301 clause 5.5.3.2.2 and Annex D; TS 25.331 clauses 8.1.8.2, 8.1.8.3 (on IDNNS) and 8.3.8.2; TS 24.008 clause 4.7.5.1.1 and 4.7.5.1.3; TS 23.236 clause 5.1; and TS 36.331 clauses 5.3.3.3 and 5.3.3.4.

[TS 23.003, clause 2.8.2.1]

The mapping of the GUTI shall be done to the combination of RAI of GERAN / UTRAN and the P-TMSI:

E-UTRAN <MCC> maps to GERAN/UTRAN <MCC>

E-UTRAN <MNC> maps to GERAN/UTRAN <MNC>

E-UTRAN <MME Group ID> maps to GERAN/UTRAN <LAC>

E-UTRAN <MME Code> maps to GERAN/UTRAN <RAC> and is also copied into the 8 most significant bits of the NRI field within the P-TMSI;

E-UTRAN <M-TMSI> maps as follows:

- 6 bits of the E-UTRAN <M-TMSI> starting at bit 29 and down to bit 24 are mapped into bit 29 and down to bit 24 of the GERAN/UTRAN <P-TMSI>;
- 16 bits of the E-UTRAN <M-TMSI> starting at bit 15 and down to bit 0 are mapped into bit 15 and down to bit 0 of the GERAN/UTRAN <P-TMSI>;
- and the remaining 8 bits of the E-UTRAN <M-TMSI> are mapped into the 8 MBS bits of the <P-TMSI signature> field.

For UTRAN, the 10-bit long NRI bits are masked out from the P-TMSI and also supplied to the RAN node as IDNNS (Intra Domain NAS Node Selector). However, the RAN configured NRI length should not exceed 8 bits.

[TS 23.003, clause 2.8.2.2]

The mapping of P-TMSI (TLLI) and RAI in GERAN/UTRAN to GUTI in E-UTRAN shall be performed as follows:

GERAN/UTRAN <MCC> maps to E-UTRAN <MCC>

GERAN/UTRAN <MNC> maps to E-UTRAN <MNC>

GERAN/UTRAN <LAC> maps to E-UTRAN <MME Group ID>

GERAN/UTRAN <RAC> maps into bit 23 and down to bit 16 of the M-TMSI

The 8 most significant bits of GERAN/UTRAN <NRI> map to the MME code.

GERAN/UTRAN <P-TMSI> maps as follows:

- 6 bits of the GERAN/UTRAN <P-TMSI> starting at bit 29 and down to bit 24 are mapped into bit 29 and down to bit 24 of the E-UTRAN <M-TMSI>;
- 16 bits of the GERAN/UTRAN <P-TMSI> starting at bit 15 and down to bit 0 are mapped into bit 15 and down to bit 0 of the E-UTRAN <M-TMSI>.

The values of <LAC> and <MME group id> shall be disjoint, so that they can be differentiated. The most significant bit of the <LAC> shall be set to zero; and the most significant bit of <MME group id> shall be set to one. Based on this definition, the most significant bit of the <MME group id> can be used to distinguish the node type, i.e. whether it is an MME or SGSN.

[TS 23.401, Annex J.2 "Usage of TIN"]

...

When ISR is not active the TIN is always set to the temporary ID belonging to the currently used RAT. This guarantees that always the most recent context data are used, which means during inter-RAT changes there is always context transfer from the CN node serving the last used RAT. The UE identities, old GUTI IE and additional GUTI IE, indicated in the next TAU Request message, and old P-TMSI IE and additional P-TMSI/RAI IE, indicated in the next RAU Request message depend on the setting of TIN and are specified in table 4.3.5.6-2.

[TS 24.301, clause 5.5.3.2.2 "Normal and periodic tracking area updating procedure initiation"]

...

If the UE supports A/Gb mode or Iu mode, the UE shall handle the GUTI as follows:

- if the TIN indicates "P-TMSI" and the UE holds a valid P-TMSI and RAI, the UE shall map the P-TMSI and RAI into the old GUTI IE. If a P-TMSI signature is associated with the P-TMSI, the UE shall include it in the Old P-TMSI signature IE. Additionally, if the UE holds a valid GUTI, the UE shall indicate the GUTI in the Additional GUTI IE.
- if the TIN indicates "GUTI" or "RAT-related TMSI" and the UE holds a valid GUTI, the UE shall indicate the GUTI in the Old GUTI IE.

...

If the UE has a current EPS security context, the UE shall include the eKSI (either KSI_{ASME} or KSI_{SGSN}) in the NAS Key Set Identifier IE in the TRACKING AREA UPDATE REQUEST message. Otherwise, the UE shall set the NAS Key Set Identifier IE to the value "no key is available". If the UE has a current EPS security context, the UE shall integrity protect the TRACKING AREA UPDATE REQUEST message with the current EPS security context. Otherwise the UE shall not integrity protect the TRACKING AREA UPDATE REQUEST message.

...

When the tracking area updating procedure is initiated in EMM-IDLE mode to perform an inter-system change from A/Gb mode or Iu mode to S1 mode and the TIN is set to "P-TMSI", the UE shall include the GPRS ciphering key sequence number applicable for A/Gb mode or Iu mode and a $nonce_{UE}$ in the TRACKING AREA UPDATE REQUEST message.

...

If the UE initiates the first tracking area updating procedure following an attach in A/Gb mode or Iu mode, the UE shall include a UE radio capability information update needed IE in the TRACKING AREA UPDATE REQUEST message.

...[TS 24.301, Annex D]

...

Table D.1.1: Mapping of NAS procedure to establishment cause and call type

NAS procedure	RRC establishment cause (according 3GPP TS 36.331 [22])	Call type
...		
Tracking Area Update	MO signalling (See Note 1)	"originating signalling"
...		
Note 1: For these NAS procedures initiated by UEs of access class 12, 13 or 14 in their home country, the RRC establishment cause will be set to "High priority access AC 11 – 15". For this purpose the home country is defined as the country of the MCC part of the IMSI, see 3GPP TS 22.011 [1A]. For these NAS procedures initiated by UE of access class 11 or 15 in their HPLMN or EHPLMN, the RRC establishment cause will be set to "High priority access AC 11 – 15".		

[TS 36.331, clause 5.3.3.3]

The UE shall set the contents of *RRCCONNECTIONREQUEST* message as follows:

- 1> set the *ue-Identity* as follows:
 - 2> if upper layers provide an S-TMSI:
 - 3> set the *ue-Identity* to the value received from upper layers;
 - 2> else
 - 3> draw a random value in the range $0 \dots 2^{40}-1$ and set the *ue-Identity* to this value;

NOTE 1: Upper layers provide the S-TMSI if the UE is registered in the TA of the current cell.

- 1> Set the *establishmentCause* in accordance with the information received from upper layers;

[TS 36.331, clause 5.3.3.4]

...

- 1> set the content of *RRCCONNECTIONSETUPCOMPLETE* message as follows:
 - 2> set the *selectedPLMN-Identity* to the PLMN selected by upper layers (see TS 23.122 [11], TS 24.301 [35]) from the PLMN(s) included in the *plmn-IdentityList* in *SystemInformationBlockType1*;
 - 2> if upper layers provide the 'Registered MME', set the *registeredMME* as follows:
 - 3> if the PLMN identity of the 'Registered MME' is different from the PLMN selected by the upper layers:
 - 4> include the *plmnIdentity* in the *registeredMME* and set it to the value of the PLMN identity in the 'Registered MME' received from upper layers;
 - 3> set the *mmegi* and the *mmec* to the value received from upper layers;
 - 2> set the *dedicatedInfoNAS* to include the information received from upper layers;

...

[TS 24.008, clause 4.7.5.1.1]

To initiate the normal routing area updating procedure, the MS sends the message ROUTING AREA UPDATE REQUEST to the network, starts timer T3330 and changes to state GMM-ROUTING-AREA-UPDATING-INITIATED.

If the MS supports S1 mode, the MS shall handle the P-TMSI IE as follows:

- If the TIN indicates "GUTI" and the MS holds a valid GUTI, the MS shall map the GUTI into a P-TMSI, P-TMSI signature and RAI as specified in 3GPP TS 23.003 [4]. The MS shall include the mapped RAI in the Old routing area identification IE and the mapped P-TMSI signature in the P-TMSI signature IE. When the routing area updating procedure is initiated in Iu mode, the MS shall also include the mapped P-TMSI in the P-TMSI IE. Additionally, in Iu mode and A/Gb mode, if the MS holds a valid P-TMSI and RAI, the MS shall

indicate the P-TMSI in the Additional mobile identity IE and the RAI in the Additional old routing area identification IE.

...

If the routing area updating procedure is initiated by the MS due to an S1 mode to Iu mode or S1 mode to A/Gb mode inter-system change in idle mode and the TIN indicates "GUTI", the message ROUTING AREA UPDATE REQUEST shall include a P-TMSI signature filled with a NAS token as specified in 3GPP TS 33.401 [119]. In the GPRS ciphering key sequence number IE the MS shall indicate the value of the eKSI associated with the current EPS security context.

NOTE: When the MS includes a P-TMSI signature filled with a NAS token, 8 bits of the NAS token will be filled with bits from the M-TMSI (see 3GPP TS 23.003 [4]).

If the routing area updating procedure is initiated by the MS due to the S1 mode to Iu mode or S1 mode to A/Gb mode inter-system change in connected mode, the MS shall derive CK' and IK' from K_{ASME} and from the NAS downlink COUNT value indicated by lower layers as specified in 3GPP TS 33.401 [119]. If the routing area updating procedure is initiated by the MS due to the S1 mode to Iu mode or S1 mode to A/Gb mode inter-system change in idle mode when the TIN indicates "GUTI", the MS shall derive CK' and IK' from the K_{ASME} and the NAS downlink COUNT value corresponding to the NAS token derived as specified in 3GPP TS 33.401 [119]. The MS shall indicate the eKSI value in the CKSN field of the GPRS ciphering key sequence number IE in the ROUTING AREA UPDATE REQUEST message. Then, the MS shall reset the START value and store the mapped UMTS security context replacing the established UMTS security context.

[TS 24.008, clause 4.7.5.1.3]

...

A ROUTING AREA UPDATE COMPLETE message shall be returned to the network if the ROUTING AREA UPDATE ACCEPT message contained any of:

- a P-TMSI;
- Receive N-PDU Numbers (see 3GPP TS 44.065 [78] and 3GPP TS 25.322 [19b]); or
- a request for the provision of Inter RAT handover information or E-UTRAN inter RAT handover information or both.

If Receive N-PDU Numbers were included, the Receive N-PDU Numbers values valid in the MS, shall be included in the ROUTING AREA UPDATE COMPLETE message.

If the network has requested the provision of Inter RAT handover information or E-UTRAN inter RAT handover information or both, the MS shall return a ROUTING AREA UPDATE COMPLETE message including the Inter RAT handover information IE or E-UTRAN inter RAT handover information IE or both to the network.

NOTE 1: In Iu mode, after a routing area updating procedure, the mobile station can initiate Service Request procedure to request the resource reservation for the active PDP contexts if the resources have been released by the network or send upper layer message (e.g. ACTIVATE PDP CONTEXT REQUEST) to the network via the existing PS signalling connection.

In Iu mode, if the network wishes to prolong the PS signalling connection (for example, if the mobile station has indicated "follow-on request pending" in ROUTING AREA UPDATE REQUEST message) the network shall indicate the "follow-on proceed" in the ROUTING AREA UPDATE ACCEPT message. If the network wishes to release the PS signalling connection, the network shall indicate "no follow-on proceed" in the ROUTING AREA UPDATE ACCEPT message.

After that in Iu mode, the mobile station shall act according to the follow-on proceed flag included in the Update result information element in the ROUTING AREA UPDATE ACCEPT message (see subclause 4.7.13).

[TS 23.236, clause 5.1 "MS Functions"]

...

In Iu mode the MS provides the IDNNS to the RNC in the access stratum part of the *RRC_initial_DT* message as described in TS 25.331 [5].

If the MS is E-UTRAN capable, then TS 23.401 [22], TS 23.060 [2] and TS 23.003 [18] define rules as to how the MS shall select and encode the identity to place in the P-TMSI/TLI parameters used in the Routing Area Update procedure. For the PS domain, the E-UTRAN capable MS shall use this P-TMSI parameter to derive the UTRAN IDNNS parameter. For the CS domain, the E-UTRAN temporary identities shall not be used to derive the IDNNS: instead the MS shall use its (MSC supplied) TMSI, if that TMSI is valid, to derive the IDNNS.

...

When the MS in Iu mode replies to IMSI paging, it shall derive IDNNS from (P)TMSI if a valid one is available. If (P)TMSI is not available, the MS shall derive IDNNS from IMSI.

[TS 25.331, clause 8.1.8.2]

In the UE, the initial direct transfer procedure shall be initiated, when the upper layers request establishment of a signalling connection. This request also includes a request for the transfer of a NAS message.

Upon initiation of the initial direct transfer procedure the UE shall:

- 1> set the variable ESTABLISHMENT_CAUSE to the cause for establishment indicated by upper layers.

Upon initiation of the initial direct transfer procedure when the UE is in idle mode, the UE shall:

- 1> perform an RRC connection establishment procedure, according to subclause 8.1.3;

NOTE: If an RRC connection establishment is ongoing, this procedure continues unchanged, i.e. it is not interrupted.

- 1> if the RRC connection establishment procedure was not successful:
 - 2> if the establishment cause for the failed RRC connection establishment was set to "MBMS reception" and a different cause value is stored in the variable "ESTABLISHMENT_CAUSE":
 - 3> UE-AS (RRC) initiates a new RRC connection establishment procedure, using the establishment cause as contained in the variable ESTABLISHMENT_CAUSE.
 - 2> otherwise:
 - 3> indicate failure to establish the signalling connection to upper layers and end the procedure.
- 1> when the RRC connection establishment procedure is completed successfully:
 - 2> continue with the initial direct transfer procedure as below.

...

The UE shall, in the INITIAL DIRECT TRANSFER message:

- 1> set the IE "NAS message" as received from upper layers; and
- 1> set the IE "CN domain identity" as indicated by the upper layers; and
- 1> set the IE "Intra Domain NAS Node Selector" as follows:
 - 2> derive the IE "Intra Domain NAS Node Selector" from TMSI/PMTSI, IMSI, or IMEI; and
 - 2> provide the coding of the IE "Intra Domain NAS Node Selector" according to the following priorities:
 1. derive the routing parameter for IDNNS from TMSI (CS domain) or PTMSI (PS domain) whenever a valid TMSI/PTMSI is available;
 2. base the routing parameter for IDNNS on IMSI when no valid TMSI/PTMSI is available;
 3. base the routing parameter for IDNNS on IMEI only if no (U)SIM is inserted in the UE.
- 1> if the UE, on the existing RRC connection, has received a dedicated RRC message containing the IE "Primary PLMN Identity" in the IE "CN Information Info":

- 2> set the IE "PLMN identity" in the INITIAL DIRECT TRANSFER message to the latest PLMN information received via dedicated RRC signalling. If NAS has indicated the PLMN towards which a signalling connection is requested, and this PLMN is not in agreement with the latest PLMN information received via dedicated RRC signalling, then the initial direct transfer procedure shall be aborted, and NAS shall be informed.
- 1> if the UE, on the existing RRC connection, has not received a dedicated RRC message containing the IE "CN Information Info" , and if the IE "Multiple PLMN List" was broadcast in the cell where the current RRC connection was established:
 - 2> set the IE "PLMN identity" in the INITIAL DIRECT TRANSFER message to the PLMN chosen by higher layers [5, 25] amongst the PLMNs in the IE "Multiple PLMN List" broadcast in the cell where the RRC connection was established.

[TS 25.331, clause 8.1.8.3]

On reception of the INITIAL DIRECT TRANSFER message the NAS message should be routed using the IE "CN Domain Identity". UTRAN may also use the IE "Intra Domain NAS Node Selector" and the IE "PLMN identity" for routing among the CN nodes for the addressed CN domain.

If no signalling connection exists towards the chosen node, then a signalling connection is established.

When the UTRAN receives an INITIAL DIRECT TRANSFER message, it shall not affect the state of any other ongoing RRC procedures, when not stated otherwise elsewhere.

The UTRAN should:

- 1> set the START value for the CN domain indicated in the IE "CN domain identity" to the value of the IE "START".

[TS 25.331, clause 8.3.8.2]

When the UE makes an inter-RAT cell reselection to UTRAN according to the criteria specified in [4], it shall initiate this procedure. The inter-RAT cell reselection made by the UE may use system information broadcast from the source radio access technology or UE dedicated information.

If the NAS procedures associated with inter-system change specified in [5] require the establishment of an RRC connection, the UE shall:

- 1> set the variable ESTABLISHMENT_CAUSE to "Inter-RAT cell reselection";
- NOTE: This value of ESTABLISHMENT_CAUSE has priority over the cause requested by upper layers.
- 1> initiate an RRC connection establishment procedure as specified in subclause 8.1.3;
- 1> after initiating an RRC connection establishment:
 - 2> release all resources specific to the other radio access technology.

If the NAS procedures associated with inter-system change specified in [5] do not require the establishment of an RRC connection, the UE shall:

- 1> enter idle mode in the target cell without accessing the cell; and
- 1> release all resources specific to the other radio access technology.

9.2.3.3.4.3 Test description

9.2.3.3.4.3.1 Pre-test conditions

System Simulator:

- cell A is configured as Serving cell, cell 5 as Non-Suitable cell;
- cell 5 (belongs to LAI-2) is operating in network operation mode II (No Gs interface present);
- cell A has the absolute priorities set to LTE.

- System information combination 4 as defined in TS 36.508[18] clause 4.4.3.1 is used in E-UTRA cells.

NOTE: For cell 5, power levels are defined in TS 34.108 subclause 6.1.5 (FDD) or 6.1.6 (TDD).

UE:

- the UE is previously registered on UTRAN, and when on UTRAN, the UE is last registered on cell 5 using default message contents according to TS 36.508 [18].

Preamble:

- the UE is in state Registered Idle Mode (state 2) in cell A according to TS 36.508 [18].

9.2.3.3.4.3.2 Test procedure sequence

Table 9.2.3.3.4.3.2-1: Main behaviour

St	Procedure	Message Sequence		TP	Verdict
		U – S	Message		
1	The signal strength of Cell 5 is raised to that of the Serving Cell and that of Cell A is lowered to that of a non-Suitable Neighbour Cell as defined in table 6.2.2.1-1 of TS 36.508 [18].	-	-	-	-
2	Void	-	-	-	-
3	Void	-	-	-	-
4	Void	-	-	-	-
-	EXCEPTION: The behaviour in table 9.2.3.3.4.3.2-2 occurs in parallel with step 5	-	-	-	-
5	Check: Does the UE transmit a ROUTING AREA UPDATE REQUEST message on Cell 5 as specified in the specific message contents included in an INITIAL DIRECT TRANSFER message with <i>intraDomainNasNodeSelector</i> mapped from GUTI-1? The required RRC Connection is established using Establishment Cause set to inter-RAT cell-selection.	-->	ROUTING AREA UPDATE REQUEST	1	P
5A	The SS sends a SECURITY MODE COMMAND message to activate integrity protection and ciphering. This message is integrity protected using IK' derived from K _{ASME} and UL NAS COUNT.	-	-	-	-
5B	Check: Does the UE transmit a SECURITY MODE COMPLETE message integrity protected using IK' derived from K _{ASME} and UL NAS COUNT?	-	-	4	P
6	The SS transmits a ROUTING AREA UPDATE ACCEPT message with Update result = "RA updated" and new P-TMSI allocated with a different NRI (=IDNNS) to that in the GUTI and the P-TMSI that was stored on the USIM. This message is ciphered and integrity protected using CK' and IK' derived from K _{ASME} and UL NAS COUNT.	<--	ROUTING AREA UPDATE ACCEPT	-	-
7	Check: Does the UE transmit a ROUTING AREA UPDATE COMPLETE message ciphered and integrity protected using CK' and IK' derived from K _{ASME} and UL NAS COUNT?	-->	ROUTING AREA UPDATE COMPLETE	4	P
8	The SS releases the RRC connection	-	-	-	-
9	The SS transmits Paging with new P-TMSI allocated in step 6 on cell 5	<--	Page	-	-
10	Check: Does the UE send a Service Request to access the PS domain using IDNNS mapped from the P-TMSI allocated in step 6?	-->	SERVICE REQUEST	2	P
10 A	The SS sends an AUTHENTICATION AND CIPHERING REQUEST message to perform a UMTS AKA procedure.	<--	AUTHENTICATION AND CIPHERING REQUEST	-	-
10 B	The UE sends an AUTHENTICATION AND CIPHERING RESPONSE message.	-->	AUTHENTICATION AND CIPHERING RESPONSE	-	-
11	The SS sends a SECURITY MODE COMMAND message to activate integrity protection and ciphering. This message is integrity protected using new IK.	-	-	-	-
11 A	Check: Does the UE transmit a SECURITY MODE COMPLETE message integrity protected using new IK?	-	-	5	-
11 B	The SS transmits a UE CAPABILITY ENQUIRY message requesting the UE E-	-	-	5	P

	UTRAN capability. This message is ciphered and integrity protected using new CK and IK. Check: Does the UE transmit a UE CAPABILITY INFORMATION message? Note: the purpose of this message is to show that the UE uses new CK and IK, and not CK' and IK' used in step 7.				
11 C	SS transmits a UE CAPABILITY INFORMATION CONFIRM message	<--	UE CAPABILITY INFORMATION CONFIRM	-	-
12	The SS releases the RRC connection	-	-	-	-
12 A	Cell A is configured as the Serving cell and cell 5 is configured as a Suitable Neighbour Cell.	-	-	-	-
12 B	Check: Does the UE transmit an RRCConnectionRequest with the <i>ue-Identity</i> set for pre-Rel-12 UE to s-TMSI or "random value", and for Rel-12 and onwards UE set to randomValue, the <i>establishmentcause</i> set to <i>MO-signalling</i> ?	-->	RRCConnectionRequest	3	P
13	The SS responds with RRCConnectionSetup.	<--	RRCConnectionSetup	-	-
14	Check: Does the UE transmit an RRCConnectionSetupComplete message with the <i>mmegi</i> and <i>mmec</i> set to the values derived from the mapped RAI and P-TMSI and with the <i>gummei</i> type set to mapped when randomValue is included in step 12B, otherwise without the registeredMME included, and containing a TRACKING AREA UPDATE REQUEST message?	-->	RRCConnectionSetupComplete (TRACKING AREA UPDATE REQUEST)	3	P
15	The SS responds with a TRACKING AREA UPDATE ACCEPT message	<--	TRACKING AREA UPDATE ACCEPT	-	-
15 A	UE transmits a TRACKING AREA UPDATE COMPLETE message	-->	TRACKING AREA UPDATE COMPLETE	-	-
16	The SS releases the RRC connection.	-	-	-	-

Table: 9.2.3.3.4.3.2-2: Parallel behaviour

St	Procedure	Message Sequence		TP	Verdict
		U - S	Message		
	EXCEPTION: Steps 1a1 to 1a2 describe behaviour that depends on the UE capability; the "lower case letter" identifies a step sequence that take place if the UE is configured in PS/CS mode of operation.				
1a1	Check: The UE transmits a LOCATION UPDATING REQUEST on cell 5 to the MSC as specified in the specific message contents included in an INITIAL DIRECT TRANSFER message with <i>intraDomainNasNodeSelector</i> mapped from MSC TMSI allocated in the ATTACH ACCEPT message (step 14 table 4.5.2.3-1 of TS 36.508 [18]).	-->	LOCATION UPDATING REQUEST	1	P
1a2	The SS transmits a LOCATION UPDATING ACCEPT message.	<--	LOCATION UPDATING ACCEPT	-	-

9.2.3.3.4.3.3 Specific message contents

Table 9.2.3.3.4.3.3-1: Void

Table 9.2.3.3.4.3.3-2: Void

Table 9.2.3.3.4.3.3-2A: INITIAL DIRECT TRANSFER (step 1a1, Table 9.2.3.3.4.3.2-2)

Derivation path: 25.331 clause 11			
Information Element	Value/Remark	Comment	Condition
InitialDirectTransfer ::= SEQUENCE {			
cn-DomainIdentity	cs-domain		
intraDomainNasNodeSelector SEQUENCE {			
version CHOICE {			
release99 SEQUENCE {			
gsm-Map-IDNNS SEQUENCE {			
routingbasis CHOICE {			
tMSIofsamePLMN {			
Routingparameter	bit 23 to bit 14 of TMSI allocated in pre-test		
}			
}			
}			
}			
nas-Message	See table 9.2.3.3.4.3.3-5		
measuredResultsOnRACH	Not checked		
v3a0NonCriticalExtensions SEQUENCE {			
initialDirectTransfer-v3a0ext SEQUENCE {			
start-Value	Any		
}			
laterNonCriticalExtensions SEQUENCE {			
initialDirectTransfer-r3-add-ext	Not checked		
v590NonCriticalExtension SEQUENCE {			
initialDirectTransfer-v590ext SEQUENCE {			
establishmentCause	Registration or Not present		
}			
}			
v690NonCriticalExtensions	Not checked		
}			
}			
}			
}			
}			
}			
}			

Table 9.2.3.3.4.3.3-3: LOCATION UPDATING REQUEST (step 1a1, Table 9.2.3.3.4.3.2-2)

Derivation path: 24.008 table 9.2.17			
Information Element	Value/Remark	Comment	Condition
Update type	1000	LA updating	
Ciphering key sequence number	eKSI stored on the test USIM		
Location area identification	PLMN= MCC/MNC TAC 1=1	"PLMN is set to the same MCC/MNC stored in EF _{IMSI} " "TAI-1"	
Mobile identity	TMSI-1	Allocated in preamble	

Table 9.2.3.3.4.3.3-3A: LOCATION UPDATING ACCEPT (step 4, Table 9.2.3.3.4.3.2-1)

Derivation Path: TS 36.508 Table 4.7B.2-5			
Information Element	Value/remark	Comment	Condition
Mobile identity	Not present		

Table 9.2.3.3.4.3.3-4: INITIAL DIRECT TRANSFER (step 5, Table 9.2.3.3.4.3.2-1)

Derivation path: 25.331 clause 11			
Information Element	Value/Remark	Comment	Condition
InitialDirectTransfer ::= SEQUENCE {			
cn-DomainIdentity	ps-domain		
intraDomainNasNodeSelector SEQUENCE {			
version CHOICE {			
release99 SEQUENCE {			
gsm-Map-IDNNS SEQUENCE {			
routingbasis CHOICE {			
tMSIofsamePLMN {			
Routingparameter	bit 23 to bit 14 of P-TMSI mapped from GUTI allocated to UE in pre-test		
}			
}			
}			
}			
}			
nas-Message	See table 9.2.3.3.4.3.3-5		
measuredResultsOnRACH	Not checked		
v3a0NonCriticalExtensions SEQUENCE {			
initialDirectTransfer-v3a0ext SEQUENCE {			
start-Value	Any		
}			
laterNonCriticalExtensions SEQUENCE {			
initialDirectTransfer-r3-add-ext	Not checked		
v590NonCriticalExtension SEQUENCE {			
initialDirectTransfer-v590ext SEQUENCE {			
establishmentCause	Registration or Not present		
}			
v690NonCriticalExtensions	Not checked		
}			
}			
}			
}			
}			

Table 9.2.3.3.4.3.3-5: Message ROUTING AREA UPDATE REQUEST (step 5, Table 9.2.3.3.4.3.2-1)

Derivation path: 24.008 table 9.4.14			
Information Element	Value/Remark	Comment	Condition
Update type	000	RA updating	
GPRS ciphering key sequence number	eKSI stored on the test USIM		
Old routing area identification	GUTI-1 right shifted by 32bits		
MS Radio Access capability	Not checked		
Old P-TMSI signature	Mapped from GUTI-1		
Requested READY timer value	Not checked		
DRX parameter	Not checked		
TMSI status	Not present		
P-TMSI	Value is specified bit by bit below: - bit 31 and bit 30: 1 - bit 29 to bit 24: bit 29 to bit 24 of M-TMSI allocated in preamble - bit 23 to bit 16: MME code allocated in preamble - bit 15 to bit 0: bit 15 to bit 0 of M-TMSI allocated in preamble		
MS network capability	Not checked		
PDP context status	Not checked		
PS LCS Capability	Not checked		
MBMS context status	Not checked		
UE network capability	Any allowed value		
Additional mobile identity	P-TMSI allocated in pre-test		
Additional old routing area identification	RAI-1		
Mobile station classmark 2	Not checked		
Mobile station classmark 3	Not checked		
Supported Codecs	Not checked		

Table 9.2.3.3.4.3.3-6: Message SERVICE REQUEST (step 10, Table 9.2.3.3.4.3.2-1)

Derivation path: 24.008 table 9.4.20			
Information Element	Value/Remark	Comment	Condition
Ciphering key sequence number	FFS		
Service Type	010 (Paging Response)		
P-TMSI	P-TMSI allocated in step 6.		

Table 9.2.3.3.4.3-6A: SECURITY MODE COMMAND (step 11, Table 9.2.3.3.4.3.2-1)

Derivation path: 34.108 clause 9.1.1			
Information Element	Value/Remark	Comment	Condition
RRC transaction identifier	Arbitrarily selects an integer between 0 and 3		
Integrity check info			
- Message authentication code	Set to MAC-I value computed by the SS. The first/ leftmost bit of the bit string contains the most significant bit of the MAC-I.		
- RRC Message Sequence Number	Set to an arbitrarily selected integer between 0 and 15		
Security capability	Set same value as originally sent by UE in the RRC CONNECTION SETUP COMPLETE message in step 10.		
Ciphering mode info			
- Ciphering mode command	Start/restart		
- Ciphering algorithm	Set one of the algorithms supported by the UE as indicated in the IE "security capability" in the RRC CONNECTION SETUP COMPLETE message in step 10.		
- Ciphering activation time for DPCH	Not Present		
- Radio bearer downlink ciphering activation time info			
- Radio bearer activation time			
- RB identity	1		
- RLC sequence number	Current RLC SN stored in the SS		
- RB identity	2		
- RLC sequence number	Current RLC SN stored in the SS +2		
- RB identity	3		
- RLC sequence number	Current RLC SN stored in the SS		
- RB identity	4		
- RLC sequence number	Current RLC SN stored in the SS		
Integrity protection mode info			
- Integrity protection mode command	startIntegrityProtection		
- Integrity protection initialisation number	Arbitrary selects 32 bits number for FRESH		
- Integrity protection algorithm	Set one of the algorithms supported by the UE as indicated in the IE "security capability" in the RRC CONNECTION SETUP COMPLETE message in step 10.		
CN domain identity	PS		
UE system specific security capability	Not present		not GSM
UE system specific security capability			GSM
- Inter-RAT UE security capability			
- CHOICE system	GSM		
- GSM security capability	Set the same as the algorithms supported by the UE as indicated in the IE "UE system specific capability" in the		

	RRC CONNECTION SETUP COMPLETE message in step 10.		
--	---	--	--

Condition	Explanation
GSM	UE supporting GSM

Table 9.2.3.3.4.3.3-6B: SECURITY MODE COMPLETE (step 11 A , Table 9.2.3.3.4.3.2-1)

Derivation path: 34.108 clause 9.1.1			
Information Element	Value/Remark	Comment	Condition
RRC transaction identifier	The value of this IE is checked to see that it matches the value of the same IE transmitted in the downlink SECURITY MODE COMMAND message.		
Integrity check info			
- Message authentication code	This IE is checked to see if it is present. The value is compared against the XMAC-I value computed by SS. The first/ leftmost bit of the bit string contains the most significant bit of the MAC-I.		
- RRC Message Sequence Number	The value is used by SS to compute the XMAC-I value.		
Uplink integrity protection activation info			
- RRC message sequence number list			
- RRC message sequence number	Check to see if the RRC SN for RB 0 is present		
- RRC message sequence number	Check to see if the RRC SN for RB 1 is present		
- RRC message sequence number	Check to see if the RRC SN for RB 2 is present		
- RRC message sequence number	Check to see if the RRC SN for RB 3 is present		
- RRC message sequence number	Check to see if the RRC SN for RB 4 is present		
Radio bearer uplink ciphering activation time info			
- Radio bearer activation time			
- RB Identity	1		
- RLC sequence number	Check to see if the RLC SN for RB1 is present		
- RB Identity	2		
- RLC sequence number	Check to see if the RLC SN for RB2 is present		
- RB Identity	3		
- RLC sequence number	Check to see if the RLC SN for RB3 is present		
- RB Identity	4		
- RLC sequence number	Check to see if the RLC SN for RB4 is present		

Table 9.2.3.3.4.3.3-7: Message RRCConnectionRequest (step 12 B, Table 9.2.3.3.4.3.2-1)

Derivation path: 36.508 table 4.6.1-16			
Information Element	Value/Remark	Comment	Condition
RRCConnectionRequest ::= SEQUENCE {			
criticalExtensions CHOICE {			
rrcConnectionRequest-r8 SEQUENCE {			
ue-Identity CHOICE {			
s-TMSI	Received from upper layer NAS	Rel-8 to Rel-11 inclusive	
randomValue	Any allowed value	Rel-8 and onwards	
}			
establishmentCause	Mo-Signalling		
}			
}			
}			

Table 9.2.3.3.4.3.3-8: Message RRCConnectionSetupComplete (step 14, Table 9.2.3.3.4.3.2-1)

Derivation path: 36.508 table 4.6.1-18			
Information Element	Value/Remark	Comment	Condition
RRCConnectionSetupComplete ::= SEQUENCE {			
criticalExtensions CHOICE {			
c1 CHOICE {			
rrcConnectionSetupComplete-r8 SEQUENCE {			
selectedPLMN-Identity	1		
registeredMME	Not present	Shall be absent if the upper layers provided s-TMSI in RRCConnectionRequest message in step 12B for pre-Rel-12 UE	
registeredMME {		Present only when the ue-Identity in step 12B is set to randomValue	
plmn-Identity	Not present		
Mmegi	LAC sent to the UE in step 6		
Mmec	Bit 23 to bit 16 of P-TMSI sent to the UE in step 6		
}			
dedicatedInfoNAS	See table 9.2.3.3.4.3.3-9		
nonCriticalExtension SEQUENCE {			
nonCriticalExtension SEQUENCE {			
gummei-Type-r10	mapped	Present when the registeredMME is included	
}			
}			
}			
}			
}			
}			

Table 9.2.3.3.4.3-9: Message TRACKING AREA UPDATE REQUEST (step 14, Table 9.2.3.3.4.3-1)

Derivation path: 36.508 table 4.7.2-27 with condition UNCIPHERED (the message is integrity protected using the key stored in the USIM).			
Information Element	Value/Remark	Comment	Condition
EPS update type	000 or 010	'TA updating' or 'combined TA/LA updating with IMSI attach'	
NAS key set identifier			
NAS key set identifier	The valid NAS key set identifier stored in the USIM		
TSC	'0'B	native security context (for KSI _{ASME})	
Old GUTI or IMSI			
Type of identity	110	GUTI	
MNC/MCC	Mobile Country Code and Mobile Network Code stored in EF _{IMSI} on the test USIM		
MME Group ID	LAI allocated at step 8		
MME Code	Bit 23 to bit 16 of P-TMSI allocated at step 8		
M-TMSI	Value is specified bit by bit below: - bit 31 and bit 30: FFS - bit 29 to bit 24: bit 29 to bit 24 of P-TMSI allocated at step 8 - bit 23 to bit 16: RAC allocated at step 8 - bit 15 to bit 0: bit 15 to bit 0 of P-TMSI allocated at step 8		
GPRS ciphering key sequence number	GPRS ciphering key sequence number allocated at step 10A		
Old P-TMSI signature	P-TMSI signature allocated at step 8		
Additional GUTI	GUTI-1		
Nonce _{UE}	Any allowed value (must be present)		
UE network capability	Any allowed value (must be present)		
Last visited registered TAI	TAI stored in the test USIM		
MS network capability	Any allowed value (must be present)		
Old location area identification	Not present if "EPS update type" is 'TA updating', LAI-2 is "EPS update type" is 'combined TA/LA updating'		
TMSI status	Not present		

9.2.3.3.5 Periodic routing area update

9.2.3.3.5.1 Test Purpose (TP)

(1)

```
with { UE is camped on an E-UTRAN cell or in ECM-CONNECTED state and ISR is activated }
ensure that {
  when { UE performs E-UTRA RRC state transitions }
```

```

    then { UE keeps the periodic routing area update timer T3312 running }
  }

```

(2)

```

with { UE is camped on an E-UTRAN cell or ECM-CONNECTED state and ISR is activated }
ensure that {
  when { the periodic routing area update timer T3312 expires }
  then { UE does not change RAT }
}

```

(3)

```

with { UE is in state GMM-REGISTERED.NO-CELL-AVAILABLE and ISR is activated and the periodic routing
area update timer T3312 expires }
ensure that {
  when { UE enters the state GMM-REGISTERED.NORMAL-SERVICE }
  then { UE initiates the routing area updating procedure }
}

```

9.2.3.3.5.2 Conformance requirements

References: The conformance requirements covered in the present TC are specified in: TS 24.008, clause 4.7.2.2 and TS 23.401, clause 4.3.5.2.

[TS 24.008, clause 4.7.2.2]

If ISR is activated, the MS shall keep both the periodic tracking area update timer (timer T3412) and the periodic routing area update timer (timer T3312). The two separate timers run in the MS for updating MME and SGSN independently. If the periodic routing area update timer expires and the MS is in state GMM-REGISTERED.NO-CELL-AVAILABLE, the MS shall set its TIN to "RAT-related TMSI" and start the GERAN/UTRAN Deactivate ISR timer T3323. The MS shall initiate the routing area updating procedure and stop the timer T3323 when the MS enters the state GMM-REGISTERED.NORMAL-SERVICE before timer T3323 expires. After expiry of timer T3323 the MS shall deactivate ISR by setting its TIN to "GUTI" and initiate the routing area updating procedure when the UE enters the state GMM-REGISTERED.NORMAL-SERVICE.

[TS 23.401, clause 4.3.5.2]

If the UE is camped on an E-UTRAN cell or is in ECM-CONNECTED state when the UE's periodic RAU or periodic LAU timer expires and ISR is activated the UE shall start the GERAN/UTRAN Deactivate ISR timer. After the GERAN/UTRAN Deactivate ISR timer expires the UE shall deactivate ISR by setting its TIN to "GUTI". The GMM/PMM-REGISTERED UE shall remember it has to perform a Routing Area Update to the SGSN or a Location Area Update to the MSC when it next returns to 2G/3G coverage.

The E-UTRAN Deactivate ISR timer is stopped when the UE performs a successful TAU; and the GERAN/UTRAN Deactivate ISR timer is stopped when the UE performs a successful RAU/LAU.

Expiry of the periodic TAU timer, or, the periodic RAU timer, or, the periodic LAU timer shall not cause the UE to change RAT.

...

E-UTRAN RRC state transitions shall have no impact on the periodic RAU timer or periodic LAU timer except that handover from 2G/3G to E-UTRAN shall cause the periodic RAU timer to be started from its initial value.

9.2.3.3.5.3 Test description

9.2.3.3.5.3.1 Pre-test conditions

System Simulator:

- cell A (belongs to TAI-1, home PLMN) is set to "Serving cell";
- if pc_UTRA AND px_RATComb_Tested = EUTRA_UTRA, cell 5 (home PLMN, RAI-1, NMO 1) is set to "Non-suitable cell";
- if pc_GERAN AND px_RATComb_Tested = EUTRA_GERAN, cell 24 (home PLMN, RAI-1, NMO 1) is set to "Non-suitable cell";
- System information combination 10 as defined in TS 36.508[18] clause 4.4.3.1 is used in E-UTRA cells.

NOTE: Setting px_RATComb_Tested = EUTRA_Only is not allowed.

UE:

- if pc_UTRA AND px_RATComb_Tested = EUTRA_UTRA, the UE is previously registered on UTRAN cell 5 using default message contents according to TS 36.508 [18].
- if pc_GERAN AND px_RATComb_Tested = EUTRA_GERAN, the UE is previously registered on GERAN cell 24 using default message contents according to TS 36.508 [18].

Preamble:

- the UE is in state Registered, Idle Mode (state 2) on cell A according to TS 36.508 [18].

9.2.3.3.5.3.2 Test procedure sequence

Table 9.2.3.3.5.3.2-1: Main behaviour

St	Procedure	Message Sequence		TP	Verdict
		U - S	Message		
-	EXCEPTION: Steps 1a1 to 1b5 describe behaviour that depends on the UE capability; the "lower case letter" identifies a step sequence that takes place if a capability is supported.	-	-	-	-
1a1	IF pc_UTRA THEN the SS sets the cell type of Cell 5 to "Serving cell" and the cell type of Cell A to "Non-suitable cell".	-	-	-	-
1a2	The UE transmits a ROUTING AREA UPDATE REQUEST message on Cell 5.	-->	ROUTING AREA UPDATE REQUEST	-	-
1a3	The SS transmits a ROUTING AREA UPDATE ACCEPT message on Cell 5.	<--	ROUTING AREA UPDATE ACCEPT	-	-
1a4	Void	-	-	-	-
1a5	The SS sets the cell type of Cell A to "Serving cell" and the cell type of Cell 5 to "Non-suitable cell".	-	-	-	-
1b1	ELSE IF pc_GERAN THEN the SS sets the cell type of Cell 24 to "Serving cell" and the cell type of Cell A to "Non-suitable cell".	-	-	-	-
1b2	The UE transmits a ROUTING AREA UPDATE REQUEST message on Cell 24.	-->	ROUTING AREA UPDATE REQUEST	-	-
1b2 A1	The SS transmits an Authentication and Ciphering Request message on Cell 24	<--	Authentication and Ciphering Request	-	-
1b2 A2	The UE transmits an Authentication and Ciphering Response message on Cell 24	-->	Authentication and Ciphering Response	-	-
1b3	The SS transmits a ROUTING AREA UPDATE ACCEPT message on Cell 24	<--	ROUTING AREA UPDATE ACCEPT	-	-
1b4	Void	-	-	-	-
1b5	The SS sets the cell type of Cell A to "Serving cell" and the cell type of Cell 24 to "Non-suitable cell".	-	-	-	-
-	EXCEPTION: Steps 1Aa1 to 1Aa4 describe behaviour that depends on the UE capability; the "lower case letter" identifies a step sequence that take place according to UE mode of operation.	-	-	-	-
1A a1	IF CS/PS mode 1 or CS/PS mode 2 of operation is configured on the UE and px_AttachTypeTested is set to COMBINED_ATTACH THEN the UE transmits a TRACKING AREA UPDATE REQUEST message on Cell A.	-->	TRACKING AREA UPDATE REQUEST	-	-
1A a2	The SS transmits a TRACKING AREA UPDATE ACCEPT message on Cell A.	<--	TRACKING AREA UPDATE ACCEPT	-	-
1A a3	The UE transmits a TRACKING AREA UPDATE COMPLETE message on Cell A.	-->	TRACKING AREA UPDATE COMPLETE	-	-
1A a4	The SS releases the RRC connection.	-	-	-	-
2	The SS waits for 1 min.	-	-	-	-
3	The SS pages the UE on Cell A using S-TMSI with CN domain indicator set to "PS".	<--	-	-	-
4	The UE transmits a SERVICE REQUEST message on Cell A.	-->	SERVICE REQUEST	-	-
5	The SS transmits an ACTIVATE DEDICATED EPS BEARER CONTEXT REQUEST message on Cell A activating a new EPS bearer context. This message is included in an <i>RRCConnectionReconfiguration</i> message to setup the new radio bearer associated with the	<--	ACTIVATE DEDICATED EPS BEARER CONTEXT REQUEST	-	-

	dedicated EPS bearer context activated by the NAS message.				
6	The UE transmits an ACTIVATE DEDICATED EPS BEARER CONTEXT ACCEPT message on Cell A.	-->	ACTIVATE DEDICATED EPS BEARER CONTEXT ACCEPT	-	-
7	The SS transmits a DEACTIVATE EPS BEARER CONTEXT REQUEST message on Cell A deactivating the dedicated EPS bearer context activated at Step 5. This message is included in an <i>RRCConnectionReconfiguration</i> message.	<--	DEACTIVATE EPS BEARER CONTEXT REQUEST	-	-
8	The UE transmits a DEACTIVATE EPS BEARER CONTEXT ACCEPT message on Cell A.	-->	DEACTIVATE EPS BEARER CONTEXT ACCEPT	-	-
8A	The SS releases the RRC connection.	-	-	-	-
-	EXCEPTION: Steps 9a1 to 9b5 describe behaviour that depends on the UE capability; the "lower case letter" identifies a step sequence that takes place if a capability is supported.	-	-	-	-
9a1	IF pc_UTRA AND px_RATComb_Tested = EUTRA_UTRA THEN the SS sets the cell type of Cell 5 to "Serving cell" and the cell type of Cell A to "Non-suitable cell".	-	-	-	-
9a2	Check: When T3312 started after Step 1a3 expires, does the UE transmit a ROUTING AREA UPDATE REQUEST on Cell 5?	-->	ROUTING AREA UPDATE REQUEST	1	P
9a3	The SS transmits a ROUTING AREA UPDATE ACCEPT message on Cell 5.	<--	ROUTING AREA UPDATE ACCEPT	-	-
9a4	Void	-	-	-	-
9a5	The SS sets the cell type of Cell A to "Serving cell" and the cell type of Cell 5 to "Non-suitable cell".	-	-	-	-
9b1	ELSE IF pc_GERAN AND px_RATComb_Tested = EUTRA_GERAN THEN the SS sets the cell type of Cell 24 to "Serving cell" and the cell type of Cell A to "Non-suitable cell".	-	-	-	-
9b2	Check: When T3312 started after Step 1b3 expires, does the UE transmit a ROUTING AREA UPDATE REQUEST on Cell 24?	-->	ROUTING AREA UPDATE REQUEST	1	P
9b3	The SS transmits a ROUTING AREA UPDATE ACCEPT message on Cell 24 .	<--	ROUTING AREA UPDATE ACCEPT	-	-
9b4	Void	-	-	-	-
9b5	The SS sets the cell type of Cell A to "Serving cell" and the cell type of Cell 24 to "Non-suitable cell".	-	-	-	-
-	EXCEPTION: Steps 9Aa1 to 9Aa4 describe behaviour that depends on the UE capability; the "lower case letter" identifies a step sequence that take place according to UE mode of operation.	-	-	-	-
9A a1	IF CS/PS mode 1 or CS/PS mode 2 of operation is configured on the UE and px_AttachTypeTested is set to COMBINED_ATTACH THEN the UE transmits a TRACKING AREA UPDATE REQUEST message on Cell A.	-->	TRACKING AREA UPDATE REQUEST	-	-
9A a2	The SS transmits a TRACKING AREA UPDATE ACCEPT message on Cell A.	<--	TRACKING AREA UPDATE ACCEPT	-	-
9A a3	The UE transmits a TRACKING AREA UPDATE COMPLETE message on Cell A.	-->	TRACKING AREA UPDATE COMPLETE	-	-
9A a4	The SS releases the RRC connection.	-	-	-	-
10	The SS waits for 1 min.	-	-	-	-
11	The SS pages the UE on Cell A using S-TMSI	<--	-	-	-

	with CN domain indicator set to "PS".				
12	The UE transmits a SERVICE REQUEST message on Cell A.	-->	SERVICE REQUEST	-	-
13	The SS transmits an ACTIVATE DEDICATED EPS BEARER CONTEXT REQUEST message on Cell A activating a new EPS bearer context. This message is included in an <i>RRConnectionReconfiguration</i> message to setup the new radio bearer associated with the dedicated EPS bearer context activated by the NAS message.	<--	ACTIVATE DEDICATED EPS BEARER CONTEXT REQUEST	-	-
14	The UE transmits an ACTIVATE DEDICATED EPS BEARER CONTEXT ACCEPT message on Cell A.	-->	ACTIVATE DEDICATED EPS BEARER CONTEXT ACCEPT	-	-
15	The SS waits until T3312 timer started at Step 9a3/9b3 has expired.	-	-	-	-
16	Check: After T3312 started after Step 9a3/9b3 expires and before T3323 expires, does the test result of generic test procedure in TS 36.508 subclause 6.4.2.6 indicate that a dedicated EPS bearer context is active on cell A?	-	-	2	-
17	The SS transmits a DEACTIVATE EPS BEARER CONTEXT REQUEST message on Cell A deactivating the dedicated EPS bearer context activated at Step 13. This message is included in an <i>RRConnectionReconfiguration</i> message.	<--	DEACTIVATE EPS BEARER CONTEXT REQUEST	-	-
18	The UE transmits a DEACTIVATE EPS BEARER CONTEXT ACCEPT message on Cell A.	-->	DEACTIVATE EPS BEARER CONTEXT ACCEPT	-	-
19	The SS waits for 2 min.	-	-	-	-
19 A	The SS releases the RRC connection.	-	-	-	-
20	Check: After T3312 started after Step 9a3/9b3 expires and before T3323 expires, does the test result of generic test procedure in TS 36.508 subclause 6.4.2.2 indicate that the UE is in state Registered, Idle Mode on Cell A?	-	-	2	-
-	EXCEPTION: Steps 21a1 to 21b4 describe behaviour that depends on the UE capability; the "lower case letter" identifies a step sequence that takes place if a capability is supported.	-	-	-	-
21a 1	IF pc_UTRA AND px_RATComb_Tested = EUTRA_UTRA THEN the SS sets the cell type of Cell 5 to "Serving cell" and the cell type of Cell A to "Non-suitable cell".	-	-	-	-
21a 2	Check: After T3312 started after Step 9a3 expires and before T3323 expires, does the UE transmit a ROUTING AREA UPDATE REQUEST message on Cell 5?	-->	ROUTING AREA UPDATE REQUEST	3	P
21a 3	The SS transmits a ROUTING AREA UPDATE ACCEPT message on Cell 5.	<--	ROUTING AREA UPDATE ACCEPT	-	-
21a 4	Void	-	-		
21b 1	ELSE IF pc_GERAN AND px_RATComb_Tested = EUTRA_GERAN THEN the SS sets the cell type of Cell 24 to "Serving cell" and the cell type of Cell A to "Non-suitable cell".	-	-	-	-
21b 2	Check: After T3312 started after Step 9b3 expires and before T3323 expires, does the UE transmit a ROUTING AREA UPDATE	-->	ROUTING AREA UPDATE REQUEST	3	P

	REQUEST message on Cell 24?				
21b 3	The SS transmits a ROUTING AREA UPDATE ACCEPT message on Cell 24.	<--	ROUTING AREA UPDATE ACCEPT	-	-
21b 4	Void		-		

9.2.3.3.5.3.3 Specific message contents

Table 9.2.3.3.5.3.3-1: Message ROUTING AREA UPDATE REQUEST (steps 1a2/1b2, Table 9.2.3.3.5.3.2-1)

Information Element	Value/remark	Comment	Condition
Update type	Any allowed value		
P-TMSI	P-TMSI mapped from GUTI assigned to UE during preamble		UTRA
MS network capability			
ISR support	1		

Table 9.2.3.3.5.3.3-2: Message ROUTING AREA UPDATE REQUEST (step 9a2/9b2, Table 9.2.3.3.5.3.2-1)

Information Element	Value/remark	Comment	Condition
Update type	011	"Periodic updating"	
P-TMSI	P-TMSI assigned to UE during preamble		UTRA
MS network capability			
ISR support	1		
UE network capability	Not present		

Table 9.2.3.3.5.3.3-3: Message ROUTING AREA UPDATE ACCEPT (steps 1a3, and 21a3/21b3, Table 9.2.3.3.5.3.2-1)

Information Element	Value/remark	Comment	Condition
Update result	100	"RA updated and ISR activated"	TA only
	001	"combined RA/LA updated"	combined_TA_LA
Periodic RA update timer	00100111	7 min	
Allocated P-TMSI	Not present		

Table 9.2.3.3.5.3.3-4: Message TRACKING AREA UPDATE REQUEST (step 9Aa1, table 9.2.3.3.5.3.2-1)

Derivation path: 36.508 table 4.7.2-27			
Information Element	Value/Remark	Comment	Condition
Old P-TMSI signature	Any allowed value		
GPRS ciphering key sequence number	Any allowed value		
Additional GUTI	Not present or any allowed value		
Nonce _{UE}	Any allowed value		

Table 9.2.3.3.5.3.3-5 Message TRACKING AREA UPDATE ACCEPT (steps 1Aa2 and 9Aa2 Table 9.2.3.3.5.3.2-1)

Derivation path: 36.508 table 4.7.2-24			
Information Element	Value/Remark	Comment	Condition
EPS update result	101	"combined TA/LA updated and ISR activated"	

Table 9.2.3.3.5.3.3-6: Message TRACKING AREA UPDATE REQUEST (step 1Aa1, table 9.2.3.3.5.3.2-1)

Derivation path: 36.508 table 4.7.2-27			
Information Element	Value/Remark	Comment	Condition
EPS update type	010	combined TA/LA updating with IMSI attach	
GPRS ciphering key sequence number	Any allowed value		
Old P-TMSI signature	Any allowed value		
Additional GUTI	Not present or any allowed value		
Nonce _{UE}	Any allowed value		

Table 9.2.3.3.5.3.3-7: Message ROUTING AREA UPDATE REQUEST (step 21a2/21b2, Table 9.2.3.3.5.3.2-1)

Information Element	Value/remark	Comment	Condition
Update type	011	"Periodic updating"	TA only
	010	"combined RA/LA updating with IMSI attach"	combined_TA_LA
P-TMSI	P-TMSI assigned to UE during preamble		UTRA
MS network capability			
ISR support	1		
UE network capability	Not present		TA only
	Any allowed value		combined_TA_LA

Table 9.2.3.3.5.3.3-8: Message ROUTING AREA UPDATE ACCEPT (step 9a3, Table 9.2.3.3.5.3.2-1)

Information Element	Value/remark	Comment	Condition
Update result	100	"RA updated and ISR activated"	TA only
	000	"RA updated"	combined_TA_LA
Periodic RA update timer	00100111	7 min	
Allocated P-TMSI	Not present		

Table 9.2.3.3.5.3.3-9: Message ROUTING AREA UPDATE ACCEPT (steps 1b3, Table 9.2.3.3.5.3.2-1)

Information Element	Value/remark	Comment	Condition
Update result	100	"RA updated and ISR activated"	TA only
	001	"combined RA/LA updated"	combined_TA_LA
Periodic RA update timer	00100111	7 min	
READY Timer	00000	0 sec	
Allocated P-TMSI	Not present		

Table 9.2.3.3.5.3.3-10: Message ROUTING AREA UPDATE ACCEPT (step 9b3, Table 9.2.3.3.5.3.2-1)

Information Element	Value/remark	Comment	Condition
Update result	100	"RA updated and ISR activated"	TA only
	000	"RA updated"	combined_TA_LA
Periodic RA update timer	00100111	7 min	
READY Timer	00000	0 sec	
Allocated P-TMSI	Not present		

9.2.3.3.5a Periodic Location Update

9.2.3.3.5a.1 Test Purpose (TP)

(1)

```
with { UE in MM IDLE substate NORMAL SERVICE with periodic location update timer T3212 running}
ensure that {
  when { UE camps on a E-UTRAN cell and successfully performs a Tracking Area Update and T3212 expires}
  then { the UE does not perform a periodic location update whilst in E-UTRAN coverage and does not change RAT because T3212 has expired}
}
```

9.2.3.3.5a.2 Conformance requirements

References: The conformance requirements covered in the current TC are specified in: TS 23.401 clauses 4.3.5.2; and TS 24.008 clauses 4.7.1.4.1 and 4.7.5.1.1 and TS 24.301 clause 5.1.5.

[TS 23.401, clause 4.3.5.2 "Reachability Management for UE in ECM-IDLE state"]

...

If the UE is EPS attached only and either camps on an E UTRAN cell or is in ECM CONNECTED state when the UE's periodic LAU timer expires, the UE shall perform a Location Area Update procedure in NMO II/III or combined RA/LA update in NMO I when it next returns to GERAN/UTRAN coverage.

...

Expiry of the periodic TAU timer, or, the periodic RAU timer, or, the periodic LAU timer shall not cause the UE to change RAT.

...

E-UTRAN RRC state transitions shall have no impact on the periodic RAU timer or periodic LAU timer except that handover from GERAN/UTRAN to E-UTRAN shall cause the periodic RAU timer to be started from its initial value.

[TS 24.008, 4.2.2.1 "Service State, NORMAL SERVICE"]

When in state MM IDLE and service state NORMAL SERVICE, the mobile station shall:

- perform normal location updating when a new location area is entered;
- perform location updating procedure at expiry of timer T3211 or T3213;
- perform periodic updating at expiration of timer T3212;
- perform IMSI detach;
- support requests from the CM layer;
- respond to paging; and
- for an eCall only mobile station (as determined by information configured in USIM), perform the eCall inactivity procedure at expiry of timer T3242 or timer T3243.

[TS 24.008, 4.4.1 "Location updating procedure"]

...

Upon successful location updating the mobile station sets the update status to UPDATED in the SIM/USIM, and stores the Location Area Identification received in the LOCATION UPDATING ACCEPT message in the SIM/USIM. The attempt counter shall be reset.

[TS 24.008, 4.4.2 "Periodic updating"]

...

The procedure is controlled by the timer T3212 in the mobile station. If the timer is not already started, the timer is started each time the mobile station enters the MM IDLE substate NORMAL SERVICE or ATTEMPTING TO UPDATE. When the MS leaves the MM Idle State the timer T3212 shall continue running until explicitly stopped.

...

When the timer T3212 expires, the location updating procedure is started and the timer shall be set to its initial value for the next start. If the mobile station is in other state than MM Idle when the timer expires the location updating procedure is delayed until the MM Idle State is entered.

...

If the mobile station is in service state NO CELL AVAILABLE, LIMITED SERVICE, PLMN SEARCH or PLMN SEARCH-NORMAL SERVICE when the timer expires the location updating procedure is delayed until this service state is left.

[TS 24.301, clause 5.1.5]

UEs that operate in CS/PS mode 1 or CS/PS mode 2 of operation should not use any MM timers related to MM specific procedures (e.g. T3210, T3211, T3212, T3213) while camped on E-UTRAN, unless the re-activation of these timers is explicitly described. If the MM timers are already running, the UE should not react on the expiration of the timers.

9.2.3.3.5a.3 Test description

9.2.3.3.5a.3.1 Pre-test conditions

System Simulator:

- cell A is configured as Non-suitable cell;
- if pc_UTRA AND px_RATComb_Tested = EUTRA_UTRA, cell 5 (LAI-1, NMO II) is configured as Serving cell. The value of T3212 (in SIB1) is 0110 (6 minutes);
- if pc_GERAN AND px_RATComb_Tested = EUTRA_GERAN, Cell 24 (LAI-1, NMO II) is configured as Serving cell and does not support Dual Transfer Mode (DTM_SUPPORT is configured as default (see TS 51.010-1 clause 40.2.1.1 [23]). The value of T3212 (Octet 4 of the Control Channel Description IE) is 0110 (6 minutes);
- System information combination 10 as defined in TS 36.508[18] clause 4.4.3.1 is used in E-UTRA cells.

UE:

- if pc_UTRA AND px_RATComb_Tested = EUTRA_UTRA, the UE is previously registered on UTRAN cell 5 using default message contents according to TS 36.508 [18].
- if pc_GERAN AND px_RATComb_Tested = EUTRA_GERAN, the UE is previously registered on GERAN cell 24 using default message contents according to TS 36.508 [18].
- the UE is configured to initiate combined EPS/IMSI attach.

Preamble:

- The UE is in state Switched Off (state 1).

9.2.3.3.5a.3.2 Test procedure sequence

Table 9.2.3.3.5a.3.2-1: Main behaviour

St	Procedure	Message Sequence		TP	Verdict
		U – S	Message		
1	The UE is switched on and camps on Cell 24 or Cell 5.	-	-	-	-
-	EXCEPTION: In parallel to the events described in steps 5 to 7 the step specified in Table 9.2.3.3.5a.3.2-3 should take place.	-	-	-	-
2	Void	-	-	-	-
-	EXCEPTION: The messages in the next two steps are sent only on Cell 24	-	-	-	-
2A a1	The UE transmits a <i>Classmark Change</i> message	-->	CLASSMARK CHANGE		
-	EXCEPTION: The next step describes behaviour that depends on UE capability.	-	-	-	-
2A a2	IF pc_UTRA THEN the UE transmits a <i>Utran Classmark Change</i> message.	-->	UTRAN CLASSMARK CHANGE.		
3-4	Void	-	-	-	-
5	The UE transmits an ATTACH REQUEST message on Cell 24 or Cell 5 indicating "GPRS attach".	-->	ATTACH REQUEST		
-	EXCEPTION: The messages in the next two steps are only on Cell 24				
5A a1	The SS transmits an Authentication and Ciphering Request message on Cell 24	<--	Authentication and Ciphering Request	-	-
5A a2	The UE transmits an Authentication and Ciphering Response message on Cell 24	-->	Authentication and Ciphering Response	-	-
6	The SS transmits an ATTACH ACCEPT message indicating "GPRS only attached". The UE sets the update status to UPDATED on the USIM. The SS allocates a P-TMSI.	<--	ATTACH ACCEPT	-	-
7	The UE transmits an ATTACH COMPLETE to acknowledge the P-TMSI allocation.	-->	ATTACH COMPLETE		
8	The UE requests the activation of a default PDP context	-->	ACTIVATE PDP CONTEXT REQUEST		
9	The SS accepts the request for default PDP context request and return an ACTIVATE PDP CONTEXT ACCEPT	<--	ACTIVATE PDP CONTEXT ACCEPT		
-	EXCEPTION: Step 9Aa1 describes behaviour that depends on the RAT combination; the "lower case letter" identifies a step sequence that takes place if a UTRA is applied.	-	-	-	-
9A a1	IF px_RATComb_Tested = EUTRA_UTRA THEN the SS releases the RRC connection.	-	-	-	-
10	The signal strength of Cell A is raised to that of the Serving Cell and Cell 24 or Cell 5 is lowered to that of a Suitable Neighbour Cell as defined in table 6.2.2.1-1 of TS 36.508 [18]. Note: Cell 24 or Cell 5 is still suitable but the UE shall select Cell A	-	-	-	-
11	The UE camps on E-UTRAN cell A and transmits a TRACKING AREA UPDATE REQUEST message.	-->	TRACKING AREA UPDATE REQUEST	-	-
12	The SS transmits an AUTHENTICATION REQUEST message to initiate the EPS authentication and AKA procedure.	<--	AUTHENTICATION REQUEST	-	-
13	The UE transmits an AUTHENTICATION RESPONSE message and establishes mutual authentication.	-->	AUTHENTICATION RESPONSE	-	-
14	The SS transmits a NAS SECURITY MODE COMMAND message to activate NAS security.	<--	SECURITY MODE COMMAND	-	-
15	The UE transmits a NAS SECURITY MODE COMPLETE message and establishes the	-->	SECURITY MODE COMPLETE	-	-

	initial security configuration.				
16	SS responds with TRACKING AREA UPDATE ACCEPT message including a valid TAI list containing the TAI of Cell A; with PLMN ID of Cell A included in the GUTI. The UE sets the TIN = GUTI. Note: This Accept message includes EPS update result = combined TA/LA updated.	<--	TRACKING AREA UPDATE ACCEPT	-	-
17	The UE transmits a TRACKING AREA UPDATE COMPLETE message	-->	TRACKING AREA UPDATE COMPLETE	-	-
18	The SS releases the RRC Connection	-	-	-	-
19-28	Void	-	-	-	-
29	Check: Does UE transmit a LOCATION UPDATING REQUEST (on Cell 24 or Cell 5) and changes RAT. Check this until 7 minutes after step 3 in Table 9.2.3.3.5a.3.2-3 (when in GERAN) or 7 (when in UTRAN)	-->	LOCATION UPDATING REQUEST	1	F
30-36	Void	-	-	-	-

Table: 9.2.3.3.5a.3.2-2: Void

Table 9.2.3.3.5a.3.2-3: Parallel behaviour

St	Procedure	Message Sequence		TP	Verdict
		U - S	Message		
1	The UE transmits a LOCATION UPDATING REQUEST with location updating type set to "IMSI attach" on Cell 24 or Cell 5.	-->	LOCATION UPDATING REQUEST	-	-
2	The SS transmits a LOCATION UPDATING ACCEPT, and the UE stores the received LAI and sets the update status to UPDATED on the USIM. The SS allocates a TMSI.	<--	LOCATION UPDATING ACCEPT	-	-
3	The UE transmits a TMSI REALLOCATION COMPLETE message to acknowledge the TMSI allocation.	-->	TMSI REALLOCATION COMPLETE	-	-

9.2.3.3.5a.3.3 Specific message contents

Table 9.2.3.3.5a.3.3-1: Void

Table 9.2.3.3.5a.3.3-2: Message TRACKING AREA UPDATE REQUEST (step 11, table 9.2.3.3.5a.3.2-1)

Derivation path: 36.508 table 4.7.2-27			
Information Element	Value/Remark	Comment	Condition
EPS update type	001	combined TA/LA updating	
GPRS ciphering key sequence number	Any allowed value		
Old P-TMSI signature	Any allowed value		
Additional GUTI	Not present or any allowed value		
Nonce _{UE}	Any allowed value		

9.2.3.3.6 E-UTRAN RRC connection failure / Reselection of UTRAN cell / NAS signalling to release old S1 interface connection

9.2.3.3.6.1 Test Purpose (TP)

(1)

```
with { UE is E-UTRA RRC_CONNECTED state and ISR not activated }
ensure that {
  when { Radio link failure is detected and UE attempts to select a suitable E-UTRA cell to re-
establish the RRC connection }
  then { UE can not find a suitable cell for T311 and leaves RRC_CONNECTED state with release
cause 'RRC connection failure' }
```

(2)

```
with { UE searches for a suitable cell after an indication of E-UTRAN 'RRC connection failure' }
ensure that {
  when { UE detects an UTRA cell and returns to coverage }
  then { UE performs a routing area update }
```

9.2.3.3.6.2 Conformance requirements

References: The conformance requirements covered in the present TC are specified in: TS 24.008, clause 4.7.5, TS36.331 clauses 5.3.7.2, 5.3.11.1, 5.3.11.3 and 5.3.12 and TS36.304 clauses 5.2.7.

[TS24.008 clause 4.7.5]

This procedure is used for:

...

- in Iu mode and A/Gb mode after intersystem change from S1 mode, and the GMM receives an indication of "RRC connection failure" from lower layers due to lower layer failure while in S1 mode;

...

[TS 36.331 clause 5.3.7.2]

The UE shall only initiate the procedure when AS security has been activated. The UE initiates the procedure when one of the following conditions is met:

- 1> upon detecting radio link failure, in accordance with 5.3.11; or

...

Upon initiation of the procedure, the UE shall:

- 1> stop timer T310, if running;
- 1> start timer T311;
- 1> suspend all RBs except SRB0;
- 1> reset MAC;
- 1> apply the default physical channel configuration as specified in 9.2.4;
- 1> apply the default semi-persistent scheduling configuration as specified in 9.2.3;
- 1> apply the default MAC main configuration as specified in 9.2.2;
- 1> perform cell selection in accordance with the cell selection process as specified in TS 36.304 [4];

[TS 36.304 clause 5.3.11.1]

The UE shall:

- 1> upon receiving N310 consecutive "out-of-sync" indications from lower layers while neither T300, T301, T304 nor T311 is running;
- 2> start timer T310;

[TS 36.304 clause 5.3.11.3]

The UE shall:

- 1> upon T310 expiry; or
- 1> upon random access problem indication from MAC while neither T300, T301, T304 nor T311 is running; or
- 1> upon indication from RLC that the maximum number of retransmissions has been reached:
 - 2> consider radio link failure to be detected;
 - 2> if AS security has not been activated:
 - 3> perform the actions upon leaving RRC_CONNECTED as specified in 5.3.12, with release cause 'other';
 - 2> else:
 - 3> initiate the connection re-establishment procedure as specified in 5.3.7;

[TS36.331 clause 5.3.12]

Upon leaving RRC_CONNECTED, the UE shall:

- 1> reset MAC;
- 1> stop all timers that are running except T320;
- 1> release all radio resources, including release of the RLC entity, the MAC configuration and the associated PDCP entity for all established RBs;
- 1> indicate the release of the RRC connection to upper layers together with the release cause;
- 1> if leaving RRC_CONNECTED was not triggered by reception of the *MobilityFromEUTRACommand* message:
- 2> enter RRC_IDLE by performing cell selection in accordance with the cell selection process, defined for the case of leaving RRC_CONNECTED, as specified in TS 36.304 [4];

[TS 36.304 clause 5.2.7]

On transition from RRC_CONNECTED to RRC_IDLE, a UE shall attempt to camp on the last cell for which it was in RRC_CONNECTED or any cell on a frequency or frequency of RAT assigned by RRC in the state transition message. If no suitable cell is found, the UE shall perform a cell selection starting with Stored Information Cell Selection procedure in order to find a suitable cell to camp on.

When returning to idle mode after UE moved to RRC_CONNECTED state from camped on any cell state, UE shall attempt to camp on the last cell for which it was in RRC_CONNECTED state or any cell on a frequency or frequency of RAT assigned by RRC in the state transition message. If no acceptable cell is found, the UE shall continue to search for an acceptable cell of any PLMN in state *any cell selection*.

9.2.3.3.6.3 Test description

9.2.3.3.6.3.1 Pre-test conditions

System Simulator:

- cell A (belongs to TAI-1) is set to "Serving cell";
- cell 5 (belongs to RAI-1) is set to "Non-suitable cell";
- cell 5 belongs to a PLMN different from cell A's PLMN and not included in cell A's Equivalent PLMN list;
- system information indicates that NMO 1 is used.

- System information combination 1 as defined in TS 36.508[18] clause 4.4.3.1 is used in E-UTRA cells.

UE:

none.

Preamble:

- the UE is in state Generic RB established (state 3) on cell A according to TS 36.508 [18].

9.2.3.3.6.3.2 Test procedure sequence

Table 9.2.3.3.6.3.2-1: Main behaviour

St	Procedure	Message Sequence		TP	Verdict
		U - S	Message		
1	The SS changes the power level of Cell A to non-suitable "Off" according to TS 36.508 subclause 6.2.2.1 in order that the radio link quality of Cell A be degraded and waits for 1s (i.e. T310 transmitted in SIB2.) + additional 0.5s to ensure the UE detects the radio link failure	-	-	-	-
1A	The SS sets Cell A to "Non-suitable cell" and waits for 10s (i.e. T311 transmitted in SIB2)	-	-	-	-
2	The SS raises Cell 5 level as "Serving cell"	-	-	-	-
-	EXCEPTION: In parallel with step 3 below, the test steps in the parallel behaviour in table 9.2.3.3.6.3.2-2 is taking place	-	-	-	-
3	Check: Does the UE transmit a <i>RRConnectionReestablishmentRequest</i> messages within the next 60s?	-->	<i>RRConnectionReestablishmentRequest</i>	1	F
-	At the end of this test procedure sequence, the UE is in end state UTRA connected (U2) according to TS 36.508 but attached for EPS services only.	-	-	-	-

Table 9.2.3.3.6.3.2-2: Parallel behaviour

St	Procedure	Message Sequence		TP	Verdict
		U - S	Message		
1	Check: Does UE perform Routing area updating procedure on Cell 5? Note: No message contents other than message type needs checking.	-->	ROUTING AREA UPDATE REQUEST	2	P
2-5	The SS completes the routing area update procedure by performing Steps 5-8 of the procedure in TS 36.508 subclause 6.4.2.8.	-	-	-	-

9.2.3.3.6.3.3 Specific Message Contents

None

9.2.3.4 A/Gb mode to S1 mode inter-system change

9.2.3.4.1 TAU/RAU procedure for inter-system cell reselection between A/Gb and S1 modes

9.2.3.4.1.1 Test Purpose (TP)

(1)

with { UE attached to GERAN with a PDP context active, and, E-UTRAN NAS and Security parameters including a valid GUTI stored on the USIM }
ensure that {

```

when { UE performs a cell reselection to E-UTRAN and performs a Tracking Area Update }
then { the UE encodes the RRC parameters in the RRC Connection Establishment messages correctly
(i.e. in the RRCConnectionRequest message, the ue-Identity is set to "randomValue" and the
establishmentCause is set to MO-signalling; and, in the RRCConnectionSetupComplete message the
selectedPLMN-identity, mmegi and mmec indicate the value of the registered MME }
}

```

(2)

```

with { UE attached to GERAN with a PDP context active, and, E-UTRAN NAS and EPS Security parameters
including a valid GUTI stored on the USIM, and ISR not activated }
ensure that {
when { UE performs a cell reselection to E-UTRAN and performs a Tracking Area Update }
then { the UE encodes the parameters in the TRACKING AREA UPDATE REQUEST correctly i.e.:
- the NAS key set identifierASME IE is set to the value stored in the USIM/allocated in
the last TRACKING AREA UPDATE ACCEPT message;
- the Old GUTI IE is derived from the mapped P-TMSI and RAI;
- the Additional GUTI IE is set to the GUTI stored in the USIM/allocated in the last
TRACKING AREA UPDATE ACCEPT message;
- the GPRS ciphering key sequence number IE is set to the value allocated in the
AUTHENTICATION AND CIPHERING REQUEST message; and
- the NONCEue IE is included;
- the DRX parameter IE is not included. }
}

```

(3)

```

with { UE powered on in GERAN }
ensure that {
when { UE makes its first Tracking Area Update to E-UTRAN}
then { UE sends the UE radio capability information update needed IE }
}

```

(4)

```

with { UE registered in E-UTRAN, and, GERAN NAS and Security parameters including a valid P-TMSI
available in the UE and ISR not activated }
ensure that {
when { UE performs a cell reselection to GERAN and performs a Routeing Area Update }
then { the UE derives the TLLI parameter in the RLC/MAC header from the GUTI allocated in the
TRACKING AREA UPDATE ACCEPT message }
}

```

(5)

```

with { UE registered in E-UTRAN, and, GERAN NAS and GERAN Security parameters including a valid P-
TMSI available in the UE, and ISR not activated }
ensure that {
when { UE performs a cell reselection to GERAN and performs a Routeing Area Update }
then { the UE encodes the parameters in the ROUTING AREA UPDATE REQUEST correctly i.e.:
- [the GPRS ciphering key sequence number IE is set to the value mapped from
KSI-ASME;;] - the Old routing area identification IE, and the Old P-
TMSI signature IE are
mapped from the GUTI allocated in the TRACKING AREA UPDATE ACCEPT message;
- the Additional mobile identity IE contains the P-TMSI allocated in the last received
ATTACH ACCEPT/ROUTING AREA UPDATE ACCEPT message;
- the Additional old routing area identification IE contains the RAI allocated in the
last received ATTACH ACCEPT/ROUTING AREA UPDATE ACCEPT message; and
- [the DRX parameter IE is not included]. }
}

```

(6)

```

with { UE registered }
ensure that {
when { UE performs Tracking Area Update to E-UTRAN which is not for the "first TAU following
GERAN/UTRAN Attach" or for a "UE radio capability update"}
then { UE does not send the UE radio capability information update needed IE }
}

```

(7)

```

with { UE attached to GERAN with a PDP context active, and, E-UTRAN NAS and Security parameters
including a valid GUTI stored on the USIM }
ensure that {
  when { UE performs a cell reselection to E-UTRAN and performs a Tracking Area Update }
  then { the UE encodes the RRC parameters in the RRC Connection Establishment messages correctly
(i.e. in the RRCConnectionRequest message, the ue-Identity is set to S-TMSI or random value for pre-
Rel-12 UE, or set to random value from Rel-12 and onwards, and the establishmentcause is set to MO-
signalling; and, in the RRCConnectionSetupComplete message the registeredMME is not included when s-
TMSI is included, or include the registeredMME and the mapped GUMMEI otherwise }
}

```

9.2.3.4.1.2 Conformance requirements

References: The conformance requirements covered in the current TC are specified in: TS 23.003 clauses 2.8.2.1 and 2.8.2.2; TS 23.401 clauses 4.3.5.6, 5.3.3.1 and 5.3.3.3; TS 24.008 clauses 4.7.1.4.1 and 4.7.5.1.1; and TS 24.301 clauses 5.3.1.1 and 5.5.3.2.2.

[TS 23.003, clause 2.8.2.1 “Mapping from GUTI to RAI, P-TMSI and P-TMSI signature”]

The mapping of the GUTI shall be done to the combination of RAI of GERAN / UTRAN and the P-TMSI:

E-UTRAN <MCC> maps to GERAN/UTRAN <MCC>

E-UTRAN <MNC> maps to GERAN/UTRAN <MNC>

E-UTRAN <MME Group ID> maps to GERAN/UTRAN <LAC>

E-UTRAN <MME Code> maps to GERAN/UTRAN <RAC> and is also copied into the 8 most significant bits of the NRI field within the P-TMSI;

E-UTRAN <M-TMSI> maps as follows:

- 6 bits of the E-UTRAN <M-TMSI> starting at bit 29 and down to bit 24 are mapped into bit 29 and down to bit 24 of the GERAN/UTRAN <P-TMSI>;
- 16 bits of the E-UTRAN <M-TMSI> starting at bit 15 and down to bit 0 are mapped into bit 15 and down to bit 0 of the GERAN/UTRAN <P-TMSI>;
- and the remaining 8 bits of the E-UTRAN <M-TMSI> are mapped into the 8 MBS bits of the <P-TMSI signature> field.

For UTRAN, the 10-bit long NRI bits are masked out from the P-TMSI and also supplied to the RAN node as IDNNS (Intra Domain NAS Node Selector). However, the RAN configured NRI length should not exceed 8 bits.

[TS 23.003, clause 2.8.2.2 “Mapping from RAI and P-TMSI to GUTI”]

The mapping of P-TMSI (TLI) and RAI in GERAN/UTRAN to GUTI in E-UTRAN shall be performed as follows:

GERAN/UTRAN <MCC> maps to E-UTRAN <MCC>

GERAN/UTRAN <MNC> maps to E-UTRAN <MNC>

GERAN/UTRAN <LAC> maps to E-UTRAN <MME Group ID>

GERAN/UTRAN <RAC> maps into bit 23 and down to bit 16 of the M-TMSI

The 8 most significant bits of GERAN/UTRAN <NRI> map to the MME code.

GERAN/UTRAN <P-TMSI> maps as follows:

- 6 bits of the GERAN/UTRAN <P-TMSI> starting at bit 29 and down to bit 24 are mapped into bit 29 and down to bit 24 of the E-UTRAN <M-TMSI>;
- 16 bits of the GERAN/UTRAN <P-TMSI> starting at bit 15 and down to bit 0 are mapped into bit 15 and down to bit 0 of the E-UTRAN <M-TMSI>.

...

[TS 23.401, clause 4.3.5.6, "Idle mode signalling reduction function"]

The TIN can take one of the three values, "P-TMSI", "GUTI" or "RAT-related TMSI". The UE shall set the TIN when receiving an Attach Accept, a TAU Accept or RAU Accept message according to the rules in table 4.3.5.6-1.

Table 4.3.5.6-1: Setting of the TIN

Message received by UE	Current TIN value stored by UE	TIN value to be set by the UE when receiving message
Attach Accept via E-UTRAN (never indicates ISR activation)	Any value	GUTI
Attach Accept via GERAN/UTRAN (never indicates ISR activation)	Any value	P-TMSI
TAU Accept not indicating ISR	Any value	GUTI
TAU Accept indicating ISR	GUTI P-TMSI or RAT-related TMSI	GUTI RAT-related TMSI
RAU Accept not indicating ISR	Any value	P-TMSI
RAU Accept indicating ISR	P-TMSI GUTI or RAT-related TMSI	P-TMSI RAT-related TMSI

[TS 23.401, clause 5.3.3.1, step 2, "Tracking Area Update procedure with Serving GW change"]

....

If the UE's TIN indicates "P-TMSI" and the UE holds a valid P-TMSI and related RAI then these two elements are indicated as the old GUTI.

...

[TS 23.401, clause 5.3.3.3, step 2, "Routeing Area Update with MME interaction and without S-GW change"]

...

If the UE's internal TIN indicates "GUTI" and the UE holds a valid GUTI then the UE indicates the GUTI as the old P-TMSI and old RAI

...

[TS 24.008, clause 4.7.1.4.1, "Radio resource sublayer address handling (A/Gb mode only)"]

For an MS supporting S1 mode, the following five cases can be distinguished:

- a) the TIN indicates "P-TMSI" or "RAT-related TMSI" and the MS holds a valid P-TMSI and a RAI;
- b) the TIN indicates "GUTI" and the MS holds a valid GUTI;
- c) the TIN is deleted and the UE holds a valid P-TMSI and RAI;
- d) the TIN is deleted and the UE holds a valid GUTI, but no valid P-TMSI and RAI; or
- e) none of the previous cases is fulfilled.

In case a) the MS shall derive a foreign TLLI from the P-TMSI and proceed as specified for case i) above.

In case b), the MS shall derive a P-TMSI from the GUTI and then a foreign TLLI from this P-TMSI and proceed as specified for case i) above.

...

[TS 24.008, clause 4.7.5.1.1, "Normal and periodic routing area updating procedure initiation"]

To initiate the normal routing area updating procedure, the MS sends the message ROUTING AREA UPDATE REQUEST to the network, starts timer T3330 and changes to state GMM-ROUTING-AREA-UPDATING-INITIATED.

If the MS supports S1 mode, the MS shall handle the P-TMSI IE as follows:

- If the TIN indicates "GUTI" and the MS holds a valid GUTI, the MS shall map the GUTI into a P-TMSI, P-TMSI signature and RAI as specified in 3GPP TS 23.003 [4]. The MS shall include the mapped RAI in the Old routing area identification IE and the mapped P-TMSI signature in the P-TMSI signature IE. When the routing area updating procedure is initiated in Iu mode, the MS shall also include the mapped P-TMSI in the P-TMSI IE. Additionally, in Iu mode and A/Gb mode, if the MS holds a valid P-TMSI and RAI, the MS shall indicate the P-TMSI in the Additional mobile identity IE and the RAI in the Additional old routing area identification IE.
- If the TIN indicates "P-TMSI" or "RAT-related TMSI" and the MS holds a valid P-TMSI and RAI, the MS shall indicate the RAI in the Old routing area identification IE. When the routing area updating procedure is initiated in Iu mode, the MS shall also include the P-TMSI in the P-TMSI IE.

If the routing area updating procedure is not initiated by the MS due to an S1 mode to Iu mode or S1 mode to A/Gb mode intersystem change, the message ROUTING AREA UPDATE REQUEST shall contain the P-TMSI signature when received within a previous ATTACH ACCEPT or ROUTING AREA UPDATE ACCEPT message.

If the routing area updating procedure is initiated by the MS due to an S1 mode to Iu mode or S1 mode to A/Gb mode inter-system change in idle mode and the MS does not have a valid current UMTS security context, the message ROUTING AREA UPDATE REQUEST shall include a P-TMSI signature filled with a NAS token as specified in 3GPP TS 33.401 [119]. If the MS has a valid current UMTS security context, the MS shall indicate it in the GPRS ciphering key sequence number IE.

NOTE: If the TIN indicates "GUTI", 8 bits of the NAS token will be filled with bits from the M-TMSI (see 3GPP TS 23.003 [4]).

If the routing area updating procedure is initiated by the MS due to the S1 mode to Iu mode or S1 mode to A/Gb mode inter-system change in connected mode or in idle mode if the MS does not have a valid current security context, the MS shall derive CK' and IK' from the K_{ASME} and the NAS downlink COUNT value corresponding to the NAS token derived as specified in 3GPP TS 33.401 [119]. The MS shall indicate the eKSI value in the CKSN field of the GPRS ciphering key sequence number IE in the ROUTING AREA UPDATE REQUEST message. Then, the MS shall reset the START value and store the mapped UMTS security context replacing the current UMTS security context.

...

In order to indicate the new DRX parameter while in GERAN or UTRAN coverage, the MS shall send the ROUTING AREA UPDATE REQUEST message containing the DRX parameter in the DRX parameter IE to the network, with the exception of the case if the MS had indicated its UE specific DRX parameter (3GPP TS 24.301 [120]) to the network while in E-UTRAN coverage. In this case, when the MS enters GERAN or UTRAN coverage and initiates a routing area updating procedure, the MS shall not include the DRX parameter in the DRX parameter IE in the ROUTING AREA UPDATE REQUEST message.

[TS 24.008, clause 4.7.5.1.3, "Normal and periodic routing area updating procedure accepted by the network"]

If the MS has indicated in the ROUTING AREA UPDATE REQUEST message that it supports PS inter-RAT HO from GERAN to E-UTRAN, the network may include in the ROUTING AREA UPDATE ACCEPT message a request to provide the E-UTRAN inter RAT information container.

[TS 24.301, clause 5.3.1.1 "Establishment of the NAS signalling connection"]

For the routing of the initial NAS message to the appropriate MME, the UE NAS provides the lower layers with either the S-TMSI or the registered globally unique MME identifier (GUMMEI) that consists of the PLMN ID, the MME group ID, and the MME code (see 3GPP TS 23.003 [2]).

- When the UE is registered in the tracking area of the current cell during the NAS signalling connection establishment, the UE NAS shall provide the lower layers with the S-TMSI, but shall not provide the registered MME identifier to the lower layers. Exceptionally, when the UE in EMM-IDLE mode initiates a tracking area updating procedure for load balancing purposes, the UE NAS shall provide the lower layers with neither S-TMSI nor registered MME identifier.
- When the UE is not registered in the tracking area of the current cell during the NAS signalling connection establishment, the UE NAS does not provide the lower layers with the S-TMSI. If the UE has a valid registered MME identifier from a previous registration, the UE NAS shall provide the lower layers with the registered MME identifier.

[TS 24.301, clause 5.5.3.2.2 “Normal and periodic tracking area updating procedure initiation”]

...

In order to indicate its UE specific DRX parameter while in E-UTRAN coverage, the UE shall send the TRACKING AREA UPDATE REQUEST message containing the UE specific DRX parameter in the DRX parameter IE to the network, with the exception of the case if the UE had indicated its DRX parameter (3GPP TS 24.008 [13]) to the network while in GERAN or UTRAN coverage. In this case, when the UE enters E-UTRAN coverage and initiates a tracking area updating procedure, the UE shall not include the UE specific DRX parameter in the DRX parameter IE in the TRACKING AREA UPDATE REQUEST message.

...

When initiating a tracking area updating procedure as a result of an Iu mode to S1 mode or A/Gb mode to S1 mode inter-system change, the UE shall handle the GUTI as follows:

- if the TIN indicates "P-TMSI" and the UE holds a valid P-TMSI and RAI, the UE shall map the P-TMSI and RAI into the old GUTI IE. Additionally, if the UE holds a valid GUTI, the UE shall indicate the GUTI in the Additional GUTI IE.

NOTE: Mapping the P-TMSI and RAI to the GUTI is specified in Annex H of 3GPP TS 23.401 [10].

- if the TIN indicates "GUTI" or "RAT-related TMSI" and the UE holds a valid GUTI, the UE shall indicate the GUTI in the Old GUTI IE.

...

When the tracking area updating procedure is initiated to perform an inter-system change from A/Gb mode or Iu mode to S1 mode, the UE shall include the KSI_{ASME} in the TRACKING AREA UPDATE REQUEST message if the UE has a cached EPS security context. Otherwise, the UE shall set the KSI_{ASME} to the value "no key is available".

When the tracking area updating procedure is initiated in EMM-IDLE mode to perform an inter-system change from A/Gb mode or Iu mode to S1 mode, the UE shall include the KSI_{SGSN} in the TRACKING AREA UPDATE REQUEST message. If the UE does not have a cached EPS security context, the UE shall include the $Nonce_{UE}$ IE in the TRACKING AREA UPDATE REQUEST message. The TRACKING AREA UPDATE REQUEST message shall be integrity protected with the cached EPS security context if the UE has one. If the UE does not have a cached EPS security context, the TRACKING AREA UPDATE REQUEST message shall not be integrity protected.

...

When the tracking area updating procedure is initiated in EMM-IDLE mode to perform an inter-system change from A/Gb mode or Iu mode to S1 mode, the UE shall include the KSI_{SGSN} in the TRACKING AREA UPDATE REQUEST message. If the UE does not have a cached EPS security context, the UE shall include the $Nonce_{UE}$ IE in the TRACKING AREA UPDATE REQUEST message. The TRACKING AREA UPDATE REQUEST message shall be integrity protected with the cached EPS security context if the UE has one. If the UE does not have a cached EPS security context, the TRACKING AREA UPDATE REQUEST message shall not be integrity protected.

...

If the UE initiates the first tracking area updating procedure following an attach in A/Gb mode or Iu mode, the UE shall include a UE radio capability information update needed IE in the TRACKING AREA UPDATE REQUEST message.

...

[TS 24.301, clause 4.4.2 “Handling of EPS security contexts”]

...

The key set identifier eKSI is assigned by the MME either during the authentication procedure or, for the mapped security context, during the handover procedure. The eKSI consists of a value and a type of security context parameter indicating whether an EPS security context is a native EPS security context or a mapped EPS security context. When the EPS security context is a native EPS security context, the eKSI has the value of KSI_{ASME} , and when the current EPS security context is a mapped EPS security context, the eKSI has the value of KSI_{SGSN} .

...

[TS 24.301, clause 5.3.1.1 "Establishment of the NAS signalling connection"]

b) if the TIN indicates "P-TMSI" and the UE holds a valid P-TMSI and RAI, the UE NAS shall provide the lower layers with the MME identifier part of the mapped GUTI, which is generated from the P-TMSI and RAI.

9.2.3.4.1.3 Test description

9.2.3.4.1.3.1 Pre-test conditions

System Simulator:

NOTE: while this test describes the uses of 3 cells, it is intended that this test only requires 2 cells to be active at any one instant.

- cell A (E-UTRAN), cell B (E-UTRAN), cell 24 and cell 26 (GERAN)
- with the exception of the MCC and MNC, cell 24 and cell 26 take the default parameters of the GERAN cells as defined in clause 6.3.1 of TS 36.508 [18], cells 24 and 26 are configured with the same MCC and MNC as cell A. Cells 24 and 26 are in the same routing area;
- as defined in clause 40.1 of TS 51.010 [23], the GERAN cells are configured to use Network Mode of Operation I;
- the power level of Cell 24 is the Serving Cell level;
- the power level of Cell A is set to the Non-suitable level;
- the power level of Cell B is set to the Non-suitable " Off" level;
- the power level of Cell 26 is set to the Non-suitable Off.
- System information combination 5 as defined in TS 36.508[18] clause 4.4.3.1 is used in E-UTRA cells.

UE:

- the UE was previously registered on E-UTRAN cell B, and when on E-UTRAN, the UE was last authenticated and registered on a cell (no name assigned) frequency 2 belonging to a PLMN with (MCC, MNC) = (65, 987) and allocated a GUTI with (MMEGI, MMEC) = (0xfedc, 0xba) and an arbitrary M-TMSI value.

Preamble:

- the UE is in state Switched OFF (state 1) according to TS 36.508 [18].

9.2.3.4.1.3.2 Test procedure sequence

Table 9.2.3.4.1.3.2-1: Main behaviour

St	Procedure	Message Sequence		TP	Verdict
		U – S	Message		
1	The UE is switched on.	-	-	-	-
2	The UE transmits an ATTACH REQUEST message on Cell 24	-->	ATTACH REQUEST	-	-
3	The SS transmits an AUTHENTICATION REQUEST message.	<--	AUTHENTICATION REQUEST	-	-
4	The UE transmits an AUTHENTICATION RESPONSE message.	-->	AUTHENTICATION RESPONSE	-	-
5	The SS transmits a NAS SECURITY MODE COMMAND message	<--	SECURITY MODE COMMAND	-	-
6	The UE transmits a NAS SECURITY MODE COMPLETE message ciphered with the new EPS security context identified by the KSI_{ASME} received in the SECURITY MODE COMMAND message in step 5	-->	SECURITY MODE COMPLETE	-	-
8	SS responds with ATTACH ACCEPT message including valid TMSI, P-TMSI (TIN set to P-TMSI) and RAI. Editor's Note: the default message contents in 51.010 clause 40.2.4.3 allocate a Negotiated READY timer value of 32 seconds.	<--	ATTACH ACCEPT	-	-
9	The UE transmits an ATTACH COMPLETE message.	-	ATTACH COMPLETE	-	-
9A	The activation of a PDP context is triggered by MMI or AT command.	-	-	-	-
9B	The UE transmits an ACTIVATE PDP CONTEXT REQUEST message	-->	ACTIVATE PDP CONTEXT REQUEST	-	-
9C	The SS responds with an ACTIVATE PDP CONTEXT ACCEPT message	<--	ACTIVATE PDP CONTEXT ACCEPT	-	-
10	Void	-	-	-	-
11	Void	-	-	-	-
12	Void	-	-	-	-
13	The signal strength of Cell A is raised to that of the Serving Cell and that of Cell 24 is lowered to that of a Suitable Neighbour Cell. Note: Cell 24 is still suitable but the UE is expected to select Cell A.	-	-	-	-
14	Void	-	-	-	-
15	Check: Does the UE send an RRCConnectionRequest with the <i>ue-Identity</i> set to "randomValue" and the <i>establishmentCause</i> set to <i>MO-signalling</i> on Cell A? Editor's Note: Cell reselection to E-UTRAN might not occur until the GPRS READY timer has expired. Hence this step might occur up to 40 seconds after step 13.	-->	RRCConnectionRequest	1	P
16	The SS responds with RRCConnectionSetup	<--	RRCConnectionSetup		
17	Check: Does the UE send an RRCConnectionSetupComplete with the <i>mmei</i> and <i>mmecc</i> set to the values derived from the mapped RAI and P-TMSI Check: Are the contents of the TRACKING AREA UPDATE REQUEST with the correct parameters?	-->	RRCConnectionSetupComplete(RRC parameters, TRACKING AREA UPDATE REQUEST)	1, 2, 3	P
18	The SS sends TRACKING AREA UPDATE ACCEPT	<--	TRACKING AREA UPDATE ACCEPT	-	-

	Note: the default message contents cause the allocation of a new GUTI and new TAI list				
19	The UE sends TRACKING AREA UPDATE COMPLETE	-->	TRACKING AREA UPDATE COMPLETE	-	-
20	The SS releases the RRC connection	-	-	-	-
21	Cell 24 is switched off	-	-	-	-
22	The signal strength of Cell 26 is raised to that of the Serving Cell and that of Cell A is lowered to that of a Non suitable Neighbour Cell. Note: Cell A is still suitable but the UE is expected to select Cell 26.	-	-	-	-
23	Check: Does the UE send on Cell 26 an RLC/MAC header with the TLLI derived from the P-TMSI that is derived from the GUTI allocated in step 18?	-	-	4	P
24	Check: Does the UE send on Cell 26 a ROUTING AREA UPDATE REQUEST with the correct parameters?	-->	ROUTING AREA UPDATE REQUEST	5	P
24 A	The SS transmits an AUTHENTICATION AND CIPHERING REQUEST message.	<--	AUTHENTICATION AND CIPHERING REQUEST	-	-
24 B	The UE transmits an AUTHENTICATION AND CIPHERING RESPONSE message.	-->	AUTHENTICATION AND CIPHERING RESPONSE	-	-
25	The SS sends ROUTING AREA UPDATE ACCEPT (without the allocated P-TMSI IE, but with the Requested MS Information IE indicating "E-UTRAN inter RAT information container IE requested in case UE supports PS inter-RAT HO from GERAN to E-UTRAN").	<--	ROUTING AREA UPDATE ACCEPT	-	-
-	EXCEPTION: Step 26 describes behaviour that depends on the UE capability.	-	-	-	-
26	IF <i>pc_GERAN_2_E_UTRAN_PSHO</i> , then the UE sends ROUTING AREA UPDATE COMPLETE message	-->	ROUTING AREA UPDATE COMPLETE	-	-
27	The signal strength of Cell A is raised to that of the Serving Cell and that of Cell 26 is lowered to that of a Suitable Neighbour Cell. Note: Cell 26 is still suitable but the UE is expected to select Cell A.	-	-	-	-
27 A	Check: Does the UE send an RRCConnectionRequest with the <i>ue-Identity</i> set for Rel-8 to Rel-11 UE to <i>s-TMSI</i> or <i>randomValue</i> , and, for Rel-12 and onwards UE set to <i>randomValue</i> ?	-->	RRCConnectionRequest	7	P
27 B	The SS responds with RRCConnectionSetup	<--	RRCConnectionSetup		
28	Check: Does the UE send on Cell A an RRCConnectionSetupComplete without the registeredMME when <i>s-TMSI</i> is included in step 27A, otherwise with the registeredMME and the mapped GUMMEI? Check: Does the UE send a TRACKING AREA UPDATE REQUEST with the correct parameters?	-->	RRCConnectionSetupComplete(RRC parameters, TRACKING AREA UPDATE REQUEST)	7 2, 6	P
29	The SS sends TRACKING AREA UPDATE ACCEPT Note: the default message contents cause the allocation of a new GUTI.	<--	TRACKING AREA UPDATE ACCEPT	-	-
30	The UE sends TRACKING AREA UPDATE COMPLETE	-->	TRACKING AREA UPDATE COMPLETE	-	-
-	At the end of this test procedure sequence, the UE is in end state E-UTRA connected	-	-	-	-

(E2_T3440) according to TS 36.508.			
------------------------------------	--	--	--

9.2.3.4.1.3.3 Specific message contents

Table 9.2.3.4.1.3.3-1: Message RRCConnectionRequest (step 15, Table 9.2.3.4.1.3.2-1)

Derivation path: 36.508 table 4.6.1-16			
Information Element	Value/Remark	Comment	Condition
InitialUE-Identity CHOICE {			
random-Value	Any allowed value		
}			
establishmentCause	Mo-Signalling		

Table 9.2.3.4.1.3.3-2: Message RRCConnectionSetupComplete (step 17, Table 9.2.3.4.1.3.2-1)

Derivation path: 36.508 table 4.6.1-18			
Information Element	Value/remark	Comment	Condition
RRCConnectionSetupComplete ::= SEQUENCE {			
rrc-TransactionIdentifier	RRC-TransactionIdentifier-UL		
criticalExtensions CHOICE {			
c1 CHOICE {			
rrcConnectionSetupComplete-r8 SEQUENCE {			
selectedPLMN-Identity	Indicates the PLMN of cell A.		
registeredMME SEQUENCE {			
plmn-Identity	Not Checked		
Mmegi	LAC sent to the UE in step 8		
Mmec	Bit 23 to bit 16 of P-TMSI sent to the UE in step 8		
}			
nas-DedicatedInformation	Not checked at RRC layer		
nonCriticalExtension SEQUENCE {}	Not checked		
}			
}			
}			

Table 9.2.3.4.1.3.3-3: Message TRACKING AREA UPDATE REQUEST (step 17, Table 9.2.3.4.1.3.2-1)

Derivation path: 36.508 table 4.7.2-27			
Information Element	Value/Remark	Comment	Condition
Sent in SECURITY PROTECTED NAS MESSAGE with valid integrity check			
NAS key set identifier _{ASME}			
NAS key set identifier	The valid NAS key set identifier KSI _{ASME} of the UE	As stored on the USIM in EF _{EPSNSC}	
TSC	'0'B	native security context	
Old GUTI	Mapped from the P-TMSI and RAI allocated in step 8		
Additional GUTI	GUTI1	Set to the value stored in the USIM in EF _{EPSLOCI}	
DRX parameter	Not present		
UE radio capability information update needed	'1'B	UE radio capability information update needed	
GPRS ciphering key sequence number	Value mapped from the AUTHENTICATION AND CIPHERING REQUEST message		
Old Ptmsi Signature	Any Value		
Nonce	Any Value		

Table 9.2.3.4.1.3.3-4: Message ROUTING AREA UPDATE REQUEST (step 24, Table 9.2.3.4.1.3.2-1)

Derivation path: 24.008 table 9.4.14			
Information Element	Value/Remark	Comment	Condition
Protocol discriminator	GMM		
Skip indicator	'0000'		
Routing area update request message identity	'0000 1000' B		
Update type	Any allowed value		
GPRS ciphering key sequence number	set to the value to KSI-ASME	With ISR inactive and TIN indicates GUTI, then eKSI value is set to KSI-ASME	
Old routing area identification	Mapped from the GUTI received in step 18.		
MS Radio Access capability	Any allowed value		
Old P-TMSI signature	Mapped from the GUTI received in step 18.		
Requested READY timer value	If present, any allowed value.		
DRX parameter	Not present	Shall be absent	
TMSI status	If present, any allowed value.		
P-TMSI	Not present		
MS network capability	Any allowed value.		
PDP context status	If present, any allowed value.		
PS LCS Capability	If present, any allowed value.		
MBMS context status	If present, any allowed value.		
UE network capability	Any allowed value.		
Additional mobile identity	Set to the P-TMSI allocated in step 8		
Additional old routing area identification	Set to the RAI allocated		

	in step 8		
Mobile station classmark 2	If present, any allowed value.		
Mobile station classmark 3	If present, any allowed value.		
Supported Codecs	If present, any allowed value.		

Table 9.2.3.4.1.3.3-5: Message ROUTING AREA UPDATE ACCEPT (step 25, Table 9.2.3.4.1.3.2-1)

Derivation path: 24.008 table 9.4.15			
Information Element	Value/Remark	Comment	Condition
allocated P-TMSI	Absent		
Requested MS Information	'0100' B	E-UTRAN inter RAT information container IE requested	pc_GERAN_2_E_UTRAN_PSHO

Table 9.2.3.4.1.3.3-6: Message ROUTING AREA UPDATE COMPLETE (step 26, Table 9.2.3.4.1.3.2-1)

Derivation path: 24.008 table 9.4.16			
Information Element	Value/Remark	Comment	Condition
E-UTRAN inter RAT handover information	Any allowed value		

Table 9.2.3.4.1.3.3-6A: Message RRCConnectionRequest (step 27A, Table 9.2.3.4.1.3.2-1)

Derivation path: 36.508 table 4.6.1-16			
Information Element	Value/Remark	Comment	Condition
ue-Identity CHOICE { s-TMSI	Received from NAS layer	Rel-8 to Rel-11 inclusive	
randomValue	Any allowed value	Rel-8 and onwards	
}			
establishmentCause	Mo-Signalling		

Table 9.2.3.4.1.3.3-7: Message RRCConnectionSetupComplete (step 28, Table 9.2.3.4.1.3.2-1)

Derivation path: 36.508 table 4.6.1-18			
Information Element	Value/remark	Comment	Condition
RRCConnectionSetupComplete ::= SEQUENCE {			
Rrc-TransactionIdentifier	RRC-TransactionIdentifier-UL		
criticalExtensions CHOICE {			
C1 CHOICE {			
rrcConnectionSetupComplete-r8 SEQUENCE {			
selectedPLMN-Identity	Indicates the PLMN of cell 24.		
registeredMME	Not present	Shall be absent if the upper layers provided S-TMSI in <i>RRCConnectionRequest</i> message in step 27A for pre-Rel-12 UE	
registeredMME	generated from the P-TMSI and RAI	Present only when the InitialUE-Identity in step 27A is set to randomValue	
nas-DedicatedInformation	Not checked at RRC layer		
nonCriticalExtension SEQUENCE {			
nonCriticalExtension SEQUENCE {			
gummei-Type-r10	mapped	Present when the registeredMME is included,	
}			
}			
}			
}			
}			

Table 9.2.3.4.1.3.3-8: Message TRACKING AREA UPDATE REQUEST (step 28, Table 9.2.3.4.1.3.2-1)

Derivation path: 36.508 table 4.7.2-27			
Information Element	Value/Remark	Comment	Condition
Sent in SECURITY PROTECTED NAS MESSAGE with valid integrity check			
EPS update type	000	TA updating	TA_only
	010	combined TA/LA updating with IMSI attach	combined_TA_LA
NAS key set identifier _{ASME}			
NAS key set identifier	The valid NAS key set identifier KSI _{ASME} of the UE	As stored on the USIM in EF _{EPSNSC} in the pre-test conditions	
TSC	'0'B	native security context	
Old GUTI	Mapped from the P-TMSI allocated in Step 8 and RAI allocated in		
Additional GUTI	GUTI1	Set to the value allocated in step 18	
DRX parameter	Not present		
UE radio capability information update needed	Not present		
Old Ptmsi Signature	Any Value		
Nonce	Any Value		

9.3 EMM connection management procedures (S1 mode only)

9.3.1 Service request procedure

9.3.1.1 Service request initiated by UE for user data

9.3.1.1.1 Test Purpose (TP)

(1)

```

with { UE in EMM-REGISTERED state and EMM-IDLE mode }
ensure that {
  when { UE has user data pending }
  then { UE establishes the RRC connection with the RRC establishmentCause set to 'mo-Data' and
sends a SERVICE REQUEST message }
}

```

9.3.1.1.2 Conformance requirements

The conformance requirements covered in the current TC are specified in: TS 24.301 clauses 5.3.1.1, 5.1.3.2.2.4, 5.3.1.1, 5.6.1.1, 5.6.1.2, 5.6.1.4 and Annex D and TS 36.331 clause 5.3.3.3.

[TS 24.301 clause 5.3.1.1]

When the UE is in EMM-IDLE mode and needs to transmit an initial NAS message, the UE shall request the lower layer to establish a NAS signalling connection. In this request to the lower layer the NAS shall provide to the lower layer the RRC establishment cause and the call type as specified in annex D of this specification.

[TS 24.301 clause 5.1.3.2.2.4]

In the state EMM-REGISTERED an EMM context has been established and a default EPS bearer context has been activated in the UE.

...

The UE may initiate sending and receiving user data and signalling information and reply to paging. Additionally, tracking area updating procedure is performed (see subclause 5.5.3).

[TS 24.301 clause 5.3.1.1]

In S1 mode, when the RRC connection has been established successfully, the UE shall enter EMM-CONNECTED mode and consider the NAS signalling connection established.

[TS 24.301 clause 5.6.1.1]

The purpose of the service request procedure is to transfer the EMM mode from EMM-IDLE to EMM-CONNECTED mode and establish the radio and S1 bearers when uplink user data or signalling is to be sent.

...

The UE shall invoke the service request procedure when:

....

- b) the UE, in EMM-IDLE mode, has pending user data to be sent;

[TS 24.301 clause 5.6.1.2]

If the UE has pending uplink data or uplink signalling in EMM-IDLE mode to be transmitted or it responds to paging with CN domain indicator set to "PS", the UE initiates the service request procedure by sending a SERVICE REQUEST message to the MME, starts the timer T3417, and enters the state EMM-SERVICE-REQUEST-INITIATED.

[TS 24.301 clause 5.6.1.4]

For cases a, b and c in subclause 5.6.1.1, the UE shall treat the indication from the lower layers that the user plane radio bearer is set up as successful completion of the procedure.

....

Upon successful completion of the procedure, the UE shall stop the timer T3417 and enter the state EMM-REGISTERED.

[TS 24.301, Annex D]

...

Table D.1.1: Mapping of NAS procedure to establishment cause and call type

NAS procedure	RRC establishment cause (according 3GPP TS 36.331 [22])	Call type
...		
Service Request	If a SERVICE REQUEST is to request user plane radio resources, the RRC establishment cause shall be set to MO data. (See Note1)	"originating calls"
	If a SERVICE REQUEST is to request resources for UL signalling, the RRC establishment cause shall be set to MO data. (See Note 1)	"originating calls"
Note 1: For these NAS procedures initiated by UEs of access class 12, 13 or 14 in their home country, the RRC establishment cause will be set to "High priority access AC 11 – 15". For this purpose the home country is defined as the country of the MCC part of the IMSI, see 3GPP TS 22.011 [1A]. For these NAS procedures initiated by UE of access class 11 or 15 in their HPLMN or EHPLMN, the RRC establishment cause will be set to "High priority access AC 11 – 15".		

[TS 36.331, clause 5.3.3.3]

...

The UE shall set the contents of *RRCCConnectionRequest* message as follows:

- 1> set the *ue-Identity* as follows:
 - 2> if upper layers provide an S-TMSI:
 - 3> set the *ue-Identity* to the value received from upper layers;

2> else

3> draw a random value and set the *ue-Identity* to this value;

NOTE 1 Upper layers provide the S-TMSI if the UE is registered in the TA of the current cell.

1> Set the *establishmentCause* in accordance with the information received from upper layers;

9.3.1.1.3 Test description

9.3.1.1.3.1 Pre-test conditions

System Simulator:

- cell A.

UE:

none.

Preamble:

- the UE is in state Loopback Activated (State 4) according to TS 36.508 [18] using the specific message content for ACTIVATE TEST MODE and CLOSE UE TEST LOOP messages in table 9.3.1.1.3.3-1 and table 9.3.1.1.3.3-2.

9.3.1.1.3.2 Test procedure sequence

Table 9.3.1.1.3.2-1: Main behaviour

St	Procedure	Message Sequence		TP	Verdict
		U - S	Message		
1	The SS transmits one IP Packet to the UE.	<--	IP packet	-	-
2	The SS waits 1 second after the IP packet has been transmitted in step 1 and then transmits an <i>RRCCConnectionRelease</i> message. (Note 2)	-	-	-	-
3	Check: Does the UE transmit an <i>RRCCConnectionRequest</i> message with <i>establishmentCause</i> set to 'mo-Data' followed by a SERVICE REQUEST message? (Note 1)	-->	SERVICE REQUEST	1	P
4-7	Steps 6 to 9 of the generic radio bearer establishment procedure (TS 36.508 4.5.3.3-1) are executed to successfully complete the service request procedure.	-	-	-	-
Note 1: Triggered when timer T_delay_modeB (IP PDU delay time) expires and pending uplink data exist in buffered PDCP SDUs according to [25] clause 5.4.4.3. Note 2: The 1 second delay is used to secure that the UE have received and forwarded the IP Packet transmitted by the SS in step 1 to the UE test loop function before the <i>RRCCConnectionRelease</i> message is sent by the SS in step 2.					

9.3.1.1.3.3 Specific message contents

Table 9.3.1.1.3.3-1: ACTIVATE TEST MODE (preamble)

Derivation Path: 36.508, Table 4.7A-1, condition UE TEST LOOP MODE B

Table 9.3.1.1.3.3-2: CLOSE UE TEST LOOP (preamble)

Derivation Path: 36.508, Table 4.7A-3, condition UE TEST LOOP MODE B			
Information Element	Value/remark	Comment	Condition
UE test loop mode B LB setup			
IP PDU delay	0 0 0 0 0 1 0 1	5 seconds	

Table 9.3.1.1.3.3-3: Message *RRCConnectionRequest* (step 3, Table 9.3.1.1.3.2-1)

Derivation path: 36.508 table 4.6.1-16			
Information Element	Value/Remark	Comment	Condition
RRCConnectionRequest ::= SEQUENCE {			
criticalExtensions CHOICE {			
rrcConnectionRequest-r8 SEQUENCE {			
establishmentCause	mo-Data		
}			
}			
}			

9.3.1.2 Void

9.3.1.3 Service request / Mobile originating CS fallback

9.3.1.3.1 Test Purpose (TP)

(1)

```
with { UE in state EMM-REGISTERED and EMM-CONNECTED mode}
ensure that {
  when { UE initiates mobile originating CS fallback }
  then { UE sends EXTENDED SERVICE REQUEST message }
}
```

(2)

```
with { UE in state EMM-REGISTERED and EMM-IDLE mode}
ensure that {
  when { UE initiates mobile originating CS fallback }
  then { UE establishes the RRC connection with the RRC establishmentCause set to 'mo-Data' and
        sends EXTENDED SERVICE REQUEST message }
}
```

9.3.1.3.2 Conformance requirements

References: The conformance requirements covered in the present TC are specified in: 3GPP TS 24.301 clauses 5.3.1.1, 5.6.1.1, 5.6.1.2 and Annex D and TS 36.331 clause 5.3.3.3.[TS 24.301 clause 5.3.1.1]

When the UE is in EMM-IDLE mode and needs to transmit an initial NAS message, the UE shall request the lower layer to establish a NAS signalling connection. In this request to the lower layer the NAS shall provide to the lower layer the RRC establishment cause and the call type as specified in annex D of this specification.

[TS24.301 clause5.6.1.1]

The purpose of the service request procedure is to transfer the EMM mode from EMM-IDLE to EMM-CONNECTED mode and establish the radio and S1 bearers when uplink user data or signalling is to be sent. Another purpose of this procedure is to invoke MO/MT CS fallback procedures.

This procedure is used when:

...

- the UE in EMM-IDLE or EMM-CONNECTED mode has requested to perform mobile originating/terminating CS fallback; or

...

The service request procedure is initiated by the UE, however, for the downlink transfer of signalling or user data in EMM-IDLE mode, the trigger is given by the network by means of the paging procedure (see subclause 5.6.2).

The UE shall invoke the service request procedure when:

...

- d) the UE, in EMM-IDLE or EMM-CONNECTED mode, has a mobile originating CS fallback request;

...

[TS24.301 clause 5.6.1.2]

If the UE has pending uplink data or uplink signalling in EMM-IDLE mode to be transmitted or it responds to paging with CN domain indicator set to "PS", the UE initiates the service request procedure by sending a SERVICE REQUEST message to the MME, starts the timer T3417, and enters the state EMM-SERVICE-REQUEST-INITIATED.

The UE shall send an EXTENDED SERVICE REQUEST message,

- regardless of the EMM mode, if the UE has a mobile originating CS fallback request; and

...

[TS24.301 clause 5.6.1.5]

#39 (CS domain temporarily not available);

The UE shall start timer T3442 and shall set the EPS update status to EU2 NOT UPDATED (and shall store it according to subclause 5.1.3.3). The UE shall enter the state EMM-REGISTERED.NORMAL-SERVICE.

The UE shall not try to send an EXTENDED SERVICE REQUEST message for mobile originating services to the network until timer T3442 expires or the UE sends a TRACKING AREA UPDATE REQUEST message.

...

[TS 24.301, Annex D]

...

Table D.1.1: Mapping of NAS procedure to establishment cause and call type

NAS procedure	RRC establishment cause (according 3GPP TS 36.331 [22])	Call type
...		
Service Request	If a EXTENDED SERVICE REQUEST has service type set to "mobile originating CS fallback", the RRC establishment cause shall be set to MO data. (See Note1).	"originating calls"
...		
Note 1: For these NAS procedures initiated by UEs of access class 12, 13 or 14 in their home country, the RRC establishment cause will be set to "High priority access AC 11 – 15". For this purpose the home country is defined as the country of the MCC part of the IMSI, see 3GPP TS 22.011 [1A]. For these NAS procedures initiated by UE of access class 11 or 15 in their HPLMN or EHPLMN, the RRC establishment cause will be set to "High priority access AC 11 – 15".		

[TS 36.331, clause 5.3.3.3]

...

The UE shall set the contents of *RRCConnectionRequest* message as follows:

- 1> set the *ue-Identity* as follows:
 - 2> if upper layers provide an S-TMSI:
 - 3> set the *ue-Identity* to the value received from upper layers;
 - 2> else
 - 3> draw a random value and set the *ue-Identity* to this value;

NOTE 1: Upper layers provide the S-TMSI if the UE is registered in the TA of the current cell.

- 1> Set the *establishmentCause* in accordance with the information received from upper layers;

9.3.1.3.3 Test description

9.3.1.3.3.1 Pre-test conditions

System Simulator:

- cell A.

UE:

none.

Preamble:

- the UE is in state Generic RB established (state 3) on cell A according to TS 36.508 [18].

9.3.1.3.3.2 Test procedure sequence

Table 9.3.1.3.3.2-1: Main behaviour

St	Procedure	Message Sequence		TP	Verdict
		U - S	Message		
1	Force the UE to initiate CS Voice call. (Note 1)	-		-	-
2	Check: Does the UE transmit EXTENDED SERVICE REQUEST message?	-->	EXTENDED SERVICE REQUEST	1	P
3	The SS sends SERVICE REJECT message with T3442 = 60 seconds in order that the UE enters EMM-REGISTERED.NORMAL-SERVICE.	<--	SERVICE REJECT	-	-
4	The SS releases the RRC connection	--		-	-
-	EXCEPTION: The behaviour in table 9.3.1.3.3.2-2 may occur in parallel with step 4A.	-	-	-	-
4A	SS waits for 60 seconds (T3442)	-	-	-	-
5	Force the UE to initiate CS Voice call. (Note1)	-		-	-
6	Check: Does the UE transmit an <i>RRCConnectionRequest</i> message with <i>establishmentCause</i> set to 'mo-Data' followed by EXTENDED SERVICE REQUEST message?	-->	EXTENDED SERVICE REQUEST	2	P
7	The SS sends SERVICE REJECT message with T3442 = 60 seconds in order that the UE enters EMM-REGISTERED.NORMAL-SERVICE.	<--	SERVICE REJECT	-	-
8	The SS releases the RRC connection	--		-	-
-	EXCEPTION: The behaviour in table 9.3.1.3.3.2-2 may occur in parallel with step 8A.	-	-	-	-
8A	SS waits for 60 seconds (T3442)	-	-	-	-

Note 1: This could be done by e.g. MMI or by AT command.

Table 9.3.1.3.3.2-2: Parallel Behaviour

St	Procedure	Message Sequence		TP	Verdict
		U - S	Message/PDU/SDU		
1	The UE transmits a TRACKING AREA UPDATE REQUEST message.	-->	TRACKING AREA UPDATE REQUEST	-	-
2	The SS transmits a TRACKING AREA UPDATE ACCEPT message.	<--	TRACKING AREA UPDATE ACCEPT	-	-
3	The SS releases the RRC connection.	-	-	-	-

9.3.1.3.3.3 Specific message contents

Table 9.3.1.3.3.3-1: Message EXTENDED SERVICE REQUEST (step 2/6, Table 9.3.1.3.3.2-1)

Derivation Path: 36.508 clause 4.7.2-14A			
Information Element	Value/remark	Comment	Condition
Service type	'0000'B	"mobile originating CS fallback"	
M-TMSI	M-TMSI1		
CSFB response	Not present		

Table 9.3.1.3.3.3-2: Message SERVICE REJECT (step 3 and7, Table 9.3.1.3.3.2-1)

Derivation Path: 36.508 clause 4.7.2-22			
Information Element	Value/remark	Comment	Condition
EMM cause	'0010 0111'	"CS domain temporarily not available"	
T3442 value	'0010 0001'B	1 minute	

Table 9.3.1.3.3.3-3: Message RRCConnectionRequest (step 6, Table 9.3.1.3.3.2-1)

Derivation path: 36.508 table 4.6.1-16			
Information Element	Value/Remark	Comment	Condition
<pre> RRCConnectionRequest ::= SEQUENCE { criticalExtensions CHOICE { rrcConnectionRequest-r8 SEQUENCE { establishmentCause } } } </pre>	mo-Data		

Table 9.3.1.3.3.3-4 Message TRACKING AREA UPDATE ACCEPT (step 2, Table 9.3.1.3.3.2-2)

Derivation path: 36.508 table 4.7.2-24			
Information Element	Value/Remark	Comment	Condition
GUTI	Not present		
MS identity	Not present		

Table 9.3.1.3.3.3-5: ATTACH ACCEPT (Preamble)

Derivation Path: 36.508 Table 4.7.2-1			
Information Element	Value/remark	Comment	Condition
EPS network feature support	Not present		

9.3.1.4 Service request / Rejected / IMSI invalid

9.3.1.4.1 Test Purpose (TP)

(1)

```

with { UE having sent a SERVICE REQUEST message }
ensure that {
  when { UE receives a SERVICE REJECT message with the EMM cause set to 'Illegal UE' }
  then { UE sets the EPS update status to E3 ROAMING NOT ALLOWED, deletes any GUTI, last visited
registered TAI, TAI list and KSI, considers the USIM as invalid for EPS services until switching off
or the UICC containing the USIM is removed, enters the state EMM-DEREGISTERED }
}

```

(2)

```

with { UE having sent a SERVICE REQUEST message }
ensure that {
  when { UE receives a SERVICE REJECT message with the EMM cause set to 'Illegal UE' }
}

```

```

    then { UE handles the GMM parameters GMM state, GPRS update status, P-TMSI, P-TMSI signature,
    RAI and GPRS ciphering key sequence number and the MM parameters update status, TMSI, LAI and
    ciphering key sequence number }
  }

```

9.3.1.4.2 Conformance requirements

References: The conformance requirements covered in the present TC are specified in: TS 24.301, clause 5.6.1.5 and TS 24.008, clause 4.7.13.4.

[TS 24.301, clause 5.6.1.5]

If the service request cannot be accepted, the network shall return a SERVICE REJECT message to the UE including an appropriate EMM cause value. When the EMM cause value is #39 "CS domain temporarily not available", the MME shall include a value for timer T3442 in the SERVICE REJECT message.

On receipt of the SERVICE REJECT message, the UE shall stop timer T3417 and take the following actions depending on the received EMM cause value.

#3 (Illegal UE); or

...

The UE shall set the EPS update status to EU3 ROAMING NOT ALLOWED (and shall store it according to subclause 5.1.3.3) and shall delete any GUTI, last visited registered TAI, TAI list and eKSI. The UE shall consider the USIM as invalid for EPS services until switching off or the UICC containing the USIM is removed. The UE shall enter the state EMM-DEREGISTERED.

If A/Gb mode or Iu mode is supported by the UE, the UE shall handle the GMM parameters GMM state, GPRS update status, P-TMSI, P-TMSI signature, RAI and GPRS ciphering key sequence number and the MM parameters update status, TMSI, LAI and ciphering key sequence number as specified in 3GPP TS 24.008 [13] for the case when the service request procedure is rejected with the GMM cause with the same value. The USIM shall be considered as invalid also for non-EPS services until switching off or the UICC containing the USIM is removed.

NOTE 1: The possibility to configure a UE so that the radio transceiver for a specific radio access technology is not active, although it is implemented in the UE, is out of scope of the present specification.

[TS 24.008, clause 4.7.13.4]

If the Service request cannot be accepted, the network returns a SERVICE REJECT message to the mobile station. An MS that receives a SERVICE REJECT message stops timer T3317. The MS shall then take different actions depending on the received reject cause value:

3 (Illegal MS); or

...

- The MS shall set the GPRS update status to GU3 ROAMING NOT ALLOWED (and shall store it according to subclause 4.1.3.2) and enter the state GMM-DEREGISTERED. Furthermore, it shall delete any P-TMSI, P-TMSI signature, RAI and GPRS ciphering key sequence number and shall consider the SIM/USIM as invalid for GPRS services until switching off or the SIM/USIM is removed.
- A GPRS MS operating in MS operation mode A shall in addition set the update status to U3 ROAMING NOT ALLOWED, shall delete any TMSI, LAI and ciphering key sequence number. If the MS is operating in MS operation mode A and an RR connection exists, the MS shall abort the RR connection, unless an emergency call is ongoing. The SIM/USIM shall be considered as invalid also for non-GPRS services until switching off or the SIM/USIM is removed.

If S1 mode is supported in the MS, the MS shall handle the EMM parameters EMM state, EPS update status, GUTI, last visited registered TAI, TAI list and KSI as specified in 3GPP TS 24.301 [120] for the case when the service request procedure is rejected with the EMM cause with the same value.

9.3.1.4.3 Test description

9.3.1.4.3.1 Pre-test conditions

System Simulator:

- cell A and cell B;
- If (px_RATComb_Tested = EUTRA_UTRA OR px_RATComb_Tested = EUTRA_GERAN);-if pc_UTRA AND px_RATComb_Tested = EUTRA_UTRA, cell 5 (belongs to LAI-1 and RAI-1, home PLMN) is configured;
- if pc_GERAN AND px_RATComb_Tested = EUTRA_GERAN, cell 24 (belongs to LAI-1 and RAI-1, home PLMN) is configured;
- system information combination 10 as defined in TS 36.508[18] clause 4.4.3.1 is applied in E-UTRA cells;
 - cell A is "Serving cell" and cell B, cell 5 and cell 24 are "non-Suitable cell".
- If (px_RATComb_Tested = EUTRA_Only):
 - neither cell 5 nor cell 24 is configured;
 - system information combination 1 as defined in TS 36.508[18] clause 4.4.3.1 is applied in E-UTRA cells.

UE:

- if pc_UTRA AND px_RATComb_Tested = EUTRA_UTRA, the UE is previously registered on UTRAN cell 5 using default message contents according to TS 36.508 [18].
- if pc_GERAN AND px_RATComb_Tested = EUTRA_GERAN, the UE is previously registered on GERAN cell 24 using default message contents according to TS 36.508 [18].

Preamble:

- the UE is in state Registered, Idle mode (state 2) on cell A according to TS 36.508 [18].

9.3.1.4.3.2 Test procedure sequence

Table 9.3.1.4.3.2-1: Main behaviour

St	Procedure	Message Sequence		TP	Verdict
		U - S	Message		
1	The SS pages the UE using S-TMSI with CN domain indicator set to "PS".	-	-	-	-
-	The following messages are to be observed on Cell A unless explicitly stated otherwise.	-	-	-	-
2	The UE transmits a SERVICE REQUEST message.	-->	SERVICE REQUEST	-	-
3	The SS transmits a SERVICE REJECT message with the EMM cause set to 'Illegal UE'.	<--	SERVICE REJECT	-	-
4	The SS releases the RRC connection.	-	-	-	-
5	Set the cell type of Cell A to the "non-Suitable cell". Set the cell type of Cell B to the "Serving cell".	-	-	-	-
-	The following messages are to be observed on Cell B unless explicitly stated otherwise.	-	-	-	-
6	Check: Does the UE transmit an ATTACH REQUEST message in the next 30 seconds?	-->	ATTACH REQUEST	1	F
-	EXCEPTION: Steps 6Aa1 to 6Ba1 describe behaviour that depends on the UE capability; the "lower case letter" identifies a step sequence that take place if a capability is supported	-	-	-	-
6Aa1	IF pc_UTRA AND px_RATComb_Tested = EUTRA_UTRA OR pc_GERAN AND px_RATComb_Tested = EUTRA_GERAN THEN the SS sets the cell type of Cell B to the "non-Suitable cell" and sets the cell type of Cell 5 or Cell 24 to the "Serving cell".	-	-	-	-
-	The following messages are to be observed on Cell 5 or Cell 24 unless explicitly stated otherwise.	-	-	-	-
6Aa2	Void	-	-	-	-
6Aa3	Check: Does the UE transmit an ATTACH REQUEST message in the next 30 seconds?	-->	ATTACH REQUEST	2	F
6Aa4	If possible (see ICS) switch off is performed or the USIM is removed, otherwise the power is removed.	-	-	-	-
6Aa5	The UE is brought back to operation or the USIM is inserted.	-	-	-	-
-	EXCEPTION: Steps 21a6a1, 21a6a2 describe behaviour that depends on the UE capability; the "lower case letter" identifies a step sequence that take place if pc_AutomaticAttachSwitchON is NOT supported	-	-	-	-
6Aa5 Aa1	IF NOT pc_AutomaticAttachSwitchON	-	Registration on CS	-	-
6Aa5 Aa2	IF NOT pc_AutomaticAttachSwitchON the user initiates an attach by MMI or by AT command.	-	-	-	-
6Aa6	Check: Does the UE transmit an ATTACH REQUEST message?	-->	ATTACH REQUEST	2	P
6Ba1	If not (pc_UTRA or pc_GERAN) then (if possible (see ICS) switch off is performed or the USIM is removed. Otherwise the power is removed (Note 2)).	-	-	-	-
7-11	Void	-	-	-	-
11A	Set the cell type of the Cell B to the "non-Suitable cell". Set the cell type of Cell A to the "Serving cell". If px_RATComb_Tested = EUTRA_UTRA set the cell type of Cell 5 to the "Cell Off" or if	-	-	-	-

	px_RATComb_Tested = EUTRA_GERAN set Cell 24 to the "Cell Off".				
-	The following messages are to be observed on Cell A unless explicitly stated otherwise.	-	-	-	-
	EXCEPTION: Steps 12a1 describe behaviour that depends on the UE capability; the "lower case letter" identifies a step sequence that take place if a capability is supported				
12	Void	-	-	-	-
12a1	If not (pc_UTRA or pc_GERAN), the UE is brought back to operation or the USIM is inserted.	-	-	-	-
13	Check: Does the UE transmit an ATTACH REQUEST message including a PDN CONNECTIVITY REQUEST message?	-->	ATTACH REQUEST	1	P
14-30	Void	-	-	-	-
31a1 - 31a9	Void	-	-	-	-
32-43	The attach procedure is completed by executing steps 5 to 16 of the UE registration procedure in TS 36.508 sub clause 4.5.2.3.	-	-	-	-
-	At the end of this test procedure sequence, the UE is in end state E-UTRA connected (E2) according to TS 36.508.	-	-	-	-
Note 1: Void.					
Note 2: Switching off, USIM removal, or power removal shall be done before T3310 and T3311 expire (30 seconds) so that the UE does not retransmit ATTACH REQUEST message.					

9.3.1.4.3.3 Specific message contents

Table 9.3.1.4.3.3-1: SERVICE REJECT (step 3, Table 9.3.1.4.3.2-1)

Derivation Path: TS 36.508 Table 4.7.2-22			
Information Element	Value/remark	Comment	Condition
EMM cause	'0000 0011'B	Illegal UE	

Table 9.3.1.4.3.3-2: ATTACH REQUEST (step 13, Table 9.3.1.4.3.2-1)

Derivation Path: 36.508, Table 4.7.2-4			
Information Element	Value/remark	Comment	Condition
NAS key set identifier			
NAS key set identifier	'111'B	no key is available	
TSC	Any allowed value	TSC does not apply for NAS key set identifier value "111".	
Old GUTI or IMSI	IMSI of the UE		
Last visited registered TAI	Not present		
Old location area identification	Not present		
TMSI status	Not present		
	'0'B	no valid TMSI available	pc_combined_attach AND (px_AttachTypeTested = COMBINED_ATTACH) AND (pc_UTRA OR pc_GERAN)

Table 9.3.1.4.3.3-3: ATTACH REQUEST (step 6Aa6, Table 9.3.1.4.3.2-1)

Derivation Path: TS 24.008 , Table 9.4.1			
Information Element	Value/remark	Comment	Condition
MS network capability	Any allowed value		
Attach type	Any allowed value		
GPRS ciphering key sequence number	'111'B	No key is available (MS to network)	
DRX parameter	Any allowed value		
P-TMSI or IMSI	IMSI of the UE		
Old routing area identification	All bits of octets 5 and 6 are set to 1, except bit 1 of octet 6 which is set to 0. Other bits are not checked.		
MS Radio Access capability	Any allowed value		
Old P-TMSI signature	Not present		
Requested READY timer value	Not present or any allowed value		
TMSI status	Not present		
	'0'B	no valid TMSI available	pc_SupportOpMode AND (px_AttachTypeTested = COMBINED_ATTACH)
PS LCS Capability	Not present or any allowed value		
Mobile station classmark 2	Not present or any allowed value		
Mobile station classmark 3	Not present or any allowed value		
Supported Codecs	Not present or any allowed value		
UE network capability	Not present or any allowed value		
Additional mobile identity	Not present		
Additional old routing area identification	Not present		

9.3.1.5 Service request / Rejected / Illegal ME

9.3.1.5.1 Test Purpose (TP)

(1)

```
with { UE having sent a SERVICE REQUEST message }
ensure that {
  when { UE receives a SERVICE REJECT message with the EMM cause set to 'Illegal ME' }
  then { UE sets the EPS update status to EU3 ROAMING NOT ALLOWED, deletes any GUTI, last visited
registered TAI, TAI list and KSI, considers the USIM as invalid for EPS services until switching off
or the UICC containing the USIM is removed, enters the state EMM-DEREGISTERED }
}
```

(2)

```
with { UE supporting A/Gb mode or Iu mode and having sent a SERVICE REQUEST message }
ensure that {
  when { UE receives a SERVICE REJECT message with the EMM cause set to 'Illegal ME' }
  then { UE sets the GPRS update status to GU3 ROAMING NOT ALLOWED, deletes any P-TMSI, P-TMSI
signature, TMSI, LAI, RAI and GPRS ciphering key sequence number and considers the SIM/USIM as
invalid for GPRS services until switching off or the SIM/USIM is removed }
}
```

9.3.1.5.2 Conformance requirements

References: The conformance requirements covered in the present TC are specified in: TS 24.301, clause 5.6.1.5 and TS 24.008, clause 4.7.13.4.

[TS 24.301, clause 5.6.1.5]

On receipt of the SERVICE REJECT message, the UE shall stop timer T3417 and take the following actions depending on the received EMM cause value.

...

#6 (Illegal ME);

The UE shall set the EPS update status to EU3 ROAMING NOT ALLOWED (and shall store it according to subclause 5.1.3.3) and shall delete any GUTI, last visited registered TAI, TAI list and KSI. The UE shall consider the USIM as invalid for EPS services until switching off or the UICC containing the USIM is removed. The UE shall enter the state EMM-DEREGISTERED.

If A/Gb mode or Iu mode is supported by the UE, the UE shall handle the GMM parameters GMM state, GPRS update status, P-TMSI, P-TMSI signature, RAI and GPRS ciphering key sequence number and the MM parameters update status, TMSI, LAI and ciphering key sequence number as specified in 3GPP TS 24.008 [13] for the case when the service request procedure is rejected with the GMM cause with the same value. The USIM shall be considered as invalid also for non-EPS services until switching off or the UICC containing the USIM is removed.

NOTE 1: The possibility to configure a UE so that the radio transceiver for a specific radio access technology is not active, although it is implemented in the UE, is out of scope of the present specification.

[TS 24.008, clause 4.7.13.4]

If the Service request cannot be accepted, the network returns a SERVICE REJECT message to the mobile station. An MS that receives a SERVICE REJECT message stops timer T3317. The MS shall then take different actions depending on the received reject cause value:

...

6 (Illegal ME);

- The MS shall set the GPRS update status to GU3 ROAMING NOT ALLOWED (and shall store it according to subclause 4.1.3.2) and enter the state GMM-DEREGISTERED. Furthermore, it shall delete any P-TMSI, P-TMSI signature, RAI and GPRS ciphering key sequence number and shall consider the SIM/USIM as invalid for GPRS services until switching off or the SIM/USIM is removed.
- A GPRS MS operating in MS operation mode A shall in addition set the update status to U3 ROAMING NOT ALLOWED, shall delete any TMSI, LAI and ciphering key sequence number. If the MS is operating in MS operation mode A and an RR connection exists, the MS shall abort the RR connection, unless an emergency call is ongoing. The SIM/USIM shall be considered as invalid also for non-GPRS services until switching off or the SIM/USIM is removed.

9.3.1.5.3 Test description

The test description is identical to the one of subclause 9.3.1.4 except that the reject cause #3 "Illegal UE" is replaced with reject cause #6 "Illegal ME".

9.3.1.6 Service request / Rejected / EPS services not allowed

9.3.1.6.1 Test Purpose (TP)

(1)

```
with { UE having sent a SERVICE REQUEST message }
ensure that {
  when { UE receives a SERVICE REJECT message with the EMM cause set to 'EPS services not allowed' }
  then { UE sets the EPS update status to EU3 ROAMING NOT ALLOWED, deletes any GUTI, last visited
registered TAI, TAI list and KSI, considers the USIM as invalid for EPS services until switching off
or the UICC containing the USIM is removed and enters the state EMM-DEREGISTERED }
}
```

(2)

```
with { UE supporting A/Gb mode or Iu mode and having sent a SERVICE REQUEST message }
ensure that {
  when { UE receives a SERVICE REJECT message with the EMM cause set to 'EPS services not allowed' }
  then { UE sets the GPRS update status to GU3 ROAMING NOT ALLOWED, deletes any P-TMSI, P-TMSI
signature, RAI and GPRS ciphering key sequence number and considers the SIM/USIM as invalid for GPRS
services until switching off or the SIM/USIM is removed }
}
```

9.3.1.6.2 Conformance requirements

References: The conformance requirements covered in the present TC are specified in: TS 24.301, clause 5.6.1.5 and TS 24.008, clause 4.7.13.4.

[TS 24.301, clause 5.6.1.5]

On receipt of the SERVICE REJECT message, the UE shall stop timer T3417 and take the following actions depending on the received EMM cause value.

...

#7 (EPS services not allowed);

The UE shall set the EPS update status to EU3 ROAMING NOT ALLOWED (and shall store it according to subclause 5.1.3.3) and shall delete any GUTI, last visited registered TAI, TAI list and KSI. The UE shall consider the USIM as invalid for EPS services until switching off or the UICC containing the USIM is removed. The UE shall enter the state EMM-DEREGISTERED.

A UE operating in CS/PS mode 1 or CS/PS mode 2 of operation is still IMSI attached for non-EPS services. The UE shall set the update status to U2 NOT UPDATED, shall select GERAN or UTRAN radio access technology and proceed with appropriate MM specific procedure according to the MM service state. The UE shall not reselect E-UTRAN radio access technology until switching off or the UICC containing the USIM is removed

...

If A/Gb mode or Iu mode is supported by the UE, the UE shall handle the GMM parameters GMM state, GPRS update status, P-TMSI, P-TMSI signature, RAI and GPRS ciphering key sequence number as specified in 3GPP TS 24.008 [13] for the case when the service request procedure is rejected with the GMM cause with the same value.

[TS 24.008, clause 4.7.13.4]

If the Service request cannot be accepted, the network returns a SERVICE REJECT message to the mobile station. An MS that receives a SERVICE REJECT message stops timer T3317. The MS shall then take different actions depending on the received reject cause value:

...

7 (GPRS services not allowed);

- The MS shall set the GPRS update status to GU3 ROAMING NOT ALLOWED (and shall store it according to subclause 4.1.3.2) and shall delete any P-TMSI, P-TMSI signature, RAI and GPRS ciphering key sequence

number. The SIM/USIM shall be considered as invalid for GPRS services until switching off or the SIM/USIM is removed. The new state is GMM-DEREGISTERED.

9.3.1.6.3 Test description

9.3.1.6.3.1 Pre-test conditions

System Simulator:

- cell A is configured as the "Serving cell";
- If (px_RATComb_Tested = EUTRA_UTRA OR px_RATComb_Tested = EUTRA_GERAN);
- if pc_UTRA AND px_RATComb_Tested = EUTRA_UTRA, cell 5 (belongs to LAI-1 and RAI-1, home PLMN) is configured and set to as a 'Non-suitable cell';
- if pc_GERAN AND px_RATComb_Tested = EUTRA_GERAN, cell 24 (belongs to LAI-1 and RAI-1, home PLMN) is configured and set to as a 'Non-suitable cell';
- system information combination 10 as defined in TS 36.508[18] clause 4.4.3.1 is applied in E-UTRA cells;
- If (px_RATComb_Tested = EUTRA_Only):
 - neither cell 5 nor cell 24 is configured;
 - system information combination 1 as defined in TS 36.508[18] clause 4.4.3.1 is applied in E-UTRA cells;

UE:

- if pc_UTRA AND px_RATComb_Tested = EUTRA_UTRA, the UE is previously registered on UTRAN cell 5 using default message contents according to TS 36.508 [18].
- if pc_GERAN AND px_RATComb_Tested = EUTRA_GERAN, the UE is previously registered on GERAN cell 24 using default message contents according to TS 36.508 [18].

Preamble:

- the UE is in state Registered, Idle mode (state 2) on cell A according to TS 36.508 [18].

9.3.1.6.3.2 Test procedure sequence

Table 9.3.1.6.3.2-1: Main behaviour

St	Procedure	Message Sequence		TP	Verdict
		U - S	Message		
1	The SS pages the UE using S-TMSI with CN domain indicator set to "PS".	-	-	-	-
1A	Void	-	-	-	-
-	The following messages are to be observed on Cell A unless explicitly stated otherwise.	-	-	-	-
2	UE transmits a SERVICE REQUEST message.	-->	SERVICE REQUEST	-	-
3	The SS transmits an SERVICE REJECT message with EMM cause = "EPS services not allowed".	<--	SERVICE REJECT	-	-
4	The SS releases the RRC connection.	-	-	-	-
5	Check: Does the UE transmit a SERVICE REQUEST message in the next 30 seconds?	-->	SERVICE REQUEST	1	F
6	Check: Does the test result of generic procedure in TS 36.508 subclause 6.4.2.5 indicate that the UE does not respond to paging when paged with S-TMSI included in GUTI-1 and with CN domain indicator set to "PS"?	-	-	1	-
-	EXCEPTION: Steps 7a1 to 7b8 describe behaviour that depends on the UE capability; the "lower case letter" identifies a step sequence that take place if a capability is supported	-	-	-	-
7a1	IF pc_UTRA AND px_RATComb_Tested = EUTRA_UTRA THEN SS configures: - Cell A as 'Non-suitable cell' - Cell 5 as 'Serving cell'	-	-	-	-
-	The following messages are to be observed on Cell 5 unless explicitly stated otherwise.	-	-	-	-
-	EXCEPTION: The behaviour in table 9.3.1.6.3.2-2 occurs in parallel with step 7a2.	-	-	-	-
7a2	Check: Does the UE transmit an ATTACH REQUEST message in the next 90 seconds?	-->	ATTACH REQUEST	2	F
7a3	The user initiates an attach by MMI or by AT command.	-	-	-	-
7a4	Check: Does the UE transmit an ATTACH REQUEST message in the next 30 seconds?	-->	ATTACH REQUEST	1	F
7a5	If possible (see ICS) switch off is performed or the USIM is removed. Otherwise the power is removed.	-	-	-	-
-	EXCEPTION: Steps 7a6a1 describe behaviour that depends on the UE capability; the "lower case letter" identifies a step sequence that take place if a capability is supported	-	-	-	-
7a6a1	IF pc_CS THEN the UE optionally transmits an IMSI DETACH INDICATION message	-->	IMSI DETACH INDICATION	-	-
7a7	The UE is brought back to operation or the USIM is inserted.	-	-	-	-
7a8	Check: Does the UE transmit an ATTACH REQUEST message?	-->	ATTACH REQUEST	2	P
-	EXCEPTION: Steps 21a6a1, 21a6a2 describe behaviour that depends on the UE capability; the "lower case letter" identifies a step sequence that take place if pc_AutomaticAttachSwitchON is NOT supported	-	-	-	-
7a8Aa1	IF NOT pc_AutomaticAttachSwitchON	-	Registration on CS	-	-
7a8Aa2	IF NOT pc_AutomaticAttachSwitchON the user initiates an attach by MMI or by AT command.	-	-	-	-

7b1	IF pc_GERAN AND px_RATComb_Tested = EUTRA_GERAN THEN SS configures: - Cell A as 'Non-suitable cell' - Cell 24 as 'Serving cell'	-	-	-	-
-	The following messages are to be observed on Cell 24 unless explicitly stated otherwise.	-	-	-	-
-	EXCEPTION: The behaviour in table 9.3.1.6.3.2-2 occurs in parallel with step 7b2.	-	-	-	-
7b2	Check: Does the UE transmit an ATTACH REQUEST message in the next 90 seconds?	-->	ATTACH REQUEST	2	F
7b3	The user initiates an attach by MMI or by AT command.	-	-	-	-
7b4	Check: Does the UE transmit an ATTACH REQUEST message in the next 30 seconds?	-->	ATTACH REQUEST	1	F
7b5	If possible (see ICS) switch off is performed or the USIM is removed. Otherwise the power is removed.	-	-	-	-
7b6	IF Location Updating procedure has been performed in step 1a1 of behaviour described in table 9.3.1.6.3.2-2 parallel to step 7b2 THEN the UE transmits an IMSI DETACH INDICATION message	-->	IMSI DETACH INDICATION	-	-
7b6A	The UE transmits a <i>Classmark Change</i> message	-->	CLASSMARK CHANGE	-	-
-	EXCEPTION: Step 7b6B describes behaviour that depends on UE capability.	-	-	-	-
7b6B	IF pc_UTRA THEN the UE transmits a <i>Utran Classmark Change</i> message.	-->	UTRAN CLASSMARK CHANGE	-	-
7b7	The UE is brought back to operation or the USIM is inserted.	-	-	-	-
7b8	Check: Does the UE transmit an ATTACH REQUEST message?	-->	ATTACH REQUEST	2	P
	EXCEPTION: Steps 8a1 describe behaviour that depends on the UE capability; the "lower case letter" identifies a step sequence that take place if a capability is supported				
8 a1	IF not (pc_UTRA or pc_GERAN) then (if possible (see ICS) switch off is performed or the USIM is removed. Otherwise the power is removed).	-	-	-	-
9	The SS configures: - Cell A as the 'Serving cell'. - IF pc_UTRA AND px_RATComb_Tested = EUTRA_UTRA THEN Cell 5 'Non-suitable cell off'. - IF pc_GERAN AND px_RATComb_Tested = EUTRA_GERAN THEN Cell 24 'Non-suitable cell off'.	-	-	-	-
	EXCEPTION: Steps 10a1 describe behaviour that depends on the UE capability; the "lower case letter" identifies a step sequence that take place if a capability is supported				
10 a1	If not (pc_UTRA or pc_GERAN), the UE is brought back to operation or the USIM is inserted..	-	-	-	-
11	The UE transmits an ATTACH REQUEST message on cell A including a PDN CONNECTIVITY REQUEST message	-->	ATTACH REQUEST	1	P
12	The SS transmits an AUTHENTICATION REQUEST message to initiate the EPS authentication and AKA procedure.	<--	AUTHENTICATION REQUEST	-	-
13	The UE transmits an AUTHENTICATION RESPONSE message and establishes mutual authentication.	-->	AUTHENTICATION RESPONSE	-	-
14	The SS transmits a NAS SECURITY MODE COMMAND message to activate NAS security.	<--	SECURITY MODE COMMAND	-	-
15	The UE transmits a NAS SECURITY MODE	-->	SECURITY MODE COMPLETE	-	-

	COMPLETE message and establishes the initial security configuration.				
-	EXCEPTION: Steps 16a1 to 16a2 describe behaviour that depends on UE configuration; the "lower case letter" identifies a step sequence that take place if the UE has ESM information which needs to be transferred.	-	-	-	-
16a1	IF the UE sets the ESM information transfer flag in the last PDN CONNECTIVITY REQUEST message THEN the SS transmits an ESM INFORMATION REQUEST message to initiate exchange of protocol configuration options and/or APN.	<--	ESM INFORMATION REQUEST	-	-
16a2	The UE transmits the ESM INFORMATION REQUEST message to transfer protocol configuration options and/or APN.	-->	ESM INFORMATION RESPONSE	-	-
17	SS responds with ATTACH ACCEPT message. The ACTIVATE DEFAULT EPS BEARER CONTEXT REQUEST message is piggybacked in ATTACH ACCEPT message	<--	ATTACH ACCEPT	-	-
Note 1: Void					

Table 9.3.1.6.3.2-2: Parallel behaviour

St	Procedure	Message Sequence		TP	Verdict
		U - S	Message		
-	EXCEPTION: Steps 1a1 and 1a4 describe a behaviour which depends on the UE capability; the "lower case letter" identifies a step sequence that take place if a capability is supported.	-	-	-	-
1a1	IF pc_CS THEN the UE optionally transmits a LOCATION UPDATING REQUEST message.	-->	LOCATION UPDATING REQUEST	-	-
-	EXCEPTION: The messages in the next two steps are sent only on Cell 24	-	-	-	-
1a1A a1	The UE transmits a <i>Classmark Change</i> message	-->	CLASSMARK CHANGE		
-	EXCEPTION: The next step describes behaviour that depends on UE capability.	-	-	-	-
1a1A a2	IF pc_UTRA THEN the UE transmits a <i>Utran Classmark Change</i> message.	-->	UTRAN CLASSMARK CHANGE.		
1a2	The SS transmits an AUTHENTICATION REQUEST message to initiate the authentication and AKA procedure.	<--	AUTHENTICATION REQUEST	-	-
1a3	The UE transmits an AUTHENTICATION RESPONSE message.	-->	AUTHENTICATION RESPONSE	-	-
1a4	The SS transmits a LOCATION UPDATING ACCEPT message including IMSI-1	<--	LOCATION UPDATING ACCEPT	-	-

9.3.1.6.3.3 Specific message contents

Table 9.3.1.6.3.3-1: SERVICE REJECT (step 3, Table 9.3.1.6.3.2-1)

Derivation Path: TS 36.508 Table 4.7.2-22			
Information Element	Value/remark	Comment	Condition
EMM cause	'0000 0111'B	EPS services not allowed	

Table 9.3.1.6.3.3-2: Message ATTACH REQUEST (step 11, Table 9.3.1.6.3.2-1)

Derivation path: TS 36.508 table 4.7.2-4			
Information Element	Value/Remark	Comment	Condition
NAS key set identifier	'111'B	no key is available	
Old GUTI or IMSI	IMSI1		
Last visited registered TAI	Not present		

Table 9.3.1.6.3.3-3: Message ATTACH REQUEST (step 7a8 and 7b8, Table 9.3.1.6.3.2-1)

Derivation path: TS 24.008 table 9.4.1			
Information Element	Value/Remark	Comment	Condition
GPRS ciphering key sequence number	'111'B	no key is available	
P-TMSI or IMSI	IMSI1		
Old routing area identification	all bits of the location area code shall be set to one with the exception of the least significant bit which shall be set to zero	RAI is deleted	
Old P-TMSI signature	Not present		
TMSI status	Not present or 0		

Table 9.3.1.6.3.3-4: Void**Table 9.3.1.6.3.3-5: Void****Table 9.3.1.6.3.3-6: LOCATION UPDATING ACCEPT (step 1a2, Table 9.3.1.6.3.2-2)**

Derivation Path: TS 36.508 Table 4.7B.2-5			
Information Element	Value/remark	Comment	Condition
Mobile identity			
IMSI	IMSI-1		

9.3.1.7 Service request / Rejected / UE identity cannot be derived by the network

9.3.1.7.1 Test Purpose (TP)

(1)

```
with { UE having sent a SERVICE REQUEST message }
ensure that {
  when { UE receives a SERVICE REJECT message with the EMM cause value = 9 (UE identity cannot be
derived by the network) }
  then { UE sets the EPS update status to EU2 NOT UPDATED and deletes any GUTI, last visited
registered TAI, TAI list and KSI and automatically initiate the attach procedure }
}
```

9.3.1.7.2 Conformance requirements

References: The conformance requirements covered in the present TC are specified in: TS 24.301, clause 5.6.1.5.

[TS 24.301, clause 5.6.1.5]

On receipt of the SERVICE REJECT message, the UE shall stop timer T3417 and take the following actions depending on the received EMM cause value.

...

#9 (UE identity cannot be derived by the network);

The UE shall set the EPS update status to EU2 NOT UPDATED (and shall store it according to subclause 5.1.3.3) and shall delete any GUTI, last visited registered TAI, TAI list and KSI. The UE shall enter the state EMM-DEREGISTERED.

Subsequently, the UE shall automatically initiate the attach procedure.

NOTE 3: User interaction is necessary in some cases when the UE cannot re-activate the EPS bearer(s) automatically.

9.3.1.7.3 Test description

9.3.1.7.3.1 Pre-test conditions

System Simulator:

- cell A.

UE:

none.

Preamble:

- the UE is in state Registered, Idle mode (state 2) on cell A according to TS 36.508 [18].

9.3.1.7.3.2 Test procedure sequence

Table 9.3.1.7.3.2-1: Main behaviour

St	Procedure	Message Sequence		TP	Verdict
		U - S	Message		
1	The SS pages the UE using S-TMSI with CN domain indicator set to "PS".	-	-	-	-
2	The UE transmits a SERVICE REQUEST message.	-->	SERVICE REQUEST	-	-
3	The SS transmits a SERVICE REJECT message with the EMM cause set to #9 (UE identity cannot be derived by the network).	<--	SERVICE REJECT	-	-
-	EXCEPTION: Steps 3a1-3a2 describes the behaviour that depends on UE behaviour (Note 1).	-	-	-	-
3a1	The SS releases the RRC connection.	-	-	-	-
-	EXCEPTION: Step 3a2 describes a behaviour which depends on the UE capability	-	-	-	-
3a2	IF NOT pc_Automatic_EPS_Re_Attach, the user initiates an attach by MMI or by AT command.	-	-	-	-
4	Check: Does the UE transmit an ATTACH REQUEST message including IMSI and without integrity protection?	-->	ATTACH REQUEST	1	P
5-16	The attach procedure is completed by executing steps 5 to 16 of the UE registration procedure in TS 36.508 sub clause 4.5.2.3.	-	-	-	-
-	At the end of this test procedure sequence, the UE is in end state E-UTRA connected (E2) according to TS 36.508.	-	-	-	-
Note 1: SS waits for 1 second to receive the Attach Request on the existing RRC Connection. In case Attach Request is not received within 1 second, existing RRC Connection is released.					

9.3.1.7.3.3 Specific message contents

Table 9.3.1.7.3.3-1: SERVICE REJECT (step 3, Table 9.3.1.7.3.2-1)

Derivation Path: TS 36.508 Table 4.7.2-22			
Information Element	Value/remark	Comment	Condition
EMM cause	'0000 1001'B	UE identity cannot be derived by the network	

Table 9.3.1.7.3.3-2: ATTACH REQUEST (step 4, Table 9.3.1.7.3.2-1)

Derivation Path: 36.508, Table 4.7.2-4			
Information Element	Value/remark	Comment	Condition
NAS key set identifier	'111'B	no key is available	
Old GUTI or IMSI	IMSI		
Last visited registered TAI	Not present		

9.3.1.7a Service request / Rejected / UE implicitly detached

9.3.1.7a.1 Test Purpose (TP)

(1)

```

with { UE having sent a SERVICE REQUEST message }
ensure that {
  when { UE receives a SERVICE REJECT message with the EMM cause set to 'Implicitly detached' }
  then { UE enters the state EMM-DEREGISTERED.NORMAL-SERVICE, delete the EPS mapped EPS security
context if any and performs a new attach procedure }
}

```

9.3.1.7a.2 Conformance requirements

References: The conformance requirements covered in the present TC are specified in: TS 24.301, clause 5.6.1.5.

[TS 24.301, clause 5.6.1.5]

If the service request cannot be accepted, the network shall return a SERVICE REJECT message to the UE including an appropriate EMM cause value.

...

On receipt of the SERVICE REJECT message, the UE shall stop timer T3417 and take the following actions depending on the received EMM cause value.

...

#10 (Implicitly detached);

The UE shall enter the state EMM-DEREGISTERED.NORMAL-SERVICE. The UE shall delete any mapped EPS security context or partial native EPS security context. The UE shall perform a new attach procedure.

NOTE 4: User interaction is necessary in some cases when the UE cannot re-activate the EPS bearer(s) automatically.

9.3.1.7a.3 Test description

9.3.1.7a.3.1 Pre-test conditions

System Simulator:

- cell A.

UE:

none.

Preamble:

- the UE is in state Registered, Idle mode (state 2) on cell A according to TS 36.508 [18].

9.3.1.7a.3.2 Test procedure sequence

Table 9.3.1.7a.3.2-1: Main behaviour

St	Procedure	Message Sequence		TP	Verdict
		U - S	Message		
1	The SS pages the UE using S-TMSI with CN domain indicator set to "PS".	-	-	-	-
2	The UE transmits a SERVICE REQUEST message.	-->	SERVICE REQUEST	-	-
3	The SS transmits a SERVICE REJECT message with the EMM cause set to 'Implicitly detached'.	<--	SERVICE REJECT	-	-
-	EXCEPTION: Steps 3a1 & 3a2 describes the behaviour that depends on UE behaviour (Note 1).	-	-	-	-
3a1	The SS releases the RRC connection.	-	-	-	-
-	EXCEPTION: Step 3a2 describes a behaviour which depends on the UE capability	-	-	-	-
3a2	IF NOT pc_Automatic_EPS_Re_Attach, the user initiates an attach by MMI or by AT command.	-	-	-	-
4	Check: Does the UE transmit an ATTACH REQUEST message including a PDN CONNECTIVITY REQUEST message and integrity protected using the native security context resulting from authentication during the test preamble?	-->	ATTACH REQUEST	1	P
5-16	The attach procedure is completed by executing steps 5 to 16 of the UE registration procedure in TS 36.508 sub clause 4.5.2.3.	-	-	-	-
-	At the end of this test procedure sequence, the UE is in end state E-UTRA connected (E2) according to TS 36.508.	-	-	-	-
Note 1: SS waits for 1 second to receive the Attach Request on the existing RRC Connection. In case Attach Request is not received within 1 second, existing RRC Connection is released.					

9.3.1.7a.3.3 Specific message contents

Table 9.3.1.7a.3.3-1: SERVICE REJECT (step 3, Table 9.3.1.7a.3.2-1)

Derivation Path: TS 36.508 Table 4.7.2-22			
Information Element	Value/remark	Comment	Condition
EMM cause	'0000 1010'B	Implicitly detached	

Table 9.3.1.7a.3.3-2: ATTACH REQUEST (step 4, Table 9.3.1.7a.3.2-1)

Derivation Path: 36.508, Table 4.7.2-4			
Information Element	Value/remark	Comment	Condition
NAS key set identifier			
NAS key set identifier	NAS key set identifier allocated to UE during authentication in test preamble		
TSC	'0'B	Native security context	
Old GUTI or IMSI	GUTI allocated to UE during previous attach on Cell A.		
Last visited registered TAI	TAI-1		

9.3.1.8 to 9.3.1.12 Void

9.3.1.12a Extended service request / Rejected / CS domain temporarily not available

9.3.1.12a.1 Test Purpose (TP)

(1)

```

with { UE has received a SERVICE REJECT message with the EMM cause set to 'CS domain temporarily not
available' and T3442 expired }
ensure that {
  when { UE is requested to initiate a CS call }
  then { UE transmit EXTENDED SERVICE REQUEST message }
}

```

9.3.1.12a.2 Conformance requirements

References: The conformance requirements covered in the present TC are specified in: TS 24.301, clause 5.6.1.5.

[TS 24.301, clause 5.6.1.5]

If the service request cannot be accepted, the network shall return a SERVICE REJECT message to the UE including an appropriate EMM cause value. When the EMM cause value is #39 "CS domain temporarily not available", the MME shall include a value for timer T3442 in the SERVICE REJECT message.

On receipt of the SERVICE REJECT message, the UE shall stop timer T3417 and take the following actions depending on the received EMM cause value.

...

#39 (CS domain temporarily not available);

The UE shall start timer T3442 and enter the state EMM-REGISTERED.NORMAL-SERVICE.

The UE shall not try to send an EXTENDED SERVICE REQUEST message for mobile originating services to the network, except for mobile originating CS fallback for emergency calls, until timer T3442 expires or the UE sends a TRACKING AREA UPDATE REQUEST message.

9.3.1.12a.3 Test description

9.3.1.12a.3.1 Pre-test conditions

System Simulator:

- cell A.

UE:

none.

Preamble:

- the UE is in state Registered, Idle Mode (state 2) according to TS 36.508 [18].

9.3.1.12a.3.2 Test procedure sequence

Table 9.3.1.12a.3.2-1: Main behaviour

St	Procedure	Message Sequence		TP	Verdict
		U - S	Message		
1	The SS pages the UE using S-TMSI with CN domain indicator set to "CS".	-	-	-	-
2	The UE transmits an EXTENDED SERVICE REQUEST message.	-->	EXTENDED SERVICE REQUEST	-	-
3	The SS transmits a SERVICE REJECT message with the EMM cause set to 'CS domain temporarily not available' and T3442 = 60 seconds.	<--	SERVICE REJECT	-	-
4	The SS releases the RRC connection.	-	-	-	-
-	EXCEPTION: The behaviour in table 9.3.1.12a.3.2-2 may occur in parallel with step 4A.	-	-	-	-
4A	SS waits for 60 seconds (T3442)	-	-	-	-
5	Cause the UE to originate CS call. (Note 1)	-	-	-	-
6	Check: Does the UE transmit an EXTENDED SERVICE REQUEST message?	-->	EXTENDED SERVICE REQUEST	1	P
6A	The SS sends SERVICE REJECT message with the EMM cause set to 'CS domain temporarily not available' and T3442 = 60 seconds.	<--	SERVICE REJECT	-	-
6B	The SS releases the RRC Connection,	-	-	-	-
-	EXCEPTION: The behaviour in table 9.3.1.12a.3.2-2 may occur in parallel with step 6C.	-	-	-	-
6C	The SS waits for 60 seconds (T3442)	-	-	-	-
7	If possible (see ICS) switch off is performed or the USIM is removed. Otherwise the power is removed. (Note 2)	-	-	-	-
<p>Note 1: The trigger in step 5 is the same as in the generic procedure in 36.508 clause 6.4.3.5.</p> <p>Note 2: The UE is powered off, switched off, or the USIM is removed because the UE may retry a transmission of an EXTENDED SERVICE REQUEST message depending on the UE implementation after timer T3442 expires. Additionally, it is not clear which postamble procedure is performed, since the UE may search the UTRAN/GERAN cell after step 3.</p>					

Table 9.3.1.12a.3.2-2: Parallel Behaviour

St	Procedure	Message Sequence		TP	Verdict
		U - S	Message/PDU/SDU		
1	The UE transmits a TRACKING AREA UPDATE REQUEST message.	-->	TRACKING AREA UPDATE REQUEST	-	-
2	The SS transmits a TRACKING AREA UPDATE ACCEPT message.	<--	TRACKING AREA UPDATE ACCEPT	-	-
3	The SS releases the RRC connection.	-	-	-	-

9.3.1.12a.3.3 Specific message contents

Table 9.3.1.12a.3.3-1: Message SERVICE REJECT (step 3 and 6A, Table 9.3.1.12a.3.2-1)

Derivation Path: TS 36.508, Table 4.7.2-22			
Information Element	Value/remark	Comment	Condition
EMM cause	'0010 0111'B	CS domain temporarily not available	
T3442 value			
Timer value	'0 0001'B	1 minute	
Unit	'001'B	value is incremented in multiples of 1 minute	

Table 9.3.1.12a.3.3-2: Message TRACKING AREA UPDATE ACCEPT (step 2, Table 9.3.1.12a.3.2-2)

Derivation path: 36.508 table 4.7.2-24			
Information Element	Value/Remark	Comment	Condition
GUTI	Not present		
MS Identity	Not Present		

9.3.1.13 Void

9.3.1.14 Void

9.3.1.15 Void

9.3.1.16 Service request / Abnormal case / Switch off

9.3.1.16.1 Test Purpose (TP)

(1)

```

with { UE having sent a SERVICE REQUEST message }
ensure that {
  when { UE is switched off }
  then { UE performs the detach procedure }
}

```

9.3.1.16.2 Conformance requirements

References: The conformance requirements covered in the present TC are specified in: TS 24.301, clause 5.6.1.6.

[TS 24.301, clause 5.6.1.6]

The following abnormal cases can be identified:

...

g) Switch off

If the UE is in state EMM-SERVICE-REQUEST-INITIATED at switch off, the detach procedure shall be performed.

...

9.3.1.16.3 Test description

9.3.1.16.3.1 Pre-test conditions

System Simulator:

- cell A.

UE:

none.

Preamble:

- the UE is in state Registered, Idle mode (state 2) according to TS 36.508 [18].

9.3.1.16.3.2 Test procedure sequence

Table 9.3.1.16.3.2-1: Main behaviour

St	Procedure	Message Sequence		TP	Verdict
		U - S	Message		
1	The SS pages the UE using S-TMSI with CN domain indicator set to "PS".	-	-	-	-
2	The UE transmits a SERVICE REQUEST message.	-->	SERVICE REQUEST	-	-
3	The SS does not respond to the SERVICE REQUEST message. NOTE: The SS does not transmit both <i>SecurityModeCommand</i> message and <i>RRCCConnectionReconfiguration</i> message.	-	-	-	-
4	The UE is switched off.	-	-	-	-
5	Check: Does the UE transmit a DETACH REQUEST message?	-->	DETACH REQUEST	1	P
6	Check: Does the test result of generic test procedure in TS 36.508 subclause 6.4.2.5 indicates that the UE does not respond to paging when paged with S-TMSI included in GUTI-1 and with CN domain indicator set to "PS"?	-	-	1	-

9.3.1.16.3.3 Specific message contents

None.

9.3.1.17 Service request / Abnormal case / Procedure collision

9.3.1.17.1 Test Purpose (TP)

(1)

```
with { UE having sent a SERVICE REQUEST message }
ensure that {
  when { UE receives a DETACH REQUEST message with the Type of detach set to 're-attach required' }
  then { UE sends a DETACH ACCEPT message and performs the attach procedure }
}
```

(2)

```
with { UE having sent a SERVICE REQUEST message or an EXTENDED SERVICE REQUEST message }
ensure that {
  when { UE receives a DETACH REQUEST message with the Type of detach set to the value other than 're-attach required' }
  then { UE sends a DETACH ACCEPT message }
}
```

9.3.1.17.2 Conformance requirements

References: The conformance requirements covered in the present TC are specified in: TS 24.301, clause 5.6.1.6.

[TS 24.301, clause 5.6.1.6]

The following abnormal cases can be identified:

...

h) Procedure collision

If the UE receives a DETACH REQUEST message with detach type "re-attach required" or "re-attach not required" with EMM cause other than #2 "IMSI unknown in HSS" from the network in state EMM-SERVICE-REQUEST-INITIATED, the detach procedure shall be progressed and the service request procedure shall be aborted.

Additionally, if the service request was initiated for CS fallback or 1xCS fallback, the EMM sublayer shall indicate to the MM sublayer or the cdma2000[®] upper layers that the CS fallback or 1xCS fallback procedure has failed.

If the Detach type IE in the DETACH REQUEST message indicated "re-attach required", the attach procedure shall be performed.

9.3.1.17.3 Test description

9.3.1.17.3.1 Pre-test conditions

System Simulator:

- cell A.

UE:

none.

Preamble:

- the UE is in state Registered, Idle mode (state 2) according to TS 36.508 [18].

9.3.1.17.3.2 Test procedure sequence

Table 9.3.1.17.3.2-1: Main behaviour

St	Procedure	Message Sequence		TP	Verdict
		U - S	Message		
1	The SS pages the UE using S-TMSI with CN domain indicator set to "PS".	-	-	-	-
2	The UE transmits a SERVICE REQUEST message.	-->	SERVICE REQUEST	-	-
3	The SS transmits a DETACH REQUEST message with the Type of detach set to 're-attach required'.	<--	DETACH REQUEST	-	-
4	Check: Does the UE transmit a DETACH ACCEPT message?	-->	DETACH ACCEPT	1	P
5	Void	-	-	-	-
-	EXCEPTION: Steps 5a-5b describes a behaviour that depends on UE behaviour (Note 1).	-	-	-	-
5a	The SS releases the RRC connection.	-	-	-	-
-	EXCEPTION: Step 5b describes a behaviour which depends on the UE capability	-	-	-	-
5b	IF NOT pc_Automatic_Re_Attach, the user initiates an attach by MMI or by AT command.	-	-	-	-
6	Check: Does the UE transmit an ATTACH REQUEST message including a PDN CONNECTIVITY REQUEST message?	-->	ATTACH REQUEST	1	P
7	The SS transmits an AUTHENTICATION REQUEST message to initiate the EPS authentication and AKA procedure.	<--	AUTHENTICATION REQUEST	-	-
8	The UE transmits an AUTHENTICATION RESPONSE message and establishes mutual authentication.	-->	AUTHENTICATION RESPONSE	-	-
9	The SS transmits a NAS SECURITY MODE COMMAND message to activate NAS security.	<--	SECURITY MODE COMMAND	-	-
10	The UE transmits a NAS SECURITY MODE COMPLETE message and establishes the initial security configuration.	-->	SECURITY MODE COMPLETE	-	-
-	EXCEPTION: Steps 11a1 to 11a2 describe behaviour that depends on UE configuration; the "lower case letter" identifies a step sequence that take place if the UE has ESM information which needs to be transferred after NAS SECURITY MODE COMPLETE message.	-	-	-	-
11a1	IF the UE sets the ESM information transfer flag in the last PDN CONNECTIVITY REQUEST message THEN the SS transmits an ESM INFORMATION REQUEST message to initiate exchange of protocol configuration options and/or APN.	<--	ESM INFORMATION REQUEST	-	-
11a2	The UE transmits an ESM INFORMATION RESPONSE message to transfer protocol configuration options and/or APN.	-->	ESM INFORMATION RESPONSE	-	-
12	The SS responds with an ATTACH ACCEPT message. The ACTIVATE DEFAULT EPS BEARER CONTEXT REQUEST message is piggybacked in ATTACH ACCEPT message.	<--	ATTACH ACCEPT	-	-
-	EXCEPTION: In parallel to the event described in step 13 below the generic procedure for IP address allocation in the U-plane specified in TS 36.508 subclause 4.5A.1 takes place performing IP address allocation in the U-plane if requested by the UE.	-	-	-	-
13	The UE transmits an ATTACH COMPLETE message including an ACTIVATE DEFAULT EPS BEARER CONTEXT ACCEPT message.	-->	ATTACH COMPLETE	-	-

14	The SS releases the RRC connection.	-	-	-	-
-	EXCEPTION: Steps 15a1 to 15b2 describe behaviour that depends on the UE capability; the "lower case letter" identifies a step sequence that take place if a capability is supported	-	-	-	-
15a1	IF (px_AttachTypeTested == COMBINED_ATTACH) and (pc_CS_Fallback is true) THEN the SS pages the UE using S-TMSI with CN domain indicator set to "CS".	-	-	-	-
15a2	The UE transmits an EXTENDED SERVICE REQUEST message.	-->	EXTENDED SERVICE REQUEST	-	-
15b1	ELSE the SS pages the UE using S-TMSI with CN domain indicator set to "PS".	-	-	-	-
15b2	The UE transmits a SERVICE REQUEST message.	-->	SERVICE REQUEST	-	-
16	The SS transmits a DETACH REQUEST message with the Type of detach set to the value other than 're-attach required'.	<--	DETACH REQUEST	-	-
17	Check: Does the UE transmit a DETACH ACCEPT message?	-->	DETACH ACCEPT	2	P
18	The SS releases the RRC connection.	-	-	-	-
-	At the end of this test procedure sequence, the UE is in end state E-UTRA deregistered (E4) according to TS 36.508.	-	-	-	-

Note 1: SS waits for 1 second to receive the Attach Request on the existing RRC Connection. In case Attach Request is not received within 1 second, existing RRC Connection is released.

9.3.1.17.3.3 Specific message contents

Table 9.3.1.17.3.3-1: Message DETACH REQUEST (step 3, Table 9.3.1.17.3.2-1)

Derivation Path: TS 36.508 Table 4.7.2-12			
Information Element	Value/remark	Comment	Condition
Detach type			
Type of detach	'001'B	re-attach required	
EMM cause	Not present	If the detach type IE indicates "IMSI detach" or "re-attach required", then the UE shall ignore the EMM cause IE if received.	

Table 9.3.1.17.3.3-2: Message DETACH REQUEST (step 16, Table 9.3.1.17.3.2-1)

Derivation Path: TS 36.508 Table 4.7.2-12			
Information Element	Value/remark	Comment	Condition
Detach type			
Type of detach	'010'B	re-attach not required	
EMM cause	'0000 0011'B	Illegal UE	

9.3.1.18 Service Request / Rejected / Not authorized for this CSG

9.3.1.18.1 Test Purpose (TP)

(1)

```
with { UE having sent a SERVICE REQUEST message }
ensure that {
  when { UE receives a SERVICE REJECT message with the EMM cause value = 25 (Not authorized for this CSG) and this SERVICE REJECT message is not without integrity protection }
```

```

    then { UE sets the EPS update status to EU3 ROAMING NOT ALLOWED, removes the CSG ID of the cell
that sent SERVICE REJECT message from the Allowed CSG list, searches for a suitable cell in the same
PLMN }
}

```

(2)

```

with { UE in state EMM-REGISTERED and EMM-IDLE mode and the CSG ID is removed from the Allowed CSG
list }
ensure that {
  when { UE detects entering new tracking areas not included in the TAI list }
  then { UE attempts to enter a normal cell and does not select a cell which is not included in
the allowed CSG list }
}

```

9.3.1.18.2 Conformance requirements

References: The conformance requirements covered in the present TC are specified in: TS 24.301, clause 5.6.1.5.

[TS 24.301, clause 5.6.1.5]

On receipt of the SERVICE REJECT message, the UE shall stop timer T3417 and take the following actions depending on the received EMM cause value.

...

#25 (Not authorized for this CSG);

Cause #25 is only applicable when received from a CSG cell. Cause #25 received from a non-CSG cell is considered as an abnormal case and the behaviour of the UE is specified in subclause 5.6.1.6.

If the SERVICE REJECT message with cause #25 was received without integrity protection, then the UE shall discard the message.

The UE shall set the EPS update status to EU3 ROAMING NOT ALLOWED (and shall store it according to subclause 5.1.3.3). The UE shall enter the state EMM-REGISTERED.LIMITED-SERVICE.

The UE shall remove the CSG ID of the cell where the UE has initiated the service request procedure from the Allowed CSG list.

The UE shall search for a suitable cell in the same PLMN according to 3GPP TS 36.304 [21].

9.3.1.18.3 Test description

9.3.1.18.3.1 Pre-test conditions

System Simulator:

- cell A(TAC1, frequency 1, is a CSG cell);
- cell B(TAC2, frequency 1, not a CSG cell);
- cell A is "Serving cell" and cell B " Non-suitable cell".
- System information combination 3 as defined in TS 36.508[18] clause 4.4.3.1 is used in E-UTRA cell B.
- System information combination 7 as defined in TS 36.508[18] clause 4.4.3.1 is used in cell A;

UE:

- the UE is previously registered on cell A using manual CSG selection (so the allowed CSG list includes CSG ID of cell A).

Preamble:

- The UE is in state Registered, Idle mode (state 2) on cell A according to [18].

9.3.1.18.3.2 Test procedure sequence

Table 9.3.1.18.3.2-1: Main behaviour

St	Procedure	Message Sequence		TP	Verdict
		U - S	Message		
1	The SS pages the UE using S-TMSI with CN domain indicator set to "PS".	-	-	-	-
-	The following messages are sent and shall be received on Cell A.	-	-	-	-
2	The UE transmits a SERVICE REQUEST message.	-->	SERVICE REQUEST	-	-
3	The SS transmits a SERVICE REJECT message with the EMM cause = " Not authorized for this CSG " as specified.	<--	SERVICE REJECT	-	-
4	The SS releases the RRC connection.	-	-	-	-
5	The SS configures: - Cell A as a "Serving cell". - Cell B as a "Suitable Neighbour intra-frequency cell".	-	-	-	-
6	Check: Does the UE transmit a TRACKING AREA UPDATE REQUEST message on cell B?	-->	TRACKING AREA UPDATE REQUEST	1	P
7	The SS transmits a TRACKING AREA UPDATE ACCEPT message.	<--	TRACKING AREA UPDATE ACCEPT	-	-
8	The UE transmits a TRACKING AREA UPDATE COMPLETE message.	-->	TRACKING AREA UPDATE COMPLETE	-	-
8A	The SS releases the RRC connection.	-	-	-	-
9	The SS configures: - Cell A as a " Serving cell". - Cell B as a " Not Suitable cell".	-	-	-	-
10	Check: Does the UE transmit a TRACKING AREA UPDATE REQUEST message on cell A in the next 30 seconds?	-->	TRACKING AREA UPDATE REQUEST	2	F

9.3.1.18.3.3 Specific message contents

Table 9.3.1.18.3.3-1: SERVICE REJECT (step 3, Table 9.3.1.18.3.2-1)

Derivation Path: TS 36.508 Table 4.7.2-22			
Information Element	Value/remark	Comment	Condition
EMM cause	'00011001'B	#25 "Not authorized for this CSG"	

Table 9.3.1.18.3.3-2: SystemInformationBlockType1 for Cell A, B(Pre-test conditions and all steps in Table 9.3.1.18.3.2-1)

Derivation Path: 36.508 clause 4.4.3.2			
Information Element	Value/remark	Comment	Condition
SystemInformationBlockType1 ::= SEQUENCE {			
cellAccessRelatedInfo SEQUENCE {			
csg-Indication	TRUE		Cell A
	FALSE		Cell B
csg-Identity	Not present		Cell B
	'000 0000 0000 0000 0000 0000 0010'B		Cell A

9.3.2 Paging procedure

9.3.2.1 Paging procedure

9.3.2.1.1 Test Purpose (TP)

(1)

```
with { UE in ECM-IDLE }
ensure that {
  when { the network initiates a paging procedure for EPS services using S-TMSI }
  then { the UE responds to the paging with a SERVICE REQUEST message providing correct S-TMSI in
the RRCConectionRequest }
}
```

9.3.2.1.2 Conformance requirements

References: The conformance requirements covered in the current TC are specified in: TS 24.301, clauses 5.6.1.1, 5.6.2.2.1, TS 33.401 clause 7.2.6.2, TS 36.331 clause 5.3.3.3.

[TS 24.301, clause 5.6.2.2.1]

To initiate the procedure the EMM entity in the network requests the lower layer to start paging (see 3GPP TS 36.300 [20], 3GPP TS 36.413 [23]) and starts the timer T3413 for this paging procedure. Upon reception of a paging indication, the UE shall respond to the paging with a SERVICE REQUEST message (see 3GPP TS 23.401 [10] and 3GPP TS 36.413 [23]). If the paging for EPS services was received during an ongoing UE initiated EMM specific procedure or service request procedure, then the UE shall ignore the paging and the UE and the network shall proceed with the EMM specific procedure or the service request procedure.

[TS 24.301, clause 5.6.1.1]

The UE shall invoke the service request procedure when:

- a) the UE in EMM-IDLE mode receives a paging request with CN domain indicator set to "PS" from the network;

[TS 33.401 clause 7.2.6.2]

The procedure the UE uses to transit from ECM-IDLE to ECM-CONNECTED when in EMM-REGISTERED state is initiated by a NAS Service Request message from the UE to the MME. As the UE is in EMM-REGISTERED state, a EPS security context exists in the UE and the MME, and this EPS security context further contains uplink and downlink NAS COUNTs. The NAS Service Request message sent in EMM-REGISTERED shall be integrity protected and contain the uplink NAS sequence number.

[TS 36.331, clause 5.3.3.3]

The UE shall set the contents of *RRCCo*nectionRequest message as follows:

- 1> set the *ue-Identity* as follows:
 - 2> if upper layers provide an S-TMSI:
 - 3> set the *ue-Identity* to the value received from upper layers;

9.3.2.1.3 Test description

9.3.2.1.3.1 Pre-test conditions

System Simulator:

- cell A.

UE:

- none.

Preamble:

- the UE is in Registered, Idle Mode (state 2) according to TS 36.508 [18].

9.3.2.1.3.2 Test procedure sequence

Table 9.3.2.1.3.2-1: Main behaviour

St	Procedure	Message Sequence		TP	Verdict
		U - S	Message		
1	SS pages the UE using S-TMSI with CN domain indicator set to "PS"	-	-	-	-
2	Check: Does the UE transmit <i>RRCConnectionRequest</i> message providing correct S-TMSI?	-	-	1	P
3	Check: Does the UE respond with a SERVICE REQUEST message?	-->	SERVICE REQUEST	1	P
4-7	Steps 6 to 9 of the generic radio bearer establishment procedure (TS 36.508 4.5.3.3-1) are executed to successfully complete the service request procedure.	-	-	-	-

9.3.2.1.3.3 Specific message contents

Table 9.3.2.1.3.3-1: *RRCConnectionRequest* (step 2, Table 9.3.2.1.3.2-1)

Derivation Path: Table 4.6.1-16			
Information Element	Value/remark	Comment	Condition
<i>RRCConnectionRequest</i> ::= SEQUENCE {			
criticalExtensions CHOICE {			
<i>rrcConnectionRequest-r8</i> SEQUENCE {			
ue-Identity[1] CHOICE {			
s-TMSI	Set to the value of the S-TMSI of the UE		
}			
}			
}			
}			

9.3.2.2 Paging for CS fallback / Idle mode

9.3.2.2.1 Test Purpose (TP)

(1)

```
with { UE in state EMM-REGISTERED and EMM-IDLE mode}
ensure that {
  when { UE received Paging for mobile termination CS fallback from NW }
  then { UE establishes the RRC connection with the RRC establishmentCause set to 'mt-Access' and sends EXTENDED SERVICE REQUEST message }
}
```

9.3.2.2.2 Conformance requirements

References: The conformance requirements covered in the present TC are specified in: 3GPP TS 24.301 clauses 5.3.1.1, 5.6.1.1, 5.6.2.3 and Annex D and TS 36.331 clause 5.3.3.3.

[TS 24.301 clause 5.3.1.1]

When the UE is in EMM-IDLE mode and needs to transmit an initial NAS message, the UE shall request the lower layer to establish a NAS signalling connection. In this request to the lower layer the NAS shall provide to the lower layer the RRC establishment cause and the call type as specified in annex D of this specification.

[TS24.301 clause5.6.1.1]

The purpose of the service request procedure is to transfer the EMM mode from EMM-IDLE to EMM-CONNECTED mode and establish the radio and S1 bearers when uplink user data or signalling is to be sent. Another purpose of this procedure is to invoke MO/MT CS fallback procedures.

This procedure is used when:

...

- the UE in EMM-IDLE or EMM-CONNECTED mode has requested to perform mobile originating/terminating CS fallback; or

...

The service request procedure is initiated by the UE, however, for the downlink transfer of signalling or user data in EMM-IDLE mode, the trigger is given by the network by means of the paging procedure (see subclause 5.6.2).

The UE shall invoke the service request procedure when:

...

- e) the UE, in EMM-IDLE or EMM-CONNECTED mode, has a CS fallback response to be sent to the network; or

...

[TS24.301 clause5.6.2.3]

The network may initiate the paging procedure for non-EPS services when the UE is IMSI attached for non-EPS services.

To initiate the procedure when no NAS signalling connection exists, the EMM entity in the network requests the lower layer to start paging (see 3GPP TS 36.300 [2012], 3GPP TS 36.413 [2315]) and starts the timer T3413 for this paging procedure. The paging message includes a CN domain indicator set to "CS" in order to indicate that this is paging for CS fallback. Upon reception of a paging indication, the UE may respond to the paging immediately or may request upper layers input i.e. to accept or reject CS fallback. The response is indicated in the CSFB response information element in the EXTENDED SERVICE REQUEST message in both EMM-IDLE and EMM-CONNECTED modes.

The network shall stop the timer T3413 for the paging procedure when a response is received from the UE.

To notify the UE about an incoming mobile terminating CS service when a NAS signalling connection exists, the EMM entity in the network shall send a CS SERVICE NOTIFICATION message.

[TS 24.301, Annex D]

...

Table D.1.1: Mapping of NAS procedure to establishment cause and call type

NAS procedure	RRC establishment cause (according 3GPP TS 36.331 [22])	Call type
...		
Service Request	If a EXTENDED SERVICE REQUEST has service type set to "mobile terminating CS fallback", the RRC establishment cause shall be set to MT access. (See Note1).	"terminating calls"
...		
Note 1: For these NAS procedures initiated by UEs of access class 12, 13 or 14 in their home country, the RRC establishment cause will be set to "High priority access AC 11 – 15". For this purpose the home country is defined as the country of the MCC part of the IMSI, see 3GPP TS 22.011 [1A]. For these NAS procedures initiated by UE of access class 11 or 15 in their HPLMN or EHPLMN, the RRC establishment cause will be set to "High priority access AC 11 – 15".		

[TS 36.331, clause 5.3.3.3]

...

The UE shall set the contents of *RRCConnectionRequest* message as follows:

1> set the *ue-Identity* as follows:

2> if upper layers provide an S-TMSI:

3> set the *ue-Identity* to the value received from upper layers;

2> else

3> draw a random value and set the *ue-Identity* to this value;

NOTE 1: Upper layers provide the S-TMSI if the UE is registered in the TA of the current cell.

1> Set the *establishmentCause* in accordance with the information received from upper layers;

9.3.2.2.3 Test description

9.3.2.2.3.1 Pre-test conditions

System Simulator:

- cell A.

UE:

none.

Preamble:

- the UE is in state Registered, Idle Mode (state 2) on cell A according to TS 36.508 [18].

9.3.2.2.3.2 Test procedure sequence

Table 9.3.2.2.3.2-1: Main behaviour

St	Procedure	Message Sequence		TP	Verdict
		U - S	Message		
1	The SS sends a paging message which CN domain indicates "CS" domain to the UE.	-	-	-	-
2	The UE accepts CS fallback	-	-	-	-
3	Check: Does the UE transmit an <i>RRCConnectionRequest</i> message with <i>establishmentCause</i> set to 'mt-Access' followed by EXTENDED SERVICE REQUEST message?	-->	EXTENDED SERVICE REQUEST	1	P
4	The SS sends SERVICE REJECT message with T3442 = 60 seconds in order that the UE enters EMM-REGISTERED.NORMAL-SERVICE.	<--	SERVICE REJECT	-	-
5	The SS releases the RRC connection.	-	-	-	-
-	EXCEPTION: The behaviour in table 9.3.2.2.3.2-2 may occur in parallel with step 6.	-	-	-	-
6	SS waits for 60 seconds (T3442)	-	-	-	-

Table 9.3.2.2.3.2-2: Parallel Behaviour

St	Procedure	Message Sequence		TP	Verdict
		U - S	Message/PDU/SDU		
1	The UE transmits a TRACKING AREA UPDATE REQUEST message.	-->	TRACKING AREA UPDATE REQUEST	-	-
2	The SS transmits a TRACKING AREA UPDATE ACCEPT message.	<--	TRACKING AREA UPDATE ACCEPT	-	-
3	The SS releases the RRC connection.	-	-	-	-

9.3.2.2.3.3 Specific message contents

Table 9.3.2.2.3.3-0: Message *RRConnectionRequest* (step 3, Table 9.3.2.2.3.2-1)

Derivation path: 36.508 table 4.6.1-16			
Information Element	Value/Remark	Comment	Condition
RRConnectionRequest ::= SEQUENCE {			
criticalExtensions CHOICE {			
rrcConnectionRequest-r8 SEQUENCE {			
establishmentCause	mt-Access		
}			
}			
}			

Table 9.3.2.2.3.3-1: Message EXTENDED SERVICE REQUEST (step 3, Table 9.3.2.2.3.2-1)

Derivation Path: 36.508 clause 4.7.2-14A			
Information Element	Value/remark	Comment	Condition
M-TMSI	M-TMSI1		

Table 9.3.2.2.3.3-2: Message SERVICE REJECT (step 4, Table 9.3.2.2.3.2-1)

Derivation Path: 36.508 clause 4.7.2-22			
Information Element	Value/remark	Comment	Condition
EMM cause	'0010 0111'B	CS domain temporarily not available	
T3442 value	'0010 0001'B	1 minute	

Table 9.3.2.2.3.3-3: Message TRACKING AREA UPDATE ACCEPT (step 2, Table 9.3.2.2.3.2-2)

Derivation path: 36.508 table 4.7.2-24			
Information Element	Value/Remark	Comment	Condition
GUTI	Not present		
MS identity	Not present		

9.3.2.2a Paging for CS fallback / Connected mode

9.3.2.2a.1 Test Purpose (TP)

(1)

```

with { UE in state EMM-REGISTERED and EMM-CONNECTED mode}
ensure that {
  when { UE receives a CS SERVICE NOTIFICATION message for mobile termination CS fallback from NW }
  then { UE sends EXTENDED SERVICE REQUEST message }
}

```

9.3.2.2a.2 Conformance requirements

References: The conformance requirements covered in the present TC are specified in: 3GPP TS 24.301 clauses 5.3.1.1, 5.6.1.1, 5.6.2.3 and Annex D and TS 36.331 clause 5.3.3.3.

[TS 24.301 clause 5.3.1.1]

When the UE is in EMM-IDLE mode and needs to transmit an initial NAS message, the UE shall request the lower layer to establish a NAS signalling connection. In this request to the lower layer the NAS shall provide to the lower layer the RRC establishment cause and the call type as specified in annex D of this specification.

[TS24.301 clause5.6.1.1]

The purpose of the service request procedure is to transfer the EMM mode from EMM-IDLE to EMM-CONNECTED mode and establish the radio and S1 bearers when uplink user data or signalling is to be sent. Another purpose of this procedure is to invoke MO/MT CS fallback procedures.

This procedure is used when:

...

- the UE in EMM-IDLE or EMM-CONNECTED mode has requested to perform mobile originating/terminating CS fallback; or

...

The service request procedure is initiated by the UE, however, for the downlink transfer of signalling or user data in EMM-IDLE mode, the trigger is given by the network by means of the paging procedure (see subclause 5.6.2).

The UE shall invoke the service request procedure when:

...

- e) the UE, in EMM-IDLE or EMM-CONNECTED mode, has a CS fallback response to be sent to the network; or

...

[TS24.301 clause5.6.2.3]

The network may initiate the paging procedure for non-EPS services when the UE is IMSI attached for non-EPS services.

To initiate the procedure when no NAS signalling connection exists, the EMM entity in the network requests the lower layer to start paging (see 3GPP TS 36.300 [2012], 3GPP TS 36.413 [2315]) and starts the timer T3413 for this paging procedure. The paging message includes a CN domain indicator set to "CS" in order to indicate that this is paging for CS fallback. Upon reception of a paging indication, the UE may respond to the paging immediately or may request upper layers input i.e. to accept or reject CS fallback. The response is indicated in the CSFB response information element in the EXTENDED SERVICE REQUEST message in both EMM-IDLE and EMM-CONNECTED modes.

The network shall stop the timer T3413 for the paging procedure when a response is received from the UE.

To notify the UE about an incoming mobile terminating CS service when a NAS signalling connection exists, the EMM entity in the network shall send a CS SERVICE NOTIFICATION message.

[TS 24.301, Annex D]

...

Table D.1.1: Mapping of NAS procedure to establishment cause and call type

NAS procedure	RRC establishment cause (according 3GPP TS 36.331 [22])	Call type
...		
Service Request	If a EXTENDED SERVICE REQUEST has service type set to "mobile terminating CS fallback", the RRC establishment cause shall be set to MT access. (See Note1).	"terminating calls"
...		
Note 1: For these NAS procedures initiated by UEs of access class 12, 13 or 14 in their home country, the RRC establishment cause will be set to "High priority access AC 11 – 15". For this purpose the home country is defined as the country of the MCC part of the IMSI, see 3GPP TS 22.011 [1A]. For these NAS procedures initiated by UE of access class 11 or 15 in their HPLMN or EHPLMN, the RRC establishment cause will be set to "High priority access AC 11 – 15".		

9.3.2.2a.3 Test description

9.3.2.2a.3.1 Pre-test conditions

System Simulator:

- Cell A(TAI-1) is set to "Serving cell"

UE:

None.

Preamble:

- The UE is in state Generic RB established (state 3) on cell A according to [18].

9.3.2.2a.3.2 Test procedure sequence

Table 9.3.2.2a.3.2-1: Main behaviour

St	Procedure	Message Sequence		TP	Verdict
		U - S	Message		
1	The SS sends a CS SERVICE NOTIFICATION message to the UE.	<--	CS SERVICE NOTIFICATION	-	-
2	The UE accepts CS fallback	-		-	-
3	Check: Does the UE transmit an EXTENDED SERVICE REQUEST message to SS?	-->	EXTENDED SERVICE REQUEST	1	P
4	The SS sends a SERVICE REJECT message with T3442 = 60 seconds in order that the UE enters EMM-REGISTERED.NORMAL-SERVICE.	<--	SERVICE REJECT	-	-
5	The SS releases the RRC connection.	-	-	-	-
-	EXCEPTION: The behaviour in table 9.3.2.2a.3.2-2 may occur in parallel with step 6.	-	-	-	-
6	SS waits for 60 seconds (T3442)	-	-	-	-

Table 9.3.2.2a.3.2-2: Parallel Behaviour

St	Procedure	Message Sequence		TP	Verdict
		U - S	Message/PDU/SDU		
1	The UE transmits a TRACKING AREA UPDATE REQUEST message.	-->	TRACKING AREA UPDATE REQUEST	-	-
2	The SS transmits a TRACKING AREA UPDATE ACCEPT message.	<--	TRACKING AREA UPDATE ACCEPT	-	-
3	The SS releases the RRC connection.	-	-	-	-

9.3.2.2a.3.3 Specific message contents

Table 9.3.2.2a.3.3-1: Message EXTENDED SERVICE REQUEST (step 3, Table 9.3.2.2a.3.2-1)

Derivation Path: 36.508 clause 4.7.2-14A			
Information Element	Value/remark	Comment	Condition
M-TMSI	M-TMSI1		

Table 9.3.2.2a.3.3-2: Message SERVICE REJECT (step 4, Table 9.3.2.2a.3.2-1)

Derivation Path: 36.508 clause 4.7.2-22			
Information Element	Value/remark	Comment	Condition
EMM cause	'00100111'B	CS domain temporarily not available	
T3442 value	'0010 0001'B'	1 minute	

Table 9.3.2.2a.3.3-3: Message TRACKING AREA UPDATE ACCEPT (step 2, Table 9.3.2.2a.3.2-2)

Derivation path: 36.508 table 4.7.2-24			
Information Element	Value/Remark	Comment	Condition
GUTI	Not present		
MS identity	Not present		

9.4 NAS Security

9.4.1 Integrity protection / Correct functionality of EPS NAS integrity algorithm / SNOW3G

9.4.1.1 Test Purpose (TP)

(1)

```
with { successful completion of EPS authentication and key agreement (AKA) procedure }
ensure that {
  when { UE receives a an integrity protected SECURITY MODE COMMAND message instructing to start
integrity protection using algorithm SNOW3G }
  then { UE transmits an integrity protected SECURITY MODE COMPLETE using SNOW3G and starts
applying the NAS Integrity protection in both UL and DL }
```

(2)

```
with { Integrity protection successful started by executing Security Mode Procedure}
ensure that {
  when { UE receives an IDENTITY REQUEST message without integrity protected }
  then { UE does not transmit an IDENTITY RESPONSE message }
}
```

9.4.1.2 Conformance requirements

References: The conformance requirements covered in the current TC are specified in: TS 24.301 clause 4.4.4.1, 4.4.4.2, 5.4.3.1, 5.4.3.2 and 5.4.3.3.

[TS 24.301, clause 4.4.4.1]

For the UE, integrity protected signalling is mandatory for the NAS messages once a valid EPS security context exists and has been taken into use. For the network, integrity protected signalling is mandatory for the NAS messages once a secure exchange of NAS messages has been established for the NAS signalling connection. Integrity protection of all NAS signalling messages is the responsibility of the NAS. It is the network which activates integrity protection.

[TS 24.301, clause 4.4.4.2]

Once the secure exchange of NAS messages has been established, the receiving EMM or ESM entity in the UE shall not process any NAS signalling messages unless they have been successfully integrity checked by the NAS. If NAS signalling messages, having not successfully passed the integrity check, are received, then the NAS in the UE shall discard that message. If any NAS signalling message is received as not integrity protected even though the secure exchange of NAS messages has been established by the network, then the NAS shall discard this message.

[TS 24.301, clause 5.4.3.1]

The purpose of the NAS security mode control procedure is to take an EPS security context into use, and initialise and start NAS signalling security between the UE and the MME with the corresponding NAS keys and security algorithms.

[TS 24.301, clause 5.4.3.2]

The MME initiates the NAS security mode control procedure by sending a SECURITY MODE COMMAND message to the UE and starting timer T3460 (see example in figure 5.4.3.2.1).

If the security mode control procedure is initiated further to a successful execution of the authentication procedure, the MME shall use the reset downlink NAS COUNT to integrity protect the SECURITY MODE COMMAND message.

The MME shall send the SECURITY MODE COMMAND message unciphered, but shall integrity protect the message with the NAS integrity key based on K_{ASME} or mapped K'_{ASME} indicated by the eKSI included in the message. The MME shall set the security header type of the message to "integrity protected with new EPS security context".

...

The MME shall include the replayed security capabilities of the UE (including the security capabilities with regard to NAS, RRC and UP (user plane) ciphering as well as NAS, RRC integrity, and other possible target network security capabilities, i.e. UTRAN/GERAN if UE included them in the message to network), the replayed nonce_{UE} if the UE included it in the message to the network, the selected NAS ciphering and integrity algorithms and the Key Set Identifier (eKSI).

Additionally, the MME may request the UE to include its IMEISV in the SECURITY MODE COMPLETE message.

NOTE: The AS and NAS security capabilities will be the same, i.e. if the UE supports one algorithm for NAS it is also be supported for AS.

[TS 24.301, clause 5.4.3.3]

Upon receipt of the SECURITY MODE COMMAND message, the UE shall check whether the security mode command can be accepted or not. This is done by performing the integrity check of the message and by checking that the received UE security capabilities and the received nonce_{UE} have not been altered compared to what the UE provided in the initial layer 3 message that triggered this procedure.

If the type of security context flag is set to "native security context" and if the KSI matches a valid native EPS security context held in the UE while the UE has a mapped EPS security context as the current security context, the UE shall take the native EPS security context into use.

If the security mode command can be accepted, the UE shall reset the uplink NAS COUNT and the UE shall take the new EPS security context into use when:

- a) the SECURITY MODE COMMAND message is received further to a successful execution of the authentication procedure; or
- b) the type of security context flag is set to "mapped security context" in the NAS KSI IE included in the SECURITY MODE COMMAND message

If the security mode command can be accepted, the UE shall send a SECURITY MODE COMPLETE message integrity protected with the selected NAS integrity algorithm and the NAS integrity key based on the K_{ASME} or mapped K'_{ASME} if the type of security context flag is set to "mapped security context" indicated by the eKSI. If the SECURITY MODE COMMAND message includes the type of security context flag set to "mapped security context" in the NAS KSI IE, nonce_{MME} and nonce_{UE}, the UE shall generate K'_{ASME} from both nonces as indicated in 3GPP TS 33.401 [19] and reset the downlink NAS COUNT to check whether the SECURITY MODE COMMAND can be accepted or not. The UE shall cipher the SECURITY MODE COMPLETE message with the selected NAS ciphering algorithm and the NAS ciphering key based on the K_{ASME} or mapped K'_{ASME} indicated by the eKSI. The UE shall set the security header type of the message to "integrity protected and ciphered with new EPS security context".

From this time onward the UE shall cipher and integrity protect all NAS signalling messages with the selected NAS ciphering and NAS integrity algorithms.

If the MME indicated in the SECURITY MODE COMMAND message that the IMEISV is requested, the UE shall include its IMEISV in the SECURITY MODE COMPLETE message.

9.4.1.3 Test description

9.4.1.3.1 Pre-test conditions

System Simulator:

- cell A.

UE:

none.

Preamble:

- the UE is in state Switched OFF (state 1) according to TS 36.508 [18].

9.4.1.3.2 Test procedure sequence

Table 9.4.1.3.2-1: Main behaviour

St	Procedure	Message Sequence		TP	Verdict
		U - S	Message		
1	The UE is switched on.	-	-	-	-
2	The UE transmits an ATTACH REQUEST message including a PDN CONNECTIVITY REQUEST message	-->	ATTACH REQUEST	-	-
3	The SS transmits an AUTHENTICATION REQUEST message to initiate the EPS authentication and AKA procedure.	<--	AUTHENTICATION REQUEST	-	-
4	The UE transmits an AUTHENTICATION RESPONSE message and establishes mutual authentication.	-->	AUTHENTICATION RESPONSE	-	-
5	The SS transmits a NAS SECURITY MODE COMMAND message to activate NAS security. It is integrity protected.	<--	SECURITY MODE COMMAND	-	-
6	Check: Does the UE transmit a NAS SECURITY MODE COMPLETE message and starts applying the NAS Integrity protection in both UL and DL?	-->	SECURITY MODE COMPLETE	1	P
-	EXCEPTION: Steps 6Aa1 to 6Aa2 describe behaviour that depends on UE configuration; the "lower case letter" identifies a step sequence that take place if the UE has ESM information which needs to be transferred.	-	-	-	-
6A a1	IF the UE sets the ESM information transfer flag in the last PDN CONNECTIVITY REQUEST message THEN the SS transmits an ESM INFORMATION REQUEST message to initiate exchange of protocol configuration options and/or APN.	<--	ESM INFORMATION REQUEST	-	-
6A a2	The UE transmits an ESM INFORMATION RESPONSE message to transfer protocol configuration options and/or APN.	-->	ESM INFORMATION RESPONSE	-	-
7	The SS transmits with an ATTACH ACCEPT message. The ACTIVATE DEFAULT EPS BEARER CONTEXT REQUEST message is piggybacked in ATTACH ACCEPT message	<--	ATTACH ACCEPT	-	-
8	The UE transmits an ATTACH COMPLETE message including an ACTIVATE DEFAULT EPS BEARER CONTEXT ACCEPT message	-->	ATTACH COMPLETE	-	-
9	The SS transmits an IDENTITY REQUEST message with Integrity protected and with default ciphering	<-	IDENTITY REQUEST	-	-
10	Check: Does the UE transmit an IDENTITY RESPONSE message with Integrity Protected and with default ciphering?	->	IDENTITY RESPONSE	1	P
11	The SS transmits an IDENTITY REQUEST message (not Integrity protected)	<-	IDENTITY REQUEST	-	-
12	Check: Does the UE transmit an IDENTITY RESPONSE message within the next 5 seconds?	->	IDENTITY RESPONSE	2	F

9.4.1.3.3 Specific message contents

Table 9.4.1.3.3-1: SECURITY MODE COMMAND (Step 5)

Derivation path: 36.508 table 4.7.2-19			
Information Element	Value/Remark	Comment	Condition
Selected NAS security algorithms			
- Type of integrity protection algorithm	001	EPS integrity algorithm 128-EIA1[SNOW3G]	

9.4.2 Integrity protection / Correct functionality of EPS NAS integrity algorithm / AES

9.4.2.1 Test Purpose (TP)

(1)

```
with { successful completion of EPS authentication and key agreement (AKA) procedure }
ensure that {
  when { UE receives an integrity protected SECURITY MODE COMMAND message, to start integrity
protection using algorithm AES }
  then { UE sends SECURITY MODE COMPLETE, integrity protected with AES and starts applying the NAS
Integrity protection in both UL and DL}
```

(2)

```
with { Integrity protection successful started by executing Security Mode Procedure}
ensure that {
  when { UE receives a IDENTITY REQUEST message (requested identification parameter is not IMSI),
without integrity protected }
  then { UE Does not transmit IDENTITY Response}
}
```

9.4.2.2 Conformance requirements

Same Conformance requirements as in clause 9.4.1.2

9.4.2.3 Test description

9.4.2.3.1 Pre-test conditions

Same Pre-test conditions as in clause 9.4.1.3.1

9.4.2.3.2 Test procedure sequence

Same Test procedure sequence as in table 9.4.1.3.2.1, except the integrity protection algorithm is AES.

9.4.2.3.3 Specific message contents

Table 9.4.2.3.3-1: SECURITY MODE COMMAND (Step 6)

Derivation path: 36.508 table 4.7.2-19			
Information Element	Value/Remark	Comment	Condition
Selected NAS security algorithms			
- Type of integrity protection algorithm	010	EPS integrity algorithm 128-EIA2 (AES)	

9.4.3 Cipherng and deciphering / Correct functionality of EPS NAS encryption algorithm / SNOW3G

9.4.3.1 Test Purpose (TP)

(1)

```
with { successful completion of EPS authentication and key agreement (AKA) procedure }
```

```

ensure that {
  when { UE receives a SECURITY MODE COMMAND instructing to start ciphering using algorithm SNOW3G }
  then { UE sends a SECURITY MODE COMPLETE message ciphered with SNOW3G and starts applying the
NAS ciphering in both UL and DL}
}

```

9.4.3.2 Conformance requirements

References: The conformance requirements covered in the current TC are specified in: TS 24.301 clause 5.4.3.1, 5.4.3.2 and 5.4.3.3.

[TS 24.301, clause 5.4.3.1]

The purpose of the NAS security mode control procedure is to take an EPS security context into use, and initialise and start NAS signalling security between the UE and the MME with the corresponding NAS keys and security algorithms.

[TS 24.301, clause 5.4.3.2]

The MME initiates the NAS security mode control procedure by sending a SECURITY MODE COMMAND message to the UE and starting timer T3460 (see example in figure 5.4.3.2.1).

If the security mode control procedure is initiated further to a successful execution of the authentication procedure, the MME shall use the reset downlink NAS COUNT to integrity protect the SECURITY MODE COMMAND message.

The MME shall send the SECURITY MODE COMMAND message unciphered, but shall integrity protect the message with the NAS integrity key based on K_{ASME} or mapped K'_{ASME} indicated by the eKSI included in the message. The MME shall set the security header type of the message to "integrity protected with new EPS security context".

...

The MME shall include the replayed security capabilities of the UE (including the security capabilities with regard to NAS, RRC and UP (user plane) ciphering as well as NAS, RRC integrity, and other possible target network security capabilities, i.e. UTRAN/GERAN if UE included them in the message to network), the replayed $nonce_{UE}$ if the UE included it in the message to the network, the selected NAS ciphering and integrity algorithms and the Key Set Identifier (eKSI).

Additionally, the MME may request the UE to include its IMEISV in the SECURITY MODE COMPLETE message.

NOTE: The AS and NAS security capabilities will be the same, i.e. if the UE supports one algorithm for NAS it is also be supported for AS.

[TS 24.301, clause 5.4.3.3]

Upon receipt of the SECURITY MODE COMMAND message, the UE shall check whether the security mode command can be accepted or not. This is done by performing the integrity check of the message and by checking that the received UE security capabilities and the received $nonce_{UE}$ have not been altered compared to what the UE provided in the initial layer 3 message that triggered this procedure.

If the type of security context flag is set to "native security context" and if the KSI matches a valid native EPS security context held in the UE while the UE has a mapped EPS security context as the current security context, the UE shall take the native EPS security context into use.

If the security mode command can be accepted, the UE shall reset the uplink NAS COUNT and the UE shall take the new EPS security context into use when:

- a) the SECURITY MODE COMMAND message is received further to a successful execution of the authentication procedure; or
- b) the type of security context flag is set to "mapped security context" in the NAS KSI IE included in the SECURITY MODE COMMAND message

If the security mode command can be accepted, the UE shall send a SECURITY MODE COMPLETE message integrity protected with the selected NAS integrity algorithm and the NAS integrity key based on the K_{ASME} or mapped K'_{ASME} if the type of security context flag is set to "mapped security context" indicated by the eKSI. If the SECURITY MODE COMMAND message includes the type of security context flag set to "mapped security context" in the NAS KSI IE, $nonce_{MME}$ and $nonce_{UE}$, the UE shall generate K'_{ASME} from both nonces as indicated in 3GPP TS 33.401 [19] and reset the downlink NAS COUNT to check whether the SECURITY MODE COMMAND can be accepted or not. The UE

shall cipher the SECURITY MODE COMPLETE message with the selected NAS ciphering algorithm and the NAS ciphering key based on the K_{ASME} or mapped K'_{ASME} indicated by the eKSI. The UE shall set the security header type of the message to "integrity protected and ciphered with new EPS security context".

From this time onward the UE shall cipher and integrity protect all NAS signalling messages with the selected NAS ciphering and NAS integrity algorithms.

If the MME indicated in the SECURITY MODE COMMAND message that the IMEISV is requested, the UE shall include its IMEISV in the SECURITY MODE COMPLETE message.

9.4.3.3 Test description

9.4.3.3.1 Pre-test conditions

System Simulator:

- cell A.

UE:

none.

Preamble:

- the UE is in state Switched OFF (state 1) according to TS 36.508 [18].

9.4.3.3.2 Test procedure sequence

Table 9.4.3.3.2-1: Main behaviour

St	Procedure	Message Sequence		TP	Verdict
		U - S	Message		
1	The UE is switched on.	-	-	-	-
2	The UE transmits an ATTACH REQUEST message including a PDN CONNECTIVITY REQUEST message	-->	ATTACH REQUEST	-	-
3	The SS transmits an AUTHENTICATION REQUEST message to initiate the EPS authentication and AKA procedure.	<--	AUTHENTICATION REQUEST	-	-
4	The UE transmits an AUTHENTICATION RESPONSE message and establishes mutual authentication.	-->	AUTHENTICATION RESPONSE	-	-
5	The SS transmits a SECURITY MODE COMMAND message to activate NAS security.	<--	SECURITY MODE COMMAND	-	-
6	Check: Does the UE transmit a SECURITY MODE COMPLETE message ciphered and starts applying the NAS ciphering in both UL and DL?	-->	SECURITY MODE COMPLETE	1	P
-	EXCEPTION: Steps 6Aa1 to 6Aa2 describe behaviour that depends on UE configuration; the "lower case letter" identifies a step sequence that take place if the UE has ESM information which needs to be transferred.	-	-	-	-
6A a1	IF the UE sets the ESM information transfer flag in the last PDN CONNECTIVITY REQUEST message THEN the SS transmits an ESM INFORMATION REQUEST message to initiate exchange of protocol configuration options and/or APN.	<--	ESM INFORMATION REQUEST	-	-
6A a2	The UE transmits an ESM INFORMATION RESPONSE message to transfer protocol configuration options and/or APN.	-->	ESM INFORMATION RESPONSE	-	-
7	The SS transmits with an ATTACH ACCEPT message The ACTIVATE DEFAULT EPS BEARER CONTEXT REQUEST message is piggybacked in ATTACH ACCEPT message	<--	ATTACH ACCEPT	-	-
8	The UE transmits an ATTACH COMPLETE message including an ACTIVATE DEFAULT EPS BEARER CONTEXT ACCEPT message	-->	ATTACH COMPLETE	-	-
9	The SS transmits an IDENTITY REQUEST message Ciphered	<-	IDENTITY REQUEST	-	-
10	Check: Does the UE transmit an IDENTITY RESPONSE message Ciphered?	->	IDENTITY RESPONSE	1	P

9.4.3.3.3 Specific message contents

Table 9.4.3.3.3-1: SECURITY MODE COMMAND (Step 5)

Derivation path: 36.508 table 4.7.2-19			
Information Element	Value/Remark	Comment	Condition
Selected NAS security algorithms			
- Type of ciphering algorithm	001	EPS encryption algorithm 128-EEA1 [SNOW3G]	

9.4.4 Cipherng and deciphering / Correct functionality of EPS NAS encryption algorithm / AES

9.4.4.1 Test Purpose (TP)

(1)

```
with { successful completion of EPS authentication and key agreement (AKA) procedure }
ensure that {
  when { UE receives a SECURITY MODE COMMAND, to start encryption using algorithm AES }
  then { UE sends SECURITY MODE COMPLETE, encrypted with AES and starts applying the NAS
encryption in both UL and DL }
}
```

9.4.4.2 Conformance requirements

Same Conformance requirements as in clause 9.4.3.2

9.4.4.3 Test description

9.4.4.3.1 Pre-test conditions

Same Pre-test conditions as in clause 9.4.3.3.1

9.4.4.3.2 Test procedure sequence

Same Test procedure sequence as in Table 9.4.3.3.2-1, except the integrity cipherng algorithm is AES.

9.4.4.3.3 Specific message contents

Table 9.4.4.3.3-1: SECURITY MODE COMMAND (Step 5)

Derivation path: 36.508 table 4.7.2-19			
Information Element	Value/Remark	Comment	Condition
Selected NAS security algorithms - Type of cipherng algorithm	010	EPS encryption algorithm 128-EEA2 (AES)	

9.4.5 Integrity protection / Correct functionality of EPS NAS integrity algorithm / ZUC

9.4.5.1 Test Purpose (TP)

(1)

```
with { successful completion of EPS authentication and key agreement (AKA) procedure }
ensure that {
  when { UE receives an integrity protected SECURITY MODE COMMAND message, to start integrity
protection using algorithm ZUC }
  then { UE sends SECURITY MODE COMPLETE, integrity protected with ZUC and starts applying the NAS
Integrity protection in both UL and DL }
}
```

(2)

```
with { Integrity protection successful started by executing Security Mode Procedure }
ensure that {
  when { UE receives a IDENTITY REQUEST message (requested identification parameter is not IMSI),
without integrity protected }
  then { UE Does not transmit IDENTITY Response }
}
```

9.4.5.2 Conformance requirements

Same Conformance requirements as in clause 9.4.1.2

9.4.5.3 Test description

9.4.5.3.1 Pre-test conditions

Same Pre-test conditions as in clause 9.4.1.3.1

9.4.5.3.2 Test procedure sequence

Same Test procedure sequence as in table 9.4.1.3.2.1, except the integrity protection algorithm is ZUC.

9.4.5.3.3 Specific message contents

Table 9.4.5.3.3-1: SECURITY MODE COMMAND (Step 6)

Derivation path: 36.508 table 4.7.2-19			
Information Element	Value/Remark	Comment	Condition
Selected NAS security algorithms - Type of integrity protection algorithm	011	EPS integrity algorithm 128-EIA3 (ZUC)	

9.4.6 Ciphering and deciphering / Correct functionality of EPS NAS encryption algorithm / ZUC

9.4.6.1 Test Purpose (TP)

(1)

```
with { successful completion of EPS authentication and key agreement (AKA) procedure }
ensure that {
  when { UE receives a SECURITY MODE COMMAND, to start encryption using algorithm ZUC }
  then { UE sends SECURITY MODE COMPLETE, encrypted with ZUC and starts applying the NAS encryption
in both UL and DL }
}
```

9.4.6.2 Conformance requirements

Same Conformance requirements as in clause 9.4.3.2

9.4.6.3 Test description

9.4.6.3.1 Pre-test conditions

Same Pre-test conditions as in clause 9.4.3.3.1

9.4.6.3.2 Test procedure sequence

Same Test procedure sequence as in Table 9.4.3.3.2-1, except the integrity ciphering algorithm is ZUC.

9.4.6.3.3 Specific message contents

Table 9.4.6.3.3-1: SECURITY MODE COMMAND (Step 5)

Derivation path: 36.508 table 4.7.2-19			
Information Element	Value/Remark	Comment	Condition
Selected NAS security algorithms - Type of ciphering algorithm	011	EPS encryption algorithm 128-EEA3 (ZUC)	

10 EPS session management

10.1 Void

10.2 Dedicated EPS bearer context activation

10.2.1 Dedicated EPS bearer context activation / Success

10.2.1.1 Test Purpose (TP)

(1)

```

with { UE is in EMM-REGISTERED state and a PDN address for an active default EPS bearer was received
in an ACTIVATE DEFAULT EPS BEARER CONTEXT REQUEST message }
ensure that {
  when { UE receives an ACTIVATE DEDICATED EPS BEARER CONTEXT REQUEST message linked to the existing
default EPS bearer }
  then { UE transmits an ACTIVATE DEDICATED EPS BEARER CONTEXT ACCEPT message }
}

```

10.2.1.2 Conformance requirements

References: The conformance requirements covered in the present TC are specified in: TS 24.301, clause 6.4.2.3.

[TS 24.301, clause 6.4.2.3]

Upon receipt of the ACTIVATE DEDICATED EPS BEARER CONTEXT REQUEST message, the UE shall first check the received TFT before taking it into use. Then the UE shall send an ACTIVATE DEDICATED EPS BEARER CONTEXT ACCEPT message and enter the state BEARER CONTEXT ACTIVE. The ACTIVATE DEDICATED EPS BEARER CONTEXT ACCEPT message shall include the EPS bearer identity.

The linked EPS bearer identity included in the ACTIVATE DEDICATED EPS BEARER CONTEXT REQUEST message indicates to the UE to which default bearer, IP address and PDN the dedicated bearer is linked.

If the PTI is included in the ACTIVATE DEDICATED EPS BEARER CONTEXT REQUEST message, the UE uses the PTI to identify the UE requested bearer resource allocation procedure or the UE requested bearer resource modification procedure to which the dedicated bearer context activation is related.

If the PTI is included in the ACTIVATE DEDICATED EPS BEARER CONTEXT REQUEST message and the PTI is associated to a UE requested bearer resource allocation procedure or a UE requested bearer resource modification procedure, the UE shall release the traffic flow aggregate description associated to the PTI value provided.

The UE shall use the received TFT to apply mapping of uplink traffic flows to the radio bearer if the TFT contains packet filters for the uplink direction.

Upon receipt of the ACTIVATE DEDICATED EPS BEARER CONTEXT ACCEPT message, the MME shall stop the timerT3485 and enter the state BEARER CONTEXT ACTIVE.

10.2.1.3 Test description

10.2.1.3.1 Pre-test conditions

System Simulator:

- Cell A is configured according to Table 6.3.2.2-1 in [18].

UE:

None.

Preamble:

- The UE is in Registered, Idle Mode state (state 2) according to [18].

10.2.1.3.2 Test procedure sequence

Table 10.2.1.3.2-1: Main behaviour

St	Procedure	Message Sequence		TP	Verdict
		U - S	Message		
1	The SS pages the UE in order to establish a dedicated EPS bearer context.	-	-	-	-
2	The UE transmits a SERVICE REQUEST for downlink signalling.	-->	SERVICE REQUEST	-	-
2A	The SS establishes SRB2 and DRB associated with the default EPS bearer context activated during the preamble (a first PDN obtained during the attach procedure).	-	-	-	-
3	The SS transmits an ACTIVATE DEDICATED EPS BEARER CONTEXT REQUEST with particular settings (use Reference dedicated EPS bearer context #1 – see table 6.6.2-1 in TS 36.508) (See Note 1). Note: The SS implicitly reuses the PDN address defined in ACTIVATE DEFAULT EPS BEARER CONTEXT REQUEST message.	<--	ACTIVATE DEDICATED EPS BEARER CONTEXT REQUEST	-	-
4	Check: Does the UE transmit an ACTIVATE DEDICATED EPS BEARER CONTEXT ACCEPT message as specified?	-->	ACTIVATE DEDICATED EPS BEARER CONTEXT ACCEPT	1	P
5	Check: Does the test result of CALL generic procedure indicate that the UE accepts a modification of the newly activated EPS bearer context? (clause 6.4.2.6 in [18])	-	-	1	-
Note 1: The ACTIVATE DEDICATED EPS BEARER CONTEXT REQUEST message is included in a RRCConnectionReconfiguration message including a DRB setup for the same EPS bearer ID					

10.2.1.3.3 Specific message contents

Table 10.2.1.3.3-1: Message ACTIVATE DEDICATED EPS BEARER CONTEXT REQUEST (step 3, Table 10.2.1.3.2-1)

Derivation path: 36.508 table 4.7.3-3 and table 4.6.1-8 with condition AM-DRB-ADD(2)			
Information Element	Value/Remark	Comment	Condition
EPS bearer identity	6		
Procedure transaction identity	0	"No procedure transaction identity assigned"	
Linked EPS bearer identity	5	SS re-uses the EPS bearer identity of the default EPS bearer context.	
EPS QoS	According to reference dedicated EPS bearer context #1 - see [18]		
TFT	According to reference dedicated EPS bearer context #1- see [18]		

Table 10.2.1.3.3-2: Message ACTIVATE DEDICATED EPS BEARER CONTEXT ACCEPT (step 4, Table 10.2.1.3.2-1)

Derivation path: 36.508 table 4.7.3-1			
Information Element	Value/Remark	Comment	Condition
EPS bearer identity	6	Same value as in ACTIVATE DEDICATED EPS BEARER CONTEXT REQUEST	
Procedure transaction identity	0	"No procedure transaction identity assigned"	

10.3 EPS bearer context modification

10.3.1 EPS bearer context modification / Success

10.3.1.1 Test Purpose (TP)

(1)

```
with { the UE is in BEARER CONTEXT ACTIVE STATE and in EMM-CONNECTED mode }
ensure that {
  when { the UE receives a MODIFY EPS BEARER CONTEXT REQUEST message with new TFT }
  then { the UE sets the new TFT and then transmits a MODIFY EPS BEARER CONTEXT ACCEPT }
}
```

10.3.1.2 Conformance requirements

References: The conformance requirements covered in the present TC are specified in: TS 24.301, clause 66.4.3.1, 6.4.3.2 and .4.3.3.

[TS 24.301, clause 6.4.3.1]

The purpose of the EPS bearer context modification procedure is to modify an EPS bearer context with a specific QoS and TFT. The EPS bearer context modification procedure is initiated by the network, but it may also be initiated as part of the UE requested bearer resource allocation procedure or the UE requested bearer resource modification procedure.

...

[TS 24.301, clause 6.4.3.2]

The MME shall initiate the EPS bearer context modification procedure by sending a MODIFY EPS BEARER CONTEXT REQUEST message to the UE, starting the timer T3486, and entering the state BEARER CONTEXT MODIFY PENDING (see example in figure 6.4.3.2.1).

The MME shall include an EPS bearer identity that identifies the EPS bearer context to be modified in the MODIFY EPS BEARER CONTEXT REQUEST message.

[TS 24.301, clause 6.4.3.3]

Upon receipt of the MODIFY EPS BEARER CONTEXT REQUEST message, the UE shall first check the received TFT before taking it into use and then send a MODIFY EPS BEARER CONTEXT ACCEPT message to the MME.

If the PTI is included in the MODIFY EPS BEARER CONTEXT REQUEST message, the UE uses the PTI to identify the UE requested bearer resource allocation procedure or the UE requested bearer resource modification procedure to which the EPS bearer context modification is related (see subclause 6.5.3 and subclause 6.5.4).

If the PTI is included in the MODIFY EPS BEARER CONTEXT REQUEST message and the PTI is associated to a UE requested bearer resource allocation procedure or a UE requested bearer resource modification procedure, the UE shall release the traffic flow aggregate description associated to the PTI value provided.

The UE shall use the received TFT to apply mapping of uplink traffic flows to the radio bearer if the TFT contains packet filters for the uplink direction.

Upon receipt of the MODIFY EPS BEARER CONTEXT ACCEPT message, the MME shall stop the timer T3486 and enter the state BEARER CONTEXT ACTIVE.

10.3.1.3 Test description

10.3.1.3.1 Pre-test conditions

System Simulator:

- Cell A is configured according to Table 6.3.2.2-1 in [18].

UE:

None.

Preamble:

- The UE is in state Switched OFF (State 1).

10.3.1.3.2 Test procedure sequence

The test procedure in Table 10.3.1.3.2-1 is executed once for IPv4 case (sub test 1) and once for IPv6 case (sub test 2) dependent on UE capability as specified in Table 10.3.1.3.2-2a.

Table 10.3.1.3.2-1a: Test executions and test parameters

Sub test	Applicability	IP type
1	UE supporting IPv4	'IPv4'
2	UE supporting IPv6	'IPv6'
Note 1: For UEs supporting both IPv4 and IPv6 then both test execution 1 and 2 shall be performed.		

Table 10.3.1.3.2-1: Main behaviour

St	Procedure	Message Sequence		TP	Verdict
		U - S	Message		
0	The SS performs the generic procedure to get UE in Loopback Activated (state 4) with a Reference default EPS bearer context #1 and Reference dedicated EPS bearer context #1 according to [18] on Cell A.				
1	The SS transmits a MODIFY EPS BEARER CONTEXT REQUEST message with new TFT. This message is included in a DLInformationTransfer message.	<--	MODIFY EPS BEARER CONTEXT REQUEST	-	-
2	Check: Does the UE transmit a MODIFY EPS BEARER CONTEXT ACCEPT message?	-->	MODIFY EPS BEARER CONTEXT ACCEPT	1	P
3	Void	-	-	-	-
4	The SS transmits one IP Packet matching with new TFT (reference packet filter #3) but not existing uplink packet filters (reference packet filter #2).	-	-	-	-
5	Check: Does UE send the IP Packet on the data radio bearer associated with the dedicated EPS bearer context?	-	-	1	P
-	EXCEPTION: Steps 6 – 15 are executed only if two executions apply and this is the first execution	-	-	-	-
6	The SS transmits an OPEN UE TEST LOOP message to exit the UE test loop mode.	<--	RRC: DLInformationTransfer TC: OPEN UE TEST LOOP	-	-
7	The UE transmits an OPEN UE TEST LOOP COMPLETE message.	-->	RRC: ULInformationTransfer TC: OPEN UE TEST LOOP COMPLETE	-	-
8	The SS transmits a DEACTIVATE TEST MODE message to de-activate UE radio bearer test mode procedure.	<--	RRC: DLInformationTransfer TC: DEACTIVATE TEST MODE	-	-
9	The UE transmits a DEACTIVATE TEST MODE COMPLETE message.	-->	RRC: ULInformationTransfer TC: DEACTIVATE TEST MODE COMPLETE	-	-
10	VOID	-	-	-	-
11	VOID	-	-	-	-
12	VOID	-	-	-	-
13	VOID	-	-	-	-
14	The UE is switched OFF. See Note.	-	-	-	-
15	The UE is switched ON.	-	-	-	-
Note: This implies detaching of the UE, releasing of the RRC connection and resetting of the radio bearers at the SS side.					

10.3.1.3.3 Specific message contents

Table 10.3.1.3.3-0: ACTIVATE DEFAULT EPS BEARER CONTEXT REQUEST (Test execution 2: step 0, Table 10.3.1.3.2-1)

Derivation Path: 36.508 table 4.7.3-6			
Information Element	Value/remark	Comment	Condition
PDN address			
Length of PDN address contents	9 octets		
PDN type value	'010'B	IPv6	
PDN address information	IPv6 interface identifier	The SS provides a valid IPv6 interface identifier	
ESM cause	IF "PDN type" IE in step 4 (preamble) is 'IPv4v6' THEN '00110011'B ELSE Not present	"PDN type IPv6 only allowed"	

Table 10.3.1.3.3-0A: ACTIVATE DEFAULT EPS BEARER CONTEXT REQUEST (Test execution 1: step 0, Table 10.3.1.3.2-1)

Derivation Path: 36.508 table 4.7.3-6			
Information Element	Value/remark	Comment	Condition
PDN address			
Length of PDN address contents	5 octets		
PDN type value	'001'B	IPv4	
PDN address information	IPv4 address	The SS provides a valid IPv4 address	
ESM cause	IF "PDN type" IE in step 4 (preamble) is 'IPv4v6' THEN '00110010'B ELSE Not present	"PDN type IPv4 only allowed"	

Table 10.3.1.3.3-1: Message MODIFY EPS BEARER CONTEXT REQUEST (step 1, Table 10.3.1.3.2-1)

Derivation path: 36.508 table 4.7.3-16 and table 4.6.1-3			
Information Element	Value/Remark	Comment	Condition
EPS bearer identity	6	SS assigns the current dedicated EPS bearer context.	
Procedure transaction identity	0	"No procedure transaction identity assigned"	
TFT	According to reference dedicated EPS bearer context #2 except for TFT operation code - see [18]	SS modifies the current packet filters of the dedicated EPS bearer context.	
TFT operation code	Replace packet filters in existing TFT		

Table 10.3.1.3.3-2: Message MODIFY EPS BEARER CONTEXT ACCEPT (step 2, Table 10.3.1.3.2-1)

Derivation path: 36.508 table 4.7.3-14			
Information Element	Value/Remark	Comment	Condition
EPS bearer identity	6	Same value as in MODIFY EPS BEARER CONTEXT REQUEST	
Procedure transaction identity	0	"No procedure transaction identity assigned"	

Table 10.3.1.3.3-2A: VOID

Table 10.3.1.3.3-2 B: IP packet (step 4, Table 10.3.1.3.2-1)

Derivation path: IETF RFC 791 section 3.1 (IPv4) or RFC 2460 section 3 (IPv6) and RFC 769 introduction			
Information Element	Value/Remark	Comment	Condition
Protocol	17	UDP Same value as reference packet filter #2. Reference packet filter #3 can match all values of 'Protocol'	
Source Address	remoteIPv4	Same value as in reference packet filters#2 and #3	
	remoteIPv6	Same value as in reference packet filters#2 and #3	IPv6-only
Destination Address	remoteIPv4	Same value as in reference packet filters#2 and #3	
	remoteIPv6	Same value as in reference packet filters #2 and #3	IPv6-only
Source Port	60000	Not significant for IP packet classification	
Destination Port	60000	Value does not match with reference packet filter #2. Reference packet filter #3 can match all values of "Destination port"	

Table 10.3.1.3.3-3: Condition for IP packet contents (step 4, Table 10.3.1.3.2-1)

Condition	Explanation
IPv6-only	This condition applies if the test variable IP type is set to 'IPv6'

10.4 EPS bearer context deactivation

10.4.1 EPS bearer context deactivation / Success

10.4.1.1 Test Purpose (TP)

(1)

```
with { UE is in BEARER CONTEXT ACTIVE STATE and in EMM-CONNECTED mode }
ensure that {
  when { UE receives a DEACTIVATE EPS BEARER CONTEXT REQUEST message }
  then { UE deletes the EPS bearer context identified by the EPS bearer identity and transmits a
DEACTIVATE EPS BEARER CONTEXT ACCEPT }
}
```

(2)

```
with { UE is in BEARER CONTEXT ACTIVE STATE and in EMM-CONNECTED mode }
ensure that {
  when { UE receives a DEACTIVATE EPS BEARER CONTEXT REQUEST message indicating the EPS bearer
identity of the default bearer to a PDN }
  then { UE deletes all EPS bearer contexts identified to the PDN and transmits a DEACTIVATE EPS
BEARER CONTEXT ACCEPT }
}
```

(3)

```

with { UE is in BEARER CONTEXT ACTIVE STATE and in EMM-CONNECTED mode }
ensure that {
  when { UE receives a DEACTIVATE EPS BEARER CONTEXT REQUEST message that does not point to an
existing EPS bearer context }
  then { UE transmits a DEACTIVATE EPS BEARER CONTEXT ACCEPT with EPS bearer identity set to the
received EPS bearer identity }
}

```

(4)

```

with { UE is in BEARER CONTEXT ACTIVE STATE and in EMM-IDLE mode }
ensure that {
  when { UE initiates an EMM-IDLE to EMM-CONNECTED transition (i.e. SERVICE REQUEST, TRACKING AREA
UPDATE REQUEST) }
  then { UE only synchronizes EPS bearer context state(s) which are explicitly activated by SS in
signalling messages }
}

```

10.4.1.2 Conformance requirements

References: The conformance requirements covered in the present TC are specified in: TS 24.301, clauses 6.4.4.2, 5.5.3.2.4, 5.6.1.4, 6.4.4.3 and 6.4.4.6.

[TS 24.301, clause 6.4.4.2]

...

When the MME wants to deactivate all EPS bearer contexts to a PDN and thus disconnect the UE from the PDN, the MME shall include the EPS bearer identity of the default bearer associated to the PDN in the DEACTIVATE EPS BEARER CONTEXT REQUEST message.

If no NAS signalling connection exists when the MME initiates the EPS bearer context deactivation, the ESM entity in the MME shall locally deactivate the EPS bearer context towards the UE without any peer-to-peer ESM signalling between the MME and the UE.

NOTE: The EPS bearer context state(s) can be synchronized between the UE and the MME at the next EMM-IDLE to EMM-CONNECTED transition, e.g. during a service request or tracking area updating procedure.

[TS 24.301, clause 5.6.1.4]

...

The UE shall locally deactivate the EPS bearer contexts that do not have a user plane radio bearer established after the successful completion of the service request procedure.

...

[TS 24.301, clause 5.5.3.2.4]

...

If an EPS bearer context status IE is included in the TRACKING AREA UPDATE REQUEST message, the MME shall deactivate all those EPS bearer contexts locally (without peer-to-peer signalling between the MME and the UE) which are active on the network side, but are indicated by the UE as being inactive. If a default EPS bearer context is marked as inactive in the EPS bearer context status IE included in the TRACKING AREA UPDATE REQUEST message, and this default bearer is not associated with the last PDN of the user in the MME, the MME shall locally deactivate all EPS bearer contexts associated to the PDN connection with the default EPS bearer context without peer-to-peer ESM signalling to the UE.

If the EPS bearer context status IE is included in the TRACKING AREA UPDATE REQUEST, the MME shall include an EPS bearer context status IE in the TRACKING AREA UPDATE ACCEPT message, indicating which EPS bearer contexts are active in the MME.

...

If an EPS bearer context status IE is included in the TRACKING AREA UPDATE ACCEPT message, the UE shall deactivate all those EPS bearers contexts locally (without peer-to-peer signalling between the UE and the MME) which are active in the UE, but are indicated by the MME as being inactive.

...

[TS 24.301, clause 6.4.4.3]

Upon receipt of the DEACTIVATE EPS BEARER CONTEXT REQUEST message, the UE shall delete the EPS bearer context identified by the EPS bearer identity. After deactivating the identified EPS bearer context, the UE shall respond to the MME with the DEACTIVATE EPS BEARER CONTEXT ACCEPT.

If the EPS bearer identity indicated in the DEACTIVATE EPS BEARER CONTEXT REQUEST is that of the default bearer to a PDN, the UE shall delete all EPS bearer contexts associated to the PDN. After deactivating all EPS bearer contexts, the UE shall respond to the MME with the DEACTIVATE EPS BEARER CONTEXT ACCEPT.

Upon sending the DEACTIVATE EPS BEARER CONTEXT ACCEPT message, the UE shall enter the state BEARER CONTEXT INACTIVE

If the PTI is included in the DEACTIVATE EPS BEARER CONTEXT REQUEST message, the UE uses the PTI to identify the UE requested bearer resource modification procedure or UE requested PDN disconnect procedure to which the EPS bearer context deactivation is related (see subclause 6.5.4).

If the PTI is included in the DEACTIVATE EPS BEARER CONTEXT REQUEST message, the UE shall release the traffic flow aggregate description associated to the PTI value provided.

...

[TS 24.301, clause 7.3.2]

...

The following UE procedures shall apply for handling an unknown, erroneous, or unforeseen EPS bearer identity received in the header of an ESM message:

- i) If the UE receives a DEACTIVATE EPS BEARER CONTEXT REQUEST message which includes an unassigned or reserved EPS bearer identity value or an assigned EPS bearer identity value that does not match an existing EPS bearer context, the UE shall respond with a DEACTIVATE EPS BEARER CONTEXT ACCEPT message with the EPS bearer identity set to the received EPS bearer identity.

...

[TS 24.301, clause 6.4.4.6]

The UE and the MME deactivate EPS bearer contexts locally without peer-to-peer ESM signalling in the following cases:

- 1) during the service request procedure, if the E-UTRAN fails to establish the user plane radio bearers for one or more EPS bearer contexts e.g. due to radio access control;

...For those cases, based on the indication from the lower layers, the UE and the MME shall locally deactivate the EPS bearer contexts for which no user plane radio bearers are set up.

...

When the user plane radio bearer for a default EPS bearer context is not established during the service request procedure or tracking area updating procedure with "active" flag, the UE shall locally deactivate all EPS bearer contexts associated to the PDN connection with the default EPS bearer context. The MME shall locally deactivate all EPS bearer contexts associated to the PDN connection with the default EPS bearer context without peer-to-peer ESM signalling to the UE.

10.4.1.3 Test description

10.4.1.3.1 Pre-test conditions

System Simulator:

- Cell A and Cell B are configured according to Table 6.3.2.2-1 in [18].
- Cell A, Cell B (home PLMN, different TAs).
- System information combination 3 as defined in TS 36.508[18] clause 4.4.3.1 is used in E-UTRA cells;

UE:

None.

Preamble:

- The UE is in state Registered, Idle mode (state 2) according to [18] on Cell A.

10.4.1.3.2 Test procedure sequence

Table 10.4.1.3.2-1: Main behaviour

St	Procedure	Message Sequence		TP	Verdict
		U – S	Message		
-	Cell A is the serving cell Cell B is a suitable cell	-	-	-	-
1	Cause the UE to request connectivity to an additional PDN (see Note 1)	-	-	-	-
1A	The UE transmits a SERVICE REQUEST	-->	SERVICE REQUEST	-	-
1B	The SS establishes SRB2 and DRB associated with default EPS bearer context obtained during the attach procedure.	-	-	-	-
2	The UE transmits a PDN CONNECTIVITY REQUEST message as specified to request an additional PDN.	-->	PDN CONNECTIVITY REQUEST	-	-
3	The SS transmits an ACTIVATE DEFAULT EPS BEARER CONTEXT REQUEST message with IE EPS Bearer Identity set to new EPS bearer context. Note: the SS allocates a PDN address of a PDN type which is compliant with the PDN type requested by the UE.	<--	ACTIVATE DEFAULT EPS BEARER CONTEXT REQUEST	-	-
4	The UE transmits an ACTIVATE DEFAULT EPS BEARER CONTEXT ACCEPT message as specified.	-->	ACTIVATE DEFAULT EPS BEARER CONTEXT ACCEPT	-	-
5	The SS transmits an ACTIVATE DEDICATED EPS BEARER CONTEXT REQUEST relative to the additional PDN. Note: the same PDN address is applicable because the linked EPS bearer ID refers to the default EBC allocated in step 3.	<--	ACTIVATE DEDICATED EPS BEARER CONTEXT REQUEST	-	-
6	The UE transmits an ACTIVATE DEDICATED EPS BEARER CONTEXT ACCEPT message as specified.	-->	ACTIVATE DEDICATED EPS BEARER CONTEXT ACCEPT	-	-
7	The SS releases the RRC connection.	-	-	-	-
8	The SS transmits a Paging message to the UE using S-TMSI with CN domain indicator set to "PS".	<--	-	-	-
9	The UE transmits the SERVICE REQUEST message	-->	SERVICE REQUEST	-	-
9A	The SS establishes SRB2 and DRBs associated with two default EPS bearer context (a first PDN obtained during the attach procedure and an additional PDN).	-	-	-	-
10	The SS transmits a DEACTIVATE EPS BEARER CONTEXT REQUEST including the EPS bearer identity of the dedicated EPS bearer to the additional PDN.	<--	DEACTIVATE EPS BEARER CONTEXT REQUEST	-	-
11	Check: Does the UE transmit a DEACTIVATE EPS BEARER CONTEXT ACCEPT?	-->	DEACTIVATE EPS BEARER CONTEXT ACCEPT	1	P
12	The SS transmits an ACTIVATE DEDICATED EPS BEARER CONTEXT REQUEST relative to the additional PDN. Note: the same PDN address is applicable because the linked EPS bearer ID refers to the default EBC allocated in step 3.	<--	ACTIVATE DEDICATED EPS BEARER CONTEXT REQUEST	-	-
13	The UE transmits an ACTIVATE DEDICATED EPS BEARER CONTEXT ACCEPT message as specified.	-->	ACTIVATE DEDICATED EPS BEARER CONTEXT ACCEPT	-	-
14	The SS transmits a DEACTIVATE EPS BEARER CONTEXT REQUEST including the EPS bearer identity of the default EPS bearer to the additional PDN.	<--	DEACTIVATE EPS BEARER CONTEXT REQUEST	-	-

15	Check: Does the UE transmit a DEACTIVATE EPS BEARER CONTEXT ACCEPT? (see Note 3)	-->	DEACTIVATE EPS BEARER CONTEXT ACCEPT	2	P
16	The SS transmits a MODIFY EPS BEARER CONTEXT REQUEST message including the EPS bearer identity of the dedicated EPS bearer. This message is included in a DLInformationTransfer message.	<--	MODIFY EPS BEARER CONTEXT REQUEST	-	-
17	Check: Does UE transmit a MODIFY EPS BEARER CONTEXT REJECT message with ESM cause #43? (see Note 4)	-->	MODIFY EPS BEARER CONTEXT REJECT	2	P
18	The SS transmits a DEACTIVATE EPS BEARER CONTEXT REQUEST that does not point an existing EPS bearer context.	<--	DEACTIVATE EPS BEARER CONTEXT REQUEST	-	-
19	Check: Does the UE transmit a DEACTIVATE EPS BEARER CONTEXT ACCEPT?	-->	DEACTIVATE EPS BEARER CONTEXT ACCEPT	3	P
20	The SS releases the RRC connection.	-	-	-	-
21	Cause the UE to request connectivity to an additional PDN (see note 1)	-	-	-	-
21 A	The UE transmits a SERVICE REQUEST	-->	SERVICE REQUEST	-	-
21 B	The SS establishes SRB2 and DRBs associated with two default EPS bearer context (a first PDN obtained during the attach procedure and an additional PDN).	-	-	-	-
22	The UE transmits a PDN CONNECTIVITY REQUEST message as specified to request an additional PDN.	-->	PDN CONNECTIVITY REQUEST	-	-
23	The SS transmits an ACTIVATE DEFAULT EPS BEARER CONTEXT REQUEST message with IE EPS Bearer Identity set to new EPS bearer context.	<--	ACTIVATE DEFAULT EPS BEARER CONTEXT REQUEST	-	-
24	The UE transmit an ACTIVATE DEFAULT EPS BEARER CONTEXT ACCEPT message as specified.	-->	ACTIVATE DEFAULT EPS BEARER CONTEXT ACCEPT	-	-
25	The SS transmits an ACTIVATE DEDICATED EPS BEARER CONTEXT REQUEST relative to additional PDN. Note: the same PDN address is applicable because the linked EPS bearer ID refers to the default EBC allocated in step 3.	<--	ACTIVATE DEDICATED EPS BEARER CONTEXT REQUEST	-	-
26	The UE transmit an ACTIVATE DEDICATED EPS BEARER CONTEXT ACCEPT message as specified.	-->	ACTIVATE DEDICATED EPS BEARER CONTEXT ACCEPT	-	-
27	The SS releases the RRC connection.	-	-	-	-
28	The SS transmits a Paging message to the UE using S-TMSI with CN domain indicator set to "PS".	<--	-	-	-
29	The UE transmits SERVICE REQUEST message	-->	SERVICE REQUEST	-	-
30	The SS performs a radio bearer establishment procedure. (Note 2) The RRCConnectionReconfiguration message doesn't include the EPS bearer ID of the additional PDN.	-	-	-	-
31	Check: Does UE transmit an RRCConnectionReconfigurationComplete message? (Note 2)	-	-	4	P
32	The SS transmits a MODIFY EPS BEARER CONTEXT REQUEST message including the EPS bearer identity of the default EPS bearer to the additional PDN. This message is included in a DLInformationTransfer message.	<--	MODIFY EPS BEARER CONTEXT REQUEST	-	-
32 A	Check: Does UE transmits a MODIFY EPS BEARER CONTEXT REJECT message with	-->	MODIFY EPS BEARER CONTEXT REJECT	4	P

	ESM cause #43?(see Note 3)				
32 B	The SS transmits a MODIFY EPS BEARER CONTEXT REQUEST message including the EPS bearer identity of the dedicated EPS bearer.	<--	MODIFY EPS BEARER CONTEXT REQUEST	-	-
32 C	Check: Does UE transmit a MODIFY EPS BEARER CONTEXT REJECT message with ESM cause #43? (see Note 4)	-->	MODIFY EPS BEARER CONTEXT REJECT	4	P
33	The SS releases the RRC connection.	-	-	-	-
34	Cause the UE to request connectivity to an additional PDN (see note 1)	-	-	-	-
34 A	The UE transmits a SERVICE REQUEST	-->	SERVICE REQUEST	-	-
34 B	The SS establishes SRB2 and DRB associated with default EPS bearer context obtained during the attach procedure	-	-	-	-
35	The UE transmits a PDN CONNECTIVITY REQUEST message as specified to request an additional PDN.	-->	PDN CONNECTIVITY REQUEST	-	-
36	The SS transmits an ACTIVATE DEFAULT EPS BEARER CONTEXT REQUEST message with IE EPS Bearer Identity set to new EPS bearer context. Note: SS allocates a PDN address of a PDN type which is compliant with the PDN type requested by the UE.	<--	ACTIVATE DEFAULT EPS BEARER CONTEXT REQUEST	-	-
37	The UE transmits an ACTIVATE DEFAULT EPS BEARER CONTEXT ACCEPT message as specified.	-->	ACTIVATE DEFAULT EPS BEARER CONTEXT ACCEPT	-	-
38	The SS transmits an ACTIVATE DEDICATED EPS BEARER CONTEXT REQUEST relative to additional PDN. Note: the same PDN address is applicable because the linked EPS bearer ID refers to the default EBC allocated in step 3.	<--	ACTIVATE DEDICATED EPS BEARER CONTEXT REQUEST	-	-
39	The UE transmits an ACTIVATE DEDICATED EPS BEARER CONTEXT ACCEPT message as specified.	-->	ACTIVATE DEDICATED EPS BEARER CONTEXT ACCEPT	-	-
40	The SS releases the RRC connection.	-	-	-	-
41	Cell A is a suitable cell Cell B is the serving cell	-	-	-	-
42	The UE transmit a TRACKING AREA UPDATE REQUEST message as specified on Cell B.	-->	TRACKING AREA UPDATE REQUEST		
43	The SS transmits a TRACKING AREA UPDATE ACCEPT indicating only one EPS bearer (default EBIId-1) active in the EPS bearer context status IE. Note: The EPS bearer ID linked to the additional PDN is deactivated by SS.	<--	TRACKING AREA UPDATE ACCEPT	-	-
43 AA	The UE transmits TRACKING AREA UPDATE COMPLETE message	-->	TRACKING AREA UPDATE COMPLETE	-	-
43 AB	Void	-	-	-	-
43 A	The SS transmits a MODIFY EPS BEARER CONTEXT REQUEST message including the EPS bearer identity of the default EPS bearer to the additional PDN. This message is included in a DLInformationTransfer message.	<--	MODIFY EPS BEARER CONTEXT REQUEST	-	-
43 B	Check: Does UE transmits a MODIFY EPS BEARER CONTEXT REJECT message with ESM cause #43?(see Note 3)	-->	MODIFY EPS BEARER CONTEXT REJECT	4	P

43 C	The SS transmits a MODIFY EPS BEARER CONTEXT REQUEST message including the EPS bearer identity of the dedicated EPS bearer. This message is included in a DLInformationTransfer message.	<--	MODIFY EPS BEARER CONTEXT REQUEST	-	-
43 D	Check: Does UE transmit a MODIFY EPS BEARER CONTEXT REJECT message with ESM cause #43? (see Note 4)	-->	MODIFY EPS BEARER CONTEXT REJECT	4	P
44	The SS releases the RRC connection.	-	-	-	-
-	EXCEPTION: Step 45 & 46 describe behaviour that depends on the UE capability.				
45	If pc_ESM_MO_Bearer_Allocation cause the UE to request bearer resource allocation of dedicated EPS bearer associated with additional PDN connectivity.	-	-	-	-
46	Check: Does the UE transmit SERVICE REQUEST?	-->	SERVICE REQUEST	4	F
<p>Note 1: The request of connectivity to an additional PDN and the sending of data may be performed by MMI or AT command.</p> <p>Note 2: After a correct SERVICE REQUEST is received then the SS performs the Radio Bearer Establishment procedure. The UE transmission of the RRCConnectionReconfigurationComplete message indicates the completion of the radio bearer establishment procedure and that the UE has changed EMM mode from EMM-IDLE to EMM-CONNECTED.</p> <p>Note 3: It can be confirmed that the additional default EPS bearer has been deactivated by UE.</p> <p>Note 4: It can be confirmed that the dedicated EPS bearer has been deactivated by UE.</p>					

10.4.1.3.3 Specific message contents

Table 10.4.1.3.3-1: Message PDN CONNECTIVITY REQUEST (step 2, 22 and 35, Table 10.4.1.3.2-1)

Derivation path: 36.508 table 4.7.3-20			
Information Element	Value/Remark	Comment	Condition
EPS bearer identity	0000	No EPS bearer identity assigned	
Procedure transaction identity	PTI-1	UE assigns a particular PTI not yet used between 1 and 254	
ESM information transfer flag	Not present	This IE is only used during an attach procedure.	
Access point name	APN-1 (New PDN name)	The requested PDN is different from default PDN	

Table 10.4.1.3.3-2: Message ACTIVATE DEFAULT EPS BEARER CONTEXT REQUEST (step 3, 23 and 36, Table 10.4.1.3.2-1)

Derivation path: 36.508 table 4.7.3-6 and table 4.6.1-8 with condition AM-DRB-ADD(2)			
Information Element	Value/Remark	Comment	Condition
EPS bearer identity	6	SS assigns an additional EPS Bearer Id different from default EPS Bearer Id between 5 and 15.	
Procedure transaction identity	PTI-1	SS re-uses the particular PTI defined by UE for this present additional PDN connectivity request procedure.	
Access point name	APN-1	SS re-uses the particular APN defined by UE for this present additional PDN connectivity request procedure	

Table 10.4.1.3.3-3: Message ACTIVATE DEFAULT EPS BEARER CONTEXT ACCEPT (step 4, 24 and 37, Table 10.4.1.3.2-1)

Derivation path: 36.508 table 4.7.3-4			
Information Element	Value/Remark	Comment	Condition
EPS bearer identity	6	Same value as in ACTIVATE DEFAULT EPS BEARER CONTEXT REQUEST	
Procedure transaction identity	0	No procedure transaction identity assigned	

Table 10.4.1.3.3-4: Message ACTIVATE DEDICATED EPS BEARER CONTEXT REQUEST (step 5, 12, 25 and 38, Table 10.4.1.3.2-1)

Derivation path: 36.508 table 4.7.3-3 and table 4.6.1-8 with condition AM-DRB-ADD(3)			
Information Element	Value/Remark	Comment	Condition
EPS bearer identity	7	SS assigns a dedicated bearer Id different from default EBIId and additional EBIId and between 5 and 15.	
Procedure transaction identity	0	No procedure transaction identity assigned	
Linked EPS bearer identity	Default EBIId-2 (same value like in table 10.4.1.3.3-2)		
EPS QoS	According to reference dedicated EPS bearer context #1 - see [18]	SS defines an additional dedicated EPS QoS	
TFT	According to reference dedicated EPS bearer context #1 - see [18]		

Table 10.4.1.3.3-5: Message ACTIVATE DEDICATED EPS BEARER CONTEXT ACCEPT (step 6, 13, 26 and 39, Table 10.4.1.3.2-1)

Derivation path: 36.508 table 4.7.3-1			
Information Element	Value/Remark	Comment	Condition
EPS bearer identity	7	Same value as in ACTIVATE DEDICATED EPS BEARER CONTEXT REQUEST in step 5	
Procedure transaction identity	0	No procedure transaction identity assigned	

Table 10.4.1.3.3-6: Message DEACTIVATE EPS BEARER CONTEXT REQUEST (step 10, Table 10.4.1.3.2-1)

Derivation path: 36.508 table 4.7.3-12 and table 4.6.1-8 with condition DRB-REL(3)			
Information Element	Value/Remark	Comment	Condition
EPS bearer identity	7	Same value as in ACTIVATE DEDICATED EPS BEARER CONTEXT REQUEST of step 5	
Procedure transaction identity	0	No procedure transaction identity assigned	
ESM cause	00100100	regular deactivation	
Protocol configuration options	Not present		

Table 10.4.1.3.3-7: Message DEACTIVATE EPS BEARER CONTEXT ACCEPT (step 11, Table 10.4.1.3.2-1)

Derivation path: 36.508 table 4.7.3-11			
Information Element	Value/Remark	Comment	Condition
EPS bearer identity	7	Same value as in ACTIVATE DEDICATED EPS BEARER CONTEXT REQUEST of step 5	
Procedure transaction identity	0	No procedure transaction identity assigned	

Table 10.4.1.3.3-8: Message DEACTIVATE EPS BEARER CONTEXT REQUEST (step 14, Table 10.4.1.3.2-1)

Derivation path: 36.508 table 4.7.3-12 and table 4.6.1-8 with condition DRB-REL(2)			
Information Element	Value/Remark	Comment	Condition
EPS bearer identity	Default EBId-2	Same value as in ACTIVATE DEFAULT EPS BEARER CONTEXT REQUEST of step 3	
Procedure transaction identity	0	No procedure transaction identity assigned	
ESM cause	00100100	regular deactivation	
Protocol configuration options	Not present		

Table 10.4.1.3.3-9: Message DEACTIVATE EPS BEARER CONTEXT ACCEPT (step 15, Table 10.4.1.3.2-1)

Derivation path: 36.508 table 4.7.3-11			
Information Element	Value/Remark	Comment	Condition
EPS bearer identity	6	Same value as in ACTIVATE DEFAULT EPS BEARER CONTEXT REQUEST of step 3	
Procedure transaction identity	0	No procedure transaction identity assigned	

Table 10.4.1.3.3-9b: Message MODIFY EPS BEARER CONTEXT REQUEST (step 16, Table 10.4.1.3.2-1)

Derivation path: 36.508 table 4.7.3-16			
Information Element	Value/Remark	Comment	Condition
EPS bearer identity	7	Dedicated EPS bearer context which should have been deactivated	
Procedure transaction identity	0	"No procedure transaction identity assigned"	
TFT	According to reference dedicated EPS bearer context #2 except for TFT operation code - see [18]	SS modifies the current packet filters of the dedicated EPS bearer context.	
TFT operation code	Replace packet filters in existing TFT		

Table 10.4.1.3.3-10: Message DEACTIVATE EPS BEARER CONTEXT REQUEST (step 18, Table 10.4.1.3.2-1)

Derivation path: 36.508 table 4.7.3-12 and table 4.6.1-8 with condition DRB-REL(2)			
Information Element	Value/Remark	Comment	Condition
EPS bearer identity	6	This value does not refer to an existing EPS bearer	
Procedure transaction identity	0	No procedure transaction identity assigned	
ESM cause	00100100	regular deactivation	
Protocol configuration options	Not present		

Table 10.4.1.3.3-11: Message DEACTIVATE EPS BEARER CONTEXT ACCEPT (step 19, Table 10.4.1.3.2-1)

Derivation path: 36.508 table 4.7.3-11			
Information Element	Value/Remark	Comment	Condition
EPS bearer identity	6	Same value as in DEACTIVATE EPS BEARER CONTEXT REQUEST of step 16	
Procedure transaction identity	0	No procedure transaction identity assigned	

Table 10.4.1.3.3-11a: Message RRCConnectionReconfiguration (step 30, Table 10.4.1.3.2-1)

Derivation path: 36.508 table 4.6.1-8 with condition SRB2-DRB(0, 1)			
---	--	--	--

Table 10.4.1.3.3-12: Message MODIFY EPS BEARER CONTEXT REQUEST (step 32 and 43A, Table 10.4.1.3.2-1)

Derivation path: 36.508 table 4.7.3-16			
Information Element	Value/Remark	Comment	Condition
EPS bearer identity	6	SS assigns the additional default EPS bearer context which isn't present.	
Procedure transaction identity	0	No procedure transaction identity assigned	

Table 10.4.1.3.3-13: Message MODIFY EPS BEARER CONTEXT REJECT (step 32A and 43B, Table 10.4.1.3.2-1)

Derivation path: 36.508 table 4.7.3-14			
Information Element	Value/Remark	Comment	Condition
EPS bearer identity	6	Same value as in MODIFY EPS BEARER CONTEXT REQUEST	
Procedure transaction identity	0	No procedure transaction identity assigned	
ESM cause	00101011	invalid EPS bearer identity	

Table 10.4.1.3.3-14: Message MODIFY EPS BEARER CONTEXT REQUEST (step 16, 32B and 43C, Table 10.4.1.3.2-1)

Derivation path: 36.508 table 4.7.3-16			
Information Element	Value/Remark	Comment	Condition
EPS bearer identity	7	SS assigns the dedicated EPS bearer context which isn't present.	
Procedure transaction identity	0	No procedure transaction identity assigned	

Table 10.4.1.3.3-15: Message MODIFY EPS BEARER CONTEXT REJECT (step 17, 32C and 43D, Table 10.4.1.3.2-1)

Derivation path: 36.508 table 4.7.3-14			
Information Element	Value/Remark	Comment	Condition
EPS bearer identity	7	Same value as in MODIFY EPS BEARER CONTEXT REQUEST	
Procedure transaction identity	0	No procedure transaction identity assigned	
ESM cause	00101011	invalid EPS bearer identity	

Table 10.4.1.3.3-16: Message TRACKING AREA UPDATE REQUEST (step 42, Table 10.4.1.3.2-1)

Derivation path: 36.508 table 4.7.2-27			
Information Element	Value/Remark	Comment	Condition
EPS bearer context status	optional	This IE may be present	
EPS bearer context status IEI	57		
Length of EPS bearer context status contents	2	2 octets	
EBI(0)-EBI(4)	0		
EBI(5)-EBI(7)	7	EPS bearer contexts activated in preamble, step 36 and step 38.	
EBI(8)-EBI(15)	0		

Table 10.4.1.3.3-17: Message TRACKING AREA UPDATE ACCEPT (step 43, Table 10.4.1.3.2-1)

Derivation path: 36.508 table 4.7.2-24			
Information Element	Value/Remark	Comment	Condition
EPS bearer context status	present	The SS deactivates the EPS bearer Id of the additional PDN given at step 30.	
EPS bearer context status IEI	57		
Length of EPS bearer context status contents	2	2 octets	
EBI(0)-EBI(4)	0		
EBI(5-7)	1	EPS bearer contexts activated in preamble	
EBI(8)-EBI(15)	0		

10.4.2 EPS bearer context deactivation / Re-establishment

10.4.2.1 Test Purpose (TP)

(1)

```
with { the UE in BEARER CONTEXT ACTIVE STATE state and EMM-CONNECTED mode }
ensure that {
  when { UE receives a DEACTIVATE EPS BEARER CONTEXT REQUEST message }
  then { the UE transmits a DEACTIVATE EPS BEARER CONTEXT ACCEPT }
}
```

(2)

```
with { the UE in BEARER CONTEXT ACTIVE STATE state and EMM-CONNECTED mode and the UE needs to
continue having a public user identity registered }
ensure that {
  when { UE receives a DEACTIVATE EPS BEARER CONTEXT REQUEST message indicating the EPS bearer used
for SIP signalling }
  then { the UE performs an EPS attach }
}
```

(3)

```
with { the UE in BEARER CONTEXT ACTIVE STATE state and EMM-CONNECTED mode }
ensure that {
  when { UE receives a DEACTIVATE EPS BEARER CONTEXT REQUEST message indicating the EPS bearer used
for SIP signalling }
  then { the UE performs a new initial IMS registration }
}
```

10.4.2.2 Conformance requirements

References: The conformance requirements covered in the present TC are specified in: TS 24.301, clauses 6.4.4.2, 6.4.4.3 and 6.4.4.6 and TS 24.229, clause L2.2.1B. Unless otherwise stated these are Rel-8 requirements.

[TS 24.301, clause 6.4.4.2]

If a NAS signalling connection exists when the MME initiates the EPS bearer context deactivation procedure, the MME shall initiate the EPS bearer context deactivation procedure by sending a DEACTIVATE EPS BEARER CONTEXT REQUEST message to the UE, start the timer T3495, and enter the state BEARER CONTEXT INACTIVE PENDING (see example in figure 6.4.4.2.1). The DEACTIVATE EPS BEARER CONTEXT REQUEST message contains an ESM cause typically indicating one of the following:

- #8: operator determined barring;
- #36: regular deactivation;
- #38: network failure; or
- #112: APN restriction value incompatible with active EPS bearer context.

The procedure transaction identity (PTI) shall also be included if the deactivation is triggered by a UE initiated bearer resource modification procedure or UE requested PDN disconnect procedure.

When the MME wants to deactivate all EPS bearer contexts to a PDN and thus disconnect the UE from the PDN, the MME shall include the EPS bearer identity of the default bearer associated to the PDN in the DEACTIVATE EPS BEARER CONTEXT REQUEST message.

[TS 24.301, clause 6.4.4.3]

Upon receipt of the DEACTIVATE EPS BEARER CONTEXT REQUEST message, the UE shall delete the EPS bearer context identified by the EPS bearer identity. After deactivating the identified EPS bearer context, the UE shall respond to the MME with the DEACTIVATE EPS BEARER CONTEXT ACCEPT.

If the EPS bearer identity indicated in the DEACTIVATE EPS BEARER CONTEXT REQUEST is that of the default bearer to a PDN, the UE shall delete all EPS bearer contexts associated to the PDN. After deactivating all EPS bearer contexts, the UE shall respond to the MME with the DEACTIVATE EPS BEARER CONTEXT ACCEPT.

[TS 24.229, clause L.2.2.1B "Re-establishment of the EPS bearer context for SIP signalling"]

If the UE registered a public user identity with an IP address allocated for the APN of the EPS bearer context used for SIP signalling, the EPS bearer context used for SIP signalling is deactivated as result of signalling from the network and:

- i) if the UE is required to perform an initial registration according to subclause L.3.1.2;
- ii) if the signalling from the network results in requiring the UE to initiate activation of the PDN connection of the EPS bearer context used for SIP signalling; or
- iii) if the UE needs to continue having a public user identity registered with an IP address allocated for the APN;

the UE shall:

- A) if the non-access stratum is performing the UE requested PDN connectivity procedure and the EPS bearer context activation procedure(s) for the APN triggered as result of the signalling from the network, wait until the UE requested PDN connectivity procedure and the EPS bearer context activation procedure(s) for the APN finish; and
- B) perform the procedures in subclause L.2.2.1, bullets a), b) and c).

If none of the bullets i), ii) and iii) of this subclause evaluate to true, or the procedures in bullet B) of this subclause were unable to ensure that the EPS bearer context used for SIP signalling is available or were unable to acquire any P-CSCF address(es):

- 1) if the SIP signalling was carried over a dedicated EPS bearer context, the UE shall release all resources established as a result of SIP signalling by sending to the network either:

- a) a BEARER RESOURCE MODIFICATION REQUEST message, if there are EPS bearer contexts to this PDN that are not related SIP sessions; or
- b) a PDN DISCONNECT REQUEST message if all the EPS bearer contexts to this PDN are related to SIP sessions.

NOTE: If the SIP signalling was carried over the default EPS bearer context, all the resources established as a result of SIP signalling are released without any explicit NAS signalling.

If the default EPS bearer context of the PDN connection of the EPS bearer context used for SIP signalling was deactivated at the start of this subclause, and the procedures in bullet B) of this subclause ensured that the EPS bearer context used for SIP signalling is available and acquired the P-CSCF address(es), the UE shall perform a new initial registration according to subclause 5.1.1.2.

10.4.2.3 Test description

10.4.2.3.1 Pre-test conditions

System Simulator:

- cell A

UE:

None.

Preamble:

- The UE is in state Registered, Idle mode (state 2) according to [18] on cell A.

10.4.2.3.2 Test procedure sequence

Table 10.4.2.3.2-1: Main behaviour

St	Procedure	Message Sequence		TP	Verdict
		U – S	Message		
1	The SS transmits a DEACTIVATE EPS BEARER CONTEXT REQUEST including the EPS bearer identity of the default EPS bearer.	<--	DEACTIVATE EPS BEARER CONTEXT REQUEST	-	-
2	Check: Does the UE transmit a DEACTIVATE EPS BEARER CONTEXT ACCEPT?	-->	DEACTIVATE EPS BEARER CONTEXT ACCEPT	1	P
3	The UE transmits an ATTACH REQUEST message. The PDN CONNECTIVITY REQUEST message is piggybacked in ATTACH REQUEST.	-->	ATTACH REQUEST PDN CONNECTIVITY REQUEST	2	P
4-12	Steps 5 to 13 of the generic test procedure for UE registration (TS 36.508 4.5.2.3-1).	-	-	-	-
13	The SS transmits ATTACH ACCEPT message. The ACTIVATE DEFAULT EPS BEARER CONTEXT REQUEST message is piggybacked in ATTACH ACCEPT.	<--	ATTACH ACCEPT ACTIVATE DEFAULT EPS BEARER CONTEXT REQUEST	-	-
-	EXCEPTION: In parallel to the event described in step 14 below, if initiated by the UE the generic procedure for IP address allocation in the U-plane specified in TS 36.508 subclause 4.5A.1 takes place performing IP address allocation in the U-plane.	-	-	-	-
-	EXCEPTION: In parallel to the event described in step 14 below the generic procedure for IMS signalling in the U-plane specified in table 10.4.2.3.2-2 takes place.	-	-	-	-
14	This message includes the ATTACH COMPLETE message. The ACTIVATE DEFAULT EPS BEARER CONTEXT ACCEPT message is piggybacked in ATTACH COMPLETE.	-->	ATTACH COMPLETE ACTIVATE DEFAULT EPS BEARER CONTEXT ACCEPT	-	-

Table 10.4.2.3.2-2: Procedure for IMS signalling in the U-plane

St	Procedure	Message Sequence		TP	Verdict
		U – S	Message		
1-9	Registration procedure according TS 34.229-1 [43] subclause C.2 (steps 3-11).	-	-	3	P

10.4.2.3.3 Specific message contents

Table 10.4.2.3.3-1: Message DEACTIVATE EPS BEARER CONTEXT REQUEST (step 1, Table 10.4.2.3.2-1)

Derivation path: 36.508 table 4.7.3-12 and table 4.6.1-8 with condition DRB-REL(1)			
Information Element	Value/Remark	Comment	Condition
EPS bearer identity	7	Same value as in ACTIVATE DEFAULT EPS BEARER CONTEXT REQUEST from preamble	
Procedure transaction identity	0	No procedure transaction identity assigned	
ESM cause	00100100	regular deactivation	
Protocol configuration options	Not present		

10.5 UE requested PDN connectivity

10.5.1 UE requested PDN connectivity accepted by the network

10.5.1.1 Test Purpose (TP)

(1)

```
with { UE in EMM-REGISTERED state and EMM-IDLE mode }
ensure that {
  when { UE has uplink signalling pending }
  then { UE establishes the RRC connection with the RRC establishmentCause set to 'mo-Data' and sends a SERVICE REQUEST message }
}
```

(2)

```
with { UE is in EMM-REGISTERED mode }
ensure that {
  when { UE is triggered to request connectivity to an additional PDN }
  then { the UE transmits a PDN CONNECTIVITY REQUEST message with the request type set to "initial request" and including APN }
}
```

(3)

```
with { UE has sent a PDN CONNECTIVITY REQUEST message }
ensure that {
  when { UE receives an RRCConnectionReconfiguration message including an ACTIVATE DEFAULT EPS BEARER CONTEXT REQUEST message with IE Procedure transaction identity matching the PDN CONNECTIVITY REQUEST message and an ACTIVATE DEDICATED EPS BEARER CONTEXT REQUEST message linked to the EPS bearer context activated in the first message }
  then { UE transmits an ACTIVATE DEFAULT EPS BEARER CONTEXT ACCEPT message and an ACTIVATE DEDICATED EPS BEARER CONTEXT ACCEPT message both containing the EPS bearer identity and enters EMM-REGISTERED state }
}
```

10.5.1.2 Conformance requirements

References: The conformance requirements covered in the present TC are specified in: TS 24.301, clauses 5.3.3.1, 5.6.1.1, 5.6.1.2, 5.6.1.4, 6.2.2, 6.4.1.3, 6.4.2.3, 6.5.1.2 and Annex D, and TS 25.331 clause 5.3.3.3.

[TS 24.301 clause 5.3.1.1]

When the UE is in EMM-IDLE mode and needs to transmit an initial NAS message, the UE shall request the lower layer to establish a RRC connection. In this request to the lower layer the NAS shall provide to the lower layer the RRC establishment cause and the call type as specified in annex D of this specification.

...

[TS 24.301 clause 5.6.1.1]

The UE shall invoke the service request procedure when:

...

- c) the UE, in EMM-IDLE mode, has uplink signalling pending;

...

[TS 24.301 clause 5.6.1.2]

If the UE has pending uplink data or uplink signalling in EMM-IDLE mode to be transmitted or it responds to paging with CN domain indicator set to "PS", the UE initiates the service request procedure by sending a SERVICE REQUEST message to the MME, starts the timer T3417, and enters the state EMM-SERVICE-REQUEST-INITIATED.

...

[TS 24.301 clause 5.6.1.4]

For cases a, b, c and h in subclause 5.6.1.1, the UE shall treat the indication from the lower layers that the user plane radio bearer is set up as successful completion of the procedure. The UE shall stop the timer T3417 and enter the state EMM-REGISTERED.

Upon successful completion of the procedure, the UE shall stop the timer T3417 and enter the state EMM-REGISTERED.

[TS 24.301, Annex D]

...

Table D.1.1: Mapping of NAS procedure to establishment cause and call type

NAS procedure	RRC establishment cause (according 3GPP TS 36.331 [22])	Call type
...		
Service Request	If a SERVICE REQUEST is to request user plane radio resources, the RRC establishment cause shall be set to MO data. (See Note1)	"originating calls"
	If a SERVICE REQUEST is to request resources for UL signalling, the RRC establishment cause shall be set to MO data. (See Note 1)	"originating calls"
	If a SERVICE REQUEST is a response to paging where the CN domain indicator is set to "PS", the RRC establishment cause shall be set to MT access. (See Note 1)	"terminating calls"
	If an EXTENDED SERVICE REQUEST has service type set to "mobile originating CS fallback or 1xCS fallback", the RRC establishment cause shall be set to MO data. (See Note1).	"originating calls"
	If an EXTENDED SERVICE REQUEST has service type set to "mobile terminating CS fallback or 1xCS fallback", the RRC establishment cause shall be set to MT access. (See Note1).	"terminating calls"
	If an EXTENDED SERVICE REQUEST has service type set to "mobile originating CS fallback emergency call or 1xCS fallback emergency call", the RRC establishment cause shall be set to Emergency call. (See Note1).	"emergency calls"
...		
Note 1: For these NAS procedures initiated by UEs of access class 12, 13 or 14 in their home country, the RRC establishment cause will be set to "High priority access AC 11 – 15". For this purpose the home country is defined as the country of the MCC part of the IMSI, see 3GPP TS 22.011 [1A]. For these NAS procedures initiated by UE of access class 11 or 15 in their HPLMN (if the EHPLMN list is not present or is empty) or EHPLMN (if the EHPLMN list is present), the RRC establishment cause will be set to "High priority access AC 11 – 15".		

[TS 36.331, clause 5.3.3.3]

The UE shall set the contents of *RRCConnectionRequest* message as follows:

- 1> set the *ue-Identity* as follows:
 - 2> if upper layers provide an S-TMSI:
 - 3> set the *ue-Identity* to the value received from upper layers;
 - 2> else:
 - 3> draw a random value in the range $0 \dots 2^{40}-1$ and set the *ue-Identity* to this value;

NOTE 1: Upper layers provide the S-TMSI if the UE is registered in the TA of the current cell.

- 1> set the *establishmentCause* in accordance with the information received from upper layers;

The UE shall submit the *RRCConnectionRequest* message to lower layers for transmission.

...

[TS 24.301, clause 6.2.2]

The UE shall set the PDN type IE in the PDN CONNECTIVITY REQUEST message, based on its IP stack configuration as follows:

- a) A UE, which is IPv6 and IPv4 capable and

- has not been allocated an IP address for this APN, shall set the PDN type IE to IPv4v6.
 - has been allocated an IPv4 address for this APN and received the ESM cause #52 "single address bearers only allowed", and is requesting an IPv6 address, shall set the PDN type IE to IPv6.
 - has been allocated an IPv6 address for this APN and received the ESM cause #52 "single address bearers only allowed", and is requesting an IPv4 address, shall set the PDN type IE to IPv4.
- b) A UE, which is only IPv4 capable, shall set the PDN type IE to IPv4.
- c) A UE, which is only IPv6 capable, shall set the PDN type IE to IPv6.
- d) When the IP version capability of the UE is unknown in the UE (as in the case when the MT and TE are separated and the capability of the TE is not known in the MT), the UE shall set the PDN type IE to IPv4v6.

...

[TS 24.301, clause 6.4.1.3]

Upon receipt of the ACTIVATE DEFAULT EPS BEARER CONTEXT REQUEST message, the UE shall send an ACTIVATE DEFAULT EPS BEARER CONTEXT ACCEPT message and enter the state BEARER CONTEXT ACTIVE. When the default bearer is activated as part of the attach procedure, the UE shall send the ACTIVATE DEFAULT EPS BEARER CONTEXT ACCEPT message together with ATTACH COMPLETE message. When the default bearer is activated as the response to the stand-alone PDN CONNECTIVITY REQUEST message, the UE shall send the ACTIVATE DEFAULT EPS BEARER CONTEXT ACCEPT message alone.

The UE checks the PTI in the ACTIVATE DEFAULT EPS BEARER CONTEXT REQUEST message to identify the UE requested PDN connectivity procedure to which the default bearer context activation is related (see subclause 6.5.1).

...

[TS 24.301, clause 6.4.2.3]

Upon receipt of the ACTIVATE DEDICATED EPS BEARER CONTEXT REQUEST message, the UE shall first check the received TFT before taking it into use. Then the UE shall send an ACTIVATE DEDICATED EPS BEARER CONTEXT ACCEPT message and enter the state BEARER CONTEXT ACTIVE. The ACTIVATE DEDICATED EPS BEARER CONTEXT ACCEPT message shall include the EPS bearer identity.

The linked EPS bearer identity included in the ACTIVATE DEDICATED EPS BEARER CONTEXT REQUEST message indicates to the UE to which default bearer, IP address and PDN the dedicated bearer is linked.

If the PTI is included in the ACTIVATE DEDICATED EPS BEARER CONTEXT REQUEST message, the UE uses the PTI to identify the UE requested bearer resource allocation procedure or the UE requested bearer resource modification procedure to which the dedicated bearer context activation is related.

If the PTI is included in the ACTIVATE DEDICATED EPS BEARER CONTEXT REQUEST message and the PTI is associated to a UE requested bearer resource allocation procedure or a UE requested bearer resource modification procedure, the UE shall release the traffic flow aggregate description associated to the PTI value provided.

The UE shall use the received TFT to apply mapping of uplink traffic flows to the radio bearer if the TFT contains packet filters for the uplink direction.

...

[TS 24.301, clause 6.5.1.2]

...

In order to request connectivity to a PDN using the default APN, the UE includes the access point name IE in the PDN CONNECTIVITY REQUEST message or, when applicable, in the ESM INFORMATION RESPONSE message, according to the following conditions:

- if use of a PDN using the default APN requires PAP/CHAP, then the UE should include the access point name IE; and
- in all other conditions, the UE need not include the access point name IE.

In order to request connectivity to an additional PDN, the UE shall send a PDN CONNECTIVITY REQUEST message including a requested APN to the MME, start timer T3482 and enter the state PROCEDURE TRANSACTION PENDING (see example in figure 6.5.1.2.1). In the PDN type information element the UE shall indicate the IP version capability of the IP stack associated with the UE as specified in subclause 6.4.1

The UE shall set the request type to "initial request" when the UE is establishing connectivity to a PDN for the first time, i.e. when it is an initial attach to that PDN. The UE shall set the request type to "handover" when the connectivity to a PDN is established upon handover from a non-3GPP access network and the UE was connected to that PDN before the handover to the 3GPP access network.

...

10.5.1.3 Test description

10.5.1.3.1 Pre-test conditions

System Simulator:

- Cell A

UE:

None.

Preamble:

- The UE is in state Registered, Idle mode (state 2) according to [18].10.5.1.3.2 Test procedure sequence

Table 10.5.1.3.2-1: Main Behaviour

St	Procedure	Message Sequence		TP	Verdict
		U - S	Message		
1	Cause the UE to request connectivity to an additional PDN (see Note)	-	-	-	-
1A	Check: Does UE transmit an <i>RRCConnectionRequest</i> message with <i>establishmentCause</i> set to 'mo-Data' followed by a SERVICE REQUEST message?	-->	SERVICE REQUEST	1	P
1B	The SS establishes SRB2 and DRB associated with default EPS bearer context (a first PDN obtained during the attach procedure).	-	-	-	-

2	Check: Does the UE transmit a PDN CONNECTIVITY REQUEST message as specified to request an additional PDN?	-->	PDN CONNECTIVITY REQUEST	2	P
3	The SS transmits an ACTIVATE DEFAULT EPS BEARER CONTEXT REQUEST message with IE EPS Bearer Identity set to new EPS bearer context and ACTIVATE DEDICATED EPS BEARER CONTEXT REQUEST message with IE Linked EPS bearer identity set to the new EPS bearer context. Note: ACTIVATE DEFAULT EPS BEARER CONTEXT REQUEST and ACTIVATE DEDICATED EPS BEARER CONTEXT REQUEST are included in dedicatedInfoNASList of RRCConnectionReconfiguration message.	<--	ACTIVATE DEFAULT EPS BEARER CONTEXT REQUEST ACTIVATE DEDICATED EPS BEARER CONTEXT REQUEST	-	-
-	EXCEPTION: In parallel with step 4 below, the test steps in the parallel behaviour in table 10.5.1.3.2-2 is taking place				
4	Check: Does the UE transmit an ACTIVATE DEFAULT EPS BEARER CONTEXT ACCEPT message for the additional default EPS Bearer?	-->	ACTIVATE DEFAULT EPS BEARER CONTEXT ACCEPT	3	P
5-6	Void	-	-	-	-
7	The SS releases the RRC connection.	-	-	-	-
Note: The request of connectivity to an additional PDN may be performed by MMI or AT command.					

Table 10.5.1.3.2-2: Parallel behaviour

St	Procedure	Message Sequence		TP	Verdict
		U - S	Message		
1	Check: Does the UE transmit an ACTIVATE DEDICATED EPS BEARER CONTEXT ACCEPT message for the dedicated EPS Bearer?	-->	ACTIVATE DEDICATED EPS BEARER CONTEXT ACCEPT	3	P

10.5.1.3.3 Specific message contents

Table 10.5.1.3.3-0: Message RRCConnectionRequest (step 1a, Table 10.5.1.3.2-1)

Derivation path: 36.508 table 4.6.1-16			
Information Element	Value/Remark	Comment	Condition
RRCConnectionRequest ::= SEQUENCE {			
criticalExtensions CHOICE {			
rrcConnectionRequest-r8 SEQUENCE {			
establishmentCause	mo-Data		
}			
}			
}			

Table 10.5.1.3.3-1: Message PDN CONNECTIVITY REQUEST (step 2, Table 10.5.1.3.2-1)

Derivation Path: TS 36.508 Table 4.7.3-20			
Information Element	Value/remark	Comment	Condition
EPS bearer identity	0000	No EPS bearer identity assigned	
Procedure transaction identity	PTI-1	UE assigns a particular PTI not yet used between 1 and 254	
ESM information transfer flag	Not present	This IE is only used during an attach procedure.	
Access point name	APN-1(New PDN name)	The requested PDN is different from default PDN	

Table 10.5.1.3.3-1a: Message RRCConnectionReconfiguration (step 3, Table 10.5.1.3.2-1)

Derivation path: 36.508 table 4.6.1-8 using condition DRB(2,0)			
Information Element	Value/Remark	Comment	Condition
RRCConnectionReconfiguration ::= SEQUENCE {			
criticalExtensions CHOICE {			
c1 CHOICE{			
rrcConnectionReconfiguration-r8 SEQUENCE {			
dedicatedInfoNASList SEQUENCE {	2 entries		
dedicatedInfoNAS[1]	See table 10.5.1.3.3-2		
dedicatedInfoNAS[2]	See table 10.5.1.3.3-3		
}			
}			
}			
}			
}			

Table 10.5.1.3.3-2: Message ACTIVATE DEFAULT EPS BEARER CONTEXT REQUEST (step 3, Table 10.5.1.3.2-1)

Derivation Path: TS 36.508 Table 4.7.3-6			
Information Element	Value/remark	Comment	Condition
EPS bearer identity	6		
Procedure transaction identity	PTI-1	SS re-uses the particular PTI defined by UE for this present additional PDN connectivity request procedure.	
Access point name	APN-1	SS re-uses the particular APN defined by UE for this present additional PDN connectivity request procedure	

Table 10.5.1.3.3-3: Message ACTIVATE DEDICATED EPS BEARER CONTEXT REQUEST (step 3, Table 10.5.1.3.2-1)

Derivation Path: TS 36.508 Table 4.7.3-3			
Information Element	Value/remark	Comment	Condition
EPS bearer identity	7		
Procedure transaction identity	0	No procedure transaction identity assigned	
Linked EPS bearer identity	6		
EPS QoS	According to reference dedicated EPS bearer context #2 - see [18]	SS defines an additional dedicated EPS QoS	
TFT	According to reference dedicated EPS bearer context #2 - see [18]		

Table 10.5.1.3.3-4: Message ACTIVATE DEFAULT EPS BEARER CONTEXT ACCEPT (step 4, Table 10.5.1.3.2-1)

Derivation Path: TS 36.508 Table 4.7.3-4			
Information Element	Value/remark	Comment	Condition
EPS bearer identity	6		
Procedure transaction identity	0	No procedure transaction identity assigned	

Table 10.5.1.3.3-5: Message ACTIVATE DEDICATED EPS BEARER CONTEXT ACCEPT (step 6, Table 10.5.1.3.2-2)

Derivation Path: TS 36.508 Table 4.7.3-1			
Information Element	Value/remark	Comment	Condition
EPS bearer identity	7		
Procedure transaction identity	0	No procedure transaction identity assigned	

10.5.2 Void

10.5.3 UE requested PDN connectivity not accepted

10.5.3.1 Test Purpose (TP)

(1)

```

with { the UE has sent a PDN CONNECTIVITY REQUEST message to an additional PDN }
ensure that {
  when { the UE receives an PDN CONNECTIVITY REJECT message with PTI matching the PDN CONNECTIVITY
REQUEST message and including a ESM cause value }
  then { the UE enters the state PROCEDURE TRANSACTION INACTIVE }
}

```

10.5.3.2 Conformance requirements

References: The conformance requirements covered in the present TC are specified in: TS 24.301, clauses 6.2.2, 6.4.1.3, 6.4.2.3 and 6.5.1.2.

[TS 24.301, clause 6.2.2]

The UE shall set the PDN type IE in the PDN CONNECTIVITY REQUEST message, based on its IP stack configuration as follows:

- a) A UE, which is IPv6 and IPv4 capable and

- has not been allocated an IP address for this APN, shall set the PDN type IE to IPv4v6.
 - has been allocated an IPv4 address for this APN and received the ESM cause #52 "single address bearers only allowed", and is requesting an IPv6 address, shall set the PDN type IE to IPv6.
 - has been allocated an IPv6 address for this APN and received the ESM cause #52 "single address bearers only allowed", and is requesting an IPv4 address, shall set the PDN type IE to IPv4.
- b) A UE, which is only IPv4 capable, shall set the PDN type IE to IPv4.
- c) A UE, which is only IPv6 capable, shall set the PDN type IE to IPv6.
- d) When the IP version capability of the UE is unknown in the UE (as in the case when the MT and TE are separated and the capability of the TE is not known in the MT), the UE shall set the PDN type IE to IPv4v6.

...

[TS 24.301, clause 6.5.1.2]

...

In order to request connectivity to an additional PDN, the UE shall send a PDN CONNECTIVITY REQUEST message including a requested APN to the MME, start timer T3482 and enter the state PROCEDURE TRANSACTION PENDING (see example in figure 6.5.1.2.1). In the PDN type information element the UE shall indicate the IP version capability of the IP stack associated with the UE as specified in subclause 6.4.1

The UE shall set the request type to "initial request" when the UE is establishing connectivity to a PDN for the first time, i.e. when it is an initial attach to that PDN. The UE shall set the request type to "handover" when the connectivity to a PDN is established upon handover from a non-3GPP access network and the UE was connected to that PDN before the handover to the 3GPP access network.

...

[TS 24.301, clause 6.5.1.4]

...

Upon receipt of the PDN CONNECTIVITY REJECT message, the UE shall stop timer T3482 and enter the state PROCEDURE TRANSACTION INACTIVE.

The PDN CONNECTIVITY REJECT message contains an ESM cause IE that typically indicates one of the following ESM cause values:

- #8: operator determined barring;
- #26: insufficient resources;
- #27: missing or unknown APN;
- #28: unknown PDN type;
- #29: user authentication failed;
- #30: request rejected by Serving GW or PDN GW;
- #31: request rejected, unspecified;
- #32: service option not supported;
- #33: requested service option not subscribed;
- #34: service option temporarily out of order;
- #35: PTI already in use;
- #38: network failure;
- #50: PDN type IPv4 only allowed;

- #51: PDN type IPv6 only allowed;
- #53: ESM information not received;
- #54: PDN connection does not exist;
- #55: multiple PDN connections for a given APN not allowed;
- #95 – 111: protocol errors;
- #112: APN restriction value incompatible with active EPS bearer context.

10.5.3.3 Test description

10.5.3.3.1 Pre-test conditions

System Simulator:

- Cell A.

UE:

None.

Preamble:

- The UE is in state Registered, Idle mode (state 2) according to [18] (1 default EPS bearer context is active).

10.5.3.3.2 Test procedure sequence

Table 10.5.3.3.2-1: Main behaviour

St	Procedure	Message Sequence		TP	Verdict
		U - S	Message		
1	Cause the UE to request connectivity to an additional PDN (see Note)	-	-	-	-
1A	The UE transmits a SERVICE REQUEST	-->	SERVICE REQUEST	-	-
1B	The SS establishes SRB2 and DRB associated with the default EPS bearer context activated during the preamble (a first PDN obtained during the attach procedure).	-	-	-	-
2	The UE transmits a PDN CONNECTIVITY REQUEST message as specified to request an additional PDN.	-->	PDN CONNECTIVITY REQUEST	-	-
3	The SS transmits a PDN CONNECTIVITY REJECT message.	<--	PDN CONNECTIVITY REJECT	-	-
4	Void	-	-	-	-
5	Void	-	-	-	-
6	The SS releases the RRC connection.	-	-	-	-
7	Cause the UE to request connectivity to an additional PDN (see Note)	-	-	-	-
8	The UE transmits a SERVICE REQUEST message.	-->	SERVICE REQUEST	-	-
9	The SS establishes a DRB associated with the default EPS bearer context activated during the preamble.	-	-	-	-
9A	Check: Does the UE transmit a PDN CONNECTIVITY REQUEST as specified to request an additional PDN?	-->	PDN CONNECTIVITY REQUEST	1	P
9B	The SS transmits an ACTIVATE DEFAULT EPS BEARER CONTEXT REQUEST message with IE EPS Bearer Identity set to new EPS bearer context. Note: ACTIVATE DEFAULT EPS BEARER CONTEXT REQUEST is included in dedicatedInfoNASList of RRCConnectionReconfiguration message.	<--	ACTIVATE DEFAULT EPS BEARER CONTEXT REQUEST	-	-
10	Check: Does the UE transmit an ACTIVATE DEFAULT EPS BEARER CONTEXT ACCEPT message for the additional default EPS bearer?	-->	ACTIVATE DEFAULT EPS BEARER CONTEXT ACCEPT	1	P
Note: The trigger in step 1 and the RRC messages in steps 1A to 2 and in steps 8 to 10 are the same as in the generic procedure in 36.508 clause 6.4.3.2. The request of connectivity to an additional PDN may be performed by MMI or AT command.					

10.5.3.3.3 Specific message contents

Table 10.5.3.3.3-1: Message PDN CONNECTIVITY REQUEST (step 2, table 10.5.3.3.2-1)

Derivation Path: TS 36.508 Table 4.7.3-20			
Information Element	Value/remark	Comment	Condition
EPS bearer identity	0000	No EPS bearer identity assigned	
Procedure transaction identity	PTI-1	UE assigns a particular PTI not yet used between 1 and 254	
ESM information transfer flag	Not present	This IE is only activable during an attach procedure.	
Access point name	APN-1(New PDN name)	The requested PDN is different from default PDN	

Table 10.5.3.3.3-2: Message PDN CONNECTIVITY REJECT (step 3, table 10.5.3.3.2-1)

Derivation Path: TS 36.508 Table 4.7.3-19			
Information Element	Value/remark	Comment	Condition
EPS bearer identity	0000	No EPS bearer identity assigned	
Procedure transaction identity	PTI-1	The SS indicates the same value like received in the PDN CONNECTIVITY REQUEST	
ESM cause	01101111	"Protocol error, unspecified"	
Protocol configuration options	Not present		

Table 10.5.3.3.3-3: Void**Table 10.5.3.3.3-4: Message PDN CONNECTIVITY REQUEST (step 9A, table 10.5.3.3.2-1)**

Derivation Path: TS 36.508 Table 4.7.3-20			
Information Element	Value/remark	Comment	Condition
EPS bearer identity	0000	No EPS bearer identity assigned	
Procedure transaction identity	PTI-2	UE assigns a particular PTI not yet used between 1 and 254 (may be identical to PTI-1)	
ESM information transfer flag	Not present	This IE is only activable during an attach procedure.	
Access point name	APN-2 (New PDN name)	The requested PDN is different from default PDN (may be identical to APN-1)	

Table 10.5.3.3-5: Message ACTIVATE DEFAULT EPS BEARER CONTEXT REQUEST (step 9B, table 10.5.3.3.2-1)

Derivation Path: TS 36.508 Table 4.7.3-6 and table 4.6.1-8 with condition AM-DRB-ADD(2)			
Information Element	Value/remark	Comment	Condition
EPS bearer identity	6		
Procedure transaction identity	PTI-2	SS re-uses the particular PTI defined by UE for this present additional PDN connectivity request procedure.	
Access point name	APN-2	SS re-uses the particular APN defined by UE for this present additional PDN connectivity request procedure	

Table 10.5.3.3-6: Message ACTIVATE DEFAULT EPS BEARER CONTEXT ACCEPT (step 10, table 10.5.3.3.2-1)

Derivation path: 36.508 table 4.7.3-1			
Information Element	Value/Remark	Comment	Condition
EPS bearer identity	6	Same value as in ACTIVATE DEFAULT EPS BEARER CONTEXT REQUEST	
Procedure transaction identity	0	"No procedure transaction identity assigned"	

10.5.4 UE requested PDN connectivity not accepted / Network reject with Extended Wait Timer

10.5.4.1 Test Purpose (TP)

(1)

```
with { the UE has sent a EXTENDED SERVICE REQUEST message indicating low NAS signalling priority }
ensure that {
  when { the UE receives RRC reject with Extended wait timer }
  then { the UE activates timer T3346 with the value of the Extended wait time and the UE does not
initiate any signalling before the timer has expired }
}
```

(2)

```
with { UE is in EMM-REGISTERED mode }
ensure that {
  when { UE is triggered to request connectivity to an additional PDN }
  then { the UE transmits a PDN CONNECTIVITY REQUEST message with the request type set to "initial
request" and including APN }
}
```

10.5.4.2 Conformance requirements

References: The conformance requirements covered in the present TC are specified in: TS 24.301, clauses 4.2A, 5.6.1.2, 5.6.1.6 and 6.5.1.2.

[TS 24.301, clause 4.2A]

A UE configured for NAS signalling low priority indicates this by including the Device properties IE in the appropriate NAS message and setting the low priority indicator to "MS is configured for NAS signalling low priority", except for the following cases in which the UE shall set the low priority indicator to "MS is not configured for NAS signalling low priority":

- the UE is performing an attach for emergency bearer services;
- the UE has a PDN connection for emergency bearer services established and is performing EPS mobility management procedures, or is establishing a PDN connection for emergency bearer services;
- the UE is accessing the network with access class 11 – 15; or
- the UE is responding to paging.

The network may use the NAS signalling low priority indication for NAS level mobility management congestion control and APN based congestion control.

If the NAS signalling low priority indication is provided in a PDN CONNECTIVITY REQUEST message, the MME stores the NAS signalling low priority indication within the default EPS bearer context activated due to the PDN connectivity request procedure.

[TS 24.301, clause 5.6.1.2]

...

For cases a, b, c, h and k, if the UE is configured for NAS signalling low priority, and the last received ATTACH ACCEPT message or TRACKING AREA UPDATE ACCEPT message from the network indicated that the network supports use of EXTENDED SERVICE REQUEST for packet services, the UE shall send an EXTENDED SERVICE REQUEST message with service type set to "packet services via S1". If the last received ATTACH ACCEPT message or TRACKING AREA UPDATE ACCEPT message from the network did not indicate that the network supports use of EXTENDED SERVICE REQUEST for packet services, the UE shall instead send a SERVICE REQUEST message. After sending the SERVICE REQUEST message or EXTENDED SERVICE REQUEST message with service type set to "packet services via S1", the UE shall start T3417 and enter the state EMM-SERVICE-REQUEST-INITIATED.

[TS 24.301, clause 5.6.1.6]

...

- l) "Extended wait time" from the lower layers

The UE shall abort the service request procedure, enter state EMM-REGISTERED, and stop timer T3417 or T3417ext if still running.

If the EXTENDED SERVICE REQUEST message contained the NAS signalling low priority indicator set to "MS is configured for NAS signalling low priority", the UE shall start timer T3346 with the "Extended wait time" value.

In other cases the UE shall ignore the "Extended wait time".

The service request procedure is started, if still necessary, when timer T3346 expires or is stopped.

If the service request was initiated for CS fallback and timer T3246 is not running, the UE in CS/PS mode 1 of operation shall select GERAN or UTRAN radio access technology and disable E-UTRA capability (see subclause 4.5). It then proceeds with appropriate MM and CC specific procedures. The EMM sublayer shall not indicate the abort of the service request procedure to the MM sublayer.

If the service request was initiated for 1xCS fallback, the UE shall select cdma2000® 1x radio access technology. The UE then proceeds with appropriate cdma2000® 1x CS call processing.

If the service request was initiated due to a request from the SMS entity to send an SMS and timer T3246 is not running, the UE, if operating in CS/PS mode 1 of operation, may select GERAN or UTRAN radio access technology and disable E-UTRA capability (see subclause 4.5). It then proceeds with the appropriate MM procedure.

[TS 24.301, clause 6.5.1.2]

...

In order to request connectivity to an additional PDN, the UE shall send a PDN CONNECTIVITY REQUEST message including a requested APN to the MME, start timer T3482 and enter the state PROCEDURE TRANSACTION PENDING (see example in figure 6.5.1.2.1). In the PDN type information element the UE shall indicate the IP version capability of the IP stack associated with the UE as specified in subclause 6.4.1

The UE shall set the request type to "initial request" when the UE is establishing connectivity to a PDN for the first time, i.e. when it is an initial attach to that PDN. The UE shall set the request type to "handover" when the connectivity to a PDN is established upon handover from a non-3GPP access network and the UE was connected to that PDN before the handover to the 3GPP access network.

...

10.5.4.3 Test description

10.5.4.3.1 Pre-test conditions

System Simulator:

- Cell A.

UE:

- the UE is configured for NAS signalling low priority

Preamble:

- The UE is in state Registered, Idle mode (state 2) according to [18] (1 default EPS bearer context is active).

10.5.4.3.2 Test procedure sequence

Table 10.5.4.3.2-1: Main behaviour

St	Procedure	Message Sequence		TP	Verdict
		U - S	Message		
1	Cause the UE to request connectivity to an additional PDN (see Note)	-	-	-	-
2	The UE transmits an EXTENDED SERVICE REQUEST	-->	EXTENDED SERVICE REQUEST	1	P
3	The SS transmits an <i>RRCCConnectionRelease</i> message indicating redirection to cell 5	<--	<i>RRCCConnectionRelease</i> The SS includes the IE "Extended Wait Time" in the <i>RRCCConnectionRelease</i> message. UE starts timer T3346 with the value 5 seconds	-	-
4	Check: does the UE initiate any signalling before timer T3346 has expired?	-	-	1	F
5	The UE transmits an EXTENDED SERVICE REQUEST message.	-->	EXTENDED SERVICE REQUEST	-	-
6	The SS establishes a DRB associated with the default EPS bearer context activated during the preamble.	-	-	-	-
7	Check: Does the UE transmit a PDN CONNECTIVITY REQUEST as specified to request an additional PDN?	-->	PDN CONNECTIVITY REQUEST	2	P
8	The SS transmits an ACTIVATE DEFAULT EPS BEARER CONTEXT REQUEST message with IE EPS Bearer Identity set to new EPS bearer context. Note: ACTIVATE DEFAULT EPS BEARER CONTEXT REQUEST is included in dedicatedInfoNASList of <i>RRCCConnectionReconfiguration</i> message.	<--	ACTIVATE DEFAULT EPS BEARER CONTEXT REQUEST	-	-
9	The UE transmit an ACTIVATE DEFAULT EPS BEARER CONTEXT ACCEPT message for the additional default EPS bearer	-->	ACTIVATE DEFAULT EPS BEARER CONTEXT ACCEPT	-	-

Note: The trigger in step 1 is the same as in the generic procedure in 36.508 clause 6.4.3.2. The request of connectivity to an additional PDN may be performed by MMI or AT command.

10.5.4.3.3 Specific message contents

Table 10.5.4.3.3-1: Message EXTENDED SERVICE REQUEST (step 2, table 10.5.4.3.2-1)

Derivation path: 36.508 table 4.7.2-14A			
Information Element	Value/remark	Comment	Condition
Service type	1000	'packet services via S1'	
Device properties	1	'MS is configured for NAS signalling low priority'	

Table 10.5.4.3.3-2: RRCConnectionRelease (step 3, table 10.5.4.3.2-1)

Derivation Path: 36.508 Table 4.6.1-15			
Information Element	Value/remark	Comment	Condition
RRCConnectionRelease ::= SEQUENCE {			
criticalExtensions CHOICE {			
c1 CHOICE {			
rrcConnectionRelease-r8 SEQUENCE {			
nonCriticalExtension SEQUENCE {		RRCConnectionRelease-v890-IEs	
lateNonCriticalExtension	Not Present		
nonCriticalExtension SEQUENCE {		RRCConnectionRelease-v920-IEs	
cellInfoList-r9	Not Present		
nonCriticalExtension SEQUENCE {		RRCConnectionRelease-v1020-IEs	
extendedWaitTime-r10	5 seconds		
nonCriticalExtension	Not Present		
}			
}			
}			
}			
}			
}			
}			

Table 10.5.4.3.3-3: Message PDN CONNECTIVITY REQUEST (step 7, table 10.5.4.3.2-1)

Derivation Path: TS 36.508 Table 4.7.3-20			
Information Element	Value/remark	Comment	Condition
EPS bearer identity	0000	No EPS bearer identity assigned	
Procedure transaction identity	PTI-1	UE assigns a particular PTI not yet used between 1 and 254	
ESM information transfer flag	Not present	This IE is only activable during an attach procedure.	
Access point name	APN-1(New PDN name)	The requested PDN is different from default PDN	
Device properties	1	'MS is configured for NAS signalling low priority'	

10.6 UE requested PDN disconnect

10.6.1 UE requested PDN disconnect procedure accepted by the network

10.6.1.1 Test Purpose (TP)

(1)

```
with { UE is in BEARER CONTEXT ACTIVE STATE state }
ensure that {
  when { UE is triggered to disconnect from a PDN }
  then { UE sends a PDN DISCONNECT REQUEST message including the default EPS bearer identity associated with this PDN }
}
```

(2)

```
with { UE is in PROCEDURE TRANSACTION PENDING state }
ensure that {
```

```

when { UE receives a DEACTIVATE EPS BEARER CONTEXT REQUEST message with any valid ESM cause }
then { UE deactivates the default EPS bearer context for this PDN connection between the UE and
the SS }

}

```

10.6.1.2 Conformance requirements

References: The conformance requirements covered in the present TC are specified in: TS 24.301, clauses 6.5.2.2, and 6.5.2.4.

[TS 24.301, clause 6.5.2.2]

In order to request PDN disconnection from a PDN, the UE shall send a PDN DISCONNECT REQUEST message to the MME, start the timer T3492 and enter the state PROCEDURE TRANSACTION PENDING (see example in figure 6.5.2.2.1). The PDN DISCONNECT REQUEST message shall include the EPS bearer identity of the default bearer associated with the PDN to disconnect from as the linked EPS bearer identity in the PDN DISCONNECT REQUEST message.

[TS 24.301, clause 6.5.2.3]

...

Upon receipt of the DEACTIVATE EPS BEARER CONTEXT REQUEST message, the UE shall stop the timer T3492 and enter the state PROCEDURE TRANSACTION INACTIVE. The behaviour of the UE is described in subclause 6.4.4.

...

[TS 24.301, clause 6.4.4.2]

If a NAS signalling connection exists when the MME initiates the EPS bearer context deactivation procedure, the MME shall initiate the EPS bearer context deactivation procedure by sending a DEACTIVATE EPS BEARER CONTEXT REQUEST message to the UE, start the timer T3495, and enter the state BEARER CONTEXT INACTIVE PENDING (see example in figure 6.4.4.2.1). The DEACTIVATE EPS BEARER CONTEXT REQUEST message contains an ESM cause typically indicating one of the following:

- #8: operator determined barring;
- #36: regular deactivation;
- #38: network failure; or
- #112: APN restriction value incompatible with active EPS bearer context.

The procedure transaction identity (PTI) shall also be included if the deactivation is triggered by a UE initiated bearer resource modification procedure or UE requested PDN disconnect procedure.

...

10.6.1.3 Test description

10.6.1.3.1 Pre-test conditions

System Simulator:

- Cell A is configured according to Table 6.3.2.2-1 in [18].

UE:

None.

Preamble:

- The UE is in state Registered, Idle mode (state 2) according to [18] on Cell A.
- Two default EPS bearer context are activated and present on UE side (a first PDN obtained during the attach procedure and an additional PDN).

10.6.1.3.2 Test procedure sequence

Table 10.6.1.3.2-1: Main behaviour

St	Procedure	Message Sequence		TP	Verdict
		U - S	Message		
1	Cause the UE to request disconnection from the additional PDN (see Note 1)	-	-	-	-
1A	The UE transmits a SERVICE REQUEST	-->	SERVICE REQUEST	-	-
1B	The SS establishes SRB2 and DRBs associated with two default EPS bearer context (a first PDN obtained during the attach procedure and an additional PDN).	-	-	-	-
2	Check: Does the UE transmit a PDN DISCONNECT REQUEST message as specified (to disconnect from the additional PDN)?	-->	PDN DISCONNECT REQUEST	1	P
3	The SS transmits a DEACTIVATE EPS BEARER CONTEXT REQUEST message included in an RRCConnectionReconfiguration message.	<--	DEACTIVATE EPS BEARER CONTEXT REQUEST	-	-
4	The UE transmits a DEACTIVATE EPS BEARER CONTEXT ACCEPT message.	-->	DEACTIVATE EPS BEARER CONTEXT ACCEPT	2	P
5	Void	-	-	-	-
5A	The SS releases the RRC connection.	-	-	-	-

Note 1: The request to disconnect from a PDN may be performed by MMI or AT command.

10.6.1.3.3 Specific message contents

Table 10.6.1.3.3-1: Message PDN DISCONNECT REQUEST (step 2, Table 10.6.1.3.2-1)

Derivation Path: TS 36.508 Table 4.7.3-22			
Information Element	Value/remark	Comment	Condition
EPS bearer identity	'0000'	"no EPS bearer identity assigned"	
Procedure transaction identity	PTI-1	UE assigns a particular PTI not yet used between 1 and 254	
Linked EPS bearer identity	6		

Table 10.6.1.3.3-1a: Message RRCConnectionReconfiguration (step 3, Table 10.6.1.3.2-1)

Derivation path: 36.508 table 4.6.1-8 using condition DRB-REL(2)
--

Table 10.6.1.3.3-2: Message DEACTIVATE EPS BEARER CONTEXT REQUEST (step 3, Table 10.6.1.3.2-1)

Derivation Path: TS 36.508 Table 4.7.3-12			
Information Element	Value/remark	Comment	Condition
EPS bearer identity	6	SS re-uses the EPS Bearer Id defined by UE for this present PDN disconnection procedure.	
Procedure transaction identity	PTI-1	SS re-uses the particular PTI defined by UE for this present PDN disconnection procedure.	UE-INITIATED
ESM cause	#36	regular deactivation	

Table 10.6.1.3.3-3: Message DEACTIVATE EPS BEARER CONTEXT ACCEPT (step 4, Table 10.6.1.3.2-1)

Derivation Path: TS 36.508 Table 4.7.3-11			
Information Element	Value/remark	Comment	Condition
EPS bearer identity	6	The same value as the value set in DEACTIVATE EPS BEARER CONTEXT REQUEST message.	
Procedure transaction identity	0	No procedure transaction identity assigned	

10.6.2 Void

10.7 UE requested bearer resource allocation

10.7.1 UE requested bearer resource allocation accepted by the network / New EPS bearer context

10.7.1.1 Test Purpose (TP)

(1)

```
with { UE in PROCEDURE TRANSACTION INACTIVE state and in EMM-IDLE mode }
ensure that {
  when { UE is requested to allocate of bearer resource }
  then { UE sends a BEARER RESOURCE ALLOCATION REQUEST message }
}
```

(2)

```
with { UE has sent the BEARER RESOURCE ALLOCATION REQUEST message }
ensure that {
  when { UE receives an ACTIVATE DEDICATED EPS BEARER CONTEXT REQUEST message with the procedure
transaction identity (PTI) indicated in the BEARER RESOURCE ALLOCATION REQUEST message }
  then { UE sends an ACTIVATE DEDICATED EPS BEARER CONTEXT ACCEPT message }
}
```

10.7.1.2 Conformance requirements

References: The conformance requirements covered in the present TC are specified in: TS 24.301, clause 6.5.3.2 and 6.5.3.3.

[TS 24.301, clause 6.5.3.2]

In order to request the allocation of bearer resources for one traffic flow aggregate, the UE shall send a BEARER RESOURCE ALLOCATION REQUEST message to the MME, start timer T3480 and enter the state PROCEDURE TRANSACTION PENDING (see example in figure 6.5.3.2.1).

The UE shall include the EPS bearer identity of the default EPS bearer associated with the requested bearer resource in the Linked EPS bearer identity IE. The UE shall set the TFT operation code in the Traffic flow aggregate IE to "Create new TFT". In the Required traffic flow QoS IE, the UE shall indicate a QCI and, if the UE also includes a GBR, the additional GBR required for the traffic flow aggregate.

...

[TS 24.301, clause 6.5.3.3]

...

If the bearer resource allocation requested is accepted by the network, the MME shall initiate either a dedicated EPS bearer context activation procedure or an EPS bearer context modification procedure. Upon receipt of an ACTIVATE DEDICATED EPS BEARER CONTEXT REQUEST or MODIFY EPS BEARER CONTEXT REQUEST with a PTI which matches the value used for the BEARER RESOURCE ALLOCATION REQUEST, the UE shall stop timer T3480 and enter the state PROCEDURE TRANSACTION INACTIVE.

If the ACTIVATE DEDICATED EPS BEARER CONTEXT REQUEST is received, the UE shall verify that the EPS bearer identity given in the EPS bearer identity IE is not already used by any dedicated EPS bearer contexts associated with the included linked EPS bearer identity. The UE shall then proceed as described in subclause 6.4.2.3 or subclause 6.4.2.4.

...

10.7.1.3 Test description

10.7.1.3.1 Pre-test conditions

System Simulator:

- Cell A

UE:

None.

Preamble:

- The UE is in state Registered, Idle mode (state 2) according to [18].
- A default EPS bearer is established between the first PDN and the UE.

10.7.1.3.2 Test procedure sequence

Table 10.7.1.3.2-1: Main behaviour

St	Procedure	Message Sequence		TP	Verdict
		U - S	Message		
1	Cause the UE to request bearer resource allocation of dedicated EPS bearer associated with first PDN connectivity. (see Note)	-	-	-	-
2	The UE transmits a SERVICE REQUEST message.	-->	SERVICE REQUEST	-	-
2A	The SS establishes SRB2 and DRB associated with the default EPS bearer context activated during the preamble (a first PDN obtained during the attach procedure).	-	-	-	-
3	Check: Does the UE transmit a BEARER RESOURCE ALLOCATION REQUEST message?	-->	BEARER RESOURCE ALLOCATION REQUEST	1	P
4	The SS transmits an ACTIVATE DEDICATED EPS BEARER CONTEXT REQUEST message.	<--	ACTIVATE DEDICATED EPS BEARER CONTEXT REQUEST	-	-
5	Check: Does the UE transmit an ACTIVATE DEDICATED EPS BEARER CONTEXT ACCEPT message?	-->	ACTIVATE DEDICATED EPS BEARER CONTEXT ACCEPT	2	P
Note: The trigger in step 1 and the RRC messages in steps 2 to 5 are the same as in the generic procedure in 36.508 clause 6.4.3.1.					

10.7.1.3.3 Specific message contents

Table 10.7.1.3.3-1: Message BEARER RESOURCE ALLOCATION REQUEST (step 3, Table 10.7.1.3.2-1)

Derivation path: 36.508 table 4.7.3-6B			
Information Element	Value/Remark	Comment	Condition
Linked EPS bearer identity	5		

Table 10.7.1.3.3-2: Message ACTIVATE DEDICATED EPS BEARER CONTEXT REQUEST (step 4, Table 10.7.1.3.2-1)

Derivation path: 36.508 table 4.7.3-3, condition UE-INITIATED and table 4.6.1-8 with condition AM-DRB-ADD(2)			
Information Element	Value/Remark	Comment	Condition
EPS bearer identity	6		
Linked EPS bearer identity	5		

10.7.2 UE requested bearer resource allocation accepted by the network / Existing EPS bearer context

10.7.2.1 Test Purpose (TP)

(1)

```
with { UE in PROCEDURE TRANSACTION INACTIVE state and in EMM-IDLE mode }
ensure that {
  when { UE is requested to allocate of bearer resource }
  then { UE sends a BEARER RESOURCE ALLOCATION REQUEST message }
}
```

(2)

```
with { UE has sent a BEARER RESOURCE ALLOCATION REQUEST message }
ensure that {
  when { UE receives a MODIFY EPS BEARER CONTEXT REQUEST message with the procedure transaction identity (PTI) indicated in the BEARER RESOURCE ALLOCATION REQUEST message }
  then { UE sends a MODIFY EPS BEARER CONTEXT ACCEPT message }
}
```

10.7.2.2 Conformance requirements

References: The conformance requirements covered in the present TC are specified in: TS 24.301, clause 6.5.3.2 and 6.5.3.3.

[TS 24.301, clause 6.5.3.2]

In order to request the allocation of bearer resources for one traffic flow aggregate, the UE shall send a BEARER RESOURCE ALLOCATION REQUEST message to the MME, start timer T3480 and enter the state PROCEDURE TRANSACTION PENDING (see example in figure 6.5.3.2.1).

The UE shall include the EPS bearer identity of the default EPS bearer associated with the requested bearer resource in the Linked EPS bearer identity IE. The UE shall set the TFT operation code in the Traffic flow aggregate IE to "Create new TFT". In the Required traffic flow QoS IE, the UE shall indicate a QCI and, if the UE also includes a GBR, the additional GBR required for the traffic flow aggregate.

...

[TS 24.301, clause 6.5.3.3]

...

If the bearer resource allocation requested is accepted by the network, the MME shall initiate either a dedicated EPS bearer context activation procedure or an EPS bearer context modification procedure. Upon receipt of an ACTIVATE DEDICATED EPS BEARER CONTEXT REQUEST or MODIFY EPS BEARER CONTEXT REQUEST with a PTI which matches the value used for the BEARER RESOURCE ALLOCATION REQUEST, the UE shall stop timer T3480 and enter the state PROCEDURE TRANSACTION INACTIVE.

...

If the MODIFY EPS BEARER CONTEXT REQUEST is received, the UE verifies that the EPS bearer identity given in the EPS bearer identity IE is any of the active EPS bearer contexts. The UE shall then proceed as described in subclause 6.4.3.3 or subclause 6.4.3.4.

10.7.2.3 Test description

10.7.2.3.1 Pre-test conditions

System Simulator:

- Cell A

UE:

None.

Preamble:

- The UE is in state Generic RB Established (state 3) according to [18].
- A default EPS bearer and a dedicated bearer are established between the first PDN and the UE.

10.7.2.3.2 Test procedure sequence

Table 10.7.2.3.2-1: Main behaviour

St	Procedure	Message Sequence		TP	Verdict
		U - S	Message		
0	The SS releases the RRC connection.	-	-	-	-

1	Cause the UE to request bearer resource allocation of dedicated EPS bearer associated with first PDN connectivity.(see Note)	-	-	-	-
2	The UE transmits a SERVICE REQUEST message.	-->	SERVICE REQUEST	-	-
2A	The SS establishes SRB2 and DRBs associated with default EPS bearer context and a dedicated bearer context (a first PDN obtained during the attach procedure).	-	-	-	-
3	Check: Does the UE transmit a BEARER RESOURCE ALLOCATION REQUEST message?	-->	BEARER RESOURCE ALLOCATION REQUEST	1	P
4	The SS transmits a MODIFY EPS BEARER CONTEXT REQUEST message. This message is included in a DLInformationTransfer message.	<--	MODIFY EPS BEARER CONTEXT REQUEST	-	-
5	Check: Does the UE transmit a MODIFY EPS BEARER CONTEXT ACCEPT message?	-->	MODIFY EPS BEARER CONTEXT ACCEPT	2	P
Note: The trigger in step 1 and the RRC messages in steps 2 to 5 are the same as in the generic procedure in 36.508 clause 6.4.3.1.					

10.7.2.3.3 Specific message contents

Table 10.7.2.3.3-1: Message BEARER RESOURCE ALLOCATION REQUEST (step 3, Table 10.7.2.3.2-1)

Derivation path: 36.508 table 4.7.3-6B			
Information Element	Value/Remark	Comment	Condition
Linked EPS bearer identity	5		

Table 10.7.2.3.3-2: Message MODIFY EPS BEARER CONTEXT REQUEST (step 4, Table 10.7.2.3.2-1)

Derivation path: 36.508 table 4.7.3-18, condition UE-INITIATED			
Information Element	Value/Remark	Comment	Condition
EPS bearer identity	6		
New EPS QoS	According to reference dedicated EPS bearer context #1 - see [18]		
TFT	According to reference dedicated EPS bearer context #2 except for TFT operation code - see [18]	SS modifies the current packet filters of the dedicated EPS bearer context.	
TFT operation code	'011'B	Add packet filters to existing TFT	

10.7.3 UE requested bearer resource allocation not accepted by the network

10.7.3.1 Test Purpose (TP)

(1)

```
with { UE has sent the BEARER RESOURCE ALLOCATION REQUEST message }
ensure that {
  when { UE receives a BEARER RESOURCE ALLOCATION REJECT message with the procedure transaction
identity (PTI) indicated in the BEARER RESOURCE ALLOCATION REQUEST message and a cause "Protocol
error, unspecified" }
  then { UE enters state PROCEDURE TRANSACTION INACTIVE }
}
```

10.7.3.2 Conformance requirements

References: The conformance requirements covered in the present TC are specified in: TS 24.301, clause 6.5.3.4 and 7.3.1.

[TS 24.301, clause 6.5.3.4]

If the bearer resource allocation requested cannot be accepted by the network, the MME shall send a BEARER RESOURCE ALLOCATION REJECT message to the UE. The message shall contain the PTI and an ESM cause value indicating the reason for rejecting the UE requested bearer resource allocation.

The ESM cause value typically indicates one of the following:

- #26: insufficient resources;
- #30: request rejected by Serving GW or PDN GW;
- #31: request rejected, unspecified;
- #32: service option not supported;
- #33: requested service option not subscribed;
- #34: service option temporarily out of order;
- #35: PTI already in use;
- #37: EPS QoS not accepted;
- #41: semantic error in the TFT operation;
- #42: syntactical error in the TFT operation;
- #43: invalid EPS bearer identity;
- #44: semantic error(s) in packet filter(s);
- #45: syntactical error(s) in packet filter(s);
- #56: collision with network initiated request;
- #59: unsupported QCI value; or
- #95 – 111: protocol errors.

...

Upon receipt of a BEARER RESOURCE ALLOCATION REJECT message, the UE shall stop the timer T3480, release the traffic flow aggregate description associated to the PTI value, and enter the state PROCEDURE TRANSACTION INACTIVE.

The further actions to be performed by the UE are implementation dependent as part of upper layers responsibility.

[TS 24.301, clause 7.3.1]

...

The following UE procedures shall apply for handling an unknown, erroneous, or unforeseen PTI received in an ESM message:

...

- h) If the UE receives an ACTIVATE DEDICATED EPS BEARER CONTEXT REQUEST message in which the PTI value is an assigned value that does not match any PTI in use, the UE shall respond with an ACTIVATE DEDICATED EPS BEARER CONTEXT REJECT message including ESM cause #47 "PTI mismatch".

...

10.7.3.3 Test description

10.7.3.3.1 Pre-test conditions

System Simulator:

- Cell A

UE:

None.

Preamble:

- The UE is in state Registered, Idle mode (state 2) according to [18].
- A default EPS bearer is established between the first PDN and the UE.

10.7.3.3.2 Test procedure sequence

Table 10.7.3.3.2-1: Main behaviour

St	Procedure	Message Sequence		TP	Verdict
		U - S	Message		
1	Cause the UE to request bearer resource allocation of dedicated EPS bearer associated with first PDN connectivity.(see Note 1)	-	-	-	-
2	The UE transmits a SERVICE REQUEST message.	-->	SERVICE REQUEST	-	-
2A	The SS establishes SRB2 and DRB associated with the default EPS bearer context activated during the preamble (a first PDN obtained during the attach procedure).	-	-	-	-
3	The UE transmits a BEARER RESOURCE ALLOCATION REQUEST message.	-->	BEARER RESOURCE ALLOCATION REQUEST	-	-
4	The SS transmits a BEARER RESOURCE ALLOCATION REJECT message.	<--	BEARER RESOURCE ALLOCATION REJECT	-	-
4A	SS waits for 500ms (Note 2).	-	-	-	-
5	The SS transmits an ACTIVATE DEDICATED EPS BEARER CONTEXT REQUEST message.	<--	ACTIVATE DEDICATED EPS BEARER CONTEXT REQUEST	-	-
6	Check: Does the UE transmit an ACTIVATE DEDICATED EPS BEARER CONTEXT REJECT message?	-->	ACTIVATE DEDICATED EPS BEARER CONTEXT REJECT	1	P
Note 1: The trigger in step 1 and the RRC messages in steps 2 to 6 are the same as in the generic procedure in 36.508 clause 6.4.3.1.					
Note 2: The timer of 500ms is added to ensure that UE receives BEARER RESOURCE ALLOCATION REJECT message before ACTIVATE DEDICATED EPS BEARER CONTEXT REQUEST message.					

10.7.3.3.3 Specific message contents

Table 10.7.3.3.3-1: Message BEARER RESOURCE ALLOCATION REQUEST (step 3, Table 10.7.3.3.2-1)

Derivation path: 36.508 table 4.7.3-6B			
Information Element	Value/Remark	Comment	Condition
Linked EPS bearer identity	5		

Table 10.7.3.3.3-2: Message BEARER RESOURCE ALLOCATION REJECT (step 4, Table 10.7.3.3.2-1)

Derivation path: 36.508 table 4.7.3-6A			
Information Element	Value/Remark	Comment	Condition
ESM cause	'0110 1111'B	Protocol error, unspecified	

Table 10.7.3.3.3-3: Message ACTIVATE DEDICATED EPS BEARER CONTEXT REQUEST (step 5, Table 10.7.3.3.2-1)

Derivation path: 36.508 table 4.7.3-3 and table 4.6.1-8 with condition AM-DRB-ADD(2)			
Information Element	Value/Remark	Comment	Condition
EPS bearer identity	6		
Procedure transaction identity	The same value as the value set in BEARER RESOURCE ALLOCATION REQUEST message in step 3.		
Linked EPS bearer identity	5		

Table 10.7.3.3.3-4: Message ACTIVATE DEDICATED EPS BEARER CONTEXT REJECT (step 6, Table 10.7.3.3.2-1)

Derivation path: 36.508 table 4.7.3-2			
Information Element	Value/Remark	Comment	Condition
ESM cause	'0010 1111'B	PTI mismatch	

10.7.4 UE requested bearer resource allocation / Expiry of timer T3480

10.7.4.1 Test Purpose (TP)

(1)

```
with { UE has sent a BEARER RESOURCE ALLOCATION REQUEST message }
ensure that {
  when { UE detects less than fifth expiry of timer T3480 }
  then { UE re-sends a BEARER RESOURCE ALLOCATION REQUEST message }
}
```

(2)

```
with { UE has sent the BEARER RESOURCE ALLOCATION REQUEST message 5 times }
ensure that {
  when { UE detects fifth expiry of timer T3480 }
  then { UE does not re-send a BEARER RESOURCE ALLOCATION REQUEST message }
}
```

10.7.4.2 Conformance requirements

References: The conformance requirements covered in the present TC are specified in: TS 24.301, clause 6.5.3.2 and 6.5.3.5.

[TS 24.301, clause 6.5.3.2]

In order to request the allocation of bearer resources for one traffic flow aggregate, the UE shall send a BEARER RESOURCE ALLOCATION REQUEST message to the MME, start timer T3480 and enter the state PROCEDURE TRANSACTION PENDING (see example in figure 6.5.3.2.1).

...

[TS 24.301, clause 6.5.3.5]

a) Expiry of timer T3480:

On the first expiry of the timer T3480, the UE shall resend the BEARER RESOURCE ALLOCATION REQUEST and shall reset and restart timer T3480. This retransmission is repeated four times, i.e. on the fifth expiry of timer T3480, the UE shall abort the procedure, release the PTI allocated for this activation and enter the state PROCEDURE TRANSACTION INACTIVE.

...

10.7.4.3 Test description

10.7.4.3.1 Pre-test conditions

System Simulator:

- Cell A

UE:

None.

Preamble:

- The UE is in state Registered, Idle mode (state 2) according to [18].
- A default EPS bearer is established between the first PDN and the UE.

10.7.4.3.2 Test procedure sequence

Table 10.7.4.3.2-1: Main behaviour

St	Procedure	Message Sequence		TP	Verdict
		U - S	Message		
1	Cause the UE to request bearer resource allocation of dedicated EPS bearer associated with first PDN connectivity.(see Note)	-	-	-	-
2	The UE transmits a SERVICE REQUEST message.	-->	SERVICE REQUEST	-	-
2A	The SS establishes SRB2 and DRB associated with the default EPS bearer context activated during the preamble (a first PDN obtained during the attach procedure).	-	-	-	-
3	The UE transmits a BEARER RESOURCE ALLOCATION REQUEST message.	-->	BEARER RESOURCE ALLOCATION REQUEST	-	-
4	Wait for 8 s to ensure that T3480 expires (1 st expiry).	-	-	-	-
5	Check: Does the UE re-transmit a BEARER RESOURCE ALLOCATION REQUEST message?	-->	BEARER RESOURCE ALLOCATION REQUEST	1	P
6	Wait for 8 s to ensure that T3480 expires (2 nd expiry).	-	-	-	-
7	Check: Does the UE re-transmit a BEARER RESOURCE ALLOCATION REQUEST message?	-->	BEARER RESOURCE ALLOCATION REQUEST	1	P
8	Wait for 8 s to ensure that T3480 expires (3 rd expiry).	-	-	-	-
9	Check: Does the UE re-transmit a BEARER RESOURCE ALLOCATION REQUEST message?	-->	BEARER RESOURCE ALLOCATION REQUEST	1	P
10	Wait for 8 s to ensure that T3480 expires (4 th expiry).	-	-	-	-
11	Check: Does the UE re-transmit a BEARER RESOURCE ALLOCATION REQUEST message?	-->	BEARER RESOURCE ALLOCATION REQUEST	1	P
12	Wait for 8 s to ensure that T3480 expires (5 th expiry).	-	-	-	-
13	Check: Does the UE re-transmit a BEARER RESOURCE ALLOCATION REQUEST message?	-->	BEARER RESOURCE ALLOCATION REQUEST	2	F
Note:	The trigger in step 1 and the RRC messages in steps 2 to 13 are the same as in the generic procedure in 36.508 clause 6.4.3.1.				

10.7.4.3.3 Specific message contents

Table 10.7.4.3.3-1: Message BEARER RESOURCE ALLOCATION REQUEST (step 3,5,7,9,11, Table 10.7.4.3.2-1)

Derivation path: 36.508 table 4.7.3-6B			
Information Element	Value/Remark	Comment	Condition
Linked EPS bearer identity	5		

10.7.5 UE requested bearer resource allocation / BEARER RESOURCE ALLOCATION REJECT message including cause #43 "invalid EPS bearer identity"

10.7.5.1 Test Purpose (TP)

(1)

```

with { UE has sent the BEARER RESOURCE ALLOCATION REQUEST message in order to establish dedicated
EPS bearer between the additional PDN and the UE }
ensure that {
  when { UE receives a BEARER RESOURCE ALLOCATION REJECT message with the procedure transaction
identity (PTI) indicated in the BEARER RESOURCE ALLOCATION REQUEST message and a cause "invalid EPS
bearer identity" }
    then { UE deactivates the EPS bearer context(s) corresponding to the additional PDN locally }
}

```

10.7.5.2 Conformance requirements

References: The conformance requirements covered in the present TC are specified in: TS 24.301, clause 6.5.1.1, 6.5.1.3, 6.5.3.4 and 6.5.3.5.

[TS 24.301, clause 6.5.1.1]

The purpose of the UE requested PDN connectivity procedure is for a UE to request the setup of a default EPS bearer to a PDN. The UE requests connectivity to a PDN by sending a PDN CONNECTIVITY REQUEST message to the network. If accepted by the network, this procedure initiates the establishment of a default EPS bearer context. The procedure is used either to establish the first default bearer by including the PDN CONNECTIVITY REQUEST message into the initial attach message, or to establish subsequent default bearers to additional PDNs in order to allow the UE simultaneous access to multiple PDNs by sending the message stand-alone.

[TS 24.301, clause 6.5.1.3]

...

If connectivity with the requested PDN is accepted by the network, the MME shall initiate the default EPS bearer context activation procedure (see subclause 6.4.1).

...

[TS 24.301, clause 6.5.3.4]

If the bearer resource allocation requested cannot be accepted by the network, the MME shall send a BEARER RESOURCE ALLOCATION REJECT message to the UE. The message shall contain the PTI and an ESM cause value indicating the reason for rejecting the UE requested bearer resource allocation.

The ESM cause value typically indicates one of the following:

...

#43: invalid EPS bearer identity;

...

Upon receipt of a BEARER RESOURCE ALLOCATION REJECT message, the UE shall stop the timer T3480, release the traffic flow aggregate description associated to the PTI value, and enter the state PROCEDURE TRANSACTION INACTIVE.

The further actions to be performed by the UE are implementation dependent as part of upper layers responsibility.

[TS 24.301, clause 6.5.3.5]

The following abnormal cases can be identified:

...

b) Unknown EPS bearer context

Upon receipt of the BEARER RESOURCE ALLOCATION REJECT message including ESM cause #43 "invalid EPS bearer identity", the UE shall deactivate the existing default EPS bearer context locally without peer-to-peer signalling between the UE and the MME.

10.7.5.3 Test description

10.7.5.3.1 Pre-test conditions

System Simulator:

- Cell A

UE:

None.

Preamble:

- The UE is in state Registered, Idle mode (state 2) according to [18].
- A default EPS bearer is established between the first PDN and the UE.

10.7.5.3.2 Test procedure sequence

Table 10.7.5.3.2-1: Main behaviour

St	Procedure	Message Sequence		TP	Verdict
		U - S	Message		
1	Cause the UE to request connectivity to an additional PDN.(see Note 1)	-	-	-	-
2	The UE transmits a SERVICE REQUEST message.	-->	SERVICE REQUEST	-	-
2A	The SS establishes SRB2 and DRB associated with the default EPS bearer context activated during the preamble (a first PDN obtained during the attach procedure).	-	-	-	-
3	The UE transmits a PDN CONNECTIVITY REQUEST message.	-->	PDN CONNECTIVITY REQUEST	-	-
4	The SS transmits an ACTIVATE DEFAULT EPS BEARER CONTEXT REQUEST message.	<--	ACTIVATE DEFAULT EPS BEARER CONTEXT REQUEST	-	-
5	The UE transmits an ACTIVATE DEFAULT EPS BEARER CONTEXT ACCEPT message.	-->	ACTIVATE DEFAULT EPS BEARER CONTEXT ACCEPT	-	-
6	Cause the UE to request bearer resource allocation of dedicated EPS bearer associated with additional PDN connectivity. (see Note 2)	-	-	-	-
7	The UE transmits a BEARER RESOURCE ALLOCATION REQUEST message.	-->	BEARER RESOURCE ALLOCATION REQUEST	-	-
8	The SS transmits a BEARER RESOURCE ALLOCATION REJECT message.	<--	BEARER RESOURCE ALLOCATION REJECT	-	-
9	The SS transmits an ACTIVATE DEDICATED EPS BEARER CONTEXT REQUEST message.	<--	ACTIVATE DEDICATED EPS BEARER CONTEXT REQUEST	-	-
10	Check: Does the UE transmit an ACTIVATE DEDICATED EPS BEARER CONTEXT REJECT message?	-->	ACTIVATE DEDICATED EPS BEARER CONTEXT REJECT	1	P
Note 1: The trigger in step 1 and the RRC messages in steps 2 to 5 are the same as in the generic procedure in 36.508 clause 6.4.3.2.					
Note 2: The trigger in step 6 and the RRC messages in steps 7 to 10 are the same as in the generic procedure in 36.508 clause 6.4.3.1.					

10.7.5.3.3 Specific message contents

Table 10.7.5.3.3-1: Message PDN CONNECTIVITY REQUEST (step 3, Table 10.7.5.3.2-1)

Derivation path: 36.508 table 4.7.3-20			
Information Element	Value/Remark	Comment	Condition
ESM information transfer flag	Not present		
Access point name	Arbitrary name	different from first PDN	

Table 10.7.5.3.3-2: Message ACTIVATE DEFAULT EPS BEARER CONTEXT REQUEST (step 4, Table 10.7.5.3.2-1)

Derivation path: 36.508 table 4.7.3-6 and table 4.6.1-8 with condition AM-DRB-ADD(2)			
Information Element	Value/Remark	Comment	Condition
EPS bearer identity	6		

Table 10.7.5.3.3-3: Message ACTIVATE DEFAULT EPS BEARER CONTEXT ACCEPT (step 5, Table 10.7.5.3.2-1)

Derivation path: 36.508 table 4.7.3-4			
Information Element	Value/Remark	Comment	Condition
EPS bearer identity	6		

Table 10.7.5.3.3-4: Message BEARER RESOURCE ALLOCATION REQUEST (step 7, Table 10.7.5.3.2-1)

Derivation path: 36.508 table 4.7.3-6B			
Information Element	Value/Remark	Comment	Condition
Linked EPS bearer identity	6		

Table 10.7.5.3.3-5: Message BEARER RESOURCE ALLOCATION REJECT (step 8, Table 10.7.5.3.2-1)

Derivation path: 36.508 table 4.7.3-6A			
Information Element	Value/Remark	Comment	Condition
ESM cause	'0010 1011'B	Invalid EPS bearer identity	

Table 10.7.5.3.3-6: Message ACTIVATE DEDICATED EPS BEARER CONTEXT REQUEST (step 9, Table 10.7.5.3.2-1)

Derivation path: 36.508 table 4.7.3-3 with condition NETWORK-INITIATED and table 4.6.1-8 with condition AM-DRB-ADD(3)			
Information Element	Value/Remark	Comment	Condition
EPS bearer identity	7		
Linked EPS bearer identity	6		

Table 10.7.5.3.3-7: Message ACTIVATE DEDICATED EPS BEARER CONTEXT REJECT (step 10, Table 10.7.5.3.2-1)

Derivation path: 36.508 table 4.7.3-2			
Information Element	Value/Remark	Comment	Condition
ESM cause	'0010 1011'B	invalid EPS bearer identity	

10.8 UE requested bearer resource modification

10.8.1 UE requested bearer resource modification accepted by the network / New EPS bearer context

10.8.1.1 Test Purpose (TP)

(1)

```
with { UE in PROCEDURE TRANSACTION INACTIVE state and in EMM-CONNECTED mode }
ensure that {
  when { UE is requested to modify of bearer resource corresponding to the dedicated bearer }
  then { UE sends a BEARER RESOURCE MODIFICATION REQUEST message }
}
```

(2)

```
with { UE having sent the BEARER RESOURCE MODIFICATION REQUEST message }
ensure that {
  when { UE receives an ACTIVATE DEDICATED EPS BEARER CONTEXT REQUEST message with the procedure
transaction identity (PTI) indicated in the BEARER RESOURCE MODIFICATION REQUEST message }
  then { UE sends an ACTIVATE DEDICATED EPS BEARER CONTEXT ACCEPT message }
}
```

10.8.1.2 Conformance requirements

References: The conformance requirements covered in the present TC are specified in: TS 24.301, clause 6.4.2.3, 6.5.4.2 and 6.5.4.3.

[TS 24.301, clause 6.4.2.3]

...

The linked EPS bearer identity included in the ACTIVATE DEDICATED EPS BEARER CONTEXT REQUEST message indicates to the UE to which default bearer, IP address and PDN the dedicated bearer is linked.

If the PTI is included in the ACTIVATE DEDICATED EPS BEARER CONTEXT REQUEST message, the UE uses the PTI to identify the UE requested bearer resource allocation procedure or the UE requested bearer resource modification procedure to which the dedicated bearer context activation is related.

...

[TS 24.301, clause 6.5.4.2]

In order to request the modification of bearer resources for one traffic flow aggregate, the UE shall send a BEARER RESOURCE MODIFICATION REQUEST message to the MME, start timer T3481 and enter the state PROCEDURE TRANSACTION PENDING (see example in figure 6.5.3.2.1).

...

[TS 24.301, clause 6.5.4.3]

Upon receipt of the BEARER RESOURCE MODIFICATION REQUEST message, the MME checks whether the resources requested by the UE can be established, modified or released by verifying the EPS bearer identity given in the EPS bearer identity for packet filter IE.

If the bearer resource modification requested is accepted by the network, the MME shall initiate either a dedicated EPS bearer context activation procedure, an EPS bearer context modification procedure or an EPS bearer context deactivation procedure.

Upon receipt of an ACTIVATE DEDICATED EPS BEARER CONTEXT REQUEST, MODIFY EPS BEARER CONTEXT REQUEST or DEACTIVATE EPS BEARER CONTEXT REQUEST with a PTI which matches the value used for the BEARER RESOURCE MODIFICATION REQUEST, the UE shall stop timer T3481 and enter the state PROCEDURE TRANSACTION INACTIVE.

- i) If the ACTIVATE DEDICATED EPS BEARER CONTEXT REQUEST is received, the UE shall verify that the EPS bearer identity given in the EPS bearer identity IE is not already used by any dedicated EPS bearer contexts associated with the included linked EPS bearer identity. The UE shall then proceed as described in subclause 6.4.2.3 or subclause 6.4.2.4.

...

10.8.1.3 Test description

10.8.1.3.1 Pre-test conditions

System Simulator:

- Cell A

UE:

None.

Preamble:

- The UE is in state Generic RB Established (state 3) according to [18].
- A default EPS bearer and a dedicated bearer are established between the first PDN and the UE.

10.8.1.3.2 Test procedure sequence

Table 10.8.1.3.2-1: Main behaviour

St	Procedure	Message Sequence		TP	Verdict
		U - S	Message		
1	Cause the UE to request bearer resource modification of dedicated EPS bearer associated with first PDN connectivity.(see Note)	-	-	-	-
2	Check: Does the UE transmit a BEARER RESOURCE MODIFICATION REQUEST message?	-->	BEARER RESOURCE MODIFICATION REQUEST	1	P
3	The SS transmits an ACTIVATE DEDICATED EPS BEARER CONTEXT REQUEST message.	<--	ACTIVATE DEDICATED EPS BEARER CONTEXT REQUEST	-	-
4	Check: Does the UE transmit an ACTIVATE DEDICATED EPS BEARER CONTEXT ACCEPT message?	-->	ACTIVATE DEDICATED EPS BEARER CONTEXT ACCEPT	2	P
Note: The trigger in step 1 and the RRC messages in steps 2 to 4 are the same as in the generic procedure in 36.508 clause 6.4.3.3.					

10.8.1.3.3 Specific message contents

Table 10.8.1.3.3-1: Message ACTIVATE DEDICATED EPS BEARER CONTEXT REQUEST (step 3, Table 10.8.1.3.2-1)

Derivation path: 36.508 table 4.7.3-3, condition UE-INITIATED and table 4.6.1-8 with condition AM-DRB-ADD(3)			
Information Element	Value/Remark	Comment	Condition
EPS bearer identity	7		
EPS QoS	According to reference dedicated EPS bearer context #1 - see [18]		
TFT	According to reference dedicated EPS bearer context #2 - see [18]		

10.8.2 UE requested bearer resource modification accepted by the network / Existing EPS bearer context

10.8.2.1 Test Purpose (TP)

(1)

```
with { UE in PROCEDURE TRANSACTION INACTIVE state and in EMM-CONNECTED mode }
ensure that {
  when { UE is requested to modify of bearer resource corresponding to the dedicated bearer }
  then { UE sends a BEARER RESOURCE MODIFICATION REQUEST message }
}
```

(2)

```
with { UE having sent the BEARER RESOURCE MODIFICATION REQUEST message }
ensure that {
  when { UE receives a MODIFY EPS BEARER CONTEXT REQUEST message with the procedure transaction identity (PTI) indicated in the BEARER RESOURCE MODIFICATION REQUEST message }
  then { UE sends a MODIFY EPS BEARER CONTEXT ACCEPT message }
}
```

10.8.2.2 Conformance requirements

References: The conformance requirements covered in the present TC are specified in: TS 24.301, clause 6.5.4.2, 6.5.4.3 and 6.4.3.3.

[TS 24.301, clause 6.5.4.2]

In order to request the modification of bearer resources for one traffic flow aggregate, the UE shall send a BEARER RESOURCE MODIFICATION REQUEST message to the MME, start timer T3481 and enter the state PROCEDURE TRANSACTION PENDING (see example in figure 6.5. 4.2.1).

...

[TS 24.301, clause 6.5.4.3]

Upon receipt of the BEARER RESOURCE MODIFICATION REQUEST message, the MME checks whether the resources requested by the UE can be established, modified or released by verifying the EPS bearer identity given in the EPS bearer identity for packet filter IE.

If the bearer resource modification requested is accepted by the network, the MME shall initiate either a dedicated EPS bearer context activation procedure, an EPS bearer context modification procedure or an EPS bearer context deactivation procedure.

Upon receipt of an ACTIVATE DEDICATED EPS BEARER CONTEXT REQUEST, MODIFY EPS BEARER CONTEXT REQUEST or DEACTIVATE EPS BEARER CONTEXT REQUEST message with a PTI which matches the value used for the BEARER RESOURCE MODIFICATION REQUEST message, the UE shall stop timer T3481 and enter the state PROCEDURE TRANSACTION INACTIVE.

...

- ii) If the MODIFY EPS BEARER CONTEXT REQUEST message is received, the UE verifies that the EPS bearer identity given in the EPS bearer identity IE is any of the active EPS bearer contexts. The UE shall then proceed as described in subclause 6.4.3.3 or subclause 6.4.3.4.

...

[TS 24.301, clause 6.4.3.3]

...

If the MODIFY EPS BEARER CONTEXT REQUEST message contains a PTI value other than "no procedure transaction identity assigned" and "reserved" (see 3GPP TS 24.007 [12]), the UE uses the PTI to identify the UE requested bearer resource allocation procedure or the UE requested bearer resource modification procedure to which the EPS bearer context modification is related (see subclause 6.5.3 and subclause 6.5.4).

If the MODIFY EPS BEARER CONTEXT REQUEST message contains a PTI value other than "no procedure transaction identity assigned" and "reserved" (see 3GPP TS 24.007 [12]) and the PTI is associated to a UE requested bearer resource allocation procedure or a UE requested bearer resource modification procedure, the UE shall release the traffic flow aggregate description associated to the PTI value provided.

...

10.8.2.3 Test description

10.8.2.3.1 Pre-test conditions

System Simulator:

- Cell A

UE:

None

Preamble:

- The UE is in state Generic RB Established (state 3) according to [18].
- A default EPS bearer and a dedicated bearer are established between the first PDN and the UE.

10.8.2.3.2 Test procedure sequence

Table 10.8.2.3.2-1: Main behaviour

St	Procedure	Message Sequence		TP	Verdict
		U - S	Message		
1	Cause the UE to request bearer resource modification of dedicated EPS bearer associated with first PDN connectivity.(see Note)	-	-	-	-
2	Check: Does the UE transmit a BEARER RESOURCE MODIFICATION REQUEST message?	-->	BEARER RESOURCE MODIFICATION REQUEST	1	P
3	The SS transmits a MODIFY EPS BEARER CONTEXT REQUEST message. This message is included in a DLInformationTransfer message.	<--	MODIFY EPS BEARER CONTEXT REQUEST	-	-
4	Check: Does the UE transmit a MODIFY EPS BEARER CONTEXT ACCEPT message?	-->	MODIFY EPS BEARER CONTEXT ACCEPT	2	P
Note: The trigger in step 1 and the RRC messages in steps 2 to 4 are the same as in the generic procedure in 36.508 clause 6.4.3.3.					

10.8.2.3.3 Specific message contents

Table 10.8.2.3.3-1: Message BEARER RESOURCE MODIFICATION REQUEST (step 2, Table 10.8.2.3.2-1)

Derivation path: 36.508 table 4.7.3-8			
Information Element	Value/Remark	Comment	Condition
EPS bearer identity for packet filter	6		

Table 10.8.2.3.3-2: Message MODIFY EPS BEARER CONTEXT REQUEST (step 3, Table 10.8.2.3.2-1)

Derivation path: 36.508 table 4.7.3-18, condition UE-INITIATED			
Information Element	Value/Remark	Comment	Condition
EPS bearer identity	6		
New EPS QoS	According to reference dedicated EPS bearer context #1 - see [18]		

10.8.3 UE requested bearer resource modification not accepted by the network

10.8.3.1 Test Purpose (TP)

(1)

```

with { UE has sent the BEARER RESOURCE MODIFICATION REQUEST message }
ensure that {
  when { UE receives a BEARER RESOURCE MODIFICATION REJECT message with the procedure transaction
identity (PTI) indicated in the BEARER RESOURCE MODIFICATION REQUEST message and a cause "Protocol
error, unspecified" }
  then { UE enters state PROCEDURE TRANSACTION INACTIVE }
}

```

10.8.3.2 Conformance requirements

References: The conformance requirements covered in the present TC are specified in: TS 24.301, clause 6.5.4.4 and 7.3.1.

[TS 24.301, clause 6.5.4.4]

If the bearer resource modification requested cannot be accepted by the network, the MME shall send a BEARER RESOURCE MODIFICATION REJECT message to the UE. The message shall contain the PTI and an ESM cause value indicating the reason for rejecting the UE requested bearer resource modification.

The ESM cause value typically indicates one of the following:

- #26: insufficient resources;
- #30: request rejected by Serving GW or PDN GW;
- #31: request rejected, unspecified;
- #32: service option not supported;
- #33: requested service option not subscribed;
- #34: service option temporarily out of order;
- #35: PTI already in use;
- #37: EPS QoS not accepted;
- #41: semantic error in the TFT operation;
- #42: syntactical error in the TFT operation;
- #43: invalid EPS bearer identity;
- #44: semantic error(s) in packet filter(s);
- #45: syntactical error(s) in packet filter(s);
- #56: collision with network initiated request;
- #59: unsupported QCI value; or
- #95 – 111: protocol errors.

...

Upon receipt of a BEARER RESOURCE MODIFICATION REJECT message, the UE shall stop the timer T3481, release the traffic flow aggregate description associated to the PTI value, and enter the state PROCEDURE TRANSACTION INACTIVE. If the ESM cause included in the BEARER RESOURCE MODIFICATION REJECT message is #43 "invalid EPS bearer identity", the UE locally deactivates the EPS bearer context(s) without peer-to-peer ESM signalling.

The further actions to be performed by the UE are implementation dependent as part of upper layers responsibility.

...

[TS 24.301, clause 7.3.1]

...

The following UE procedures shall apply for handling an unknown, erroneous, or unforeseen PTI received in an ESM message:

...

- h) If the UE receives an ACTIVATE DEDICATED EPS BEARER CONTEXT REQUEST message in which the PTI value is an assigned value that does not match any PTI in use, the UE shall respond with an ACTIVATE DEDICATED EPS BEARER CONTEXT REJECT message including ESM cause #47 "PTI mismatch".

...

10.8.3.3 Test description

10.8.3.3.1 Pre-test conditions

System Simulator:

- Cell A

UE:

None.

Preamble:

- The UE is in state Generic RB Established (state 3) according to [18].
- A default EPS bearer and a dedicated bearer are established between the first PDN and the UE.

10.8.3.3.2 Test procedure sequence

Table 10.8.3.3.2-1: Main behaviour

St	Procedure	Message Sequence		TP	Verdict
		U - S	Message		
1	Cause the UE to request bearer resource modification of dedicated EPS bearer associated with first PDN connectivity.(see Note 1)	-	-	-	-
2	The UE transmits a BEARER RESOURCE MODIFICATION REQUEST message.	-->	BEARER RESOURCE MODIFICATION REQUEST	-	-
3	The SS transmits a BEARER RESOURCE MODIFICATION REJECT message.	<--	BEARER RESOURCE MODIFICATION REJECT	-	-
3A	SS waits for 500ms (Note 2).	-	-	-	-
4	The SS transmits an ACTIVATE DEDICATED EPS BEARER CONTEXT REQUEST message.	<--	ACTIVATE DEDICATED EPS BEARER CONTEXT REQUEST	-	-
5	Check: Does the UE transmit an ACTIVATE DEDICATED EPS BEARER CONTEXT REJECT message?	-->	ACTIVATE DEDICATED EPS BEARER CONTEXT REJECT	1	P
Note 1: The trigger in step 1 and the RRC messages in steps 2 to 5 are the same as in the generic procedure in 36.508 clause 6.4.3.3. Note 2: The timer of 500ms is added to ensure that UE receives BEARER RESOURCE MODIFICATION REJECT message before ACTIVATE DEDICATED EPS BEARER CONTEXT REQUEST message.					

10.8.3.3.3 Specific message contents

Table 10.8.3.3.3-1: Message BEARER RESOURCE MODIFICATION REQUEST (step 2, Table 10.8.3.3.2-1)

Derivation path: 36.508 table 4.7.3-8			
Information Element	Value/Remark	Comment	Condition
EPS bearer identity for packet filter	6		

Table 10.8.3.3.3-2: Message BEARER RESOURCE MODIFICATION REJECT (step 3, Table 10.8.3.3.2-1)

Derivation path: 36.508 table 4.7.3-6A			
Information Element	Value/Remark	Comment	Condition
ESM cause	'0110 1111'B	Protocol error, unspecified	

Table 10.8.3.3.3-3: Message ACTIVATE DEDICATED EPS BEARER CONTEXT REQUEST (step 4, Table 10.8.3.3.2-1)

Derivation path: 36.508 table 4.7.3-3 and table 4.6.1-8 with condition AM-DRB-ADD(3)			
Information Element	Value/Remark	Comment	Condition
EPS bearer identity	7		
Procedure transaction identity	The same value as the value set in BEARER RESOURCE MODIFICATION REQUEST message in step 2.		
Linked EPS bearer identity	5		
EPS QoS	According to reference dedicated EPS bearer context #2 - see [18]		
TFT	According to reference dedicated EPS bearer context #2 - see [18]		

Table 10.8.3.3.3-4: Message ACTIVATE DEDICATED EPS BEARER CONTEXT REJECT (step 5, Table 10.8.3.3.2-1)

Derivation path: 36.508 table 4.7.3-2			
Information Element	Value/Remark	Comment	Condition
ESM cause	'0010 1111'B	PTI mismatch	

10.8.4 UE requested bearer resource modification / Cause #36 "regular deactivation"

10.8.4.1 Test Purpose (TP)

(1)

```
with { UE in PROCEDURE TRANSACTION INACTIVE state and in EMM-CONNECTED mode }
ensure that {
  when { UE is requested to release of bearer resources corresponding to the dedicated bearer }
  then { UE sends a BEARER RESOURCE MODIFICATION REQUEST message with a cause "regular
deactivation" }
}
```

(2)

```
with { UE having sent the BEARER RESOURCE MODIFICATION REQUEST message }
ensure that {
  when { UE receives a DEACTIVATE EPS BEARER CONTEXT REQUEST message with the procedure transaction
identity (PTI) indicated in the BEARER RESOURCE MODIFICATION REQUEST message and the EPS bearer
identity pointing an existing EPS bearer context }
  then { UE deactivates the EPS bearer context identified by the EPS bearer identity indicated in
the DEACTIVATE EPS BEARER CONTEXT REQUEST message and sends a DEACTIVATE EPS BEARER CONTEXT ACCEPT
message }
}
```

10.8.4.2 Conformance requirements

References: The conformance requirements covered in the present TC are specified in: TS 24.301, clause 6.5.4.3, 6.4.4.3 and 7.3.2.

[TS 24.301, clause 6.5.4.3]

Upon receipt of the BEARER RESOURCE MODIFICATION REQUEST message, the MME checks whether the resources requested by the UE can be established, modified or released by verifying the EPS bearer identity given in the EPS bearer identity for packet filter IE.

If the bearer resource modification requested is accepted by the network, the MME shall initiate either a dedicated EPS bearer context activation procedure, an EPS bearer context modification procedure or an EPS bearer context deactivation procedure.

Upon receipt of an ACTIVATE DEDICATED EPS BEARER CONTEXT REQUEST, MODIFY EPS BEARER CONTEXT REQUEST or DEACTIVATE EPS BEARER CONTEXT REQUEST message with a PTI which matches the value used for the BEARER RESOURCE MODIFICATION REQUEST message, the UE shall stop timer T3481 and enter the state PROCEDURE TRANSACTION INACTIVE.

...

- iii) If the DEACTIVATE EPS BEARER CONTEXT REQUEST message is received, the UE verifies that the EPS bearer identity given in the EPS bearer identity IE is any of the active EPS bearer contexts associated with the included linked EPS bearer identity. The UE shall then proceed as described in subclause 6.4.4.3.

...

[TS 24.301, clause 6.4.4.3]

Upon receipt of the DEACTIVATE EPS BEARER CONTEXT REQUEST message, the UE shall delete the EPS bearer context identified by the EPS bearer identity. After deactivating the identified EPS bearer context, the UE shall respond to the MME with the DEACTIVATE EPS BEARER CONTEXT ACCEPT.

...

Upon sending the DEACTIVATE EPS BEARER CONTEXT ACCEPT message, the UE shall enter the state BEARER CONTEXT INACTIVE

If the DEACTIVATE EPS BEARER CONTEXT REQUEST message contains a PTI value other than "no procedure transaction identity assigned" and "reserved" (see 3GPP TS 24.007 [12]), the UE uses the PTI to identify the UE requested bearer resource modification procedure or UE requested PDN disconnect procedure to which the EPS bearer context deactivation is related (see subclause 6.5.4).

If the DEACTIVATE EPS BEARER CONTEXT REQUEST message contains a PTI value other than "no procedure transaction identity assigned" and "reserved" (see 3GPP TS 24.007 [12]), the UE shall release the traffic flow aggregate description associated to the PTI value provided.

...

[TS 24.301, clause 7.3.2]

...

The following UE procedures shall apply for handling an unknown, erroneous, or unforeseen EPS bearer identity received in the header of an ESM message:

...

- i) If the UE receives a MODIFY EPS BEARER CONTEXT REQUEST message which includes an unassigned or reserved EPS bearer identity value or an assigned EPS bearer identity value that does not match an existing EPS bearer context, the UE shall respond with a MODIFY EPS BEARER CONTEXT REJECT message including ESM cause #43 "invalid EPS bearer identity".

...

10.8.4.3 Test description

10.8.4.3.1 Pre-test conditions

System Simulator:

- Cell A

UE:

None.

Preamble:

- The UE is in state Generic RB Established (state 3) according to [18].
- A default EPS bearer and a dedicated bearer are established between the first PDN and the UE.

10.8.4.3.2 Test procedure sequence

Table 10.8.4.3.2-1: Main behaviour

St	Procedure	Message Sequence		TP	Verdict
		U - S	Message		
1	Cause the UE to request bearer resource release of dedicated EPS bearer associated with first PDN connectivity (see Note).	-	-	-	-
2	Check: Does the UE transmit a BEARER RESOURCE MODIFICATION REQUEST message?	-->	BEARER RESOURCE MODIFICATION REQUEST	1	P
3	The SS transmits a DEACTIVATE EPS BEARER CONTEXT REQUEST message.	<--	DEACTIVATE EPS BEARER CONTEXT REQUEST	-	-
4	Check: Does the UE transmit a DEACTIVATE EPS BEARER CONTEXT ACCEPT message?	-->	DEACTIVATE EPS BEARER CONTEXT ACCEPT	2	P
5	The SS transmits a MODIFY EPS BEARER CONTEXT REQUEST message. This message is included in a DLInformationTransfer message.	<--	MODIFY EPS BEARER CONTEXT REQUEST	-	-
6	Check: Does the UE transmit a MODIFY EPS BEARER CONTEXT REJECT message?	-->	MODIFY EPS BEARER CONTEXT REJECT	2	P

Note: The trigger in step 1 and the RRC messages in steps 2 to 4 are the same as in the generic procedure in 36.508 clause 6.4.3.4.

10.8.4.3.3 Specific message contents

Table 10.8.4.3.3-1: Message BEARER RESOURCE MODIFICATION REQUEST (step 2, Table 10.8.4.3.2-1)

Derivation path: 36.508 table 4.7.3-8, condition RELEASE-REQUESTED			
Information Element	Value/Remark	Comment	Condition
EPS bearer identity for packet filter	6		
ESM cause	'0010 0100'B	Regular deactivation	

Table 10.8.4.3.3-2: Message DEACTIVATE EPS BEARER CONTEXT REQUEST (step 3, Table 10.8.4.3.2-1)

Derivation path: 36.508 table 4.7.3-12, condition UE-INITIATED and table 4.6.1-8 with condition DRB-REL(2)			
Information Element	Value/Remark	Comment	Condition
EPS bearer identity	6		

Table 10.8.4.3.3-3: Message MODIFY EPS BEARER CONTEXT REQUEST (step 5, Table 10.8.4.3.2-1)

Derivation path: 36.508 table 4.7.3-18, condition NETWORK-INITIATED			
Information Element	Value/Remark	Comment	Condition
EPS bearer identity	6		
New EPS QoS	According to reference dedicated EPS bearer context #2 - see [18]		
TFT	According to reference dedicated EPS bearer context #2 except for TFT operation code - see [18]		
TFT operation code	'100'B	Replace packet filters in existing TFT	

Table 10.8.4.3.3-4: Message MODIFY EPS BEARER CONTEXT REJECT (step 6, Table 10.8.4.3.2-1)

Derivation path: 36.508 table 4.7.3-17			
Information Element	Value/Remark	Comment	Condition
ESM cause	'0010 1011'B	Invalid EPS bearer identity	

10.8.5 UE requested bearer resource modification / BEARER RESOURCE MODIFICATION REJECT message including cause #43 "invalid EPS bearer identity"

10.8.5.1 Test Purpose (TP)

(1)

```

with { UE has sent the BEARER RESOURCE MODIFICATION REQUEST message }
ensure that {
  when { UE receives a BEARER RESOURCE MODIFICATION REJECT message with the procedure transaction
identity (PTI) indicated in the BEARER RESOURCE MODIFICATION REQUEST message and a cause "invalid
EPS bearer identity" }
  then { UE deactivates the EPS bearer context identified by the EPS bearer identity indicated in
the BEARER RESOURCE MODIFICATION REQUEST message }
}

```

10.8.5.2 Conformance requirements

References: The conformance requirements covered in the present TC are specified in: TS 24.301, clause 6.5.4.4, 6.5.4.5 and 7.3.2.

[TS 24.301, clause 6.5.4.4]

If the bearer resource modification requested cannot be accepted by the network, the MME shall send a BEARER RESOURCE MODIFICATION REJECT message to the UE. The message shall contain the PTI and an ESM cause value indicating the reason for rejecting the UE requested bearer resource modification.

The ESM cause value typically indicates one of the following:

...

#43: invalid EPS bearer identity;

...

Upon receipt of a BEARER RESOURCE MODIFICATION REJECT message, the UE shall stop the timer T3481, release the traffic flow aggregate description associated to the PTI value, and enter the state PROCEDURE TRANSACTION INACTIVE. If the ESM cause included in the BEARER RESOURCE MODIFICATION REJECT message is #43 "invalid EPS bearer identity", the UE locally deactivates the EPS bearer context(s) without peer-to-peer ESM signalling.

The further actions to be performed by the UE are implementation dependent as part of upper layers responsibility.

[TS 24.301, clause 6.5.4.5]

The following abnormal cases can be identified:

...

b) Unknown EPS bearer context

Upon receipt of the BEARER RESOURCE MODIFICATION REJECT message including ESM cause #43 "invalid EPS bearer identity", the UE shall deactivate the existing EPS bearer context locally without peer-to-peer signalling between the UE and the MME.

...

[TS 24.301, clause 7.3.2]

...

The following UE procedures shall apply for handling an unknown, erroneous, or unforeseen EPS bearer identity received in the header of an ESM message:

...

- h) If the UE receives a MODIFY EPS BEARER CONTEXT REQUEST message which includes an unassigned or reserved EPS bearer identity value or an assigned EPS bearer identity value that does not match an existing EPS bearer context, the UE shall respond with a MODIFY EPS BEARER CONTEXT REJECT message including ESM cause #43 "invalid EPS bearer identity".

...

10.8.5.3 Test description

10.8.5.3.1 Pre-test conditions

System Simulator:

- Cell A

UE:

None.

Preamble:

- The UE is in state Generic RB Established (state 3) according to [18].
- A default EPS bearer and a dedicated bearer are established between the first PDN and the UE.

10.8.5.3.2 Test procedure sequence

Table 10.8.5.3.2-1: Main behaviour

St	Procedure	Message Sequence		TP	Verdict
		U - S	Message		
1	Cause the UE to request bearer resource modification of dedicated EPS bearer associated with first PDN connectivity.(see Note)	-	-	-	-
2	The UE transmits a BEARER RESOURCE MODIFICATION REQUEST message.	-->	BEARER RESOURCE MODIFICATION REQUEST	-	-
3	The SS transmits a BEARER RESOURCE MODIFICATION REJECT message.	<--	BEARER RESOURCE MODIFICATION REJECT	-	-
4	The SS transmits a MODIFY EPS BEARER CONTEXT REQUEST message. This message is included in a DLInformationTransfer message.	<--	MODIFY EPS BEARER CONTEXT REQUEST	-	-
5	Check: Does the UE transmit a MODIFY EPS BEARER CONTEXT REJECT message?	-->	MODIFY EPS BEARER CONTEXT REJECT	1	P
Note: The trigger in step 1 and the RRC messages in steps 2 to 5 are the same as in the generic procedure in 36.508 clause 6.4.3.3.					

10.8.5.3.3 Specific message contents

Table 10.8.5.3.3-1: Message BEARER RESOURCE MODIFICATION REQUEST (step 2, Table 10.8.5.3.2-1)

Derivation path: 36.508 table 4.7.3-8			
Information Element	Value/Remark	Comment	Condition
EPS bearer identity for packet filter	6		

Table 10.8.5.3.3-2: Message BEARER RESOURCE MODIFICATION REJECT (step 3, Table 10.8.5.3.2-1)

Derivation path: 36.508 table 4.7.3-7			
Information Element	Value/Remark	Comment	Condition
ESM cause	'0010 1011'B	Invalid EPS bearer identity	

Table 10.8.5.3.3-3: Message MODIFY EPS BEARER CONTEXT REQUEST (step 4, Table 10.8.5.3.2-1)

Derivation path: 36.508 table 4.7.3-18 and table 4.6.1-8 with condition AM-DRB-ADD(2)			
Information Element	Value/Remark	Comment	Condition
EPS bearer identity	6		
Procedure transaction identity	0	No procedure transaction identity assigned	
New EPS QoS	According to reference dedicated EPS bearer context #2 - see [18]		
TFT	According to reference dedicated EPS bearer context #2 except for TFT operation code - see [18]		
TFT operation code	'100'B	Replace packet filters in existing TFT	

Table 10.8.5.3.3-4: Message MODIFY EPS BEARER CONTEXT REJECT (step 5, Table 10.8.5.3.2-1)

Derivation path: 36.508 table 4.7.3-17			
Information Element	Value/Remark	Comment	Condition
ESM cause	'0010 1011'B	Invalid EPS bearer identity	

10.8.6 UE requested bearer resource modification / Collision of a UE requested bearer resource modification procedure and EPS bearer context deactivation procedure

10.8.6.1 Test Purpose (TP)

(1)

```
with { UE having sent the BEARER RESOURCE MODIFICATION REQUEST message }
ensure that {
  when { UE receives a DEACTIVATE EPS BEARER CONTEXT REQUEST message with an unassigned PTI value
and the EPS bearer identity indicated in the BEARER RESOURCE MODIFICATION REQUEST message }
  then { UE aborts the UE requested bearer resource modification procedure and deactivates the EPS
bearer context identified by the EPS bearer identity indicated in DEACTIVATE EPS BEARER CONTEXT
REQUEST message and sends a DEACTIVATE EPS BEARER CONTEXT ACCEPT message }
}
```

10.8.6.2 Conformance requirements

References: The conformance requirements covered in the present TC are specified in: TS 24.301, clause 6.5.4.5 and 7.3.2.

[TS 24.301, clause 6.5.4.5]

The following abnormal cases can be identified:

...

- c) Collision of a UE requested bearer resource modification procedure and an EPS bearer context deactivation procedure.

When the UE receives a DEACTIVATE EPS BEARER CONTEXT REQUEST message during the bearer resource modification procedure, and the EPS bearer identity indicated in the DEACTIVATE EPS BEARER CONTEXT REQUEST message is a EPS bearer context the UE indicated in the UE requested bearer resource modification procedure, then the UE shall abort the UE requested bearer resource modification procedure and proceed with the EPS bearer context deactivation procedure.

[TS 24.301, clause 7.3.1]

The following UE procedures shall apply for handling an unknown, erroneous, or unforeseen PTI received in an ESM message:

...

- j) If the UE receives a MODIFY EPS BEARER CONTEXT REQUEST message in which the PTI value is an assigned value that does not match any PTI in use, the UE shall respond with a MODIFY EPS BEARER CONTEXT REJECT message including ESM cause #47 "PTI mismatch".

10.8.6.3 Test description

10.8.6.3.1 Pre-test conditions

System Simulator:

- Cell A

UE:

None.

Preamble:

- The UE is in state Generic RB Established (state 3) according to [18].
- A default EPS bearer and a dedicated bearer are established between the first PDN and the UE.

10.8.6.3.2 Test procedure sequence

Table 10.8.6.3.2-1: Main behaviour

St	Procedure	Message Sequence		TP	Verdict
		U - S	Message		
1	Cause the UE to request bearer resource modification of dedicated EPS bearer associated with first PDN connectivity.(see Note)	-	-	-	-
2	The UE transmits a BEARER RESOURCE MODIFICATION REQUEST message.	-->	BEARER RESOURCE MODIFICATION REQUEST	-	-
3	The SS transmits a DEACTIVATE EPS BEARER CONTEXT REQUEST message.	<--	DEACTIVATE EPS BEARER CONTEXT REQUEST	-	-
4	Check: Does the UE transmit a DEACTIVATE EPS BEARER CONTEXT ACCEPT message?	-->	DEACTIVATE EPS BEARER CONTEXT ACCEPT	1	P
5	The SS transmits a MODIFY EPS BEARER CONTEXT REQUEST message. This message is included in a DLInformationTransfer message.	<--	MODIFY EPS BEARER CONTEXT REQUEST	-	-
6	Check: Does the UE transmit a MODIFY EPS BEARER CONTEXT REJECT message?	-->	MODIFY EPS BEARER CONTEXT REJECT	1	P
Note: The trigger in step 1 and the RRC messages in steps 2 to 4 are the same as in the generic procedure in 36.508 clause 6.4.3.4.					

10.8.6.3.3 Specific message contents

Table 10.8.6.3.3-1: Message BEARER RESOURCE MODIFICATION REQUEST (step 2, Table 10.8.6.3.2-1)

Derivation path: 36.508 table 4.7.3-8			
Information Element	Value/Remark	Comment	Condition
EPS bearer identity for packet filter	6		

Table 10.8.6.3.3-2: Message DEACTIVATE EPS BEARER CONTEXT REQUEST (step 3, Table 10.8.6.3.2-1)

Derivation path: 36.508 table 4.7.3-12, condition NETWORK-INITIATED and table 4.6.1-8 with condition DRB-REL(2)			
Information Element	Value/Remark	Comment	Condition
EPS bearer identity	6		

Table 10.8.6.3.3-3: Message MODIFY EPS BEARER CONTEXT REQUEST (step 5, Table 10.8.6.3.2-1)

Derivation path: 36.508 table 4.7.3-18			
Information Element	Value/Remark	Comment	Condition
EPS bearer identity	6		
Procedure transaction identity	The same value as the value set in BEARER RESOURCE MODIFICATION REQUEST message in step 2.		
New EPS QoS	According to reference dedicated EPS bearer context #2 - see [18]		
TFT	According to reference dedicated EPS bearer context #2 except for TFT operation code - see [18]		
TFT operation code	'100'B	Replace packet filters in existing TFT	

Table 10.8.6.3.3-4: Message MODIFY EPS BEARER CONTEXT REJECT (step 6, Table 10.8.6.3.2-1)

Derivation path: 36.508 table 4.7.3-17			
Information Element	Value/Remark	Comment	Condition
ESM cause	'0010 1111'B	PTI mismatch	

10.8.7 UE requested bearer resource modification / Expiry of timer T3481

10.8.7.1 Test Purpose (TP)

(1)

```
with { UE has sent a BEARER RESOURCE MODIFICATION REQUEST message }
ensure that {
  when { UE detects less than fifth expiry of timer T3481 }
  then { UE re-sends a BEARER RESOURCE MODIFICATION REQUEST message }
}
```

(2)

```
with { UE is in EMM-REGISTERED.NO-CELL-AVAILABLE state and has deactivated the EPS bearer context
without peer-to-peer signalling between the UE and the MME }
ensure that {
  when { UE receives indication of "back to E-UTRAN coverage" from the lower layers }
  then { UE sends TRACKING AREA UPDATE REQUEST message }
}
```

10.8.7.2 Conformance requirements

References: The conformance requirements covered in the present TC are specified in: TS 24.301, clause 5.5.3.2.2 and 6.5.4.5.

[TS 24.301, clause 5.5.3.2.2]

The UE in state EMM-REGISTERED shall initiate the tracking area updating procedure by sending a TRACKING AREA UPDATE REQUEST message to the MME,

...

- f) when the UE deactivated EPS bearer context(s) locally while in EMM-REGISTERED.NO-CELL-AVAILABLE, and then returns to EMM-REGISTERED.NORMAL-SERVICE;

...

[TS 24.301, clause 6.5.4.5]

The following abnormal cases can be identified:

a) Expiry of timer T3481:

On the first expiry of the timer T3481, the UE shall resend the BEARER RESOURCE MODIFICATION REQUEST and shall reset and restart timer T3481. This retransmission is repeated four times, i.e. on the fifth expiry of timer T3481, the UE shall abort the procedure, release the PTI allocated for this activation and enter the state PROCEDURE TRANSACTION INACTIVE. In addition, if the UE had initiated resource release for all the traffic flows for the bearer, it shall deactivate the EPS bearer context locally without peer-to-peer signalling between the UE and the MME. In order to synchronize the EPS bearer context status with the MME, on indication of "back to E-UTRAN coverage" from the lower layers, the UE shall send a TRACKING AREA UPDATE REQUEST message that includes the EPS bearer context status IE to the MME.

...

10.8.7.3 Test description

10.8.7.3.1 Pre-test conditions

System Simulator:

- Cell A

UE:

None.

Preamble:

- The UE is in state Generic RB Established (state 3) according to [18].
- A default EPS bearer and a dedicated bearer are established between the first PDN and the UE.

10.8.7.3.2 Test procedure sequence

Table 10.8.7.3.2-1: Main behaviour

St	Procedure	Message Sequence		TP	Verdict
		U - S	Message		
1	Cause the UE to request bearer resource release of dedicated EPS bearer associated with first PDN connectivity.(see Note)	-	-	-	-
2	The UE transmits a BEARER RESOURCE MODIFICATION REQUEST message.	-->	BEARER RESOURCE MODIFICATION REQUEST	-	-
3	Wait for 8 s to ensure that T3481 expires (1 st expiry).	-	-	-	-
4	Check: Does the UE transmit a BEARER RESOURCE MODIFICATION REQUEST message?	-->	BEARER RESOURCE MODIFICATION REQUEST	1	P
5	Wait for 8 s to ensure that T3481 expires (2 nd expiry).	-	-	-	-
6	Check: Does the UE transmit a BEARER RESOURCE MODIFICATION REQUEST message?	-->	BEARER RESOURCE MODIFICATION REQUEST	1	P
7	Wait for 8 s to ensure that T3481 expires (3 rd expiry).	-	-	-	-
8	Check: Does the UE transmit a BEARER RESOURCE MODIFICATION REQUEST message?	-->	BEARER RESOURCE MODIFICATION REQUEST	1	P
9	Wait for 8 s to ensure that T3481 expires (4 th expiry).	-	-	-	-
10	Check: Does the UE transmit a BEARER RESOURCE MODIFICATION REQUEST message?	-->	BEARER RESOURCE MODIFICATION REQUEST	1	P
11	Set the cell type of Cell A to the "Non-suitable "Off" cell".	-	-	-	-
12	Wait for 12 s to ensure that T310 plus T311 as well as T3481 expire (5 th expiry).	-	-	-	-
13	Set the cell type of Cell A to the "Suitable cell".	-	-	-	-
14	Check: Does the UE transmit a TRACKING AREA UPDATE REQUEST message?	-->	TRACKING AREA UPDATE REQUEST	2	P
15	The SS transmits a TRACKING AREA UPDATE ACCEPT message.	<--	TRACKING AREA UPDATE ACCEPT	-	-
16	The UE transmits a TRACKING AREA UPDATE COMPLETE message.	-->	TRACKING AREA UPDATE COMPLETE	-	-
-	At the end of this test procedure sequence, the UE is in end state E-UTRA connected (E2_T3440) according to TS 36.508.	-	-	-	-
Note: The trigger in step 1 and the RRC messages in steps 2 to 10 are the same as in the generic procedure in 36.508 clause 6.4.3.3.					

10.8.7.3.3 Specific message contents

Table 10.8.7.3.3-1: Message BEARER RESOURCE MODIFICATION REQUEST (step 2, step 4, step 6, step 8 and step 10, Table 10.8.7.3.2-1)

Derivation path: 36.508 table 4.7.3-8, condition RELEASE-REQUESTED			
Information Element	Value/Remark	Comment	Condition
EPS bearer identity for packet filter	6		

Table 10.8.7.3.3-2: Message TRACKING AREA UPDATE REQUEST (step 14, Table 10.8.7.3.2-1)

Derivation path: 36.508 table 4.7.2-27			
Information Element	Value/Remark	Comment	Condition
EPS bearer context status			
EPS bearer context status IEI	57		
Length of EPS bearer context status contents	2	2 octets	
EBI(0)-EBI(4)	'0 0000'B		
EBI(5-7)	'001'B		
EBI(8)-EBI(15)	'0000 0000'B		

Table 10.8.7.3.3-3: Message TRACKING AREA UPDATE ACCEPT (step 15, Table 10.8.7.3.2-1)

Derivation path: 36.508 table 4.7.2-24			
Information Element	Value/Remark	Comment	Condition
EPS bearer context status			
EPS bearer context status IEI	57		
Length of EPS bearer context status contents	2	2 octets	
EBI(0)-EBI(4)	'0 0000'B		
EBI(5-7)	'001'B		
EBI(8)-EBI(15)	'0000 0000'B		

10.9 UE routing of uplink packets

10.9.1 UE routing of uplinks packets

10.9.1.1 Test Purpose (TP)

(1)

```
with { the UE is in BEARER CONTEXT ACTIVE STATE state and in EMM-CONNECTED mode with a default EPS
bearer and two dedicated EPS bearers active }
ensure that {
  when { the UE has IP packets for transmission where each IP packet matches at least one of the
different packet filters configured in the UL TFTs for the dedicated EPS bearers }
  then { the UE evaluates the packet filters in the correct evaluation order and transmits IP
packets in uplink on the dedicated EPS bearer associated with the matched packet filter }
}
```

(2)

```
with { the UE is in BEARER CONTEXT ACTIVE STATE state and in EMM-CONNECTED mode with a default EPS
bearer and two dedicated EPS bearers active }
ensure that {
  when { the UE has an IP packet for transmission where the IP header does not satisfy any of the
configured packet filters configured in the UL TFT for the dedicated EPS bearers AND no packet
filter is configured for the default EPS bearer }
  then { the UE transmits the IP packet in uplink on the default EPS bearer }
}
```

(3)

```
with { the UE is in BEARER CONTEXT ACTIVE STATE state and in EMM-CONNECTED mode with a default EPS
bearer and two dedicated EPS bearers active }
ensure that {
  when { the UE has an IP packet for transmission where the IP header only satisfies a packet filter
configured in the UL TFT for the default EPS bearers }
  then { the UE transmits the IP packet in uplink on the default EPS bearer }
}
```

(4)

```
with { the UE is in BEARER CONTEXT ACTIVE STATE state and in EMM-CONNECTED mode with a default EPS
bearer and two dedicated EPS bearers active }
ensure that {
  when { the UE has an IP packet for transmission where the IP header does not satisfy any of the
configured packet filters in the UL TFT configured for the default and dedicated EPS bearers }
}
```

```

then { the UE discards the IP packet }
}

```

10.9.1.2 Conformance requirements

References: The conformance requirements covered in the present TC are specified in: TS 23.060, clause 15.3.2.0 and TS 24.008, clause 10.5.6.12.

[TS 23.060, clause 15.3.2.0]

Each valid downlink- and uplink-packet filter contains a unique identifier within a given TFT, an evaluation precedence index that is unique among all packet filters for the same direction (downlink or uplink) for one PDP address and APN pair, and at least one of the following attributes:

- Remote Address and Subnet Mask.
- Protocol Number (IPv4) / Next Header (IPv6).
- Local Port Range.
- Remote Port Range.
- IPSec Security Parameter Index (SPI).
- Type of Service (TOS) (IPv4) / Traffic class (IPv6) and Mask.
- Flow Label (IPv6).

In the list of attributes above 'Remote' refers to the external network entity, and 'Local' to the MS.

Some of the above-listed attributes may coexist in a packet filter while others mutually exclude each other. In table 12 below, the possible combinations are shown. Only those attributes marked with an "X" may be specified for a single packet filter. All marked attributes may be specified, but at least one shall be specified.

If the parameters of the header of a received PDP PDU match all specified attribute values in a packet filter, then it is considered that a match is found for this packet filter. In this case, the evaluation procedure is aborted. Other packet filters in increasing order of their evaluation precedence index are evaluated until such match is found.

There may be potential conflicts if attribute values are combined in such a way that the defined filter can never achieve a match to a valid IP packet header. However, the determination of such conflicts is outside the scope of GPRS standardization.

Table 12: Valid Packet Filter Attribute Combinations

Packet filter attribute	Valid combination types		
	I	II	III
Remote Address and Subnet Mask	X	X	X
Protocol Number (IPv4) / Next Header (IPv6)	X	X	
Local Port Range	X		
Remote Port Range	X		
IPSec SPI		X	
TOS (IPv4) / Traffic Class (IPv6) and Mask	X	X	X
Flow Label (IPv6)			X

[TS 24.008, clause 10.5.6.12]

The purpose of the *traffic flow template* information element is to specify the TFT parameters and operations for a PDP context. In addition, this information element may be used to transfer extra parameters to the network (e.g. the Authorization Token; see 3GPP TS 24.229 [95]). The TFT may contain packet filters for the downlink direction, the uplink direction or packet filters that apply for both directions. The packet filters determine the traffic mapping to PDP contexts. The downlink packet filters shall be applied by the network and the uplink packet filters shall be applied by the MS. A packet filter that applies for both directions shall be applied by the network as a downlink packet filter and by the MS as an uplink filter.

The *traffic flow template* is a type 4 information element with a minimum length of 3 octets. The maximum length for the IE is 257 octets.

NOTE 1: The IE length restriction is due to the maximum length that can be encoded in a single length octet.

NOTE 2: A maximum size IPv4 packet filter can be 32 bytes. Therefore, 7 maximum size IPv4 type packet filters, plus the last packet filter which can contain max 30 octets can fit into one TFT, i.e. if needed not all packet filter components can be defined into one message. A maximum size Ipv6 packet filter can be 60 bytes. Therefore, only 4 maximum size IPv6 packet filters can fit into one TFT. However, using "Add packet filters to existing TFT", it's possible to create a TFT including 16 maximum size Ipv4 or IPv6 filters.

The *traffic flow template* information element is coded as shown in figure 10.5.144/3GPP TS 24.008 and table 10.5.162/3GPP TS 24.008.

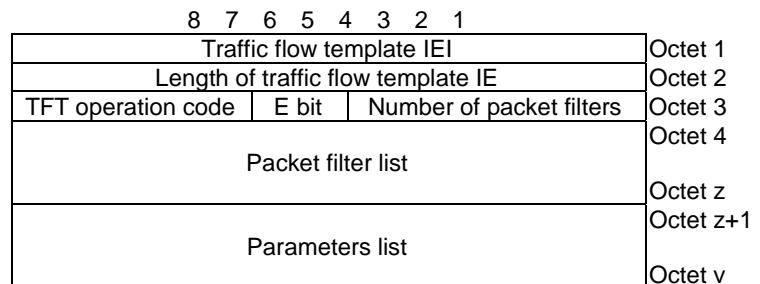

Figure 10.5.144/3GPP TS 24.008: *Traffic flow template* information element

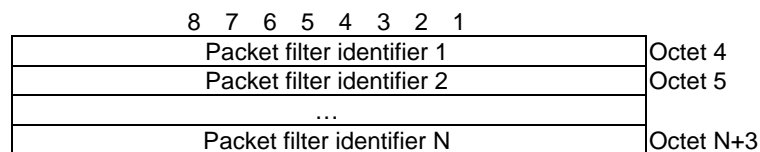

Figure 10.5.144a/3GPP TS 24.008: *Packet filter list* when the TFT operation is "delete packet filters from existing TFT" (z=N+3)

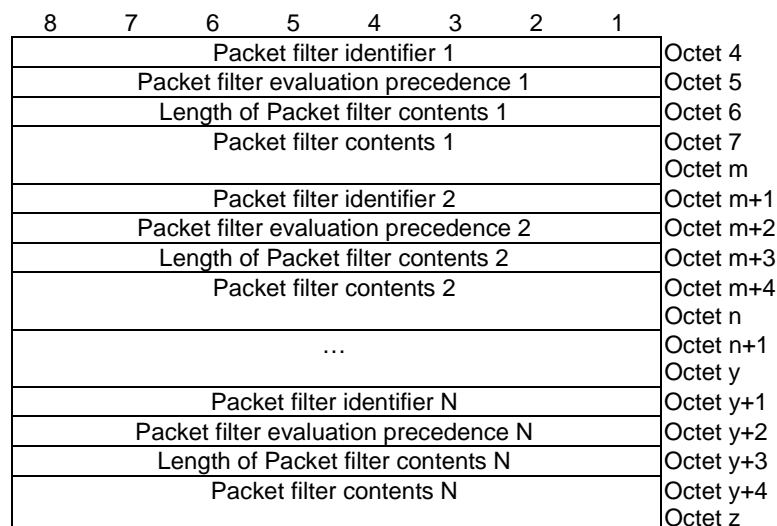

Figure 10.5.144b/3GPP TS 24.008: *Packet filter list* when the TFT operation is "create new TFT", or "add packet filters to existing TFT" or "replace packet filters in existing TFT"

8	7	6	5	4	3	2	1	
Parameter identifier 1								Octet z+1
Length of Parameter contents 1								Octet z+2
Parameter contents 1								Octet z+3
Parameter identifier 2								Octet k
Length of Parameter contents 2								Octet k+1
Parameter contents 2								Octet k+2
...								Octet k+3
Parameter identifier N								Octet p
Length of Parameter contents N								Octet p+1
Parameter contents N								Octet q
Parameter identifier N								Octet q+1
Length of Parameter contents N								Octet q+2
Parameter contents N								Octet q+3
Parameter identifier N								Octet v

Figure 10.5.144c/3GPP TS 24.008: *Parameters list*

Table 10.5.162/3GPP TS 24.008: *Traffic flow template* information element

<p>TFT operation code (octet 3)</p> <p>Bits</p> <p>8 7 6</p> <p>0 0 0 Spare</p> <p>0 0 1 Create new TFT</p> <p>0 1 0 Delete existing TFT</p> <p>0 1 1 Add packet filters to existing TFT</p> <p>1 0 0 Replace packet filters in existing TFT</p> <p>1 0 1 Delete packet filters from existing TFT</p> <p>1 1 0 No TFT operation</p> <p>1 1 1 Reserved</p> <p>The TFT operation code "No TFT operation" shall be used if a <i>parameters list</i> is included but no <i>packet filter list</i> is included in the <i>traffic flow template</i> information element.</p> <p>E bit (bit 5 of octet 3)</p> <p>The <i>E bit</i> indicates if a <i>parameters list</i> is included in the TFT IE and it is encoded as follows:</p> <p>0 <i>parameters list</i> is not included</p> <p>1 <i>parameters list</i> is included</p> <p>Number of packet filters (octet 3)</p> <p>The <i>number of packet filters</i> contains the binary coding for the number of packet filters in the <i>packet filter list</i>. The <i>number of packet filters</i> field is encoded in bits 4 through 1 of octet 3 where bit 4 is the most significant and bit 1 is the least significant bit. For the "delete existing TFT" operation and for the "no TFT operation", the <i>number of packet filters</i> shall be coded as 0. For all other operations, the number of packet filters shall be greater than 0 and less than or equal to 16.</p> <p>Packet filter list (octets 4 to z)</p> <p>The <i>packet filter list</i> contains a variable number of packet filters. For the "delete existing TFT" operation and the "no TFT operation", the <i>packet filter list</i> shall be empty.</p> <p>For the "delete packet filters from existing TFT" operation, the <i>packet filter list</i> shall contain a variable number of packet filter identifiers. This number shall be derived from the coding of the <i>number of packet filters</i> field in octet 3.</p> <p>For the "create new TFT", "add packet filters to existing TFT" and "replace packet filters in existing TFT" operations, the <i>packet filter list</i> shall contain a variable number of packet filters. This number shall be derived from the coding of the <i>number of packet filters</i> field in octet 3.</p> <p>Each packet filter is of variable length and consists of</p> <ul style="list-style-type: none"> - a packet filter identifier and direction (1 octet); - a packet filter evaluation precedence (1 octet); - the length of the packet filter contents (1 octet); and - the packet filter contents itself (v octets). <p>The <i>packet filter identifier</i> field is used to identify each packet filter in a TFT. The least significant 4 bits are used.</p> <p>The <i>packet filter direction</i> is used to indicate, in bits 5 and 6, for what traffic direction</p>
--

the filter applies:

00 - pre Rel-7 TFT filter
 01 - downlink only
 10 - uplink only
 11 - bidirectional

Bits 8 through 7 are spare bits.

The *packet filter evaluation precedence* field is used to specify the precedence for the packet filter among all packet filters in all TFTs associated with this PDP address. Higher the value of the *packet filter evaluation precedence* field, lower the precedence of that packet filter is. The first bit in transmission order is the most significant bit.

The *length of the packet filter contents* field contains the binary coded representation of the length of the *packet filter contents* field of a packet filter. The first bit in transmission order is the most significant bit.

The *packet filter contents* field is of variable size and contains a variable number (at least one) of *packet filter components*. Each *packet filter component* shall be encoded as a sequence of a one octet *packet filter component type identifier* and a fixed length *packet filter component value* field. The *packet filter component type identifier* shall be transmitted first.

In each packet filter, there shall not be more than one occurrence of each packet filter component type. Among the "IPv4 remote address type" and "IPv6 remote address type" packet filter components, only one shall be present in one packet filter. Among the "single local port type" and "local port range type" packet filter components, only one shall be present in one packet filter. Among the "single remote port type" and "remote port range type" packet filter components, only one shall be present in one packet filter.

The term *local* refers to the MS and the term *remote* refers to an external network entity.

Packet filter component type identifier

Bits

8 7 6 5 4 3 2 1

0 0 0 1 0 0 0 0	IPv4 remote address type
0 0 1 0 0 0 0 0	IPv6 remote address type
0 0 1 1 0 0 0 0	Protocol identifier/Next header type
0 1 0 0 0 0 0 0	Single local port type
0 1 0 0 0 0 0 1	Local port range type
0 1 0 1 0 0 0 0	Single remote port type
0 1 0 1 0 0 0 1	Remote port range type
0 1 1 0 0 0 0 0	Security parameter index type
0 1 1 1 0 0 0 0	Type of service/Traffic class type
1 0 0 0 0 0 0 0	Flow label type

All other values are reserved.

For "IPv4 remote address type", the *packet filter component value* field shall be encoded as a sequence of a four octet *IPv4 address* field and a four octet *IPv4 address mask* field. The *IPv4 address* field shall be transmitted first.

For "IPv6 remote address type", the *packet filter component value* field shall be encoded as a sequence of a sixteen octet *IPv6 address* field and a sixteen octet *IPv6 address mask* field. The *IPv6 address* field shall be transmitted first.

For "Protocol identifier/Next header type", the *packet filter component value* field shall be encoded as one octet which specifies the IPv4 protocol identifier or IPv6 next header.

For "Single local port type" and "Single remote port type", the *packet filter component value* field shall be encoded as two octet which specifies a port number.

For "Local port range type" and "Remote port range type", the *packet filter component value* field shall be encoded as a sequence of a two octet *port range low*

limit field and a two octet *port range high limit* field. The *port range low limit* field shall be transmitted first.

For "Security parameter index", the *packet filter component value* field shall be encoded as four octet which specifies the IPsec security parameter index.

For "Type of service/Traffic class type", the *packet filter component value* field shall be encoded as a sequence of a one octet *Type-of-Service/Traffic Class* field and a one octet *Type-of-Service/Traffic Class mask* field. The *Type-of-Service/Traffic Class* field shall be transmitted first.

For "Flow label type", the *packet filter component value* field shall be encoded as three octet which specifies the IPv6 flow label. The bits 8 through 5 of the first octet shall be spare whereas the remaining 20 bits shall contain the IPv6 flow label.

Parameters list (octets z+1 to v)

The *parameters list* contains a variable number of parameters that may be transferred. If the *parameters list* is included, the *E bit* is set to 1; otherwise, the *E bit* is set to 0.

Each parameter included in the *parameters list* is of variable length and consists of:

- a parameter identifier (1 octet);
- the length of the parameter contents (1 octet); and
- the parameter contents itself (v octets).

The *parameter identifier* field is used to identify each parameter included in the *parameters list* and it contains the hexadecimal coding of the parameter identifier. Bit 8 of the *parameter identifier* field contains the most significant bit and bit 1 contains the least significant bit. In this version of the protocol, the following parameter identifiers are specified:

- 01H (Authorization Token);
- 02H (Flow Identifier) ; and
- 03H (Packet Filter Identifier).

If the *parameters list* contains a parameter identifier that is not supported by the receiving entity the corresponding parameter shall be discarded.

The *length of parameter contents* field contains the binary coded representation of the length of the *parameter contents* field. The first bit in transmission order is the most significant bit.

When the *parameter identifier* indicates Authorization Token, the *parameter contents* field contains an authorization token, as specified in 3GPP TS 29.207 [100]. The first octet is the most significant octet of the authorization token and the last octet is the least significant octet of the authorization token.

The *parameters list* shall be coded in a way that an Authorization Token (i.e. a parameter with identifier 01H) is always followed by one or more Flow Identifiers (i.e. one or more parameters with identifier 02H).

If the *parameters list* contains two or more consecutive Authorization Tokens without any Flow Identifiers in between, the receiver shall treat this as a semantical TFT error.

When the *parameter identifier* indicates Flow Identifier, the *parameter contents* field contains the binary representation of a flow identifier. The Flow Identifier consists of four octets. Octets 1 and 2 contains the Media Component number as specified in 3GPP TS 29.207 [100]. Bit 1 of octet 2 is the least significant bit, and bit 8 of octet 1 is the most significant bit. Octets 3 and 4 contains the IP flow number as specified in 3GPP TS 29.207 [100]. Bit 1 of octet 4 is the least significant bit, and bit 8 of octet 3 is the most significant bit.

When the parameter identifier indicates Packet Filter Identifier, the parameter contents field contains the binary representation of one or more packet filter identifiers. Each packet filter identifier is encoded in one octet, in the 4 least significant bits. This parameter is used by the MS to identify one or more packet filters in a TFT when modifying the QoS of a PDP context without modifying the

packet filter itself.

10.9.1.3 Test description

10.9.1.3.1 Pre-test conditions

System Simulator:

- Cell A is configured according to Table 6.3.2.2-1 in [18].

UE:

- None.

Preamble:

- The UE is in state Switched OFF (State 1).

Table 10.9.1.3.2-1: Packet filters

Packet filter ID	UL TFT	Packet filter components										Comments
		Packet filter evaluation precedence	Protocol Number (IPv4) / Next Header (IPv6)	Remote address and Subnet mask	Single Local Port (UE)	Local Port Range (UE)	Single Remote Port (NW)	Remote Port Range (NW)	IPSec SPI range	Type of Service (IPv4) / Traffic Class (IPv6) and Mask	Flow Label (IPv6)	
1	DRB2	6	17 (UDP)	IPv4: 172.168.8.0 [255.255.255.0] IPv6: 2001:0ba0:: [ffff:ffff::]	60001	-	-	60350: 60450	-	10101000, Mask= 11111100	-	UDP application identified by remote address, type of service/traffic class and specific local and remote port numbers This is a valid Packet Filter Attribute Combination Type I according to TS 23.060, subclause 15.3.2.0.
2	DRB3	7	17 (UDP)	IPv4: 172.168.8.0 [255.255.255.0] IPv6: 2001:0ba0:: [ffff:ffff::]	-	60000:6 0100	-	60350	-	10101000, Mask= 11111100	-	UDP application identified by remote address, type of service/traffic class and range of local and remote port numbers. This is a valid Packet Filter Attribute Combination Type I according to TS 23.060, subclause 15.3.2.0.
3	DRB3	5	50 IPSec (ESP)	IPv4: 172.168.8.0 [255.255.255.0] IPv6: 2001:0ba0:: [ffff:ffff::]	-	-	-	-	0x0F80F0000	10100000, Mask= 11111100	-	IPSec session. Example from TS 23.060 cl 15.3.3.3 This is a valid Packet Filter Attribute Combination Type II according to TS 23.060, subclause 15.3.2.0.
4	DRB3	2	-	IPv6: 2001:0ba0:: [ffff:ffff::]	-	-	-	-	-	10110000, Mask= 11111100	5	IPv6 Flow Label filter. This is a valid Packet Filter Attribute Combination Type III according to TS 23.060, subclause 15.3.2.0.
5	DRB1 (default bearer)	255	-	IPv4: 172.168.8.0 [255.255.255.0] IPv6: 2001:0ba0:: [ffff:ffff::]	-	-	-	-	-	-	-	Application identified by remote address. This is a valid Packet Filter Attribute Combination Type I according to TS 23.060, subclause 15.3.2.0.

Table 10.9.1.3.2-2: Sub-test test parameters and test requirements

Sub-test Index	Test data (IP packet) Note 1	Expected DRB associated with the EPS bearer context for the matching packet filter	Packet Filter Attribute Combination under test	Packet Filter Component under test	Comment
1	IP packet#1	DRB2	Type I	All Type I packet filter components match	The IP packet is only matching Packet Filter 1 and 2 in Table 10.9.1.3.2-1. The IP packet is returned on DRB2 as Packet Filter 1 is evaluated before Packet Filter 2.
2	IP packet#2	DRB1	Type I	Remote Address does not match	No packet filter matches. The IP packet is returned on DRB1 (default bearer)
3	IP packet#3	DRB1	Type I	Protocol identifier/Next header does not match	No packet filter matches. The IP packet is returned on DRB1 (default bearer)
4	IP packet#4	DRB3	Type I	Single local port does not match	The IP packet is only matching Packet Filter 2 in Table 10.9.1.3.2-1. The IP packet is returned on DRB3.
5	IP packet#5	DRB1	Type I	Local port range does not match	No packet filter matches. The IP packet is returned on DRB1 (default bearer)
6	IP packet#6	DRB2	Type I	Single remote port does not match	IP packet is only matching Packet Filter 1 in Table 10.9.1.3.2-1. The IP packet is returned on DRB2.
7	IP packet#7	DRB1	Type I	Remote port range does not match	No packet filter matches. The IP packet is returned on DRB1 (default bearer)
8	IP packet#8	DRB1	Type I	Type of service/Traffic class does not match	No packet filter matches. The IP packet is returned on DRB1 (default bearer)
9	IP packet#9	DRB3	Type II	All Type II packet filter components match	The IP packet is only matching Packet Filter 3 in Table 10.9.1.3.2-1. The IP packet is returned on DRB3.
10	IP packet#10	DRB1	Type II	Remote Address does not match	No packet filter matches. The IP packet is returned on DRB1 (default bearer)
11	IP packet#11	DRB1	Type II	Protocol identifier/Next header does not match	No packet filter matches. The IP packet is returned on DRB1 (default bearer)
12	IP packet#12	DRB1	Type II	Security parameter index does not match	No packet filter matches. The IP packet is returned on DRB1 (default bearer)
13	IP packet#13	DRB1	Type II	Type of service/Traffic class does not match	No packet filter matches. The IP packet is returned on DRB1 (default bearer)
14	IP packet#14	DRB3	Type III	All Type III packet filter components match	The IP packet is only matching Packet Filter 4 in Table 10.9.1.3.2-1. The IP packet is returned on DRB2.
15	IP packet#15	DRB1	Type III	Remote Address does not match	No packet filter matches. The IP packet is returned on DRB1 (default bearer)
16	IP packet#16	DRB1	Type III	Type of service/Traffic class does not match	No packet filter matches. The IP packet is returned on DRB1 (default bearer)
17	IP packet#17	DRB1	Type III	Flow Label does not match	No packet filter matches. The IP packet is returned on DRB1 (default bearer)
18	IP packet#18	DRB1	Type I	Remote Address match	IP packet is only matching Packet Filter 5 in Table 10.9.1.3.2-1.
19	IP packet#19	None	Type I	Remote Address does not match	IP packet does not match any Packet Filters.
Note 1:	IP Packet details are specified in Tables 10.9.1.3.3-5 to 10.9.1.3.3-14 in clause 10.9.1.3.3.				
Note 2:	IP packets for sub-test index 1 to 17 are sent by the SS while no TFT is assigned to the default EPS bearer (associated by DRB1). IP packets for sub-test index 18 and 19 are sent by the SS after adding a TFT to the default EPS bearer.				

The test procedure in Table 10.9.1.3.2-3 is executed once for IPv4 case (sub test 1) and once for IPv6 case (sub test 2) dependent on UE capability as specified in Table 10.9.1.3.2-2a.

Table 10.9.1.3.2-2a: Test executions and test parameters

Sub test	Applicability	IPtyp
1	UE supporting IPv4	'IPv4'
2	UE supporting IPv6	'IPv6'
Note 1:	For UEs supporting both IPv4 and IPv6 then both test execution 1 and 2 shall be performed.	

Table 10.9.1.3.2-3: Main behaviour

St	Procedure	Message Sequence		TP	Verdict
		U – S	Message		
0	The SS performs the generic procedure to get UE in Loopback Activated (state 4) on Cell A establishing a default EPS bearer in accordance to Reference default EPS bearer context #1 (DRB1) as specified in subclause 6.6.1 in [18] and two dedicated EPS bearers (DRB2 and DRB3) with EPS bearer context as specified in ACTIVATE DEDICATED EPS BEARER CONTEXT REQUEST message for DRB2 and DRB3 in subclause 10.9.1.3.3.	-	-	-	-
	EXCEPTION: IF IPtype='IPv4' then test steps 1 to 2 are repeated for N= 1 to 13 using the IPv4 packet filters components in Table 10.9.1.3.2-1. IF IPtype='IPv6' then test steps 1 to 2 are repeated for N= 1 to 17 using the IPv6 packet filters components in Table 10.9.1.3.2-1.	-	-	-	-
1	The SS transmits one IP Packet according to Table 10.9.1.3.2-2 for Sub-test index=N on DRB1	-	-	-	-
2	Check: Does UE send the IP Packet on the data radio bearer as specified by Table 10.9.1.3.2-2 for Sub-test index=N?	-	-	1,2	P
3	The SS transmits a MODIFY EPS BEARER CONTEXT REQUEST message to add TFT to the default EPS bearer. This message is included in a DLInformationTransfer message.	<--	MODIFY EPS BEARER CONTEXT REQUEST	-	-
4	UE transmits a MODIFY EPS BEARER CONTEXT ACCEPT message	-->	MODIFY EPS BEARER CONTEXT ACCEPT	-	-
5	The SS transmits one IP Packet according to Table 10.9.1.3.2-2 for Sub-test index=18 on DRB1	-	-	-	-
6	Check: Does UE send the IP Packet on the data radio bearer as specified by Table 10.9.1.3.2-2 for Sub-test index=18?	-	-	3	P
7	The SS transmits one IP Packet according to Table 10.9.1.3.2-2 for Sub-test index=19 on DRB1	-	-	-	-
8	Check: Does UE send an IP Packet on any of the dedicated or default data radio bearers?	-	-	4	F
-	EXCEPTION: Steps 9 – 18 are executed only if two executions apply and this is the first execution.	-	-	-	-
9	The SS transmits an OPEN UE TEST LOOP message to exit the UE test loop mode.	<--	RRC: <i>DLInformationTransfer</i> TC: OPEN UE TEST LOOP	-	-
10	The UE transmits an OPEN UE TEST LOOP COMPLETE message.	-->	RRC: <i>ULInformationTransfer</i> TC: OPEN UE TEST LOOP COMPLETE	-	-
11	The SS transmits a DEACTIVATE TEST MODE message to de-activate UE radio bearer test mode procedure.	<--	RRC: <i>DLInformationTransfer</i> TC: DEACTIVATE TEST MODE	-	-
12	The UE transmits a DEACTIVATE TEST MODE COMPLETE message.	-->	RRC: <i>ULInformationTransfer</i> TC: DEACTIVATE TEST MODE COMPLETE	-	-
13	VOID	-	-	-	-
14	VOID	-	-	-	-
15	VOID	-	-	-	-
16	VOID	-	-	-	-
17	The UE is switched OFF. See Note.	-	-	-	-
18	The UE is switched ON.	-	-	-	-

Note: This implies detaching of the UE, releasing of the RRC connection and resetting of the radio bearers at the SS side.

10.9.1.3.3 Specific message contents

Table 10.9.1.3.3-0A: ACTIVATE DEFAULT EPS BEARER CONTEXT REQUEST (Test execution 2: step 0, Table 10.9.1.3.2-3)

Derivation Path: 36.508 table 4.7.3-6			
Information Element	Value/remark	Comment	Condition
PDN address			
Length of PDN address contents	9 octets		
PDN type value	'010'B	IPv6	
PDN address information	IPv6 interface identifier	The SS provides a valid IPv6 interface identifier	
ESM cause	IF "PDN type" IE in step 4 (preamble) is 'IPv4v6' THEN '00110011'B ELSE Not present	"PDN type IPv6 only allowed"	

Table 10.9.1.3.3-0B: ACTIVATE DEFAULT EPS BEARER CONTEXT REQUEST (Test execution 1: step 0, Table 10.9.1.3.2-3)

Derivation Path: 36.508 table 4.7.3-6			
Information Element	Value/remark	Comment	Condition
PDN address			
Length of PDN address contents	5 octets		
PDN type value	'001'B	IPv4	
PDN address information	IPv4 address	The SS provides a valid IPv4 address	
ESM cause	IF "PDN type" IE in step 4 (preamble) is 'IPv4v6' THEN '00110010'B ELSE Not present	"PDN type IPv4 only allowed"	

Table 10.9.1.3.3-1: Message ACTIVATE DEDICATED EPS BEARER CONTEXT REQUEST step 0, Table 10.9.1.3.2-3 (, DRB2)

Derivation path: 36.508 table 4.7.3-3 and table 4.6.1-8 with condition AM-DRB-ADD(2)			
Information Element	Value/Remark	Comment	Condition
EPS bearer identity	6		
Procedure transaction identity	0	"No procedure transaction identity assigned"	
Linked EPS bearer identity	5	SS re-uses the EPS bearer identity of the default EPS bearer context.	
EPS QoS	According to reference dedicated EPS bearer context #1 - see [18]		
TFT			
TFT operation code	"create new TFT"		
E bit	0		
Packet filters (Note 1)	1		
Note 1: This row refers to the packet filters defined in Table 10.9.1.3.2-1.			

Table 10.9.1.3.3-2: Message ACTIVATE DEDICATED EPS BEARER CONTEXT REQUEST (step 0, Table 10.9.1.3.2-3, DRB3)

Derivation path: 36.508 table 4.7.3-3 and table 4.6.1-8 with condition AM-DRB-ADD(3)			
Information Element	Value/Remark	Comment	Condition
EPS bearer identity	7		
Procedure transaction identity	0	"No procedure transaction identity assigned"	
Linked EPS bearer identity	5	SS re-uses the EPS bearer identity of the default EPS bearer context.	
EPS QoS	According to reference dedicated EPS bearer context #1 - see [18]		
TFT			
TFT operation code	"create new TFT"		
E bit	0		
Packet filters (Note 1)	2, 3		IPv4
	2, 3, 4		IPv6
Note 1: This row refers to the packet filters defined in Table 10.9.1.3.2-1.			

Condition	Explanation
IPv4	This condition applies if test variable IP type is set to 'IPv4'.
IPv6	This condition applies if test variable IP type is set to 'IPv6'.

Table 10.9.1.3.3-3: Message MODIFY EPS BEARER CONTEXT REQUEST (step 3, Table 10.9.1.3.2-3)

Derivation path: 36.508 table 4.7.3-16 and table 4.6.1-3			
Information Element	Value/Remark	Comment	Condition
EPS bearer identity	The same value as the value set in ACTIVATE DEFAULT EPS BEARER CONTEXT REQUEST message	SS assigns the current default EPS bearer context.	
Procedure transaction identity	0	"No procedure transaction identity assigned"	
TFT			
TFT operation code	"Create new TFT"		
E bit	0		
Packet filters (Note 1)	5	SS adds packet filter to the default EPS bearer context.	
Note 1: This row refers to the packet filters defined in Table 10.9.1.3.2-1.			

Table 10.9.1.3.3-4: Message MODIFY EPS BEARER CONTEXT ACCEPT (step 4, Table 10.9.1.3.2-3)

Derivation path: 36.508 table 4.7.3-14			
Information Element	Value/Remark	Comment	Condition
EPS bearer identity	The same value as the value set in ACTIVATE DEFAULT EPS BEARER CONTEXT REQUEST message	Same value as in MODIFY EPS BEARER CONTEXT REQUEST	
Procedure transaction identity	0	"No procedure transaction identity assigned"	

Table 10.9.1.3.3-4A: Void

Table 10.9.1.3.3-5: IP packet#1 (Table 10.9.1.3.2-2)

Derivation path: IETF RFC 791 section 3.1 (IPv4) or RFC 2460 section 3 (IPv6) and RFC 769 introduction			
Information Element	Value/Remark	Comment	Condition
Type of service (IPv4) / Traffic Class (IPv6)	10101001	Significant for packet filters 1, 2, 3, and 4. Value matches packet filters 1 and 2. Value does not match packet filters 3 or 4.	
Protocol	17	UDP Significant packet filters 1, 2 and 3. Value matches packet filters 1 and 2. Value does not match packet filter 3.	
Source Address	192.168.0.1	Not significant for any packet filters	IPv4
	fe80::1:1	Not significant for any packet filters	IPv6
Destination Address	172.168.8.1	Significant for packet filters 1, 2 and 3. Value matches packet filters 1, 2 and 3.	IPv4
	2001:0ba0::0001:0001	Significant for packet filters 1, 2, 3 and 4. Value matches packet filters 1, 2, 3 and 4.	IPv6
Source Port	60001	Significant for packet filters 1 and 2. Value matches packet filters 1 and 2.	
Destination Port	60350	Significant for packet filters 1 and 2. Value matches packet filters 1 and 2.	
Flow Label	10	Significant for packet filter 4. Value does not match packet filter 4.	IPv6

Condition	Explanation
IPv4	This condition applies if test variable IP type is set to 'IPv4'.
IPv6	This condition applies if test variable IP type is set to 'IPv6'.

Table 10.9.1.3.3-6: IP packet#2 (Table 10.9.1.3.2-2)

Derivation path: IP packet#1, Table 10.9.1.3.3-5			
Information Element	Value/Remark	Comment	Condition
Destination Address	172.168.9.1	Significant for packet filter 1, 2 and 3. Value does not match packet filters 1, 2 or 3.	IPv4
	2001:0bb0::0001:0001	Significant for packet filter 1, 2, 3 and 4. Value does not match packet filters 1, 2, 3 or 4.	IPv6

Condition	Explanation
IPv4	This condition applies if test variable IP type is set to 'IPv4'.
IPv6	This condition applies if test variable IP type is set to 'IPv6'.

Table 10.9.1.3.3-7: IP packet#3 (Table 10.9.1.3.2-2)

Derivation path: IP packet#1, Table 10.9.1.3.3-5			
Information Element	Value/Remark	Comment	Condition
Protocol	6	TCP Significant packet filters 1, 2 and 3. Value does not match packet filters 1, 2 or 3.	

Table 10.9.1.3.3-8: IP packet#4 (Table 10.9.1.3.2-2)

Derivation path: IP packet#1, Table 10.9.1.3.3-5			
Information Element	Value/Remark	Comment	Condition
Source Port	60002	Significant for packet filters 1 and 2. Value matches packet filter 2. Value does not match packet filter 1.	

Table 10.9.1.3.3-9: IP packet#5 (Table 10.9.1.3.2-2)

Derivation path: IP packet#1, Table 10.9.1.3.3-5			
Information Element	Value/Remark	Comment	Condition
Source Port	60101	Significant for packet filters 1 and 2. Value does not match packet filters 1 or 2.	

Table 10.9.1.3.3-10: IP packet#6 (Table 10.9.1.3.2-2)

Derivation path: IP packet#1, Table 10.9.1.3.3-5			
Information Element	Value/Remark	Comment	Condition
Destination Port	60351	Significant for packet filters 1 and 2. Value matches packet filter 1. Value does not match packet filter 2	

Table 10.9.1.3.3-11: IP packet#7 (Table 10.9.1.3.2-2)

Derivation path: IP packet#1, Table 10.9.1.3.3-5			
Information Element	Value/Remark	Comment	Condition
Destination Port	60451	Significant for packet filters 1 and 2. Value does not match packet filter 1 or 2.	

Table 10.9.1.3.3-12: IP packet#8 (Table 10.9.1.3.2-2)

Derivation path: IP packet#1, Table 10.9.1.3.3-5			
Information Element	Value/Remark	Comment	Condition
Type of service (IPv4) / Traffic Class (IPv6)	11101001	Significant for packet filters 1, 2, 3, and 4. Value does not match packet filters 1, 2, 3 or 4.	

Table 10.9.1.3.3-13: IP packet#9 (Table 10.9.1.3.2-2)

Derivation path: IETF RFC 791 section 3.1 (IPv4) or RFC 2460 section 3 (IPv6) and RFC 769 introduction			
Information Element	Value/Remark	Comment	Condition
Type of service (IPv4) / Traffic Class (IPv6)	10100010	Significant for packet filters 1, 2, 3, and 4. Value matches packet filter 3. Value does not match packet filters 1, 2 or 4.	
Protocol	50	IPSec (ESP) Significant packet filters 1, 2 and 3. Value matches packet filter 3. Value does not match packet filters 1 or 2.	
Source Address	192.168.0.1	Not significant for any packet filters	IPv4
	Fe80::1:1	Not significant for any packet filters	IPv6
Destination Address	172.168.8.1	Significant for packet filters 1, 2 and 3. Value matches packet filters 1, 2 and 3.	IPv4
	2001:0ba0::0001:0001	Significant for packet filters 1, 2, 3 and 4. Value matches packet filters 1, 2, 3 and 4.	IPv6
Source Port	60101	Significant for packet filters 1 and 2. Value does not match packet filters 1 or 2.	
Destination Port	60451	Significant for packet filters 1 and 2. Value does not match packet filters 1 or 2.	
IP Sec SPI range	0x0F80F0000	Significant for packet filter 3. Value matches packet filter 3.	
Flow Label	10	Significant for packet filter 4. Value does not match packet filter 4.	IPv6

Condition	Explanation
IPv4	This condition applies if test variable IP type is set to 'IPv4'.
IPv6	This condition applies if test variable IP type is set to 'IPv6'.

Table 10.9.1.3.3-14: IP packet#10 (Table 10.9.1.3.2-2)

Derivation path: IP packet#9, Table 10.9.1.3.3-13			
Information Element	Value/Remark	Comment	Condition
Destination Address	172.168.9.1	Significant for packet filter 1, 2 and 3. Value does not match packet filters 1, 2 or 3.	IPv4
	2001:0bb0::0001:0001	Significant for packet filter 1, 2, 3 and 4. Value does not match packet filters 1, 2, 3 or 4.	IPv6

Condition	Explanation
IPv4	This condition applies if test variable IP type is set to 'IPv4'.
IPv6	This condition applies if test variable IP type is set to 'IPv6'.

Table 10.9.1.3.3-15: IP packet#11 (Table 10.9.1.3.2-2)

Derivation path: IP packet#9, Table 10.9.1.3.3-13			
Information Element	Value/Remark	Comment	Condition
Protocol	6	TCP Significant packet filters 1, 2 and 3. Value does not match packet filters 1, 2 or 3.	

Table 10.9.1.3.3-16: IP packet#12 (Table 10.9.1.3.2-2)

Derivation path: IP packet#9, Table 10.9.1.3.3-13			
Information Element	Value/Remark	Comment	Condition
IP Sec SPI range	0x0F90F0000	Significant for packet filter 3. Value does not match packet filter 3.	

Table 10.9.1.3.3-17: IP packet#13 (Table 10.9.1.3.2-2)

Derivation path: IP packet#9, Table 10.9.1.3.3-13			
Information Element	Value/Remark	Comment	Condition
Type of service (IPv4) / Traffic Class (IPv6)	11101001	Significant for packet filters 1, 2, 3 and 4. Value does not match packet filters 1, 2, 3 or 4.	

Table 10.9.1.3.3-18: IP packet#14 (Table 10.9.1.3.2-2)

Derivation path: RFC 2460 section 3 (IPv6) and RFC 769 introduction			
Information Element	Value/Remark	Comment	Condition
Type of service (IPv4) / Traffic Class (IPv6)	10110011	Significant for packet filters 1, 2, 3, and 4. Value matches packet filter 4. Value does not match packet filters 1, 2 or 3.	
Protocol	6	TCP Significant packet filters 1, 2 and 3. Value does not match packet filters 1, 2 or 3.	
Source Address	Fe80::1:1	IPv6 Not significant for any packet filters	
Destination Address	2001:0ba0::0001:0001	IPv6 Significant for packet filters 1, 2, 3 and 4. Value matches packet filters 1, 2, 3 and 4.	
Source Port	60101	Significant for packet filters 1 and 2. Value does not match packet filters 1 or 2.	
Destination Port	60451	Significant for packet filters 1 and 2. Value does not match packet filters 1 or 2.	
Flow Label	5	IPv6 Significant for packet filter 4. Value matches packet filter 4.	

Table 10.9.1.3.3-19: IP packet#15 (Table 10.9.1.3.2-2)

Derivation path: IP packet#14, Table 10.9.1.3.3-18			
Information Element	Value/Remark	Comment	Condition
Destination Address	2001:0bb0::0001:0001	IPv6 Significant for packet filter 1, 2, 3 and 4. Value does not match packet filters 1, 2, 3 or 4.	

Table 10.9.1.3.3-20: IP packet#16 (Table 10.9.1.3.2-2)

Derivation path: IP packet#14, Table 10.9.1.3.3-18			
Information Element	Value/Remark	Comment	Condition
Type of service (IPv4) / Traffic Class (IPv6)	11101001	Significant for packet filters 1, 2, 3 and 4. Value does not match packet filters 1, 2, 3 or 4.	

Table 10.9.1.3.3-21: IP packet#17 (Table 10.9.1.3.2-2)

Derivation path: IP packet#14, Table 10.9.1.3.3-18			
Information Element	Value/Remark	Comment	Condition
Flow Label	10	IPv6 Significant for packet filter 4. Value does not match packet filter 4.	

Table 10.9.1.3.3-22: IP packet#18 (Table 10.9.1.3.2-2)

Derivation path: IETF RFC 791 section 3.1 (IPv4) or RFC 2460 section 3 (IPv6) and RFC 769 introduction			
Information Element	Value/Remark	Comment	Condition
Type of service (IPv4) / Traffic Class (IPv6)	10101010	Significant for packet filters 1, 2, 3, and 4. Value matches packet filter 1 and 2. Value does not match packet filters 3 or 4.	
Protocol	6	TCP Significant packet filters 1, 2 and 3 Value does not match packet filters 1, 2 or 3.	
Source Address	192.168.0.1	Not significant for any packet filters	IPv4
	Fe80::1:1	Not significant for any packet filters	IPv6
Destination Address	172.168.8.1	Significant for packet filters 1, 2, 3 and 5. Value matches packet filters 1, 2, 3 and 5.	IPv4
	2001:0ba0: :0001:0001	Significant for packet filters 1, 2, 3, 4 and 5. Value matches packet filters 1, 2, 3, 4 and 5.	IPv6
Source Port	60101	Significant for packet filters 1 and 2. Value does not match packet filters 1 or 2.	
Destination Port	60451	Significant for packet filters 1 and 2. Value does not match packet filters 1 or 2.	
Flow Label	10	Significant for packet filter 4. Value does not match packet filter 4.	IPv6

Condition	Explanation
IPv4	This condition applies if test variable IP type is set to 'IPv4'.
IPv6	This condition applies if test variable IP type is set to 'IPv6'.

Table 10.9.1.3.3-23: IP packet#19 (Table 10.9.1.3.2-2)

Derivation path: IP packet#18, Table 10.9.1.3.3-22			
Information Element	Value/Remark	Comment	Condition
Destination Address	172.168.9.1	Significant for packet filters 1, 2, 3 and 5. Value does not match packet filters 1, 2, 3 and 5.	IPv4
	2001:0ba1::0001:0001	Significant for packet filters 1, 2, 3, 4 and 5. Value does not match packet filters 1, 2, 3, 4 and 5.	IPv6

11 General tests

11.1 SMS over SGs

11.1.1 MT-SMS over SGs / Idle mode

11.1.1.1 Test Purpose (TP)

(1)

```
with { UE is IMSI attached for non-EPS services and UE has received a paging request with CN domain indicator set to "PS" in EMM-IDLE mode and UE has sent a SERVICE REQUEST message}
ensure that {
  when { UE receives a CP-DATA containing an RP-DATA RPDU (SMS DELIVER TPDU) encapsulated in a Downlink NAS transport message }
  then { UE sends a CP-ACK encapsulated in an Uplink NAS transport message followed by a CP-DATA containing an RP-ACK RPDU encapsulated in an Uplink NAS transport message}
}
```

11.1.1.2 Conformance requirements

References: The conformance requirements covered in the present TC are specified in: 3GPP TS 24.301, clauses 5.6.3.1, 5.6.3.3 and 9.9.3.22.

[TS 24.301, clause 5.6.3.1]

The purpose of the transport of NAS messages procedure is to carry SMS messages in an encapsulated form between the MME and the UE. The procedure may be initiated by the UE or the network and can only be used when the UE is attached for EPS services and IMSI attached for non-EPS services and is in EMM-CONNECTED mode.

[TS 24.301, clause 5.6.3.3]

The network initiates the procedure by sending a DOWNLINK NAS TRANSPORT message. When receiving the DOWNLINK NAS TRANSPORT message, the EMM entity in the UE shall forward the contents of the NAS message container IE to the SMS entity.

[TS 24.301, clause 9.9.3.22]

This information element is used to encapsulate the SMS messages transferred between the UE and the network. The NAS message container information element is coded as shown in figure 9.9.3.22.1 and table 9.9.3.22.1.

The NAS message container is a type 4 information element with a minimum length of 4 octets and a maximum length of 253 octets.

8	7	6	5	4	3	2	1	
NAS message container IEI								octet 1
Length of NAS message container contents								octet 2
								octet 3
NAS message container contents								
								octet n

Figure 9.9.3.22.1: NAS message container information element

Table 9.9.3.22.1: NAS message container information element

NAS message container contents (octet 3 to octet n)
This IE can contain an SMS message (i.e. CP-DATA, CP-ACK or CP-ERROR) as defined in subclause 7.2 in 3GPP TS 24.011 [13A].

11.1.1.3 Test description

11.1.1.3.1 Pre-test conditions

System Simulator:

- Cell A is configured according to Table 6.3.2.2-1 in [18].
- Cell A belongs TAI-1.
- Cell A is set to the "Serving cell".

UE:

- The UE does not have any stored SMS message.

Preamble:

- UE is in state Registered, Idle Mode (state 2) on Cell A according to [18].

11.1.1.3.2 Test procedure sequence

Table 11.1.1.3.2-1: Main behaviour

St	Procedure	Message Sequence		TP	Verdict
		U - S	Message		
1	The SS pages the UE using S-TMSI with CN domain indicator set to 'PS'.	-	-	-	-
2	The UE transmits a SERVICE REQUEST message.	-->	SERVICE REQUEST	-	-
3	The SS transmits a CP-DATA containing an RP-DATA RPDU (SMS DELIVER TPDU) encapsulated in a Downlink NAS transport message to the UE.	<--	DOWNLINK NAS TRANSPORT	-	-
4	Check: Does the UE transmit a CP-ACK encapsulated in an Uplink NAS transport message?	-->	UPLINK NAS TRANSPORT	1	P
5	Check: Does the UE transmit a CP-DATA containing an RP-ACK RPDU encapsulated in an Uplink NAS transport message?	-->	UPLINK NAS TRANSPORT	1	P
6	The SS transmits a CP-ACK encapsulated in a Downlink NAS transport message to the UE.	<--	DOWNLINK NAS TRANSPORT	-	-

11.1.1.3.3 Specific message contents

Table 11.1.1.3.3-1: Message DOWNLINK NAS TRANSPORT (step 3, Table 11.1.1.3.2-1)

Derivation Path: 36.508 clause 4.7.2-12A			
Information Element	Value/remark	Comment	Condition
NAS message container	CP-DATA		

Table 11.1.1.3.3-2: Message CP-DATA (step 3, Table 11.1.1.3.2-1)

Information Element	Value/remark	Comment	Condition
CP-User data	RP-DATA		

Table 11.1.1.3.3-3: Void**Table 11.1.1.3.3-4: Void****Table 11.1.1.3.3-5: Message UPLINK NAS TRANSPORT (step 4, Table 11.1.1.3.2-1)**

Derivation Path: 36.508 clause 4.7.2-27A			
Information Element	Value/remark	Comment	Condition
NAS message container	CP-ACK		

Table 11.1.1.3.3-6: Void**Table 11.1.1.3.3-7: Message UPLINK NAS TRANSPORT (step 5, Table 11.1.1.3.2-1)**

Derivation Path: 36.508 clause 4.7.2-27A			
Information Element	Value/remark	Comment	Condition
NAS message container	CP-DATA		

Table 11.1.1.3.3-8: Message CP-DATA (step 5, Table 11.1.1.3.2-1)

Information Element	Value/remark	Comment	Condition
CP-User data	RP-ACK		

Table 11.1.1.3.3-9: Void**Table 11.1.1.3.3-10: Void****Table 11.1.1.3.3-11: Message DOWNLINK NAS TRANSPORT (step 6, Table 11.1.1.3.2-1)**

Derivation Path: 36.508 clause 4.7.2-12A			
Information Element	Value/remark	Comment	Condition
NAS message container	CP-ACK		

Table 11.1.1.3.3-12: Void**11.1.2 MT-SMS over SGs / Active mode****11.1.2.1 Test Purpose (TP)**

(1)

```

with { UE is IMSI attached for non-EPS services and in EMM-CONNECTED mode }
ensure that {
  when { UE receives a CP-DATA containing an RP-DATA RPDU (SMS DELIVER TPDU) encapsulated in a
Downlink NAS transport message }
  then { UE sends a CP-ACK encapsulated in an Uplink NAS transport message followed by a CP-DATA
containing an RP-ACK RPDU encapsulated in an Uplink NAS transport message}
}

```

11.1.2.2 Conformance requirements

References: The conformance requirements covered in the present TC are specified in: 3GPP TS 24.301, clauses 5.6.3.1, 5.6.3.3, and 9.9.3.22.

[TS 24.301, clause 5.6.3.1]

The purpose of the transport of NAS messages procedure is to carry SMS messages in an encapsulated form between the MME and the UE. The procedure may be initiated by the UE or the network and can only be used when the UE is attached for EPS services and IMSI attached for non-EPS services and is in EMM-CONNECTED mode.

[TS 24.301, clause 5.6.3.3]

The network initiates the procedure by sending a DOWNLINK NAS TRANSPORT message. When receiving the DOWNLINK NAS TRANSPORT message, the EMM entity in the UE shall forward the contents of the NAS message container IE to the SMS entity.

[TS 24.301, clause 9.9.3.22]

This information element is used to encapsulate the SMS messages transferred between the UE and the network. The NAS message container information element is coded as shown in figure 9.9.3.22.1 and table 9.9.3.22.1.

The NAS message container is a type 4 information element with a minimum length of 4 octets and a maximum length of 253 octets.

8	7	6	5	4	3	2	1	
NAS message container IEI								octet 1
Length of NAS message container contents								octet 2
NAS message container contents								octet 3
NAS message container contents								octet n

Figure 9.9.3.22.1: NAS message container information element

Table 9.9.3.22.1: NAS message container information element

NAS message container contents (octet 3 to octet n) This IE can contain an SMS message (i.e. CP-DATA, CP-ACK or CP-ERROR) as defined in subclause 7.2 in 3GPP TS 24.011 [13A].

11.1.2.3 Test description

11.1.2.3.1 Pre-test conditions

System Simulator:

- Cell A is configured according to Table 6.3.2.2-1 in [18].
- Cell A belongs TAI-1.
- Cell A is set to the "Serving cell".

UE:

- The UE does not have any stored SMS message.

Preamble:

- UE is in state Generic RB Established (state 3) on Cell A according to [18].

11.1.2.3.2 Test procedure sequence

Table 11.1.2.3.2-1: Main behaviour

St	Procedure	Message Sequence		TP	Verdict
		U - S	Message		
1	The SS transmits a CP-DATA containing an RP-DATA RPDU (SMS DELIVER TPDU) encapsulated in a Downlink NAS transport message to the UE.	<--	DOWNLINK NAS TRANSPORT	-	-
2	Check: Does the UE transmit a CP-ACK encapsulated in an Uplink NAS transport message?	-->	UPLINK NAS TRANSPORT	1	P
3	Check: Does the UE transmit a CP-DATA containing an RP-ACK RPDU encapsulated in an Uplink NAS transport message?	-->	UPLINK NAS TRANSPORT	1	P
4	The SS transmits a CP-ACK encapsulated in a Downlink NAS transport message to the UE.	<--	DOWNLINK NAS TRANSPORT	-	-

11.1.2.3.3 Specific message contents

Table 11.1.2.3.3-1: Message DOWNLINK NAS TRANSPORT (step 1, Table 11.1.2.3.2-1)

Derivation Path: 36.508 clause 4.7.2-12A			
Information Element	Value/remark	Comment	Condition
NAS message container	CP-DATA		

Table 11.1.2.3.3-2: Message CP-DATA (step 1, Table 11.1.2.3.2-1)

Information Element	Value/remark	Comment	Condition
CP-User data	RP-DATA		

Table 11.1.2.3.3-3: Void**Table 11.1.2.3.3-4: Void****Table 11.1.2.3.3-5: Message UPLINK NAS TRANSPORT (step 2, Table 11.1.2.3.2-1)**

Derivation Path: 36.508 clause 4.7.2-27A			
Information Element	Value/remark	Comment	Condition
NAS message container	CP-ACK		

Table 11.1.2.3.3-6: Void**Table 11.1.2.3.3-7: Message UPLINK NAS TRANSPORT (step 3, Table 11.1.2.3.2-1)**

Derivation Path: 36.508 clause 4.7.2-27A			
Information Element	Value/remark	Comment	Condition
NAS message container	CP-DATA		

Table 11.1.2.3.3-8: Message CP-DATA (step 3, Table 11.1.2.3.2-1)

Information Element	Value/remark	Comment	Condition
CP-User data	RP-ACK		

Table 11.1.2.3.3-9: Void

Table 11.1.2.3.3-10: Void

Table 11.1.2.3.3-12: Message DOWNLINK NAS TRANSPORT (step 4, Table 11.1.2.3.2-1)

Derivation Path: 36.508 clause 4.7.2-12A			
Information Element	Value/remark	Comment	Condition
NAS message container	CP-ACK		

Table 11.1.2.3.3-12: Void

11.1.3 MO-SMS over SGs / Idle mode

11.1.3.1 Test Purpose (TP)

(1)

```
with { UE is IMSI attached for non-EPS services and in EMM-IDLE mode }
ensure that {
  when { a MO SMS is initiated at the UE }
  then { UE sends an SERVICE REQUEST message followed by a CP-DATA containing an RP-DATA RPDU
(SMS SUBMIT TPDU) encapsulated in an Uplink NAS transport message }
}
```

(2)

```
with { UE is IMSI attached for non-EPS services and UE has sent an SERVICE REQUEST message triggered
by MO SMS followed by a CP-DATA containing an RP-DATA RPDU (SMS SUBMIT TPDU) encapsulated in an
Uplink NAS transport message }
ensure that {
  when { UE receives a CP-DATA containing an RP-ACK RPDU encapsulated in a Downlink NAS transport
message }
  then { UE sends a CP-ACK encapsulated in an Uplink NAS Transport message }
}
```

11.1.3.2 Conformance requirements

References: The conformance requirements covered in the present TC are specified in: 3GPP TS 24.301, clauses 5.6.3.1, 5.6.3.2 and 9.9.3.22., TS 23.401 clause 5.3.4.1.

[TS 24.301, clause 5.6.3.1]

The purpose of the transport of NAS messages procedure is to carry SMS messages in an encapsulated form between the MME and the UE. The procedure may be initiated by the UE or the network and can only be used when the UE is attached for EPS services and IMSI attached for non-EPS services and is in EMM-CONNECTED mode.

[TS 24.301, clause 5.6.3.2]

Upon request from the SMS entity to send an SMS message, the EMM entity in the UE initiates the procedure by sending an UPLINK NAS TRANSPORT message including the SMS message in the NAS message container IE.

[TS 24.301, clause 9.9.3.22]

This information element is used to encapsulate the SMS messages transferred between the UE and the network. The NAS message container information element is coded as shown in figure 9.9.3.22.1 and table 9.9.3.22.1.

The NAS message container is a type 4 information element with a minimum length of 4 octets and a maximum length of 253 octets.

8	7	6	5	4	3	2	1	
NAS message container IEI								octet 1
Length of NAS message container contents								octet 2
								octet 3
NAS message container contents								
								octet n

Figure 9.9.3.22.1: NAS message container information element

Table 9.9.3.22.1: NAS message container information element

NAS message container contents (octet 3 to octet n)
This IE can contain an SMS message (i.e. CP-DATA, CP-ACK or CP-ERROR) as defined in subclause 7.2 in 3GPP TS 24.011 [13A].

...

[TS 23.401, clause 5.3.4.1]

1. The UE sends NAS message Service Request towards the MME encapsulated in an RRC message to the eNodeB. The RRC message(s) that can be used to carry the S-TMSI and this NAS message are described in TS 36.300 [5].
2. The eNodeB forwards NAS message to MME. NAS message is encapsulated in an S1-AP: Initial UE Message (NAS message, TAI+ECGI of the serving cell, S-TMSI, CSG ID, CSG access Mode). Details of this step are described in TS 36.300 [5]. If the MME can't handle the Service Request it will reject it. CSG ID is provided if the UE sends the Service Request message via a CSG cell or a hybrid cell. CSG access mode is provided if the UE sends the Service Request message via a hybrid cell. If the CSG access mode is not provided but the CSG ID is provided, the MME shall consider the cell as a CSG cell.

If a CSG ID is indicated and CSG access mode is not provided, and there is no subscription data for this CSG ID or the CSG subscription is expired, the MME rejects the Service Request with an appropriate cause. The UE shall remove the CSG ID of the cell where the UE has initiated the service request procedure from the Allowed CSG list, if present.

For UEs with emergency EPS bearers, i.e. at least one EPS bearer has an ARP values reserved for emergency services, if CSG access restrictions do not allow the UE to get normal services the MME shall deactivate all non-emergency bearers and accept the Service Request.

3. NAS authentication/security procedures as defined in clause 5.3.10 on "Security function" may be performed.
4. The MME sends S1-AP Initial Context Setup Request (Serving GW address, S1-TEID(s) (UL), EPS Bearer QoS(s), Security Context, MME Signalling Connection Id, Handover Restriction List, CSG Membership Indication) message to the eNodeB. This step activates the radio and S1 bearers for all the active EPS Bearers. The eNodeB stores the Security Context, MME Signalling Connection Id, EPS Bearer QoS(s) and S1-TEID(s) in the UE RAN context. The step is described in detail in TS 36.300 [5]. Handover Restriction List is described in clause 4.3.5.7 "Mobility Restrictions".

The MME shall only request to establish Emergency EPS Bearer if the UE is not allowed to access the cell where the UE initiated the service request procedure due to CSG access restriction.

If the Service Request is performed via a hybrid cell, CSG Membership Indication indicating whether the UE is a CSG member shall be included in the S1-AP message from the MME to the RAN. Based on this information the RAN can perform differentiated treatment for CSG and non-CSG members.

5. The eNodeB performs the radio bearer establishment procedure. The user plane security is established at this step, which is described in detail in TS 36.300 [5]. When the user plane radio bearers are setup. EPS bearer state synchronization is performed between the UE and the network, i.e. the UE shall locally remove any EPS bearer for which no radio bearers are setup and, if the radio bearer for a default EPS bearer is not established, the UE shall locally deactivate all EPS bearers associated to that default EPS bearer.

...

11.1.3.3 Test description

11.1.3.3.1 Pre-test conditions

System Simulator:

- Cell A is configured according to Table 6.3.2.2-1 in [18].
- Cell A belongs TAI-1.

- Cell A is set to the "Serving cell".

UE:

- The UE does not have any stored SMS message.

Preamble:

- UE is in state Registered, Idle Mode (state 2) on Cell A according to [18].

11.1.3.3.2 Test procedure sequence

Table 11.1.3.3.2-1: Main behaviour

St	Procedure	Message Sequence		TP	Verdict
		U - S	Message		
1	Sending of a 160 character MO SMS is initiated at the UE via MMI or AT command	-	-	-	-
2	Check: Does the UE transmit an SERVICE REQUEST message?	-->	SERVICE REQUEST	1	P
3	Check: Does the UE transmit a CP-DATA containing an RP-DATA RPDU (SMS SUBMIT TPDU) encapsulated in an Uplink NAS transport message?	-->	UPLINK NAS TRANSPORT	1	P
4	The SS transmits a CP-ACK encapsulated in a Downlink NAS Transport message.	<--	DOWNLINK NAS TRANSPORT	-	-
5	The SS transmits a CP-DATA containing an RP-ACK RPDU encapsulated in an Downlink NAS transport message	<--	DOWNLINK NAS TRANSPORT	-	-
6	Check: Does the UE transmit a CP-ACK encapsulated in an Uplink NAS Transport message?	-->	UPLINK NAS TRANSPORT	2	P

11.1.3.3.3 Specific message contents

Table 11.1.3.3.3-1: Message UPLINK NAS TRANSPORT (step 3, Table 11.1.3.3.2-1)

Derivation Path: 36.508 clause 4.7.2-27A			
Information Element	Value/remark	Comment	Condition
NAS message container	CP-DATA		

Table 11.1.3.3.3-2: Message CP-DATA (step 3, Table 11.1.3.3.2-1)

Information Element	Value/remark	Comment	Condition
CP-User data	RP-DATA		

Table 11.1.3.3.3-3: Void

Table 11.1.3.3.3-4: Void

Table 11.1.3.3.3-5: Message DOWNLINK NAS TRANSPORT (step 4, Table 11.1.3.3.2-1)

Derivation Path: 36.508 clause 4.7.2-12A			
Information Element	Value/remark	Comment	Condition
NAS message container	CP-ACK		

Table 11.1.3.3.3-6: Void

Table 11.1.3.3.3-7: Message DOWNLINK NAS TRANSPORT (step 5, Table 11.1.3.3.2-1)

Derivation Path: 36.508 clause 4.7.2-12A			
Information Element	Value/remark	Comment	Condition
NAS message container	CP-DATA		

Table 11.1.3.3.3-8: Message CP-DATA (step 5, Table 11.1.3.3.2-1)

Information Element	Value/remark	Comment	Condition
CP-User data	RP-ACK		

Table 11.1.3.3.3-9: Void**Table 11.1.3.3.3-10: Void****Table 11.1.3.3.3-11: Message UPLINK NAS TRANSPORT (step 6, Table 11.1.3.3.2-1)**

Derivation Path: 36.508 clause 4.7.2-27A			
Information Element	Value/remark	Comment	Condition
NAS message container	CP-ACK		

Table Void**11.1.4 MO-SMS over SGs / Active mode****11.1.4.1 Test Purpose (TP)**

(1)

```
with { UE is IMSI attached for non-EPS services and in EMM-CONNECTED mode }
ensure that {
  when { a MO SMS is initiated at the UE }
  then { UE sends a CP-DATA containing an RP-DATA RPDU (SMS SUBMIT TPDU) encapsulated in an Uplink
NAS transport message }
}
```

(2)

```
with { UE is IMSI attached for non-EPS services and in EMM-CONNECTED mode and UE has sent a CP-DATA
containing an RP-DATA RPDU (SMS SUBMIT TPDU) encapsulated in an Uplink NAS transport message }
ensure that {
  when { UE receives a CP-DATA containing an RP-ACK RPDU encapsulated in a Downlink NAS transport
message }
  then { UE sends a CP-ACK encapsulated in an Uplink NAS Transport message }
}
```

11.1.4.2 Conformance requirements

References: The conformance requirements covered in the present TC are specified in: 3GPP TS 24.301, clauses 5.6.3.1, 5.6.3.2 and 9.9.3.22, and TS 23.401, clause 5.3.4.1.

[TS 24.301, clause 5.6.3.1]

The purpose of the transport of NAS messages procedure is to carry SMS messages in an encapsulated form between the MME and the UE. The procedure may be initiated by the UE or the network and can only be used when the UE is attached for EPS services and IMSI attached for non-EPS services and is in EMM-CONNECTED mode.

[TS 24.301, clause 5.6.3.2]

Upon request from the SMS entity to send an SMS message, the EMM entity in the UE initiates the procedure by sending an UPLINK NAS TRANSPORT message including the SMS message in the NAS message container IE.

[TS 24.301, clause 9.9.3.22]

This information element is used to encapsulate the SMS messages transferred between the UE and the network. The NAS message container information element is coded as shown in Table 9.9.3.22.1 and 9.9.3.22.2.

The NAS message container is a type 4 information element with a minimum length of 4 octets and a maximum length of 253 octets.

Table 9.9.3.22.1: NAS message container information element

8	7	6	5	4	3	2	1	
NAS message container IEI								octet 1
Length of NAS message container contents								octet 2
NAS message container contents								octet 3
NAS message container contents								octet n

Table 9.9.3.22.2: NAS message container information element

NAS message container contents (octet 3 to octet n)
This IE can contain an SMS message (i.e. CP-DATA, CP-ACK or CP-ERROR) as defined in subclause 7.2 in 3GPP TS 24.011 [13A].

...

[TS 23.401, clause 5.3.4]

1. The UE sends NAS message Service Request towards the MME encapsulated in an RRC message to the eNodeB. The RRC message(s) that can be used to carry the S-TMSI and this NAS message are described in TS 36.300 [5].
2. The eNodeB forwards NAS message to MME. NAS message is encapsulated in an S1-AP: Initial UE Message (NAS message, TAI+ECGI of the serving cell, S-TMSI, CSG ID, CSG access Mode). Details of this step are described in TS 36.300 [5]. If the MME can't handle the Service Request it will reject it. CSG ID is provided if the UE attaches via a closed or hybrid mode CSG cell. CSG access mode is provided if the UE sends the Service Request message via a hybrid mode CSG cell. If the CSG access mode is not provided but the CSG ID is provided, the MME shall consider the CSG cell as a closed mode CSG cell.

If a CSG ID is indicated and CSG access mode is "closed" or CSG access mode is not provided, and there is no subscription data for this CSG ID or the CSG subscription is expired, the MME rejects the Service Request with an appropriate cause. The UE shall remove the CSG ID of the cell where the UE has initiated the service request procedure from the Allowed CSG list.
3. NAS authentication procedures may be performed.
4. The MME sends S1-AP Initial Context Setup Request (Serving GW address, S1-TEID(s) (UL), EPS Bearer QoS(s), Security Context, MME Signalling Connection Id, Handover Restriction List) message to the eNodeB. This step activates the radio and S1 bearers for all the active EPS Bearers. The eNodeB stores the Security Context, MME Signalling Connection Id, EPS Bearer QoS(s) and S1-TEID(s) in the UE RAN context. The step is described in detail in TS 36.300 [5]. Handover Restriction List is described in clause 4.3.5.7 "Mobility Restrictions".
5. The eNodeB performs the radio bearer establishment procedure. The user plane security is established at this step, which is described in detail in TS 36.300 [5]. When the user plane radio bearers are setup the Service Request is completed and EPS bearer state is synchronized between the UE and the network, i.e. the UE should remove the EPS bearer for which no radio bearers are setup.

...

- 11.1.4.3 Test description
- 11.1.4.3.1 Pre-test conditions

System Simulator:

- Cell A is configured according to Table 6.3.2.2-1 in [18].
- Cell A belongs TAI-1.
- Cell A is set to the "Serving cell".

UE:

- The UE does not have any stored SMS message.

Preamble:

- UE is in state Generic RB Established (state 3) on Cell A according to [18].

11.1.4.3.2 Test procedure sequence

Table 11.1.4.3.2-1: Main behaviour

St	Procedure	Message Sequence		TP	Verdict
		U - S	Message		
1	Sending of a 160 character MO SMS is initiated at the UE via MMI or AT command	-	-	-	-
2	Check: Does the UE transmit a CP-DATA containing an RP-DATA RPDU (SMS SUBMIT TPDU) encapsulated in an Uplink NAS transport message?	-->	UPLINK NAS TRANSPORT	1	P
3	The SS transmits a CP-ACK encapsulated in a Downlink NAS Transport message.	<--	DOWNLINK NAS TRANSPORT	-	-
4	The SS transmits a CP-DATA containing an RP-ACK RPDU encapsulated in an Downlink NAS transport message	<--	DOWNLINK NAS TRANSPORT	-	-
5	Check: Does the UE transmit a CP-ACK encapsulated in an Uplink NAS Transport message?	-->	UPLINK NAS TRANSPORT	2	P

11.1.4.3.3 Specific message contents

Table 11.1.4.3.3-1: Message UPLINK NAS TRANSPORT (step 2, Table 11.1.4.3.2-1)

Derivation Path: 36.508 clause 4.7.2-27A			
Information Element	Value/remark	Comment	Condition
NAS message container	CP-DATA		

Table 11.1.4.3.3-2: Message CP-DATA (step 2, Table 11.1.4.3.2-1)

Information Element	Value/remark	Comment	Condition
CP-User data	RP-DATA		

Table 11.1.4.3.3-3: Void

Table 11.1.4.3.3-4: Void

Table 11.1.4.3.3-5: Message DOWNLINK NAS TRANSPORT (step 3, Table 11.1.4.3.2-1)

Derivation Path: 36.508 clause 4.7.2-12A			
Information Element	Value/remark	Comment	Condition
NAS message container	CP-ACK		

Table 11.1.4.3.3-6: Void

Table 11.1.4.3.3-7: Message DOWNLINK NAS TRANSPORT (step 4, Table 11.1.4.3.2-1)

Derivation Path: 36.508 clause 4.7.2-12A			
Information Element	Value/remark	Comment	Condition
NAS message container	CP-DATA		

Table 11.1.4.3.3-8: Message CP-DATA (step 4, Table 11.1.4.3.2-1)

Information Element	Value/remark	Comment	Condition
CP-User data	RP-ACK		

Table 11.1.4.3.3-9: Void

Table 11.1.4.3.3-10: Void

Table 11.1.4.3.3-11: Message UPLINK NAS TRANSPORT (step 5, Table 11.1.4.3.2-1)

Derivation Path: 36.508 clause 4.7.2-27A			
Information Element	Value/remark	Comment	Condition
NAS message container	CP-ACK		

Table 11.1.4.3.3-12: Void

11.1.5 Multiple MO-SMS over SGs / Idle mode

11.1.5.1 Test Purpose (TP)

(1)

```
with { UE is IMSI attached for non-EPS services and in EMM-IDLE mode }
ensure that {
  when { a MO SMS is initiated at the UE }
  then { UE sends an SERVICE REQUEST message followed by a CP-DATA containing an RP-DATA RPDU (SMS SUBMIT TPDU) encapsulated in an Uplink NAS transport message }
}
```

(2)

```
with { UE is IMSI attached for non-EPS services and UE has sent an SERVICE REQUEST message triggered by MO SMS followed by a CP-DATA containing an RP-DATA RPDU (SMS SUBMIT TPDU) encapsulated in an Uplink NAS Transport message }
ensure that {
  when { UE receives a CP-DATA containing an RP-ACK RPDU (SMS SUBMIT REPORT TPDU) encapsulated in a Downlink NAS transport message and has another MO SMS to send }
  then { UE does not send a final CP-ACK before it sends a CP-DATA containing the successive RP-DATA RPDU (SMS SUBMIT TPDU) encapsulated in an Uplink NAS Transport message }
}
```

(3)

```
with { UE is IMSI attached for non-EPS services and UE has sent an SERVICE REQUEST message triggered by MO SMS followed by a CP-DATA containing an RP-DATA RPDU encapsulated in an Uplink NAS transport message }
ensure that {
  when { UE receives a CP-DATA containing an RP-ACK RPDU (SMS SUBMIT REPORT TPDU) encapsulated in a Downlink NAS transport message and does not have any further MO SMS to send }
  then { UE sends a CP-ACK encapsulated in an Uplink NAS Transport message }
}
```

11.1.5.2 Conformance requirements

References: The conformance requirements covered in the present TC are specified in: 3GPP TS 24.301, clauses 5.6.3.1, 5.6.3.2 and 9.9.3.22, TS 23.401 clause 5.3.4.1 and TS 24.011 clause 5.4.

[TS 24.301, clause 5.6.3.1]

The purpose of the transport of NAS messages procedure is to carry SMS messages in an encapsulated form between the MME and the UE. The procedure may be initiated by the UE or the network and can only be used when the UE is attached for EPS services and IMSI attached for non-EPS services and is in EMM-CONNECTED mode.

[TS 24.301, clause 5.6.3.2]

Upon request from the SMS entity to send an SMS message, the EMM entity in the UE initiates the procedure by sending an UPLINK NAS TRANSPORT message including the SMS message in the NAS message container IE.

[TS 24.301, clause 9.9.3.22]

This information element is used to encapsulate the SMS messages transferred between the UE and the network. The NAS message container information element is coded as shown in figure 9.9.3.22.1 and table 9.9.3.22.1.

The NAS message container is a type 4 information element with a minimum length of 4 octets and a maximum length of 253 octets.

8	7	6	5	4	3	2	1	
NAS message container IEI								octet 1
Length of NAS message container contents								octet 2
NAS message container contents								octet 3
NAS message container contents								octet n

Figure 9.9.3.22.1: NAS message container information element

Table 9.9.3.22.1: NAS message container information element

NAS message container contents (octet 3 to octet n)
This IE can contain an SMS message (i.e. CP-DATA, CP-ACK or CP-ERROR) as defined in subclause 7.2 in 3GPP TS 24.011 [13A].

[TS 23.401, clause 5.3.4.1]

1. The UE sends NAS message Service Request towards the MME encapsulated in an RRC message to the eNodeB. The RRC message(s) that can be used to carry the S-TMSI and this NAS message are described in TS 36.300 [5].
2. The eNodeB forwards NAS message to MME. NAS message is encapsulated in an S1-AP: Initial UE Message (NAS message, TAI+ECGI of the serving cell, S-TMSI, CSG ID, CSG access Mode). Details of this step are described in TS 36.300 [5]. If the MME can't handle the Service Request it will reject it. CSG ID is provided if the UE sends the Service Request message via a CSG cell or a hybrid cell. CSG access mode is provided if the UE sends the Service Request message via a hybrid cell. If the CSG access mode is not provided but the CSG ID is provided, the MME shall consider the cell as a CSG cell.

If a CSG ID is indicated and CSG access mode is not provided, and there is no subscription data for this CSG ID or the CSG subscription is expired, the MME rejects the Service Request with an appropriate cause. The UE shall remove the CSG ID of the cell where the UE has initiated the service request procedure from the Allowed CSG list, if present.

For UEs with emergency EPS bearers, i.e. at least one EPS bearer has an ARP values reserved for emergency services, if CSG access restrictions do not allow the UE to get normal services the MME shall deactivate all non-emergency bearers and accept the Service Request.

3. NAS authentication/security procedures as defined in clause 5.3.10 on "Security function" may be performed.
4. The MME sends S1-AP Initial Context Setup Request (Serving GW address, S1-TEID(s) (UL), EPS Bearer QoS(s), Security Context, MME Signalling Connection Id, Handover Restriction List, CSG Membership Indication) message to the eNodeB. This step activates the radio and S1 bearers for all the active EPS Bearers. The eNodeB stores the Security Context, MME Signalling Connection Id, EPS Bearer QoS(s) and S1-TEID(s) in the UE RAN context. The step is described in detail in TS 36.300 [5]. Handover Restriction List is described in clause 4.3.5.7 "Mobility Restrictions".

The MME shall only request to establish Emergency EPS Bearer if the UE is not allowed to access the cell where the UE initiated the service request procedure due to CSG access restriction.

If the Service Request is performed via a hybrid cell, CSG Membership Indication indicating whether the UE is a CSG member shall be included in the S1-AP message from the MME to the RAN. Based on this information the RAN can perform differentiated treatment for CSG and non-CSG members.

5. The eNodeB performs the radio bearer establishment procedure. The user plane security is established at this step, which is described in detail in TS 36.300 [5]. When the user plane radio bearers are setup. EPS bearer state synchronization is performed between the UE and the network, i.e. the UE shall locally remove any EPS bearer for which no radio bearers are setup and, if the radio bearer for a default EPS bearer is not established, the UE shall locally deactivate all EPS bearers associated to that default EPS bearer.

...

[TS 24.011, clause 5.4]

In the case of a SMS transfer via the PS domain, when the MS chooses to use the same PS signalling connection (in Iu mode and in S1 mode if packet-switched service is used); or in the case of a SMS transfer via the PS domain in A/Gb mode; or in the case of SMS transfer through the EPS, then:

- the MS shall transmit the CP-DATA for the successive RPDU and shall not transmit the final CP-ACK for the current SMS (i.e. the one that acknowledges the CP-DATA that carried the RP-ACK);
- the Transaction Identifier used for the successive RPDU shall be different to that used for the current RPDU; and
- the MS shall not transmit the CP-DATA for the successive RPDU before the final CP-DATA (i.e. the one that carried the RP-ACK) has been received.

NOTE: When an MS sends successive memory available notifications and/or mobile originated short messages on different RR connections (in A/Gb mode) or signalling connections (in Iu mode and S1 mode), the MS is strongly recommended to use different Transaction Identifiers for the old and new MM connections.

...

11.1.5.3 Test description

11.1.5.3.1 Pre-test conditions

System Simulator:

- Cell A is configured according to Table 6.3.2.2-1 in [18].
- Cell A belongs TAI-1.
- Cell A is set to the "Serving cell".

UE:

- The UE does not have any stored SMS message.

Preamble:

- UE is in state Registered, Idle Mode (state 2) on Cell A according to [18].

11.1.5.3.2 Test procedure sequence

Table 11.1.5.3.2-1: Main behaviour

St	Procedure	Message Sequence		TP	Verdict
		U - S	Message		
1	Sending of 3 MO SMS as multiple SMS, i.e. one concatenated SMS that is being sent, is initiated at the UE via MMI or AT command	-	-	-	-
2	Check: Does the UE transmit an SERVICE REQUEST message?	-->	SERVICE REQUEST	1	P
3	Check: Does the UE transmit a CP-DATA containing an RP-DATA RPDU (SMS SUBMIT TPDU) encapsulated in an Uplink NAS transport message?	-->	UPLINK NAS TRANSPORT	1	P
4	The SS transmits a CP-ACK encapsulated in a Downlink NAS Transport message.	<--	DOWNLINK NAS TRANSPORT	-	-
5	The SS transmits a CP-DATA containing an RP-ACK RPDU encapsulated in a Downlink NAS transport message	<--	DOWNLINK NAS TRANSPORT	-	-
6	Check: Does the UE transmit a CP-ACK encapsulated in an Uplink NAS Transport message before the CP-DATA in step 7 is transmitted?	-->	UPLINK NAS TRANSPORT	2	F
7	Check: Does the UE transmit a CP-DATA containing an RP-DATA RPDU (SMS SUBMIT TPDU) encapsulated in an Uplink NAS transport message?	-->	UPLINK NAS TRANSPORT	2	P
8	The SS transmits a CP-ACK encapsulated in a Downlink NAS Transport message.	<--	DOWNLINK NAS TRANSPORT	-	-
9	The SS transmits a CP-DATA containing an RP-ACK RPDU encapsulated in a Downlink NAS transport message	<--	DOWNLINK NAS TRANSPORT	-	-
10	Check: Does the UE transmit a CP-ACK encapsulated in an Uplink NAS Transport message before the CP-DATA in step 11 is transmitted?	-->	UPLINK NAS TRANSPORT	2	F
11	Check: Does the UE transmit a CP-DATA containing an RP-DATA RPDU (SMS SUBMIT TPDU) encapsulated in an Uplink NAS transport message?	-->	UPLINK NAS TRANSPORT	2	P
12	The SS transmits a CP-ACK encapsulated in a Downlink NAS Transport message.	<--	DOWNLINK NAS TRANSPORT	-	-
13	The SS transmits a CP-DATA containing an RP-ACK RPDU encapsulated in a Downlink NAS transport message	<--	DOWNLINK NAS TRANSPORT	-	-
14	Check: Does the UE transmit a CP-ACK encapsulated in an Uplink NAS Transport message?	-->	UPLINK NAS TRANSPORT	3	P

11.1.5.3.3 Specific message contents

Table 11.1.5.3.3-1: Message UPLINK NAS TRANSPORT (step 3, Table 11.1.5.3.2-1)

Derivation Path: 36.508 clause 4.7.2-27A			
Information Element	Value/remark	Comment	Condition
NAS message container	CP-DATA		

Table 11.1.5.3.3-2: Message CP-DATA (step 3, Table 11.1.5.3.2-1)

Information Element	Value/remark	Comment	Condition
Transaction identifier	TI used in steps 3, 4 and 5 shall be x.		
CP-User data	RP-DATA		

Table 11.1.5.3.3-3: Message DOWNLINK NAS TRANSPORT (step 4, Table 11.1.5.3.2-1)

Derivation Path: 36.508 clause 4.7.2-12A			
Information Element	Value/remark	Comment	Condition
NAS message container	CP-ACK		

Table 11.1.5.3.3-4: Message DOWNLINK NAS TRANSPORT (step 5, Table 11.1.5.3.2-1)

Derivation Path: 36.508 clause 4.7.2-12A			
Information Element	Value/remark	Comment	Condition
NAS message container	CP-DATA		

Table 11.1.5.3.3-5: Message UPLINK NAS TRANSPORT (step 7, Table 11.1.5.3.2-1)

Derivation Path: 36.508 clause 4.7.2-27A			
Information Element	Value/remark	Comment	Condition
NAS message container	CP-DATA		

Table 11.1.5.3.3-6: Message CP-DATA (step 7, Table 11.1.5.3.2-1)

Information Element	Value/remark	Comment	Condition
Transaction identifier	TI used in steps 7, 8 and 9 shall be y, with $y <> x$ (see step 3).		
CP-User data	RP-DATA		

Table 11.1.5.3.3-7: Message DOWNLINK NAS TRANSPORT (step 8, Table 11.1.5.3.2-1)

Derivation Path: 36.508 clause 4.7.2-12A			
Information Element	Value/remark	Comment	Condition
NAS message container	CP-ACK		

Table 11.1.5.3.3-8: Message DOWNLINK NAS TRANSPORT (step 9, Table 11.1.5.3.2-1)

Derivation Path: 36.508 clause 4.7.2-12A			
Information Element	Value/remark	Comment	Condition
NAS message container	CP-DATA		

Table 11.1.5.3.3-9: Message UPLINK NAS TRANSPORT (step 11, Table 11.1.5.3.2-1)

Derivation Path: 36.508 clause 4.7.2-27A			
Information Element	Value/remark	Comment	Condition
NAS message container	CP-DATA		

Table 11.1.5.3.3-10: Message CP-DATA (step 11, Table 11.1.5.3.2-1)

Information Element	Value/remark	Comment	Condition
Transaction identifier	TI used in steps 11, 12, 13 and 14 shall be z, with $z <> y$ (see step 7).		
CP-User data	RP-DATA		

Table 11.1.5.3.3-11: Message DOWNLINK NAS TRANSPORT (step 12, Table 11.1.5.3.2-1)

Derivation Path: 36.508 clause 4.7.2-12A			
Information Element	Value/remark	Comment	Condition
NAS message container	CP-ACK		

Table 11.1.5.3.3-12: Message DOWNLINK NAS TRANSPORT (step 13, Table 11.1.5.3.2-1)

Derivation Path: 36.508 clause 4.7.2-12A			
Information Element	Value/remark	Comment	Condition
NAS message container	CP-DATA		

Table 11.1.5.3.3-13: Message UPLINK NAS TRANSPORT (step 14, Table 11.1.5.3.2-1)

Derivation Path: 36.508 clause 4.7.2-27A			
Information Element	Value/remark	Comment	Condition
NAS message container	CP-ACK		

11.1.6 Multiple MO-SMS over SGs / Active mode

11.1.6.1 Test Purpose (TP)

(1)

```
with { UE is IMSI attached for non-EPS services and in EMM-CONNECTED mode }
ensure that {
  when { a MO SMS is initiated at the UE }
  then { UE sends a CP-DATA containing an RP-DATA RPDU (SMS SUBMIT TPDU) encapsulated in an Uplink
NAS transport message }
}
```

(2)

```
with { UE is IMSI attached for non-EPS services and in EMM-CONNECTED mode and UE has sent a CP-DATA
containing an RP-DATA RPDU (SMS SUBMIT TPDU) encapsulated in an Uplink NAS transport message }
ensure that {
  when { UE receives a CP-DATA containing an RP-ACK RPDU encapsulated in a Downlink NAS transport
message and has another MO SMS to send }
  then { UE does not send a final CP-ACK before it sends a CP-DATA containing the successive RP-
DATA RPDU (SMS SUBMIT TPDU) encapsulated in an Uplink NAS Transport message }
}
```

(3)

```
with { UE is IMSI attached for non-EPS services and in EMM-CONNECTED mode and UE has sent a CP-DATA
containing an RP-DATA RPDU (SMS SUBMIT TPDU) encapsulated in an Uplink NAS transport message }
ensure that {
  when { UE receives a CP-DATA containing an RP-ACK RPDU encapsulated in a Downlink NAS transport
message and does not have any further MO SMS to send }
  then { UE sends a CP-ACK encapsulated in an Uplink NAS Transport message }
}
```

11.1.6.2 Conformance requirements

References: The conformance requirements covered in the present TC are specified in: 3GPP TS 24.301, clauses 5.6.3.1, 5.6.3.2 and 9.9.3.22, and TS 24.011, clause 5.4.

[TS 24.301, clause 5.6.3.1]

The purpose of the transport of NAS messages procedure is to carry SMS messages in an encapsulated form between the MME and the UE. The procedure may be initiated by the UE or the network and can only be used when the UE is attached for EPS services and IMSI attached for non-EPS services and is in EMM-CONNECTED mode.

[TS 24.301, clause 5.6.3.2]

Upon request from the SMS entity to send an SMS message, the EMM entity in the UE initiates the procedure by sending an UPLINK NAS TRANSPORT message including the SMS message in the NAS message container IE.

[TS 24.011, clause 5.4]

In the case of a SMS transfer via the PS domain, when the MS chooses to use the same PS signalling connection (in Iu mode and in S1 mode if packet-switched service is used); or in the case of a SMS transfer via the PS domain in A/Gb mode; or in the case of SMS transfer through the EPS, then:

- the MS shall transmit the CP-DATA for the successive RPDU and shall not transmit the final CP-ACK for the current SMS (i.e. the one that acknowledges the CP-DATA that carried the RP-ACK);
- the Transaction Identifier used for the successive RPDU shall be different to that used for the current RPDU; and
- the MS shall not transmit the CP-DATA for the successive RPDU before the final CP-DATA (i.e. the one that carried the RP-ACK) has been received.

NOTE: When an MS sends successive memory available notifications and/or mobile originated short messages on different RR connections (in A/Gb mode) or signalling connections (in Iu mode and S1 mode), the MS is strongly recommended to use different Transaction Identifiers for the old and new MM connections.

...

11.1.6.3 Test description

11.1.6.3.1 Pre-test conditions

System Simulator:

- Cell A is configured according to Table 6.3.2.2-1 in [18].
- Cell A belongs TAI-1.
- Cell A is set to the "Serving cell".

UE:

- The UE does not have any stored SMS message.

Preamble:

- UE is in state Generic RB Established (state 3) on Cell A according to [18].

11.1.6.3.2 Test procedure sequence

Table 11.1.6.3.2-1: Main behaviour

St	Procedure	Message Sequence		TP	Verdict
		U - S	Message		
1	Sending of 3 MO SMS as multiple SMS, i.e. one concatenated SMS that is being sent, is initiated at the UE via MMI or AT command	-	-	-	-
2	Check: Does the UE transmit a CP-DATA containing an RP-DATA RPDU (SMS SUBMIT TPDU) encapsulated in an Uplink NAS transport message?	-->	UPLINK NAS TRANSPORT	1	P
3	The SS transmits a CP-ACK encapsulated in a Downlink NAS Transport message.	<--	DOWNLINK NAS TRANSPORT	-	-
4	The SS transmits a CP-DATA containing an RP-ACK RPDU encapsulated in a Downlink NAS transport message	<--	DOWNLINK NAS TRANSPORT	-	-
5	Check: Does the UE transmit a CP-ACK encapsulated in an Uplink NAS Transport message before the CP-DATA in step 6 is transmitted?	-->	UPLINK NAS TRANSPORT	2	F
6	Check: Does the UE transmit a CP-DATA containing an RP-DATA RPDU (SMS SUBMIT TPDU) encapsulated in an Uplink NAS transport message?	-->	UPLINK NAS TRANSPORT	2	P
7	The SS transmits a CP-ACK encapsulated in a Downlink NAS Transport message.	<--	DOWNLINK NAS TRANSPORT	-	-
8	The SS transmits a CP-DATA containing an RP-ACK RPDU encapsulated in a Downlink NAS transport message	<--	DOWNLINK NAS TRANSPORT	-	-
9	Check: Does the UE transmit a CP-ACK encapsulated in an Uplink NAS Transport message before the CP-DATA in step 10 is transmitted?	-->	UPLINK NAS TRANSPORT	2	F
10	Check: Does the UE transmit a CP-DATA containing an RP-DATA RPDU (SMS SUBMIT TPDU) encapsulated in an Uplink NAS transport message?	-->	UPLINK NAS TRANSPORT	2	P
11	The SS transmits a CP-ACK encapsulated in a Downlink NAS Transport message.	<--	DOWNLINK NAS TRANSPORT	-	-
12	The SS transmits a CP-DATA containing an RP-ACK RPDU encapsulated in a Downlink NAS transport message	<--	DOWNLINK NAS TRANSPORT	-	-
13	Check: Does the UE transmit a CP-ACK encapsulated in an Uplink NAS Transport message?	-->	UPLINK NAS TRANSPORT	3	P

11.1.6.3.3 Specific message contents

Table 11.1.6.3.3-1: Message UPLINK NAS TRANSPORT (step 2, Table 11.1.6.3.2-1)

Derivation Path: 36.508 clause 4.7.2-27A			
Information Element	Value/remark	Comment	Condition
NAS message container	CP-DATA		

Table 11.1.6.3.3-2: Message CP-DATA (step 2, Table 11.1.6.3.2-1)

Information Element	Value/remark	Comment	Condition
Transaction identifier	TI used in steps 2, 3 and 4 shall be x.		
CP-User data	RP-DATA		

Table 11.1.6.3.3-3: Message DOWNLINK NAS TRANSPORT (step 3, Table 11.1.6.3.2-1)

Derivation Path: 36.508 clause 4.7.2-12A			
Information Element	Value/remark	Comment	Condition
NAS message container	CP-ACK		

Table 11.1.6.3.3-4: Message DOWNLINK NAS TRANSPORT (step 4, Table 11.1.6.3.2-1)

Derivation Path: 36.508 clause 4.7.2-12A			
Information Element	Value/remark	Comment	Condition
NAS message container	CP-DATA		

Table 11.1.6.3.3-5: Message UPLINK NAS TRANSPORT (step 6, Table 11.1.6.3.2-1)

Derivation Path: 36.508 clause 4.7.2-27A			
Information Element	Value/remark	Comment	Condition
NAS message container	CP-DATA		

Table 11.1.6.3.3-6: Message CP-DATA (step 6, Table 11.1.6.3.2-1)

Information Element	Value/remark	Comment	Condition
Transaction identifier	TI used in steps 6, 7 and 8 shall be y, with $y <> x$ (see step 2).		
CP-User data	RP-DATA		

Table 11.1.6.3.3-7: Message DOWNLINK NAS TRANSPORT (step 7, Table 11.1.6.3.2-1)

Derivation Path: 36.508 clause 4.7.2-12A			
Information Element	Value/remark	Comment	Condition
NAS message container	CP-ACK		

Table 11.1.6.3.3-8: Message DOWNLINK NAS TRANSPORT (step 8, Table 11.1.6.3.2-1)

Derivation Path: 36.508 clause 4.7.2-12A			
Information Element	Value/remark	Comment	Condition
NAS message container	CP-DATA		

Table 11.1.6.3.3-9: Message UPLINK NAS TRANSPORT (step 10, Table 11.1.6.3.2-1)

Derivation Path: 36.508 clause 4.7.2-27A			
Information Element	Value/remark	Comment	Condition
NAS message container	CP-DATA		

Table 11.1.6.3.3-10: Message CP-DATA (step 10, Table 11.1.6.3.2-1)

Information Element	Value/remark	Comment	Condition
Transaction identifier	TI used in steps 10, 11, 12 and 13 shall be z, with $z <> y$ (see step 6).		
CP-User data	RP-DATA		

Table 11.1.6.3.3-11: Message DOWNLINK NAS TRANSPORT (step 11, Table 11.1.6.3.2-1)

Derivation Path: 36.508 clause 4.7.2-12A			
Information Element	Value/remark	Comment	Condition
NAS message container	CP-ACK		

Table 11.1.6.3.3-12: Message DOWNLINK NAS TRANSPORT (step 12, Table 11.1.6.3.2-1)

Derivation Path: 36.508 clause 4.7.2-12A			
Information Element	Value/remark	Comment	Condition
NAS message container	CP-DATA		

Table 11.1.6.3.3-13: Message UPLINK NAS TRANSPORT (step 13, Table 11.1.6.3.2-1)

Derivation Path: 36.508 clause 4.7.2-27A			
Information Element	Value/remark	Comment	Condition
NAS message container	CP-ACK		

11.2 Emergency calls over IMS

11.2.0 General

Unless stated otherwise in a test case, for all test cases in this clause, the UE shall contain either ISIM and USIM applications or only a USIM application on UICC.

11.2.1 Emergency bearer services / Normal cell / NORMAL-SERVICE / Local Emergency Numbers List sent in the Attach / PDN connect new emergency EPS bearer context / Service request / Emergency PDN disconnect

11.2.1.1 Test Purpose (TP)

(1)

```
with { UE in EMM-REGISTERED state and EMM-IDLE mode }
ensure that {
  when { UE has uplink signalling pending for establishing a PDN connection for emergency bearer service }
  then { UE establishes the RRC connection with the RRC establishmentCause set to 'emergency' and sends a SERVICE REQUEST message }
}
```

(2)

```
with { UE is in EMM-REGISTERED state }
ensure that {
  when { UE is triggered to request connectivity to an additional PDN for emergency bearer service }
  then { the UE transmits a PDN CONNECTIVITY REQUEST message with the request type set to "emergency" and not including APN }
}
```

(3)

```
with { UE has sent a PDN CONNECTIVITY REQUEST message }
ensure that {
  when { UE receives an RRCConnectionReconfiguration message including an ACTIVATE DEFAULT EPS BEARER CONTEXT REQUEST message with IE Procedure transaction identity matching the PDN CONNECTIVITY REQUEST message }
  then { UE transmits an ACTIVATE DEFAULT EPS BEARER CONTEXT ACCEPT message containing the EPS bearer identity }
}
```

(4)

```
with { UE is in EMM-REGISTERED state and PDN connection for emergency bearer service established }
ensure that {
  when { UE is triggered to request connectivity to an additional PDN for emergency bearer service }
  then { the UE does not transmit a PDN CONNECTIVITY REQUEST message }
}
```

(5)

```
with { UE is in BEARER CONTEXT ACTIVE STATE state and in EMM-CONNECTED mode }
ensure that {
  when { UE receives a DEACTIVATE EPS BEARER CONTEXT REQUEST message for Emergency bearer service }
  then { UE deletes the emergency EPS bearer context identified by the EPS bearer identity and
transmits a DEACTIVATE EPS BEARER CONTEXT ACCEPT }
}
```

11.2.1.2 Conformance requirements

References: The conformance requirements covered in the present TC are specified in: TS 24.301, clauses 5.3.7, 6.5.1.1, 6.5.1.2, 6.4.1.3, 6.4.4.2, 5.5.3.2.4, 5.6.1.4, 6.4.4.3 and 6.4.4.6.

[TS 24.301, clause 6.5.1.1]

The purpose of the UE requested PDN connectivity procedure is for a UE to request the setup of a default EPS bearer to a PDN. The UE requests connectivity to a PDN by sending a PDN CONNECTIVITY REQUEST message to the network. If accepted by the network, this procedure initiates the establishment of a default EPS bearer context. The procedure is used either to establish the first default bearer by including the PDN CONNECTIVITY REQUEST message into the initial attach message, or to establish subsequent default bearers to additional PDNs in order to allow the UE simultaneous access to multiple PDNs by sending the message stand-alone.

If there is already a PDN connection for emergency bearer services established, the UE shall not request an additional PDN connection for emergency bearer services.

[TS 24.301, clause 6.5.1.2]

In order to request connectivity to an additional PDN, the UE shall send a PDN CONNECTIVITY REQUEST message to the MME, start timer T3482 and enter the state PROCEDURE TRANSACTION PENDING (see example in figure 6.5.1.2.1). If the additional PDN connection is for emergency bearer services, the UE shall not include an APN in the PDN CONNECTIVITY REQUEST message; otherwise the UE shall include the requested APN.

In the PDN type information element the UE shall indicate the IP version capability of the IP stack associated with the UE as specified in subclause 6.4.1.

The UE shall set the request type to "initial request" when the UE is establishing a new PDN connectivity to a PDN in an attach procedure or in a stand-alone PDN connectivity procedure. The UE shall set the request type to "emergency" when the UE is requesting a new PDN connectivity for emergency bearer services. The UE shall set the request type to "handover" when the connectivity to a PDN is established upon handover from a non-3GPP access network and the UE was connected to that PDN before the handover to the 3GPP access network.

[TS 24.301, clause 6.4.1.3]

Upon receipt of the ACTIVATE DEFAULT EPS BEARER CONTEXT REQUEST message, the UE shall send an ACTIVATE DEFAULT EPS BEARER CONTEXT ACCEPT message and enter the state BEARER CONTEXT ACTIVE. When the default bearer is activated as part of the attach procedure, the UE shall send the ACTIVATE DEFAULT EPS BEARER CONTEXT ACCEPT message together with ATTACH COMPLETE message. When the default bearer is activated as the response to the stand-alone PDN CONNECTIVITY REQUEST message, the UE shall send the ACTIVATE DEFAULT EPS BEARER CONTEXT ACCEPT message alone.

The UE checks the PTI in the ACTIVATE DEFAULT EPS BEARER CONTEXT REQUEST message to identify the UE requested PDN connectivity procedure to which the default bearer context activation is related (see subclause 6.5.1).

Upon receipt of the ACTIVATE DEFAULT EPS BEARER CONTEXT ACCEPT message, the MME shall enter the state BEARER CONTEXT ACTIVE and stop the timer T3485, if the timer is running.

[TS 24.301, clause 6.4.4.2]

...

When the MME wants to deactivate all EPS bearer contexts to a PDN and thus disconnect the UE from the PDN, the MME shall include the EPS bearer identity of the default bearer associated to the PDN in the DEACTIVATE EPS BEARER CONTEXT REQUEST message.

If no NAS signalling connection exists when the MME initiates the EPS bearer context deactivation, the ESM entity in the MME shall locally deactivate the EPS bearer context towards the UE without any peer-to-peer ESM signalling between the MME and the UE.

NOTE: The EPS bearer context state(s) can be synchronized between the UE and the MME at the next EMM-IDLE to EMM-CONNECTED transition, e.g. during a service request or tracking area updating procedure.

[TS 24.301, clause 6.4.4.3]

Upon receipt of the DEACTIVATE EPS BEARER CONTEXT REQUEST message, the UE shall delete the EPS bearer context identified by the EPS bearer identity. After deactivating the identified EPS bearer context, the UE shall respond to the MME with the DEACTIVATE EPS BEARER CONTEXT ACCEPT.

If the EPS bearer identity indicated in the DEACTIVATE EPS BEARER CONTEXT REQUEST is that of the default bearer to a PDN, the UE shall delete all EPS bearer contexts associated to the PDN. After deactivating all EPS bearer contexts, the UE shall respond to the MME with the DEACTIVATE EPS BEARER CONTEXT ACCEPT.

Upon sending the DEACTIVATE EPS BEARER CONTEXT ACCEPT message, the UE shall enter the state BEARER CONTEXT INACTIVE

If the PTI is included in the DEACTIVATE EPS BEARER CONTEXT REQUEST message, the UE uses the PTI to identify the UE requested bearer resource modification procedure or UE requested PDN disconnect procedure to which the EPS bearer context deactivation is related (see subclause 6.5.4).

If the PTI is included in the DEACTIVATE EPS BEARER CONTEXT REQUEST message, the UE shall release the traffic flow aggregate description associated to the PTI value provided.

[TS 24.301 clause 5.3.7]

The network may send a Local Emergency Numbers List in the ATTACH ACCEPT or in the TRACKING AREA UPDATE ACCEPT messages, by including the Emergency Number List IE. The user equipment shall store the Local Emergency Numbers List, as provided by the network, except that any emergency number that is already stored in the USIM shall be removed from the Local Emergency Numbers List before it is stored by the user equipment. If there are no emergency numbers stored on the USIM, then before storing the received Local Emergency Numbers List, the user equipment shall remove from the Local Emergency Numbers List any emergency number stored permanently in the user equipment for use in this case (see 3GPP TS 22.101 [8]). The Local Emergency Numbers List stored in the user equipment shall be replaced on each receipt of a new Emergency Number List IE.

The emergency number(s) received in the Emergency Number List IE are valid only in networks with the same MCC as in the cell on which this IE is received. If no Local Emergency Numbers List is contained in the ATTACH ACCEPT or in the TRACKING AREA UPDATE ACCEPT message, then the stored Local Emergency Numbers List in the user equipment shall be kept, except if the user equipment has successfully registered to a PLMN with an MCC different from that of the last registered PLMN.

The Local Emergency Numbers List shall be deleted at switch off and removal of the USIM. The user equipment shall be able to store up to ten local emergency numbers received from the network.

11.2.1.3 Test description

11.2.1.3.1 Pre-test conditions

System Simulator:

- Cell A is configured according to Table 6.3.2.2-1 in [18] and is the serving cell.

UE:

None.

Preamble:

- The UE is in state Registered, Idle mode (state 2) according to [18] on Cell A. UE received local emergency numbers list in 'Attach Accept' message. The local emergency number list is different from all emergency numbers stored in the UE.

11.2.1.3.2 Test procedure sequence

Table 11.2.1.3.2-1: Main behaviour

St	Procedure	Message Sequence		TP	Verdict
		U – S	Message		
1	Cause the UE to request connectivity to an additional PDN for emergency bearer service and an emergency call to one of the numbers received in Attach Accept message (see Note 1)	-	-	-	-
2	Check: Does UE transmit an <i>RRCCoalitionRequest</i> message with <i>establishmentCause</i> set to 'emergency' followed by a SERVICE REQUEST message?	-->	SERVICE REQUEST	1	P
3-13	Steps 5 to 15 of the generic test procedure for IMS Emergency call establishment in EUTRA: in EUTRA: Normal Service (TS 36.508 subclause 4.5A.4.3-1).	-	-	2,3	P
13A	Release IMS Call (see Note 4)	-	-	-	-
14	The SS releases the RRC connection.	-	-	-	-
15	Cause the UE to request connectivity to an additional PDN for emergency bearer service (see Note 1)	-	-	-	-
16	Check: Does UE transmit a SERVICE REQUEST message?	-->	SERVICE REQUEST	4	F
17	The SS transmits a Paging message to the UE using S-TMSI with CN domain indicator set to "PS".	-	-	-	-
18	The UE transmits the SERVICE REQUEST message	-->	SERVICE REQUEST	-	-
19	The SS establishes SRB2 and DRBs associated with two default EPS bearer context (a first PDN obtained during the attach procedure and an additional PDN).(see Note 2)	-	-	-	-
20	The SS transmits a DEACTIVATE EPS BEARER CONTEXT REQUEST including the EPS bearer identity of the default EPS bearer to the additional PDN.	<--	DEACTIVATE EPS BEARER CONTEXT REQUEST	-	-
21	Check: Does the UE transmit a DEACTIVATE EPS BEARER CONTEXT ACCEPT? (see Note 3)	-->	DEACTIVATE EPS BEARER CONTEXT ACCEPT	5	P
<p>Note 1: The request of connectivity to an additional PDN and the sending of data may be performed by MMI or AT command. (e.g. AT command +cgdcont with <Emergency Indication> set to 1)</p> <p>Note 2: After a correct SERVICE REQUEST is received then the SS performs the Radio Bearer Establishment procedure. The UE transmission of the <i>RRCCoalitionReconfigurationComplete</i> message indicates the completion of the radio bearer establishment procedure and that the UE has changed EMM mode from EMM-IDLE to EMM-CONNECTED.</p> <p>Note 3: It can be confirmed that the additional default EPS bearer has been deactivated by UE.</p> <p>Note 4: The IMS Call is released using the generic procedure in 36.508 subclause 4.5A.13.</p>					

11.2.1.3.3 Specific message contents

Table 11.2.1.3.3-1: ATTACH ACCEPT (Preamble)

Derivation path: 36.508 table 4.7.2-1			
Information Element	Value/Remark	Comment	Condition
Emergency number list	2 numbers TS 24.008, 10.5.3.13	The numbers shall be different than any of those indicated in TS 22.101 clause 10.1.1 AND the numbers stored in the USIM AND any emergency number stored permanently in the ME	
EPS network feature support	'0000 0111'B	- IMS voice over PS session in S1 mode supported - emergency bearer services in S1 mode supported - location services via EPC supported - no information about support of location services via CS domain is available	

Table 11.2.1.3.3-2: Message PDN CONNECTIVITY REQUEST (step 4, Table 11.2.1.3.2-1)

Derivation Path: 36.508 table 4.7.2-1			
Information Element	Value/Remark	Comment	Condition
Request type	'0100'B	emergency	
Access point name	Not present		

Table 11.2.1.3.3-3: Message ACTIVATE DEFAULT EPS BEARER CONTEXT REQUEST (step 5, Table 11.2.1.3.2-1)

Derivation path: 36.508 table 4.7.3-6 and table 4.6.1-8 with condition UM-DRB-ADD(2)			
Information Element	Value/Remark	Comment	Condition
EPS bearer identity	6	SS assigns an additional EPS Bearer Id different from default EPS Bearer Id between 5 and 15.	
Access point name	APN-1		

Table 11.2.1.3.3-4: Message DEACTIVATE EPS BEARER CONTEXT REQUEST (step 13, Table 11.2.1.3.2-1)

Derivation path: 36.508 table 4.7.3-12 and table 4.6.1-8 with condition and condition NETWORK-INITIATED			
Information Element	Value/Remark	Comment	Condition
EPS bearer identity	Default EBId-2	Same value as in ACTIVATE DEFAULT EPS BEARER CONTEXT REQUEST of step 3	
ESM cause	00100100	regular deactivation	

11.2.2 Emergency bearer services / Normal cell / LIMITED-SERVICE / Attach / PDN connect

11.2.2.1 Test Purpose (TP)

(1)

```
with { UE in EMM-DEREGISTERED.LIMITED-SERVICE state }
ensure that {
  when { UE is requested to make an outgoing emergency call }
  then { UE transmits an ATTACH REQUEST message }
}
```

11.2.2.2 Conformance requirements

References: The conformance requirements covered in the present TC are specified in: 3GPP TS 24.301 clauses 5.2.2.3.2, 5.5.1.2.2, 5.5.2.1 and 6.5.1.2.

[TS 24.301, clause 5.2.2.3.2]

The UE shall initiate an attach or combined attach procedure when entering a cell which provides normal service.

The UE may initiate attach for emergency bearer services.

[TS 24.301, clause 5.5.1.2.2]

In state EMM-DEREGISTERED, the UE initiates the attach procedure by sending an ATTACH REQUEST message to the MME, starting timer T3410 and entering state EMM-REGISTERED-INITIATED (see example in figure 5.5.1.2.2.1). If timer T3402 is currently running, the UE shall stop timer T3402. If timer T3411 is currently running, the UE shall stop timer T3411.

...

The UE shall send the ATTACH REQUEST message together with a PDN CONNECTIVITY REQUEST message contained in the ESM message container information element to request PDN connectivity.

If UE supports A/Gb mode or Iu mode or if the UE wants to indicate its UE specific DRX parameter to the network, the UE shall include the UE specific DRX parameter in the DRX parameter IE in the ATTACH REQUEST message.

If a valid NAS security context exists, the UE shall integrity protect the ATTACH REQUEST message combined with the PDN CONNECTIVITY REQUEST message. When the UE does not have a valid NAS security context, the ATTACH REQUEST message combined with the PDN CONNECTIVITY REQUEST message is not integrity protected.

[TS 24.301, clause 5.5.2.1]

...

After the completion of application for which the emergency services were invoked, in order to regain normal services, a UE attached for emergency bearer services may perform a detach procedure, followed by a subsequent re-attach, if the UE moves to a new cell that provides normal service.

[TS 24.301, clause 6.5.1.2]

When the PDN CONNECTIVITY REQUEST message is sent together with an ATTACH REQUEST message, the UE shall not include the APN.

11.2.2.3 Test description

11.2.2.3.1 Pre-test conditions

System Simulator:

- Cell A
- The PLMN is defined in Table 11.2.2.3.1-1.

Table 11.2.2.3.1–1: PLMN identifier

Cell	PLMN name	MCC / MNC
A	PLMN4	004 / 31

UE:

- The UE is equipped with either ISIM and USIM applications or only a USIM application on UICC. The USIM contains default values except for those listed in Table 11.2.2.3.1-2.

Table 11.2.2.3.1–2: USIM configuration

USIM field	Priority	Value	Access Technology Identifier
EF _{IMSI}		The HPLMN (MCC+MNC) of the IMSI is set to PLMN1.	
EF _{FPLMN}		PLMN4	
EF _{PLMNwAcT}	1	Default	E-UTRAN
EF _{OPLMNwAcT}	1	PLMN1	E-UTRAN
EF _{HPLMNwAcT}	1	PLMN1	E-UTRAN

Preamble:

- The UE is Switched OFF (State 1) according to [18].

11.2.2.3.2 Test procedure sequence

Table 11.2.2.3.2-1: Main behaviour

St	Procedure	Message Sequence		TP	Verdict
		U - S	Message		
1	Power on the UE.	-	-	-	-
2	Wait 60s for the UE to camp on Cell 1 as an acceptable cell.	-	-	-	-
3-5	Steps 1 to 3 of the generic test procedure for IMS Emergency call establishment in EUTRA: Limited Service (TS 36.508 subclause 4.5A.5.3-1).	-	-	-	-
6	Check: Does the UE transmit an ATTACH REQUEST message to attach for emergency bearer services, together with a PDN CONNECTIVITY REQUEST message for emergency bearer services?	-->	ATTACH REQUEST PDN CONNECTIVITY REQUEST	1	P
7-21	Steps 5 to 19 of the generic test procedure for IMS Emergency call establishment in EUTRA: Limited Service (TS 36.508 subclause 4.5A.5.3-1).	-	-	-	-
22	Release IMS Call (see Note 1)	-	-	-	-
23	The SS releases the RRC connection.	-	-	-	-

Note 1: The IMS Call is released using the generic procedure in 36.508 subclause 4.5A.13.

Table 11.2.2.3.2-2: Void

11.2.2.3.3 Specific message contents

Table 11.2.2.3.3-1: ATTACH REQUEST (Step6, Table 11.2.2.3.2-1)

Derivation Path: 36.508, Table 4.7.2-4			
Information Element	Value/remark	Comment	Condition
EPS attach type	'0110'B	EPS emergency attach	
ESM message container	PDN CONNECTIVITY REQUEST message to request PDN connectivity to an emergency PDN		

Table 11.2.2.3.3-2: PDN CONNECTIVITY REQUEST (Step 6, Table 11.2.2.3.2-1)

Derivation Path: 36.508, Table 4.7.3-20			
Information Element	Value/remark	Comment	Condition
Request type	'0100'B	emergency	

11.2.3 Emergency bearer services / CSG cell / LIMITED-SERVICE / Attach / Security mode control procedure without prior authentication / PDN connect / Service request / PDN disconnect / Detach upon UE switched off / Temporary storage of EMM information

11.2.3.1 Test Purpose (TP)

(1)

```

with { the only suitable cell is a non-allowed CSG cell }
ensure that {
  when { a call to send user data related to Emergency call is originated at the UE }
  then { UE performs an Attach for emergency bearer services on non-allowed CSG cell }
}

```

(2)

void

(3)

```

with { the UE is attached for emergency bearer services }
ensure that {
  when { the UE is detached }
  then { the UE deletes EMM parameters stored temporarily while attached for emergency bearer
services }
}

```

11.2.3.2 Conformance requirements

References: The conformance requirements covered in the present TC are specified in: 3GPP TS 24.301 clauses 5.2.3.2.3, 5.4.3.2, 5.5.1.2.2, 5.5.2.1, 5.6.1.4 and Annex C.

[TS 24.301, clause 5.2.3.2.3]

The UE:

- shall perform cell selection/reselection according to 3GPP TS 36.304 [21];
- may respond to paging (with IMSI); and
- may initiate attach for emergency bearer services.

If a valid NAS security context exists, the UE shall integrity protect the ATTACH REQUEST message combined with the PDN CONNECTIVITY REQUEST message. When the UE does not have a valid NAS security context, the ATTACH REQUEST message combined with the PDN CONNECTIVITY REQUEST message is not integrity protected.

[TS 24.301, clause 5.4.3.2]

...

The MME shall create a locally generated K_{ASME} and send the SECURITY MODE COMMAND message including a KSI value in the NAS key set identifier IE set to "000" and EIA0 and EEA0 as the selected NAS security algorithms when the security mode control procedure is initiated:

- during an attach procedure for emergency bearer services if no shared EPS security context is available;
- during a tracking area updating procedure for a UE that has a PDN connection for emergency bearer services if no shared EPS security context is available; or
- after a failed authentication procedure for a UE that has a PDN connection for emergency bearer services if continued usage of a shared security context is not possible.

The UE shall process a SECURITY MODE COMMAND message including a KSI value in the NAS key set identifier IE set to "000" and EIA0 and EEA0 as the selected NAS security algorithms and, if accepted, create a locally generated K_{ASME} when the security mode control procedure is initiated:

- during an attach procedure for emergency bearer services;
- during a tracking area updating procedure when the UE has a PDN connection for emergency bearer services; or
- after an authentication procedure when the UE has a PDN connection for emergency bearer services.

NOTE 1: The process for creation of the locally generated K_{ASME} by the MME and the UE is implementation dependent.

...

[TS 24.301, clause 5.5.1.2.2]

...

In state EMM-DEREGISTERED, the UE initiates the attach procedure by sending an ATTACH REQUEST message to the MME, starting timer T3410 and entering state EMM-REGISTERED-INITIATED (see example in figure 5.5.1.2.2.1). If timer T3402 is currently running, the UE shall stop timer T3402. If timer T3411 is currently running, the UE shall stop timer T3411.

If the UE supports neither A/Gb mode nor Iu mode, the UE shall handle the EPS mobile identity IE in the ATTACH REQUEST message as follows:

- The UE shall include in the ATTACH REQUEST message a valid GUTI together with the last visited registered TAI, if available. If there is no valid GUTI available, the UE shall include the IMSI in the ATTACH REQUEST message.

If the UE supports A/Gb mode or Iu mode, the UE shall handle the EPS mobile identity as follows:

- If the TIN indicates "P-TMSI" and the UE holds a valid P-TMSI and RAI, the UE shall map the P-TMSI and RAI into the EPS mobile identity IE. If a P-TMSI signature is associated with the P-TMSI, the UE shall include it in the Old P-TMSI signature IE. Additionally, if the UE holds a valid GUTI, the UE shall indicate the GUTI in the Additional GUTI IE.

NOTE: The mapping of the P-TMSI and the RAI to the GUTI is specified in 3GPP TS 23.003 [2].

- If the TIN indicates "GUTI" or "RAT-related TMSI" and the UE holds a valid GUTI, the UE shall indicate the GUTI in the EPS mobile identity IE.
- If the TIN is deleted and
 - the UE holds a valid GUTI, the UE shall indicate the GUTI in the EPS mobile identity IE; or
 - otherwise, if the UE holds a valid P-TMSI and RAI, the UE shall map the P-TMSI and RAI into the EPS mobile identity IE. If a P-TMSI signature is associated with the P-TMSI, the UE shall include it in the Old P-TMSI signature IE.
- Otherwise the UE shall include the IMSI in the EPS mobile identity IE.

If the UE is attaching for emergency bearer services and does not hold a valid GUTI, P-TMSI or IMSI as described above, the IMEI shall be included in the EPS mobile identity IE.

The UE shall send the ATTACH REQUEST message together with a PDN CONNECTIVITY REQUEST message contained in the ESM message container information element to request PDN connectivity.

If UE supports A/Gb mode or Iu mode or if the UE wants to indicate its UE specific DRX parameter to the network, the UE shall include the UE specific DRX parameter in the DRX parameter IE in the ATTACH REQUEST message.

If a valid NAS security context exists, the UE shall integrity protect the ATTACH REQUEST message combined with the PDN CONNECTIVITY REQUEST message. When the UE does not have a valid NAS security context, the ATTACH REQUEST message combined with the PDN CONNECTIVITY REQUEST message is not integrity protected.

[TS 24.301, clause 5.5.2.1]

...

After the completion of application for which the emergency services were invoked, in order to regain normal services, a UE attached for emergency bearer services may perform a detach procedure, followed by a subsequent re-attach, if the UE moves to a new cell that provides normal service.

If a detach is requested by the HSS for a UE that has bearers for emergency services, the MME shall not send a DETACH REQUEST message to the UE, and shall follow the procedures in subclause 6.4.4.1 for a UE that has bearers for emergency services.

If the detach procedure for EPS services is performed, the EPS bearer context(s) for this particular UE are deactivated locally without peer-to-peer signalling between the UE and the MME.

...

[TS 24.301, clause 5.6.1.4]

...

If the SERVICE REQUEST message was sent in a CSG cell and the CSG subscription has expired or was removed for a UE, but the UE has a PDN connection for emergency bearer services established, the network shall accept the SERVICE REQUEST message and deactivate all non-emergency EPS bearers locally. The emergency EPS bearers shall not be deactivated.

...

[TS 24.301, Annex C]

The following EMM parameters shall be stored on the USIM if the corresponding file is present:

- GUTI;
- last visited registered TAI;
- EPS update status;
- Allowed CSG list;
- Operator CSG list; and
- EPS security context parameters from a full native EPS security context (see 3GPP TS 33.401 [19]).

...

...

The following EMM parameter shall be stored in a non-volatile memory in the ME together with the IMSI from the USIM:

- TIN.

...

If the UE is attached for emergency bearer services, the UE shall not store the EMM parameters described in this annex on the USIM or in non-volatile memory. Instead the UE shall temporarily store these parameters locally in the ME and the UE shall delete these parameters when the UE is detached.

11.2.3.3 Test description

11.2.3.3.1 Pre-test conditions

System Simulator:

- cell A and cell B.
 - cell A is not a CSG cell and is "Serving cell";
 - cell B is a CSG cell and is "Non-suitable cell".
- System information combination 7 as defined in TS 36.508[18] clause 4.4.3.1 is used in E-UTRA cells.

UE:

- if pc_Allowed_CSG_list, the UE's Allowed CSG list is empty.

Preamble:

- the UE is in state Registered, Idle mode (state 2) on cell A according to 36.508 [18].
- the UE is not attached for emergency bearer services.

11.2.3.3.2 Test procedure sequence

Table 11.2.3.3.2-1: Main behaviour

St	Procedure	Message Sequence		TP	Verdict
		U - S	Message		
1	The SS configures: - cell A as a "Non-suitable "Off" cell". - cell B as a "Serving cell".	-	-	-	-
2	The SS waits 1 min to ensure the UE is in limited service on Cell B.	-	-	-	-
3	Cause the UE to originate a call to send user data related to Emergency call. (Note 1)	-	-	-	-
4	Check: Does the UE transmit an ATTACH REQUEST message to attach for emergency bearer services, together with a PDN CONNECTIVITY REQUEST message for emergency bearer services, on Cell B?	-->	ATTACH REQUEST PDN CONNECTIVITY REQUEST	1	P
5-14	Steps 7 to 16 of the generic test procedure in TS 36.508 subclause 4.5A.5.3 are performed on cell B. NOTE: The Attach procedure for emergency bearer services is completed and a default EPS bearer context for emergency bearer services is activated. Authentication is not performed.	-	-	-	-
15-23	Steps 8 to 10a7 of the generic test procedure in TS 36.508 subclause 4.5.3.3 are performed on cell B. NOTE: Radio bearer establishment procedure is performed to successfully complete the Service Request procedure.	-	-	-	-
23A	Release IMS Call (see Note 2)	-	-	-	-
24	If possible (see ICS) switch off is performed. Otherwise the power is removed.	-	-	-	-
	EXCEPTION: Step 25 describes behaviour that depends on the UE capability.				
25	If pc_SwitchOnOff then the UE transmits a DETACH REQUEST with the Detach Type IE indicating "switch off".	-->	DETACH REQUEST	-	-
26	The SS configures: - cell A as a "Serving cell". - cell B as a "Non-suitable "Off" cell".	-	-	-	-
27	The UE is brought back to operation or the USIM is inserted.	-	-	-	-
28	Check: Does the UE transmit an ATTACH REQUEST on Cell A with EMM parameters not reflecting previous ATTACH on cell B?	-->	ATTACH REQUEST	3	P

Note 1: This could be done by e.g. MMI or AT command.

Note 2: The IMS Call is released using the generic procedure in 36.508 subclause 4.5A.13.

11.2.3.3.3 Specific message contents

Table 11.2.3.3.3-1: Conditions for Table 11.2.3.3.3-2

Condition	Explanation
Cell A	This condition applies to system information transmitted on Cell A.
Cell B	This condition applies to system information transmitted on Cell B.

Table 11.2.3.3.2: SystemInformationBlockType1 for cell A and B (Pre-test conditions and all steps, Table 11.2.3.3.2-1)

Derivation Path: 36.508 clause 4.4.3.2			
Information Element	Value/remark	Comment	Condition
SystemInformationBlockType1 ::= SEQUENCE {			
cellAccessRelatedInfo SEQUENCE {			
csg-Indication	FALSE		Cell A
	TRUE		Cell B
csg-Identity	Not present		Cell A
	'000 0000 0000 0000 0000 0000 0010'B		Cell B
}			
}			

Table 11.2.3.3.3: SystemInformationBlockType4 for cell A and B (Pre-test conditions and all steps, Table 11.2.3.3.2-1)

Derivation Path: 36.508 clause 4.4.3.3, Table 4.4.3.3-3			
Information Element	Value/remark	Comment	Condition
SystemInformationBlockType4 ::= SEQUENCE {			
csg-PhysCellIdRange ::= SEQUENCE {			
Start	2		
Range	Not present	The UE shall apply value 1 in case the field is absent, in which case only the physical cell identity value indicated by start applies.	
}			
}			

Table 11.2.3.3.4: ATTACH REQUEST (Step 4, Table 11.2.3.3.2-1)

Derivation Path: 36.508, Table 4.7.2-4			
Information Element	Value/remark	Comment	Condition
EPS attach type	'0110'B	EPS emergency attach	
NAS key set identifier			
NAS key set identifier	NAS key set identifier allocated to UE during authentication in test preamble		
TSC	'0'B	Native security context	
EPS Mobile Identity	GUTI allocated to UE during previous attach on Cell A.		
Last visited registered TAI	TAI-1		
Old location area identification	Not present		
TMSI status	Not present		

Table 11.2.3.3.5: PDN CONNECTIVITY REQUEST (Step 4, Table 11.2.3.3.2-1)

Derivation Path: 36.508, Table 4.7.3-20			
Information Element	Value/remark	Comment	Condition
Request type	'0100'B	emergency	

Table 11.2.3.3.3-6: ATTACH REQUEST (Step 28, Table 11.2.3.3.2-1)

Derivation Path: 36.508, Table 4.7.2-4			
Information Element	Value/remark	Comment	Condition
NAS key set identifier			
NAS key set identifier	NAS key set identifier allocated to UE during authentication in test preamble		
TSC	'0'B	Native security context	
Old GUTI or IMSI	GUTI allocated to UE during previous attach on Cell A.		
Last visited registered TAI	TAI-1		
Old location area identification	Not present		
TMSI status	Not present		

11.2.4 Emergency bearer services / Normal cell / NO-IMSI / Attach / No EPS security context / PDN connect / Service request / Timer T3412 expires

11.2.4.1 Test Purpose (TP)

(1)

```
with { UE is swithed-on without a valid USIM inserted }
ensure that {
  when { the UE was triggered to originate an emergency bearer service }
  then { the UE establishes the RRC connection with the RRC establishmentCause set to " emergency
calls " }
}
```

(2)

```
with { UE is swithed-on without a valid USIM inserted, and has originated an emergency bearer
service }
ensure that {
  when { the UE receives an RRCConnectionSetup message }
  then { the UE sends an ATTACH REQUEST message with the EPS attach type set to " EPS emergency
attach " }
}
```

(3)

```
with { UE has sent an ATTACH REQUEST message for emergency bearer service }
ensure that {
  when { The UE receives an ATTACH ACCEPT message }
  then { The UE sends an ATTACH COMPLETE message }
}
```

(4)

void

(5)

```
with { UE has completed Emergency service and enters EMM-IDLE MODE}
ensure that {
  when { the periodic tracking area updating timer T3412 expires }
  then { UE does not send an TRACKING AREA UPDATE REQUEST message }
}
```

11.2.4.2 Conformance requirements

References: The conformance requirements covered in the current TC are specified in: TS 24.301, clauses 5.2.2.3.5, 5.3.1.1, 5.3.5, 5.4.2.1, 5.5.1.2.1, 5.5.1.2.2, 5.5.1.2.3, 6.4.1.3 and Annex D.

[TS 24.301, clause 5.2.2.3.5]

The UE shall perform cell selection according to 3GPP TS 36.304 [21].

The UE may initiate attach for emergency bearer services.

[TS 24.301, clause 5.3.1.1]

When the UE is in EMM-IDLE mode and needs to transmit an initial NAS message, the UE shall request the lower layer to establish a RRC connection. In this request to the lower layer the NAS shall provide to the lower layer the RRC establishment cause and the call type as specified in annex D of this specification.

...

For the routing of the initial NAS message to the appropriate MME, the UE NAS provides the lower layers with either the S-TMSI or the registered globally unique MME identifier (GUMMEI) that consists of the PLMN ID, the MME group ID, and the MME code (see 3GPP TS 23.003 [2]) according to the following rules:

- When the UE is registered in the tracking area of the current cell during the NAS signalling connection establishment, the UE NAS shall provide the lower layers with the S-TMSI, but shall not provide the registered MME identifier to the lower layers. Exceptionally, when the UE in EMM-IDLE mode initiates a tracking area updating or combined tracking area updating procedure for load balancing purposes, the UE NAS shall provide the lower layers with neither S-TMSI nor registered MME identifier.
- When the UE is not registered in the tracking area of the current cell during the NAS signalling connection establishment, the UE NAS does not provide the lower layers with the S-TMSI. Instead,
 - a) if the TIN indicates "GUTI" or "RAT-related TMSI", or the TIN is not available, and the UE holds a valid GUTI, the UE NAS shall provide the lower layers with the MME identifier part of the valid GUTI; or
 - b) if the TIN indicates "P-TMSI" and the UE holds a valid P-TMSI and RAI, the UE NAS shall provide the lower layers with the MME identifier part of the mapped GUTI, which is generated from the P-TMSI and RAI.

[TS24.301 clause5.3.5]

Periodic tracking area updating is used to periodically notify the availability of the UE to the network. The procedure is controlled in the UE by the periodic tracking area update timer (timer T3412). The value of timer T3412 is sent by the network to the UE in the ATTACH ACCEPT message and can be sent in the TRACKING AREA UPDATE ACCEPT message. The UE shall apply this value in all tracking areas of the list of tracking areas assigned to the UE, until a new value is received.

The timer T3412 is reset and started with its initial value, when the UE goes from EMM-CONNECTED to EMM-IDLE mode. The timer T3412 is stopped when the UE enters EMM-CONNECTED mode or EMM-DEREGISTERED state.

If the UE is attached for emergency bearer services, and timer T3412 expires, the UE shall not initiate a periodic tracking area updating procedure, but shall locally detach from the network.

When a UE is not attached for emergency bearer services, and timer T3412 expires, the periodic tracking area updating procedure shall be started and the timer shall be set to its initial value for the next start.

...

If the UE is not attached for emergency bearer services, the mobile reachable timer shall be longer than T3412. In this case, by default, the mobile reachable timer is 4 minutes greater than T3412. If ISR is not activated, the network behaviour upon expiry of the mobile reachable timer is network dependent, but typically the network stops sending paging messages to the UE on the first expiry, and may take other appropriate actions.

If the UE is attached for emergency bearer services, the MME shall set the mobile reachable timer with a value equal to T3412. When the mobile reachable timer expires, the MME shall locally detach the UE.

....

[TS 24.301, clause 5.4.2.1]

The purpose of the EPS authentication and key agreement (AKA) procedure is to provide mutual authentication between the user and the network and to agree on a key K_{ASME} (see 3GPP TS 33.401 [19]). The cases when the EPS AKA procedure should be used are defined in 3GPP TS 33.401 [19].

The EPS AKA procedure is always initiated and controlled by the network. However, the UE can reject the EPS authentication challenge sent by the network.

The UE shall proceed with an EPS authentication challenge only if a USIM is present.

...

[TS 24.301, clause 5.5.1.1]

The attach procedure is used to attach to an EPC for packet services in EPS.x

The attach procedure is used for three purposes:

- by a UE in PS mode of operation to attach for EPS services only;
- by a UE in CS/PS mode 1 or CS/PS mode 2 of operation to attach for both EPS and non-EPS services; or
- to attach for emergency bearer services.

If the MME does not support an attach for emergency bearer services, the MME shall reject any request to attach with an attach type set to "EPS emergency attach".

With a successful attach procedure, a context is established for the UE in the MME, and a default bearer is established between the UE and the PDN GW, thus enabling always-on IP connectivity to the UE. The network may also initiate the activation of dedicated bearers as part of the attach procedure.

...

[TS 24.301, clause 5.5.1.2.1]

When the UE initiates the attach procedure for emergency bearer services, the UE shall indicate "EPS emergency attach" in the EPS attach type IE.

[TS 24.301, clause 5.5.1.2.2]

In state EMM-DEREGISTERED, the UE initiates the attach procedure by sending an ATTACH REQUEST message to the MME, starting timer T3410 and entering state EMM-REGISTERED-INITIATED (see example in figure 5.5.1.2.2.1). If timer T3402 is currently running, the UE shall stop timer T3402. If timer T3411 is currently running, the UE shall stop timer T3411.

If the UE supports neither A/Gb mode nor Iu mode, the UE shall handle the Old GUTI or IMSI IE in the ATTACH REQUEST message as follows:

- The UE shall include in the ATTACH REQUEST message a valid GUTI together with the last visited registered TAI, if available. If there is no valid GUTI available, the UE shall include the IMSI in the ATTACH REQUEST message.

If the UE is attaching for emergency bearer services and does not hold a valid GUTI, P-TMSI or IMSI as described above, the IMEI shall be included in the EPS mobile identity IE.

...

The UE shall send the ATTACH REQUEST message together with a PDN CONNECTIVITY REQUEST message contained in the ESM message container information element to request PDN connectivity.

...

If a valid NAS security context exists, the UE shall integrity protect the ATTACH REQUEST message combined with the PDN CONNECTIVITY REQUEST message. When the UE does not have a valid NAS security context, the ATTACH REQUEST message combined with the PDN CONNECTIVITY REQUEST message is not integrity protected.

...

[TS 24.301, clause 5.5.1.2.3]

During an attach for emergency bearer services, the MME may choose to skip the authentication procedure even if no EPS security context is available and proceed directly to the execution of the security mode control procedure as specified in subclause 5.4.3.

...

[TS 24.301, clause 6.4.1.3]

Upon receipt of the ACTIVATE DEFAULT EPS BEARER CONTEXT REQUEST message, the UE shall send an ACTIVATE DEFAULT EPS BEARER CONTEXT ACCEPT message and enter the state BEARER CONTEXT ACTIVE. When the default bearer is activated as part of the attach procedure, the UE shall send the ACTIVATE DEFAULT EPS BEARER CONTEXT ACCEPT message together with ATTACH COMPLETE message. When the default bearer is activated as the response to the stand-alone PDN CONNECTIVITY REQUEST message, the UE shall send the ACTIVATE DEFAULT EPS BEARER CONTEXT ACCEPT message alone.

The UE checks the PTI in the ACTIVATE DEFAULT EPS BEARER CONTEXT REQUEST message to identify the UE requested PDN connectivity procedure to which the default bearer context activation is related (see subclause 6.5.1).

...

[TS 24.301, Annex D]

Table D.1.1: Mapping of NAS procedure to establishment cause and call type

NAS procedure	RRC establishment cause (according 3GPP TS 36.331 [22])	Call type
Attach	If an ATTACH REQUEST has EPS attach type not set to "EPS emergency attach", the RRC establishment cause shall be set to MO signalling. (See Note 1)	"originating signalling"
	If an ATTACH REQUEST has EPS attach type set to "EPS emergency attach", the RRC establishment cause shall be set to Emergency call. (See Note 1)	"emergency calls"
Note 1: For these NAS procedures initiated by UEs of access class 12, 13 or 14 in their home country, the RRC establishment cause will be set to "High priority access AC 11 – 15". For this purpose the home country is defined as the country of the MCC part of the IMSI, see 3GPP TS 22.011 [1A]. For these NAS procedures initiated by UE of access class 11 or 15 in their HPLMN (if the EHPLMN list is not present or is empty) or EHPLMN (if the EHPLMN list is present), the RRC establishment cause will be set to "High priority access AC 11 – 15".		

11.2.4.3 Test description

11.2.4.3.1 Pre-test conditions

System Simulator:

- Cell A is configured according to Table 6.3.2.2-1 in [18].

UE:

- Without a valid USIM inserted

Preamble:

- The UE is in state Switched OFF (state 1) according to [18].

11.2.4.3.2 Test procedure sequence

Table: 11.2.4.3.2-1: Main behaviour

St	Procedure	Message Sequence		TP	Verdict
		U – S	Message		
1	The UE is switched on without a valid USIM inserted.	-	-	-	-
2	Causes the UE originate an emergency bearer service (Note1).	-	-	-	-
3	Check: Does the UE transmit an <i>RRConnectionRequest</i> message with <i>establishmentCause</i> set to 'Emergency call'?	-	-	1	P
4	The SS transmits an <i>RRConnectionSetup</i> message.	-	-	-	-
5	Check: Does the UE transmit an ATTACH REQUEST message to attach for emergency bearer services, together with a PDN CONNECTIVITY REQUEST message for emergency bearer services?	-->	ATTACH REQUEST PDN CONNECTIVITY REQUEST	2	P
6-16	Steps 5 to 15 of the generic test procedure for IMS Emergency call establishment in EUTRA: Limited Service (TS 36.508 subclause 4.5A.5.3-1).	-	-	-	-
17	Check: Does the UE transmit an ATTACH COMPLETE message , and the The ACTIVATE DEFAULT EPS BEARER CONTEXT ACCEPT message is piggybacked in ATTACH COMPLETE?	-->	ATTACH COMPLETE ACTIVATE DEFAULT EPS BEARER CONTEXT ACCEPT	3	P
18-20	Steps17 to 19 of the generic test procedure for IMS Emergency call establishment in EUTRA: Limited Service (TS 36.508 subclause 4.5A.5.3-1).	-	-	-	-
20 A	Release IMS Call (see Note 2)	-	-	-	-
21	The SS releases the RRC connection.	-	-	-	-
22	The SS waits 6minutes. (Expiry of T3412)	-	-	-	-
23	Check: Does the UE send TRACKING AREA UPDATE REQUEST message?	-->	TRACKNG AREA UPDATE REQUEST	5	F

Note 1: The request to originate a emergency service may be performed by MMI or AT command.
 Note 2: The IMS Call is released using the generic procedure in 36.508 subclause 4.5A.13.

11.2.4.3.3 Specific message contents

Table 11.2.4.3.3-1: Message *RRConnectionRequest* (step 3, Table 11.2.4.3.2-1)

Derivation path: 36.508 table 4.6.1-16			
Information Element	Value/Remark	Comment	Condition
<i>RRConnectionRequest</i> ::= SEQUENCE {			
<i>criticalExtensions</i> CHOICE {			
<i>rrcConnectionRequest-r8</i> SEQUENCE {			
<i>ue-Identity</i> CHOICE {			
<i>randomValue</i>	Not checked		
}			
<i>establishmentCause</i>	Emergency call		
}			
}			

Table 11.2.4.3.3-2: Message ATTACH REQUEST (step 5, Table 11.2.4.3.2-1)

Derivation path: TS 36.508 table 4.7.2-4			
Information Element	Value/Remark	Comment	Condition
EPS attach type	'0110'B	EPS emergency attach	
EPS mobile identity	IMEI		

Table 11.2.4.3.3-3: Message ATTACH ACCEPT (step 14, 36.508 table 4.5A.5.3-11)

Derivation path: 36.508 table 4.7.2-1			
Information Element	Value/Remark	Comment	Condition
T3412 value			
Unit	'010'	"value is incremented in multiples of decihours"	
Timer value	'00001'	"6 minutes"	
EPS attach result	'0110'B	EPS emergency attach	

11.2.5 Emergency bearer services / Normal cell / NORMAL-SERVICE / Local Emergency Numbers List NOT sent in the Attach / PDN connect new emergency EPS bearer context / Authentication SQN code failure - MME aborts authentication continues using current security context / Service request

11.2.5.1 Test Purpose (TP)

(1)

```
with { UE is in state Registered, Idle mode }
ensure that {
  when { the UE is triggered to originate an emergency bearer service }
  then { the UE sends a SERVICE REQUEST message }
}
```

(2)

```
with { UE in EMM-REGISTERED state and EMM-IDLE mode }
ensure that {
  when { UE originates an emergency bearer service }
  then { the UE sends a PDN connectivity request message without an APN }
}
```

(3)

```
with { UE having sent an AUTHENTICATION FAILURE message to the network, with EMM cause "synch failure" }
ensure that {
  when { UE receives a SECURITY MODE COMMAND message }
  then { the UE sends a SECURITY MODE COMPLETE message }
}
```

(4)

```
with { UE has sent a PDN CONNECTIVITY REQUEST message }
ensure that {
  when { UE receives an RRCConnectionReconfiguration message including an ACTIVATE DEFAULT EPS BEARER CONTEXT REQUEST message with IE Procedure transaction identity matching the PDN CONNECTIVITY REQUEST message and an ACTIVATE DEDICATED EPS BEARER CONTEXT REQUEST message linked to the EPS bearer context activated in the first message }
  then { UE transmits an ACTIVATE DEFAULT EPS BEARER CONTEXT ACCEPT message and an ACTIVATE DEDICATED EPS BEARER CONTEXT ACCEPT message both containing the EPS bearer identity and enters EMM-REGISTERED state }
}
```

11.2.5.2 Conformance requirements

References: The conformance requirements covered in the current TC are specified in: TS 24.301, clauses 5.4.2.7, and 6.5.1.2.

[TS 24.301, clause 5.4.2.7]

...

For items c, d, and e:

Depending on local requirements or operator preference for emergency bearer services, if the UE has a PDN connection for emergency bearer services established or is establishing a PDN connection for emergency bearer services, the MME need not follow the procedures specified for the authentication failure specified in the present subclause. The MME may respond to the AUTHENTICATION FAILURE message by initiating the security mode control procedure selecting the "null integrity protection algorithm" EIA0, null ciphering algorithm or may abort the authentication procedure and continue using the current security context, if any. The MME shall deactivate all non-emergency EPS bearer contexts, if any, by initiating an EPS bearer context deactivation procedure. The network shall consider the UE to be attached for emergency bearer services only.

If a UE has a PDN connection for emergency bearer services established or is establishing a PDN connection for emergency bearer services and sends an AUTHENTICATION FAILURE message to the MME with the EMM cause appropriate for these cases (#20, #21, or #26, respectively) and receives the SECURITY MODE COMMAND message before the timeout of timer T3418 or T3420, the UE shall deem that the network has passed the authentication check successfully, stop timer T3418 or T3420, respectively, and execute the security mode control procedure.

If a UE has a PDN connection for emergency bearer services established when timer T3418 or T3420 expires, the UE shall not deem that the network has failed the authentication check and not behave as described in item f. Instead the UE shall continue using the current security context, if any, deactivate all non-emergency EPS bearer contexts, if any, by initiating UE requested PDN disconnect procedure and consider itself to be attached for emergency bearer services only.

[TS 24.301, clause 6.5.1.2]

When the PDN CONNECTIVITY REQUEST message is sent together with an ATTACH REQUEST message, the UE shall not include the APN.

NOTE 1: If the UE needs to provide protocol configuration options which require ciphering or provide an APN, or both, during the attach procedure, the ESM information transfer flag is included in the PDN CONNECTIVITY REQUEST. The MME then at a later stage in the PDN connectivity procedure initiates the ESM information request procedure in which the UE can provide the MME with protocol configuration options or APN or both.

In order to request connectivity to a PDN using the default APN, the UE includes the Access point name IE in the PDN CONNECTIVITY REQUEST message or, when applicable, in the ESM INFORMATION RESPONSE message, according to the following conditions:

- if use of a PDN using the default APN requires PAP/CHAP, then the UE should include the Access point name IE; and
- in all other conditions, the UE need not include the Access point name IE.

In order to request connectivity to an additional PDN, the UE shall send a PDN CONNECTIVITY REQUEST message to the MME, start timer T3482 and enter the state PROCEDURE TRANSACTION PENDING (see example in figure 6.5.1.2.1). If the additional PDN connection is for emergency bearer services, the UE shall not include an APN in the PDN CONNECTIVITY REQUEST message; otherwise the UE shall include the requested APN.

In the PDN type information element the UE shall indicate the IP version capability of the IP stack associated with the UE as specified in subclause 6.4.1.

The UE shall set the request type to "initial request" when the UE is establishing a new PDN connectivity to a PDN in an attach procedure or in a stand-alone PDN connectivity procedure. The UE shall set the request type to "emergency" when the UE is requesting PDN connectivity for emergency bearer services for the first time. The UE shall set the

request type to "handover" when the connectivity to a PDN is established upon handover from a non-3GPP access network and the UE was connected to that PDN before the handover to the 3GPP access network.

NOTE 2: For emergency bearer services, the handover from non-3GPP access to E-UTRA is not supported.

If the UE supports DSMIPv6, the UE may include a request for obtaining the IPv6 address and optionally the IPv4 address of the home agent in the Protocol configuration options IE in the PDN CONNECTIVITY REQUEST message. The UE may also include a request for obtaining the IPv6 Home Network Prefix. The UE shall request the IPv6 Home Network Prefix only if the UE has requested the home agent IPv6 address. The requested home agent address(es) and the Home Network Prefix are related to the APN the UE requested connectivity for.

The UE may set the ESM information transfer flag in the PDN CONNECTIVITY REQUEST message to indicate that it has ESM information, i.e. protocol configuration options, APN, or both, that needs to be sent after the NAS signalling security has been activated between the UE and the MME.

If the UE supports A/Gb mode or Iu mode, the UE shall indicate the support of the network requested bearer control procedures (see 3GPP TS 24.008 [13]) in A/Gb mode or Iu mode in the Protocol configuration options IE.

Protocol configuration options provided in the ESM INFORMATION RESPONSE message replace any protocol configuration options provided in the PDN CONNECTIVITY REQUEST message.

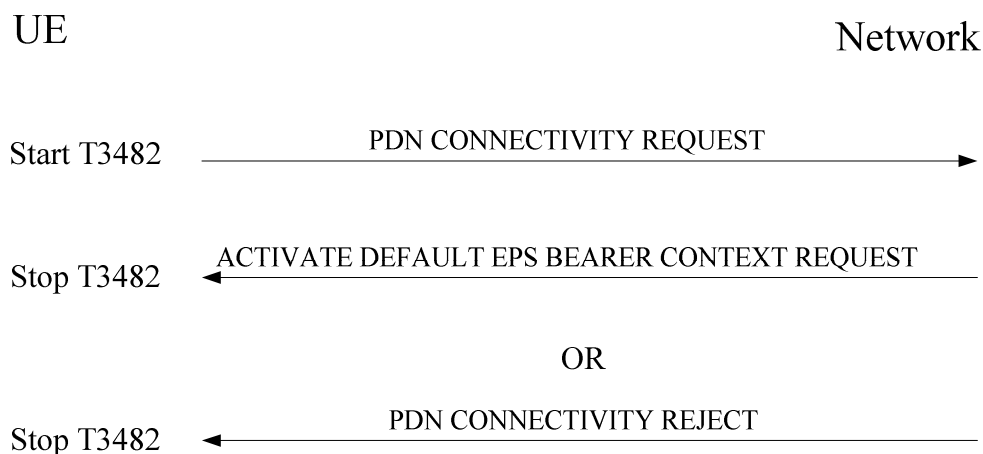

Figure 6.5.1.2.1: UE requested PDN connectivity procedure

11.2.5.3 Test description

11.2.5.3.1 Pre-test conditions

System Simulator:

- Cell A (PLMN1) is configured according to Table 6.3.2.2-1 in [18].

UE:

- None.

Preamble:

- The UE is in state Registered, Idle mode (state 2) according to [18] on Cell A.

11.2.5.3.2 Test procedure sequence

Table 11.2.5.3.2-1: Main behaviour

St	Procedure	Message Sequence		TP	Verdict
		U – S	Message		
1-3	Steps 1 to 3 of the generic test procedure for IMS Emergency call establishment in EUTRA: Normal Service (TS 36.508 subclause 4.5A.4.3-1).	-	-	-	-
4	Check: Does the UE transmit an <i>RRCConnectionSetupComplete</i> message to confirm the successful completion of the connection establishment and to initiate the session management procedure by including the SERVICE REQUEST message.	-->	SERVICE REQUEST	1	P
5	The SS transmits an AUTHENTICATION REQUEST message to initiate the EPS authentication and AKA procedure.	<--	AUTHENTICATION REQUEST	-	-
6	The UE transmits an AUTHENTICATION FAILURE message with EMM cause #21 "synch failure".	-->	AUTHENTICATION FAILURE	-	-
7	The SS transmits a NAS SECURITY MODE COMMAND message to activate NAS security using parameters from AKA performed in preamble.	<--	SECURITY MODE COMMAND	-	-
8	Check: Does UE transmit a NAS SECURITY MODE COMPLETE message and establish the initial security configuration.	-->	SECURITY MODE COMPLETE	3	P-
9-12	Steps 5 to 8 of the generic test procedure for IMS Emergency call establishment in EUTRA: Normal Service (TS 36.508 subclause 4.5A.4.3-1).	-	-	-	-
13	Check: Does the UE transmit a PDN CONNECTIVITY REQUEST message as specified to request an emergency PDN?	-->	PDN CONNECTIVITY REQUEST	2	P
14-18	Steps 10 to 14 of the generic test procedure for IMS Emergency call establishment in EUTRA: Normal Service (TS 36.508 4.5A.4.3-1).	-	-	-	-
19	Check: Does the UE transmit an ACTIVATE DEDICATED EPS BEARER CONTEXT ACCEPT message for the additional dedicated EPS Bearer?	-->	ACTIVATE DEDICATED EPS BEARER CONTEXT ACCEPT	4	P
20	Release IMS Call (see Note 1)	-	-	-	-
21	The SS releases the RRC connection.	-	-	-	-

Note 1: The IMS Call is released using the generic procedure in 36.508 subclause 4.5A.13.

Table 11.2.5.3.2-2: Void

11.2.5.3.3 Specific message contents

Table 11.2.5.3.3-1: Message RRCConnectionReconfiguration (step 1, Table 11.2.5.3.3-2 and step 12, Table 11.2.5.3.3-1)

Derivation path: 36.508 table 4.6.1-8 using condition DRB-REL(2)

Table 11.2.5.3.3-2: Message DEACTIVATE EPS BEARER CONTEXT REQUEST (step 1, Table 11.2.5.3.3-2)

Derivation Path: TS 36.508 Table 4.7.3-12			
Information Element	Value/remark	Comment	Condition
EPS bearer identity	5	The EPS bearer context setup during the attach.	
Procedure transaction identity	'0000 0000'B	No procedure transaction identity assigned	
ESM cause	#36	regular deactivation	

Table 11.2.5.3.3-3: Message DEACTIVATE EPS BEARER CONTEXT ACCEPT (step 2, Table 11.2.5.3.3-2)

Derivation Path: TS 36.508 Table 4.7.3-11			
Information Element	Value/remark	Comment	Condition
EPS bearer identity	5	The same value as the value set in DEACTIVATE EPS BEARER CONTEXT REQUEST message.	
Procedure transaction identity	0	No procedure transaction identity assigned	

Table 11.2.5.3.3-4: Message AUTHENTICATION REQUEST (step 5, Table 11.2.5.3.2-1)

Derivation Path: 36.508 Table 4.7.2-7			
Information Element	Value/remark	Comment	Condition
Authentication parameter AUTN (EPS challenge)	The SQN is out of correct range ($SEQ - SEQ_{MS} > \Delta$).		

Table 11.2.5.3.3-5: Message PDN CONNECTIVITY REQUEST (step 13, Table 11.2.5.3.2-1)

Derivation Path: 36.508 table 4.7.3-20			
Information Element	Value/remark	Comment	Condition
ESM information transfer flag	Not present		
Request type	'0100'B	emergency	
Access point name	Not present		

11.2.6 Handling of Local Emergency Numbers List provided during Attach and Normal tracking area update procedures

11.2.6.1 Test Purpose (TP)

(1)

```

with { UE in state EMM-REGISTERED and EMM-IDLE mode, Emergency numbers stored in the USIM and a
Local Emergency Numbers List provided during the Attach procedure }
ensure that {
  when { UE is requested to initiate a call with a number belonging to the emergency numbers stored
in the USIM }
  then { UE initiates an emergency call }
}

```

(2)

```

with { UE in state EMM-REGISTERED and EMM-IDLE mode, Emergency numbers stored in the USIM and a
Local Emergency Numbers List provided during the Attach procedure }
ensure that {
  when { UE performs a tracking area update to a new tracking area not included in the TAI list and
belonging to a network with the same MCC and the TRACKING AREA UPDATE ACCEPT message sent by the
network includes a Local Emergency Numbers List with 10 new numbers }
  then { UE overwrites the old list with the new one and recognises each of the new numbers as an
emergency number }
}

```

(3)

```

with { UE in state EMM-REGISTERED and EMM-IDLE mode, Emergency numbers stored in the USIM and a
Local Emergency Numbers List provided during a tracking area update }
ensure that {
  when { UE performs a tracking area update to a new tracking area not included in the TAI list and
not belonging to a network with the same MCC }
  then { UE considers the old Local Emergency Numbers List as invalid and recognises the numbers
stored in the USIM as emergency numbers }
}

```

(4)

```

with { UE in state EMM-REGISTERED and EMM-IDLE mode, Emergency numbers stored in the USIM and a
Local Emergency Numbers List provided during the Attach procedure }
ensure that {
  when { UE is requested to initiate a call with a number belonging to the Local Emergency Numbers
List }
  then { UE initiates an emergency call }
}

```

11.2.6.2 Conformance requirements

References: The conformance requirements covered in the present TC are specified in: 3GPP TS 24.301 clause 5.3.7, TS 22.101 clause 10.1.1.

[TS 24.301 clause 5.3.7]

The Local Emergency Numbers List contains additional emergency numbers used by the serving network. The list can be downloaded by the network to the UE at successful registration and subsequent registration updates. There is only one Local Emergency Numbers List in the UE, and it can be updated with EMM procedures if the UE is in S1 mode and with GMM and MM procedures if the UE is in A/Gb or Iu mode.

The UE shall use the stored Local Emergency Numbers List received from the network in addition to the emergency numbers stored on the USIM or user equipment to detect that the number dialled is an emergency number.

NOTE: The user equipment may use the emergency numbers list to assist the end user in determining whether the dialled number is intended for an emergency service or for another destination, e.g. a local directory service. The possible interactions with the end user are implementation specific.

The network may send a Local Emergency Numbers List in the ATTACH ACCEPT or in the TRACKING AREA UPDATE ACCEPT messages, by including the Emergency Number List IE. The user equipment shall store the Local Emergency Numbers List, as provided by the network, except that any emergency number that is already stored in the USIM shall be removed from the Local Emergency Numbers List before it is stored by the user equipment. If there are no emergency numbers stored on the USIM, then before storing the received Local Emergency Numbers List, the user equipment shall remove from the Local Emergency Numbers List any emergency number stored permanently in the user equipment for use in this case (see 3GPP TS 22.101 [8]). The Local Emergency Numbers List stored in the user equipment shall be replaced on each receipt of a new Emergency Number List IE.

The emergency number(s) received in the Emergency Number List IE are valid only in networks with the same MCC as in the cell on which this IE is received. If no Local Emergency Numbers List is contained in the ATTACH ACCEPT or in the TRACKING AREA UPDATE ACCEPT message, then the stored Local Emergency Numbers List in the user equipment shall be kept, except if the user equipment has successfully registered to a PLMN with an MCC different from that of the last registered PLMN.

The Local Emergency Numbers List shall be deleted at switch off and removal of the USIM. The user equipment shall be able to store up to ten local emergency numbers received from the network.

[TS 22.101 clause 10.1.1]

The ME shall identify an emergency number dialled by the end user as a valid emergency number and initiate emergency call establishment if it occurs under one or more of the following conditions. If it occurs outside of the following conditions, the ME should not initiate emergency call establishment but normal call establishment. Emergency number identification takes place before and takes precedence over any other (e.g. supplementary service related) number analysis.

- a) 112 and 911 shall always be available. These numbers shall be stored on the ME.
- b) Any emergency call number stored on a SIM/USIM when the SIM/USIM is present.
- c) 000, 08, 110, 999, 118 and 119 when a SIM/USIM is not present. These numbers shall be stored on the ME.
- d) Additional emergency call numbers that may have been downloaded by the serving network when the SIM/USIM is present.

11.2.6.3 Test description

11.2.6.3.1 Pre-test conditions

System Simulator:

- Cell A is set to "Serving cell";
- Cell C is set to "Non- Suitable cell";
- Cell E is set to "Non- Suitable cell".
- System information combination 3 as defined in TS 36.508[18] clause 4.4.3.1 is used in E-UTRA cells

UE:

- USIM contains 2 Emergency Numbers (see TS 22.101 clause 10.1.1).

Preamble:

- the UE is in state Registered, Idle Mode (state 2) on Cell A according to TS 36.508 [18].
- During the attach the ATTACH ACCEPT message provides Local Emergency Numbers List. The local emergency number list is different from all emergency numbers stored in the UE.

11.2.6.3.2 Test procedure sequence

Table 11.2.6.3.2-1: Main behaviour

St	Procedure	Message Sequence		TP	Verdict
		U - S	Message		
-	The following messages are sent and shall be received on Cell A.	-	-	-	-
1	Cause the UE to start a "call" using one of the Emergency Numbers stored on the USIM.	-	-	-	-
2	Check: Does UE transmit an <i>RRCCoNNECTIONRequest</i> message with <i>establishmentCause</i> set to 'emergency'?	-->	RRC: <i>RRCCoNNECTIONRequest</i>	1	P
3	SS transmit an <i>RRCCoNNECTIONSetup</i> message.	<--	RRC: <i>RRCCoNNECTIONSetup</i>	-	-
4	The UE transmits an <i>RRCCoNNECTIONSetupComplete</i> message to confirm the successful completion of the connection establishment and to initiate the session management procedure by including the SERVICE REQUEST message.	->	RRC: <i>RRCCoNNECTIONSetupComplete</i> NAS: SERVICE REQUEST	-	-
5	The SS transmits SERVICE REJECT.	<--	SERVICE REJECT	-	-
6	The SS releases the RRC connection.	-	-	-	-
7	Cause the UE to start a "call" using one of the Emergency Numbers received in the ATTACH ACCEPT message IE Local Emergency Numbers List sent in the preamble. (Note 1)	-	-	-	-
8	Check: Does UE transmit an <i>RRCCoNNECTIONRequest</i> message with <i>establishmentCause</i> set to 'emergency'?	-->	RRC: <i>RRCCoNNECTIONRequest</i>	4	P
9	SS transmit an <i>RRCCoNNECTIONSetup</i> message.	<--	RRC: <i>RRCCoNNECTIONSetup</i>	-	-
10	The UE transmits an <i>RRCCoNNECTIONSetupComplete</i> message to confirm the successful completion of the connection establishment and to initiate the session management procedure by including the SERVICE REQUEST message.	->	RRC: <i>RRCCoNNECTIONSetupComplete</i> NAS: SERVICE REQUEST	-	-
11	The SS transmits SERVICE REJECT.	<--	SERVICE REJECT	-	-
12	The SS releases the RRC connection.	-	-	-	-
13	The SS configures: - Cell A as the "Non-Suitable cell". - Cell C as a "Serving cell".	-	-	-	-
-	The following messages are sent and shall be received on Cell C.	-	-	-	-
14	The UE transmit a TRACKING AREA UPDATE REQUEST message.	-->	TRACKING AREA UPDATE REQUEST	-	-
15	The SS transmits a TRACKING AREA UPDATE ACCEPT message including IE Local Emergency Numbers List with 10 numbers different to the numbers stored on the USIM and those provided in the ATTACH ACCEPT in the preamble.	<--	TRACKING AREA UPDATE ACCEPT	-	-
16	The UE transmit a TRACKING AREA UPDATE COMPLETE message.	-->	TRACKING AREA UPDATE COMPLETE	-	-
17	The SS releases the RRC connection.	-	-	-	-
18	Cause the UE to start a "call" using one of the Emergency Numbers which the SS sent in the ATTACH ACCEPT message IE Local Emergency Numbers List in the preamble. The UE is expected to have them deleted(Note 1)	-	-	-	-
19	Check: Does UE transmit an <i>RRCCoNNECTIONRequest</i> message with <i>establishmentCause</i> set to 'mo-Data'?	-->	RRC: <i>RRCCoNNECTIONRequest</i>	2	P
20	SS transmit an <i>RRCCoNNECTIONSetup</i> message.	<--	RRC: <i>RRCCoNNECTIONSetup</i>	-	-

21	The UE transmits an <i>RRCCONNECTIONSETUPCOMPLETE</i> message to confirm the successful completion of the connection establishment and to initiate the session management procedure by including the SERVICE REQUEST message.	->	RRC: <i>RRCCONNECTIONSETUPCOMPLETE</i> NAS: SERVICE REQUEST	-	-
22	The SS transmits SERVICE REJECT	<--	SERVICE REJECT	-	-
23	The SS releases the RRC connection.	-	-	-	-
-	EXCEPTION: Steps 24 to 29 are repeated 10 times - each time with a different call number from one of the Emergency Numbers provided in the TRACKING AREA UPDATE ACCEPT message in step 15.	-	-	-	-
24	Cause the UE to start a "call" using one of the Emergency Numbers received in the TRACKING AREA UPDATE ACCEPT message in step 15. (Note 1)	-	-	-	-
25	Check: Does UE transmit an <i>RRCCONNECTIONREQUEST</i> message with <i>establishmentCause</i> set to 'emergency'?	-->	<i>RRCCONNECTIONREQUEST</i>	2	P
26	SS transmit an <i>RRCCONNECTIONSETUP</i> message.	<--	RRC: <i>RRCCONNECTIONSETUP</i>	-	-
27	The UE transmits an <i>RRCCONNECTIONSETUPCOMPLETE</i> message to confirm the successful completion of the connection establishment and to initiate the session management procedure by including the SERVICE REQUEST message.	->	RRC: <i>RRCCONNECTIONSETUPCOMPLETE</i> NAS: SERVICE REQUEST	-	-
28	The SS transmits SERVICE REJECT.	<--	SERVICE REJECT	-	-
29	The SS releases the RRC connection.	-	-	-	-
30	The SS configures: - Cell C as the "Non-Suitable cell". - Cell E as a "Serving cell".	-	-	-	-
-	The following messages are sent and shall be received on Cell E.	-	-	-	-
31	The UE transmit a TRACKING AREA UPDATE REQUEST message.	-->	TRACKING AREA UPDATE REQUEST	-	-
32	The SS transmits a TRACKING AREA UPDATE ACCEPT message which does not include IE Local Emergency Numbers List.	<--	TRACKING AREA UPDATE ACCEPT	-	-
33	The UE transmit a TRACKING AREA UPDATE COMPLETE message.	-->	TRACKING AREA UPDATE COMPLETE	-	-
34	The SS releases the RRC connection.	-	-	-	-
35	Cause the UE to start a "call" using one of the Emergency Numbers provided by the SS in the TRACKING AREA UPDATE ACCEPT message in step 15. (Note 1)	-	-	-	-
36	Check: Does UE transmit an <i>RRCCONNECTIONREQUEST</i> message with <i>establishmentCause</i> set to 'mo-Data'?	-->	RRC: <i>RRCCONNECTIONREQUEST</i>	3	P
37	SS transmit an <i>RRCCONNECTIONSETUP</i> message.	<--	RRC: <i>RRCCONNECTIONSETUP</i>	-	-
38	The UE transmits an <i>RRCCONNECTIONSETUPCOMPLETE</i> message to confirm the successful completion of the connection establishment and to initiate the session management procedure by including the SERVICE REQUEST message.	->	RRC: <i>RRCCONNECTIONSETUPCOMPLETE</i> NAS: SERVICE REQUEST	-	-
39	The SS transmits SERVICE REJECT	<--	SERVICE REJECT	-	-
40	The SS releases the RRC connection.	-	-	-	-
41	Cause the UE to start a "call" using one of the Emergency Numbers stored on the USIM.	-	-	-	-
42	Check: Does UE transmit an <i>RRCCONNECTIONREQUEST</i> message with <i>establishmentCause</i> set to 'emergency'?	-->	RRC: <i>RRCCONNECTIONREQUEST</i>	3	P

43-56	Steps 2-15 from the Generic Test Procedure for IMS Emergency call establishment in E-UTRA: Normal Service as described in 36.508 Table 4.5A.4.3-1 take place.	-	-	-	-
57	Release IMS Call (see Note 2)	-	-	-	-
58	The SS releases the RRC connection.	-	-	-	-
-	At the end of this test procedure sequence, the UE is in end state E-UTRA idle (E1) according to TS 36.508.	-	-	-	-
Note 1: This could be done by e.g. MMI or by AT command.					
Note 2: The IMS Call is released using the generic procedure in 36.508 subclause 4.5A.13.					

11.2.6.3.3 Specific message contents

Table 11.2.6.3.3-1: Message ATTACH ACCEPT (in the preamble)

Derivation path: 36.508 table 4.7.2-1			
Information Element	Value/Remark	Comment	Condition
Emergency number list	2 numbers TS 24.008, 10.5.3.13	The numbers shall be different than any of those indicated in TS 22.101 clause 10.1.1 AND the numbers stored in the USIM AND any emergency number stored permanently in the ME	
EPS network feature support	'0000 0111'B	- IMS voice over PS session in S1 mode supported - emergency bearer services in S1 mode supported - location services via EPC supported - no information about support of location services via CS domain is available	

Table 11.2.6.3.3-2: Message RRCConnectionRequest (steps 2, 8, 25, 42 Table 11.2.6.3.2-1)

Derivation path: 36.508 table 4.6.1-16			
Information Element	Value/Remark	Comment	Condition
RRCConnectionRequest ::= SEQUENCE {			
criticalExtensions CHOICE {			
rrcConnectionRequest-r8 SEQUENCE {			
establishmentCause	emergency		
}			
}			
}			

Table 11.2.6.3.3-3: Message SERVICE REJECT (steps 5, 11, 22, 28, 39, Table 11.2.6.3.2-1)

Derivation Path: 36.508 table 4.7.2-22			
Information Element	Value/remark	Comment	Condition
EMM cause	'0001 0110'B	#22 Congestion	

Table 11.2.6.3.3-4: Message TRACKING AREA UPDATE ACCEPT (step 15, Table 11.2.6.3.2-1)

Derivation path: 36.508 table 4.7.2-24			
Information Element	Value/Remark	Comment	Condition
Emergency number list	10 numbers TS 24.008, 10.5.3.13	The numbers shall be different than any of those indicated in TS 22.101 clause 10.1.1 AND the numbers provided in ATTACH ACCEPT in Table 11.2.6.3.3-1 AND the numbers stored in the USIM AND any emergency number stored permanently in the ME	
EPS network feature support	'0000 0111'B	- IMS voice over PS session in S1 mode supported - emergency bearer services in S1 mode supported - location services via EPC supported - no information about support of location services via CS domain is available	

Table 11.2.6.3.3-5: Message *RRConnectionRequest* (steps 19, 36 Table 11.2.6.3.2-1)

Derivation path: 36.508 table 4.6.1-16			
Information Element	Value/Remark	Comment	Condition
RRConnectionRequest ::= SEQUENCE {			
criticalExtensions CHOICE {			
rrcConnectionRequest-r8 SEQUENCE {			
establishmentCause	mo-Data		
}			
}			
}			

11.2.7 UE has PDN connection for emergency bearer services / Normal tracking area update / Accepted / Local Emergency Numbers List is not sent by the network / Handling of the lists of forbidden tracking areas

11.2.7.1 Test Purpose (TP)

(1)

```

with { UE having established a PDN connection for emergency bearer services }
ensure that {
  when { UE moves to another TA and receives a list of equivalent PLMNs in the TRACKING AREA UPDATE
ACCEPT message which includes a PLMN which is on the UE list with forbidden PLMNs }
  then { UE stores the received list of equivalent PLMNs not removing from the list the forbidden
PLMN }
}

```

(2)

```

with { UE having established a PDN connection for emergency bearer services and UE has stored a list
of equivalent PLMNs which includes a PLMN which is on the UE list with forbidden PLMNs }
ensure that {
  when { PDN connection for emergency bearer services is released }
  then { UE removes from the list of equivalent PLMNs any PLMN code present in the list of
forbidden PLMNs }
}

```

(3)

```

with { UE having received a Local Emergency Numbers List }
ensure that {
  when { UE does not receive a new Local Emergency Numbers List when roaming in the area with the
same MCC code }
  then { UE keeps the old Local Emergency Numbers List }
}

```

11.2.7.2 Conformance requirements

References: The conformance requirements covered in the present TC are specified in: 3GPP TS 24.301 clauses 5.5.3.2.4 and 5.3.7.

[TS 24.301 clause 5.5.3.2.4]

If due to regional subscription restrictions or access restrictions the UE is not allowed to access the TA, but it has a PDN connection for emergency bearer services established, the MME may accept the TRACKING AREA UPDATE REQUEST message and deactivate all non-emergency EPS bearer contexts by initiating an EPS bearer context deactivation procedure when the TAU is initiated in EMM-CONNECTED mode. When the TAU is initiated in EMM-IDLE mode, the MME locally deactivates all non-emergency EPS bearer contexts and informs the UE via the EPS bearer context status IE in the TRACKING AREA UPDATE ACCEPT message. The MME shall not deactivate the emergency EPS bearer contexts. The network shall consider the UE to be attached for emergency bearer services only and shall indicate in the EPS update result IE in the TRACKING AREA UPDATE ACCEPT message that ISR is not activated.

...

If an EPS bearer context status IE is included in the TRACKING AREA UPDATE ACCEPT message, the UE shall deactivate all those EPS bearers contexts locally (without peer-to-peer signalling between the UE and the MME) which are active in the UE, but are indicated by the MME as being inactive. If a default EPS bearer context is marked as inactive in the EPS bearer context status IE included in the TRACKING AREA UPDATE ACCEPT message, and this default bearer is not associated with the last PDN in the UE, the UE shall locally deactivate all EPS bearer contexts associated to the PDN connection with the default EPS bearer context without peer-to-peer ESM signalling to the MME. If only the PDN connection for emergency bearer services remains established, the UE shall consider itself attached for emergency bearer services only.

The MME may also include of list of equivalent PLMNs in the TRACKING AREA UPDATE ACCEPT message. Each entry in the list contains a PLMN code (MCC+MNC). The UE shall store the list as provided by the network, and if there is no PDN connection for emergency bearer services established, the UE shall remove from the list any PLMN code that is already in the list of forbidden PLMNs. If there is a PDN connection for emergency bearer services established, the UE shall remove from the list of equivalent PLMNs any PLMN code present in the list of forbidden PLMNs when the PDN connection for emergency bearer services is released. In addition, the UE shall add to the stored list the PLMN code of the registered PLMN that sent the list. The UE shall replace the stored list on each receipt of the TRACKING AREA UPDATE ACCEPT message. If the TRACKING AREA UPDATE ACCEPT message does not contain a list, then the UE shall delete the stored list.

If the UE is not attached for emergency bearer services and if the PLMN identity of the registered PLMN is a member of the list of "forbidden PLMNs" or the list of "forbidden PLMNs for GPRS service", any such PLMN identity shall be deleted from the corresponding list(s).

The network may also indicate in the EPS update result IE in the TRACKING AREA UPDATE ACCEPT message that ISR is active. If the UE is attached for emergency bearer services, the network shall indicate in the EPS update result IE in the TRACKING AREA UPDATE ACCEPT message that ISR is not activated. If the TRACKING AREA UPDATE ACCEPT message contains:

- i) no indication that ISR is activated, the UE shall set the TIN to "GUTI";
- ii) an indication that ISR is activated, the UE shall regard a previously assigned P-TMSI and RAI as valid and registered with the network. If the TIN currently indicates "P-TMSI", the UE shall set the TIN to "RAT-related TMSI".

The network informs the UE about the support of specific features, such as IMS voice over PS session, location services (EPC-LCS, CS-LCS) or emergency bearer services, in the EPS network feature support information element. In a UE with IMS voice over PS capability, the IMS voice over PS session indicator and the emergency bearer services indicator shall be provided to the upper layers. The upper layers take the IMS voice over PS session indicator into account as specified in 3GPP TS 23.221 [8A], subclause 7.2a, when selecting the access domain for voice sessions or calls. When initiating an emergency call, the upper layers also take the emergency bearer services indicator into account for the access domain selection. In a UE with LCS capability, location services indicators (EPC-LCS, CS-LCS) shall be provided to the upper layers. When MO-LR procedure is triggered by the UE's application, those indicators are taken into account as specified in 3GPP TS 24.171 [13C].

[TS 24.301 clause 5.3.7]

The Local Emergency Numbers List contains additional emergency numbers used by the serving network. The list can be downloaded by the network to the UE at successful registration and subsequent registration updates. There is only one Local Emergency Numbers List in the UE, and it can be updated with EMM procedures if the UE is in S1 mode and with GMM and MM procedures if the UE is in A/Gb or Iu mode.

The UE shall use the stored Local Emergency Numbers List received from the network in addition to the emergency numbers stored on the USIM or user equipment to detect that the number dialled is an emergency number.

...

The emergency number(s) received in the Emergency Number List IE are valid only in networks with the same MCC as in the cell on which this IE is received. If no Local Emergency Numbers List is contained in the ATTACH ACCEPT or in the TRACKING AREA UPDATE ACCEPT message, then the stored Local Emergency Numbers List in the user equipment shall be kept, except if the user equipment has successfully registered to a PLMN with an MCC different from that of the last registered PLMN.

11.2.7.3 Test description

11.2.7.3.1 Pre-test conditions

System Simulator:

- Cell A is set to "Serving cell";
- Cell B is set to "Non- Suitable cell";
- Cell G is set to "Non- Suitable Off cell"
- Cell I is set to "Non- Suitable Off cell"
- Cell A and Cell B are on the same PLMN1, Cell G is on different PLMN2 and Cell I is on different PLMN3. PLMN1 and PLMN2 have the same MCC
- System information combination 3 as defined in TS 36.508[18] clause 4.4.3.1 is used in E-UTRA cells

UE:

- USIM contains 2 Emergency Numbers (see TS 22.101 clause 10.1.1).
- PLMN2 and PLMN3 are in the UE's list with forbidden PLMNs

Preamble:

- the UE is in state Registered, Idle Mode (state 2) on Cell A according to TS 36.508 [18] with a PDN connection for emergency bearer services established (i.e. an Emergency call established according to TS 36.508 [18] section 4.5A.4 and released).

Table 11.2.7.3.2-1: Main behaviour

St	Procedure	Message Sequence		TP	Verdict
		U - S	Message		
-	The SS configures: Cell B as the "Serving cell". Cell A as a "Non-Suitable Off cell".	-	-	-	-
-	The following messages are to be observed on Cell B unless explicitly stated otherwise.	-	-	-	-
1	The UE transmit a TRACKING AREA UPDATE REQUEST message.	-->	TRACKING AREA UPDATE REQUEST	-	-
2	The SS transmits a TRACKING AREA UPDATE ACCEPT message providing a list of equivalent PLMNs which includes PLMN2 and PLMN3 which are on the UE list with forbidden PLMNs and providing a Local Emergency Numbers List.	<--	TRACKING AREA UPDATE ACCEPT	-	-
3	The UE transmits a TRACKING AREA UPDATE COMPLETE message.	-->	TRACKING AREA UPDATE COMPLETE	-	-
3A	The SS transmits an <i>RRCCConnectionRelease</i> message.	-	<i>RRCCConnectionRelease</i>	-	-
-	The SS configures: Cell G as the "Serving cell". Cell B as a " Non-Suitable Off cell"	-	-	-	-
-	The following messages are to be observed on Cell G unless explicitly stated otherwise.	-	-	-	-
4	Check: Does the UE transmit a TRACKING AREA UPDATE REQUEST message?	-->	TRACKING AREA UPDATE REQUEST	1	P
5	The SS transmits a TRACKING AREA UPDATE ACCEPT message providing a list of equivalent PLMNs which includes PLMN1 (the UE is expected to store the provided PLMN and add to the stored list the PLMN code of the registered PLMN that sent the list (PLMN2)) . No Local Emergency Numbers List is provided.	<--	TRACKING AREA UPDATE ACCEPT	-	-
6	The UE transmits a TRACKING AREA UPDATE COMPLETE message.	-->	TRACKING AREA UPDATE COMPLETE	-	-
6A	The SS transmits an <i>RRCCConnectionRelease</i> message.	-	<i>RRCCConnectionRelease</i>	-	-
7	Cause the UE to request disconnection from the emergency PDN (Note 1)	-	-	-	-
7A	Check: Does the UE transmit an <i>RRCCConnectionRequest</i> message with <i>establishmentCause</i> set to 'emergency'?	-->	<i>RRCCConnectionRequest</i>	-	-
-	The SS configures: cell I as a "Suitable cell"	-	-	-	-
7B	The SS transmits an <i>RRCCConnectionSetup</i> message.	<--	RRC: <i>RRCCConnectionSetup</i>	-	-
7C	The UE transmits an <i>RRCCConnectionSetupComplete</i> message to confirm the successful completion of the connection establishment and to initiate the session management procedure by including the SERVICE REQUEST message.	-->	RRC: <i>RRCCConnectionSetupComplete</i> NAS: SERVICE REQUEST	-	-
7D	The SS establishes SRB2 and DRBs associated with two default EPS bearer context (a first PDN obtained during the attach procedure and an additional PDN).	-	-	-	-
8	The UE transmit a PDN DISCONNECT REQUEST message.	-->	PDN DISCONNECT REQUEST	-	-
9	The SS transmits a DEACTIVATE EPS BEARER CONTEXT REQUEST message included in an <i>RRCCConnectionReconfiguration</i> message.	<--	DEACTIVATE EPS BEARER CONTEXT REQUEST	-	-
10	The UE transmits a DEACTIVATE EPS BEARER CONTEXT ACCEPT message.	-->	DEACTIVATE EPS BEARER CONTEXT ACCEPT	-	-

10 A	The SS transmits an <i>RRConnectionRelease</i> message.	-	<i>RRConnectionRelease</i>	-	-
-	The SS configures: cell G as a "Non-Suitable Off cell"	-	-	-	-
10 B	Check: Does the UE transmit a TRACKING AREA UPDATE REQUEST message in the following 1 minute?	-->	TRACKING AREA UPDATE REQUEST	2	F
-	The SS configures: cell A as a "Suitable cell"	-	-	-	-
-	The following messages are to be observed on Cell A unless explicitly stated otherwise.	-	-	-	-
-	EXCEPTION: Steps 11a1 to 11b1 describe behaviour that depends on the UE implementation; the "lower case letter" identifies a step sequence that takes place in a particular implementation.	-	-	-	-
11a 1	A generic procedure for UE camping on Cell A with TAU as described in TS 36.508 Table 6.4.2.7-1 takes place. No Local Emergency Numbers List is provided.	-	-	-	-
11b 1	Generic procedure for UE registration on Cell A as described in 36.508 Table 4.5.2.3-1 takes place. No Local Emergency Numbers List is provided.	-	-	-	-
12	Cause the UE to start a "call" using one of the Emergency Numbers received at step 2 in the TRACKING AREA UPDATE ACCEPT message within IE Local Emergency Numbers List. (Note 2).	-	-	-	-
13	Check: Does UE transmit an <i>RRConnectionRequest</i> message with <i>establishmentCause</i> set to 'emergency'?	-->	<i>RRConnectionRequest</i>	3	P
14	SS transmit an <i>RRConnectionSetup</i> message.	<--	RRC: <i>RRConnectionSetup</i>	-	-
15	The UE transmits an <i>RRConnectionSetupComplete</i> message to confirm the successful completion of the connection establishment and to initiate the session management procedure by including the SERVICE REQUEST message.	->	RRC: <i>RRConnectionSetupComplete</i> NAS: SERVICE REQUEST	-	-
16	The SS transmits SERVICE REJECT.	<--	SERVICE REJECT	-	-
17	The SS releases the RRC connection.	-	-	-	-
-	At the end of this test procedure sequence, the UE is in end state E-UTRA idle (E1) according to TS 36.508.	-	-	-	-
Note 1: The request to disconnect from a PDN may be performed by MMI or AT command.					
Note 2: The request to originate an emergency service may be performed by MMI or AT command.					

11.2.7.3.3 Specific message contents

Table 11.2.7.3.3-1: Message ATTACH ACCEPT (in the preamble)

Derivation path: 36.508 table 4.7.2-1			
Information Element	Value/Remark	Comment	Condition
EPS network feature support	'0000 0111'B	- IMS voice over PS session in S1 mode supported - emergency bearer services in S1 mode supported - location services via EPC supported - no information about support of location services via CS domain is available	

Table 11.2.7.3.3-2: Message TRACKING AREA UPDATE ACCEPT (step 2, Table 11.2.7.3.2-1)

Derivation path: 36.508 table 4.7.2-24			
Information Element	Value/Remark	Comment	Condition
Equivalent PLMNs	-	Includes MCC and MNC digits for PLMN2	
Emergency number list	2 numbers TS 24.008, 10.5.3.13	The numbers shall be different than any of those indicated in TS 22.101 clause 10.1.1 AND the numbers stored in the USIM AND any emergency number stored permanently in the ME	
EPS network feature support	'0000 0111'B	- IMS voice over PS session in S1 mode supported - emergency bearer services in S1 mode supported - location services via EPC supported - no information about support of location services via CS domain is available	

Table 11.2.7.3.3-3: Message TRACKING AREA UPDATE ACCEPT (step 5, Table 11.2.7.3.2-1)

Derivation path: 36.508 table 4.7.2-24			
Information Element	Value/Remark	Comment	Condition
Emergency number list	-	This IE is not present.	
Equivalent PLMNs	-	Includes MCC and MNC digits for PLMN1 and PLMN3	
EPS network feature support	'0000 0111'B	- IMS voice over PS session in S1 mode supported - emergency bearer services in S1 mode supported - location services via EPC supported - no information about support of location services via CS domain is available	

Table 11.2.7.3.3-4: Message ATTACH ACCEPT (step 11b1, Table 11.2.7.3.2-1)

Derivation path: 36.508 table 4.7.2-1			
Information Element	Value/Remark	Comment	Condition
Emergency number list	-	This IE is not present.	
EPS network feature support	'0000 0111'B	- IMS voice over PS session in S1 mode supported - emergency bearer services in S1 mode supported - location services via EPC supported - no information about support of location services via CS domain is available	

Table 11.2.7.3.3-5: Message RRCConnectionRequest (step 13, Table 11.2.7.3.2-1)

Derivation path: 36.508 table 4.6.1-16			
Information Element	Value/Remark	Comment	Condition
RRCConnectionRequest ::= SEQUENCE {			
criticalExtensions CHOICE {			
rrcConnectionRequest-r8 SEQUENCE {			
establishmentCause	emergency		
}			
}			
}			

Table 11.2.7.3.3-6: Message SERVICE REJECT (step 16, Table 11.2.7.3.2-1)

Derivation Path: 36.508 table 4.7.2-22			
Information Element	Value/remark	Comment	Condition
EMM cause	'0001 0110'B	#22 Congestion	

Table 11.2.7.3.3-7: Message TRACKING AREA UPDATE ACCEPT (step 11a1, Table 11.2.7.3.2-1)

Derivation path: 36.508 table 4.7.2-24			
Information Element	Value/Remark	Comment	Condition
Emergency number list	-	This IE is not present.	
EPS network feature support	'0000 0111'B	- IMS voice over PS session in S1 mode supported - emergency bearer services in S1 mode supported - location services via EPC supported - no information about support of location services via CS domain is available	

11.2.8 Attach for emergency bearer services / Rejected / No suitable cells in tracking area / Emergency call using the CS domain / UTRA or GERAN

11.2.8.1 Test Purpose (TP)

(1)

```
with { the UE has sent an ATTACH REQUEST for emergency bearer services }
ensure that {
  when { the UE receives an ATTACH REJECT message with the EMM cause set to "No suitable cells in tracking area" }
  then { UE establishes the emergency call using the CS domain (UTRA or GERAN) }
}
```

11.2.8.2 Conformance requirements

References: The conformance requirements covered in the present TC are specified in: 3GPP TS 24.301, clause 5.5.1.2.5A.

[TS 24.301, clause 5.5.1.2.5A]

If the attach request for emergency bearer services cannot be accepted by the network, the MME shall send an ATTACH REJECT message to the UE including EMM cause #5 "IMEI not accepted" or one of the EMM cause values as described in subclause 5.5.1.2.5.

Upon receiving the ATTACH REJECT message including EMM cause #5, the UE shall enter the state EMM-DEREGISTERED.NO-IMSI.

Upon receiving the ATTACH REJECT message including one of the other EMM cause values, the UE shall perform the actions as described in subclause 5.5.1.2.5 with the following addition: upon request from upper layers a CS voice capable UE may establish the emergency call using the CS domain.

...

11.2.8.3 Test description

11.2.8.3.1 Pre-test conditions

System Simulator:

- cell A is set to "Serving cell"
- If (px_RATComb_Tested = EUTRA_UTRA AND pc_CS_Em_Call_in_UTRA)
 - cell 5 is configured as "Suitable Neighbour cell"
 - System information combination 4 as defined in TS 36.508[18] clause 4.4.3.1 is used in E-UTRA cells
- If (px_RATComb_Tested = EUTRA_GERAN AND pc_CS_Em_Call_in_GERAN)
 - cell 24 is configured as "Suitable Neighbour cell"
 - System information combination 5 as defined in TS 36.508[18] clause 4.4.3.1 is used in E-UTRA cells

UE:

None.

Preamble:

- the UE is switched on and camped on cell A in EMM-DEREGISTERED.LIMITED-SERVICE state according to 36.508 [18].
- the UE is not attached for emergency bearer services.

11.2.8.3.2 Test procedure sequence

Table 11.2.8.3.2-1: Main behaviour

St	Procedure	Message Sequence		TP	Verdict
		U - S	Message		
1	Steps 1 to 3 of the generic procedures in TS 36.508 subclause 4.5A.5.3 are performed on cell A.	-	-	-	-
2	The UE transmits an ATTACH REQUEST message to attach for emergency bearer services, together with a PDN CONNECTIVITY REQUEST message for emergency bearer services, on Cell A.	-->	ATTACH REQUEST PDN CONNECTIVITY REQUEST	-	-
3	The SS transmits an ATTACH REJECT message, EMM cause = "No suitable cells in tracking area".	<--	ATTACH REJECT	-	-
3A	The SS releases the RRC connection.	-	-	-	-
-	EXCEPTION: Steps 4a1 to 4b14 describe behaviour that depends on the UE capability; the "lower case letter" identifies a step sequence that takes place if a capability is supported.	-	-	-	-
4a1	IF (px_RATComb_Testcd = EUTRA_UTRA AND pc_CS_Em_Call_in_UTRA, the SS reconfigures: Cell A as a "Suitable cell", Cell 5 as the "Serving cell".	-	-	-	-
4a2	Check: Does the UE transmit an RRC CONNECTION REQUEST message on Cell 5 with Establishment cause: Emergency Call in the next 60 seconds?	-->	RRC CONNECTION REQUEST	1	P
4a3	The SS transmits an RRC CONNECTION SETUP message.	<--	RRC CONNECTION SETUP	-	-
4a4	The UE transmits an RRC CONNECTION SETUP COMPLETE message.	-->	RRC CONNECTION SETUP COMPLETE	-	-
4a5	Check: Does the UE transmit a CM SERVICE REQUEST with CM service type IE indicating "Emergency call establishment"?	-->	CM SERVICE REQUEST	1	P
4a6	The SS transmits an AUTHENTICATION REQUEST message.	<--	AUTHENTICATION REQUEST	-	-
4a7	The UE transmits an AUTHENTICATION RESPONSE message.	-->	AUTHENTICATION RESPONSE	-	-
4a8	Check: Does the UE transmit an EMERGENCY SETUP message?	-->	EMERGENCY SETUP	1	P
4a9-4a14	Steps 11 to 16 of the generic test procedure in TS 34.108 subclause 7.2.3.2.3 are performed on Cell 5. NOTE: the CS call setup is completed.	-	-	-	-
4b1	IF (px_RATComb_Testcd = EUTRA_GERAN AND pc_CS_Em_Call_in_GERAN), the SS reconfigures: Cell A as a "Suitable cell", Cell 24 as the "Serving cell".	-	-	-	-
4b2	Check: Does the UE transmit a CHANNEL REQUEST message on Cell 24 with Establishment cause: Emergency call in the next 60 seconds?	-->	CHANNEL REQUEST	1	P
4b3	The SS transmits an IMMEDIATE ASSIGNMENT message.	<--	IMMEDIATE ASSIGNMENT	-	-
4b4	Check: Does the UE transmit a CM SERVICE REQUEST with CM service type IE indicating "Emergency call establishment"?	-->	CM SERVICE REQUEST	1	P
4b5	The SS transmits an AUTHENTICATION REQUEST message.	<--	AUTHENTICATION REQUEST	-	-
4b6	The UE transmits an AUTHENTICATION	-->	AUTHENTICATION RESPONSE	-	-

	RESPONSE message.				
4b7	Check: Does the UE transmit an EMERGENCY SETUP message?	-->	EMERGENCY SETUP	1	P
4b8-4b14	Steps 11 to 17 of the generic test procedure in TS 51.010-1 subclause 10.2.3 are performed on Cell 24. NOTE: the CS call setup is completed.	-	-	-	-

11.2.8.3.3 Specific message contents

Table 11.2.8.3.3-1: ATTACH REQUEST (Step 2, Table 11.2.8.3.2-1)

Derivation Path: 36.508, Table 4.7.2-4			
Information Element	Value/remark	Comment	Condition
EPS attach type	'0110'B	EPS emergency attach	
NAS key set identifier			
NAS key set identifier		No key is available	
EPS mobile identity	IMSI		
Old location area identification	Not present		
TMSI status	Not present		

Table 11.2.8.3.3-2: PDN CONNECTIVITY REQUEST (Step 2, Table 11.2.8.3.2-1)

Derivation Path: 36.508, Table 4.7.3-20			
Information Element	Value/remark	Comment	Condition
Request type	'0100'B	emergency	

Table 11.2.8.3.3-3: ATTACH REJECT (Step 3, Table 11.2.8.3.2-1)

Derivation Path: TS 36.508 Table 4.7.2-3			
Information Element	Value/remark	Comment	Condition
EMM cause	0000 1111	#15 "No suitable cells in tracking area"	
ESM message container	Not present		

Table 11.2.8.3.3-4: RRC CONNECTION REQUEST (Step 4a2, Table 11.2.8.3.2-1)

Derivation Path: TS 34.108 clause 9.1.1			
Information Element	Value/remark	Comment	Condition
Establishment cause	Emergency Call		

Table 11.2.8.3.3-5: CM SERVICE REQUEST (Steps 4a5 and 4b4, Table 11.2.8.3.2-1)

Derivation Path: TS 24.008 Table 9.2.11			
Information Element	Value/remark	Comment	Condition
CM service type	0010	Emergency call establishment	

Table 11.2.8.3.3-6: EMERGENCY SETUP (Steps 4a8 and 4b7, Table 11.2.8.3.2-1)

Derivation Path: TS 24.008 clause			
Information Element	Value/remark	Comment	Condition
Emergency setup message type	001110	EMERGENCY SETUP	

Table 11.2.8.3.3-7: CHANNEL REQUEST (Step 4b2, Table 11.2.8.3.2-1)

Derivation Path: TS 44.018 Table 9.1.8.1			
Information Element	Value/remark	Comment	Condition
Establishment cause	101	Emergency call	

11.2.8a Attach for emergency bearer services / Rejected / No suitable cells in tracking area / Emergency call using the CS domain / CDMA 2000 1xRTT

11.2.8a.1 Test Purpose (TP)

Same Test Purpose as in clause 11.2.8.1 except: UE establishes the emergency call using the CDMA 2000 1xRTT as CS domain.

11.2.8a.2 Conformance requirements

Same conformance requirements as in clause 11.2.8.2. For the present TCs the CS domain shall be understood as the CDMA 2000 1xRTT CS domain.

11.2.8a.3 Test description

11.2.8a.3.1 Pre-test conditions

System Simulator:

- Cell A is set to "Serving cell"
- Cell 19 is set to "Suitable Neighbour cell"
- System information combination 6 as defined in TS 36.508[18] clause 4.4.3.1 is used in E-UTRA cells.
- The SS broadcasts Emergency Call support in System Information Block 1 on Cell A.

UE:

- UE contains ISIM and USIM and CSIM applications on UICC.

Preamble:

- The UE is switched on and camped on cell A in EMM-DEREGISTERED.LIMITED-SERVICE state according to 36.508 [18].
- The UE is not attached for emergency bearer services.

11.2.8a.3.2 Test procedure sequence

Table 11.2.8a.3.2-1: Main behaviour

St	Procedure	Message Sequence		TP	Verdict
		U - S	Message		
1	Steps 1 to 3 of the generic procedures in TS 36.508 subclause 4.5A.5.3 are performed on cell A.	-	-	-	-
2	The UE transmits an ATTACH REQUEST message to attach for emergency bearer services, together with a PDN CONNECTIVITY REQUEST message for emergency bearer services, on Cell A.	-->	ATTACH REQUEST PDN CONNECTIVITY REQUEST	-	-
3	The SS transmits an ATTACH REJECT message, EMM cause = "No suitable cells in tracking area".	<--	ATTACH REJECT	-	-
4	The SS releases the RRC connection.	-	-	-	-
5	The SS reconfigures: Cell A as a "Suitable cell", Cell 19 as the "Serving cell".	-	-	-	-
6	Check: Does the UE transmit an <i>Origination</i> message on Cell 19 in the next [60] seconds?	-->	<i>Origination</i>	1	P
7	The SS transmits an <i>Extended Channel Assignment</i> message on Cell 19.	<--	<i>Extended Channel Assignment</i>	-	-
8	After the SS detects that Traffic Channel Initialization is successful, it transmits an <i>Acknowledgement Order</i> message on Cell 19.	<--	<i>Acknowledgement Order</i>	-	-
9	The SS transmits a <i>Service Connect</i> message on Cell 19.	<--	<i>Service Connect</i>	-	-
10	The UE transmits a <i>Service Connect Completion</i> message on Cell 19.	-->	<i>Service Connect Completion</i>	-	-

11.2.8a.3.3 Specific message contents

Table 11.2.8a.3.3-1: ATTACH REQUEST (Step 2, Table 11.2.8a.3.2-1)

Derivation Path: 36.508, Table 4.7.2-4			
Information Element	Value/remark	Comment	Condition
EPS attach type	'0110'B	EPS emergency attach	
NAS key set identifier			
NAS key set identifier		No key is available	
EPS mobile identity	IMSI		
Old location area identification	Not present		
TMSI status	Not present		

Table 11.2.8a.3.3-2: PDN CONNECTIVITY REQUEST (Step 2, Table 11.2.8a.3.2-1)

Derivation Path: 36.508, Table 4.7.3-20			
Information Element	Value/remark	Comment	Condition
Request type	'0100'B	emergency	

Table 11.2.8a.3.3-3: ATTACH REJECT (Step 3, Table 11.2.8a.3.2-1)

Derivation Path: TS 36.508 Table 4.7.2-3			
Information Element	Value/remark	Comment	Condition
EMM cause	0000 1111	#15 "No suitable cells in tracking area"	
ESM message container	Not present		

Table 11.2.8a.3.3-4: Origination (Step 6, Table 11.2.8a.3.2-1)

Field	Value/remark	Comment	Condition
MSG_ID	'000100'B	Origination Message	this value shall be verified by TTCN
SPECIAL_SERVICE	'1'B		
SERVICE_OPTION	Any value mapping to a voice service option		

Table 11.2.8a.3.3-5: Extended Channel Assignment (Step 7, Table 11.2.8a.3.2-1)

Field	Value/remark	Comment	Condition
MSG_ID	'010101'B	Extended Channel Assignment Message	
ASSIGN_MODE	'000'B	Traffic Channel Assignment	

Table 11.2.8a.3.3-6: Acknowledgment Order (Step 8, Table 11.2.8a.3.2-1)

Field	Value/remark	Comment	Condition
MSG_ID	'00000001'B	Order Message	
ORDER	'010000'B	Base Station Acknowledgment Order	
ORDQ	'00000000'B		

Table 11.2.8a.3.3-7: Service Connect (Step 9, Table 11.2.8a.3.2-1)

Field	Value/remark	Comment	Condition
MSG_ID	'00010100'B	Service Connect Message	
SERV_CON_SEQ	Set by SS		

Table 11.2.8a.3.3-8: Service Connect Completion (Step 10, Table 11.2.8a.3.2-1)

Information Element	Value/remark	Comment	Condition
MSG_ID	'00001110'B	Service Connect Completion Message	this value shall be verified by TTCN
SERV_CON_SEQ	Same value as SERV_CON_SEQ received in Service Connect Message (Table 11.2.8a.3.3-7)		

11.2.9 Void

11.2.10 LIMITED-SERVICE / EPS does not support IMS Emergency / Emergency call using the CS domain

11.2.10.1 Test Purpose (TP)

(1)

```
with { UE not equipped with a USIM and UE supporting IMS Emergency and Voice services }
ensure that {
  when { UE is switched on and LTE cell does not support IMS emergency call }
  then { UE camps on a non-LTE cell }
```

```
}
```

(2)

```
with { UE supporting IMS Emergency and Voice services not equipped with a USIM and camped on a non-  
LTE cell }  
ensure that {  
  when { UE is requested to make an emergency call }  
  then { UE transmits an RRC CONNECTION REQUEST message }  
}
```

11.2.10.2 Conformance requirements

References: The conformance requirements covered in the present TC are specified in: TS 36.304, clause 4.15.2.2, 5.2.9.

[TS 36.304, clause 5.2.2]

Figure 2 shows the states and state transitions and procedures in RRC_IDLE. Whenever a new PLMN selection is performed, it causes an exit to number 1.

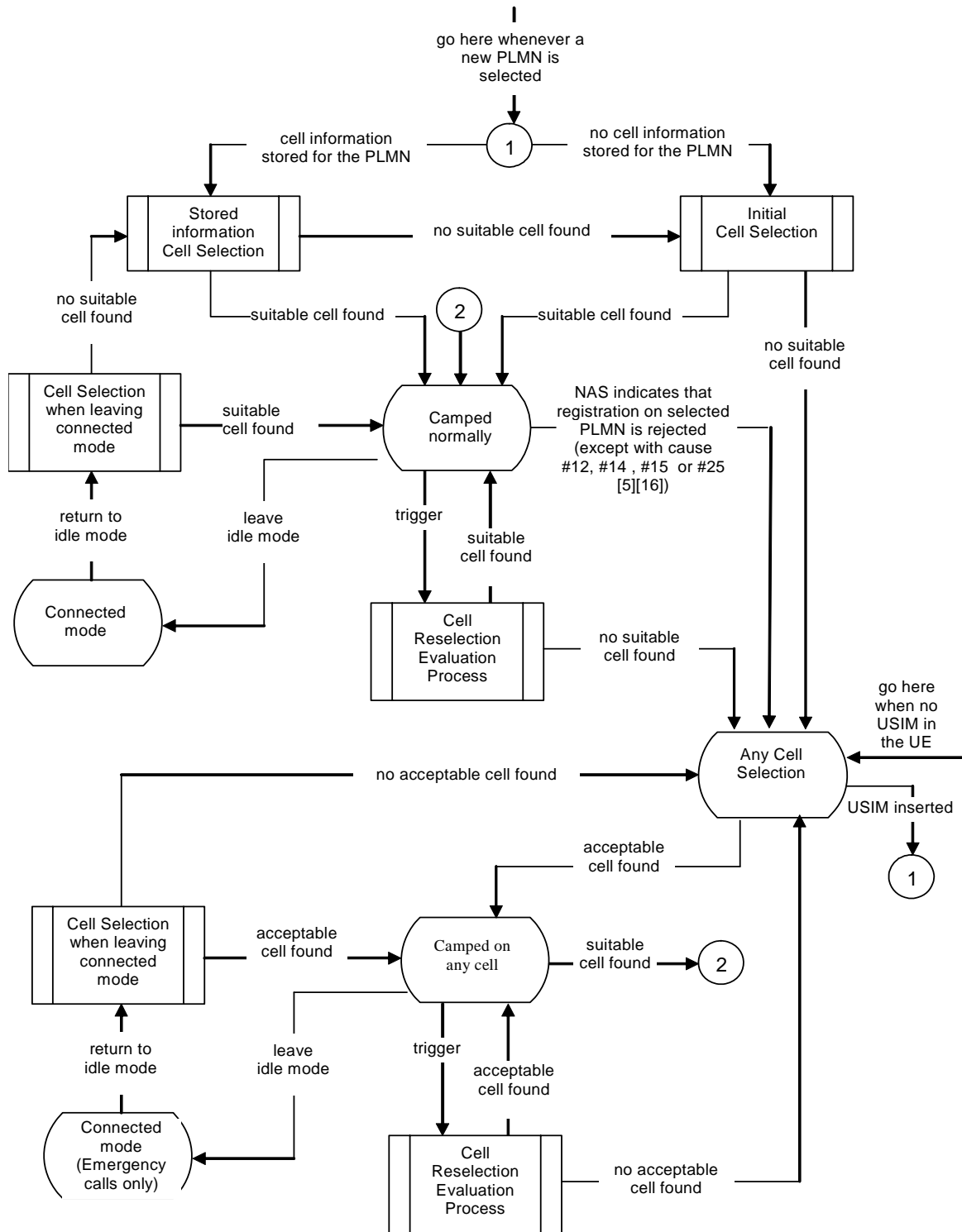

Figure 5.2.2-1: RRC_IDLE Cell Selection and Reselection

[TS 36.304, clause 5.2.9]

In this state, the UE shall perform the following tasks:

- select and monitor the indicated paging channels of the cell as specified in clause 7;
- monitor relevant System Information as specified in [3];
- perform necessary measurements for the cell reselection evaluation procedure;
- execute the cell reselection evaluation process on the following occasions/triggers:
 - 1) UE internal triggers, so as to meet performance as specified in [10];
 - 2) When information on the BCCH used for the cell reselection evaluation procedure has been modified;
- regularly attempt to find a suitable cell trying all frequencies of all RATs that are supported by the UE. If a suitable cell is found, UE shall move to *camped normally* state;
- if the UE supports voice services and the current cell does not support emergency call as indicated in System information specified in [3], the UE should perform cell selection/ reselection to an acceptable cell of any supported RAT regardless of priorities provided in system information from current cell, if no suitable cell is found.

NOTE1: The UE is allowed to not perform reselection to an inter-frequency E-UTRAN cell in order to prevent camping on a cell on which it cannot initiate an IMS emergency call.

11.2.10.3 Test description

11.2.10.3.1 Pre-test conditions

System Simulator:

- Cell A and Cell 5.

Table 11.2.10.3.1-1: Time instances of cell power level and parameter changes

	Parameter	Unit	Cell A	Cell 5
T0	Cell-specific RS EPRE	dBm	-70	-
	CPICH_Ec (UTRA FDD)	dBm/3.84 MHz	-	-75
	PCCPCH RSCP (UTRA LCR TDD)	dBm/1.28 MHz	-	-75

UE:

- The UE is not equipped with either a USIM or ISIM.

Preamble:

- The UE is in state Switched OFF (state 1) according to [18].

11.2.10.3.2 Test procedure sequence

Table 11.2.10.3.2-1: Main behaviour

St	Procedure	Message Sequence		TP	Verdict
		U - S	Message		
1	The UE is switched on.	-	-	-	-
2	Wait for 60s for the UE to complete cell selection. E-UTRA cell is more powerful than UTRA cell	-	-	-	-
3	Cause the UE to originate Emergency call. (see Note 1)	-	-	-	-
4	Check: Does the UE transmit an RRC CONNECTION REQUEST message on Cell 5?	-->	RRC CONNECTION REQUEST	1, 2	P
5	The SS transmits an RRC CONNECTION SETUP message on Cell 5.	<--	RRC CONNECTION SETUP	-	-
6	The UE transmits an RRC CONNECTION SETUP COMPLETE message on Cell 5.	-->	RRC CONNECTION SETUP COMPLETE	-	-
7	The UE transmits an INITIAL DIRECT TRANSFER message on Cell 5. This message includes a CM SERVICE REQUEST message.	-->	INITIAL DIRECT TRANSFER	-	-
8	The SS transmits a DOWNLINK DIRECT TRANSFER message on Cell 5. This message includes a CM SERVICE ACCEPT message.	<--	DOWNLINK DIRECT TRANSFER	-	-
9	The UE transmits an UPLINK DIRECT TRANSFER message on Cell 5. This message includes an EMERGENCY SETUP message.	-->	UPLINK DIRECT TRANSFER	-	-
10-15	Steps 11 to 16 of the generic test procedure in TS 34.108 subclause 7.2.3.2.3 are performed on Cell 5.	-	-	-	-

Note 1: The request is assumed to be triggered by AT command D.

11.2.10.3.3 Specific message contents

Table 11.2.10.3.3-1: SystemInformationBlockType1 for Cell1 (preamble and all steps)

Derivation Path: 36.508 clause 4.4.3.2			
Information Element	Value/remark	Comment	Condition
SystemInformationBlockType1 ::= SEQUENCE {			
ims-EmergencySupport-r9	Not present	Not support IMS emergency call	
}			

11.2.11 LIMITED-SERVICE / Inter-system mobility / E-UTRA to UTRA CS / SRVCC Emergency Call Handover to UTRAN

11.2.11.1 Test Purpose (TP)

(1)

```

with { UE in E-UTRA RRC_CONNECTED state }
ensure that {
  when { UE receives a MobilityFromEUTRACommand message and an IMS emergency call is ongoing and an UTRA Speech RAB combination is configured for an UTRA cell }
  then { UE transmits a HANDOVER TO UTRAN COMPLETE message on the UTRA cell }
}

```

11.2.11.2 Conformance requirements

References: The conformance requirements covered in the present TC are specified in: TS 36.331, clause 5.4.3.3, TS 23.216, clause 6.2.2.1 and TS 23.216, clause 6.2.2.1A.

[TS 36.331, clause 5.4.3.3]

The UE shall be able to receive a *MobilityFromEUTRACCommand* message and perform a cell change order to GERAN, even if no prior UE measurements have been performed on the target cell.

The UE shall:

- 1> stop timer T310, if running;
- 1> if the *MobilityFromEUTRACCommand* message includes the *purpose* set to 'handover':
 - 2> if the *targetRAT-Type* is set to 'utra' or 'geran':
 - 3> consider inter-RAT mobility as initiated towards the RAT indicated by the *targetRAT-Type* included in the *MobilityFromEUTRACCommand* message;
 - 3> forward the *nas-SecurityParamFromEUTRA* to the upper layers;
 - 3> access the target cell indicated in the inter-RAT message in accordance with the specifications of the target RAT;

[TS 23.216, clause 6.2.2.1]

Depicted in figure 6.2.2.1-1 is a call flow for SRVCC from E-UTRAN to GERAN without DTM support. The flow requires that eNB can determine that the target is GERAN without DTM support or that the UE is without DTM support.

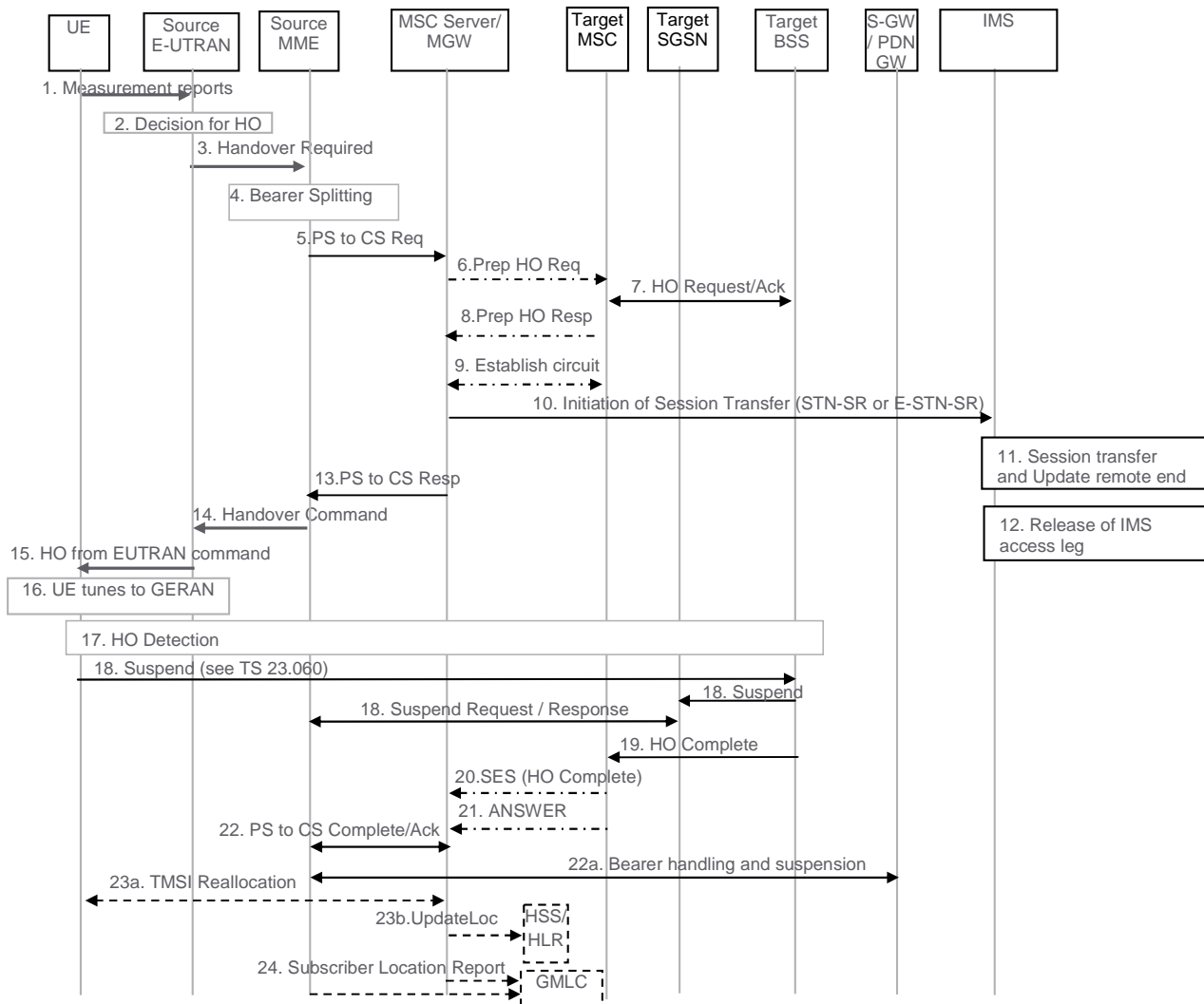

Figure 6.2.2.1-1: SRVCC from E-UTRAN to GERAN without DTM support

1. UE sends measurement reports to E-UTRAN.
2. Based on UE measurement reports the source E-UTRAN decides to trigger an SRVCC handover to GERAN.
3. Source E-UTRAN sends Handover Required (Target ID, generic Source to Target Transparent Container, SRVCC HO Indication) message to the source MME. The E-UTRAN places the "old BSS to new BSS information IE" for the CS domain in the generic Source to Target Transparent Container. The SRVCC HO indication indicates to the MME that target is only CS capable; hence this is a SRVCC handover operation only towards the CS domain. The message includes an indication that the UE is not available for the PS service in the target cell.
4. Based on the QCI associated with the voice bearer (QCI 1) and the SRVCC HO indication, the source MME splits the voice bearer from the non voice bearers and initiates the PS-CS handover procedure for the voice bearer only towards MSC Server.
5. The MME sends a SRVCC PS to CS Request (IMSI, Target ID, STN-SR, C-MSISDN, generic Source to Target Transparent Container, MM Context, and Emergency Indication) message to the MSC Server. The Emergency Indication and the equipment identifier are included if the ongoing session is emergency session. Authenticated IMSI and C-MSISDN shall also be included, if available. The MME received STN-SR and C-MSISDN from the HSS as part of the subscription profile downloaded during the E-UTRAN attach procedure. The MM Context contains security related information. CS security key is derived by the MME from the E-UTRAN/EPS domain key as defined in TS 33.401 [22]. The CS Security key is sent in the MM Context.
6. The MSC Server interworks the PS-CS handover request with a CS inter-MSC handover request by sending a Prepare Handover Request message to the target MSC. The MSC Server assigns a default SAI as Source ID on the interface to the target BSS and uses BSSMAP encapsulated for the Prepare Handover Request.

NOTE 1: The value of the default SAI is configured in the MSC and allows a release 8 and later BSC to identify that the source for the SRVCC Handover is E-UTRAN. To ensure correct statistics in the target BSS the default SAI should be different from the SAIs used in UTRAN.

7. Target MSC performs resource allocation with the target BSS by exchanging Handover Request/ Acknowledge messages.
8. Target MSC sends a Prepare Handover Response message to the MSC Server.
9. Establishment of circuit connection between the target MSC and the MGW associated with the MSC Server e.g. using ISUP IAM and ACM messages.
10. For non-emergency session, the MSC Server initiates the Session Transfer by using the STN-SR e.g. by sending an ISUP IAM (STN-SR) message towards the IMS. For emergency session, the MSC Server initiates the Session Transfer by using the locally configured E-STN-SR and by including the equipment identifier. Standard IMS Service Continuity or Emergency IMS Service Continuity procedures are applied for execution of the Session Transfer; see TS 23.237 [14].

NOTE 2: This step can be started after step 8.

NOTE 3: If the MSC Server is using an ISUP interface, then the initiation of the session transfer for non-emergency session may fail if the subscriber profile including CAMEL triggers is not available prior handover (see clause 7.3.2.1.3 in TS 23.292 [13]).

11. During the execution of the Session Transfer procedure the remote end is updated with the SDP of the CS access leg. The downlink flow of VoIP packets is switched towards the CS access leg at this point.
12. Source IMS access leg is released as per TS 23.237 [14].

NOTE 4: Steps 11 and 12 are independent of step 13.

13. MSC Server sends a SRVCC PS to CS Response (Target to Source Transparent Container) message to the source MME.
14. Source MME sends a Handover Command (Target to Source Transparent Container) message to the source E-UTRAN. The message includes information about the voice component only.

15. Source E-UTRAN sends a Handover from E-UTRAN Command message to the UE.
16. UE tunes to GERAN.
17. Handover Detection at the target BSS occurs. The UE sends a Handover Complete message via the target BSS to the target MSC. If the target MSC is not the MSC Server, then the Target MSC sends an SES (Handover Complete) message to the MSC Server.
18. The UE starts the Suspend procedure specified in TS 23.060 [10], clause 16.2.1.1.2. The TLLI and RAI pair are derived from the GUTI as described in TS 23.003 [27]. This triggers the Target SGSN to send a Suspend Notification message to the Source MME. The MME returns a Suspend Acknowledge to the Target SGSN.

NOTE 5: The MME might not be able to derive the GUTI from the received P-TMSI and RAI pair and therefore it might not be able to identify which UE context is associated with the Suspend Notification message. Also in this case the bearers are deactivated and/or suspended as in step 22a.

19. Target BSS sends a Handover Complete message to the target MSC.
20. Target MSC sends an SES (Handover Complete) message to the MSC Server. The speech circuit is through connected in the MSC Server/MGW according to TS 23.009 [18].
21. Completion of the establishment procedure with ISUP Answer message to the MSC Server according to TS 23.009 [18].
22. MSC Server sends a SRVCC PS to CS Complete Notification message to the source MME, informing it that the UE has arrived on the target side. Source MME acknowledges the information by sending a SRVCC PS to CS Complete Acknowledge message to the MSC Server.

- 22a. The MME deactivates bearers used for voice and other GBR bearers. All GBR bearers are deactivated towards S-GW and P-GW by initiating MME-initiated Dedicated Bearer Deactivation procedure as specified in TS 23.401 [2]. The MME does not send deactivation request toward the eNodeB on receiving PS-to-CS Complete Notification in step 22. PS-to-CS handover indicator is notified to P-GW for voice bearer during the bearer deactivation procedure. For GTP-based S5/S8, the S-GW requests the P-GW to delete all GBR bearer contexts by sending a Delete Bearer Command message. If dynamic PCC is deployed, the P-GW may interact with PCRF as defined in TS 23.203 [31]. For PMIP-based S5/S8, S-GW interacts with the PCRF which in turn updates PCC rules for GBR traffic in the P-GW.

The MME starts preservation and suspension of non-GBR bearers by sending Suspend Notification message towards S-GW. For these non-GBR bearers, the S-GW releases S1-U bearers for the UE and sends Suspend Notification message to the P-GW(s). The MME stores in the UE context that UE is in suspended status. All the preserved non-GBR bearers are marked as suspended status in the S-GW and P-GW. The P-GW should discard packets if received for the suspended UE.

- 23a. If the HLR is to be updated, i.e. if the IMSI is authenticated but unknown in the VLR, the MSC Server performs a TMSI reallocation towards the UE using its own non-broadcast LAI and, if the MSC Server and other MSC/VLRs serve the same (target) LAI, with its own Network Resource Identifier (NRI).

NOTE 5: The TMSI reallocation is performed by the MSC Server towards the UE via target MSC.

- 23b. If the MSC Server performed a TMSI reallocation in step 23a, and if this TMSI reallocation was completed successfully, the MSC Server performs a MAP Update Location to the HSS/HLR.

NOTE 6: This Update Location is not initiated by the UE.

24. For an emergency services session after handover is complete, the source MME or the MSC Server may send a Subscriber Location Report carrying the identity of the MSC Server to a GMLC associated with the source or target side, respectively, as defined in TS 23.271 [29] to support location continuity.

NOTE 7: Any configuration of the choice between a source MME versus MSC Server update to a GMLC needs to ensure that a single update occurs from one of these entities when the control plane location solution is used on the source and/or target sides.

After the CS voice call is terminated and if the UE is still in GERAN (or for any other reason specified in TS 24.008), then the UE shall resume PS services as specified in TS 23.060 [10]. A Gn SGSN will follow TS 23.060 [10] to resume the PDP Context(s). An S4 SGSN will follow TS 23.060 [10] to resume the bearers, and will in addition inform S-GW

and P-GW(s) to resume the suspended bearers. If the UE has returned to E-UTRAN after the CS voice call was terminated, then the UE shall resume PS service by sending TAU to MME. The MME will in addition inform S-GW and P-GW(s) to resume the suspended bearers. Resuming the suspended bearers in the S-GW and in the P-GW should be done by implicit resume using the Modify Bearer request message if it is triggered by the procedure in operation, e.g. RAU, TAU or Service Request. The S-GW is aware of the suspend state of the bearers and will forward the Modify Bearer request to the P-GW. Explicit resume using the Resume Notification message should be used in cases when Modify Bearer Request is not triggered by the procedure in operation.

[TS 23.216, clause 6.2.2.1A]

The call flow for this scenario is similar to the call flow depicted in figure 6.2.2.1-1, with the exceptions that the Suspend procedure (step 18 and step 22a in figure 6.2.2.1-1) is not performed and that the MME only deactivates bearers used for voice (step 22a in figure 6.2.2.1-1) and sets the PS-to-CS handover indicator. The scenario requires that eNB can determine that the target is either GERAN with DTM but without DTM HO support and that the UE is supporting DTM or that the target is UTRAN (HSPA) without PS HO support. The message in step 3 in figure 6.2.2.1-1 includes an indication to the MME that the UE is available for PS service in the target cell. Furthermore, if the target is GERAN, the E-UTRAN places in the generic Source to Target Transparent Container the "old BSS to new BSS information IE", while if the target is UTRAN, the generic Source to Target Transparent container is encoded according to the Source RNC to Target RNC Transparent Container IE definition. At the end of the procedure described in figure 6.2.2.1-1, the remaining PS resources are re-established when the UE performs the Routeing Area update procedure. Triggers for performing Routeing Area update procedure are described in TS 23.060 [10]. The target SGSN may deactivate the PDP contexts that cannot be established as described in TS 23.060 [10].

11.2.11.3 Test description

11.2.11.3.1 Pre-test conditions

System Simulator:

- Cell A and Cell 5.
- System information combination 4 as defined in TS 36.508 [18] clause 4.4.3.1 is used in E-UTRA cells.
- The PLMN is defined in Table 11.2.11.3.1-1.

Table 11.2.11.3.1-1: PLMN identifier

Cell	PLMN name
A	PLMN4

UE:

- The UE is equipped with either ISIM and USIM applications or only a USIM application on UICC. The USIM containing default values except for those listed in Table 11.2.11.3.1-2.

Table 11.2.11.3.1-2: USIM configuration

USIM field	Priority	Value	Access Technology Identifier
EF _{IMSI}	-	The HPLMN (MCC+MNC) of the IMSI is set to PLMN1.	-
EF _{FPLMN}	-	PLMN4	-
EF _{PLMNwACT}	1	Default	E-UTRAN
EF _{OPLMNwACT}	1	PLMN1	E-UTRAN
EF _{HPLMNwACT}	1	PLMN1	E-UTRAN

Preamble:

- The UE is Switched OFF (State 1) according to [18].

11.2.11.3.2 Test procedure sequence

Table 11.2.11.3.2-1 illustrates the downlink power levels and other changing parameters to be applied for the cells at various time instants of the test execution. Row marked "T0" denotes the initial conditions after preamble, while

columns marked "T1" is to be applied subsequently. The exact instants on which these values shall be applied are described in the texts in this clause.

Table 11.2.11.3.2-1: Time instances of cell power level and parameter changes

	Parameter	Unit	Cell A	Cell 5	Remark
T0	Cell-specific RS EPRE	dBm/15k Hz	-60	-	The power level values are such that entering conditions for event B2 are not satisfied.
	CPICH_Ec (UTRA FDD)	dBm/3.8 4 MHz	-	-88	
	PCCPCH_Ec (UTRA LCR TDD)	dBm/1.2 8 MHz	-	-88	
T1	Cell-specific RS EPRE	dBm/15k Hz	-84	-	The power level values are such that entering conditions for event B2 are satisfied.
	CPICH_Ec (UTRA FDD)	dBm/3.8 4 MHz	-	-64	
	PCCPCH_Ec (UTRA LCR TDD)	dBm/1.2 8 MHz	-	-64	

Table 11.2.11.3.2-2: Main behaviour

St	Procedure	Message Sequence		TP	Verdict
		U - S	Message		
1	The SS configures UTRA cell 5 to reference configuration according 36.508 table 4.8.3-1, condition UTRA Speech.	-	-	-	-
2	Power on the UE.	-	-	-	-
3	Wait 60s for the UE to camp on Cell A as an acceptable cell.	-	-	-	-
4-6	Steps 1 to 3 of the generic test procedure for IMS Emergency call establishment in EUTRA: Limited Service (TS 36.508 subclause 4.5A.5.3-1).	-	-	-	-
7	The UE transmits an <i>RRConnectionSetupComplete</i> message.	-->	RRC: <i>RRConnectionSetupComplete</i> NAS: ATTACH REQUEST NAS: PDN CONNECTIVITY REQUEST	-	-
8-22	Steps 5 to 19 of the generic test procedure for IMS Emergency call establishment in EUTRA: Limited Service (TS 36.508 subclause 4.5A.5.3-1).	-	-	-	-
23	The SS transmits an <i>RRConnectionReconfiguration</i> message on Cell A to setup inter RAT measurement and reporting for event B2.	<--	<i>RRConnectionReconfiguration</i>	-	-
24	The UE transmits an <i>RRConnectionReconfigurationComplete</i> message on Cell A.	-->	<i>RRConnectionReconfigurationComplete</i>	-	-
25	The SS changes the power level for Cell A and Cell 5 according to the row "T1" in table 11.2.11.3.2-1	-	-	-	-
26	The UE transmits a <i>MeasurementReport</i> message on Cell A to report event B2 for Cell 5.	-->	<i>MeasurementReport</i>	-	-
27	The SS transmits a <i>MobilityFromEUTRACommand</i> message on Cell A.	<--	<i>MobilityFromEUTRACommand</i>	-	-
28	Check: Does the UE transmit a <i>HANDOVER TO UTRAN COMPLETE</i> message on cell 5?	-->	<i>HANDOVER TO UTRAN COMPLETE</i>	1	P
-	EXCEPTION: In parallel to the events described in step 29 to 34 the steps specified in table 11.2.11.3.2-3 takes place.	-	-	-	-
29	The SS transmits a <i>SECURITY MODE COMMAND</i> message for the CS domain.	<--	<i>SECURITY MODE COMMAND</i>	-	-
30	The UE transmits a <i>SECURITY MODE COMPLETE</i> message.	-->	<i>SECURITY MODE COMPLETE</i>	-	-
31	The SS transmits an <i>UTRAN MOBILITY INFORMATION</i> message to notify CN information.	<--	<i>UTRAN MOBILITY INFORMATION</i>	-	-
32	The UE transmits an <i>UTRAN MOBILITY INFORMATION CONFIRM</i> message.	-->	<i>UTRAN MOBILITY INFORMATION CONFIRM</i>	-	-
33	The SS transmits a <i>TMSI REALLOCATION COMMAND</i> message.	<--	<i>TMSI REALLOCATION COMMAND</i>	-	-
34	The UE transmits a <i>TMSI REALLOCATION COMPLETE</i> message.	-->	<i>TMSI REALLOCATION COMPLETE</i>	-	-

Table 11.2.11.3.2-3: Parallel behaviour

St	Procedure	Message Sequence		TP	Verdict
		U - S	Message		
1	Check: Does the UE transmit a ROUTING AREA UPDATE REQUEST message?	-->	ROUTING AREA UPDATE REQUEST	-	P
2	The SS transmits a ROUTING AREA UPDATE ACCEPT message.	<--	ROUTING AREA UPDATE ACCEPT	-	-
3	The UE transmits a ROUTING AREA UPDATE COMPLETE message.	-->	ROUTING AREA UPDATE COMPLETE	-	-

Table 11.2.11.3.2-4: Void

11.2.11.3.3 Specific message contents

Table 11.2.11.3.3-1: ATTACH REQUEST (Step 7, Table 11.2.11.3.2-2)

Derivation path: 36.508 table 4.7.2-4			
Information Element	Value/remark	Comment	Condition
EPS attach type	'0110'B	EPS emergency attach	
ESM message container	PDN CONNECTIVITY REQUEST message to request PDN connectivity to an emergency PDN		
MS network capability	SRVCC from UTRAN HSPA or E-UTRAN to GERAN/UTRAN supported		
Mobile station classmark 2	Any allowed value		
Supported Codecs	Any allowed value		

Table 11.2.11.3.3-2: RRCConnectionReconfiguration (step 23, Table 11.2.11.3.2-2)

Derivation Path: 36.508 clause 4.6.1 table 4.6.1-8 with condition MEAS
--

Table 11.2.11.3.3-3: MeasConfig (step 23, Table 11.2.11.3.3-2)

Derivation path: 36.508 clause 4.6.6 table 4.6.6-1 with condition UTRAN			
Information Element	Value/Remark	Comment	Condition
measurementConfiguration ::= SEQUENCE {			
measObjectToAddModifyList SEQUENCE (SIZE (1..maxObjectId)) OF SEQUENCE {	2 entries		
measObjectId[1]	IdMeasObject-f8		
measObject[1]	MeasObjectUTRA-GENERIC(f8)		
measObjectId[2]	IdMeasObject-f1		
measObject[2]	MeasObjectEUTRA-GENERIC(f1)		
}			
reportConfigToAddModifyList SEQUENCE (SIZE (1..maxReportConfigId)) OF SEQUENCE {	1 entry		
reportConfigId[1]	IdReportConfigInterRAT-B2-UTRA		
reportConfig[1]	ReportConfigInterRAT-B2-UTRA(-72, -76)		
}			
measIdToAddModifyList SEQUENCE (SIZE (1..maxMeasId)) OF SEQUENCE {	1 entry		
measId[1]	1		
measObjectId[1]	IdMeasObject-f8		
reportConfigId[1]	IdReportConfigInterRAT-B2-UTRA		
}			
}			

Table 11.2.11.3.3-4: MeasurementReport (step 26, Table 11.2.11.3.2-2)

Derivation Path: 36.508, table 4.6.1-5			
Information Element	Value/remark	Comment	Condition
MeasurementReport ::= SEQUENCE {			
criticalExtensions CHOICE {			
c1 CHOICE{			
measurementReport-r8 SEQUENCE {			
measResults SEQUENCE {			
measId	1		
measResultServCell SEQUENCE {			
rsrpResult	(0..97)		
rsrqResult	(0..34)		
}			
measResultNeighCells CHOICE {			
measResultListUTRA SEQUENCE (SIZE (1..maxCellReport)) OF SEQUENCE {	1 entry		
physCellId[1]	PhysicalCellIdentity of Cell 5		
cgi-Info[1]	Not present		
measResult[1] SEQUENCE {			
utra-RSCP	(-5..91)		
}			
}			
}			
}			
}			
}			

Table 11.2.11.3.3-5: *MobilityFromEUTRACommand* (step 27, Table 11.2.11.3.2-2)

Derivation Path: 36.508, Table 4.6.1-6			
Information Element	Value/remark	Comment	Condition
MobilityFromEUTRACommand ::= SEQUENCE {			
criticalExtensions CHOICE {			
c1 CHOICE{			
mobilityFromEUTRACommand-r8 SEQUENCE {			
cs-FallbackIndicator	True		
purpose CHOICE{			
handover SEQUENCE {			
targetRAT-Type	Utra		
targetRAT-MessageContainer	HANDOVER TO UTRAN COMMAND(UTRA RRC message)		
nas-SecurityParamFromEUTRA	The 4 least significant bits of the NAS downlink COUNT value		
systemInformation	Not present		
}			
}			
}			
}			
}			
}			
}			

Table 11.2.11.3.3-7: HANDOVER TO UTRAN COMMAND (step 27, Table 11.2.11.3.3-5)

Derivation Path: 36.508, Table 4.7B.1-1, condition UTRA Speech

Table 11.2.11.3.3-8: SECURITY MODE COMMAND (step 29, Table 11.2.11.3.2-2)

Derivation Path: 36.508, Table 4.7B.1-n		
Information Element	Condition	Value/remark
Ciphering mode info		Not Present

12 E-UTRA radio bearer tests

12.1 General

The present clause defines radio bearer combinations as well as generic E-UTRA radio bearer test procedures. The generic E-UTRA radio bearer test procedures include generic TPs and test description. The TCs that follow verify specific E-UTRA radio bearer combinations by indicating the relevant combinations and making reference to the generic procedures' TPs and test description as appropriate. The reference to the generic TP shall be understood not as having the same TP rather as applying the same TP to a different E-UTRA radio bearer combination.

12.1.0 Definition of radio bearer combinations

The radio bearer combinations tested are listed in table 12-1. The radio bearer combinations and identifiers (1 to 13) are according to the radio bearer combinations and identifier in TS 36.331 Annex B.1.

Table 12-1: Radio Bearer Combinations

RB combination identifier	Radio bearer combination
1	SRB1 and SRB2 for DCCH + 1xAM DRB
2	SRB1 and SRB2 for DCCH + 1xAM DRB + 1xUM DRB
3	SRB1 and SRB2 for DCCH + 2xAM DRB
4	SRB1 and SRB2 for DCCH + 2xAM DRB + 1xUM DRB
5	SRB1 and SRB2 for DCCH + 2xAM DRB + 2xUM DRB
6	SRB1 and SRB2 for DCCH + 3xAM DRB
7	SRB1 and SRB2 for DCCH + 3xAM DRB + 1xUM DRB
8	SRB1 and SRB2 for DCCH + 3xAM DRB + 2xUM DRB
9	SRB1 and SRB2 for DCCH + 4xAM DRB
10	SRB1 and SRB2 for DCCH + 4xAM DRB + 1xUM DRB
11	SRB1 and SRB2 for DCCH + 4xAM DRB + 2xUM DRB
12	SRB1 and SRB2 for DCCH + 5xAM DRB + 3xUM DRB
13	SRB1 and SRB2 for DCCH + 8xAM DRB

12.1.1 Generic E-UTRA radio bearer test procedure / MIMO not configured

12.1.1.1 Test Purpose (TP)

(1)

```
with { UE in E-UTRA RRC_CONNECTED state with a "n x AM DRB + m x UM DRB" radio bearer combination
established and physical layer configured for SISO transmission}
ensure that {
  when { UE receives a PDCP SDU on each configured AM and UM DRB within the same TTI }
  then { UE forward the received PDCP SDUs to upper layer }
}
```

(2)

```
with { UE in E-UTRA RRC_CONNECTED state with "an x AM DRB + m x UM DRB" radio bearer combination
established }
ensure that {
  when { UE has pending data in the transmission buffer corresponding to a complete PDCP SDU on each
configured AM and UM DRB and UE receives an UL Grant allowing UE to transmit all pending data }
  then { UE transmits a PDCP SDU on each configured AM and UM DRB within the same TTI }
}
```

12.1.1.2 Conformance requirements

References: The conformance requirements covered in the present TC are specified in: 3GPP TS 36-series Layer 1, Layer 2 and Layer 3 core specifications.

12.1.1.3 Test description

12.1.1.3.1 Pre-test conditions

System Simulator

- Cell 1

UE:

- None

Preamble

- The UE is in state Loopback Activated (state 4) according to [18].
- Radio bearer for combination SRB1 and SRB2 for $n \times$ AM DRB + $m \times$ UM DRB is used where n and m are specified in the test case.

Table 12.1.1.3.1-1: RLC settings

Parameter	Value
t-PollRetransmit	250 ms

NOTE: In case of multiple iterations of this procedure, the generic test procedures in TS 36.508 Tables 4.5.3.3-1 and 4.5.4.3-1 are performed between each iteration to bring the UE back to state Loopback Activated (state 4).

12.1.1.3.2 Test procedure sequence

Table 12.1.1.3.2-1: Main behaviour

St	Procedure	Message Sequence		TP	Verdict
		U - S	Message		
1	The SS ignores scheduling requests and does not allocate any uplink grant.	-	-	-	-
2	The SS transmits a PDCP SDU of size 40 bytes on each configured AM DRB and a PDCP SDU of size 40 bytes on each configured UM DRB in the same TTI	<--	PDCP SDUs	-	-
2A	SS respond to any scheduling request from the UE by an UL Grant of 32 bits. (Note 1)	<--	(UL Grant, 32 bits)	-	-
3	SS waits until UE transmit a BSR with 'Buffer size' field set to value indicating that all data received in step 2 is pending for transmission.	-	-	-	-
4	After 100ms SS transmits an UL grants to enable UE to return all pending data in one TTI	<--	(UL grant)	-	-
5	Check: Does UE transmit a PDCP SDU on each configure AM and UM DRB of the same size and content as transmitted by the SS in step 2?	-->	PDCP SDUs	1,2	P
5A	The SS transmits an OPEN UE TEST LOOP message to exit the UE test loop mode.	<--	RRC: <i>DLInformationTransfer</i> TC: OPEN UE TEST LOOP	-	-
5B	The UE transmits an OPEN UE TEST LOOP COMPLETE message.	-->	RRC: <i>ULInformationTransfer</i> TC: OPEN UE TEST LOOP COMPLETE	-	-
6	The SS releases the connection.	-	-	-	-
Note 1: 32 bits enables UE to transmit a MAC PDU with a MAC BSR header and a Short BSR (1 bytes) or a Long BSR (3 byte).					

12.1.1.3.3 Specific Message Contents

Table 12.1.1.3.3-1: PDCP-Config-DRB-UM (preamble: Table 4.5.3.3-1, step 8)

Derivation Path: 36.508 clause 4.8.2.1.2.1-1			
Information Element	Value/remark	Comment	Condition
PDCP-Config-DRB-UM ::= SEQUENCE {			
discardTimer	ms300		

12.1.2 Generic E-UTRA radio bearer test procedure / MIMO configured

12.1.2.1 Test Purpose (TP)

(1)

```

with { UE in E-UTRA RRC_CONNECTED state with a "n x AM DRB + m x UM DRB" radio bearer combination
established and physical layer configured for MIMO transmission}
ensure that {
  when { UE receives PDCP SDUs from one or more logical channels multiplexed on transport block 1
and transport block 2 within the same TTI }
  then { UE forward the received PDCP SDUs to upper layer }
}

```

(2)

```

with { UE in E-UTRA RRC_CONNECTED state with a "n x AM DRB + m x UM DRB" radio bearer combination
established }
ensure that {
  when { UE has pending data in the transmission buffer corresponding to two complete PDCP SDUs on
each configured AM and UM DRB and UE receives an UL Grant allowing UE to transmit all pending data }
  then { UE transmits two PDCP SDUs on each configured AM and UM DRB }
}

```

12.1.2.2 Conformance requirements

References: The conformance requirements covered in the present TC are specified in: 3GPP TS 36-series Layer 1, Layer 2 and Layer 3 core specifications.

12.1.2.3 Test description

12.1.2.3.1 Pre-test conditions

System Simulator

- Cell 1 (MIMO)

UE:

- None

Preamble

- The UE is in state Loopback Activated (state 4) according to [18] using condition 2TX to configure MIMO.
- Radio bearer for combination SRB1 and SRB2 for n x AM DRB + m x UM DRB is used where n and m are specified in the test case.

12.1.2.3.2 Test procedure sequence

Table 12.1.2.3.2-1: Main behaviour

St	Procedure	Message Sequence		TP	Verdict
		U - S	Message		
1	The SS ignores scheduling requests and does not allocate any uplink grant.	-	-	-	-
2	The SS transmits two PDCP SDUs of size 40 bytes on each configured AM DRB and two PDCP SDUs of size 40 bytes on each configured UM DRB in the same TTI. The PDCP SDUs are multiplexed on transport block 1 and 2 based on logical channel priority with data from higher MAC logical channel priority mapped to transport block 1. If more than one DRB have same logical channel priority then data from DRB with lower DRB-ID value gets mapped on transport block 1.	<--	PDCP SDUs	-	-
2a	SS respond to any scheduling request from the UE by an UL Grant of 32 bits. (Note 1)	<--	(UL Grant, 32 bits)	-	-
3	SS waits until UE transmit a BSR with 'Buffer size' field set to value indicating that all data received in step 2 is pending for transmission.	-	-	-	-
4	After 100ms SS transmits an UL grants to enable UE to return all pending data in one TTI	-	-	-	-
5	Check: Does UE transmit two PDCP SDUs on each configured AM and UM DRB of the same size and content as transmitted by the SS in step 2?	-->	PDCP SDUs	1,2	P
6	The SS releases the connection	-	-	-	-
Note 1: 32 bits enables UE to transmit a MAC PDU with a MAC BSR header and a Short BSR (1 bytes) or a Long BSR (3 byte).					

12.1.2.3.3 Specific Message Contents

Table 12.1.2.3.3-1: PDCP-Config-DRB-UM (preamble: Table 4.5.3.3-1, step 8)

Derivation Path: 36.508 clause 4.8.2.1.2.1-1			
Information Element	Value/remark	Comment	Condition
PDCP-Config-DRB-UM ::= SEQUENCE {			
discardTimer	ms300		

12.2 MIMO not configured

12.2.1 Data transfer of E-UTRA radio bearer combinations 1, 3, 6 and 9

12.2.1.1 Test Purpose (TP)

See 12.1.1.1

12.2.1.2 Conformance requirements

See 12.1.1.2

12.2.1.3 Test description

12.2.1.3.1 Pre-test conditions

System Simulator

- See 12.1.1.3

UE:

- See 12.1.1.3

Preamble

- The number of AM data radio bearers (n) and UM data radio bearers (m) for each execution is specified in table 12.2.1.3.1-1.

Table 12.2.1.3.1-1: Test parameters (m,n) for each execution (k)

Execution k	Number of AM DRBs n	Number of UM DRBs m	Radio bearer combination
1	1	-	1: SRB1 and SRB2 for DCCH + 1xAM DRB
2	2	-	3: SRB1 and SRB2 for DCCH + 2xAM DRB
3	3	-	6: SRB1 and SRB2 for DCCH + 3xAM DRB
4	4	-	9: SRB1 and SRB2 for DCCH + 4xAM DRB

12.2.1.3.2 Test procedure sequence

Table 12.2.1.3.2-1: Main behaviour

St	Procedure	Message Sequence		TP	Verdict
		U - S	Message		
	EXCEPTION: Step 1 is repeated for execution counter k=1 to 4	-	-	-	-
1	Generic test procedure in 12.1.1 is executed for execution k with number of AM DRB (n) and number of UM DRB (m) as specified in table 12.2.1.3.1-1.	-	-	-	-

12.2.1.3.3 Specific Message Contents

None

12.2.2 Data transfer of E-UTRA radio bearer combinations 2,4,7 and 10

12.2.2.1 Test Purpose (TP)

See 12.1.1.1

12.2.2.2 Conformance requirements

See 12.1.1.2

12.2.2.3 Test description

12.2.2.3.1 Pre-test conditions

System Simulator

- See 12.1.1.3

UE:

- See 12.1.1.3

Preamble

- The number of AM data radio bearers (n) and UM data radio bearers (m) for each execution is specified in table 12.2.2.3.1-1.

Table 12.2.2.3.1-1: Test parameters (m,n) for each execution (k)1

Execution k	Number of AM DRBs n	Number of UM DRBs m	Radio bearer combination
1	1	1	2: SRB1 and SRB2 for DCCH + 1xAM DRB + 1xUM DRB
2	2	1	4: SRB1 and SRB2 for DCCH + 2xAM DRB + 1xUM DRB
3	3	1	7: SRB1 and SRB2 for DCCH + 3xAM DRB + 1xUM DRB
4	4	1	10: SRB1 and SRB2 for DCCH + 4xAM DRB + 1xUM DRB

12.2.2.3.2 Test procedure sequence

Table 12.2.2.3.2-1: Main behaviour

St	Procedure	Message Sequence		TP	Verdict
		U - S	Message		
	EXCEPTION: Step 1 is repeated for execution counter k=1 to 4	-	-	-	-
1	Generic test procedure in 12.1.1 is executed for execution k with number of AM DRB (n) and number of UM DRB (m) as specified in table 12.2.2.3.1-1.	-	-	-	-

12.2.2.3.3 Specific Message Contents

None

12.2.3 Data transfer of E-UTRA radio bearer combinations 5,8,11 and 12

12.2.3.1 Test Purpose (TP)

See 12.1.1.1

12.2.3.2 Conformance requirements

See 12.1.1.2

12.2.3.3 Test description

12.2.3.3.1 Pre-test conditions

System Simulator

- See 12.1.1.3

UE:

- See 12.1.1.3

Preamble

- The number of AM data radio bearers (n) and UM data radio bearers (m) for each execution is specified in table 12.2.3.3.1-1.

Table 12.2.3.3.1-1: Test parameters (m,n) for each execution (k)

Execution K	Number of AM DRBs n	Number of UM DRBs m	Radio bearer combination
1	2	2	5: SRB1 and SRB2 for DCCH + 2xAM DRB + 2xUM DRB
2	3	2	8: SRB1 and SRB2 for DCCH + 3xAM DRB + 2xUM DRB
3	4	2	11: SRB1 and SRB2 for DCCH + 4xAM DRB + 2xUM DRB
4	5	3	12: SRB1 and SRB2 for DCCH + 5xAM DRB + 3xUM DRB

12.2.3.3.2 Test procedure sequence

Table 12.2.3.3.2-1: Main behaviour

St	Procedure	Message Sequence		TP	Verdict
		U - S	Message		
	EXCEPTION: Step 1 is repeated for execution counter k=1 to 4	-	-	-	-
1	Generic test procedure in 12.1.1 is executed for execution k with number of AM DRB (n) and number of UM DRB (m) as specified in table 12.2.3.3.1-1.	-	-	-	-

12.2.3.3.3 Specific Message Contents

None

12.2.4 Data transfer of E-UTRA radio bearer combination 13

12.2.4.1 Test Purpose (TP)

See 12.1.1.1

12.2.4.2 Conformance requirements

See 12.1.1.2

12.2.4.3 Test description

12.2.4.3.1 Pre-test conditions

System Simulator

- See 12.1.1.3

UE:

- See 12.1.1.3

Preamble

- The number of AM data radio bearers (n) and UM data radio bearers (m) is specified in table 12.2.4.3.1-1.

Table 12.2.4.3.1-1: Test parameters (m,n) for execution (k)

Execution k	Number of AM DRBs n	Number of UM DRBs m	Radio bearer combination
1	8	0	13: SRB1 and SRB2 for DCCH + 8xAM DRB

12.2.4.3.2 Test procedure sequence

Table 12.2.4.3.2-1: Main behaviour

St	Procedure	Message Sequence		TP	Verdict
		U - S	Message		
1	Generic test procedure in 12.1.1 is executed for execution 1 with number of AM DRB (n) and number of UM DRB (m) as specified in table 12.2.4.3.1-1.	-	-	-	-

12.2.4.3.3 Specific Message Contents

None

12.3 MIMO configured

12.3.1 Data transfer of E-UTRA radio bearer combinations 1,3,6 and 9 / MIMO

12.3.1.1 Test Purpose (TP)

See 12.1.2.1

12.3.1.2 Conformance requirements

See 12.1.2.2

12.3.1.3 Test description

12.3.1.3.1 Pre-test conditions

System Simulator

- See 12.1.2.3

UE:

- See 12.1.2.3

Preamble

- The number of AM data radio bearers (n) and UM data radio bearers (m) for each execution is specified in table 12.3.1.3.1-1.

Table 12.3.1.3.1-1: Test parameters (m,n) for each execution (k)

Execution k	Number of AM DRBs n	Number of UM DRBs m	Radio bearer combination
1	1	-	1: SRB1 and SRB2 for DCCH + 1xAM DRB
2	2	-	3: SRB1 and SRB2 for DCCH + 2xAM DRB
3	3	-	6: SRB1 and SRB2 for DCCH + 3xAM DRB
4	4	-	9: SRB1 and SRB2 for DCCH + 4xAM DRB

12.3.1.3.2 Test procedure sequence

Table 12.3.1.3.2-1: Main behaviour

St	Procedure	Message Sequence		TP	Verdict
		U - S	Message		
	EXCEPTION: Step 1 is repeated for execution counter k=1 to 4	-	-	-	-
1	Generic test procedure in 12.1.2 is executed for execution k with number of AM DRB (n) and number of UM DRB (m) as specified in table 12.3.1.3.1-1.	-	-	-	-

12.3.1.3.3 Specific Message Contents

None

12.3.2 Data transfer of E-UTRA radio bearer combinations 2,4,7 and 10 / MIMO

12.3.2.1 Test Purpose (TP)

See 12.1.2.1

12.3.2.2 Conformance requirements

See 12.1.2.2

12.3.2.3 Test description

12.3.2.3.1 Pre-test conditions

System Simulator

- See 12.1.2.3

UE:

- See 12.1.2.3

Preamble

- The number of AM data radio bearers (n) and UM data radio bearers (m) for each execution is specified in table 12.3.2.3.1-1.

Table 12.3.2.3.1-1: Test parameters (m,n) for each execution (k)

Execution k	Number of AM DRBs n	Number of UM DRBs M	Radio bearer combination
1	1	1	2: SRB1 and SRB2 for DCCH + 1xAM DRB + 1xUM DRB
2	2	1	4: SRB1 and SRB2 for DCCH + 2xAM DRB + 1xUM DRB
3	3	1	7: SRB1 and SRB2 for DCCH + 3xAM DRB + 1xUM DRB
4	4	1	10: SRB1 and SRB2 for DCCH + 4xAM DRB + 1xUM DRB

12.3.2.3.2 Test procedure sequence

Table 12.3.2.3.2-1: Main behaviour

St	Procedure	Message Sequence		TP	Verdict
		U - S	Message		
	EXCEPTION: Step 1 is repeated for execution counter k=1 to 4	-	-	-	-
1	Generic test procedure in 12.1.2 is executed for execution k with number of AM DRB (n) and number of UM DRB (m) as specified in table 12.3.2.3.1-1.	-	-	-	-

12.3.2.3.3 Specific Message Contents

None

12.3.3 Data transfer of E-UTRA radio bearer combinations 5,8,11 and 12 / MIMO

12.3.3.1 Test Purpose (TP)

See 12.1.2.1

12.3.3.2 Conformance requirements

See 12.1.2.2

12.3.3.3 Test description

12.3.3.3.1 Pre-test conditions

System Simulator

- See 12.1.2.3

UE:

- See 12.1.2.3

Preamble

- The number of AM data radio bearers (n) and UM data radio bearers (m) for each execution is specified in table 12.3.3.3.1-1.

Table 12.3.3.3.1-1: Test parameters (m,n) for each execution (k)

Execution K	Number of AM DRBs n	Number of UM DRBs m	Radio bearer combination
1	2	2	5: SRB1 and SRB2 for DCCH + 2xAM DRB + 2xUM DRB
2	3	2	8: SRB1 and SRB2 for DCCH + 3xAM DRB + 2xUM DRB
3	4	2	11: SRB1 and SRB2 for DCCH + 4xAM DRB + 2xUM DRB
4	5	3	12: SRB1 and SRB2 for DCCH + 5xAM DRB + 3xUM DRB

12.3.3.3.2 Test procedure sequence

Table 12.3.3.3.2-1: Main behaviour

St	Procedure	Message Sequence		TP	Verdict
		U - S	Message		
	EXCEPTION: Step 1 is repeated for execution counter k=1 to 4	-	-	-	-
1	Generic test procedure in 12.1.2 is executed for execution k with number of AM DRB (n) and number of UM DRB (m) as specified in table 12.3.3.3.1-1.	-	-	-	-

12.3.3.3.3 Specific Message Contents

None

12.3.4 Data transfer of E-UTRA radio bearer combination 13 / MIMO

12.3.4.1 Test Purpose (TP)

See 12.1.2.1

12.3.4.2 Conformance requirements

See 12.1.2.2

12.3.4.3 Test description

12.3.4.3.1 Pre-test conditions

System Simulator

- See 12.1.2.3

UE:

- See 12.1.2.3

Preamble

- The number of AM data radio bearers (n) and UM data radio bearers (m) is specified in table 12.3.4.3.1-1.

Table 12.3.4.3.1-1: Test parameters (m,n) for each execution (k)

Execution k	Number of AM DRBs n	Number of UM DRBs m	Radio bearer combination
1	8	0	13: SRB1 and SRB2 for DCCH + 8xAM DRB

12.3.4.3.2 Test procedure sequence

Table 12.3.4.3.2-1: Main behaviour

St	Procedure	Message Sequence		TP	Verdict
		U - S	Message		
1	Generic test procedure in 12.1.2 is executed for execution 1 with number of AM DRB (n) and number of UM DRB (m) as specified in table 12.3.4.3.1-1.	-	-	-	-

12.3.4.3.3 Specific Message Contents

None

13 Multi layer Procedures

13.1 Call setup

13.1.1 Activation and deactivation of additional data radio bearer in E-UTRA

13.1.1.1 Test Purpose (TP)

(1)

```
with { UE has a default EPS bearer context and dedicated EPS bearer context active and the
associated DRBs are established }
ensure that {
  when { UE receives downlink data on the radio bearer associated with the default or the dedicated
EPS bearer context }
    then { UE delivers the downlink data to upper layers }
}
```

(2)

```
with { UE has a default EPS bearer context and dedicated EPS bearer context active and the
associated DRBs are established }
ensure that {
  when { uplink data are submitted for transmission }
    then { UE transmits the uplink data on the radio bearer associated with the default EPS bearer
context or the dedicated EPS bearer context according to configured TFT}
}
```

(3)

```
with { UE has a default EPS bearer context and the dedicated EPS bearer context was deactivated }
ensure that {
  when { UE receives downlink data on the radio bearer associated with the default EPS bearer
context }
    then { UE delivers the downlink data to upper layers }
}
```

(4)

```
with { UE has a default EPS bearer context and the dedicated EPS bearer context was deactivated }
ensure that {
  when { uplink data are submitted for transmission }
    then { UE transmits the uplink data on the radio bearer associated with the default EPS bearer
context }
}
```

13.1.1.2 Conformance requirements

Same Conformance requirements as in clause 8.2.1.3, 8.2.3.1, 10.2.1 and 10.4.1

13.1.1.3 Test description

13.1.1.3.1 Pre-test conditions

System Simulator:

- Cell 1.

UE:

None.

Preamble:

- The UE is in state Generic RB Established, UE test mode activated (state 3A) according to [18] using the UE TEST LOOP MODE B.

13.1.1.3.2 Test procedure sequence

Table 13.1.1.3.2-1: Main behaviour

St	Procedure	Message Sequence		TP	Verdict
		U - S	Message		
1	SS transmits an <i>RRCCONNECTIONRECONFIGURATION</i> message to establish a data radio bearer. The SS transmits a <i>ACTIVATE DEDICATED EPS BEARER CONTEXT REQUEST</i> message activating a new EPS bearer context. The NAS message is included in a <i>RRCCONNECTIONRECONFIGURATION</i> message.	<--	<i>RRCCONNECTIONRECONFIGURATION</i> NAS: <i>ACTIVATE DEDICATED EPS BEARER CONTEXT REQUEST</i>	-	-
2	The UE transmits a <i>RRCCONNECTIONRECONFIGURATIONCOMPLETE</i> message to confirm the establishment of data radio bearer.	-->	<i>RRCCONNECTIONRECONFIGURATIONCOMPLETE</i>	-	-
3	The UE transmits an <i>ACTIVATE DEDICATED EPS BEARER CONTEXT ACCEPT</i> message.	-->	<i>ULINFORMATIONTRANSFER</i> NAS: <i>ACTIVATE DEDICATED EPS BEARER CONTEXT ACCEPT</i>	-	-
4	The SS closes the UE test loop mode.	-	-	-	-
5	The SS transmits one IP packet to the UE on the DRB associated with the default EPS bearer context.	<--	IP packet	-	-
6	Check: Does the UE loop back the IP packet on the DRB associated with the default EPS bearer context?	-->	IP packet	1,2	P
7	The SS transmits one IP packet to the UE on the DRB associated with the dedicated EPS bearer context.	<--	IP packet	-	-
8	Check: Does the UE loop back the IP packet on the DRB associated with the dedicated EPS bearer context?	-->	IP packet	1,2	P
9	SS transmits an <i>RRCCONNECTIONRECONFIGURATION</i> message to release a data radio bearer. The SS transmits a <i>DEACTIVATE EPS BEARER CONTEXT REQUEST</i> including the EPS bearer identity of the dedicated EPS bearer. The NAS message is included in a <i>RRCCONNECTIONRECONFIGURATION</i> message.	<--	<i>RRCCONNECTIONRECONFIGURATION</i> NAS: <i>DEACTIVATE EPS BEARER CONTEXT REQUEST</i>	-	-
10	The UE transmits an <i>RRCCONNECTIONRECONFIGURATIONCOMPLETE</i> message.	-->	<i>RRCCONNECTIONRECONFIGURATIONCOMPLETE</i>	-	-
11	The UE transmits a <i>DEACTIVATE EPS BEARER CONTEXT ACCEPT</i> .	-->	<i>ULINFORMATIONTRANSFER</i> NAS: <i>DEACTIVATE EPS BEARER CONTEXT ACCEPT</i>	-	-
12	The SS transmits one IP packet to the UE on the DRB associated with the default EPS bearer context.	<--	IP packet	-	-
13	Check: Does the UE loop back the IP packet on the DRB associated with the default EPS bearer context?	-->	IP packet	3, 4	P

13.1.1.3.3 Specific message contents

Table 13.1.1.3.3-1: Message RRCConnectionReconfiguration (step 1, Table 13.1.1.3.2-1)

Derivation Path: 36.508 table 4.6.1-8, condition DRB(1,0)			
Information Element	Value/remark	Comment	Condition
RRCConnectionReconfiguration ::= SEQUENCE {			
criticalExtensions CHOICE {			
c1 CHOICE{			
rrcConnectionReconfiguration-r8 SEQUENCE {			
dedicatedInfoNASList SEQUENCE	1 entry		
(SIZE(1..maxDRB)) OF			
dedicatedInfoNAS [1]	octet string	ACTIVATE DEDICATED EPS BEARER CONTEXT REQUEST according 36.508 table 4.7.3-3	
}			
}			
}			
}			

Table 13.1.1.3.3-2: Message ACTIVATE DEDICATED EPS BEARER CONTEXT REQUEST (step 1, Table 13.1.1.3.2-1)

Derivation path: 36.508 table 4.7.3-3			
Information Element	Value/Remark	Comment	Condition
EPS bearer identity	EBId-1	SS defines a dedicated bearer Id different from default EBId and between 5 and 15.	
Procedure transaction identity	0	"No procedure transaction identity assigned"	
Linked EPS bearer identity	Default EBId	SS re-uses the EPS bearer identity of the default EPS bearer context.	
EPS QoS	According to reference dedicated EPS bearer context #1 - see [18]		
TFT	According to reference dedicated EPS bearer context #1- see [18]		

Table 13.1.1.3.3-3: Message ACTIVATE DEDICATE EPS BEARER CONTEXT ACCEPT (step 3, Table 13.1.1.3.2-1)

Derivation path: 36.508 table 4.7.3-1			
Information Element	Value/Remark	Comment	Condition
EPS bearer identity	EBId-1	Same value as in ACTIVATE DEDICATED EPS BEARER CONTEXT REQUEST	
Procedure transaction identity	0	"No procedure transaction identity assigned"	

Table 13.1.1.3.3-4: Message RRCConnectionReconfiguration (step 9, Table 13.1.1.3.2-1)

Derivation Path: 36.508 table 4.6.1-8			
Information Element	Value/remark	Comment	Condition
RRCConnectionReconfiguration ::= SEQUENCE {			
criticalExtensions CHOICE {			
c1 CHOICE{			
rrcConnectionReconfiguration-r8 SEQUENCE {			
dedicatedInfoNASList SEQUENCE			
(SIZE(1..maxDRB)) OF SEQUENCE {			
DedicatedInfoNAS[1]	DEACTIVATE EPS BEARER CONTEXT REQUEST		
}			
radioResourceConfigDedicated	RadioResourceConfigDe dicated-DRB-RELEASE		
}			
}			
}			
}			

Table 13.1.1.3.3-5: Message RadioResourceConfigDedicated-DRB-RELEASE (step 9, Table 13.1.1.3.2-1)

Derivation Path: 36.331 clause 6.3.2			
Information Element	Value/remark	Comment	Condition
RadioResourceConfigDedicated ::= SEQUENCE {			
srb-ToAddModList	Not present		
drb-ToAddModList	Not present		
drb-ToReleaseList SEQUENCE (SIZE (1..maxDRB)) OF SEQUENCE {	1 entry		
drb-Identity[1]	2		
}			
mac-MainConfig CHOICE { }	Not present		
sps-Config	Not present		
physicalConfigDedicated	Not present		
}			

Table 13.1.1.3.3-6: Message DEACTIVATE EPS BEARER CONTEXT REQUEST (step 9, Table 13.1.1.3.2-1)

Derivation path: 36.508 table 4.7.3-12			
Information Element	Value/Remark	Comment	Condition
EPS bearer identity	EBId-1	Same value as in ACTIVATE DEDICATED EPS BEARER CONTEXT REQUEST of step 1	
Procedure transaction identity	0	No procedure transaction identity assigned	
ESM cause	00100100	"Regular deactivation"	
Protocol configuration options	Not present		

Table 13.1.1.3.3-7: Message DEACTIVATE EPS BEARER CONTEXT REQUEST (step 11, Table 13.1.1.3.2-1)

Derivation path: 36.508 table 4.7.3-11			
Information Element	Value/Remark	Comment	Condition
EPS bearer identity	EBId-1	Same value as in ACTIVATE DEDICATED EPS BEARER CONTEXT REQUEST of step 1	
Procedure transaction identity	0	No procedure transaction identity assigned	

13.1.2 Call setup from E-UTRAN RRC_IDLE / CS fallback to UTRAN with redirection / MO call

13.1.2.1 Test Purpose (TP)

(1)

```
with { the UE is in E-UTRA RRC_IDLE state }
ensure that {
  when { the user initiates a CS voice call }
  then { the UE transmits an EXTENDED SERVICE REQUEST message with Service Type IE set to "mobile
originating CS fallback or 1xCS fallback" }
}
```

(2)

```
with { the UE transmitted an EXTENDED SERVICE REQUEST message with Service Type IE set to "mobile
originating CS fallback or 1xCS fallback" }
ensure that {
  when { the UE receives an RRCConnectionRelease message with redirection to a UMTS cell which
belongs to the LA allocated to the UE during the previous registration procedure in E-UTRAN }
  then { UE establishes a connection to the designated UMTS cell, performs a RA update procedure
and establishes a CS call }
}
```

13.1.2.2 Conformance requirements

The conformance requirements covered in the present TC are specified in: TS 24.301 clauses 5.6.1.1 and TS 24.008, clause 4.5.1.1.

[TS 24.301, clause 5.6.1.1]

...

The UE shall invoke the service request procedure when:

...

- d) the UE in EMM-IDLE or EMM-CONNECTED mode is configured to use CS fallback and has a mobile originating CS fallback request from the upper layer;

[TS 24.008, clause 4.5.1.1]

...

In order to establish an MM connection, the mobile station proceeds as follows:

...

- d) When the MS is IMSI attached for CS services via EMM combined procedures, as described in 3GPP TS 24.301 [120], and the MS is camping on an E-UTRAN cell, the MM sublayer requests EMM to initiate a service request procedure for CS fallback. The MM connection establishment is delayed until the MS changes to a GERAN or UTRAN cell.

If the MS enters a GERAN or UTRAN cell, then the MS shall initiate the MM connection establishment and send a CM SERVICE REQUEST message. If the MS determines that it is in a different location area than the stored location area, the MS shall first initiate a normal location updating procedure or a combined routing area update procedure, depending on Network Mode of Operation. If the location area of the current cell is not available, the MS may initiate a normal location updating procedure directly. The MM connection establishment is delayed until successful completion of the normal location updating or combined routing area update procedure. The MS may perform location area updating procedure instead of combined routing area update procedure in NMO I. If the normal location updating procedure is initiated, the MS shall indicate the "follow-on request pending" in the LOCATION UPDATING REQUEST message.

13.1.2.3 Test description

13.1.2.3.1 Pre-test conditions

System Simulator:

- cell 1 (E-UTRA) and cell 5 (UTRA);
- power levels are constant and as defined in table 13.1.2.3.1-1;
- cell 5 is in NMO 1.
- System information combination 4 as defined in TS 36.508 [18] clause 4.4.3.1 is used in E-UTRA cells.

Table 13.1.2.3.1-1: Cell power levels

	Parameter name	Unit	Cell 1	Cell 5
T0	RS EPRE	dBm/15kHz	-75	
	CPICH_Ec	dBm/3.84 MHz		-70
	P-CCPCH	dBm/1.28 MHz		-72
T1	RS EPRE	dBm/15kHz	Non-suitable "Off"	
	CPICH_Ec	dBm/3.84 MHz		-70
	P-CCPCH	dBm/1.28 MHz		-72

UE:

None.Preamble:

- the UE is in state Registered, Idle Mode (state 2) according to TS 36.508 [18].

13.1.2.3.2 Test procedure sequence

Table 13.1.2.3.2-1: Main behaviour

St	Procedure	Message Sequence		TP	Verdict
		U - S	Message		
1	A CS call is initiated (see Note 1)				
2	The UE transmits an <i>RRCCoalitionRequest</i> message.	-->	<i>RRCCoalitionRequest</i>	-	-
3	The SS transmits an <i>RRCCoalitionSetup</i> message	<--	<i>RRCCoalitionSetup</i>	-	-
4	Check: Does the UE transmit an EXTENDED SERVICE REQUEST message?	-->	EXTENDED SERVICE REQUEST	1	P
5	Void			-	-
6	Void			-	-
7	Void			-	-
8	The SS transmits an <i>RRCCoalitionRelease</i> message indicating redirection to cell 5	<--	<i>RRCCoalitionRelease</i>	-	-
9	The UE transmits an RRC CONNECTION REQUEST with an establishment cause indicating 'Originating Conversational Call'.	-->	RRC CONNECTION REQUEST	-	-
9A	SS adjusts cell levels according to row T1 of table 13.1.2.3.1-1.				
10-27	Check: Does steps 2 to 19 of the generic test procedure in TS 36.508 subclause 6.4.3.7.2 are performed?	-	-	2	-
-	The UE is in end state UTRA CS call (U5).	-	-	-	-
Note 1: The request is assumed to be triggered by AT command D.					
Note 2: Void					

Table 13.1.2.3.2-2: Void

13.1.2.3.3 Specific message contents

Table 13.1.2.3.3-1: SystemInformationBlockType6 for cell 1 (preamble and all steps, table 13.1.2.3.2-1)

Derivation path: 36.508 table 4.4.3.3-5			
Information Element	Value/Remark	Comment	Condition
SystemInformationBlockType6 ::= SEQUENCE {			
carrierFreqListUTRA-FDD SEQUENCE (SIZE (1..maxUTRA-FDD-Carrier)) OF SEQUENCE {			FDD
carrierFreq[n]	Same as cell 5		
cellReselectionPriority[n]	3	Lower than cell 1 priority (priority = 4)	
}			
carrierFreqListUTRA-TDD SEQUENCE (SIZE (1..maxUTRA-TDD-Carrier)) OF SEQUENCE {	1 entry		TDD
carrierFreq[n]	Same as cell 5		
cellReselectionPriority[n]	3	Lower than cell 1 priority (priority = 4)	
}			
}			

Table 13.1.2.3.3-2: EXTENDED SERVICE REQUEST (step 4, table 13.1.2.3.2-1)

Derivation path: 36.508 table 4.7.2-14A			
Information Element	Value/Remark	Comment	Condition
Service type	0000 'mobile originating CS fallback or 1xCS fallback'		
CSFB response	Not present		
EPS bearer context status	Not present or any allowed value		

Table 13.1.2.3.3-3: RRCConnectionRelease (step 8, table 13.1.2.3.2-1)

Derivation path: 36.508 table 4.6.1-15			
Information Element	Value/Remark	Comment	Condition
RRCConnectionRelease ::= SEQUENCE {			
criticalExtensions CHOICE {			
c1 CHOICE {			
rrcConnectionRelease-r8 SEQUENCE {			
redirectedCarrierInfo ::= CHOICE {			
ultra-FDD	Downlink UARFCN of cell 5		FDD
ultra-TDD	Downlink UARFCN of cell 5		TDD
}			
}			
}			
}			

Table 13.1.2.3.3-4: CM SERVICE REQUEST (step 12, table 13.1.2.3.2-1)

Derivation path: 24.008 table 9.2.11			
Information Element	Value/Remark	Comment	Condition
CM service type	0001 'Mobile originating call establishment or packet mode connection establishment'		
Ciphering key sequence number	Any allowed value		
Mobile station classmark	Any allowed value		
Mobile identity			
TMSI	TMSI-1		
Priority	Not present or any allowed value		

Table 13.1.2.3.3-5: Void**Table 13.1.2.3.3-6: ATTACH ACCEPT (Preamble)**

Derivation Path: 36.508 Table 4.7.2-1			
Information Element	Value/remark	Comment	Condition
EPS network feature support	Not present		

13.1.2a Call setup from E-UTRAN RRC_IDLE / CS fallback to UTRAN with redirection including System Information / MO call

13.1.2a.1 Test Purpose (TP)

(1)

```
with { UE in E-UTRA RRC_CONNECTED state }
ensure that {
```

```

when { UE receives an RRCConnectionRelease message with redirection to UTRAN including System
Information }
then { UE uses the received System Information and UE sends an RRC CONNECTION REQUEST message in
the cell which belongs to the frequency indicated in RRCConnectionRelease message }
}

```

13.1.2a.2 Conformance requirements

References: The conformance requirements covered in the present TC are specified in: TS 24.301 clauses 5.6.1.1, TS 24.008, clause 4.5.1.1 and TS 25.331, clause 8.1.1.8.

[TS 24.301, clause 5.6.1.1]

The UE shall invoke the service request procedure when:

...

- d) the UE in EMM-IDLE or EMM-CONNECTED mode is configured to use CS fallback and has a mobile originating CS fallback request from the upper layer;

[TS 24.008, clause 4.5.1.1]

In order to establish an MM connection, the mobile station proceeds as follows:

...

- d) When the MS is IMSI attached for CS services via EMM combined procedures, as described in 3GPP TS 24.301 [120], and the MS is camping on an E-UTRAN cell, the MM sublayer requests EMM to initiate a service request procedure for CS fallback. The MM connection establishment is delayed until the MS changes to a GERAN or UTRAN cell.

If the MS enters a GERAN or UTRAN cell, then the MS shall initiate the MM connection establishment and send a CM SERVICE REQUEST message. If the MS determines that it is in a different location area than the stored location area, the MS shall first initiate a normal location updating procedure or a combined routing area update procedure, depending on Network Mode of Operation. If the location area of the current cell is not available, the MS may initiate a normal location updating procedure directly. The MM connection establishment is delayed until successful completion of the normal location updating or combined routing area update procedure. The MS may perform location area updating procedure instead of combined routing area update procedure in NMO I. If the normal location updating procedure is initiated, the MS shall indicate the "follow-on request pending" in the LOCATION UPDATING REQUEST message.

[TS 25.331, clause 8.1.1.8]

If the UE was redirected from a different RAT:

- 1> if the UE receives the System Information Container message corresponding to a cell, on which UE is camped after a cell selection procedure triggered by the redirection procedure:
 - 2> the UE may store the System Information Container message into variable SYSTEM INFORMATION CONTAINER and use the stored master information block, scheduling blocks and system information blocks in the variable SYSTEM_INFORMATION_CONTAINER until the variable is cleared, and act as if this system information was scheduled on BCCH of this cell.

13.1.2a.3 Test description

13.1.2a.3.1 Pre-test conditions

System Simulator:

- Cell 1 (E-UTRA) and Cell 5 (UTRA);
- power levels are constant and as defined in Table 13.1.2a.3.1-1;
- Cell 5 is in NMO I.
- System information combination 4 as defined in TS 36.508 [18] clause 4.4.3.1 is used in E-UTRA cell.

Table 13.1.2a.3.1-1: Cell power levels

	Parameter name	Unit	Cell 1	Cell 5
T0	RS EPRE	dBm/15kHz	-75	
	CPICH_Ec	dBm/3.84 MHz		-70
	P-CCPCH	dBm/1.28 MHz		-72
T1	RS EPRE	dBm/15kHz	Non-suitable "Off"	
	CPICH_Ec	dBm/3.84 MHz		-70
	P-CCPCH	dBm/1.28 MHz		-72

UE:

None.Preamble:

- the UE is in state Registered, Idle Mode (state 2) on Cell 1 according to TS 36.508 [18].

13.1.2a.3.2 Test procedure sequence

Table 13.1.2a.3.2-1: Main behaviour

St	Procedure	Message Sequence		TP	Verdict
		U - S	Message		
1	A CS call is initiated (see Note 1)	-	-	-	-
2	The UE transmits an <i>RRCCONNECTIONREQUEST</i> message on Cell 1.	-->	<i>RRCCONNECTIONREQUEST</i>	-	-
3	The SS transmits an <i>RRCCONNECTIONSETUP</i> message on Cell 1.	<--	<i>RRCCONNECTIONSETUP</i>	-	-
4	The UE transmits an EXTENDED SERVICE REQUEST message on Cell 1.	-->	EXTENDED SERVICE REQUEST	-	-
5	The SS transmits an <i>RRCCONNECTIONRELEASE</i> message indicating redirection to cell 5 on Cell 1.	<--	<i>RRCCONNECTIONRELEASE</i>	-	-
6	Check: Does the UE transmit an RRC CONNECTION REQUEST message with an establishment cause indicating 'Originating Conversational Call' on Cell 5?	-->	RRC CONNECTION REQUEST	1	P
6A	SS adjusts cell levels according to row T1 of table 13.1.2a.3.1-1.				
7	The SS transmits an RRC CONNECTION SETUP message on Cell 5.	<--	RRC CONNECTION SETUP	-	-
8	The UE transmits an RRC CONNECTION SETUP COMPLETE message on Cell 5.	-->	RRC CONNECTION SETUP COMPLETE	-	-
-	EXCEPTION: In parallel to step 9, the parallel behaviour in Table 13.1.2a.3.2-2 is taking place.	-	-	-	-
9	The UE transmits a CM SERVICE REQUEST message on Cell 5.	-->	CM SERVICE REQUEST	-	-
10	The SS transmits a SECURITY MODE COMMAND message for the PS domain on Cell 5. (see Note 2)	<--	SECURITY MODE COMMAND	-	-
11	The UE transmits a SECURITY MODE COMPLETE message on Cell 5.	-->	SECURITY MODE COMPLETE	-	-
12	The SS transmits a ROUTING AREA UPDATE ACCEPT message not including P-TMSI on Cell 5.	<--	ROUTING AREA UPDATE ACCEPT	-	-
13-21	Steps 8 to 16 of the generic test procedure in TS 34.108 subclause 7.2.3.2 are performed on Cell 5 (the SS performs a SMC procedure and the CS call is set up).	-	-	-	-
-	The UE is in end state UTRA CS call (U5).	-	-	-	-
Note 1: The trigger in step 1 is the same as in the generic procedure in 36.508 clause 6.4.3.5.					
Note 2: A real network will initiate the security mode command procedure for the CS domain immediately after receiving the CM SERVICE REQUEST, but in this test case it was chosen to complete the procedure for PS domain first in order to avoid the possibility of a security mode command procedure running in parallel with another RRC procedure.					

Table 13.1.2a.3.2-2: Parallel behaviour

St	Procedure	Message Sequence		TP	Verdict
		U - S	Message		
1	The UE transmits a ROUTING AREA UPDATE REQUEST message.	-->	ROUTING AREA UPDATE REQUEST	-	-

13.1.2a.3.3 Specific message contents

Table 13.1.2a.3.3-1: SystemInformationBlockType6 for cell 1 (preamble and all steps, Table 13.1.2a.3.2-1)

Derivation path: 36.508 Table 4.4.3.3-5			
Information Element	Value/Remark	Comment	Condition
SystemInformationBlockType6 ::= SEQUENCE {			
carrierFreqListUTRA-FDD SEQUENCE (SIZE (1..maxUTRA-FDD-Carrier)) OF SEQUENCE {			FDD
carrierFreq[n]	Same as cell 5		
cellReselectionPriority[n]	3	Lower than cell 1 priority (priority = 4)	
}			
carrierFreqListUTRA-TDD SEQUENCE (SIZE (1..maxUTRA-TDD-Carrier)) OF SEQUENCE {	1 entry		TDD
carrierFreq[n]	Same as cell 5		
cellReselectionPriority[n]	3	Lower than cell 1 priority (priority = 4)	
}			
}			

Condition	Explanation
FDD	FDD cell environment
TDD	TDD cell environment

Table 13.1.2a.3.3-2: EXTENDED SERVICE REQUEST (step 4, Table 13.1.2a.3.2-1)

Derivation path: 36.508 Table 4.7.2-14A			
Information Element	Value/Remark	Comment	Condition
Service type	'0000'B	'mobile originating CS fallback or 1xCS fallback'	
CSFB response	Not present		
EPS bearer context status	Not present or any allowed value		

Table 13.1.2a.3.3-3: *RRCConnectionRelease* (step 5, Table 13.1.2a.3.2-1)

Derivation path: 36.508 Table 4.6.1-15			
Information Element	Value/Remark	Comment	Condition
RRCConnectionRelease ::= SEQUENCE {			
criticalExtensions CHOICE {			
c1 CHOICE {			
rrcConnectionRelease-r8 SEQUENCE {			
redirectedCarrierInfo CHOICE {			
utra-FDD	Downlink UARFCN of cell 5		FDD
utra-TDD	Downlink UARFCN of cell 5		TDD
}			
nonCriticalExtension SEQUENCE {			
cellInfoList-r9 CHOICE {			
utra-FDD-r9 SEQUENCE {	1 entry		FDD
physCellId-r9[1]	PhysicalCellIdentity of Cell 5		
utra-BCCH-Container-r9[1]	SYSTEM INFORMATION CONTAINER		
}			
utra-TDD-r9 SEQUENCE {	1 entry		TDD
physCellId-r9[1]	PhysicalCellIdentity of Cell 5		
utra-BCCH-Container-r9[1]	SYSTEM INFORMATION CONTAINER		
}			
}			
}			
}			
}			
}			

Condition	Explanation
FDD	FDD cell environment
TDD	TDD cell environment

Table 13.1.2a.3.3-4: SYSTEM INFORMATION CONTAINER (Table 13.1.2a.3.3-3)

Derivation path: 25.331 clause 11.2			
Information Element	Value/Remark	Comment	Condition
mib	See Table 13.1.2a.3.3-5		
sysInfoTypeSB1	See 34.108 6.1.0a		
sysInfoTypeSB2	Not present		
sysInfoType1	See 34.108 6.1.0b		
sysInfoType3	See 34.108 6.1.0b		
sysInfoType5	See 34.108 6.1.0b		
sysInfoType7	See 34.108 6.1.0b		
sysInfoType11	See 34.108 6.1.0b		
sysInfoType11bis	Not present		
sysInfoType12	See 34.108 6.1.0b		

Table 13.1.2a.3.3-5: Master Information Block (Table 13.1.2a.3.3-4)

Derivation Path: 34.108 clause 6.1.0a.3			
Information Element	Value/remark	Comment	Condition
- MIB value tag	1		

Table 13.1.2a.3.3-6: System Information Block type 3 for Cell 5 (preamble and all steps, Table 13.1.2a.3.2-1)

Derivation path: 34.108 clause 6.1.0b			
Information Element	Value/Remark	Comment	Condition
Access Class Barred List			
- Access Class Barred0	barred		
- Access Class Barred1	barred		
- Access Class Barred2	barred		
- Access Class Barred3	barred		
- Access Class Barred4	barred		
- Access Class Barred5	barred		
- Access Class Barred6	barred		
- Access Class Barred7	barred		
- Access Class Barred8	barred		
- Access Class Barred9	barred		
- Access Class Barred10	barred		
- Access Class Barred11	barred		
- Access Class Barred12	barred		
- Access Class Barred13	barred		
- Access Class Barred14	barred		
- Access Class Barred15	barred		

NOTE: To confirm that the UE uses System Information included in *RRConnectionRelease* message, the parameters of System Information included in *RRConnectionRelease* message is intentionally different from the target cell.

Table 13.1.2a.3.3-7: Master Information Block for Cell 5 (preamble and all steps, Table 13.1.2a.3.2-1)

Derivation Path: 34.108 clause 6.1.0a.3			
Information Element	Value/remark	Comment	Condition
- MIB value tag	2		

Table 13.1.2a.3.3-8: CM SERVICE REQUEST (step 9, Table 13.1.2a.3.2-1)

Derivation path: 24.008 Table 9.2.11			
Information Element	Value/Remark	Comment	Condition
CM service type	'0001'B	'Mobile originating call establishment or packet mode connection establishment'	
Ciphering key sequence number	Any allowed value		
Mobile station classmark	Any allowed value		
Mobile identity			
TMSI	TMSI-1		
Priority	Not present or any allowed value		

Table 13.1.2a.3.3-9: ROUTING AREA UPDATE ACCEPT (step 12, Table 13.1.2a.3.2-1)

Derivation path: 24.008 Table 9.4.15			
Information Element	Value/Remark	Comment	Condition
P-TMSI signature	Not present		
Allocated P-TMSI	Not present		

Table 13.1.2a.3.3-10: ATTACH ACCEPT (Preamble)

Derivation Path: 36.508 Table 4.7.2-1			
Information Element	Value/remark	Comment	Condition
EPS network feature support	Not present		

13.1.3 Call setup from E-UTRAN RRC_CONNECTED / CS fallback to UTRAN with Redirection / MT call

13.1.3.1 Test Purpose (TP)

(1)

```
with { UE in E-UTRA RRC_CONNECTED state }
ensure that {
  when { UE receives a DLInformationTransfer message containing a CS SERVICE NOTIFICATION message }
  then { UE transmits an ULInformationTransfer message containing an EXTENDED SERVICE REQUEST
message with Service Type IE set to "mobile terminating CS fallback or 1xCS fallback" }
}
```

(2)

```
with { UE having transmitted an ULInformationTransfer message containing an EXTENDED SERVICE REQUEST
message with Service Type IE set to "mobile terminating CS fallback or 1xCS fallback" }
ensure that {
  when { SS transmits an RRCConnectionRelease message with redirection to a UTRA cell in same
location area and operating in NMO I }
  then { UE tunes to UTRA cell and initiates a CS domain PAGING RESPONSE procedure and a parallel
PS domain RA Update procedure }
}
```

(3)

void

(4)

```
with { UE having transmitted an ULInformationTransfer message containing an EXTENDED SERVICE REQUEST
message with Service Type IE set to "mobile terminating CS fallback or 1xCS fallback" and tuned to
UTRA cell and initiated a RA Update procedure and having pending UL data to send}
ensure that {
  when { UE completes the RA Update procedure }
  then { UE transmits a SERVICE REQUEST to set up PS bearers on UTRA cell }
}
```

(5)

```
with { UE having transmitted an ULInformationTransfer message containing an EXTENDED SERVICE REQUEST
message with Service Type IE set to "mobile terminating CS fallback or 1xCS fallback" and tuned to
UTRA cell and initiated a RA Update procedure and having pending UL data to send}
ensure that {
  when { PS bearers have been set up on UTRA cell }
  then { UE transmits pending UL data }
}
```

13.1.3.2 Conformance requirements

References: The conformance requirements covered in the current TC are those listed in TC 8.1.3.6, plus those specified in: TS 23.272, clause 7.4, and TS 24.301, clause 5.6.2.3.

[TS 23.272, clause 7.4]

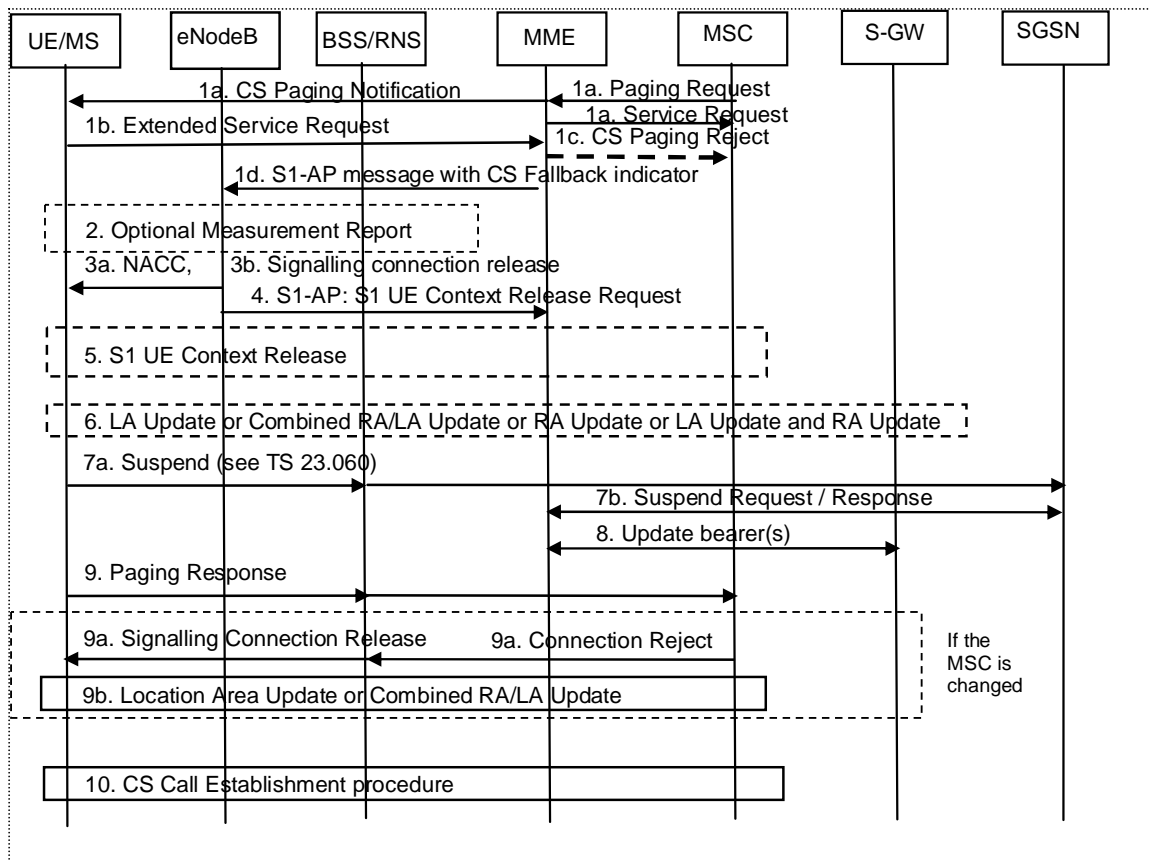

Figure 7.4-1: CS Page in E-UTRAN, Call in GERAN/UTRAN without PS HO

1a. The MSC receives an incoming voice call and responds by sending a Paging Request (IMSI or TMSI, optional Caller Line Identification and Connection Management information, priority indication) to the MME over a SGs interface. The MSC only sends a CS Page for an UE that provides location update information using the SGs interface. In active mode the MME has an established S1 connection and if the MME did not return the "SMS-only" indication to the UE during Attach or Combined TA/LA Update procedures, the MME reuses the existing connection to relay the CS Service Notification to the UE.

If the MME returned the "SMS-only" indication to the UE during Attach or Combined TA/LA Update procedures, the MME shall not send the CS Page to the UE and sends CS Paging Reject towards MSC to stop CS Paging procedure, and this CSFB procedure stops.

The eNB forwards the paging message to the UE. The message contains CN Domain indicator and, if received from the MSC, the Caller Line Identification.

The MME immediately sends the SGs Service Request message to the MSC containing an indication that the UE was in connected mode. The MSC uses this connected mode indication to start the Call Forwarding on No Reply timer for that UE and the MSC should send an indication of user alerting to the calling party. Receipt of the SGs Service Request message stops the MSC retransmitting the SGs interface Paging message.

NOTE 1: The pre-configured policy may be used by UE to avoid being disturbed without Caller Line Identification display and the detailed handling is to be decided by CT WG1 and CT WG6.

NOTE 2: This procedure can also take place immediately after MSC receives MAP_PRN from HSS, if pre-paging is deployed. Caller Line Identification is also provided in the case of pre-paging.

If the MME receives paging request message with priority indication, e.g. eMLPP priority, from the MSC, then the MME processes this message and also the subsequent CS fallback procedure preferentially compared to other normal procedures.

1b. UE sends an Extended Service Request (CS Fallback Indicator, Reject or Accept) message to the MME. Extended Service Request message is encapsulated in RRC and S1-AP messages. CS Fallback Indicator indicates MME to perform CS Fallback. The UE may decide to reject CSFB based on Caller Line Identification.

1c. Upon receiving the Extended Service Request (CSFB, Reject), the MME sends Paging Reject towards MSC to stop CS Paging procedure and this CSFB procedure stops.

1d. The MME sends an S1-AP UE Context Modification Request message to eNodeB that includes a CS Fallback Indicator. This message indicates to the eNB that the UE should be moved to UTRAN/GERAN.

If MME received priority indication in Step 1a, the MME sends S1-AP UE Context Modification Request message to the eNodeB with priority indication, i.e. "CSFB High Priority", as specified in TS 36.413 [35].

1e. The eNB shall reply with S1-AP UE Context Modification Response message.

2. The eNodeB may optionally solicit a measurement report from the UE to determine the target GERAN cell to which the redirection procedure will be performed.

The network performs one of steps 3a or 3b or 3c.

3a. If the UE and network support inter-RAT cell change order to GERAN and the target cell is GERAN:

The eNodeB can trigger an inter-RAT cell change order (optionally with NACC) to a GERAN neighbour cell by sending an RRC message to the UE. The inter-RAT cell change order may contain a CS Fallback Indicator which indicates to UE that the cell change order is triggered due to a CS fallback request. If the inter-RAT cell change order contains a CS Fallback Indicator and the UE fails to establish connection to the target RAT, then the UE considers that CS fallback has failed. Service Request procedure is considered to be successfully completed when cell change order procedure is completed successfully.

3b. If the UE or the network does not support inter-RAT PS handover from E-UTRAN to GERAN/UTRAN nor inter-RAT cell change order to GERAN:

The eNodeB can trigger RRC connection release with redirection to GERAN or UTRAN instead of PS HO or NACC.

3c. If the UE and network support "RRC connection release with redirection and Multi Cell System Information to GERAN/UTRAN":

The eNodeB can trigger RRC connection release with redirection to GERAN or UTRAN and include one or more physical cell identities and their associated System Information.

NOTE 3: Service Request procedure supervision timer shall be sufficiently long considering the optional measurement reporting at step 2. NOTE 4: Service Request procedure supervision timer shall be sufficiently long considering the optional measurement reporting at step 2.

4. The eNodeB sends an S1 UE Context Release Request message to the MME. If the target cell is GERAN and either the target cell or the UE does not support DTM the message includes an indication that the UE is not available for PS service.

5. The MME releases the UE Context in the eNodeB as well as all eNodeB related information in the S-GW as specified in TS 23.401 [2].

In case the Cause indicates that RRC was released due to abnormal conditions, e.g. radio link failure, the MME suspends the EPS bearers (Step 8).

The UE performs one of steps 6a or 6b or 6c and THEN performs step 6d.

6a. (Step 6a is performed if step 3a, Cell Change Order to GERAN, was performed)

The UE moves to the new cell in GERAN. The UE uses the NACC information and/or receives the broadcast System Information and when it has the necessary information to access the GERAN cell, establishes a radio signalling connection.

6b. (Step 6b is performed if step 3b, RRC release with redirection, was performed)

The UE moves to the target RAT, identifies a suitable cell preferably of the same PLMN as received in LAI IE of combined EPS/IMSI Attach/TAU Accept message, receives the broadcast System Information and when it has the necessary information to access GERAN/UTRAN, establishes a radio signalling connection.

- 6c. (Step 6c is performed if step 3c, RRC connection release with redirection and Multi Cell System Information, was performed)

The UE moves to the target RAT and identifies a suitable cell preferably of the same PLMN as received in LAI IE of combined EPS/IMSI Attach/TAU Accept message. The UE uses the NACC information and/or receives the broadcast System Information and when it has the necessary information to access GERAN/UTRAN, the UE establishes the radio signalling connection.

- 6d. If the LA of the new cell is different from the one stored in the UE, the UE shall initiate a Location Area Update or a Combined RA/LA Update as specified in TS 23.060 [3] for the different Network Modes of Operation (NMO). The UE shall set the "CSMT" flag in the LAU Request. The "CSMT" flag is used to avoid missing MT call in roaming retry case. In NMO I, the UE in GERAN may perform LA update over the RR connection instead of combined RA/LA update over the packet access as defined in TS 24.008 [21], clause 4.7.5.2.5, unless enhanced CS establishment in DTM is supported. Further the UE performs any Routing Area Update procedure as specified in TS 23.060 [3].

In NMO I a CSFB UE should perform LAU (and if it does so, shall set the "CSMT" flag) and RAU procedures instead of a Combined RA/LA Update procedure to speed up the CSFB procedure.

When the MSC receives a LA Update Request, it shall check for pending terminating CS calls and, if the "CSMT" flag is set, maintain the CS signalling connection after the Location Area Update procedure for pending terminating CS calls.

7. If the target RAT is GERAN and DTM is not supported, the UE starts the Suspend procedure specified in TS 23.060 [3], clause 16.2.1.1.2. This triggers the SGSN to send a Suspend Request message to the MME. The MME returns a Suspend Response to the SGSN even though GUTI cannot be derived from the P-TMSI and RAI pair.
8. If the S1-AP UE Context Release Request message, received from the eNodeB in step 4, indicates that the UE is not available for the PS services in the target cell, the MME deactivates GBR bearers towards S-GW and P-GW(s) by initiating MME-initiated Dedicated Bearer Deactivation procedure as specified in TS 23.401 [2], and starts the preservation and suspension of non-GBR bearers by sending Suspend Notification message to the S-GW. The S-GW releases all eNodeB related information (address and TEIDs) for the UE, and sends Suspend Notification message to the P-GW(s). The MME stores in the UE context that the UE is in suspended status. All the preserved non-GBR bearers are marked as suspended status in the S-GW and P-GW(s). The P-GW should discard packets if received for the suspended UE.

NOTE 4: Step 8 can not be triggered by the Suspend procedure since the full GUTI can not be derived from the P-TMSI and RAI included in the Suspend Request message.

9. If the UE does not initiate a LAU procedure, the UE responds to the paging by sending a Paging Response message as specified in TS 44.018 [4] or TS 25.331 [7]. When received at the BSS/RNS, the Paging Response is forwarded to the MSC.

NOTE 6: The MSC should be prepared to receive a Paging Response after a relatively long time from when the CS Paging Request was sent (step 1a).

- 9a. If UE is registered in the MSC serving the 2G/3G cell and the UE is allowed in the LA the MSC shall establish the CS call.
- 9b. If the UE is not registered in the MSC that receives the Paging Response or the UE is not allowed in the LA, the MSC shall reject the Paging Response by releasing the A/Iu-cs connection. The BSS/RNS in turn releases the signalling connection for CS domain.
- 9c. The signalling connection release shall trigger the UE to obtain the LAI, which causes the initiation of a Location Area Update or a Combined RA/LA procedure as specified in TS 23.060 [3] for the different Network Modes of Operation (NMO).

The Location Area Update triggers the Roaming Retry for CS Fallback procedure as defined in clause 7.5.

After performing the LAU procedure the MSC shall establish the CS call if the UE is allowed in the LA.

[TS 24.301, clause 5.6.2.3]

The network may initiate the paging procedure for non-EPS services when the UE is IMSI attached for non-EPS services (see example in figure 5.6.2.3.1).

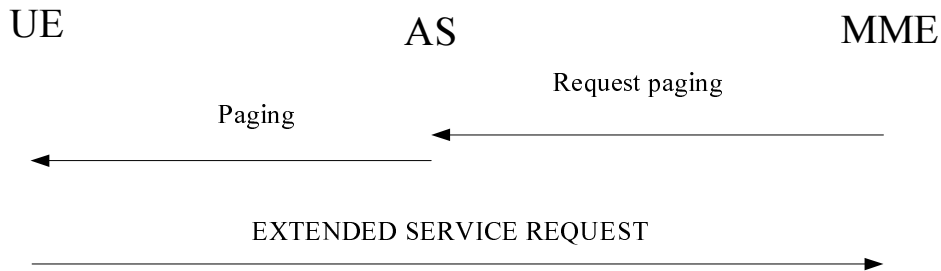

Figure 5.6.2.3.1: Paging procedure for CS fallback to A/Gb or lu mode

To initiate the procedure when no NAS signalling connection exists, the EMM entity in the network requests the lower layer to start paging (see 3GPP TS 36.300 [20], 3GPP TS 36.413 [23]). The paging message includes a CN domain indicator set to "CS" in order to indicate that this is paging for CS fallback.

NOTE: The timer T3413 is not started in the network when the paging procedure is initiated for CS fallback.

To notify the UE about an incoming mobile terminating CS service when a NAS signalling connection exists, the EMM entity in the network shall send a CS SERVICE NOTIFICATION message. This message may also include CS service related parameters (e.g. Calling Line Identification, SS or LCS related parameters).

Upon reception of a paging indication, the UE shall respond with an EXTENDED SERVICE REQUEST. If the paging is received in EMM-IDLE mode, the UE shall respond immediately. If the paging is received as NAS CS NOTIFICATION message in EMM-CONNECTED mode, the UE may request upper layers input i.e. to accept or reject CS fallback before responding with an EXTENDED SERVICE REQUEST. The response is indicated in the CSFB response information element in the EXTENDED SERVICE REQUEST message in both EMM-IDLE and EMM-CONNECTED modes.

13.1.3.3 Test description

13.1.3.3.1 Pre-test conditions

System Simulator:

- 2 cells, one E-UTRA and one UTRA cell and same Location areas but different Routing areas:
 - Cell 1 E-UTRA serving cell
 - Cell 5 suitable neighbour UTRA cell
- The parameters settings and power levels for Cell 1 and Cell 5 are selected according to [18], [5] and Table 13.1.3.3.2-1 so that camping on Cell 1 is guaranteed and no cell re-selection to Cell 5 can take place (utra priority is lower than serving and $S_{Cell 1} > Thresh_{Cell 1,low}$).
- System information combination 4 as defined in TS 36.508 [18] clause 4.4.3.1 is used in E-UTRA cells.

UE:

None.

Preamble:

- The UE is in state Loopback activated (state 4) on cell 1 according to [18] using UE test loop mode B with IP_PDU_delay set according to PIXIT parameter px_TestLoopModeB_Delay.

13.1.3.3.2 Test procedure sequence

Table 13.1.3.3.2-1 shows the cell power levels after the preamble.

Table 13.1.3.3.2-1: Cell power levels

Parameter	Unit	Cell 1	Cell 5	Remark
Cell-specific RS EPRE	dBm/15kHz	-75	-	The power levels are such that camping on Cell 1 is guaranteed.
CPICH_Ec (UTRA FDD)	dBm/3.84 MHz	-	-70	
PCCPCH_Ec (UTRA LCR TDD)	dBm/1.28 MHz	-	-72	

Table 13.1.3.3.2-2: Main behaviour

St	Procedure	Message Sequence		TP	Verdict
		U - S	Message		
1	The SS transmits one IP packet to the UE on the DRB associated with the default EPS bearer context on Cell 1.	<--	IP packet	-	-
2	The SS transmits a <i>DLInformationTransfer</i> message on Cell 1 containing a CS SERVICE NOTIFICATION message.	<--	<i>DLInformationTransfer</i> NAS: CS SERVICE NOTIFICATION	-	-
-	EXCEPTION: Step 3a1 describes behaviour that depends on the UE capability; the "lower case letter" identifies a step sequence that takes place if a capability is supported.	-	-	-	-
3a1	IF the UE needs to request upper layer input before accepting the CS fallback, the incoming CS call is accepted at the UE through MMI or AT command.	-	-	-	-
4	Check: Does the UE transmit an <i>ULInformationTransfer</i> message containing an EXTENDED SERVICE REQUEST with Service Type IE set to "mobile terminating CS fallback or 1xCS fallback" on Cell 1?	-->	<i>ULInformationTransfer</i> NAS: EXTENDED SERVICE REQUEST	1	P
5	The SS transmits an <i>RRCCONNECTIONRelease</i> message on Cell 1 with IE <i>redirectionInformation</i> including <i>UTRA-CarrierFreq</i> of Cell 5.	<--	<i>RRCCONNECTIONRelease</i>	-	-
6	Check: Does the UE transmit an RRC CONNECTION REQUEST message with Establishment cause 'Registration' or 'Terminating Conversational Call'?	-->	RRC CONNECTION REQUEST	2	P
6A 1	The SS transmits an RRC CONNECTION SETUP message.	<--	RRC CONNECTION SETUP	-	-
6A 2	The UE transmits an RRC CONNECTION SETUP COMPLETE message.	-->	RRC CONNECTION SETUP COMPLETE	-	-
7- 11	Void	-	-	-	-
-	EXCEPTION: In parallel to the events described in steps 12 to 13 A11, the steps specified in Table 13.1.3.3.2-3 shall take place.	-	-	-	-
12	Check: Does the UE transmit a PAGING RESPONSE on Cell 5?	-->	PAGING RESPONSE	2	P
13 A1- 13 A1 1	Steps 7 to 17 of the generic test procedure in TS 34.108 subclause 7.2.3.1 are performed on Cell 5. NOTE: Mobile terminating CS call is set up.	-	-	-	-
14	The SS transmits a SECURITY MODE COMMAND message for the PS domain on Cell 5. See Note.	<--	SECURITY MODE COMMAND	-	-
15	The UE transmits a SECURITY MODE COMPLETE message on Cell 5.	-->	SECURITY MODE COMPLETE	-	-
16	The SS transmits a ROUTING AREA UPDATE ACCEPT message on Cell 5.	<--	ROUTING AREA UPDATE ACCEPT	-	-
17	The UE transmits a ROUTING AREA UPDATE COMPLETE message on Cell 5.	-->	ROUTING AREA UPDATE COMPLETE	-	-
18	Check: Does the UE transmit a SERVICE REQUEST message on Cell 5?	-->	SERVICE REQUEST	4	P
18 A	The SS transmits a SERVICE ACCEPT message on Cell 5	<--	SERVICE ACCEPT	-	-
19- 20	Steps 11 to 12 of the generic test procedure in TS 34.108 subclause 7.2.4.2 are performed on Cell 5. NOTE: Mobile originating packet switched session is set up.	-	-	-	-
21	Check: Does the UE loop back the IP packet received in Step 1 on the RAB associated with	-->	IP packet	5	P

the PDP context active on Cell 5?			
Note: A real network will initiate the security mode command procedure for the PS domain immediately after receiving the ROUTING AREA UPDATE REQUEST, but in this test case it was chosen to complete the procedure for CS domain first in order to avoid the possibility of a security mode command procedure running in parallel with another RRC procedure.			

Table 13.1.3.3.2-3: Parallel behaviour

St	Procedure	Message Sequence		TP	Verdict
		U - S	Message		
0A – 0E	Void	-		-	-
1	The UE transmits a ROUTING AREA UPDATE REQUEST message on Cell 5.	-->	ROUTING AREA UPDATE REQUEST	-	-
2	Void			-	-
3	Void			-	-
4-5	Void			-	-
6	Void			-	-

Table 13.1.3.3.2-4: Void

Table 13.1.3.3.2-5: Void

13.1.3.3.3 Specific message contents

Table 13.1.3.3.3-1: Void

Table 13.1.3.3.3-1A: ACTIVATE TEST MODE (preamble)

Derivation Path: 36.508, Table 4.7A-3, condition UE TEST LOOP MODE B			
Information Element	Value/remark	Comment	Condition
UE test loop mode B LB setup			
IP PDU delay	Set according to PIXIT parameter px_TestLoopModeB_Delay		

Table 13.1.3.3.3-2: SystemInformationBlockType6 for cell 1 (preamble and all steps, Table 13.1.3.3.2-2)

Derivation Path: 36.508 Table 4.4.3.3-5			
Information Element	Value/remark	Comment	Condition
SystemInformationBlockType6 ::= SEQUENCE {			
carrierFreqListUTRA-FDD SEQUENCE (SIZE (1..maxUTRA-FDD-Carrier)) OF SEQUENCE {			UTRA-FDD
carrierFreq[n]	Same downlink UARFCN as used for cell 5		
cellReselectionPriority[n]	3	Lower priority than E-UTRA	
}			
carrierFreqListUTRA-TDD SEQUENCE (SIZE (1..maxUTRA-TDD-Carrier)) OF SEQUENCE {			UTRA-TDD
carrierFreq[n]	Same downlink UARFCN as used for cell 5		
cellReselectionPriority[n]	3	Lower priority than E-UTRA	
}			
}			

Table 13.1.3.3.3-3: DLInformationTransfer (step 2, Table 13.1.3.3.2-2)

Derivation Path: 36.508 Table 4.6.1-3			
Information Element	Value/remark	Comment	Condition
DLInformationTransfer ::= SEQUENCE {			
criticalExtensions CHOICE {			
c1 CHOICE {			
dlInformationTransfer-r8 SEQUENCE {			
dedicatedInfoType CHOICE {			
dedicatedInfoNAS	Set according to 36.508 Table 4.7.2-8A	CS SERVICE NOTIFICATION	
}			
}			
}			
}			

Table 13.1.3.3.3-4: ULInformationTransfer (step 4, Table 13.1.3.3.2-2)

Derivation Path: 36.508 Table 4.6.1-25			
Information Element	Value/remark	Comment	Condition
ULInformationTransfer ::= SEQUENCE {			
criticalExtensions CHOICE {			
c1 CHOICE {			
ulInformationTransfer-r8 SEQUENCE {			
dedicatedInfoType CHOICE {			
dedicatedInfoNAS	Set according to 36.508 Table 4.7.2-14A	EXTENDED SERVICE REQUEST	
}			
}			
}			
}			

Table 13.1.3.3.3-5: Void**Table 13.1.3.3.3-6: RRCConnectionRelease (step 5, Table 13.1.3.3.2-2)**

Derivation Path: 36.508 Table 4.6.1-15			
Information Element	Value/remark	Comment	Condition
RRCConnectionRelease ::= SEQUENCE {			
criticalExtensions CHOICE {			
c1 CHOICE {			
rrcConnectionRelease-r8 SEQUENCE {			
redirectedCarrierInfo ::= CHOICE {			
utra-FDD	Downlink UARFCN of cell 5		UTRA-FDD
utra-TDD	Downlink UARFCN of cell 5		UTRA-TDD
}			
}			
}			

Table 13.1.3.3.3-7: RRC CONNECTION REQUEST (step 6, Table 13.1.3.3.2-2)

Derivation Path: 34.108 clause 9.1.1			
Information Element	Value/remark	Comment	Condition
Establishment cause	Registration or Terminating Conversational Call		

Table 13.1.3.3.3-8: SERVICE REQUEST (step 1, Table 13.1.3.3.2-3)

Derivation Path: 24.008 Table 9.4.20			
Information Element	Value/remark	Comment	Condition
Service type	'001'B	Data	

Table 13.1.3.3.3-9: ATTACH ACCEPT (Preamble)

Derivation Path: 36.508 Table 4.7.2-1			
Information Element	Value/remark	Comment	Condition
EPS network feature support	Not present		

13.1.4 Call setup from E-UTRAN RRC_IDLE / CS fallback to UTRAN with Handover / MT call

13.1.4.1 Test Purpose (TP)

(1)

```
with { UE in E-UTRA RRC_IDLE state }
ensure that {
  when { UE receives a Paging message with CN domain indicator set to "CS" }
  then { UE transmits an ULInformationTransfer message containing an EXTENDED SERVICE REQUEST
message with Service Type IE set to "mobile terminating CS fallback or 1xCS fallback" }
}
```

(2)

```
with { UE having transmitted an ULInformationTransfer message containing an EXTENDED SERVICE REQUEST
message with Service Type IE set to "mobile terminating CS fallback or 1xCS fallback" }
ensure that {
  when { SS transmits a MobilityFromEUTRACCommand message with handover to a UTRA cell in a different
location area and operating in NMO I }
  then { UE transmits a HANDOVER TO UTRAN COMPLETE message on the utra cell and initiates a CS
domain PAGING RESPONSE procedure or LA update procedure and a parallel PS domain RA Update procedure
}
}
```

13.1.4.2 Conformance requirements

References: The conformance requirements covered in the current TC are specified in: TS 23.272, clause 7.2, 7.3, and TS 24.301, clause 5.6.2.3.

[TS 23.272, clause 7.2]

The procedure for Mobile Terminating Call in idle mode is illustrated in figure 7.2-1, in the normal case. Clause 6.6 describes the procedure when the procedure is rejected by the MME.

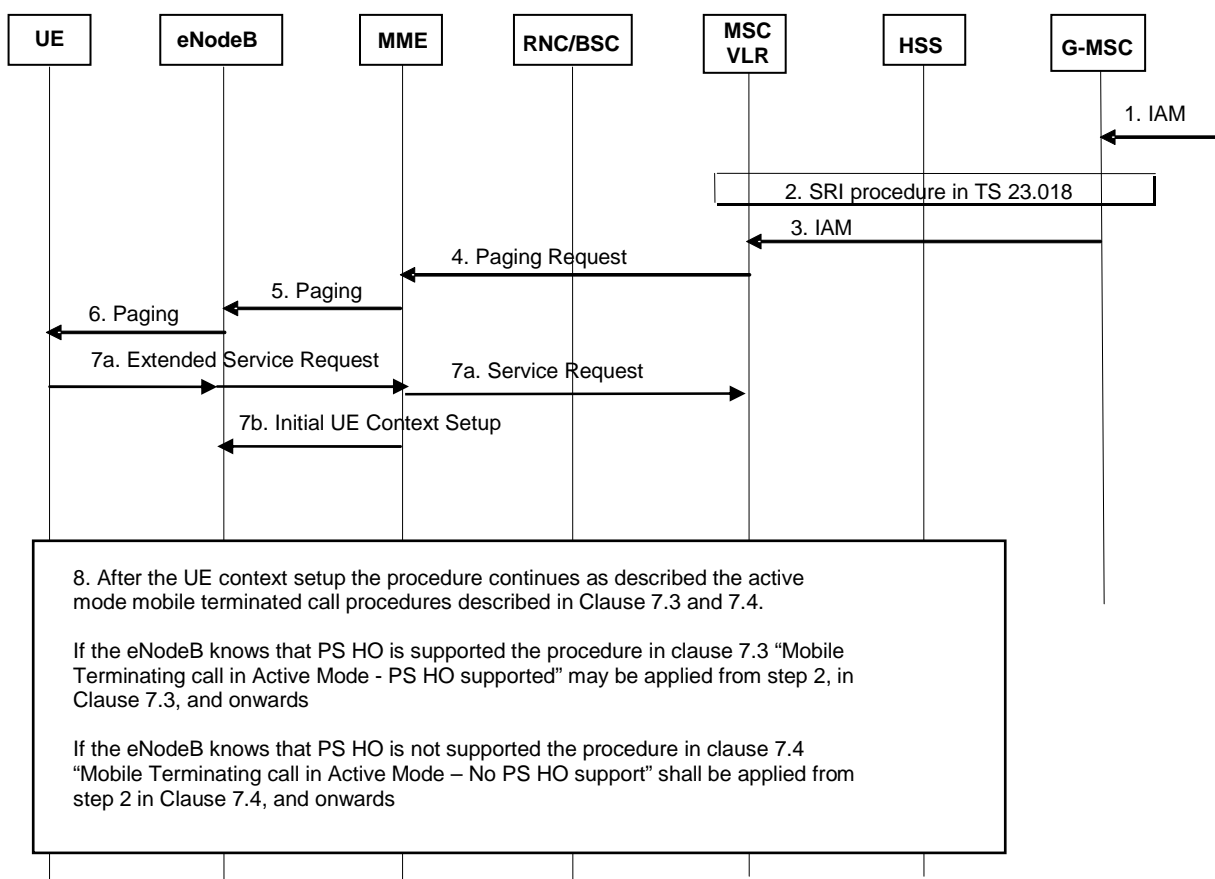

Figure 7.2-1: Mobile Terminating Call in idle mode

1. G-MSC receives IAM.
2. G-MSC retrieves routing information of the terminating UE by Send Routing Info procedures as specified in TS 23.018 [5].
3. G-MSC sends IAM to the MSC on the terminating side as specified in TS 23.018 [5].
4. The MME receives a Paging Request (IMSI, VLR TMSI, Location Information) message from the MSC over a SGs interface. If the TMSI is received from the MSC, it is used by the MME to find the S-TMSI which is used as the paging address on the radio interface. If the IMSI is received from the MSC, the IMSI shall be used as the paging address on the radio interface. If location information is reliably known by MME (i.e. MME stores the list of TAs), the MME shall page the UE in all the TAs. If the MME does not have a stored TA list for the UE, the MME should use the location information received from the MSC to page the UE.

NOTE 1: This procedure takes place before step 3, immediately after MSC receives MAP_PRN from HSS, if pre-paging is deployed.

If the MME receives a Paging Request message for an UE which is considered as detach for EPS services, the MME sends the Paging reject message to the MSC with an appropriate cause value. This rejection triggers the MSC to page the UE over A or Iu-cs interface.

NOTE 2: In case of a CS fallback capable UE in NMO II or III, there is a case where, for example, the MME releases the SGs association due to the UE idle mode mobility while the VLR still maintains the SGs association.

5. If the MME did not return an "SMS-only" indication to the UE during Attach or Combined TA/LA Update procedures, the MME sends a Paging (as specified in TS 23.401 [2]) message to each eNodeB. The Paging message includes a suitable UE Identity (i.e. S-TMSI or IMSI) and a CN Domain Indicator that indicates which domain (CS or PS) initiated the paging message. In this case it shall be set to "CS" by the MME.

If the MME returned the "SMS-only" indication to the UE during Attach or Combined TA/LA Update procedures, the MME shall not send the paging to the eNodeBs and sends Paging Reject towards MSC to stop CS Paging procedure and this CSFB procedure stops.

6. The radio resource part of the paging procedure takes place. The message contains a suitable UE Identity (i.e. S-TMSI or IMSI) and a CN Domain indicator.
- 7a. The UE establishes an RRC connection and sends an Extended Service Request (CS Fallback Indicator) to MME. The UE indicates its S-TMSI in the RRC signalling. The Extended Service Request message is encapsulated in RRC and S1-AP messages. The CS Fallback Indicator indicates to the MME that CS Fallback for this UE is required. The MME sends the SGs Service Request message to the MSC containing an indication that the UE was in idle mode (and hence, for example, that the UE has not received any Calling Line Identification information). Receipt of the SGs Service Request message stops the MSC retransmitting the SGs interface Paging message.

NOTE 3: In order to avoid the calling party experiencing a potentially long period of silence, the MSC may use the SGs Service Request message containing the idle mode indication as a trigger to inform the calling party that the call is progressing.

- 7b. MME sends S1-AP: Initial UE Context Setup (UE capabilities, CS Fallback Indicator, LAI and other parameters specified in TS 23.401 [2]) to indicate the eNodeB to move the UE to UTRAN/GERAN. The registered PLMN for CS domain is identified by the PLMN ID included in the LAI, which is allocated by the MME.

- 7c. The eNodeB shall reply with S1-AP: Initial UE Context Setup Response message.

- 8a. If the eNodeB knows that both the UE and the network support PS handover: The information flow may continue as described in clause 7.3 "Mobile Terminating call in Active Mode - PS HO supported" from step 2, in clause 7.3, and onwards.

- . If the eNodeB knows that either the UE or the network does not support PS handover: The information flow shall continue as described in clause 7.4 "Mobile Terminating call in Active Mode – No PS HO support" from step 2, in clause 7.4, and onwards.

NOTE 4: Even in case both the UE and the network support PS HO, the eNodeB may choose to use a different inter-RAT mobility procedure.

[TS 23.272, clause 7.3]

This flow may be executed when the eNodeB knows that both the UE and the network support PS HO in the normal case. Clause 6.6 describes the procedure when the procedure is rejected by the MME.

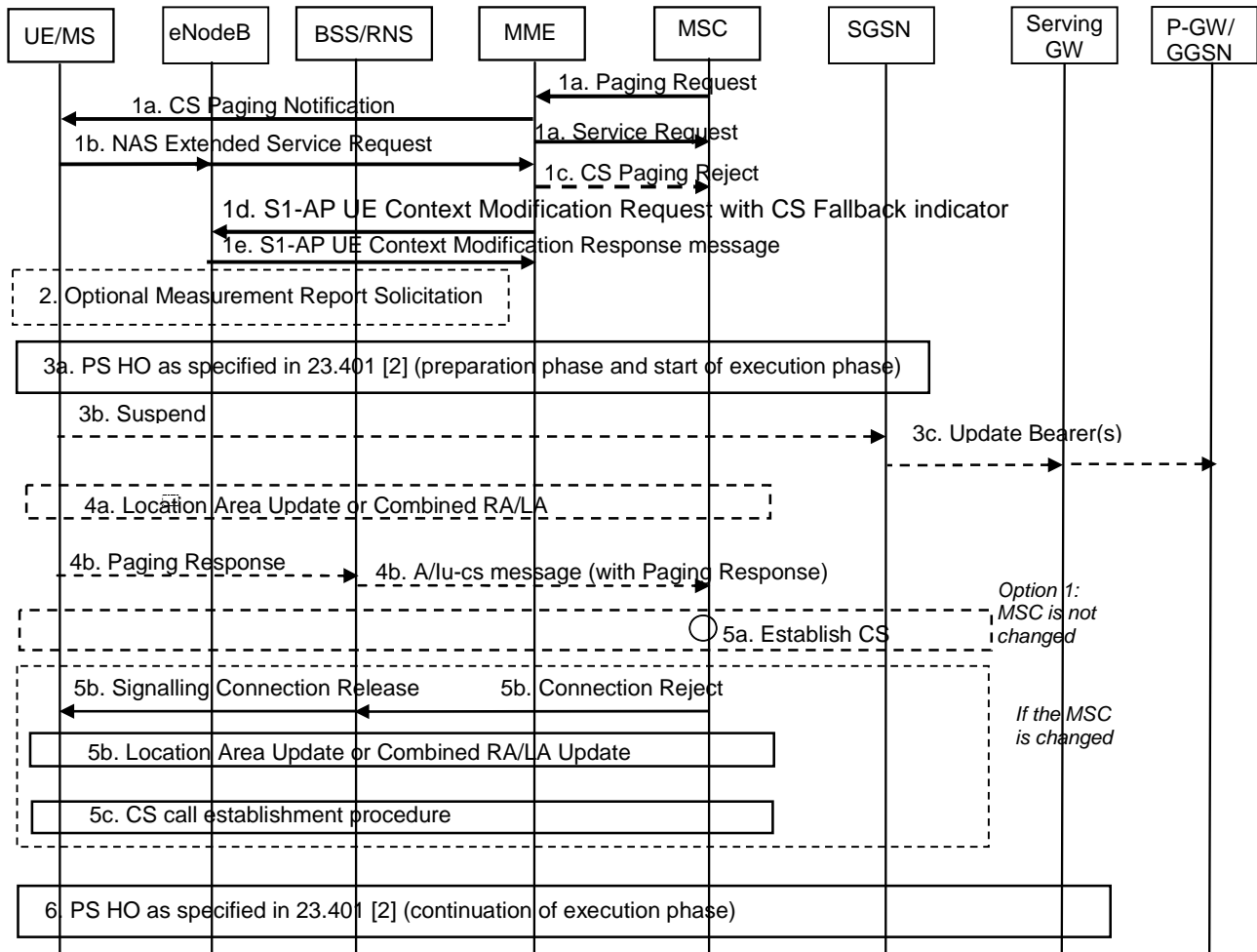

Figure 7.3-1: CS Page in E-UTRAN, Call in GERAN/UTRAN

1a. The MSC receives an incoming voice call and responds by sending a Paging Request (IMSI or TMSI, optional Caller Line Identification and Connection Management information, CS call indicator) to the MME over a SGs interface. The MSC only sends a CS Page for an UE that provides location update information using the SGs interface. In active mode the MME has an established S1 connection and if the MME did not return the "SMS-only" indication to the UE during Attach or Combined TA/LA Update procedures, the MME reuses the existing connection to relay the CS Page to the UE.

If the MME returned the "SMS-only" indication to the UE during Attach or Combined TA/LA Update procedures, the MME shall not send the CS Service Notification to the UE and shall send Paging Reject towards MSC to stop CS Paging procedure, and this CSFB procedure stops.

The eNodeB forwards the paging message to the UE. The message contains CN Domain indicator and, if received from the MSC, the Caller Line Identification.

The MME immediately sends the SGs Service Request message to the MSC containing an indication that the UE was in connected mode. The MSC uses this connected mode indication to start the Call Forwarding on No Reply timer for that UE and the MSC should send an indication of user alerting to the calling party. Receipt of the SGs Service Request message stops the MSC retransmitting the SGs interface Paging message.

NOTE 1: The pre-configured policy may be used by UE to avoid being disturbed without Caller Line Identification display and the detailed handling is to be decided by CT1 and CT6.

NOTE 2: This procedure can also take place immediately after MSC receives MAP_PRN from HSS, if pre-paging is deployed. Caller Line Identification and CS call indicator are also provided in the case of pre-paging.

NOTE 3: In order to avoid the calling party experiencing a potentially long period of silence, the MSC may use the SGs Service Request message as a trigger to inform the calling party that the call is progressing.

- 1b. UE sends an Extended Service Request (CS Fallback Indicator, Reject or Accept) message to the MME. The Extended Service Request message is encapsulated in RRC and S1-AP messages. CS Fallback Indicator indicates to the MME to perform CS Fallback. The UE may decide to reject CSFB based on Caller Line Identification.
- 1c. Upon receiving the Extended Service Request (CSFB, Reject), the MME sends Paging Reject towards MSC to stop CS Paging procedure and this CSFB procedure stops.
- 1d. MME sends an S1-AP UE Context Modification Request (CS Fallback Indicator, LAI) message to eNodeB. This message: indicates to the eNodeB that the UE should be moved to UTRAN/GERAN. The registered PLMN for CS domain is identified by the PLMN ID included in the LAI, which is allocated by the MME.
- 1e. The eNodeB shall reply with S1-AP UE Context Modification Response message.
2. The eNodeB may optionally solicit a measurement report from the UE to determine the target GERAN/UTRAN cell to which PS handover will be performed.
- 3a. The eNodeB triggers PS handover to a GERAN/UTRAN neighbour cell by sending a Handover Required message to MME. The eNodeB selects the target PS handover cell considering the PLMN ID and possibly the LAC for CS domain provided by the MME in step 1d. In the following an inter-RAT handover from E-UTRAN to UTRAN or GERAN as specified in TS 23.401 [2] begins. The eNodeB indicates in the Source RNC to Target RNC Transparent container that PS handover was triggered due to CSFB. The eNodeB also indicates whether CSFB was triggered for emergency purpose. As part of this handover, the UE receives a HO from E-UTRAN Command and tries to connect to a cell in the target RAT. The HO from E-UTRAN Command may contain a CS Fallback Indicator which indicates to UE that the handover was triggered due to a CS fallback request. If the HO from E-UTRAN Command contains a CS Fallback Indicator and the UE fails to establish connection to the target RAT, then the UE considers that CS fallback has failed.

The UE establishes the signalling connection as described in step 4b.

NOTE 4: During the PS HO the SGSN does not create a Gs association with the MSC/VLR.

- 3b. If the target RAT is GERAN and the UE has entered Dedicated Mode, the UE starts the Suspend procedure (see TS 44.018 [4]) unless both the UE and the Target cell support DTM in which case TBF re-establishment may be performed.
- 3c. A Gn/Gp-SGSN that receives the Suspend message from the UE follows the Suspend procedure specified in TS 23.060 [3], clause 16.2.1.1.1.

An S4-SGSN that receives the Suspend message from the UE follows the Suspend procedure specified in TS 23.060 [3]. The S4-SGSN deactivates GBR bearers towards S-GW and P-GW(s) by initiating MS-and SGSN Initiated Bearer Deactivation procedure as specified in TS 23.060 [3], and starts the preservation and suspension of non-GBR bearers by sending Suspend Notification message to the S-GW. The S-GW releases all RNC related information (address and TEIDs) for the UE if Direct Tunnel is established, and sends Suspend Notification message to the P-GW(s). The SGSN stores in the UE context that UE is in suspended status. All the preserved non-GBR bearers are marked as suspended status in the S-GW and P-GW(s). The P-GW should discard packets if received for the suspended UE.
- 4a. If the LA of the new cell is different from the one stored in the UE, the UE shall initiate a Location Area Update or a Combined RA/LA Update procedure as follows:
 - If the network is operating in NMO-I (Network Modes of Operation), the UE should initiate a separate Location Area Update before initiating the RAU procedure instead of a Combined RA/LA Update procedure (to speed up the CSFB procedure); or
 - if the network is operating in NMO-II or NMO-III the UE shall initiate a Location Area Update procedure before initiating the RAU procedure required for PS handover.

The UE shall set the "CSMT" flag in the LAU Request. The "CSMT" flag is used to avoid missing MT call in roaming retry case. Further the UE performs any Routing Area Update procedure as specified in TS 23.060 [3].

The UE may initiate a Location Area Update procedure immediately when the UE is handed over to the target cell i.e. before the UE receives e.g. LAI or NMO information as part of the RAN Mobility Information.

When the MSC receives a LA Update Request, it shall check for pending terminating CS calls and, if the "CSMT" flag is set, maintain the CS signalling connection after the Location Area Update procedure for pending terminating CS calls.

4b. If the UE does not initiate a LAU procedure, it shall respond with a Paging Response message to the MSC as follows:

- If the Target RAT is UTRAN or GERAN Iu mode: The UE establishes a radio signalling connection and responds to the paging by sending an RRC Paging Response as specified in TS 25.331 [7]. The CN Domain Indicator is set to "CS" in the Initial Direct Transfer message.
- If the Target RAT is GERAN A/Gb mode: The UE establishes a radio signalling connection and responds to paging by using the procedures specified in TS 44.018 [4] (i.e. UE requests and is assigned a dedicated channel where it sends a SABM containing a Paging Response to the BSS and the BSS responds by sending a UA). Upon receiving the SABM (containing a Paging Response message) the BSS sends a COMPLETE LAYER 3 INFORMATION message (containing a Paging Response message) to the MSC which indicates CS resources have been allocated in the GERAN cell. If both the UE and the target cell support enhanced CS establishment in DTM (indicated by GERAN system information included within the HO from E-UTRAN Command) an RR connection may be established while in packet transfer mode without release of the packet resources, see TS 43.055 [24]. After the establishment of the main signalling link as described in TS 44.018 [4] the UE enters either Dual Transfer Mode or Dedicated Mode and the CS call establishment procedure completes.

NOTE 5: The BSS should be prepared to receive a Paging Response even when the corresponding Paging Request has not been sent by this BSS.

5a. After performing the LAU procedure or after receiving the Paging Response the MSC shall establish the CS call if the UE is allowed in the LA.

5b. If the UE is not registered in the MSC that receives the Paging Response or the UE is not allowed in the LA, the MSC shall reject the Paging Response message by releasing the A/Iu-CS. The BSC/RNC in turn releases the signalling connection for UTRAN or GERAN CS domain. The signalling connection release shall trigger the UE to obtain the LAI, which causes the initiation of a Location Area Update or a Combined RA/LA procedure as specified in TS 23.060 [3] for the different Network Modes of Operation (NMO).

The Location Area Update triggers the Roaming Retry for CS Fallback procedure as defined in clause 7.5.

5c. After performing the LAU procedure the MSC shall establish the CS call if the UE is allowed in the LA.

6. The UE performs any remaining steps of the inter-RAT handover from E-UTRAN to UTRAN or GERAN as specified in TS 23.401 [2]

With the exception of steps 1a and 1c, above, Call Forwarding (see TS 23.082 [31]) is performed on the basis of the TS 24.008 [21] signalling received on the GERAN/UTRAN cell.

If the UE remains on UTRAN/GERAN after the CS voice call is terminated the UE performs normal mobility management procedures as defined in TS 23.060 [3] and TS 24.008 [21].

[TS 24.301, clause 5.6.2.3]

The network may initiate the paging procedure for CS fallback when the UE is IMSI attached for non-EPS services (see example in figure 5.6.2.3.1).

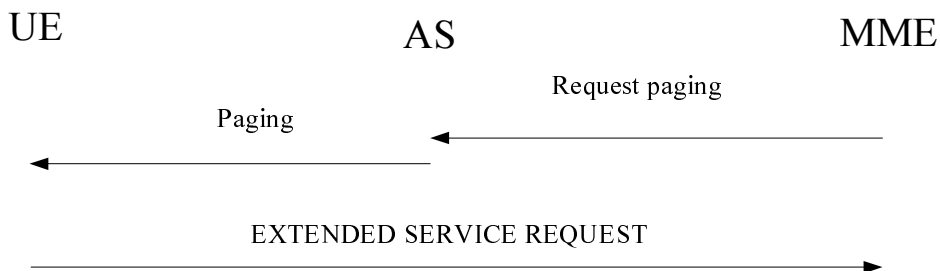

Figure 5.6.2.3.1: Paging procedure for CS fallback to A/Gb or lu mode

To initiate the procedure when no NAS signalling connection exists, the EMM entity in the network requests the lower layer to start paging (see 3GPP TS 36.300 [20], 3GPP TS 36.413 [23]). The EMM entity may provide the lower layer with a list of CSG IDs, including the CSG IDs of both the expired and the not expired subscriptions. If there is a PDN connection for emergency bearer services established, the EMM entity in the network shall not provide the list of CSG IDs to the lower layer. The paging message includes a CN domain indicator set to "CS" in order to indicate that this is paging for CS fallback.

NOTE: The timer T3413 is not started in the network when the paging procedure is initiated for CS fallback.

To notify the UE about an incoming mobile terminating CS service excluding SMS over SGs when a NAS signalling connection exists, the EMM entity in the network shall send a CS SERVICE NOTIFICATION message. This message may also include CS service related parameters (e.g. Calling Line Identification, SS or LCS related parameters).

Upon reception of a paging indication, a UE that is IMSI attached for non-EPS services shall respond with an EXTENDED SERVICE REQUEST. If the paging is received in EMM-IDLE mode, the UE shall respond immediately. If the paging is received as NAS CS NOTIFICATION message in EMM-CONNECTED mode, the UE may request upper layers input i.e. to accept or reject CS fallback before responding with an EXTENDED SERVICE REQUEST. The response is indicated in the CSFB response information element in the EXTENDED SERVICE REQUEST message in both EMM-IDLE and EMM-CONNECTED modes.

[TS 24.008, clause 4.5.1.3.4]

If the MS determines, before sending the response to paging, that it is in a different location area than the stored location area, the MS shall initiate a normal location updating procedure or a combined routing area update procedure first, depending on Network Mode of Operation. The MM connection establishment is delayed until successful completion of the normal location updating or combined routing area update procedure. In A/Gb mode, if the MS is a non DTM MS, or a DTM MS in a cell not supporting DTM, the MS may perform location area updating procedure instead of combined routing area update procedure in NMO I. After the completion of the normal location updating procedure, the MS shall not send the PAGING RESPONSE message.

13.1.4.3 Test description

13.1.4.3.1 Pre-test conditions

System Simulator:

- Cell 1 serving cell
- Cell 5 suitable neighbour cell
- System information combination 4 as defined in TS 36.508 [18] clause 4.4.3.1 is used in E-UTRA cells.

UE:

None.

Preamble:

- The UE is in state Registered, Idle Mode (state 2) on Cell 1 according to [18].

13.1.4.3.2 Test procedure sequence

Table 13.1.4.3.2-1 shows the cell power levels after the preamble.

Table 13.1.4.3.2-1: Time instances of cell power level and parameter changes

	Parameter name	Unit	Cell 1	Cell 5
T0	RS EPRE	dBm/15kHz	-75	
	CPICH_Ec	dBm/3.84 MHz		-70
	P-CCPCH	dBm/1.28 MHz		-72
T1	RS EPRE	dBm/15kHz	Non-suitable "Off"	
	CPICH_Ec	dBm/3.84 MHz		-70
	P-CCPCH	dBm/1.28 MHz		-72

Table 13.1.4.3.2-2: Main behaviour

St	Procedure	Message Sequence		TP	Verdict
		U - S	Message		
1	The SS transmits a <i>Paging</i> message to the UE on Cell 1 using S-TMSI with CN domain indicator set to "CS".	<--	<i>Paging</i>	-	-
-	EXCEPTION: Step 2a1 describes behaviour that depends on the UE capability; the "lower case letter" identifies a step sequence that takes place if a capability is supported.	-	-	-	-
2a1	IF the UE needs to request upper layer input before accepting the CS fallback, the incoming CS call is accepted at the UE through MMI or AT command.	-	-	-	-
3	The UE transmits an <i>RRCCoNNECTIONRequest</i> message on Cell1.	-->	<i>RRCCoNNECTIONRequest</i>	-	-
4	The SS transmits an <i>RRCCoNNECTIONSetup</i> message on Cell1.	<--	<i>RRCCoNNECTIONSetup</i>	-	-
5	Check: Does the UE transmit an <i>RRCCoNNECTIONSetupComplete</i> message containing an EXTENDED SERVICE REQUEST with Service Type IE set to "mobile terminating CS fallback or 1xCS fallback" on Cell 1?	-->	<i>RRCCoNNECTIONSetupComplete</i> NAS: EXTENDED SERVICE REQUEST	1	P
5A	The SS transmits a <i>SecurityModeCommand</i> message on Cell 1.	<--	<i>SecurityModeCommand</i>	-	-
5B	The UE transmits a <i>SecurityModeComplete</i> message on Cell 1.	-->	<i>SecurityModeComplete</i>	-	-
5C	The SS transmits an <i>RRCCoNNECTIONReconfiguration</i> message on Cell 1.	<--	<i>RRCCoNNECTIONReconfiguration</i>	-	-
5D	The UE transmits an <i>RRCCoNNECTIONReconfigurationComplete</i> message on Cell 1.	-->	<i>RRCCoNNECTIONReconfigurationComplete</i>	-	-
5E	The SS transmits a <i>UECapabilityEnquiry</i> message to request UE radio access capability information for E-UTRA and UTRA.	<--	<i>UECapabilityEnquiry</i>	-	-
5F	The UE transmit a <i>UECapabilityInformation</i> message on Cell 1. NOTE: The start-PS values received, should be used to configure ciphering on cell 5.	-->	<i>UECapabilityInformation</i>	-	-
6	The SS transmits a <i>MobilityFromEUTRACommand</i> message on Cell 1 with IE <i>handover</i> .	<--	<i>MobilityFromEUTRACommand</i>	-	-
7-19	Check: Are steps 1 to 11 of the generic test procedure in TS 36.508 subclause 6.4.3.7.5 performed?	-->	HANDOVER TO UTRAN COMPLETE	2	-
20	SS adjusts cell levels according to row T1 of table 13.1.4.3.2-1.				
-	The UE is in end state UTRA CS call (U5).	-	-	-	-

Table 13.1.4.3.2-3: Void

13.1.4.3.3 Specific message contents

Table 13.1.4.3.3-1: Void

Table 13.1.4.3.3-2: SystemInformationBlockType6 for cell 1 (preamble and all steps, Table 13.1.4.3.2-2)

Derivation Path: 36.508 Table 4.4.3.3-5			
Information Element	Value/remark	Comment	Condition
SystemInformationBlockType6 ::= SEQUENCE {			
carrierFreqListUTRA-FDD SEQUENCE (SIZE (1..maxUTRA-FDD-Carrier)) OF SEQUENCE {			UTRA-FDD
carrierFreq[n]	Same downlink UARFCN as used for cell 5		
cellReselectionPriority[n]	3	Lower priority than E-UTRA	
}			
carrierFreqListUTRA-TDD SEQUENCE (SIZE (1..maxUTRA-TDD-Carrier)) OF SEQUENCE {			UTRA-TDD
carrierFreq[n]	Same downlink UARFCN as used for cell 5		
cellReselectionPriority[n]	3	Lower priority than E-UTRA	
}			
}			

Condition	Explanation
UTRA-FDD	UTRA FDD cell environment
UTRA-TDD	UTRA TDD cell environment

Table 13.1.4.3.3-3: Message Paging (step 1, Table 13.1.4.3.2-2)

Derivation Path: 36.508 clause 4.6.1-7			
Information Element	Value/remark	Comment	Condition
Paging ::= SEQUENCE {			
pagingRecordList SEQUENCE (SIZE (1..maxPageRec)) OF SEQUENCE {	1 entry		
ue-Identity[1] CHOICE {			
s-TMSI	Set to the value of the S-TMSI of the UE		
}			
cn-Domain[1]	cs		
}			
}			

Table 13.1.4.3.3-4: RRCConnectionSetupComplete (step 5, Table 13.1.4.3.2-2)

Derivation Path: 36.508 Table 4.6.1-18			
Information Element	Value/remark	Comment	Condition
RRCConnectionSetupComplete ::= SEQUENCE {			
rrc-TransactionIdentifier	RRC-TransactionIdentifier-UL		
criticalExtensions CHOICE {			
c1 CHOICE {			
rrcConnectionSetupComplete-r8 SEQUENCE {			
selectedPLMN-Identity	Set to the PLMN selected by upper layers		
registeredMME	Not present		
dedicatedInfoNAS	Set according to 36.508 Table 4.7.2-14A	EXTENDED SERVICE REQUEST (Note: Sent as integrity protected NAS message)	
nonCriticalExtension SEQUENCE {}	Not checked		
}			
}			
}			

Table 13.1.4.3.3-5: RRCConnectionReconfiguration (step 5C, Table 13.1.4.3.2-2)

Derivation Path: 36.508 Table 4.6.1-8, condition SRB2-DRB(1, 0)

Table 13.1.4.3.3-6: Message MobilityFromEUTRACommand (step 6, Table 13.1.4.3.2-2)

Derivation Path: 36.508 clause 4.6.1-6			
Information Element	Value/remark	Comment	Condition
MobilityFromEUTRACommand ::= SEQUENCE {			
criticalExtensions CHOICE {			
c1 CHOICE {			
mobilityFromEUTRACommand-r8 SEQUENCE {			
csFallbackIndicator	True		
purpose CHOICE {			
handover SEQUENCE {			
targetRAT-Type	Utra		
targetRAT-MessageContainer	HANDOVER TO UTRAN COMMAND		
nas-SecurityParamFromEUTRA	The 4 least significant bits of the NAS downlink COUNT value		
systemInformation	Not present		
}			
}			
}			
}			

Table 13.1.4.3.3-7: HANDOVER TO UTRAN COMMAND (step 6, Table 13.1.4.3.3-6)

Derivation Path: 36.508 table 4.7B.1-1, condition UTRA PS RB
--

Table 13.1.4.3.3-8: Void

Table 13.1.4.3.3-9: UECapabilityEnquiry (step 5E, Table 13.1.4.3.2-2)

Derivation path: 36.508 clause 4.6.1 table 4.6.1-22			
Information Element	Value/Remark	Comment	Condition
UECapabilityEnquiry ::= SEQUENCE {			
criticalExtensions CHOICE {			
c1 CHOICE {			
ueCapabilityEnquiry-r8 SEQUENCE {			
ue-CapabilityRequest SEQUENCE (SIZE (1..maxRAT-Capabilities)) OF SEQUENCE {	2 entry		
RAT-Type[1]	Eutra		
RAT-Type[2]	Utra		
}			
}			
}			
}			
}			

Table 13.1.4.3.3-10: ATTACH ACCEPT (Preamble)

Derivation Path: 36.508 Table 4.7.2-1			
Information Element	Value/remark	Comment	Condition
EPS network feature support	Not present		

13.1.5 Call setup from E-UTRAN RRC_CONNECTED / CS fallback to UTRAN with handover / MO call

13.1.5.1 Test Purpose (TP)

(1)

```
with { UE in E-UTRA RRC_CONNECTED state having requested CS call setup }
ensure that {
  when { UE receives a MobilityFromEUTRACommand message including a cs-FallbackIndicator set to 'true' and a targetRAT-Type set to 'utra' }
  then { UE transmits a HANDOVER TO UTRAN COMPLETE message and continues the PS data service }
}
```

13.1.5.2 Conformance requirements

References: The conformance requirements covered in the present TC are specified in: TS 36.331, clause 5.4.3.3.

[TS 36.331, clause 5.4.3.3]

The UE shall be able to receive a *MobilityFromEUTRACommand* message and perform a cell change order to GERAN, even if no prior UE measurements have been performed on the target cell.

The UE shall:

- 1> stop timer T310, if running;
- 1> if the *MobilityFromEUTRACommand* message includes the *purpose* set to 'handover':
 - 2> if the *targetRAT-Type* is set to 'utra' or 'geran':
 - 3> consider inter-RAT mobility as initiated towards the RAT indicated by the *targetRAT-Type* included in the *MobilityFromEUTRACommand* message;
 - 3> forward the *nas-SecurityParamFromEUTRA* to the upper layers;
 - 3> access the target cell indicated in the inter-RAT message in accordance with the specifications of the target RAT;

13.1.5.3 Test description

13.1.5.3.1 Pre-test conditions

System Simulator:

- Cell 1 and Cell 5.
- System information combination 4 as defined in TS 36.508 [18] clause 4.4.3.1 is used in E-UTRA cells.

Table 13.1.5.3.1-1 shows the cell power levels after the preamble.

Table 13.1.5.3.1-1: Time instances of cell power level and parameter changes

	Parameter name	Unit	Cell 1	Cell 5
T0	RS EPRE	dBm/15kHz	-85	
	CPICH_Ec	dBm/3.84 MHz		-70
	P-CCPCH	dBm/1.28 MHz		-72
T1	RS EPRE	dBm/15kHz	Non-suitable "Off"	
	CPICH_Ec	dBm/3.84 MHz		-70
	P-CCPCH	dBm/1.28 MHz		-72

UE:

None.

Preamble:

- The UE is in state Loopback Activated (state 4) with condition UE TEST LOOP MODE B on Cell 1 according to [18].

13.1.5.3.2 Test procedure sequence

Table 13.1.5.3.2-1: Main behaviour

St	Procedure	Message Sequence		TP	Verdict
		U - S	Message		
1	The SS transmits one IP packet to the UE on the DRB associated with the default EPS bearer context on Cell 1.	<--	IP packet	-	-
2	The UE loops back the IP packet on the DRB associated with the default EPS bearer context on Cell 1.	-->	IP packet	-	-
3	Cause the UE to originate CS call. (see Note 1)	-	-	-	-
4	The UE transmits an <i>ULInformationTransfer</i> message on Cell 1. This message includes an EXTENDED SERVICE REQUEST message.	-->	<i>ULInformationTransfer</i>	-	-
4A	The SS transmits a <i>UECapabilityEnquiry</i> message to request UE radio access capability information for E-UTRA and UTRA.	<--	<i>UECapabilityEnquiry</i>	-	-
4B	The UE transmit a <i>UECapabilityInformation</i> message on Cell 1. NOTE: The start-PS values received, should be used to configure ciphering on cell 5.	-->	<i>UECapabilityInformation</i>	-	-
5	The SS transmits a <i>MobilityFromEUTRACommand</i> message on Cell 1.	<--	<i>MobilityFromEUTRACommand</i>	-	-
6	Check: Does the result of the "CS fallback to UTRAN with Handover / MO call" generic procedure from 36.508 clause 6.4.3.7.6 indicate that the UE performs CS fallback to UTRAN with Handover / MO Call on Cell 5?	-	-	1	P
6A	SS adjusts cell levels according to row T1 of table 13.1.5.3.1-1.				
-	Void.	-	-	-	-
7-13	Void	-	-	-	-
14	The SS transmits one IP packet to the UE on the PS RAB on Cell 5.	<--	IP packet	-	-
15	Check: Does the UE loop back the IP packet on the PS RAB on Cell 5?	-->	IP packet	1	P

Note 1: The trigger in step 3 is the same as in the generic procedure in 36.508 clause 6.4.3.5.

13.1.5.3.3 Specific message contents

Table 13.1.5.3.3-1: MobilityFromEUTRACommand (step 5, Table 13.1.5.3.2-1)

Derivation Path: 36.508, Table 4.6.1-6			
Information Element	Value/remark	Comment	Condition
MobilityFromEUTRACommand ::= SEQUENCE {			
criticalExtensions CHOICE {			
c1 CHOICE{			
mobilityFromEUTRACommand-r8 SEQUENCE {			
cs-FallbackIndicator	true		
purpose CHOICE{			
handover SEQUENCE {			
targetRAT-Type	utra		
targetRAT-MessageContainer	HANDOVER TO UTRAN COMMAND(UTRA RRC message)		
nas-SecurityParamFromEUTRA	The 4 least significant bits of the NAS downlink COUNT value		
systemInformation	Not present		
}			
}			
}			
}			
}			
}			
}			

Table 13.1.5.3.3-2: HANDOVER TO UTRAN COMMAND (Table 13.1.5.3.3-1)

Derivation Path: 36.508, Table 4.7B.1-1, condition UTRA PS RB			
---	--	--	--

Table 13.1.5.3.3-3: EXTENDED SERVICE REQUEST (step 4, table 13.1.5.3.2-1)

Derivation path: 36.508 table 4.7.2-14A			
Information Element	Value/Remark	Comment	Condition
Service type	0000 'mobile originating CS fallback or 1xCS fallback'		
CSFB response	Not present		

Table 13.1.5.3.3-4: UECapabilityEnquiry (step 4A, Table 13.1.5.3.2-1)

Derivation path: 36.508 clause 4.6.1 table 4.6.1-22			
Information Element	Value/Remark	Comment	Condition
UECapabilityEnquiry ::= SEQUENCE {			
criticalExtensions CHOICE {			
c1 CHOICE {			
ueCapabilityEnquiry-r8 SEQUENCE {			
ue-CapabilityRequest SEQUENCE (SIZE (1..maxRAT-Capabilities)) OF SEQUENCE {	2 entry		
RAT-Type[1]	Eutra		
RAT-Type[2]	Utra		
}			
}			
}			
}			
}			
}			

Table 13.1.5.3.3-5: ATTACH ACCEPT (Preamble)

Derivation Path: 36.508 Table 4.7.2-1			
Information Element	Value/remark	Comment	Condition
EPS network feature support	Not present		

13.1.6 Void

13.1.7 Call setup from E-UTRA RRC_IDLE / CS fallback to GSM with redirection / MT call

13.1.7.1 Test Purpose (TP)

(1)

```
with { UE in E-UTRA RRC_IDLE state }
ensure that {
  when { UE receives a Paging message for CS service, and UE has Set up RRCConnection with the E-UTRA CELL }
  then { UE transmits an ULInformationTransfer message containing an EXTENDED SERVICE REQUEST message with Service Type IE set to "mobile terminating CS fallback or 1xCS fallback" }
}
```

(2)

```
with { UE having transmitted an ULInformationTransfer message containing an EXTENDED SERVICE REQUEST message with Service Type IE set to "mobile terminating CS fallback or 1xCS fallback" }
ensure that {
  when { SS transmits an RRCConnectionRelease message with redirection to a GSM cell in a same location area and operating in NMO I }
  then { UE tunes to GERAN cell and completes MT circuit switched voice call setup procedure on GERAN }
}
```

13.1.7.2 Conformance requirements

References: The conformance requirements covered in the current TC are those listed in TC 8.1.3.8, plus those specified in: TS 23.272, clause 7.4, and TS 24.301, clause 5.6.2.3..

[TS 23.272, clause 7.2]

The procedure for Mobile Terminating Call in idle mode is illustrated in figure 7.2-1, in the normal case. Clause 6.6 describes the procedure when the procedure is rejected by the MME.

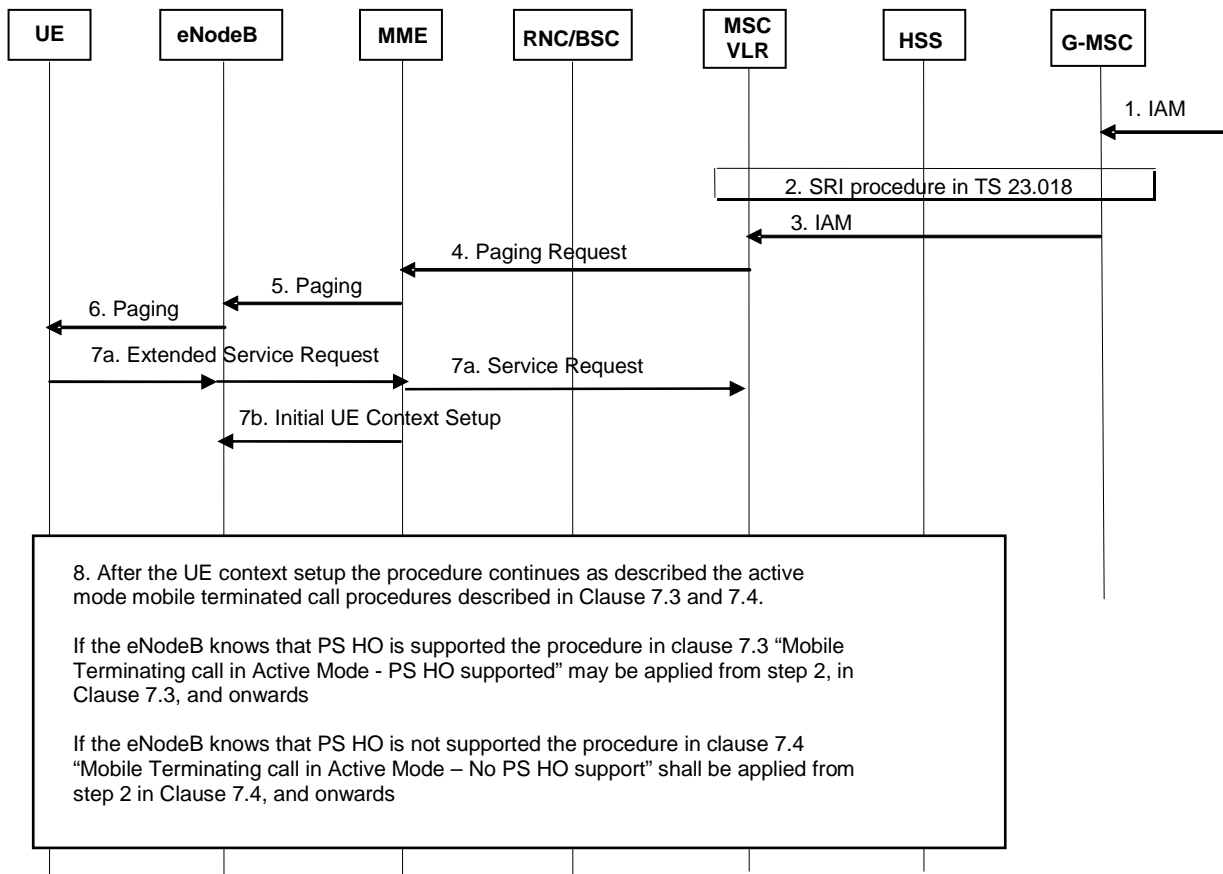

Figure 7.2-1: Mobile Terminating Call in idle mode

1. G-MSC receives IAM.
2. G-MSC retrieves routing information of the terminating UE by Send Routing Info procedures as specified in TS 23.018 [5].
3. G-MSC sends IAM to the MSC on the terminating side as specified in TS 23.018 [5].
4. The MME receives a Paging Request (IMSI, VLR TMSI, Location Information) message from the MSC over a SGs interface. If the TMSI is received from the MSC, it is used by the MME to find the S-TMSI which is used as the paging address on the radio interface. If the IMSI is received from the MSC, the IMSI shall be used as the paging address on the radio interface. If location information is reliably known by MME (i.e. MME stores the list of TAs), the MME shall page the UE in all the TAs. If the MME does not have a stored TA list for the UE, the MME should use the location information received from the MSC to page the UE.

NOTE 1: This procedure takes place before step 3, immediately after MSC receives MAP_PRN from HSS, if pre-paging is deployed.

If the MME receives a Paging Request message for an UE which is considered as detach for EPS services, the MME sends the Paging reject message to the MSC with an appropriate cause value. This rejection triggers the MSC to page the UE over A or Iu-CS interface.

NOTE 2: In case of a CS fallback capable UE in NMO II or III, there is a case where, for example, the MME releases the SGs association due to the UE idle mode mobility while the VLR still maintains the SGs association.

5. If the MME did not return an "SMS-only" indication to the UE during Attach or Combined TA/LA Update procedures, the MME sends a Paging (as specified in TS 23.401 [2]) message to each eNodeB. The Paging message includes a suitable UE Identity (i.e. S-TMSI or IMSI) and a CN Domain Indicator that indicates which domain (CS or PS) initiated the paging message. In this case it shall be set to "CS" by the MME.

If the MME returned the "SMS-only" indication to the UE during Attach or Combined TA/LA Update procedures, the MME shall not send the paging to the eNodeBs and sends Paging Reject towards MSC to stop CS Paging procedure and this CSFB procedure stops.

6. The radio resource part of the paging procedure takes place. The message contains a suitable UE Identity (i.e. S-TMSI or IMSI) and a CN Domain indicator.
 - 7a. The UE establishes an RRC connection and sends an Extended Service Request (CS Fallback Indicator) to MME. The UE indicates its S-TMSI in the RRC signalling. The Extended Service Request message is encapsulated in RRC and S1-AP messages. The CS Fallback Indicator indicates to the MME that CS Fallback for this UE is required. The MME sends the SGs Service Request message to the MSC containing an indication that the UE was in idle mode (and hence, for example, that the UE has not received any Calling Line Identification information). Receipt of the SGs Service Request message stops the MSC retransmitting the SGs interface Paging message.
- NOTE 3: In order to avoid the calling party experiencing a potentially long period of silence, the MSC may use the SGs Service Request message containing the idle mode indication as a trigger to inform the calling party that the call is progressing.
- 7b. MME sends S1-AP: Initial UE Context Setup (UE capabilities, CS Fallback Indicator, LAI and other parameters specified in TS 23.401 [2]) to indicate the eNodeB to move the UE to UTRAN/GERAN. The registered PLMN for CS domain is identified by the PLMN ID included in the LAI, which is allocated by the MME.
 - 7c. The eNodeB shall reply with S1-AP: Initial UE Context Setup Response message.
 - 8a. If the eNodeB knows that both the UE and the network support PS handover: The information flow may continue as described in clause 7.3 "Mobile Terminating call in Active Mode - PS HO supported" from step 2, in clause 7.3, and onwards.
 - . If the eNodeB knows that either the UE or the network does not support PS handover: The information flow shall continue as described in clause 7.4 "Mobile Terminating call in Active Mode – No PS HO support" from step 2, in clause 7.4, and onwards.

NOTE 4: Even in case both the UE and the network support PS HO, the eNodeB may choose to use a different inter-RAT mobility procedure.

[TS 23.272, clause 7.4]

This procedure is executed when PS HO is not supported, in the normal case. Clause 6.6 describes the procedure when the procedure is rejected by the MME.

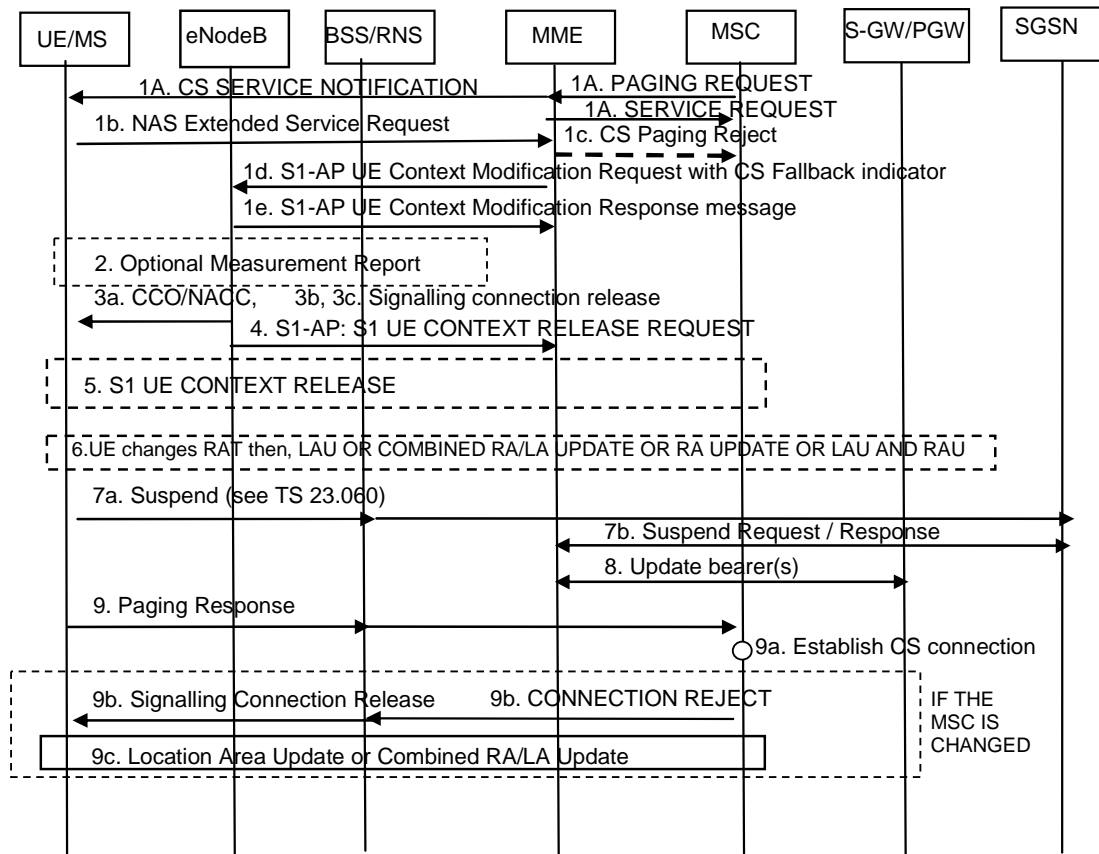

Figure 7.4-1: CS Page in E-UTRAN, Call in GERAN/UTRAN without PS HO

1a. The MSC receives an incoming voice call and responds by sending a Paging Request (IMSI or TMSI, optional Caller Line Identification and Connection Management information) to the MME over a SGs interface. The MSC only sends a CS Page for an UE that provides location update information using the SGs interface. In active mode the MME has an established S1 connection and if the MME did not return the "SMS-only" indication to the UE during Attach or Combined TA/LA Update procedures, the MME reuses the existing connection to relay the CS Service Notification to the UE.

If the MME returned the "SMS-only" indication to the UE during Attach or Combined TA/LA Update procedures, the MME shall not send the CS Page to the UE and sends CS Paging Reject towards MSC to stop CS Paging procedure, and this CSFB procedure stops.

The eNodeB forwards the paging message to the UE. The message contains CN Domain indicator and, if received from the MSC, the Caller Line Identification.

The MME immediately sends the SGs Service Request message to the MSC containing an indication that the UE was in connected mode. The MSC uses this connected mode indication to start the Call Forwarding on No Reply timer for that UE and the MSC should send an indication of user alerting to the calling party. Receipt of the SGs Service Request message stops the MSC retransmitting the SGs interface Paging message.

NOTE 1: The pre-configured policy may be used by UE to avoid being disturbed without Caller Line Identification display and the detailed handling is to be decided by CT WG1 and CT WG6.

NOTE 2: This procedure can also take place immediately after MSC receives MAP_PRN from HSS, if pre-paging is deployed. Caller Line Identification is also provided in the case of pre-paging.

1b. UE sends an Extended Service Request (CS Fallback Indicator, Reject or Accept) message to the MME. Extended Service Request message is encapsulated in RRC and S1-AP messages. CS Fallback Indicator indicates MME to perform CS Fallback. The UE may decide to reject CSFB based on Caller Line Identification.

1c. Upon receiving the Extended Service Request (CSFB, Reject), the MME sends Paging Reject towards MSC to stop CS Paging procedure and this CSFB procedure stops.

1d. The MME sends an S1-AP UE Context Modification Request (CS Fallback Indicator, LAI) message to eNodeB. This message indicates to the eNodeB that the UE should be moved to UTRAN/GERAN. The registered PLMN for CS domain is identified by the PLMN ID included in the LAI, which is allocated by the MME.

1e. The eNodeB shall reply with S1-AP UE Context Modification Response message.

2. The eNodeB may optionally solicit a measurement report from the UE to determine the target GERAN/UTRAN cell to which the redirection procedure will be performed.

The network performs one of steps 3a or 3b or 3c.

3a. If the UE and network support inter-RAT cell change order to GERAN and the target cell is GERAN:

The eNodeB can trigger an inter-RAT cell change order (optionally with NACC) to a GERAN neighbour cell by sending an RRC message to the UE. The inter-RAT cell change order may contain a CS Fallback Indicator which indicates to UE that the cell change order is triggered due to a CS fallback request. If the inter-RAT cell change order contains a CS Fallback Indicator and the UE fails to establish connection to the target RAT, then the UE considers that CS fallback has failed. Service Request procedure is considered to be successfully completed when cell change order procedure is completed successfully.

The eNodeB selects the target cell considering the PLMN ID and possibly the LAC for CS domain provided by the MME in step 1d for CCO/NACC purpose.

3b. If the UE or the network does not support inter-RAT PS handover from E-UTRAN to GERAN/UTRAN nor inter-RAT cell change order to GERAN:

The eNodeB can trigger RRC connection release with redirection to GERAN or UTRAN instead of PS HO or NACC.

NOTE 3: When performing CS Fallback to UTRAN, the RRC connection release with redirection can be optimized if both the UE and UTRAN support the optional "Deferred measurement control reading" feature specified in TS 25.331 [7].

3c. If the UE and network support "RRC connection release with redirection and Multi Cell System Information to GERAN/UTRAN":

The eNodeB can trigger RRC connection release with redirection to GERAN or UTRAN and include one or more physical cell identities and their associated System Information.

In step 3b or step 3c, the eNodeB includes the redirection control information into the RRC Connection Release message based on the PLMN ID for CS domain and the RAT/frequency priority configured in the eNodeB, so that the UE registered PLMN for CS domain can be preferably selected.

NOTE 4: Service Request procedure supervision timer shall be sufficiently long considering the optional measurement reporting at step 2.

4. The eNodeB sends an S1-AP UE Context Release Request message to the MME. If the target cell is GERAN and either the target cell or the UE does not support DTM the message includes an indication that the UE is not available for PS service.

5. The MME releases the UE Context in the eNodeB as well as all eNodeB related information in the S-GW as specified in TS 23.401 [2].

In case the Cause indicates that RRC was released due to abnormal conditions, e.g. radio link failure, the MME suspends the EPS bearers (Step 8).

The UE performs one of steps 6a or 6b or 6c and THEN performs step 6d.

6a. (Step 6a is performed if step 3a, Cell Change Order to GERAN, was performed)

The UE moves to the new cell in GERAN. The UE uses the NACC information and/or receives the broadcast System Information and when it has the necessary information to access the GERAN cell, establishes a radio signalling connection.

6b. (Step 6b is performed if step 3b, RRC release with redirection, was performed).

The UE moves to the target RAT, identifies a suitable cell preferably of the same PLMN as received in LAI IE of combined EPS/IMSI Attach/TAU Accept message, receives the broadcast System Information and when it has the necessary information to access GERAN/UTRAN, establishes a radio signalling connection.

- 6c. (Step 6c is performed if step 3c, RRC connection release with redirection and Multi Cell System Information, was performed)

The UE moves to the target RAT and identifies a suitable cell preferably of the same PLMN as received in LAI IE of combined EPS/IMSI Attach/TAU Accept message. The UE uses the NACC information and/or receives the broadcast System Information and when it has the necessary information to access GERAN/UTRAN, the UE establishes the radio signalling connection.

- 6d. If the LA of the new cell is different from the one stored in the UE, the UE shall initiate a Location Area Update or a Combined RA/LA Update as specified in TS 23.060 [3] for the different Network Modes of Operation (NMO). The UE shall set the "CSMT" flag in the LAU Request. The "CSMT" flag is used to avoid missing MT call in roaming retry case. In NMO I, the UE in GERAN may perform LA update over the RR connection instead of combined RA/LA update over the packet access as defined in TS 24.008 [21], clause 4.7.5.2.5, unless enhanced CS establishment in DTM is supported. Further the UE performs any Routing Area Update procedure as specified in TS 23.060 [3].

In NMO I a CSFB UE should perform LAU (and if it does so, shall set the "CSMT" flag) and RAU procedures instead of a Combined RA/LA Update procedure to speed up the CSFB procedure.

When the MSC receives a LA Update Request, it shall check for pending terminating CS calls and, if the "CSMT" flag is set, maintain the CS signalling connection after the Location Area Update procedure for pending terminating CS calls.

7. If the target RAT is GERAN and DTM is not supported, the UE starts the Suspend procedure specified in TS 23.060 [3]. This triggers the (serving) SGSN to send a Suspend Request (TLLI, RAI) message to the old CN node identified by the RAI and TLLI. If ISR is not active, the RAI and TLLI refer to an MME. The MME returns a Suspend Response to the SGSN even though GUTI cannot be derived from the P-TMSI and RAI pair. If ISR is active, the RAI and TLLI refer to the old S4-SGSN which has ISR association with the MME. In this case, if the serving SGSN is different from the old SGSN, the old SGSN returns a Suspend Response to the serving SGSN.

NOTE 5: For step 7b and 8, the inter-SGSN suspending procedure of ISR active case are not shown in the figure.

8. If the S1-AP UE Context Release Request message, received from the eNodeB in step 4, indicates that the UE is not available for the PS services in the target cell, the MME deactivates GBR bearers towards S-GW and P-GW(s) by initiating MME-initiated Dedicated Bearer Deactivation procedure as specified in TS 23.401 [2], and starts the preservation and suspension of non-GBR bearers by sending Suspend Notification message to the S-GW. If ISR is active, the (old) S4-SGSN sends the Suspend Notification message to the S-GW, triggered by the Suspend procedure in step 7 and hence MME may skip sending the Suspend Notification. The S-GW releases all eNodeB related information (address and TEIDs) for the UE, and sends Suspend Notification message to the P-GW(s) when it receives the Suspend Notification message from MME or S4-SGSN. If the S-GW receives two Suspend Notification messages for the same UE, it ignores the second one except for sending response. The MME stores in the UE context that the UE is in suspended status. All the preserved non-GBR bearers are marked as suspended status in the S-GW and P-GW(s). The P-GW should discard packets if received for the suspended UE.

NOTE 6: Step 8 can not be triggered by the Suspend procedure since the full GUTI can not be derived from the P-TMSI and RAI included in the Suspend Request message.

9. If the UE does not initiate a LAU procedure, the UE responds to the paging by sending a Paging Response message as specified in TS 44.018 [4] or TS 25.331 [7]. When received at the BSS/RNS, the Paging Response is forwarded to the MSC.

NOTE 7: The MSC should be prepared to receive a Paging Response after a relatively long time from when the CS Paging Request was sent (step 1a).

- 9a. If UE is registered in the MSC serving the 2G/3G cell and the UE is allowed in the LA the MSC shall establish the CS call.

- 9b. If the UE is not registered in the MSC that receives the Paging Response or the UE is not allowed in the LA, the MSC shall reject the Paging Response by releasing the A/Iu-cs connection. The BSS/RNS in turn releases the signalling connection for CS domain.
- 9c. The signalling connection release shall trigger the UE to obtain the LAI, which causes the initiation of a Location Area Update or a Combined RA/LA procedure as specified in TS 23.060 [3] for the different Network Modes of Operation (NMO).

The Location Area Update triggers the Roaming Retry for CS Fallback procedure as defined in clause 7.5.

After performing the LAU procedure the MSC shall establish the CS call if the UE is allowed in the LA.

With the exception of steps 1a and 1c, above, Call Forwarding (see TS 23.082 [31]) is performed on the basis of the TS 24.008 [21] signalling received on the GERAN/UTRAN cell.

After the CS voice call is terminated and if the UE is still in GERAN and PS services are suspended, then the UE shall resume PS services as specified in TS 23.060 [3]. A Gn/Gp- SGSN will follow TS 23.060 [3] to resume the PDP Context(s). An S4 SGSN will follow TS 23.060 [3] to resume the bearers, and informs the S-GW and P-GW(s) to resume the suspended bearers. If the UE has returned to E-UTRAN after the CS voice call was terminated, then the UE shall resume PS service by sending TAU to MME. The MME will in addition inform S-GW and P-GW(s) to resume the suspended bearers. Resuming the suspended bearers in the S-GW and in the P-GW should be done by implicit resume using the Modify Bearer request message if it is triggered by the procedure in operation e.g. RAU, TAU or Service Request. The S-GW is aware of the suspend state of the bearers and shall forward the Modify Bearer request to the P-GW. Explicit resume using the Resume Notification message should be used in cases when Modify Bearer Request is not triggered by the procedure in operation.

If the UE remains on UTRAN/GERAN after the CS voice call is terminated the UE performs normal mobility management procedures as defined in TS 23.060 [3] and TS 24.008 [21].

Editor's note: the following text shall probably be deleted.

The procedure for Mobile Terminating Call in idle mode is illustrated in figure 7.2-1.

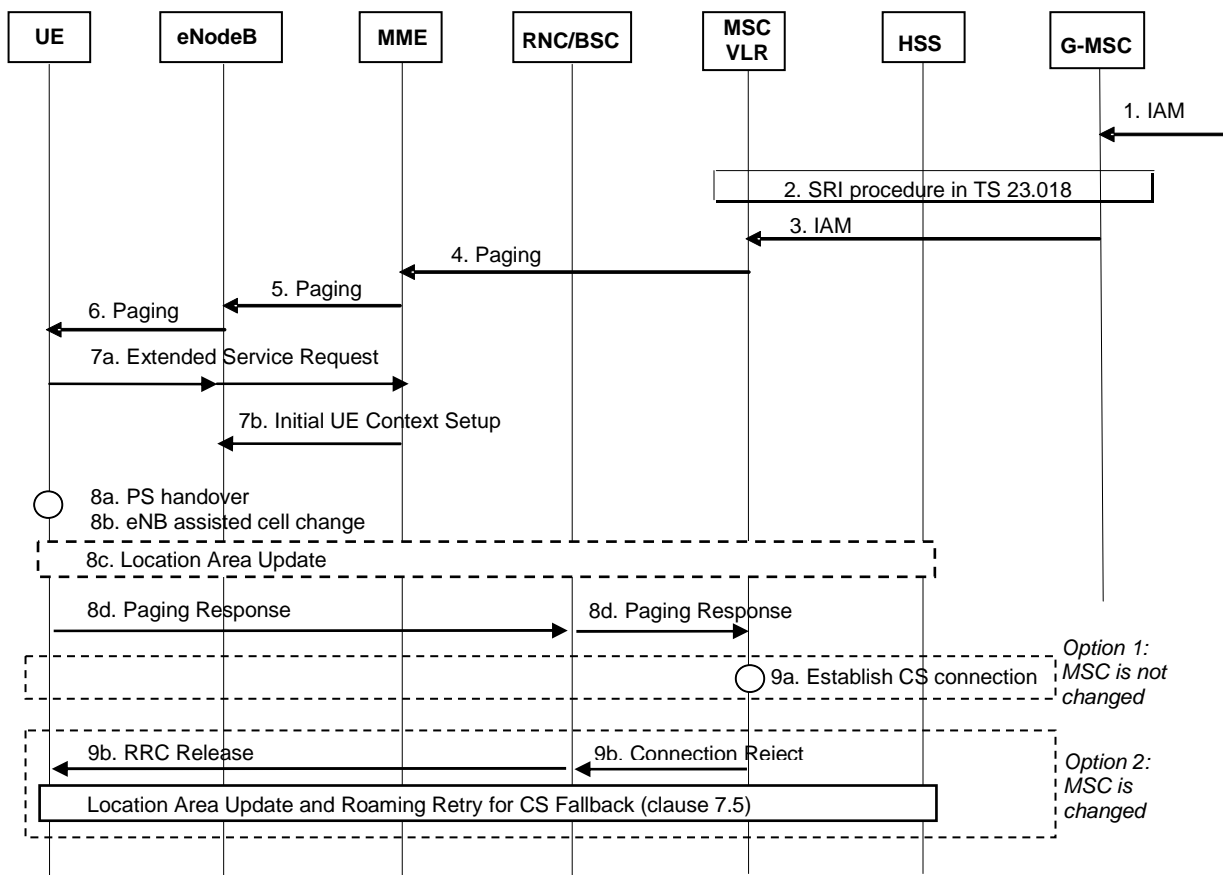

Figure 7.2-1: Mobile Terminating Call in idle mode

1. G-MSC receives IAM.
2. G-MSC retrieves routing information of the terminating UE by Send Routing Info procedures as specified in TS 23.018 [5].
3. G-MSC sends IAM to the MSC on the terminating side as specified in TS 23.018 [5].
4. The MME receives a Paging (IMSI, VLR TMSI, Location Information) message from the MSC over a SGs interface. The TMSI (or IMSI) received from the MSC is used by the MME to find the S-TMSI which is used as the paging address on the radio interface. If location information is reliably known by MME (i.e. MME stores the list of TAs), the MME shall page the UE in all the TAs. If the MME does not have a stored TA list for the UE, the MME should use the location information received from the MSC to page the UE.

NOTE 1: This procedure takes place before step 3, immediately after MSC receives MAP_PRN from HSS, if pre-paging is deployed.

5. The MME sends a Paging (as specified in TS 23.401 [2]) message to each eNodeB. The Paging message includes a suitable UE Identity (i.e. S-TMSI or IMSI) and a CN Domain Indicator that indicates which domain (CS or PS) initiated the paging message. In this case it shall be set to "CS" by the MME.
6. The radio resource part of the paging procedure takes place. The message contains a suitable UE Identity (i.e. S-TMSI or IMSI) and a CN Domain indicator.
- 7a. The UE establishes an RRC connection and sends an Extended Service Request (CS Fallback Indicator) to MME. The UE indicates its S-TMSI in the RRC signalling. The Extended Service Request message is encapsulated in RRC and S1-AP messages. The CS Fallback Indicator indicates to the MME that CS Fallback for this UE is required.
- 7b. MME sends S1-AP: Initial UE Context Setup (UE capabilities, CS Fallback Indicator and other parameters specified in TS 23.401 [2]) to indicate the eNodeB to move the UE to UTRAN/GERAN.
- 8a. Target RAT has PS HO capability: Upon receipt of the Initial UE Context Setup message with a CS Fallback Indicator the eNodeB may optionally solicit measurement reports from the UE to determine the target cell to which PS handover will be performed. A PS handover is then performed as specified in TS 23.401 [2]. As part of this PS handover, the UE receives a HO from E-UTRAN Command that may contain a CS Fallback Indicator, which indicates to UE that the handover is triggered due to a CS fallback request. If the HO from E-UTRAN Command contains a CS Fallback Indicator and the UE fails to establish connection to the target RAT, then the UE considers that CS fallback has failed.
- 8b. Target RAT has no PS HO capability. Upon receipt of the Initial UE Context Setup message with a CS Fallback Indicator the eNodeB may optionally solicit measurement reports from the UE to determine the target cell to redirect the UE to. After that, the eNB releases the RRC Connection with a redirection info to change to CS capable RATs (RAT, frequency, cell info). As an option the inter-RAT system information might be provided by the eNodeB using the NACC procedure for GERAN. In this case the UE receives in inter-RAT cell change order that may contain a CS Fallback Indicator which indicates to UE that the cell change order is triggered due to a CS fallback request. If the inter-RAT cell change order contains a CS Fallback Indicator and the UE fails to establish connection to the target RAT, then the UE considers that CS fallback has failed.
- 8c. If the UE obtains LA/RA information of the new UTRAN/GERAN cell (e.g. based on the system information or redirection info) and the LA/RA of the new cell is different from the one stored in the UE, it performs a Location Area Update or a Combined RA/LA procedure if the target system operates in Network Mode of Operation (NMO) I, according to TS 23.060 [3].
- 8d. The UE responds with a page response message to the MSC as follows:
 - If Target RAT is UTRAN or GERAN Iu mode, the UE establishes an RRC connection and responds to the paging in an RRC Initial Direct Transfer message as specified in TS 25.331 [7]. The CN Domain Indicator is set to "CS" in the Initial Direct Transfer message. When received at the RNC, the Paging Response message is sent in an RANAP Initial UE message to the MSC.
 - If Target RAT is GERAN A/Gb mode: the UE establishes an RR connection by using the procedures specified in TS 44.018 [6] (i.e. UE requests and is assigned a dedicated channel where it sends a SABM containing a layer 3 Service Request message = PAGING RESPONSE to the BSS and the BSS responds by

sending a UA). After the establishment of the main signalling link as described in TS 44.018 [4] the UE enters either Dual Transfer Mode or Dedicated Mode and the CS call establishment procedure completes. When received at the BSC, the Paging Response message is sent in a BSSAP COMPLETE LAYER 3 INFORMATION message to the MSC as specified in TS 48.008 [6].

NOTE 2: The BSS should be prepared to receive a PAGING RESPONSE even when a corresponding PAGING REQUEST has not been sent by this BSS. Also, the MSC should be prepared to receive a paging response after a relatively long time from when the CS Paging was sent (step 4).

9a. In case the MSC serving the 2G/3G cell is the same as the MSC that served the UE while camped on LTE, it shall stop the paging response timer and establish the CS connection.

9b. If the MSC that receives the paging response is different from the MSC that sent the paging request and if the Location Area Update / Combined RA/LA Update was not performed in step 8c, the MSC shall reject the page response by releasing the A/Iu-cs connection. The BSC/RNC in turn releases the RRC/RR connection. The RRC/RR release shall trigger the UE to perform a Location Area Update as follows:

- If the target system operates in Network Mode of Operation (NMO) I the UE shall perform a combined RA/LA update, as defined in TS 23.060 [3].
- If the target system operates in NMO II or III the UE performs a Location Area Update towards the MSC.

The Location Area Update triggers the Roaming Retry for CS Fallback procedure as defined in clause 7.5.

When the target system operates in Network Mode of Operation (NMO) I then, if the UE is still in UTRAN/GERAN after the CS voice call is terminated, and if a combined RA/LA update has not already been performed, the UE performs a combined RA/LA update procedure. This procedure is used to create a Gs association between the MSC/VLR and the SGSN, and to release the SGs association.

When the target system operates in Network Mode of Operation (NMO) II or III then, if the UE is still in UTRAN/GERAN after the CS voice call is terminated, and if a LA update has not already been performed, the UE performs a LA update procedure. This procedure is used to release the SGs association between the MSC/VLR and the MME.

[TS 24.301, clause 5.6.2.3]

The network may initiate the paging procedure for non-EPS services when the UE is IMSI attached for non-EPS services (see example in figure 5.6.2.3.1).

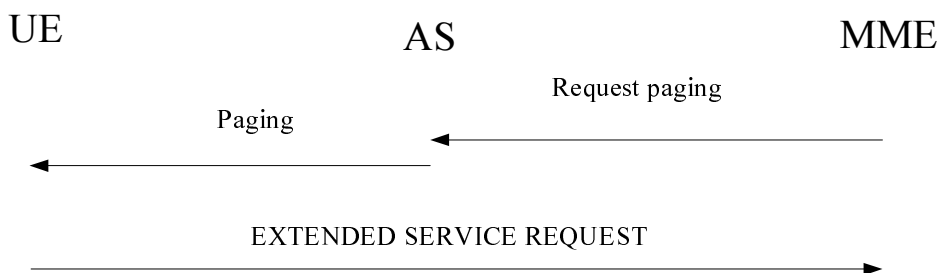

Figure 5.6.2.3.1: Paging procedure for CS fallback to A/Gb or Iu mode

To initiate the procedure when no NAS signalling connection exists, the EMM entity in the network requests the lower layer to start paging (see 3GPP TS 36.300 [20], 3GPP TS 36.413 [23]). The paging message includes a CN domain indicator set to "CS" in order to indicate that this is paging for CS fallback.

NOTE: The timer T3413 is not started in the network when the paging procedure is initiated for CS fallback.

To notify the UE about an incoming mobile terminating CS service when a NAS signalling connection exists, the EMM entity in the network shall send a CS SERVICE NOTIFICATION message. This message may also include CS service related parameters (e.g. Calling Line Identification, SS or LCS related parameters).

Upon reception of a paging indication, the UE shall respond with an EXTENDED SERVICE REQUEST. If the paging is received in EMM-IDLE mode, the UE shall respond immediately. If the paging is received as NAS CS NOTIFICATION message in EMM-CONNECTED mode, the UE may request upper layers input i.e. to accept or reject CS fallback before responding with an EXTENDED SERVICE REQUEST. The response is indicated in the CSFB response information element in the EXTENDED SERVICE REQUEST message in both EMM-IDLE and EMM-CONNECTED modes.

13.1.7.3 Test description

13.1.7.3.1 Pre-test conditions

System Simulator:

- Cell 1 (serving cell) and Cell 24 (suitable neighbour cell) are in the same LA.
- System information combination 5 as defined in TS 36.508 [18] clause 4.4.3.1 is used in E-UTRA cells.
- The parameters settings and power levels for Cell 1 and Cell 24 are selected according to [18], [5] so that camping on Cell 1 is guaranteed and no cell re-selection to Cell 24 can take place (GERAN priority is lower than serving and $S_{Cell 1} > Thresh_{Cell 1,low}$).
- DTM is not supported on the Cell 24.

UE:

Preamble:

- The UE is in state Registered, Idle Mode (state 2) on Cell 1 according to [18].

13.1.7.3.2 Test procedure sequence

Table 13.1.7.3.2-1: Void

Table 13.1.7.3.2-1A: instances of cell power level and parameter changes

	Parameter	Unit	Cell 1	Cell 24	Remark
T1	Cell-specific RS EPRE	dBm/15kHz	-115	-	The power levels are such that reselection back to cell 1 should not occur

Table 13.1.7.3.2-2: Main behaviour

St	Procedure	Message Sequence		TP	Verdict
		U - S	Message		
1	The SS transmits a Paging message on Cell1.	<--	Paging	-	-
-	EXCEPTION: Step 2a1 describes behaviour that depends on the UE capability; the "lower case letter" identifies a step sequence that takes place if a capability is supported.	-	-	-	-
2a1	IF the UE needs to request upper layer input before accepting the CS fallback (see ICS), the incoming CS call is accepted at the UE through MMI or AT command.	-	-	-	-
2	The UE transmits an <i>RRConnectionRequest</i> message on Cell1.	-->	<i>RRConnectionRequest</i>	-	-
3	The SS transmits an <i>RRConnectionSetup</i> message on Cell1.	<--	<i>RRConnectionSetup</i>	-	-
4	The UE transmits an <i>RRConnectionSetupComplete</i> message on Cell1.	-->	<i>RRConnectionSetupComplete</i>	-	-
5	Check: Does the UE transmit an <i>ULInformationTransfer</i> message on Cell1? The message includes an <i>EXTENDED SERVICE REQUEST</i> message.	-->	<i>ULInformationTransfer</i> EXTENDED SERVICE REQUEST	1	P

6	The SS transmits a <i>RRConnectionRelease</i> message on Cell 1 with IE <i>redirectedCarrierInfo</i> including geran frequency of Cell 24.	<--	<i>RRConnectionRelease</i>	-	-
6A	Void	-	-	-	-
6B	The UE transmits a CHANNEL REQUEST message on Cell24.	-->	CHANNEL REQUEST	-	-
6C	The SS changes cell 1 power level according to the row "T1"				
7-39	Check: Steps 2 to 34 of the generic test procedure described in TS36.508 subclause 6.4.3.8.1 are performed on Cell24 ?	-	-	2	-
-	At the end of this test procedure sequence, the UE is in end state GERAN idle (G1) according to TS 36.508.	-	-	-	-

13.1.7.3.3 Specific message contents

Table 13.1.7.3.3-1: Void

Table 13.1.7.3.3-2: Void

Table 13.1.7.3.3-3: Paging (step1, Table 13.1.7.3.2-2)

Derivation Path: 36.508 Table 4.6.1-7			
Information Element	Value/remark	Comment	Condition
Paging ::= SEQUENCE {			
pagingRecordList SEQUENCE (SIZE (1..maxPageRec)) OF SEQUENCE {	1 entry		
ue-Identity[1] CHOICE {			
s-TMSI	Assigned during the preamble		
}			
cn-Domain[1]	cs		
}			
}			

Table 13.1.7.3.3-4: ULInformationTransfer (step 5, Table 13.1.7.3.2-2)

Derivation Path: 36.508 Table 4.6.1-25			
Information Element	Value/remark	Comment	Condition
ULInformationTransfer ::= SEQUENCE {			
criticalExtensions CHOICE {			
c1 CHOICE {			
ullInformationTransfer-r8 SEQUENCE {			
dedicatedInfoType CHOICE {			
dedicatedInfoNAS	Set according to 36.508 Table 4.7.2-14A	EXTENDED SERVICE REQUEST	
}			
}			
}			
}			
}			

Table 13.1.7.3.3-5: Void

Table 13.1.7.3.3-6: *RRCConnectionRelease* (step 6, Table 13.1.7.3.2-2)

Derivation Path: 36.508 Table 4.6.1.1-15			
Information Element	Value/remark	Comment	Condition
RRCConnectionRelease ::= SEQUENCE {			
criticalExtensions CHOICE {			
c1 CHOICE {			
rrcConnectionRelease-r8 SEQUENCE {			
redirectedCarrierInfo ::= CHOICE {			
geran	f11		
}			
}			
}			
}			
}			

Table 13.1.7.3.3-7: Void

Table 13.1.7.3.3-8: ATTACH ACCEPT (Preamble)

Derivation Path: 36.508 Table 4.7.2-1			
Information Element	Value/remark	Comment	Condition
EPS network feature support	Not present		

13.1.8 Call setup from E-UTRA RRC_CONNECTED/ CS fallback to GSM with Redirection / MO call

13.1.8.1 Test Purpose (TP)

(1)

```
with { UE in E-UTRA RRC_CONNECTED state }
ensure that {
  when { UE is triggered by upper layers to perform a circuit switched voice call }
  then { UE transmits an ULInformationTransfer message containing an EXTENDED SERVICE REQUEST
message with Service Type IE set to "mobile originating CS fallback or 1xCS fallback" }
}
```

(2)

```
with { UE having transmitted an ULInformationTransfer message containing an EXTENDED SERVICE REQUEST
message with Service Type IE set to "mobile originating CS fallback or 1xCS fallback" }
ensure that {
  when { SS transmits an RRCConnectionRelease message with redirection to a GERAN cell in a same
location area and operating in NMO I }
  then { UE tunes to GERAN cell and completes MO circuit switched voice call setup procedure on
GERAN }
}
```

13.1.8.2 Conformance requirements

References: The conformance requirements covered in the current TC are those listed in TC 8.1.3.6, plus those specified in: TS 23.272, clause 6.3, and TS 24.301, clause 5.6.1.1.

[TS 23.272, clause 6.3]

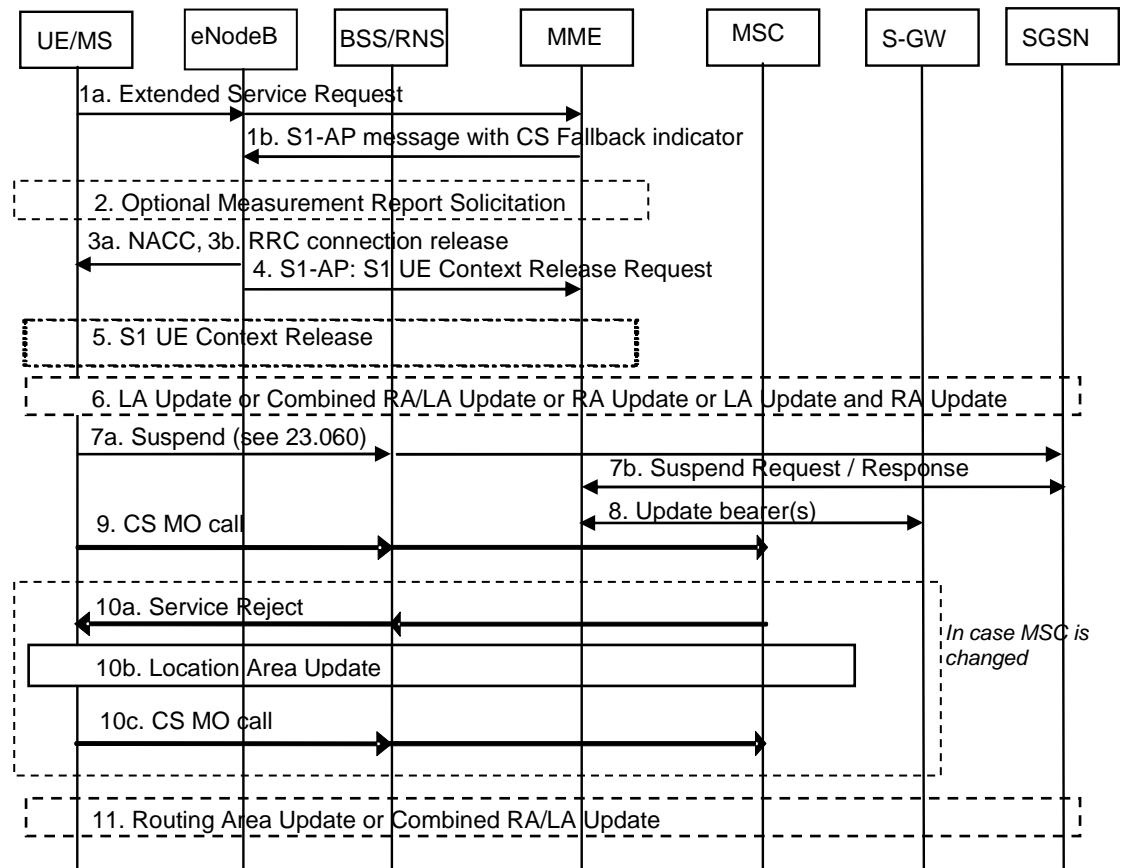

Figure 6.3-1: CS Call Request in E-UTRAN, Call in GERAN/UTRAN without PS HO

- 1a. The UE sends an Extended Service Request (CS Fallback Indicator) to the MME. Extended Service Request message is encapsulated in RRC and S1-AP messages. CS Fallback Indicator indicates MME to perform CS Fallback. The UE only transmits this request if it is attached to CS domain (with a combined EPS/IMSI Attach) and can not initiate an IMS voice session (because e.g. the UE is not IMS registered or IMS voice services are not supported by the serving IP-CAN, home PLMN or UE).
- 1b. The MME sends an S1-AP Request message to eNB that includes a CS Fallback Indicator. This message indicates to the eNB that the UE should be moved to UTRAN/GERAN.
2. The eNodeB may optionally solicit a measurement report from the UE to determine the target GERAN cell to which the redirection procedure will be performed.
- 3a. If the UE and network support inter-RAT cell change order to GERAN and the target cell is GERAN: The eNodeB triggers an inter-RAT cell change order (optionally with NACC) to a GERAN neighbour cell by sending an RRC message to the UE. The inter-RAT cell change order may contain a CS Fallback Indicator which indicates to UE that the cell change order is triggered due to a CS fallback request. If the inter-RAT cell change order contains a CS Fallback Indicator and the UE fails to establish connection to the target RAT, then the UE considers that CS fallback has failed. Service Request procedure is considered to be successfully completed when cell change order procedure is completed successfully.
- 3b. If the UE or the network does not support inter-RAT handover from E-UTRAN to GERAN/UTRAN nor inter-RAT cell change order to GERAN: The eNodeB triggers RRC connection release with redirection to GERAN/UTRAN instead of PS HO or NACC.

NOTE 2: Service Request procedure supervision timer shall be sufficiently long considering the optional measurement reporting at step 2.

4. The eNodeB sends an S1 UE Context Release Request (Cause) message to the MME. Cause indicates that the UE is not available for the PS service.

5. S1 UE Context in the eNodeB is released as specified in TS 23.401 [2].

6. The UE moves to the new cell in GERAN/UTRAN and establishes a radio signalling connection.

If the UE obtains LA information of the new cell (e.g. based on the system information) and the LA of the new cell is different from the one stored in the UE, it performs a Location Area Update or a Combined RA/LA Update procedure in case the target system operates in Network Mode of Operation (NMO) I. Alternatively, in NMO I, the UE in GERAN may perform LA update over the RR connection instead of combined RA/LA update over the packet access, as defined in TS 24.008 [21], clause 4.7.5.2.5, unless enhanced CS establishment in DTM is supported.

If the UE moves to an UTRAN cell and ISR is not active or the RA of the cell is different to the one the UE is registered in, the UE performs a Routing Area Update. This can be performed as part of the combined RA/LA Update procedure when the LA of the new cell is different from the one stored in the UE and the target system operates in NMO I.

7. If the target RAT is GERAN and DTM is not supported, the UE starts the Suspend procedure specified in TS 23.060 [3], clause 16.2.1.1.2. This triggers the SGSN to send a Suspend Request message to the MME. The MME returns a Suspend Response to the SGSN, which contains the MM and PDP contexts of the UE.

8. If PS services are suspended, the MME starts the preservation of non-GBR bearers and the deactivation of GBR bearers.

9. The UE continues with the MO call setup procedure.

10a. In case the MSC serving the 2G/3G cell is different from the MSC that served the UE while camped on E-UTRAN and if the Location Area Update / Combined RA/LA Update was not performed in step 6, the MSC shall reject the call setup service request, if implicit location update is not performed.

10b. A UE detecting that the MSC rejected the service request shall perform the Location Area Update according to existing GERAN or UTRAN procedures.

10c. After completion of the Location Area Update the UE continues with a MO call setup procedure.

11. After the CS voice call is terminated and if the UE is in GERAN and PS services are suspended, then (as specified in TS 23.060 [3]) the UE shall resume PS services by sending a Routing Area Update Request message to the SGSN. The Update Type depends on the mode of operation of the GERAN network, e.g. in mode I a Combined RA/LA Update is used and in mode II or III Routing Area Update is used.

If the UE remains on UTRAN/GERAN after the CS voice call is terminated the UE performs normal mobility management procedures as defined in TS 23.060 [3] and TS 24.008 [21], i.e. if the UE is not registered in the current RA/LA, the UE performs combined RA/LA update procedure when the target system operates in NMO I, or separate LA update and RA update procedures when the target system operates in NMO II/III. Also for NMO I if the UE performed only RA update due to the CS call the UE performs a combined RA/LA update (see TS 23.060 [3], clause 6.3.1) which creates the Gs association.

[TS 24.301, clause 5.6.1.1]

The purpose of the service request procedure is to transfer the EMM mode from EMM-IDLE to EMM-CONNECTED mode and establish the radio and S1 bearers when uplink user data or signalling is to be sent. Another purpose of this procedure is to invoke MO/MT CS fallback procedures.

This procedure is used when:

- the network has downlink signalling pending;
- the UE has uplink signalling pending;
- the UE or the network has user data pending and the UE is in EMM-IDLE mode;
- the UE in EMM-IDLE or EMM-CONNECTED mode has requested to perform mobile originating/terminating CS fallback;
- the network has downlink cdma2000[®] signalling pending; or
- the UE has uplink cdma2000[®] signalling pending.

The service request procedure is initiated by the UE, however, for the downlink transfer of signalling, cdma2000[®] signalling or user data in EMM-IDLE mode, the trigger is given by the network by means of the paging procedure (see subclause 5.6.2).

The UE shall invoke the service request procedure when:

- a) the UE in EMM-IDLE mode receives a paging request with CN domain indicator set to "PS" from the network;
- b) the UE, in EMM-IDLE mode, has pending user data to be sent;
- c) the UE, in EMM-IDLE mode, has uplink signalling pending;
- d) the UE in EMM-IDLE or EMM-CONNECTED mode is configured to use CS fallback and has a mobile originating CS fallback request from the upper layer;
- e) the UE in EMM-IDLE mode is configured to use CS fallback and receives a paging request with CN domain indicator set to "CS", or the UE in EMM-CONNECTED mode is configured to use CS fallback and receives a CS SERVICE NOTIFICATION message;
- f) the UE in EMM-IDLE or EMM-CONNECTED mode is configured to use 1xCS fallback and has a mobile originating 1xCS fallback request from the upper layer;
- g) the UE in EMM-CONNECTED mode is configured to use 1xCS fallback and accepts cdma2000[®] signalling messages containing a 1xCS paging request; or
- h) the UE, in EMM-IDLE mode, has uplink cdma2000[®] signalling pending.

[TS 24.008, clause 4.5.1.1, item d)]

- d) When the MS is IMSI attached for CS services via EMM combined procedures, as described in 3GPP TS 24.301 [120], and the MS is camping on an E-UTRAN cell, the MM sublayer requests EMM to initiate a service request procedure for CS fallback. The MM connection establishment is delayed until the MS changes to a GERAN or UTRAN cell.

If the MS enters a GERAN or UTRAN cell, then the MS shall initiate the MM connection establishment and send a CM SERVICE REQUEST message. If the MS determines that it is in a different location area than the stored location area, the MS shall first initiate a normal location updating procedure or a combined routing area update procedure, depending on Network Mode of Operation. The MM connection establishment is delayed until successful completion of the normal location updating or combined routing area update procedure. In A/Gb mode, if the MS is a non DTM MS, or a DTM MS in a cell not supporting DTM, the MS may perform location area updating procedure instead of combined routing area update procedure in NMO I.

13.1.8.3 Test description

13.1.8.3.1 Pre-test conditions

System Simulator:

- 2 cells, one E-UTRA and one GERAN cell:
 - Cell 1 E-UTRA serving cell
 - Cell 24 suitable neighbour GERAN cell
 - o Cell 24 system information indicates that NMO 1 is used
- The parameters settings and power levels for Cell 1 and Cell 24 are selected according to [18], [5] so that camping on Cell 1 is guaranteed and no cell re-selection to Cell 24 can take place (GERAN priority is lower than serving and $S_{Cell 1} > Thresh_{Cell 1,low}$).
- System information combination 5 as defined in TS 36.508 [18] clause 4.4.3.1 is used in E-UTRA cells.
- Cell 1 and Cell 24 are in the same LA.

UE:

None.

Preamble:

- The UE is in state Generic RB Established (state 3) according to [18].

13.1.8.3.2 Test procedure sequence

Table 13.1.8.3.2-0: instances of cell power level and parameter changes

	Parameter	Unit	Cell 1	Cell 24	Remark
T1	<u>Cell-specific RS EPRE</u>	<u>dBm/15kHz</u>	<u>-115</u>	-	The power levels are such that reselection back to cell 1 should not occur

Table 13.1.8.3.2-1: Main behaviour

St	Procedure	Message Sequence		TP	Verdict
		U - S	Message		
1	Cause the UE to originate CS call. (see Note 1)	-	-	-	-
2	Check: Does the UE transmit an <i>ULInformationTransfer</i> message containing an EXTENDED SERVICE REQUEST with Service Type IE set to "mobile originated CS fallback or 1xCS fallback" on Cell 1?	-->	<i>ULInformationTransfer</i> NAS: EXTENDED SERVICE REQUEST	1	P
3	The SS transmits an <i>RRConnectionRelease</i> message on Cell 1 with IE <i>redirectedCarrierInfo</i> including ARFCN of Cell 24.	<--	<i>RRConnectionRelease</i>	-	-
3A	The UE transmits a CHANNEL REQUEST message on Cell24.	-->	CHANNEL REQUEST	-	-
3B	The SS changes cell 1 power level according to the row "T1"				
4-34	Check: Steps 2 to 32 of the generic test procedure described in TS36.508 subclause 6.4.3.8.2 are performed on Cell24 ?	-	-	2	P
-	At the end of this test procedure sequence, the UE is in end state GERAN idle (G1) according to TS 36.508.	-	-	-	-
Note 1: The trigger in step 1 is the same as in the generic procedure in 36.508 clause 6.4.3.5.					

13.1.8.3.3 Specific message contents

Table 13.1.8.3.3-1: Void

Table 13.1.8.3.3-2: Void

Table 13.1.8.3.3-3: Void

Table 13.1.8.3.3-4: *ULInformationTransfer* (step 2, Table 13.1.8.3.2-2)

Derivation Path: 36.508 Table 4.6.1-25			
Information Element	Value/remark	Comment	Condition
ULInformationTransfer ::= SEQUENCE {			
criticalExtensions CHOICE {			
c1 CHOICE {			
ulInformationTransfer-r8 SEQUENCE {			
dedicatedInfoType CHOICE {			
dedicatedInfoNAS	Set according to Table 13.1.8.3.3-5	EXTENDED SERVICE REQUEST	
}			
}			
}			
}			
}			

Table 13.1.8.3.3-5: EXTENDED SERVICE REQUEST (step 2, Table 13.1.8.3.2-2)

Derivation Path: 36.508 Table 4.7.2-14A			
Information Element	Value/remark	Comment	Condition
Service type	0000 'mobile originating CS fallback or 1xCS fallback'		
CSFB response	Not present		

Table 13.1.8.3.3-6: *RRCConnectionRelease* (step 3, Table 13.1.8.3.2-2)

Derivation Path: 36.508 Table 4.6.1.1-15			
Information Element	Value/remark	Comment	Condition
RRCConnectionRelease ::= SEQUENCE {			
criticalExtensions CHOICE {			
c1 CHOICE {			
rrcConnectionRelease-r8 SEQUENCE {			
redirectedCarrierInfo ::= CHOICE {			
Geran	f11		
}			
}			
}			

Table 13.1.8.3.3-7: Void

Table 13.1.8.3.3-8: ATTACH ACCEPT (Preamble)

Derivation Path: 36.508 Table 4.7.2-1			
Information Element	Value/remark	Comment	Condition
EPS network feature support	Not present		

13.1.9 Call setup from E-UTRA RRC_IDLE / CS fallback to GSM with CCO without NACC / MO call

13.1.9.1 Test Purpose (TP)

(1)

```

with { UE in E-UTRA RRC_CONNECTED state having requested CS call setup }
ensure that {
  when { UE receives a MobilityFromEUTRACCommand message including a cs-FallbackIndicator set to 'true', a targetRAT-Type set to 'geran' and purpose set to 'cellChangeOrder' and no 'networkControlOrder' }
  then { UE acquires networkControlOrder and establishes the connection to the target cell indicated in the CellChangeOrder }
}
    
```

13.1.9.2 Conformance requirements

References: The conformance requirements covered in the present TC are specified in: TS 23.272, clauses 6.4 and 6.3, and, TS 36.331, clause 5.4.3.3, 5.3.9.2, 5.3.12 and B.1.

[TS 23.272, clause 6.4]

Mobile Originating call in Idle Mode procedure is specified by reusing the Mobile Originating Call in Active mode procedure with Extended Service Request (CS Fallback Indicator) to the MME. The UE is transited to ECM-CONNECTED mode by following the applicable procedures specified in TS 23.401 [2].

[TS 23.272, clause 6.3]

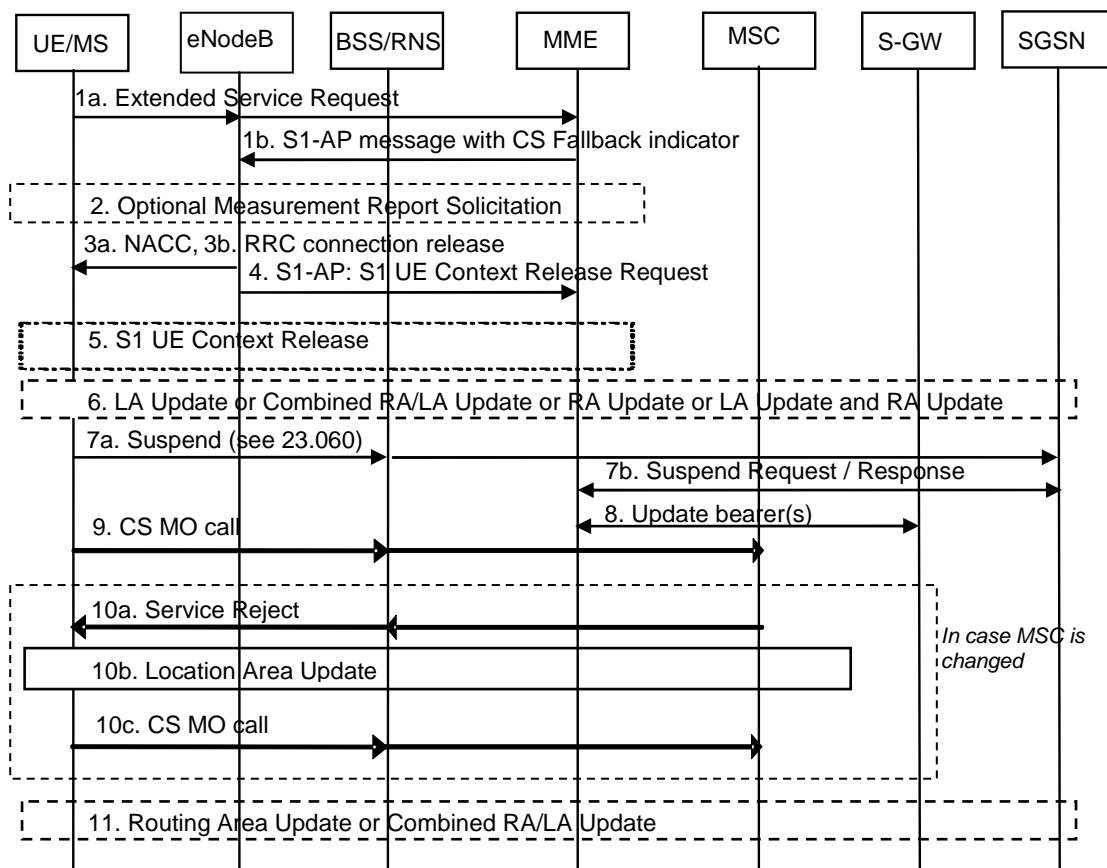

Figure 6.3-1: CS Call Request in E-UTRAN, Call in GERAN/UTRAN without PS HO

1a. The UE sends an Extended Service Request (CS Fallback Indicator) to the MME. Extended Service Request message is encapsulated in RRC and S1-AP messages. CS Fallback Indicator indicates MME to perform CS

Fallback. The UE only transmits this request if it is attached to CS domain (with a combined EPS/IMSI Attach) and can not initiate an IMS voice session (because e.g. the UE is not IMS registered or IMS voice services are not supported by the serving IP-CAN, home PLMN or UE).

...

2. The eNodeB may optionally solicit a measurement report from the UE to determine the target GERAN cell to which the redirection procedure will be performed.
- 3a. If the UE and network support inter-RAT cell change order to GERAN and the target cell is GERAN: The eNodeB triggers an inter-RAT cell change order (optionally with NACC) to a GERAN neighbour cell by sending an RRC message to the UE. The inter-RAT cell change order may contain a CS Fallback Indicator which indicates to UE that the cell change order is triggered due to a CS fallback request. If the inter-RAT cell change order contains a CS Fallback Indicator and the UE fails to establish connection to the target RAT, then the UE considers that CS fallback has failed. Service Request procedure is considered to be successfully completed when cell change order procedure is completed successfully.

...

NOTE 2: Service Request procedure supervision timer shall be sufficiently long considering the optional measurement reporting at step 2.

...

6. The UE moves to the new cell in GERAN/UTRAN and establishes a radio signalling connection.
- ...
9. The UE continues with the MO call setup procedure. An ICS UE (as defined in TS 23.292 [25]) shall not use Gm (TS 23.292 [25]) procedures to establish the call.

NOTE 3: For an ICS user, in order to receive a consistent service experience the ICS UE needs to add ICS Service Control Signalling Path once the call is established, as described in TS 23.292 [25].

...

If the UE remains on UTRAN/GERAN after the CS voice call is terminated the UE performs normal mobility management procedures as defined in TS 23.060 [3] and TS 24.008 [21], i.e. if the UE is not registered in the current RA/LA, the UE performs combined RA/LA update procedure when the target system operates in NMO I, or separate LA update and RA update procedures when the target system operates in NMO II/III. Also for NMO I if the UE performed only RA update due to the CS call the UE performs a combined RA/LA update (see TS 23.060 [3], clause 6.3.1) which creates the Gs association.

[TS 36.331, clause 5.4.3.3]

The UE shall be able to receive a *MobilityFromEUTRACCommand* message and perform a cell change order to GERAN, even if no prior UE measurements have been performed on the target cell.

The UE shall:

- 1> stop timer T310, if running;
- 1> if the *MobilityFromEUTRACCommand* message includes the *purpose* set to 'handover':
- ...
- 1> else if the *MobilityFromEUTRACCommand* message includes the *purpose* set to 'cellChangeOrder':
 - 2> start timer T304 with the timer value set to *t304*, as included in the *MobilityFromEUTRACCommand* message;
 - 2> if the *targetRAT-Type* is set to 'geran':
 - 3> if *networkControlOrder* is included in the *MobilityFromEUTRACCommand* message:
 - 4> apply the value as specified in TS 44.060 [36];
 - 3> else:

4> acquire *networkControlOrder* and apply the value as specified in TS 44.060 [36];

3> use the contents of *systemInformation*, if provided, as the system information to begin access on the target GERAN cell;

NOTE 2: The *systemInformation* is constructed in the same way as in 2G to 2G NACC, i.e. the PSI messages are encoded as such, whereas the SI messages exclude 2 octets of headers, see TS 44.060[36].

2> establish the connection to the target cell indicated in the *CellChangeOrder*;

NOTE 3: The criteria for success or failure of the cell change order to GERAN are specified in TS 44.060[36].

[TS 36.331, clause 5.3.9.2]

Upon successfully completing the handover or the cell change order, the UE shall:

1> perform the actions upon leaving RRC_CONNECTED as specified in 5.3.12, with release cause 'other';

1> stop timer T304, if running;

[TS 36.331, clause 5.3.12]

Upon leaving RRC_CONNECTED, the UE shall:

1> reset MAC;

1> stop all timers that are running except T320;

1> release all radio resources, including release of the RLC entity, the MAC configuration and the associated PDCP entity for all established RBs;

1> indicate the release of the RRC connection to upper layers together with the release cause;

[TS 36.331, clause B.1]

This annex contains the definitions of the bits in field *featureGroupIndicators*.

In this release of the protocol, the UE shall include the field *featureGroupIndicators* in the IE *UE-EUTRA-Capability*. All the functionalities defined within the field *featureGroupIndicators* defined in Table B.1-1 are mandatory for the UE, if the related capability (frequency band, RAT or SR-VCC) is also supported. For a specific indicator, if all functionalities for a feature group listed in Table B.1-1 have been implemented and tested, the UE shall set the indicator as one (1), else (i.e. if any one of the functionalities in a feature group listed in Table B.1-1, which have not been implemented or tested), the UE shall set the indicator as zero (0).

...

Table B.1-1: Definitions of feature group indicators

Index of indicator (bit number)	Definition (description of the supported functionality, if indicator set to one)	Notes
...		
10	- EUTRA RRC_CONNECTED to GERAN (Packet_) Idle by Cell Change Order - EUTRA RRC_CONNECTED to GERAN (Packet_) Idle by Cell Change Order with NACC (Network Assisted Cell Change)	
...		

13.1.9.3 Test description

13.1.9.3.1 Pre-test conditions

System Simulator:

- Cell 1 serving cell

- Cell 24 suitable neighbour cell
- The parameters settings and power levels for Cell 1 and Cell 24 are selected according to [18], [5] so that camping on Cell 1 is guaranteed and no cell re-selection to Cell 24 can take place (GERAN priority is lower than serving and $S_{Cell 1} > Thresh_{Cell 1,low}$).
- System information combination 5 as defined in TS 36.508 [18] clause 4.4.3.1 is used in E-UTRA cells.

UE:

None.

Preamble:

- The UE is in state Registered, Idle Mode (state 2) on Cell 1 according to [18].

13.1.9.3.2 Test procedure sequence

Table 13.1.9.3.2-0: instances of cell power level and parameter changes

	Parameter	Unit	Cell 1	Cell 24	Remark
T1	Cell-specific RS EPRE	dBm/15kHz	-115	-	The power levels are such that reselection back to cell 1 should not occur

Table 13.1.9.3.2-1: Main behaviour

St	Procedure	Message Sequence		TP	Verdict
		U - S	Message		
1	Cause the UE to originate CS call. (see Note 1)	-	-	-	-
2	Generic test procedure 'UE triggered CS call' as described in 36.508, clause 6.4.3.5 is performed.	-		-	-
3	The SS transmits a <i>SecurityModeCommand</i> message on Cell 1.	<--	<i>SecurityModeCommand</i>	-	-
4	The UE transmits a <i>SecurityModeComplete</i> message on Cell 1.	-->	<i>SecurityModeComplete</i>	-	-
5	The SS transmits an <i>RRCConnectionReconfiguration</i> message on Cell 1.	<--	<i>RRCConnectionReconfiguration</i>	-	-
6	The UE transmits an <i>RRCConnectionReconfigurationComplete</i> message on Cell 1.	-->	<i>RRCConnectionReconfigurationComplete</i>	-	-
7	The SS transmits a <i>MobilityFromEUTRACommand</i> message on Cell 1 including a <i>cs-FallbackIndicator</i> set to 'true', a <i>targetRAT-Type</i> set to 'geran', <i>purpose</i> set to 'cellChangeOrder' and no 'networkControlOrder'	<--	<i>MobilityFromEUTRACommand</i>	-	-
8	Void	-	-	-	-
8A	The UE transmits a CHANNEL REQUEST message on Cell24.	-->	CHANNEL REQUEST	-	-
8B	The SS changes cell 1 power level according to the row "T1"				
9-39	Check: Does the steps 2 to 32 of the generic test procedure described in TS36.508 subclause 6.4.3.8.2 are performed on Cell24?	-	-	1	-
-	At the end of this test procedure sequence, the UE is in end state GERAN idle (G1) according to TS 36.508.	-	-	-	-
Note 1: See generic procedure in 36.508 clause 6.4.3.5 for the trigger.					

13.1.9.3.3 Specific message contents

Table 13.1.4.3.3-1: RRCConnectionReconfiguration (step 5, Table 13.1.9.3.2-1)

Derivation Path: 36.508 Table 4.6.1-8, condition SRB2-DRB(1, 0)

Table 13.1.9.3.3-2: MobilityFromEUTRACommand (step 7, Table 13.1.9.3.2-1)

Derivation Path: 36.508, Table 4.6.1-6			
Information Element	Value/remark	Comment	Condition
MobilityFromEUTRACommand ::= SEQUENCE {			
criticalExtensions CHOICE {			
c1 CHOICE{			
mobilityFromEUTRACommand-r8 SEQUENCE {			
cs-FallbackIndicator	true		
purpose CHOICE{			
cellChangeOrder SEQUENCE {			
t304	ms4000		
targetRAT-Type CHOICE{			
geran SEQUENCE {			
physCellId	TS 36.508, 6.3.1.4		
carrierFreq	TS 36.508, 6.3.1.4		
networkControlOrder	Not present		
systemInformation	Not present		
}			
}			
}			
}			
}			
}			
}			
}			

Table 13.1.9.3.3-8: Void**Table 13.1.9.3.3-9: ATTACH ACCEPT (Preamble)**

Derivation Path: 36.508 Table 4.7.2-1			
Information Element	Value/remark	Comment	Condition
EPS network feature support	Not present		

13.1.10 Call setup from E-UTRA RRC_CONNECTED / CS fallback to GSM with CCO without NACC / MT call

13.1.10.1 Test Purpose (TP)

(1)

```

with { UE in E-UTRA RRC_CONNECTED state with an established S1 connection and the MME did not return
the "SMS-only" indication to the UE during Attach or Combined TA/LA Update procedures }
ensure that {
  when { UE receives a DLInformationTransfer message containing a CS SERVICE NOTIFICATION message }
  then { UE transmits an ULInformationTransfer message containing an EXTENDED SERVICE REQUEST
message with Service Type IE set to "mobile terminating CS fallback or 1xCS fallback" }
}

```

(2)

```

with { UE having transmitted an ULInformationTransfer message containing an EXTENDED SERVICE REQUEST
message with Service Type IE set to "mobile terminating CS fallback or 1xCS fallback" }
ensure that {
  when { UE receives a MobilityFromEUTRACommand message including a cs-FallbackIndicator set to
'true', a targetRAT-Type set to 'geran' and purpose set to 'cellChangeOrder' and no
'networkControlOrder' }
}

```

```

then { UE acquires networkControlOrder and establishes the connection to the target RAT and
target cell indicated in the CellChangeOrder }
}

```

(3)

```

with { UE having establishes the connection to GERAN }
ensure that {
when { GERAN does not support DTM }
then { UE requests GPRS Suspension and completes the establishment of the MT CS call }
}

```

13.1.10.2 Conformance requirements

References: The conformance requirements covered in the present TC are specified in: TS 23.272, clause 7.4, TS 24.301, clause 5.6.2.3, TS 23.060, clause 16.2.1.1.2 and TS 44.018, clause 3.4.25.3.

[TS 23.272, clause 7.4]

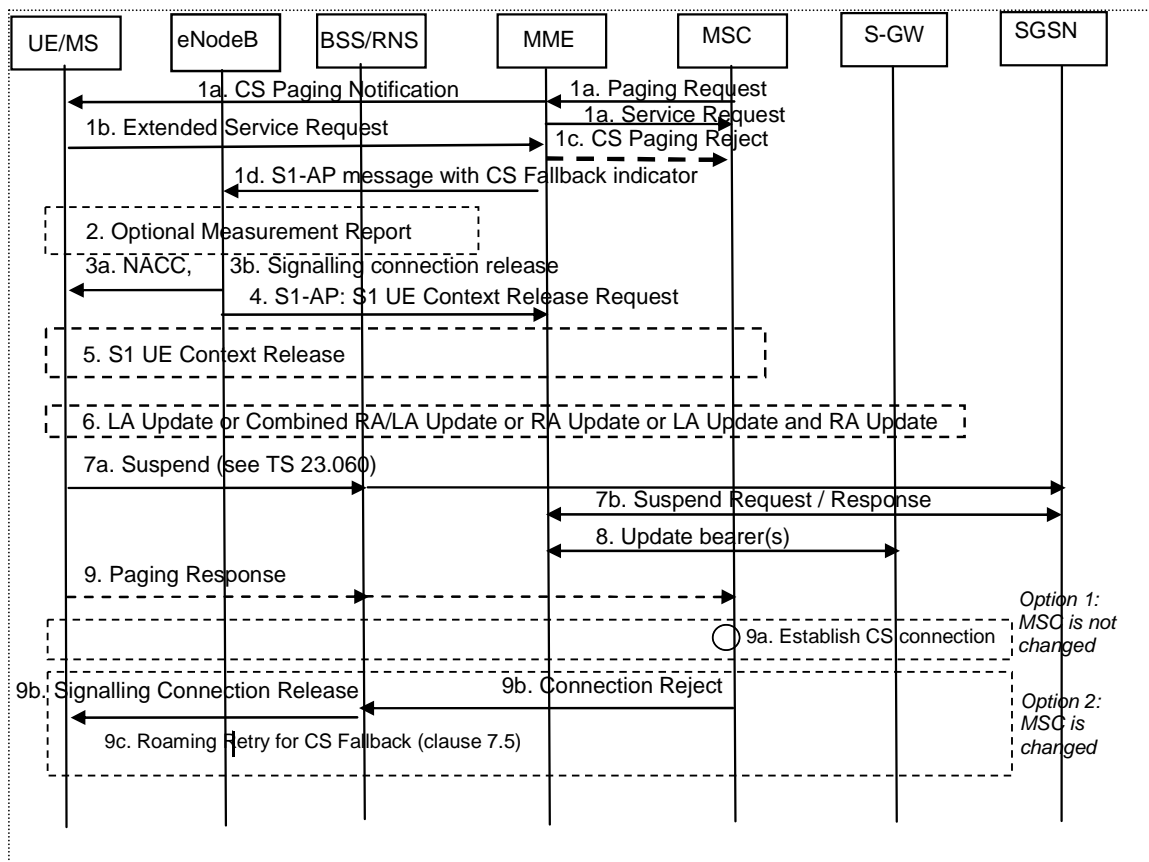

Figure 7.4-1: CS Page in E-UTRAN, Call in GERAN/UTRAN without PS HO

1a. The MSC receives an incoming voice call and responds by sending a Paging Request (IMSI or TMSI, optional Caller Line Identification and Connection Management information) to the MME over a SGs interface. The MSC only sends a CS Page for an UE that provides location update information using the SGs interface. In active mode the MME has an established S1 connection and if the MME did not return the "SMS-only" indication to the UE during Attach or Combined TA/LA Update procedures, the MME reuses the existing connection to relay the CS Service Notification to the UE.

If the MME returned the "SMS-only" indication to the UE during Attach or Combined TA/LA Update procedures, the MME shall not send the CS Service Notification to the UE and sends Paging Reject towards MSC to stop CS Paging procedure, and this CSFB procedure stops.

The eNodeB forwards the paging message to the UE. The message contains CN Domain indicator and, if received from the MSC, the Caller Line Identification if available and needed.

The MME immediately sends the SGs Service Request message to the MSC. Receipt of the SGs Service Request message stops the MSC retransmitting the SGs interface Paging message.

NOTE 1: The pre-configured policy may be used by UE to avoid being disturbed without Caller Line Identification display and the detailed handling is to be decided by CT WG1 and CT WG6.

NOTE 2: This procedure can also take place immediately after MSC receives MAP_PRN from HSS, if pre-paging is deployed. Caller Line Identification is also provided in the case of pre-paging.

NOTE 3: In order to avoid the calling party experiencing a potentially long period of silence, the MSC may use the SGs Service Request message as a trigger to inform the calling party that the call is progressing.

1b. UE sends an Extended Service Request (CS Fallback Indicator, Reject or Accept) message to the MME. Extended Service Request message is encapsulated in RRC and S1-AP messages. CS Fallback Indicator indicates MME to perform CS Fallback. The UE may decide to reject CSFB based on Caller Line Identification.

1c. Upon receiving the Extended Service Request (CSFB, Reject), the MME sends Paging Reject towards MSC to stop CS Paging procedure and this CSFB procedure stops.

1d. The MME sends a Service Accept message encapsulated in an S1-AP message that also includes the UE Radio Capabilities and a CS Fallback Indicator. This message: indicates to the eNodeB that the UE should be moved to UTRAN/GERAN.

2. The eNodeB may optionally solicit a measurement report from the UE to determine the target GERAN cell to which the redirection procedure will be performed.

3a. If the UE and network support inter-RAT cell change order to GERAN and the target cell is GERAN: The eNodeB triggers an inter-RAT cell change order (optionally with NACC) to a GERAN neighbour cell by sending an RRC message to the UE. The inter-RAT cell change order may contain a CS Fallback Indicator which indicates to UE that the cell change order is triggered due to a CS fallback request. If the inter-RAT cell change order contains a CS Fallback Indicator and the UE fails to establish connection to the target RAT, then the UE considers that CS fallback has failed. Service Request procedure is considered to be successfully completed when cell change order procedure is completed successfully.

3b. If the UE or the network does not support inter-RAT handover from E-UTRAN to GERAN/UTRAN nor inter-RAT cell change order to GERAN: The eNodeB triggers RRC connection release with redirection to GERAN/UTRAN instead of PS HO or NACC.

NOTE 4: Service Request procedure supervision timer shall be sufficiently long considering the optional measurement reporting at step 2.

4. The eNodeB sends an S1 UE Context Release Request (Cause) message to the MME. Cause indicates that the UE is not available for PS service.

5. S1 UE Context in the eNodeB is released as specified in TS 23.401 [2].

6. The UE moves to the new cell in GERAN/UTRAN, establishes a radio signalling connection.

If the UE cannot determine the LA information of the new cell (e.g. based on the system information) or the LA of the new cell is different from the one stored in the UE, the UE should initiate a Location Area Update or a Combined RA/LA Update procedure as specified in TS 23.060 [3] for the different Network Modes of Operation (NMO). In NMO I, the UE in GERAN may perform LA update over the RR connection instead of combined RA/LA update over the packet access as defined in TS 24.008 [21], clause 4.7.5.2.5, unless enhanced CS establishment in DTM is supported. Further the UE performs any Routing Area Update procedure as specified in TS 23.060 [3].

NOTE 5: In UTRAN, the UE does not need to wait for the LAI from the RNC, but the RNC also does not delay sending the LAI to the UE as the RAN Mobility Information might be used as a trigger for the UE to initiate NAS procedures.

When the MSC receives an LA Update Request, it shall check for pending terminating CS calls and maintain the CS signalling connection after the Location Area Update procedure for pending terminating CS calls.

7. If the target RAT is GERAN and DTM is not supported, the UE starts the Suspend procedure specified in TS 23.060 [3], clause 16.2.1.1.2. This triggers the SGSN to send a Suspend Request message to the MME. The MME returns a Suspend Response to the SGSN, which contains the MM and PDP contexts of the UE.
8. If PS services are suspended, the MME starts the preservation of non-GBR bearers and the deactivation of GBR bearers.
9. If the UE does not initiate a LAU procedure the UE responds to the paging by sending a Paging Response message as specified in TS 44.018 [4] or TS 25.331 [7]. When received at the BSS/RNS, the Paging Response is forwarded to the MSC.

NOTE 5: The MSC should be prepared to receive a Paging Response after a relatively long time from when the CS Paging Request was sent (step 1a).

- 9a. After performing the LAU procedure or after receiving the Paging Response the MSC shall establish the CS call if the UE is allowed in the LA.
- 9b. If the UE is not registered in the MSC that receives the Paging Response or the UE is not allowed in the LA, the MSC shall reject the Paging Response by releasing the A/Iu-cs connection. The BSS/RNS in turn releases the signalling connection for CS domain.
- 9c. The signalling connection release shall trigger the UE to obtain the LAI, which causes the initiation of a Location Area Update procedure as specified in TS 23.060 [3] for the different Network Modes of Operation (NMO).

The Location Area Update triggers the Roaming Retry for CS Fallback procedure as defined in clause 7.5.

With the exception of step 1c, above, Call Forwarding (see TS 23.082 [28]) is performed on the basis of the TS 24.008 [21] signalling received on the GERAN/UTRAN cell.

After the CS voice call is terminated and if the UE is still in GERAN and PS services are suspended, then (as specified in TS 23.060 [3]) the UE shall resume PS services by initiating a Routing Area Update procedure.

If the UE remains on UTRAN/GERAN after the CS voice call is terminated the UE performs normal mobility management procedures as defined in TS 23.060 [3] and TS 24.008 [21].

[TS 24.301, clause 5.6.2.3]

The network may initiate the paging procedure for non-EPS services when the UE is IMSI attached for non-EPS services (see example in figure 5.6.2.3.1).

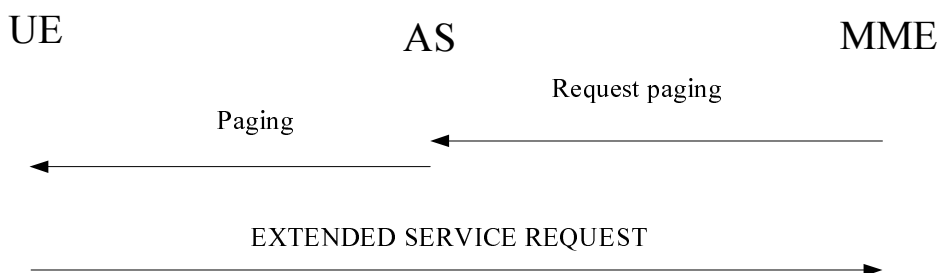

Figure 5.6.2.3.1: Paging procedure for CS fallback to A/Gb or lu mode

To initiate the procedure when no NAS signalling connection exists, the EMM entity in the network requests the lower layer to start paging (see 3GPP TS 36.300 [20], 3GPP TS 36.413 [23]). The paging message includes a CN domain indicator set to "CS" in order to indicate that this is paging for CS fallback.

NOTE: The timer T3413 is not started in the network when the paging procedure is initiated for CS fallback.

To notify the UE about an incoming mobile terminating CS service when a NAS signalling connection exists, the EMM entity in the network shall send a CS SERVICE NOTIFICATION message. This message may also include CS service related parameters (e.g. Calling Line Identification, SS or LCS related parameters).

Upon reception of a paging indication, the UE shall respond with an EXTENDED SERVICE REQUEST. If the paging is received in EMM-IDLE mode, the UE shall respond immediately. If the paging is received as NAS CS NOTIFICATION message in EMM-CONNECTED mode, the UE may request upper layers input i.e. to accept or reject CS fallback before responding with an EXTENDED SERVICE REQUEST. The response is indicated in the CSFB response information element in the EXTENDED SERVICE REQUEST message in both EMM-IDLE and EMM-CONNECTED modes.

[TS 23.060, clause 16.2.1.1.2]

The Suspend and Resume procedure for inter-SGSN is illustrated in Figure 100.

This describes the scenario where the old cell and the new cell are handled by different SGSN's, i.e. suspend message is received in an SGSN that is different from the SGSN currently handling the packet data transmission.

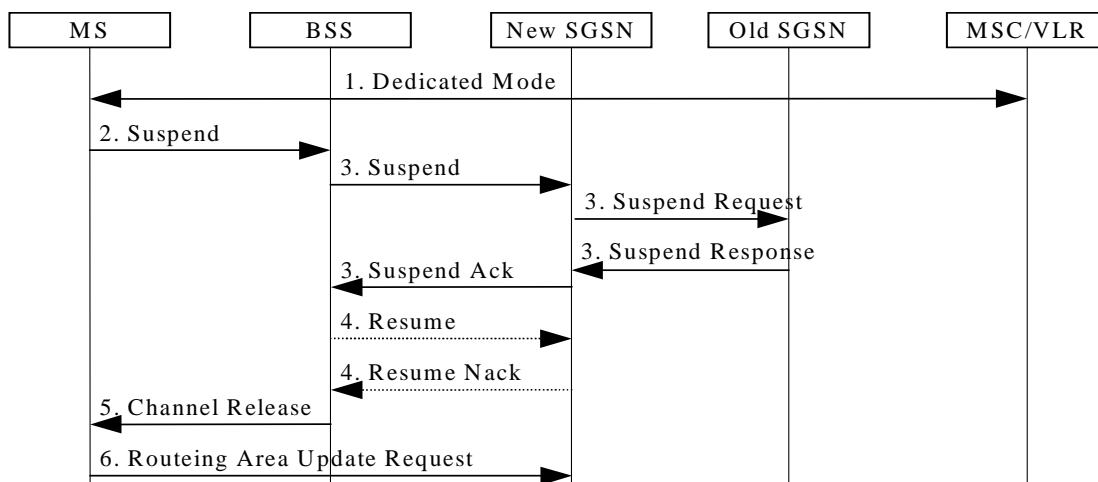

Figure 100: Suspend and Resume Procedure for inter-SGSN

- 1) During CS connection, a DTM MS performs handover from a cell supporting DTM to a cell not supporting DTM.
- 2) The MS sends an RR Suspend (TLLI, RAI) message to the BSS.

[TS 44.018, clause 3.4.25.3]

The GPRS suspension procedure shall be used to suspend GPRS services:

...

- b) when the GPRS attached mobile station is in a cell that does not support DTM and a circuit switched service is initiated.

...

In case b), the GPRS suspension procedure is initiated by the mobile station by sending a GPRS SUSPENSION REQUEST message with the suspension cause set to "DTM not supported in the cell". This can be done as early as possible after access but shall be done after sending a CLASSMARK CHANGE message.

13.1.10.3 Test description

13.1.10.3.1 Pre-test conditions

System Simulator:

- 2 cells, one E-UTRA and one GERAN cell and same Location areas but different Routing areas; DTM is not supported on the GERAN:
 - Cell 1 serving cell
 - Cell 24 suitable neighbour cell.
 - The parameters settings and power levels for Cell 1 and Cell 24 are selected according to [18], [5] so that camping on Cell 1 is guaranteed and no cell re-selection to Cell 24 can take place (GERAN priority is lower than serving and $S_{Cell 1} > Thresh_{Cell 1,low}$).
 - System information combination 5 as defined in TS 36.508 [18] clause 4.4.3.1 is used in E-UTRA cells.

UE:

- None.

Preamble:

- The UE is in state Loopback activated (state 4) on cell 1 according to [18] using UE test loop mode B.

13.1.10.3.2 Test procedure sequence

Table 13.1.10.3.2-0: instances of cell power level and parameter changes

	Parameter	Unit	Cell 1	Cell 24	Remark
T1	Cell-specific RS EPRE	dBm/15kHz	-115	-	The power levels are such that reselection back to cell 1 should not occur

Table 13.1.10.3.2-1: Main behaviour

St	Procedure	Message Sequence		TP	Verdict
		U - S	Message		
1	The SS transmits one IP packet to the UE on the DRB associated with the default EPS bearer context on Cell 1.	<--	IP packet	-	-
-	EXCEPTION: In parallel to the events described in steps 2 to 4 the steps specified in Table 13.1.10.3.2-2 may take place	-	-	-	-
2	The SS transmits a <i>DLInformationTransfer</i> message on Cell 1 containing a CS SERVICE NOTIFICATION message.	<--	<i>DLInformationTransfer</i> NAS: CS SERVICE NOTIFICATION	-	-
-	EXCEPTION: Step 3a1 describes behaviour that depends on the UE capability; the "lower case letter" identifies a step sequence that takes place if a capability is supported.	-	-	-	-
3a1	IF the UE needs to request upper layer input before accepting the CS fallback, the incoming CS call is accepted at the UE through MMI or AT command.	-	-	-	-
4	Check: Does the UE transmit an <i>ULInformationTransfer</i> message containing an EXTENDED SERVICE REQUEST with Service Type IE set to "mobile terminating CS fallback or 1xCS fallback" on Cell 1?	-->	<i>ULInformationTransfer</i> NAS: EXTENDED SERVICE REQUEST	1	P
5	The SS transmits a <i>MobilityFromEUTRACommand</i> message on Cell 1.	<--	<i>MobilityFromEUTRACommand</i>	-	-
-	The following messages are to be observed on Cell 24 unless explicitly stated otherwise.	-	-	-	-
5A-6A	Void	-	-	-	-
6B	The UE transmits a CHANNEL REQUEST message on Cell24.	-->	CHANNEL REQUEST	-	-
6C	The SS changes cell 1 power level according to the row "T1"				
7-39	Check: Steps 2 to 34 of the generic test procedure described in TS36.508 subclause 6.4.3.8.1 are performed on Cell24?	-	-	3	-
-	At the end of this test procedure sequence, the UE is in end state GERAN idle (G1) according to TS 36.508.	-	-	-	-

Table 13.1.10.3.2-2: Parallel behaviour

St	Procedure	Message Sequence		TP	Verdict
		U - S	Message		
1	The UE loops back the IP packet received in Step 1 on the RAB associated with the PDP context active on Cell 1.	-->	IP packet	-	-

13.1.10.3.3 Specific message contents

Table 13.1.10.3.3-1: ATTACH ACCEPT for cell 1 (preamble)

Derivation Path: 36.508 table 4.7.2-1			
Information Element	Value/remark	Comment	Condition
EPS attach result	'0010'B	combined EPS/IMSI attach	
Additional update result	Not present		

Table 13.1.10.3.3-2: Void

Table 13.1.10.3.3-3: *DLInformationTransfer* (step 2, Table 13.1.10.3.2-1)

Derivation Path: 36.508 Table 4.6.1-3			
Information Element	Value/remark	Comment	Condition
DLInformationTransfer ::= SEQUENCE {			
criticalExtensions CHOICE {			
c1 CHOICE {			
dlInformationTransfer-r8 SEQUENCE {			
dedicatedInfoType CHOICE {			
dedicatedInfoNAS	Set according to 36.508 Table 4.7.2-8A	CS SERVICE NOTIFICATION	
}			
}			
}			
}			
}			

Table 13.1.10.3.3-3A: Void

Table 13.1.10.3.3-4: Void

Table 13.1.10.3.3-5: *MobilityFromEUTRACommand* (step 5, Table 13.1.10.3.2-1)

Derivation Path: 36.508, Table 4.6.1-6			
Information Element	Value/remark	Comment	Condition
MobilityFromEUTRACommand ::= SEQUENCE {			
criticalExtensions CHOICE {			
c1 CHOICE{			
mobilityFromEUTRACommand-r8 SEQUENCE {			
cs-FallbackIndicator	true		
purpose CHOICE{			
cellChangeOrder SEQUENCE {			
t304	ms4000		
targetRAT-Type CHOICE{			
geran SEQUENCE {			
physCellId	TS 36.508, 6.3.1.4		
carrierFreq	TS 36.508, 6.3.1.4		
networkControlOrder	Not present		
systemInformation	Not present		
}			
}			
}			
}			
}			
}			
}			
}			

Table 13.1.10.3.3-6: ATTACH ACCEPT (Preamble)

Derivation Path: 36.508 Table 4.7.2-1			
Information Element	Value/remark	Comment	Condition
EPS network feature support	Not present		

13.1.11 Call setup from E-UTRA RRC_IDLE / CS fallback to GSM with PSHO / EDTM not supported / MT call

13.1.11.1 Test Purpose (TP)

(1)

```
with { UE in E-UTRA RRC_IDLE state }
ensure that {
  when { UE receives a Paging message with CN domain indicator set to "CS" }
  then { UE transmits an ULInformationTransfer message containing an EXTENDED SERVICE REQUEST
message with Service Type IE set to "mobile terminating CS fallback or 1xCS fallback" }
}
```

(2)

```
with { UE having transmitted an ULInformationTransfer message containing an EXTENDED SERVICE REQUEST
message with Service Type IE set to "mobile terminating CS fallback or 1xCS fallback" }
ensure that {
  when { SS transmits a MobilityFromEUTRACommand message with handover to a GERAN cell in a
different location area and operating in NMO I }
  then { UE handovers to GERAN cell }
}
```

(3)

```
with { UE having transmitted an ULInformationTransfer message containing an EXTENDED SERVICE REQUEST
message with Service Type IE set to "mobile terminating CS fallback or 1xCS fallback" and handed over
to GERAN cell and initiated a RA Update procedure }
ensure that {
  when { UE has handed over to GERAN cell }
  then { UE sets up MT CS call on GSM cell }
}
```

13.1.11.2 Conformance requirements

References: The conformance requirements covered in the present TC are specified in: TS 23.272, clauses 6.4 and 6.3, and, TS 36.331, clause 5.4.3.3.

[TS 23.272, clause 7.2]

The procedure for Mobile Terminating Call in idle mode is illustrated in figure 7.2-1, in the normal case. Clause 6.6 describes the procedure when the procedure is rejected by the MME.

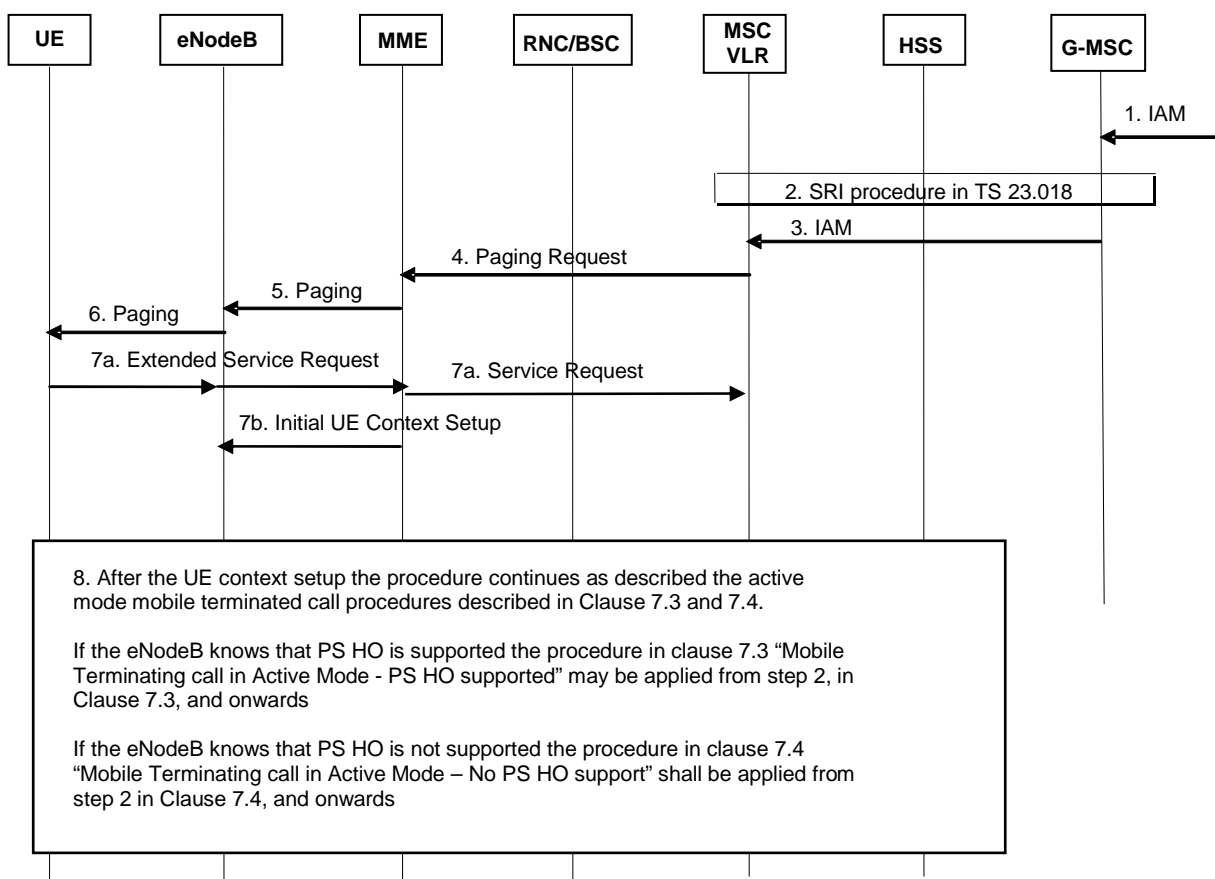

Figure 7.2-1: Mobile Terminating Call in idle mode

1. G-MSC receives IAM.
2. G-MSC retrieves routing information of the terminating UE by Send Routing Info procedures as specified in TS 23.018 [5].
3. G-MSC sends IAM to the MSC on the terminating side as specified in TS 23.018 [5].
4. The MME receives a Paging Request (IMSI, VLR TMSI, Location Information) message from the MSC over a SGs interface. If the TMSI is received from the MSC, it is used by the MME to find the S-TMSI which is used as the paging address on the radio interface. If the IMSI is received from the MSC, the IMSI shall be used as the paging address on the radio interface. If location information is reliably known by MME (i.e. MME stores the list of TAs), the MME shall page the UE in all the TAs. If the MME does not have a stored TA list for the UE, the MME should use the location information received from the MSC to page the UE.

NOTE 1: This procedure takes place before step 3, immediately after MSC receives MAP_PRN from HSS, if pre-paging is deployed.

If the MME receives a Paging Request message for an UE which is considered as detach for EPS services, the MME sends the Paging reject message to the MSC with an appropriate cause value. This rejection triggers the MSC to page the UE over A or Iu-cs interface.

NOTE 2: In case of a CS fallback capable UE in NMO II or III, there is a case where, for example, the MME releases the SGs association due to the UE idle mode mobility while the VLR still maintains the SGs association.

5. If the MME did not return an "SMS-only" indication to the UE during Attach or Combined TA/LA Update procedures, the MME sends a Paging (as specified in TS 23.401 [2]) message to each eNodeB. The Paging message includes a suitable UE Identity (i.e. S-TMSI or IMSI) and a CN Domain Indicator that indicates which domain (CS or PS) initiated the paging message. In this case it shall be set to "CS" by the MME.

If the MME returned the "SMS-only" indication to the UE during Attach or Combined TA/LA Update procedures, the MME shall not send the paging to the eNodeBs and sends Paging Reject towards MSC to stop CS Paging procedure and this CSFB procedure stops.

6. The radio resource part of the paging procedure takes place. The message contains a suitable UE Identity (i.e. S-TMSI or IMSI) and a CN Domain indicator.
- 7a. The UE establishes an RRC connection and sends an Extended Service Request (CS Fallback Indicator) to MME. The UE indicates its S-TMSI in the RRC signalling. The Extended Service Request message is encapsulated in RRC and S1-AP messages. The CS Fallback Indicator indicates to the MME that CS Fallback for this UE is required. The MME sends the SGs Service Request message to the MSC containing an indication that the UE was in idle mode (and hence, for example, that the UE has not received any Calling Line Identification information). Receipt of the SGs Service Request message stops the MSC retransmitting the SGs interface Paging message.

NOTE 3: In order to avoid the calling party experiencing a potentially long period of silence, the MSC may use the SGs Service Request message containing the idle mode indication as a trigger to inform the calling party that the call is progressing.

- 7b. MME sends S1-AP: Initial UE Context Setup (UE capabilities, CS Fallback Indicator, LAI and other parameters specified in TS 23.401 [2]) to indicate the eNodeB to move the UE to UTRAN/GERAN. The registered PLMN for CS domain is identified by the PLMN ID included in the LAI, which is allocated by the MME.

- 7c. The eNodeB shall reply with S1-AP: Initial UE Context Setup Response message.

- 8a. If the eNodeB knows that both the UE and the network support PS handover: The information flow may continue as described in clause 7.3 "Mobile Terminating call in Active Mode - PS HO supported" from step 2, in clause 7.3, and onwards.

- . If the eNodeB knows that either the UE or the network does not support PS handover: The information flow shall continue as described in clause 7.4 "Mobile Terminating call in Active Mode – No PS HO support" from step 2, in clause 7.4, and onwards.

NOTE 4: Even in case both the UE and the network support PS HO, the eNodeB may choose to use a different inter-RAT mobility procedure.

[TS 23.272, clause 7.3]

This flow may be executed when the eNodeB knows that both the UE and the network support PS HO in the normal case. Clause 6.6 describes the procedure when the procedure is rejected by the MME.

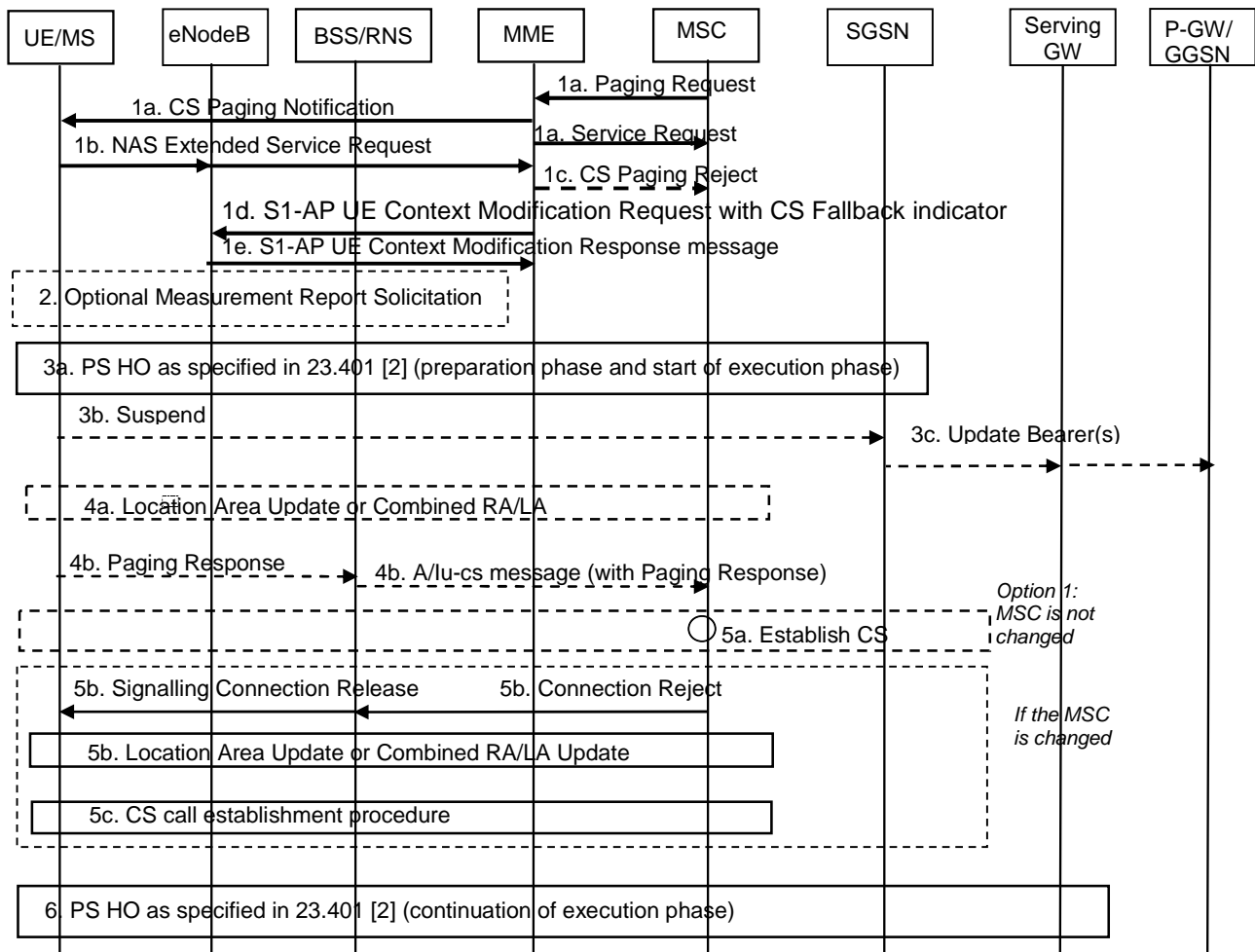

Figure 7.3-1: CS Page in E-UTRAN, Call in GERAN/UTRAN

1a. The MSC receives an incoming voice call and responds by sending a Paging Request (IMSI or TMSI, optional Caller Line Identification and Connection Management information, CS call indicator) to the MME over a SGs interface. The MSC only sends a CS Page for an UE that provides location update information using the SGs interface. In active mode the MME has an established S1 connection and if the MME did not return the "SMS-only" indication to the UE during Attach or Combined TA/LA Update procedures, the MME reuses the existing connection to relay the CS Page to the UE.

If the MME returned the "SMS-only" indication to the UE during Attach or Combined TA/LA Update procedures, the MME shall not send the CS Service Notification to the UE and shall send Paging Reject towards MSC to stop CS Paging procedure, and this CSFB procedure stops.

The eNodeB forwards the paging message to the UE. The message contains CN Domain indicator and, if received from the MSC, the Caller Line Identification.

The MME immediately sends the SGs Service Request message to the MSC containing an indication that the UE was in connected mode. The MSC uses this connected mode indication to start the Call Forwarding on No Reply timer for that UE and the MSC should send an indication of user alerting to the calling party. Receipt of the SGs Service Request message stops the MSC retransmitting the SGs interface Paging message.

NOTE 1: The pre-configured policy may be used by UE to avoid being disturbed without Caller Line Identification display and the detailed handling is to be decided by CT1 and CT6.

NOTE 2: This procedure can also take place immediately after MSC receives MAP_PRN from HSS, if pre-paging is deployed. Caller Line Identification and CS call indicator are also provided in the case of pre-paging.

NOTE 3: In order to avoid the calling party experiencing a potentially long period of silence, the MSC may use the SGs Service Request message as a trigger to inform the calling party that the call is progressing.

- 1b. UE sends an Extended Service Request (CS Fallback Indicator, Reject or Accept) message to the MME. The Extended Service Request message is encapsulated in RRC and S1-AP messages. CS Fallback Indicator indicates to the MME to perform CS Fallback. The UE may decide to reject CSFB based on Caller Line Identification.
- 1c. Upon receiving the Extended Service Request (CSFB, Reject), the MME sends Paging Reject towards MSC to stop CS Paging procedure and this CSFB procedure stops.
- 1d. MME sends an S1-AP UE Context Modification Request (CS Fallback Indicator, LAI) message to eNodeB. This message: indicates to the eNodeB that the UE should be moved to UTRAN/GERAN. The registered PLMN for CS domain is identified by the PLMN ID included in the LAI, which is allocated by the MME.
- 1e. The eNodeB shall reply with S1-AP UE Context Modification Response message.
2. The eNodeB may optionally solicit a measurement report from the UE to determine the target GERAN/UTRAN cell to which PS handover will be performed.
- 3a. The eNodeB triggers PS handover to a GERAN/UTRAN neighbour cell by sending a Handover Required message to MME. The eNodeB selects the target PS handover cell considering the PLMN ID and possibly the LAC for CS domain provided by the MME in step 1d. In the following an inter-RAT handover from E-UTRAN to UTRAN or GERAN as specified in TS 23.401 [2] begins. The eNodeB indicates in the Source RNC to Target RNC Transparent container that PS handover was triggered due to CSFB. The eNodeB also indicates whether CSFB was triggered for emergency purpose. As part of this handover, the UE receives a HO from E-UTRAN Command and tries to connect to a cell in the target RAT. The HO from E-UTRAN Command may contain a CS Fallback Indicator which indicates to UE that the handover was triggered due to a CS fallback request. If the HO from E-UTRAN Command contains a CS Fallback Indicator and the UE fails to establish connection to the target RAT, then the UE considers that CS fallback has failed.

The UE establishes the signalling connection as described in step 4b.

NOTE 4: During the PS HO the SGSN does not create a Gs association with the MSC/VLR.

- 3b. If the target RAT is GERAN and the UE has entered Dedicated Mode, the UE starts the Suspend procedure (see TS 44.018 [4]) unless both the UE and the Target cell support DTM in which case TBF re-establishment may be performed.
- 3c. A Gn/Gp-SGSN that receives the Suspend message from the UE follows the Suspend procedure specified in TS 23.060 [3], clause 16.2.1.1.1.

An S4-SGSN that receives the Suspend message from the UE follows the Suspend procedure specified in TS 23.060 [3]. The S4-SGSN deactivates GBR bearers towards S-GW and P-GW(s) by initiating MS-and SGSN Initiated Bearer Deactivation procedure as specified in TS 23.060 [3], and starts the preservation and suspension of non-GBR bearers by sending Suspend Notification message to the S-GW. The S-GW releases all RNC related information (address and TEIDs) for the UE if Direct Tunnel is established, and sends Suspend Notification message to the P-GW(s). The SGSN stores in the UE context that UE is in suspended status. All the preserved non-GBR bearers are marked as suspended status in the S-GW and P-GW(s). The P-GW should discard packets if received for the suspended UE.

- 4a. If the LA of the new cell is different from the one stored in the UE, the UE shall initiate a Location Area Update or a Combined RA/LA Update procedure as follows:
 - If the network is operating in NMO-I (Network Modes of Operation), the UE should initiate a separate Location Area Update before initiating the RAU procedure instead of a Combined RA/LA Update procedure (to speed up the CSFB procedure); or
 - if the network is operating in NMO-II or NMO-III the UE shall initiate a Location Area Update procedure before initiating the RAU procedure required for PS handover.

The UE shall set the "CSMT" flag in the LAU Request. The "CSMT" flag is used to avoid missing MT call in roaming retry case. Further the UE performs any Routing Area Update procedure as specified in TS 23.060 [3].

The UE may initiate a Location Area Update procedure immediately when the UE is handed over to the target cell i.e. before the UE receives e.g. LAI or NMO information as part of the RAN Mobility Information.

When the MSC receives a LA Update Request, it shall check for pending terminating CS calls and, if the "CSMT" flag is set, maintain the CS signalling connection after the Location Area Update procedure for pending terminating CS calls.

4b. If the UE does not initiate a LAU procedure, it shall respond with a Paging Response message to the MSC as follows:

- If the Target RAT is UTRAN or GERAN Iu mode: The UE establishes a radio signalling connection and responds to the paging by sending an RRC Paging Response as specified in TS 25.331 [7]. The CN Domain Indicator is set to "CS" in the Initial Direct Transfer message.
- If the Target RAT is GERAN A/Gb mode: The UE establishes a radio signalling connection and responds to paging by using the procedures specified in TS 44.018 [4] (i.e. UE requests and is assigned a dedicated channel where it sends a SABM containing a Paging Response to the BSS and the BSS responds by sending a UA). Upon receiving the SABM (containing a Paging Response message) the BSS sends a COMPLETE LAYER 3 INFORMATION message (containing a Paging Response message) to the MSC which indicates CS resources have been allocated in the GERAN cell. If both the UE and the target cell support enhanced CS establishment in DTM (indicated by GERAN system information included within the HO from E-UTRAN Command) an RR connection may be established while in packet transfer mode without release of the packet resources, see TS 43.055 [24]. After the establishment of the main signalling link as described in TS 44.018 [4] the UE enters either Dual Transfer Mode or Dedicated Mode and the CS call establishment procedure completes.

NOTE 5: The BSS should be prepared to receive a Paging Response even when the corresponding Paging Request has not been sent by this BSS.

5a. After performing the LAU procedure or after receiving the Paging Response the MSC shall establish the CS call if the UE is allowed in the LA.

5b. If the UE is not registered in the MSC that receives the Paging Response or the UE is not allowed in the LA, the MSC shall reject the Paging Response message by releasing the A/Iu-CS. The BSC/RNC in turn releases the signalling connection for UTRAN or GERAN CS domain. The signalling connection release shall trigger the UE to obtain the LAI, which causes the initiation of a Location Area Update or a Combined RA/LA procedure as specified in TS 23.060 [3] for the different Network Modes of Operation (NMO).

The Location Area Update triggers the Roaming Retry for CS Fallback procedure as defined in clause 7.5.

5c. After performing the LAU procedure the MSC shall establish the CS call if the UE is allowed in the LA.

6. The UE performs any remaining steps of the inter-RAT handover from E-UTRAN to UTRAN or GERAN as specified in TS 23.401 [2]

With the exception of steps 1a and 1c, above, Call Forwarding (see TS 23.082 [31]) is performed on the basis of the TS 24.008 [21] signalling received on the GERAN/UTRAN cell.

If the UE remains on UTRAN/GERAN after the CS voice call is terminated the UE performs normal mobility management procedures as defined in TS 23.060 [3] and TS 24.008 [21].

[TS 36.331, clause 5.4.3.3]

The UE shall be able to receive a *MobilityFromEUTRACCommand* message and perform a cell change order to GERAN, even if no prior UE measurements have been performed on the target cell.

The UE shall:

- 1> stop timer T310, if running;
- 1> if the *MobilityFromEUTRACCommand* message includes the *purpose* set to 'handover':
 - 2> if the *targetRAT-Type* is set to 'utra' or 'geran':

- 3> consider inter-RAT mobility as initiated towards the RAT indicated by the *targetRAT-Type* included in the *MobilityFromEUTRACommand* message;
- 3> forward the *nas-SecurityParamFromEUTRA* to the upper layers;
- 3> access the target cell indicated in the inter-RAT message in accordance with the specifications of the target RAT;
- 3> if the *targetRAT-Type* is set to 'geran':
 - 4> use the contents of *systemInformation*, if provided for PS Handover, as the system information to begin access on the target GERAN cell;

...

13.1.11.3 Test description

13.1.11.3.1 Pre-test conditions

System Simulator:

- Cell 1 serving cell
- Cell 24 suitable neighbour cell
- Cell 1 and Cell 24 are in the different LA
- The parameters settings and power levels for Cell 1 and Cell 24 are selected according to [18], [5] so that camping on Cell 1 is guaranteed and no cell re-selection to Cell 24 can take place (GERAN priority is lower than serving and $S_{Cell 1} > Thresh_{Cell 1,low}$).
- System information combination 5 as defined in TS 36.508 [18] clause 4.4.3.1 is used in E-UTRA cells.
 - Cell 24 system information indicates that NMO 1 is used
 - DTM is not supported on the Cell 24

UE:

None.

Preamble:

- The UE is in state Registered, Idle Mode (state 2) on Cell 1 according to [18].

13.1.11.3.2 Test procedure sequence

Table 13.1.11.3.2-2: Main behaviour

St	Procedure	Message Sequence		TP	Verdict
		U - S	Message		
1	The SS transmits a <i>Paging</i> message to the UE on Cell 1 using S-TMSI with CN domain indicator set to "CS".	<--	<i>Paging</i>	-	-
-	EXCEPTION: Step 2a1 describes behaviour that depends on the UE capability; the "lower case letter" identifies a step sequence that takes place if a capability is supported.	-	-	-	-
2a1	IF the UE needs to request upper layer input before accepting the CS fallback, the incoming CS call is accepted at the UE through MMI or AT command.	-	-	-	-
3	The UE transmits an <i>RRCCoNNECTIONRequest</i> message on Cell1.	-->	<i>RRCCoNNECTIONRequest</i>	-	-
4	The SS transmits an <i>RRCCoNNECTIONSetup</i> message on Cell1.	<--	<i>RRCCoNNECTIONSetup</i>	-	-
5	Check: Does the UE transmit an <i>RRCCoNNECTIONSetupComplete</i> message containing an EXTENDED SERVICE REQUEST with Service Type IE set to "mobile terminating CS fallback or 1xCS fallback" on Cell 1?	-->	<i>RRCCoNNECTIONSetupComplete</i> NAS: EXTENDED SERVICE REQUEST	1	P
6	The SS transmits a <i>SecurityModeCommand</i> message on Cell 1.	<--	<i>SecurityModeCommand</i>	-	-
7	The UE transmits a <i>SecurityModeComplete</i> message on Cell 1.	-->	<i>SecurityModeComplete</i>	-	-
8	The SS transmits an <i>RRCCoNNECTIONReconfiguration</i> message on Cell 1.	<--	<i>RRCCoNNECTIONReconfiguration</i>	-	-
9	The UE transmits an <i>RRCCoNNECTIONReconfigurationComplete</i> message on Cell 1.	-->	<i>RRCCoNNECTIONReconfigurationComplete</i>	-	-
10	The SS transmits a <i>MobilityFromEUTRACommand</i> message on Cell 1 with IE <i>handover</i> .	<--	<i>MobilityFromEUTRACommand</i>	-	-
11	The UE transmits a PS HANDOVER ACCESS message on Cell 24.	-->	PS HANDOVER ACCESS	2	P
12	The SS transmits a PS PHYSICAL INFORMATION message on Cell 24.	<--	PS PHYSICAL INFORMATION	-	-
-	EXCEPTION: Steps 13a1 to 13b2 describe behaviour that depends on the UE implementation; the "lower case letter" identifies a step sequence that takes place if the UE exercises a particular behaviour	-	-	-	-
13a1	IF the UE performs LA update THEN check: Does the UE transmit LOCATION UPDATING REQUEST?	-->	LOCATION UPDATING REQUEST	2	P
-	EXCEPTION: The messages in the next two steps are sent only on Cell 24	-	-	-	-
13a1Aa1	The UE transmits a <i>Classmark Change</i> message	-->	CLASSMARK CHANGE		
-	EXCEPTION: The next step describes behaviour that depends on UE capability.	-	-	-	-
13a1Aa2	IF <i>pc_UTRA</i> THEN the UE transmits a <i>Utran Classmark Change</i> message.	-->	UTRAN CLASSMARK CHANGE.		
13a2	UE transmits GPRS SUSPENSION REQUEST message with suspension cause set to "LOCATION AREA UPDATE"	-->	GPRS SUSPENSION REQUEST	-	-
13a3	The SS transmits MM LOCATION UPDATING ACCEPT	<--	LOCATION UPDATING ACCEPT	-	-

13b 1	IF the UE does not perform LA update THEN UE transmits GPRS SUSPENSION REQUEST message with suspension cause set to "Mobile terminating CS connection"	-->	GPRS SUSPENSION REQUEST		
13b 2	Check: Does the UE transmit a PAGING RESPONSE on Cell 24?	-->	PAGING RESPONSE	2	P
14- 43	Steps 5 to 34 of the generic test procedure described in TS 36.508 subclause 6.4.3.8.1 is performed on Cell 24.	-	-	3	P
-	At the end of this test procedure sequence, the UE is in end state GERAN idle (G1) according to TS 36.508.	-	-	-	-

13.1.11.3.3 Specific message contents

Table 13.1.11.3.3-1: SystemInformationBlockTyp7 for cell 1 (preamble and all steps, Table 13.1.11.3.2-2)

Derivation Path: 36.331 clause 6.3.1			
Information Element	Value/remark	Comment	Condition
SystemInformationBlockType7 ::= SEQUENCE {			
carrierFreqsInfoListcarrierFreqsInfoListSEQUENCE (SIZE (1..maxGNFG)) OF SEQUENCE {			
carrierFreqs carrierFreqs[n] SEQUENCE {			
startingARFCN[n]	Same starting ARFCN used for cell 24		
bandIndicator[n]	same band used for GERAN cell24		
followingARFCNs[n] CHOICE {			
explicitListOfARFCNs[n]	Same ARFCN used for cell24		
}			
}			
commonInfo[n] SEQUENCE {			
cellReselectionPriority[n]	3	Lower priority than E-UTRA	
}			
}			
}			

Table 13.1.11.3.3-2: Message Paging (step 1, Table 13.1.11.3.2-2)

Derivation Path: 36.508 clause 4.6.1-7			
Information Element	Value/remark	Comment	Condition
Paging ::= SEQUENCE {			
pagingRecordList SEQUENCE (SIZE (1..maxPageRec)) OF SEQUENCE {	1 entry		
ue-Identity[1] CHOICE {			
s-TMSI	Set to the value of the S-TMSI of the UE		
}			
cn-Domain[1]	Cs		
}			
}			

Table 13.1.11.3.3-3: RRCConnectionSetupComplete (step 5, Table 13.1.11.3.2-2)

Derivation Path: 36.508 Table 4.6.1-18			
Information Element	Value/remark	Comment	Condition
RRCConnectionSetupComplete ::= SEQUENCE {			
rrc-TransactionIdentifier	RRC-TransactionIdentifier-UL		
criticalExtensions CHOICE {			
c1 CHOICE {			
rrcConnectionSetupComplete-r8 SEQUENCE {			
selectedPLMN-Identity	Set to the PLMN selected by upper layers		
registeredMME	Not present		
dedicatedInfoNAS	Set according to 36.508 Table 4.7.2-14A	EXTENDED SERVICE REQUEST	
nonCriticalExtension SEQUENCE {}	Not checked		
}			
}			
}			

Table 13.1.11.3.3-4: RRCConnectionReconfiguration (step 8, Table 13.1.11.3.2-2)

Derivation Path: 36.508 Table 4.6.1-8, condition SRB2-DRB(1, 0)

Table 13.1.11.3.3-5: Message MobilityFromEUTRACommand (step 10, Table 13.1.11.3.2-2)

Derivation Path: 36.508 clause 4.6.1-6			
Information Element	Value/remark	Comment	Condition
MobilityFromEUTRACommand ::= SEQUENCE {			
criticalExtensions CHOICE {			
c1 CHOICE {			
mobilityFromEUTRACommand-r8 SEQUENCE {			
csFallbackIndicator	True		
purpose CHOICE {			
handover SEQUENCE {			
targetRAT-Type	Geran		
targetRAT-MessageContainer	PS HANDOVER COMMAND		
nas-SecurityParamFromEUTRA	Not Present		
systemInformation	Not present		
}			
}			
}			
}			
}			
}			

Table 13.1.11.3.3-6: PS HANDOVER COMMAND (step 10, Table 13.1.11.3.2-2)

Derivation Path: TS 36.508 Table 4.7D.1-1

Table 13.1.11.3.3-7: LOCATION UPDATING ACCEPT (step 13a7, Table 13.1.11.3.2-2)

Derivation Path: TS 36.508 Table 4.7B.2-5			
Information Element	Value/remark	Comment	Condition
Mobile identity	Not present		

Table 13.1.11.3.3-8: ATTACH ACCEPT (Preamble)

Derivation Path: 36.508 Table 4.7.2-1			
Information Element	Value/remark	Comment	Condition
EPS network feature support	Not present		

13.1.12 Call setup from E-UTRA RRC_CONNECTED / CS fallback to GSM with PSHO / EDTM not supported / MO call

13.1.12.1 Test Purpose (TP)

(1)

```
with { UE in E-UTRA RRC_CONNECTED state }
ensure that {
  when { UE is triggered by upper layers to perform a circuit switched voice call }
  then { UE transmits an ULInformationTransfer message containing an EXTENDED SERVICE REQUEST message with Service Type IE set to "mobile originating CS fallback or 1xCS fallback" }
}
```

(2)

```
with { UE having transmitted an ULInformationTransfer message containing an EXTENDED SERVICE REQUEST message with Service Type IE set to "mobile terminating CS fallback or 1xCS fallback" }
ensure that {
  when { SS transmits a MobilityFromEUTRACommand message with handover to a GERAN cell and operating in NMO I }
  then { UE handovers to GERAN cell }
}
```

(3)

```
with { UE having transmitted an ULInformationTransfer message containing an EXTENDED SERVICE REQUEST message with Service Type IE set to "mobile originating CS fallback or 1xCS fallback" and handovered to GERAN cell }
ensure that {
  when { UE has handovered to GERAN cell }
  then { UE establishes a MO circuit switched voice call on GERAN }
}
```

13.1.12.2 Conformance requirements

References: The conformance requirements covered in the present TC are specified in: TS 23.272, clauses 6.2, TS 36.331, clause 5.4.3.3.

[TS 23.272, clause 6.2]

This flow may be executed when the eNodeB knows that both the UE and the network support PS HO, in the normal case. Clause 6.6 describes the procedure when the procedure is rejected by the MME.

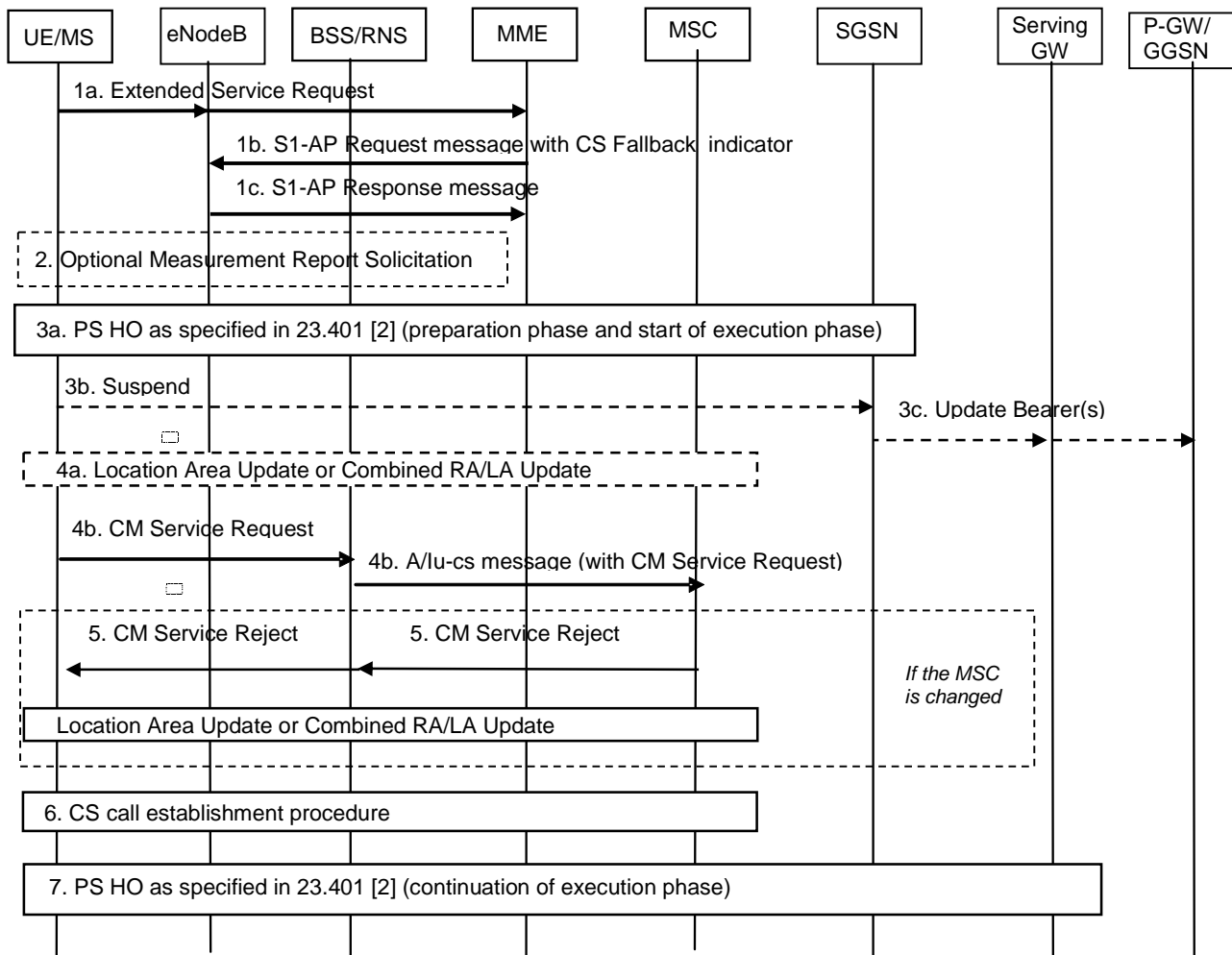

Figure 6.2-1: CS Call Request in E-UTRAN, Call in GERAN/UTRAN

NOTE 1: DTM is not mandatory for CS Fallback to work and is not linked to PS HO.

- 1a. The UE sends an Extended Service Request (CS Fallback Indicator) to MME. Extended Service Request message is encapsulated in RRC and S1-AP messages. CS Fallback Indicator indicates MME to perform CS Fallback. The UE only transmits this request if it is attached to CS domain (with a combined EPS/IMSI Attach) and can not initiate an IMS voice session (because e.g. the UE is not IMS registered or IMS voice services are not supported by the serving IP-CAN, home PLMN or UE).
- 1b. The MME sends an S1-AP UE Context Modification Request (CS Fallback Indicator, LAI) message to eNodeB. This message indicates to the eNodeB that the UE should be moved to UTRAN/GERAN. The registered PLMN for CS domain is identified by the PLMN ID included in the LAI, which is allocated by the MME.
- 1c. The eNodeB shall reply with S1-AP UE Context Modification Response message.
2. The eNodeB may optionally solicit a measurement report from the UE to determine the target GERAN/UTRAN cell to which PS handover will be performed.
- 3a. The eNodeB triggers PS handover to a GERAN/UTRAN neighbour cell by sending a Handover Required message to the MME. The eNodeB selects the target PS handover cell considering the PLMN ID and possibly the LAC for CS domain provided by the MME in step 1b. In the following an inter-RAT handover from E-UTRAN to UTRAN or GERAN as specified in TS 23.401 [2] begins. The eNodeB indicates in the Source RNC to Target RNC Transparent container that PS handover was triggered due to CSFB. The eNodeB also indicates whether CSFB was triggered for emergency purpose. As part of this handover, the UE receives a HO from

E-UTRAN Command and tries to connect to a cell in the target RAT. The HO from E-UTRAN Command may contain a CS Fallback Indicator which indicates to UE that the handover is triggered due to a CS fallback request. If the HO from E-UTRAN Command contains a CS Fallback Indicator and the UE fails to establish connection to the target RAT, then the UE considers that CS fallback has failed. Service Request procedure is considered to be successfully completed when PS Handover procedure is completed successfully.

NOTE 2: During the PS HO the SGSN does not create a Gs association with the MSC/VLR.

NOTE 3: Service Request procedure supervision timer shall be sufficiently long considering the optional measurement reporting at step 2.

When the UE arrives at the target cell, if the target RAT is UTRAN, the UE establishes the radio signalling connection by sending an RRC Initial Direct Transfer message as specified in TS 25.331 [7] that contains a NAS message. The CN Domain Indicator is set to "CS" in the Initial Direct Transfer message.

If the target RAT is GERAN A/Gb mode: The UE establishes a radio signalling connection by using the procedures specified in TS 44.018 [4] (i.e. UE requests and is assigned a dedicated channel where it sends a SABM containing a NAS message to the BSS and the BSS responds by sending a UA). Upon receiving the SABM (containing the NAS message) the BSS sends a COMPLETE LAYER 3 INFORMATION message (containing the NAS message) to the MSC which indicates CS resources have been allocated in the GERAN cell. If both the UE and the target cell support enhanced CS establishment in DTM (indicated by GERAN system information included within the HO from E-UTRAN Command) a RR connection may be established while in packet transfer mode without release of the packet resources, see TS 43.055 [24]. After the establishment of the main signalling link as described in TS 44.018 [4] the UE enters either Dual Transfer Mode or Dedicated Mode.

3b. If the target RAT is GERAN and the UE has entered Dedicated Mode, the UE starts the Suspend procedure (see TS 44.018 [4]) unless both the UE and the Target cell support DTM in which case TBF re-establishment may be performed.

3c. A Gn/Gp-SGSN that receives the Suspend message from the UE follows the Suspend procedure specified in TS 23.060 [3], clause 16.2.1.1.1

An S4-SGSN that receives the Suspend message from the UE follows the Suspend procedure specified in TS 23.060 [3]. The S4-SGSN deactivates GBR bearers towards S-GW and P-GW(s) by initiating MS-and SGSN Initiated Bearer Deactivation procedure as specified in TS 23.060 [3], and starts the preservation and suspension of non-GBR bearers by sending Suspend Notification message to the S-GW. The S-GW releases all RNC related information (address and TEIDs) for the UE if Direct Tunnel is established, and sends Suspend Notification message to the P-GW(s). The SGSN stores in the UE context that UE is in suspended status. All the preserved non-GBR bearers are marked as suspended status in the S-GW and P-GW(s). The P-GW should discard packets if received for the suspended UE.

4a. If the LA of the new cell is different from the one stored in the UE, the UE shall initiate a Location Area Update or a Combined RA/LA Update procedure as follows:

- if the network is operating in NMO-I (Network Modes of Operation), the UE may initiate a separate Location Area Update before initiating the RAU procedure instead of a Combined RA/LA Update procedure (to speed up the CSFB procedure); or
- if the network is operating in NMO-II or NMO-III, the UE shall initiate a Location Area Update before initiating the RAU procedure required for PS handover.

When the UE initiates a Location Area Update the UE shall set the "follow-on request" flag in the LAU Request in order to indicate to the MSC not to release the Iu/A connection after the LAU procedure completion. Further the UE performs any Routing Area Update procedure as specified by TS 23.060 [3].

The UE may initiate a Location Area Update procedure immediately when the UE is handed over to the target cell i.e. before the UE receives e.g. LAI or NMO information as part of the RAN Mobility Information.

4b. The UE sends a CM Service Request to the MSC.

5. If the UE is not registered in the MSC serving the 2G/3G target cell or the UE is not allowed in the LA, the MSC shall reject the CM service request, if implicit location update is not performed. The CM Service Reject shall trigger the UE to perform a Location Area Update or a Combined RA/LA Update procedure as specified in TS 23.060 [3] for the different Network Modes of Operation (NMO).

6. The UE initiates the CS call establishment procedure.
7. The UE performs any remaining steps of the inter-RAT handover from E-UTRAN to UTRAN or GERAN as specified in TS 23.401 [2].

If the UE remains on UTRAN/GERAN after the CS voice call is terminated the UE performs normal mobility management procedures as defined in TS 23.060 [3] and TS 24.008 [21].

[TS 36.331, clause 5.4.3.3]

The UE shall be able to receive a *MobilityFromEUTRACCommand* message and perform a cell change order to GERAN, even if no prior UE measurements have been performed on the target cell.

The UE shall:

- 1> stop timer T310, if running;
- 1> if the *MobilityFromEUTRACCommand* message includes the *purpose* set to 'handover':
 - 2> if the *targetRAT-Type* is set to 'utra' or 'geran':
 - 3> consider inter-RAT mobility as initiated towards the RAT indicated by the *targetRAT-Type* included in the *MobilityFromEUTRACCommand* message;
 - 3> forward the *nas-SecurityParamFromEUTRA* to the upper layers;
 - 3> access the target cell indicated in the inter-RAT message in accordance with the specifications of the target RAT;
 - 3> if the *targetRAT-Type* is set to 'geran':
 - 4> use the contents of *systemInformation*, if provided for PS Handover, as the system information to begin access on the target GERAN cell;

...

13.1.12.3 Test description

13.1.12.3.1 Pre-test conditions

System Simulator:

- 2 cells, one E-UTRA and one GERAN cell:
 - Cell 1 E-UTRA serving cell
 - Cell 24 suitable neighbour GERAN cell
 - Cell 24 system information indicates that NMO 1 is used
 - DTM is not supported on Cell 24.
 - The parameters settings and power levels for Cell 1 and Cell 24 are selected according to [18], [5] so that camping on Cell 1 is guaranteed and no cell re-selection to Cell 24 can take place (GERAN priority is lower than serving and $S_{Cell\ 1} > Thresh_{Cell\ 1,low}$).
 - System information combination 5 as defined in TS 36.508 [18] clause 4.4.3.1 is used in E-UTRA cells.
 - Cell 1 and Cell 24 are in the same LA

UE:

None

Preamble:

- The UE is in state Generic RB Established (state 3) according to [18].

13.1.12.3.2 Test procedure sequence

Table 13.1.12.3.2-2: Main behaviour

St	Procedure	Message Sequence		TP	Verdict
		U - S	Message		
1	Cause the UE to originate CS call. (see Note 1)	-	-	-	-
2	Check: Does the UE transmit an <i>ULInformationTransfer</i> message containing an EXTENDED SERVICE REQUEST with Service Type IE set to "mobile originated CS fallback or 1xCS fallback" on Cell 1?	-->	<i>ULInformationTransfer</i> NAS: EXTENDED SERVICE REQUEST	1	P
3	The SS transmits a <i>MobilityFromEUTRACommand</i> message on Cell 1 with IE <i>handover</i> .	<--	<i>MobilityFromEUTRACommand</i>	-	-
4	The UE transmits a PS HANDOVER ACCESS message on Cell 24.	-->	PS HANDOVER ACCESS	2	P
5	The SS transmits a PS PHYSICAL INFORMATION message on Cell 24.	<--	PS PHYSICAL INFORMATION	-	-
6-35	Steps 3 to 32 of the generic test procedure described in TS36.508 subclause 6.4.3.8.2 are performed on Cell24.	-	-	3	P
-	At the end of this test procedure sequence, the UE is in end state GERAN idle (G1) according to TS 36.508.	-	-	-	-

Note 1: The trigger in step 1 is the same as in the generic procedure in 36.508 clause 6.4.3.5.

13.1.12.3.3 Specific message contents

Table 13.1.12.3.3-1: SystemInformationBlockType7 for cell 1 (preamble and all steps, Table 13.1.12.3.2-2 and Table 13.1.12.3.2-3)

Derivation Path: 36.508 Table 4.4.3.3-5			
Information Element	Value/remark	Comment	Condition
SystemInformationBlockType7 ::= SEQUENCE {			
carrierFreqsInfoList SEQUENCE (SIZE (1..maxGNFG)) OF SEQUENCE {			
CarrierFreqsGERAN SEQUENCE [n] {			
startingARFCN	Same as cell 24		
bandIndicator	Same as cell 24		
followingARFCNs CHOICE {			
equallySpacedARFCNs SEQUENCE {			
arfcn-Spacing	Same as cell 24		
numberOfFollowingARFCNs	Same as cell 24		
}			
}			
}			
commonInfo SEQUENCE {			
cellReselectionPriority	3	Lower priority than E-UTRA	
}			
}			

Table 13.1.12.3.3-2: *ULInformationTransfer* (step 2, Table 13.1.12.3.2-2)

Derivation Path: 36.508 Table 4.6.1-25			
Information Element	Value/remark	Comment	Condition
ULInformationTransfer ::= SEQUENCE {			
criticalExtensions CHOICE {			
c1 CHOICE {			
ulInformationTransfer-r8 SEQUENCE {			
dedicatedInfoType CHOICE {			
dedicatedInfoNAS	Set according to Table 13.1.12.3.3-4	EXTENDED SERVICE REQUEST	
}			
}			
}			
}			
}			

Table 13.1.12.3.3-3: EXTENDED SERVICE REQUEST (step 2, Table 13.1.12.3.2-2)

Derivation Path: 36.508 Table 4.7.2-14A			
Information Element	Value/remark	Comment	Condition
Service type	'0000'B	mobile originating CS fallback or 1xCS fallback	

Table 13.1.12.3.3-4: Message *MobilityFromEUTRACommand* (step 3, Table 13.1.13.3.2-2)

Derivation Path: 36.508 clause 4.6.1-6			
Information Element	Value/remark	Comment	Condition
MobilityFromEUTRACommand ::= SEQUENCE {			
criticalExtensions CHOICE {			
c1 CHOICE {			
mobilityFromEUTRACommand-r8 SEQUENCE {			
csFallbackIndicator	True		
purpose CHOICE {			
handover SEQUENCE {			
targetRAT-Type	Geran		
targetRAT-MessageContainer	PS HANDOVER COMMAND		
nas-SecurityParamFromEUTRA	Not Present		
systemInformation	Not present		
}			
}			
}			
}			
}			
}			

Table 13.1.12.3.3-5: PS HANDOVER COMMAND (step 3, Table 13.1.13.3.2-2)

Derivation Path: TS 36.508 Table 4.7D.1-1

Table 13.1.12.3.3-7: GPRS SUSPENSION REQUEST (step 6, Table 13.1.12.3.2-2)

Derivation Path: 36.508 Table 4.7.2-14A			
Information Element	Value/remark	Comment	Condition
Protocol discriminator	RR		
Service type	'00110100'B	GPRS SUSPENSION REQUEST	
Suspension cause	'00000110'B	DTM not supported in the cell	

Table 13.1.12.3.3-8: LOCATION UPDATING ACCEPT (step 6a7, Table 13.1.12.3.2-2)

Derivation Path: TS 36.508 Table 4.7B.2-5			
Information Element	Value/remark	Comment	Condition
Mobile identity	Not present		

Table 13.1.12.3.3-9: ATTACH ACCEPT (Preamble)

Derivation Path: 36.508 Table 4.7.2-1			
Information Element	Value/remark	Comment	Condition
EPS network feature support	Not present		

13.1.13 Call setup from E-UTRA RRC_IDLE / CS fallback to GSM with PSHO / EDTM supported / MT call

13.1.13.1 Test Purpose (TP)

(1)

```
with { UE in E-UTRA RRC_IDLE state }
ensure that {
  when { UE receives a Paging message with CN domain indicator set to "CS" }
  then { UE transmits an ULInformationTransfer message containing an EXTENDED SERVICE REQUEST message with Service Type IE set to "mobile terminating CS fallback or 1xCS fallback" }
}
```

(2)

```
with { UE having transmitted an ULInformationTransfer message containing an EXTENDED SERVICE REQUEST message with Service Type IE set to "mobile terminating CS fallback or 1xCS fallback" }
ensure that {
  when { SS transmits a MobilityFromEUTRACommand message with handover to a GERAN cell in a different location area and operating in NMO I }
  then { UE handovers to GERAN cell and performs a Combined LA/RA update procedure or a LA Update procedure }
}
```

(3)

```
with { UE having transmitted an ULInformationTransfer message containing an EXTENDED SERVICE REQUEST message with Service Type IE set to "mobile terminating CS fallback or 1xCS fallback" and handovered to GERAN cell and initiated a RA Update procedure }
ensure that {
  when { UE completes the RA Update procedure }
  then { UE transmits a PAGING RESPONSE on GSM cell to set up MT CS call }
}
```

(4)

```
with { UE having transmitted an ULInformationTransfer message containing an EXTENDED SERVICE REQUEST message with Service Type IE set to "mobile terminating CS fallback or 1xCS fallback" and handovered to GERAN cell and initiated a RA Update procedure }
ensure that {
```

```

when { UE completes a Combined LA/RA update procedure or an LA Update procedure }
then { UE sets up MT CS call on GSM cell }
    }
    
```

13.1.13.2 Conformance requirements

References: The conformance requirements covered in the present TC are specified in: TS 23.272, clauses 6.4 and 6.3, and, TS 36.331, clause 5.4.3.3 and 5.3.12, and, TS44.060, clause 8.9.1.1.1.

[TS 23.272, clause 7.2]

The procedure for Mobile Terminating Call in idle mode is illustrated in figure 7.2-1, in the normal case. Clause 6.6 describes the procedure when the procedure is rejected by the MME.

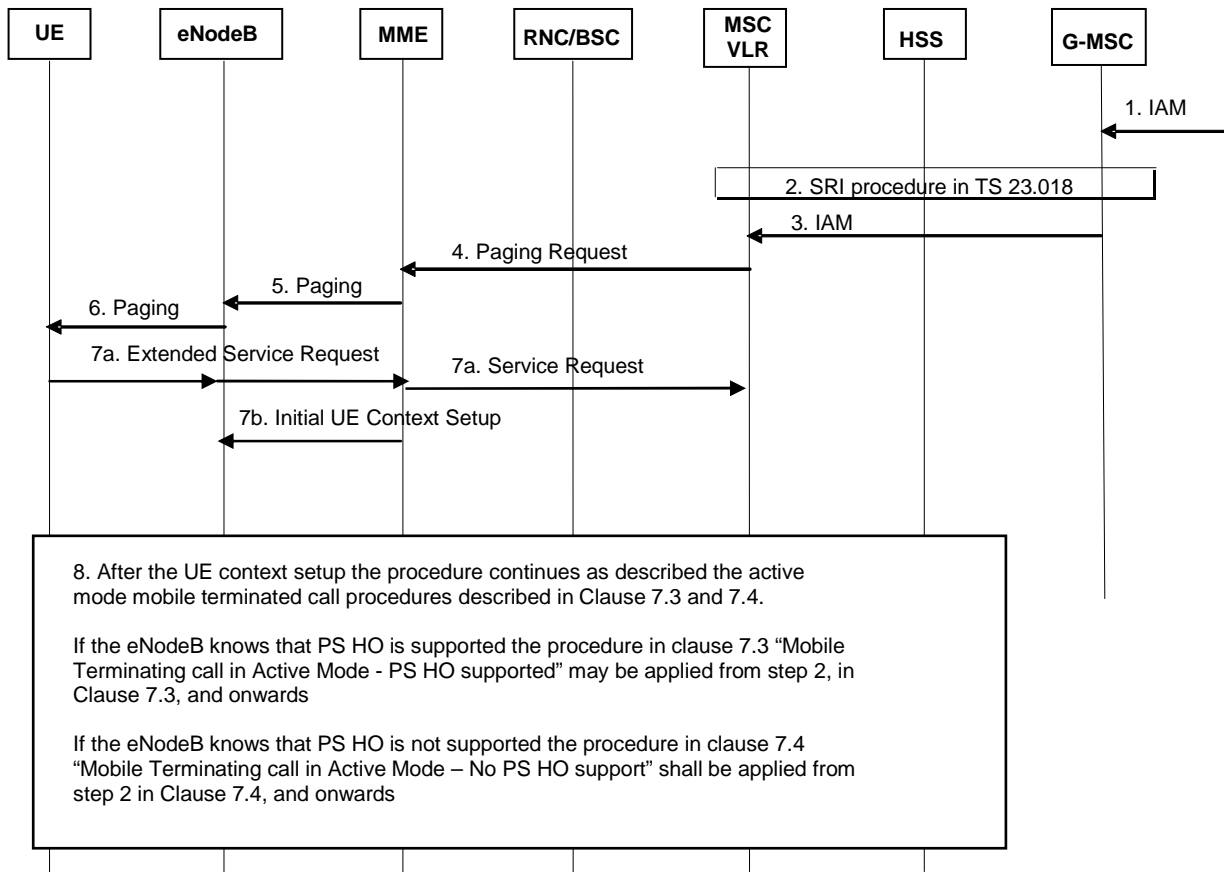

Figure 7.2-1: Mobile Terminating Call in idle mode

1. G-MSC receives IAM.
2. G-MSC retrieves routing information of the terminating UE by Send Routing Info procedures as specified in TS 23.018 [5].
- ...
- 7a. The UE establishes an RRC connection and sends an Extended Service Request for mobile terminating CS fallback to MME. The UE indicates its S-TMSI in the RRC signalling. The Extended Service Request message is encapsulated in RRC and S1-AP messages. The MME sends the SGs Service Request message to the MSC containing an indication that the UE was in idle mode (and hence, for example, that the UE has not received any Calling Line Identification information). Receipt of the SGs Service Request message stops the MSC retransmitting the SGs interface Paging message.

NOTE 3: In order to avoid the calling party experiencing a potentially long period of silence, the MSC may use the SGs Service Request message containing the idle mode indication as a trigger to inform the calling party that the call is progressing.

If the MME had received paging request with Priority Indication in step4 and receives subsequent Extended Service Request in Step 7a, it detects this message is the response to the priority CS Fallback procedure initiated in step5. In this case, the MME processes this message with priority and set the priority indication, i.e. "CSFB High Priority", in step7b as specified in TS 36.413 [35].

7b. MME sends S1-AP: Initial UE Context Setup (UE capabilities, CS Fallback Indicator, LAI and other parameters specified in TS 23.401 [2]) to indicate the eNodeB to move the UE to UTRAN/GERAN. The registered PLMN for CS domain is identified by the PLMN ID included in the LAI, which is allocated by the MME.

7c. The eNodeB shall reply with S1-AP: Initial UE Context Setup Response message.

8a. If the eNodeB knows that both the UE and the network support PS handover: The information flow may continue as described in clause 7.3 "Mobile Terminating call in Active Mode - PS HO supported" from step 2, in clause 7.3, and onwards.

. If the eNodeB knows that either the UE or the network does not support PS handover: The information flow shall continue as described in clause 7.4 "Mobile Terminating call in Active Mode – No PS HO support" from step 2, in clause 7.4, and onwards.

NOTE 4: Even in case both the UE and the network support PS HO, the eNodeB may choose to use a different inter-RAT mobility procedure.

[TS 23.272, clause 7.3]

This flow may be executed when the eNodeB knows that both the UE and the network support PS HO in the normal case. Clause 6.6 describes the procedure when the procedure is rejected by the MME.

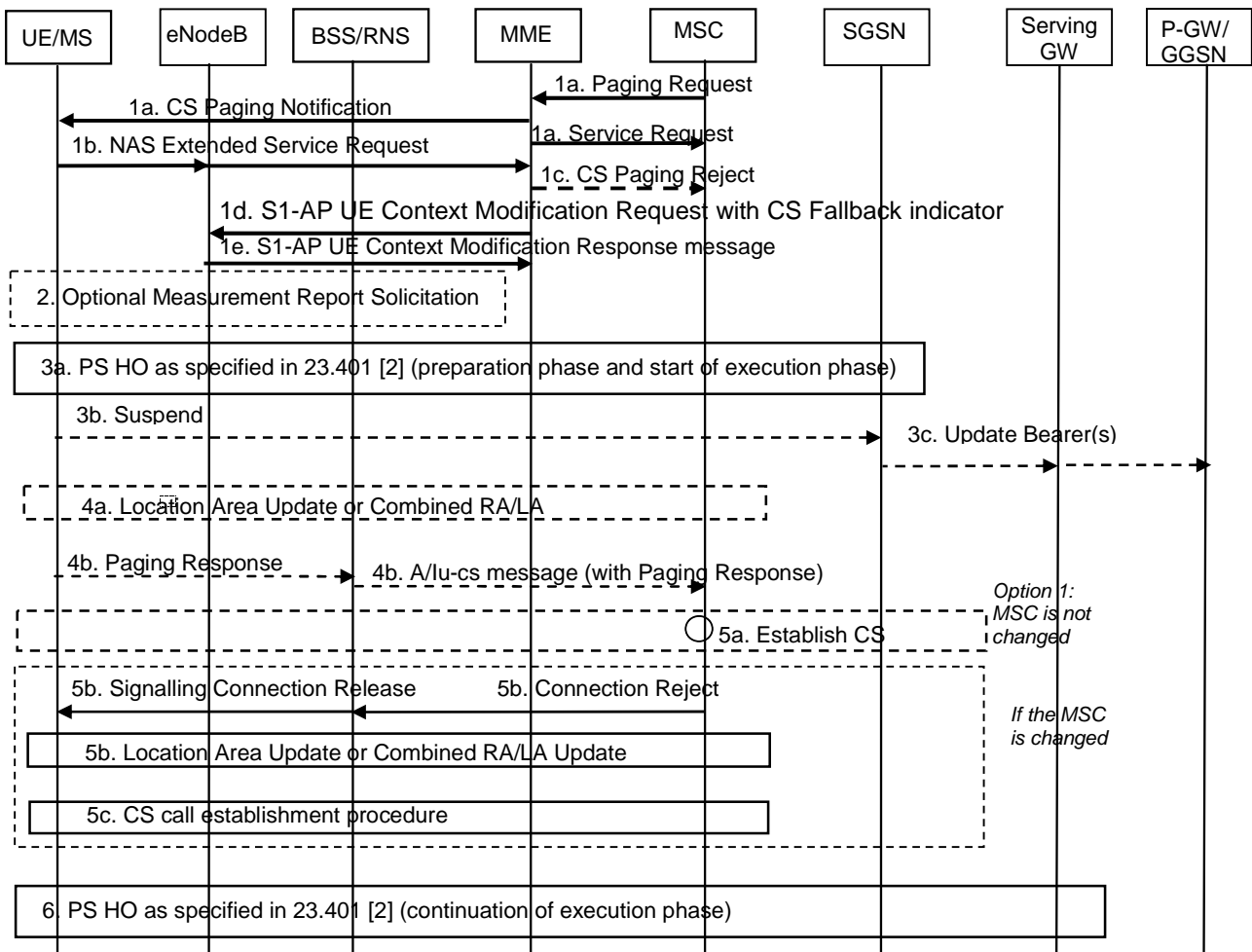

Figure 7.3-1: CS Page in E-UTRAN, Call in GERAN/UTRAN

...

- The eNodeB may optionally solicit a measurement report from the UE to determine the target GERAN/UTRAN cell to which PS handover will be performed.

NOTE 4: Based on operator policy, the priority indicator received in step 1b may be used by eNodeB to decide whether to continue CS Fallback procedures with PS HO, i.e. step 3a, or to initiate radio release procedure to redirect the UE to 2G/3G Circuit Switch.

- The eNodeB triggers PS handover to a GERAN/UTRAN neighbour cell by sending a Handover Required message to MME. The eNodeB selects the target PS handover cell considering the PLMN ID and possibly the LAC for CS domain provided by the MME in step 1d. In the following an inter-RAT handover from E-UTRAN to UTRAN or GERAN as specified in TS 23.401 [2] begins. The eNodeB indicates in the Source RNC to Target RNC Transparent container that PS handover was triggered due to CSFB. The eNodeB also indicates whether CSFB was triggered for emergency or priority call handling purpose. If the network supports a priority call handling, the eNodeB may forward the priority indication to the target GERAN/UTRAN in the Source to Target Transparent Container, and the target GERAN/UTRAN allocates radio bearer resources taking received priority indication take into account. As part of this handover, the UE receives a HO from E-UTRAN Command and tries to connect to a cell in the target RAT. The HO from E-UTRAN Command may contain a CS Fallback Indicator which indicates to UE that the handover was triggered due to a CS fallback request. If the HO from E-UTRAN Command contains a CS Fallback Indicator and the UE fails to establish connection to the target RAT, then the UE considers that CS fallback has failed.

The UE establishes the signalling connection as described in step 4b.

NOTE 5: During the PS HO the SGSN does not create a Gs association with the MSC/VLR.

- 3b. If the target RAT is GERAN and the UE has entered Dedicated Mode, the UE starts the Suspend procedure (see TS 44.018 [4]) unless both the UE and the Target cell support DTM in which case TBF re-establishment may be performed.
- 3c. A Gn/Gp-SGSN that receives the Suspend message from the UE follows the Suspend procedure specified in TS 23.060 [3], clause 16.2.1.1.1.

An S4-SGSN that receives the Suspend message from the UE follows the Suspend procedure specified in TS 23.060 [3]. The S4-SGSN deactivates GBR bearers towards S-GW and P-GW(s) by initiating MS- and SGSN Initiated Bearer Deactivation procedure as specified in TS 23.060 [3], and starts the preservation and suspension of non-GBR bearers by sending Suspend Notification message to the S-GW. The S-GW releases all RNC related information (address and TEIDs) for the UE if Direct Tunnel is established, and sends Suspend Notification message to the P-GW(s). The SGSN stores in the UE context that UE is in suspended status. All the preserved non-GBR bearers are marked as suspended status in the S-GW and P-GW(s). The P-GW should discard packets if received for the suspended UE.

- 4a. If the LA of the new cell is different from the one stored in the UE, the UE shall initiate a Location Area Update or a Combined RA/LA Update procedure as follows:
- If the network is operating in NMO-I (Network Modes of Operation), the UE should initiate a separate Location Area Update before initiating the RAU procedure instead of a Combined RA/LA Update procedure (to speed up the CSFB procedure); or
 - if the network is operating in NMO-II or NMO-III the UE shall initiate a Location Area Update procedure before initiating the RAU procedure required for PS handover.

The UE shall set the "CSMT" flag in the LAU Request. The "CSMT" flag is used to avoid missing MT call in roaming retry case. Further the UE performs any Routing Area Update procedure as specified in TS 23.060 [3].

The UE may initiate a Location Area Update procedure immediately when the UE is handed over to the target cell i.e. before the UE receives e.g. LAI or NMO information as part of the RAN Mobility Information.

When the MSC receives a LA Update Request, it shall check for pending terminating CS calls and, if the "CSMT" flag is set, maintain the CS signalling connection after the Location Area Update procedure for pending terminating CS calls.

- 4b. If the UE does not initiate a LAU procedure, it shall respond with a Paging Response message to the MSC as follows:
- If the Target RAT is UTRAN or GERAN Iu mode: The UE establishes a radio signalling connection and responds to the paging by sending an RRC Paging Response as specified in TS 25.331 [7]. The CN Domain Indicator is set to "CS" in the Initial Direct Transfer message.
 - If the Target RAT is GERAN A/Gb mode: The UE establishes a radio signalling connection and responds to paging by using the procedures specified in TS 44.018 [4] (i.e. UE requests and is assigned a dedicated channel where it sends a SABM containing a Paging Response to the BSS and the BSS responds by sending a UA). Upon receiving the SABM (containing a Paging Response message) the BSS sends a COMPLETE LAYER 3 INFORMATION message (containing a Paging Response message) to the MSC which indicates CS resources have been allocated in the GERAN cell. If both the UE and the target cell support enhanced CS establishment in DTM (indicated by GERAN system information included within the HO from E-UTRAN Command) an RR connection may be established while in packet transfer mode without release of the packet resources, see TS 43.055 [24]. After the establishment of the main signalling link as described in TS 44.018 [4] the UE enters either Dual Transfer Mode or Dedicated Mode and the CS call establishment procedure completes.

NOTE 6: The BSS should be prepared to receive a Paging Response even when the corresponding Paging Request has not been sent by this BSS.

- 5a. After performing the LAU procedure or after receiving the Paging Response the MSC shall establish the CS call if the UE is allowed in the LA.
- 5b. If the UE is not registered in the MSC that receives the Paging Response or the UE is not allowed in the LA, the MSC shall reject the Paging Response message by releasing the A/Iu-CS. The BSC/RNC in turn releases the

signalling connection for UTRAN or GERAN CS domain. The signalling connection release shall trigger the UE to obtain the LAI, which causes the initiation of a Location Area Update or a Combined RA/LA procedure as specified in TS 23.060 [3] for the different Network Modes of Operation (NMO).

The Location Area Update triggers the Roaming Retry for CS Fallback procedure as defined in clause 7.5.

5c. After performing the LAU procedure the MSC shall establish the CS call if the UE is allowed in the LA.

6. The UE performs any remaining steps of the inter-RAT handover from E-UTRAN to UTRAN or GERAN as specified in TS 23.401 [2]

With the exception of steps 1a and 1c, above, Call Forwarding (see TS 23.082 [31]) is performed on the basis of the TS 24.008 [21] signalling received on the GERAN/UTRAN cell.

If the UE remains on UTRAN/GERAN after the CS voice call is terminated the UE performs normal mobility management procedures as defined in TS 23.060 [3] and TS 24.008 [21].

[TS 36.331, clause 5.4.3.3]

The UE shall be able to receive a *MobilityFromEUTRACCommand* message and perform a cell change order to GERAN, even if no prior UE measurements have been performed on the target cell.

The UE shall:

1> stop timer T310, if running;

1> if the *MobilityFromEUTRACCommand* message includes the *purpose* set to 'handover':

2> if the *targetRAT-Type* is set to 'utra' or 'geran':

3> consider inter-RAT mobility as initiated towards the RAT indicated by the *targetRAT-Type* included in the *MobilityFromEUTRACCommand* message;

3> forward the *nas-SecurityParamFromEUTRA* to the upper layers;

3> access the target cell indicated in the inter-RAT message in accordance with the specifications of the target RAT;

3> if the *targetRAT-Type* is set to 'geran':

4> use the contents of *systemInformation*, if provided for PS Handover, as the system information to begin access on the target GERAN cell;

...

[TS 44.060, clause 8.9.1.1.1]

The RR connection establishment procedure is initiated by the RR entity of the mobile station. Initiation is triggered by request from the MM sublayer to enter dual transfer mode. The request from the MM sublayer to establish the RR connection specifies an establishment cause.

The RR entity in the mobile station shall not request the establishment of an RR connection while in packet transfer mode from the point where it receives a PS HANDOVER COMMAND message until the PS handover procedure has been completed (see sub-clause 8.10).

On receipt of the RR connection establishment request from upper layer the mobile station shall start timer T3196. At expiry of timer T3196, the mobile station shall release all ongoing TBFs and start RR connection establishment as specified in 3GPP TS 44.018. If a mobile station that supports PS handover receives a PS HANDOVER COMMAND message while T3196 is running it shall stop T3196, abort its current attempt to establish an RR connection and not make another attempt to establish an RR connection until completion of the PS handover procedure.

If the contention resolution is not solved, the mobile station shall delay the transmission of the PACKET CS REQUEST message until contention resolution is solved.

If the countdown procedure has been started on all the ongoing uplink TBFs, none of those TBFs is operating in extended uplink TBF mode and there is no downlink TBF in progress, the mobile station may either send the PACKET

CS REQUEST message, or may immediately release the ongoing TBF(s) and start an RR connection establishment as specified in 3GPP TS 44.018.

The mobile station shall initiate the RR connection establishment by sending PACKET CS REQUEST messages on the PACCH. The mobile station is allowed to retransmit the PACKET CS REQUEST message once while timer T3196 is running. The second sending occurrence of this message shall take place at the first suitable opportunity at least 0.75 s after the first transmission of that message.

13.1.13.3 Test description

13.1.13.3.1 Pre-test conditions

System Simulator:

- 2 cells, one E-UTRA and one GERAN cell
 - Cell 1 serving E-UTRA cell
 - Cell 24 suitable neighbour GERAN cell
 - o Cell 24 system information indicates that NMO 1 is used
 - o EDTM is supported on Cell 24.
 - The parameters settings and power levels for Cell 1 and Cell 24 are selected according to [18], [5] so that camping on Cell 1 is guaranteed and no cell re-selection to Cell 24 can take place (GERAN priority is lower than serving and $S_{Cell 1} > \text{Thresh}_{Cell 1,low}$).
 - System information combination 5 as defined in TS 36.508 [18] clause 4.4.3.1 is used in E-UTRA cells.

UE:

None.

Preamble:

- The UE is in state Registered, Idle Mode (state 2) on Cell 1 according to [18].

13.1.13.3.2 Test procedure sequence

Table 13.1.13.3.2-2: Main behaviour

St	Procedure	Message Sequence		TP	Verdict
		U - S	Message		
1	The SS transmits a <i>Paging</i> message to the UE on Cell 1 using S-TMSI with CN domain indicator set to "CS".	<--	<i>Paging</i>	-	-
-	EXCEPTION: Step 2a1 describes behaviour that depends on the UE capability; the "lower case letter" identifies a step sequence that takes place if a capability is supported.	-	-	-	-
2a1	IF the UE needs to request upper layer input before accepting the CS fallback, the incoming CS call is accepted at the UE through MMI or AT command.	-	-	-	-
3	The UE transmits an <i>RRCCoNNECTIONRequest</i> message on Cell1.	-->	<i>RRCCoNNECTIONRequest</i>	-	-
4	The SS transmits an <i>RRCCoNNECTIONSetup</i> message on Cell1.	<--	<i>RRCCoNNECTIONSetup</i>	-	-
5	Check: Does the UE transmit an <i>RRCCoNNECTIONSetupComplete</i> message containing an EXTENDED SERVICE REQUEST with Service Type IE set to "mobile terminating CS fallback or 1xCS fallback" on Cell 1?	-->	<i>RRCCoNNECTIONSetupComplete</i> NAS: EXTENDED SERVICE REQUEST	1	P
5A	The SS transmits a <i>SecurityModeCommand</i> message on Cell 1.	<--	<i>SecurityModeCommand</i>	-	-
5B	The UE transmits a <i>SecurityModeComplete</i> message on Cell 1.	-->	<i>SecurityModeComplete</i>	-	-
5C	The SS transmits an <i>RRCCoNNECTIONReconfiguration</i> message on Cell 1.	<--	<i>RRCCoNNECTIONReconfiguration</i>	-	-
5D	The UE transmits an <i>RRCCoNNECTIONReconfigurationComplete</i> message on Cell 1.	-->	<i>RRCCoNNECTIONReconfigurationComplete</i>	-	-
6	The SS transmits a <i>MobilityFromEUTRACommand</i> message on Cell 1 with IE <i>handover</i> .	<--	<i>MobilityFromEUTRACommand</i>	-	-
7	UE transmits a PS HANDOVER ACCESS message on Cell 24?	-->	PS HANDOVER ACCESS	-	-
8	The SS transmits a PS PHYSICAL INFORMATION message on Cell 24.	<--	PS PHYSICAL INFORMATION	-	-
	EXCEPTION: In case the UE does not choose to perform combined RA/LA procedure, the UE will perform LA update. In this case steps 9a1-9a8 are executed.				
9a1	Check: Does the UE transmit <i>PACKET CS REQUEST</i> message to initiate a CS connection?	-->	PACKET CS REQUEST	2	P
9a2	A CS connection is established	<--	PACKET CS COMMAND	-	-
9a3	Check: Does the UE transmit <i>LOCATION UPDATING REQUEST</i> ?	-->	LOCATION UPDATING REQUEST	2	P
-	EXCEPTION: The messages in the next two steps are sent only on Cell 24	-	-	-	-
9a3 Aa 1	The UE transmits a <i>Classmark Change</i> message	-->	CLASSMARK CHANGE		
-	EXCEPTION: The next step describes behaviour that depends on UE capability.	-	-	-	-
9a3 Aa 2	IF <i>pc_UTRA</i> THEN the UE transmits a <i>Utran Classmark Change</i> message.	-->	UTRAN CLASSMARK CHANGE.		
9a4	The SS transmits <i>AUTHENTICATION REQUEST</i>	<--	<i>AUTHENTICATION REQUEST</i>	-	-
9a5	The UE transmits <i>AUTHENTICATION</i>	-->	<i>AUTHENTICATION RESPONSE</i>	-	-

	RESPONSE				
9a6	The SS transmits CIPHERING MODE COMMAND	<--	CIPHERING MODE COMMAND	-	-
9a7	The UE transmits CIPHERING MODE COMPLETE	-->	CIPHERING MODE COMPLETE	-	-
9a8	The SS transmits MM LOCATION UPDATING ACCEPT	<--	LOCATION UPDATING ACCEPT	-	-
	EXCEPTION: In case UE chooses to perform combined RA/LA procedure, steps 9b1-9b7 are executed.				
9b1	The UE transmits ROUTING AREA UPDATING REQUEST message on Cell 24.	-->	ROUTING AREA UPDATING REQUEST	-	-
9b2	The SS transmits an AUTHENTICATION AND CIPHERING REQUEST message.	<--	AUTHENTICATION AND CIPHERING REQUEST	-	-
9b3	The UE transmits a AUTHENTICATION AND CIPHERING RESPONSE message.	-->	AUTHENTICATION AND CIPHERING RESPONSE	-	-
9b4	The SS transmits ROUTING AREA UPDATING ACCEPT to UE.	<--	ROUTING AREA UPDATING ACCEPT		
9b5	Check: Does the UE transmit a ROUTING AREA UPDATING COMPLETE message.	-->	ROUTING AREA UPDATING COMPLETE	2	P
9b6	A CS connection is established	<--	PACKET CS COMMAND	-	-
9b7	Check: Does the UE transmit a PAGING RESPONSE on Cell 24?	-->	PAGING RESPONSE	3	P
10	The SS transmits SETUP	<--	SETUP	-	-
11	Check: Does the UE transmits CALL CONFIRMED?	-->	CALL CONFIRMED	4	P
12-19	Steps 12 to 19 of the generic test procedure in TS 51.010-1 subclause 10.1.3 are performed on Cell 24. NOTE: Mobile terminating CS call is set up.	-	-	-	-

13.1.13.3.3 Specific message contents

Table 13.1.13.3.3-1: SystemInformationBlockType7 for cell 1 (preamble and all steps, Table 13.1.13.3.2-2)

Derivation Path: 36.331 clause 6.3.1				
Information Element	Value/remark	Comment	Condition	
SystemInformationBlockType7 ::= SEQUENCE {				
t-ReselectionGERAN	0			
t-ReselectionGERAN-SF				
carrierFreqsInfoList				
carrierFreqsInfoListSEQUENCE (SIZE (1..maxGNFG)) OF SEQUENCE {				
carrierFreqs carrierFreqs[n] SEQUENCE {				
startingARFCN[n]	Same starting ARFCN used for cell 24			
bandIndicator[n]	same band used for GERAN cell24			
followingARFCNs[n] CHOICE {				
explicitListOfARFCNs[n]	Same ARFCN used for cell24			
}				
}				
commonInfo[n] SEQUENCE {				
cellReselectionPriority[n]	3	Lower priority than E-UTRA		
}				
}				
}				

Table 13.1.13.3.3-2: Message *Paging* (step 1, Table 13.1.13.3.2-2)

Derivation Path: 36.508 clause 4.6.1-7			
Information Element	Value/remark	Comment	Condition
Paging ::= SEQUENCE {			
pagingRecordList SEQUENCE (SIZE (1..maxPageRec)) OF SEQUENCE {	1 entry		
ue-Identity[1] CHOICE {			
s-TMSI	Set to the value of the S-TMSI of the UE		
}			
cn-Domain[1]	cs		
}			
}			

Table 13.1.13.3.3-3: *RRCConnectionSetupComplete* (step 5, Table 13.1.13.3.2-2)

Derivation Path: 36.508 Table 4.6.1-18			
Information Element	Value/remark	Comment	Condition
RRCConnectionSetupComplete ::= SEQUENCE {			
rrc-TransactionIdentifier	RRC-TransactionIdentifier-UL		
criticalExtensions CHOICE {			
c1 CHOICE {			
rrcConnectionSetupComplete-r8 SEQUENCE {			
selectedPLMN-Identity	Set to the PLMN selected by upper layers		
registeredMME	Not present		
dedicatedInfoNAS	Set according to 36.508 Table 4.7.2-14A	EXTENDED SERVICE REQUEST	
nonCriticalExtension SEQUENCE {}	Not checked		
}			
}			
}			
}			

Table 13.1.13.3.3-4: *RRCConnectionReconfiguration* (step 5C, Table 13.1.13.3.2-2)

Derivation Path: 36.508 Table 4.6.1-8, condition SRB2-DRB(1, 0)

Table 13.1.13.3.3-5: Message *MobilityFromEUTRACommand* (step 6, Table 13.1.13.3.2-2)

Derivation Path: 36.508 clause 4.6.1-6			
Information Element	Value/remark	Comment	Condition
MobilityFromEUTRACommand ::= SEQUENCE {			
criticalExtensions CHOICE {			
c1 CHOICE {			
mobilityFromEUTRACommand-r8 SEQUENCE {			
csFallbackIndicator	True		
purpose CHOICE {			
handover SEQUENCE {			
targetRAT-Type	Geran		
targetRAT-MessageContainer	PS HANDOVER COMMAND		
nas-SecurityParamFromEUTRA	Not Present		
systemInformation	Not present		
}			
}			
}			
}			
}			
}			

Table 13.1.13.3.3-6: PS HANDOVER COMMAND (step 6, Table 13.1.13.3.2-2)

Derivation Path: TS 36.508 Table 4.7D.1-1

Table 13.1.13.3.3-7: PACKET CS REQUEST (step 9a1, Table 13.1.13.3.2-2)

Derivation Path: 44.060 clause 11.4.35			
Information Element	Value/remark	Comment	Condition
GLOBAL TFI	0 <5 bit Uplink TFI>		
ESTABLISHMENT CAUSE	00000000	Location updating	

Table 13.1.13.3.3-8: PACKET CS COMMAND (step 9a2 and 9b6, Table 13.1.13.3.2-2)

Derivation Path: 44.060 clause 11.4.35			
Information Element	Value/remark	Comment	Condition
PAGE_MODE	00		
GLOBAL_TFI {	0 <5 bit Uplink TFI>		
Spare	00		
CONTAINER_LENGTH	The length of message DTM ASSIGNMENT COMMAND		
DTM ASSIGNMENT COMMAND	Specified in Table 13.1.13.3.3-9		
}			

Table 13.1.13.3.3-9: DTM ASSIGNMENT COMMAND (Table 13.1.13.3.3-8)

Derivation Path: 51.010 clause 40.2.4.28			
Information Element	Value/remark	Comment	Condition
Channel Description IE			
TN	N+1 mod 8		
Channel Type	TCH/F		
Channel Mode IE	Full Rate Version 1		
RR Packet Uplink Assignment IE	Not included		
RR Packet Downlink Assignment IE	Not included		

Table 13.1.13.3.3-10: LOCATION UPDATING ACCEPT (step 9a8, Table 13.1.13.3.2-2)

Derivation Path: TS 36.508 Table 4.7B.2-5			
Information Element	Value/remark	Comment	Condition
Mobile identity	Not present		

Table 13.1.13.3.3-11: ATTACH ACCEPT (Preamble)

Derivation Path: 36.508 Table 4.7.2-1			
Information Element	Value/remark	Comment	Condition
EPS network feature support	Not present		

13.1.14

13.1.15 Call setup from E-UTRAN RRC_IDLE / CS fallback to UTRAN with redirection / MT call / UTRAN cell is barred

13.1.15.1 Test Purpose (TP)

(1)

```
with { UE in E-UTRA RRC_CONNECTED state having transmitted EXTENDED SERVICE REQUEST message for
mobile terminating CS call and a UTRA cell which broadcasts SystemInformationBlockType3 indicating
access barred for mobile originating CS call is available }
ensure that {
  when { UE receives an RRCConnectionRelease message with redirection to a UTRA carrier }
  then { UE transmits a PAGING RESPONSE message in the UTRA cell }
}
```

13.1.15.2 Conformance requirements

References: The conformance requirements covered in the present TC are specified in: TS 25.331, clause 8.1.1.6.3.

[TS 25.331, clause 8.1.1.6.3]

The UE shall apply the following handling with respect to any Access Class Barring information:

1> if in idle mode:

2> if the IE "Paging Permission with Access Control Parameters For PLMN Of MIB", the IE "Paging Permission with Access Control Parameters For OperatorN" or the IE "Paging Permission with Access Control Parameters For All" to be applied according to the requirements above is included in System Information Block Type 3, the UE shall:

3> if Paging Response Restriction Indication is set to "None":

4> when sending a response to any PAGING TYPE 1 message, *Paging* message specified in [67] or CS SERVICE NOTIFICATION message specified in [79], act as if no Access Class is barred in the IE "Access Class Barred List" as specified in [4].

3> if Paging Response Restriction Indication is set to "PS":

4> when sending a response to any PAGING TYPE 1 message, *Paging* message specified in [67] or CS SERVICE NOTIFICATION message specified in [79] from CS domain, act as if no Access Class is barred in the IE "Access Class Barred List" as specified in [4];

4> when sending a response to any PAGING TYPE 1 message, *Paging* message specified in [67] or CS SERVICE NOTIFICATION message specified in [79] from PS domain, act on the IE "Domain Specific Access Class Barred List" if indicated in the IE "PS Domain Specific Access Restriction" (or IE "Access Class Barred list" if IE "Domain Specific Access Class Barred List" is not present) as specified in [4].

3> if Paging Response Restriction Indication is set to "CS":

- 4> when sending a response to any PAGING TYPE 1 message, *Paging* message specified in [67] or CS SERVICE NOTIFICATION message specified in [79] from PS domain, act as if no Access Class is barred in the IE "Access Class Barred List" as specified in [4];
- 4> when sending a response to any PAGING TYPE 1 message, *Paging* message specified in [67] or CS SERVICE NOTIFICATION message specified in [79] from CS domain, act on the IE "Domain Specific Access Class Barred List" if indicated in the IE "CS Domain Specific Access Restriction" (or IE "Access Class Barred list" if IE "Domain Specific Access Class Barred List" is not present) as specified in [4].
- 3> else (if Paging Response Restriction Indication is set to "All"):
- 4> when sending a response to any PAGING TYPE 1 message, *Paging* message specified in [67] or CS SERVICE NOTIFICATION message specified in [79] from CS domain, act on the IE "Domain Specific Access Class Barred List" if indicated in the IE "CS Domain Specific Access Restriction" as specified in [4];
- 4> when sending a response to any PAGING TYPE 1 message, *Paging* message specified in [67] or CS SERVICE NOTIFICATION message specified in [79] from PS domain, act on the IE "Domain Specific Access Class Barred List" if indicated in the IE "PS Domain Specific Access Restriction" as specified in [4];
- 4> when sending a response to any PAGING TYPE 1 message, *Paging* message specified in [67] or CS SERVICE NOTIFICATION message specified in [79] from PS or CS domain, act on the IE "Access Class Barred list" if the IE "Domain Specific Access Class Barred List" is not present.
- 3> when initiating a Location/Registration procedure to CS domain, act on the IE "Location/Registration Access Class Barred List" if the IE "Location/Registration Restriction Indicator" is set to "All" or "CS", as specified in [4];
- 3> when initiating an access to CS domain for any other reason, act on the IE "Domain Specific Access Class Barred List" if indicated in the IE "CS Domain Specific Access Restriction" (or IE "Access Class Barred list" if IE "Domain Specific Access Class Barred List" is not present) as specified in [4];
- 3> when initiating a Location/Registration procedure to PS domain, act on the IE "Location/Registration Access Class Barred List" if the IE "Location/Registration Restriction Indicator" is set to "All" or "PS", as specified in [4];
- 3> when initiating an access to PS domain for any other reason, act on the IE "Domain Specific Access Class Barred List" if indicated in the IE "PS Domain Specific Access Restriction" (or IE "Access Class Barred list" if IE "Domain Specific Access Class Barred List" is not present) as specified in [4].

13.1.15.3 Test description

13.1.15.3.1 Pre-test conditions

System Simulator:

- Cell 1 and Cell 5.
- power levels are constant and as defined in table 13.1.15.3.1-1;
- System information combination 4 as defined in TS 36.508 section 4.4.3.1 is used in E-UTRA cells.

Table 13.1.15.3.1-1: Cell power levels

	Parameter name	Unit	Cell 1	Cell 5
T0	RS EPRE	dBm/15kHz	-75	
	CPICH_Ec	dBm/3.84 MHz		-70
	P-CCPCH	dBm/1.28 MHz		-72
T1	RS EPRE	dBm/15kHz	Non-suitable "Off"	
	CPICH_Ec	dBm/3.84 MHz		-70
	P-CCPCH	dBm/1.28 MHz		-72

UE:

None.

Preamble:

- The UE is in state Registered, Idle mode (state 2) on Cell 1 according to [18].

13.1.15.3.2 Test procedure sequence

Table 13.1.15.3.2-1: Main behaviour

St	Procedure	Message Sequence		TP	Verdict
		U - S	Message		
1	The SS transmits a <i>Paging</i> message on Cell 1.	<--	<i>Paging</i>	-	-
2	The UE transmits an <i>RRCCConnectionRequest</i> message on Cell 1.	-->	<i>RRCCConnectionRequest</i>	-	-
3	The SS transmits an <i>RRCCConnectionSetup</i> message on Cell 1.	<--	<i>RRCCConnectionSetup</i>	-	-
4	The UE transmits an <i>RRCCConnectionSetupComplete</i> message on Cell 1. This message includes an EXTENDED SERVICE REQUEST message.	-->	<i>RRCCConnectionSetupComplete</i>	-	-
5-8	Void	-	-	-	-
9	The SS transmits an <i>RRCCConnectionRelease</i> message on Cell 1 with IE <i>redirectedCarrierInfo</i> including an <i>utra-FDD</i> or an <i>utra-TDD</i> of Cell 5.	<--	<i>RRCCConnectionRelease</i>	-	-
10	Check: Does the test result of CALL generic procedure in TS 36.508 [18] clause 6.4.3.7.1 indicate that the UE performs CS fallback to UTRAN with redirection / MT call (PS bearers not established) on Cell 5?	-	-	1	-
10A	SS adjusts cell levels according to row T1 of table 13.1.15.3.1-1.				
11-28	Void	-	-	-	-

Table 13.1.15.3.2-2: Void

13.1.15.3.3 Specific message contents

Table 13.1.15.3.3-1: System Information Block type3 for Cell 5 (preamble and all steps, Table 13.1.15.3.2-1)

Information Element	Value/remark
Access Class Barred List	
- Access Class Barred0	barred
- Access Class Barred1	barred
- Access Class Barred2	barred
- Access Class Barred3	barred
- Access Class Barred4	barred
- Access Class Barred5	barred
- Access Class Barred6	barred
- Access Class Barred7	barred
- Access Class Barred8	barred
- Access Class Barred9	barred
- Access Class Barred10	barred
- Access Class Barred11	barred
- Access Class Barred12	barred
- Access Class Barred13	barred
- Access Class Barred14	barred
- Access Class Barred15	barred

Domain Specific Access Restriction Parameters For PLMN Of MIB	
-CS Domain Specific Access Restriction	restriction
-Domain Specific Access Class Barred List	
-Access Class Barred List	
- Access Class Barred0	barred
- Access Class Barred1	barred
- Access Class Barred2	barred
- Access Class Barred3	barred
- Access Class Barred4	barred
- Access Class Barred5	barred
- Access Class Barred6	barred
- Access Class Barred7	barred
- Access Class Barred8	barred
- Access Class Barred9	barred
- Access Class Barred10	barred
- Access Class Barred11	barred
- Access Class Barred12	barred
- Access Class Barred13	barred
- Access Class Barred14	barred
- Access Class Barred15	barred
-PS Domain Specific Access Restriction	no restriction
Paging Permission with Access Control Parameters For PLMN Of MIB	
- Paging Response Restriction Indication	none
- Location/Registration Restriction Indicator	All
- Location/Registration	
- Location/Registration Access Restriction	no restriction

Table 13.1.15.3.3-2: Paging (step 1, Table 13.1.15.3.2-1)

Derivation Path: 36.508, Table 4.6.1-7			
Information Element	Value/remark	Comment	Condition
Paging ::= SEQUENCE {			
pagingRecordList SEQUENCE (SIZE (1..maxPageRec)) OF SEQUENCE {	1 entry		
cn-Domain	cs		
}			
}			

Table13.1.15.3.3-3: Void

Table 13.1.15.3.3-4: RRCConnectionRelease (step 9, Table 13.1.15.3.2-1)

Derivation Path: 36.508 Table 4.6.1-15			
Information Element	Value/remark	Comment	Condition
RRCConnectionRelease ::= SEQUENCE {			
criticalExtensions CHOICE {			
c1 CHOICE {			
rrcConnectionRelease-r8 SEQUENCE {			
redirectedCarrierInfo ::= CHOICE {			
ultra-FDD	Downlink UARFCN of cell 5		UTRA-FDD
ultra-TDD	Downlink UARFCN of cell 5		UTRA-TDD
}			
}			
}			
}			
}			

Condition	Explanation
UTRA-FDD	UTRA FDD cell environment
UTRA-TDD	UTRA TDD cell environment

Table 13.1.15.3.3-5: ATTACH ACCEPT (Preamble)

Derivation Path: 36.508 Table 4.7.2-1			
Information Element	Value/remark	Comment	Condition
EPS network feature support	Not present		

13.1.16 Emergency call setup from E-UTRAN RRC_IDLE / CS fallback to UTRAN with handover

13.1.16.1 Test Purpose (TP)

(1)

```
with { UE is in E-UTRA RRC_IDLE state }
ensure that {
  when { the user initiates an emergency call }
  then { UE transmits an RRCConnectionRequest message with establishmentCause set to "emergency"
and an EXTENDED SERVICE REQUEST message with Service type IE set to "mobile originating CS fallback
emergency call or 1xCS fallback emergency call" }
}
```

(2)

```
with { UE in E-UTRA RRC_CONNECTED state having requested an emergency call }
ensure that {
  when { UE receives a MobilityFromEUTRACommand message including a cs-FallbackIndicator set to
'true' and a targetRAT-Type set to 'utra' }
  then { UE transmits a HANDOVER TO UTRAN COMPLETE message and establishes the emergency call }
}
```

13.1.16.2 Conformance requirements

References: The conformance requirements covered in the present TC are specified in: TS 23.272, clause 4.6 and TS 36.331, clause 5.4.3.3.

[TS 23.272, clause 4.6]

When UE is performing CS fallback procedure for Mobile Originating Call for the purpose of emergency call, it shall indicate to the MME that this CS fallback request is for emergency purpose. MME also indicates to the E-UTRAN via the appropriate S1-AP message that this CS fallback procedure is for emergency purpose.

NOTE: E-UTRAN may use the emergency indication for selecting a particular radio access network (2G or 3G) for CS emergency handling.

[TS 36.331, clause 5.4.3.3]

The UE shall be able to receive a *MobilityFromEUTRACommand* message and perform a cell change order to GERAN, even if no prior UE measurements have been performed on the target cell.

The UE shall:

- 1> stop timer T310, if running;
- 1> if the *MobilityFromEUTRACommand* message includes the *purpose* set to 'handover':
 - 2> if the *targetRAT-Type* is set to 'utra' or 'geran':
 - 3> consider inter-RAT mobility as initiated towards the RAT indicated by the *targetRAT-Type* included in the *MobilityFromEUTRACommand* message;
 - 3> forward the *nas-SecurityParamFromEUTRA* to the upper layers;

3> access the target cell indicated in the inter-RAT message in accordance with the specifications of the target RAT;

3> if the *targetRAT-Type* is set to 'geran':

4> use the contents of *systemInformation*, if provided for PS Handover, as the system information to begin access on the target GERAN cell;

NOTE 1: If there are DRBs for which no radio bearers are established in the target RAT as indicated in the *targetRAT-MessageContainer* in the message, the E-UTRA RRC part of the UE does not indicate the release of the concerned DRBs to the upper layers. Upper layers may derive which bearers are not established from information received from the AS of the target RAT.

13.1.16.3 Test description

13.1.16.3.1 Pre-test conditions

System Simulator:

- Cell 1 and Cell 5.
- System information combination 4 as defined in TS 36.508 [18] clause 4.4.3.1 is used in E-UTRA cell.

Table 13.1.16.3.1-1 shows the cell power levels after the preamble.

Table 13.1.16.3.1-1: Time instances of cell power level and parameter changes

	Parameter name	Unit	Cell 1	Cell 5
T0	RS EPRE	dBm/15kHz	-85	
	CPICH_Ec	dBm/3.84 MHz		-70
	P-CCPCH	dBm/1.28 MHz		-72
T1	RS EPRE	dBm/15kHz	Non-suitable "Off"	
	CPICH_Ec	dBm/3.84 MHz		-70
	P-CCPCH	dBm/1.28 MHz		-72

UE:

None.

Preamble:

- The UE is in state Registered, Idle mode (state 2) on Cell 1 according to [18].
- The UE has a valid TMSI (TMSI-1) and is registered in LAI-1.

13.1.16.3.2 Test procedure sequence

Table 13.1.16.3.2-1: Main behaviour

St	Procedure	Message Sequence		TP	Verdict
		U - S	Message		
1	Cause the UE to originate emergency call. (see Note 1)	-	-	-	-
2	Check: Does the UE transmit an <i>RRCCConnectionRequest</i> message on Cell 1?	-->	<i>RRCCConnectionRequest</i>	1	P
3	The SS transmits an <i>RRCCConnectionSetup</i> message on Cell 1.	<--	<i>RRCCConnectionSetup</i>	-	-
4	Check: Does the UE transmits an <i>RRCCConnectionSetupComplete</i> message on Cell 1 including an EXTENDED SERVICE REQUEST message with Service type IE set to "mobile originating CS fallback emergency call or 1xCS fallback emergency call"?	-->	<i>RRCCConnectionSetupComplete</i>	1	P
5	The SS transmits a <i>SecurityModeCommand</i> message on Cell 1.	<--	<i>SecurityModeCommand</i>	-	-
6	The UE transmits a <i>SecurityModeComplete</i> message on Cell 1.	-->	<i>SecurityModeComplete</i>	-	-
7	The SS transmits an <i>RRCCConnectionReconfiguration</i> message on Cell 1.	<--	<i>RRCCConnectionReconfiguration</i>	-	-
8	The UE transmits an <i>RRCCConnectionReconfigurationComplete</i> message on Cell 1.	-->	<i>RRCCConnectionReconfigurationComplete</i>	-	-
8A	The SS transmits a <i>UECapabilityEnquiry</i> message to request UE radio access capability information for E-UTRA and UTRA.	<--	<i>UECapabilityEnquiry</i>	-	-
8B	The UE transmit a <i>UECapabilityInformation</i> message on Cell 1. NOTE: The start-PS values received, should be used to configure ciphering on cell 5.	-->	<i>UECapabilityInformation</i>	-	-
9	The SS transmits a <i>MobilityFromEUTRACommand</i> message on Cell 1.	<--	<i>MobilityFromEUTRACommand</i>	-	-
10	Check: Does the test result of CALL generic procedure [18] clause 6.4.3.7.7 indicate that the UE performs CS fallback to UTRAN with Handover / emergency call on Cell 5?	-	-	2	-
11	SS adjusts cell levels according to row T1 of table 13.1.16.3.1-1.				

Note 1: The trigger in step 1 is the same as in the generic procedure in 36.508 clause 6.4.3.5.

13.1.16.3.3 Specific message contents

Table 13.1.16.3.3-1: *RRCCConnectionRequest* (step 2, Table 13.1.16.3.2-1)

Derivation Path: 36.508, Table 4.6.1-16			
Information Element	Value/remark	Comment	Condition
<i>RRCCConnectionRequest</i> ::= SEQUENCE {			
criticalExtensions CHOICE {			
rrcConnectionRequest-r8 SEQUENCE {			
establishmentCause	emergency		
}			
}			
}			

Table 13.1.16.3.3-2: EXTENDED SERVICE REQUEST (step 4, Table 13.1.16.3.2-1)

Derivation Path: TS 36.508, Table 4.7.2-14A			
Information Element	Value/remark	Comment	Condition
Service type	'0010'B	mobile originating	

		CS fallback emergency call or 1xCS fallback emergency call	
CSFB response	Not present		

Table 13.1.16.3.3-3: RRCConnectionReconfiguration (step 7, Table 13.1.16.3.2-1)

Derivation Path: 36.508 Table 4.6.1-8, condition SRB2-DRB(1, 0)

Table 13.1.16.3.3-4: MobilityFromEUTRACommand (step 9, Table 13.1.16.3.2-1)

Derivation Path: 36.508, Table 4.6.1-6			
Information Element	Value/remark	Comment	Condition
MobilityFromEUTRACommand ::= SEQUENCE {			
criticalExtensions CHOICE {			
c1 CHOICE{			
mobilityFromEUTRACommand-r8 SEQUENCE {			
cs-FallbackIndicator	true		
purpose CHOICE{			
handover SEQUENCE {			
targetRAT-Type	utra		
targetRAT-MessageContainer	HANDOVER TO UTRAN COMMAND(UTRA RRC message)		
nas-SecurityParamFromEUTRA	The 4 least significant bits of the NAS downlink COUNT value		
systemInformation	Not present		
}			
}			
}			
}			
}			
}			
}			

Table 13.1.16.3.3-5: HANDOVER TO UTRAN COMMAND (Table 13.1.16.3.3-4)

Derivation Path: 36.508, Table 4.7B.1-1, condition UTRA PS RB

Table 13.1.16.3.3-6: UECapabilityEnquiry (step 8A, Table 13.1.16.3.2-1)

Derivation path: 36.508 clause 4.6.1 table 4.6.1-22			
Information Element	Value/Remark	Comment	Condition
UECapabilityEnquiry ::= SEQUENCE {			
criticalExtensions CHOICE {			
c1 CHOICE {			
ueCapabilityEnquiry-r8 SEQUENCE {			
ue-CapabilityRequest SEQUENCE (SIZE (1..maxRAT-Capabilities)) OF SEQUENCE {	2 entry		
RAT-Type[1]	eutra		
RAT-Type[2]	utra		
}			
}			
}			
}			
}			

Table 13.1.16.3.3-7: ATTACH ACCEPT (Preamble)

Derivation Path: 36.508 Table 4.7.2-1			
Information Element	Value/remark	Comment	Condition
EPS network feature support	Not present		

13.1.17 Call setup from E-UTRAN RRC_IDLE / mobile originating 1xCS fallback emergency call to 1xRTT

13.1.17.1 Test Purpose (TP)

(1)

```
with { UE in state EMM-REGISTERED and EMM-IDLE }
ensure that {
  when { UE initiates a mobile originating 1xCS fallback emergency call }
  then { UE establishes the RRC connection with the RRC establishmentCause set to 'emergency' and
transmits an EXTENDED SERVICE REQUEST message with Service Type IE set to "mobile originating CS
fallback emergency call or 1xCS fallback emergency call" }
}
```

(2)

```
with { UE having transmitted an EXTENDED SERVICE REQUEST message with Service Type IE set to "mobile
originating CS fallback emergency call or 1xCS fallback emergency call" }
ensure that {
  when { SS transmits a RRCConnectionRelease message with redirection to 1xRTT }
  then { UE tunes to 1xRTT cell, transmits a 1xRTT Origination message on 1xRTT cell and
establishes the emergency call }
}
```

13.1.17.2 Conformance requirements

References: The conformance requirements covered in the present TC are specified in: 3GPP TS 24.301 clauses 5.3.1.1, 5.6.1.1, 5.6.1.2, 5.6.1.4 and D.1.

[TS 24.301 clause 5.3.1.1]

When the UE is in EMM-IDLE mode and needs to transmit an initial NAS message, the UE shall request the lower layer to establish a NAS signalling connection. In this request to the lower layer the NAS shall provide to the lower layer the RRC establishment cause and the call type as specified in annex D of this specification.

[TS 24.301 clause 5.6.1.1]

The purpose of the service request procedure is to transfer the EMM mode from EMM-IDLE to EMM-CONNECTED mode and establish the radio and S1 bearers when uplink user data or signalling is to be sent. Another purpose of this procedure is to invoke MO/MT CS fallback procedures.

This procedure is used when:

...

- the UE in EMM-IDLE or EMM-CONNECTED mode has requested to perform mobile originating/terminating CS fallback; or

...

The service request procedure is initiated by the UE, however, for the downlink transfer of signalling, cdma2000[®] signalling or user data in EMM-IDLE mode, the trigger is given by the network by means of the paging procedure (see subclause 5.6.2).

The UE shall invoke the service request procedure when:

...

- f) the UE in EMM-IDLE or EMM-CONNECTED mode is configured to use 1xCS fallback and has a mobile originating 1xCS fallback request from the upper layer;

...

[TS 24.301 clause 5.6.1.2]

For cases f and g in subclause 5.6.1.1, the UE shall send an EXTENDED SERVICE REQUEST message, start T3417 and enter the state EMM-SERVICE-REQUEST-INITIATED.

[TS 24.301 clause 5.6.1.4]

If the service type information element in the EXTENDED SERVICE REQUEST message indicates "mobile terminating CS fallback or 1xCS fallback" and the CSFB response IE indicates "CS fallback accepted by the UE", or if the service type information element in the EXTENDED SERVICE REQUEST message indicates "mobile originating CS fallback or 1xCS fallback" or "mobile originating CS fallback emergency call or 1xCS fallback emergency call", the network initiates CS fallback procedures. If the EPS bearer context status IE is included in the EXTENDED SERVICE REQUEST message, the network shall deactivate all those EPS bearer contexts locally (without peer-to-peer signalling between the network and the UE) which are active on the network side but are indicated by the UE as being inactive.

....

For cases f and g in subclause 5.6.1.1, the UE shall treat the indication from the lower layers that the signalling connection is released with the redirection indication to cdma2000[®] 1x access network or the indication from the lower layers that a change to cdma2000[®] 1x access network for 1xCS fallback has started (see 3GPP TS 36.331 [22]) as successful completion of the procedure. The UE shall stop the timer T3417 and enter the state EMM-REGISTERED.NO-CELL-AVAILABLE.

[TS 24.301 clause D.1]

When EMM requests the establishment of a NAS-signalling connection, the RRC establishment cause used by the UE shall be selected according to the NAS procedure as specified in table D.1.1. The EMM shall also indicate to the lower layer for the purpose of access control, the call type associated with the RRC establishment cause as specified in table D.1.1.

Table D.1.1: Mapping of NAS procedure to establishment cause and call type

NAS procedure	RRC establishment cause (according 3GPP TS 36.331 [22])	Call type
...		
Service Request	If an EXTENDED SERVICE REQUEST has service type set to "mobile originating CS fallback emergency call or 1xCS fallback emergency call", the RRC establishment cause shall be set to Emergency call. (See Note1).	"emergency calls"
...		
Note 1: For these NAS procedures initiated by UEs of access class 12, 13 or 14 in their home country, the RRC establishment cause will be set to "High priority access AC 11 – 15". For this purpose the home country is defined as the country of the MCC part of the IMSI, see 3GPP TS 22.011 [1A]. For these NAS procedures initiated by UE of access class 11 or 15 in their HPLMN or EHPLMN, the RRC establishment cause will be set to "High priority access AC 11 – 15".		

13.1.17.3 Test description

13.1.17.3.1 Pre-test conditions

System Simulator:

- cell 1 and cell 19.
- cell 1 is "Serving cell" and cell 19 is "Suitable cell".
- System information combination 6 as defined in TS 36.508[18] clause 4.4.3.1 is used in E-UTRA cells.

UE:

- The UE is equipped with a USIM containing default values (as per TS 36.508) except for those shown in Table 13.1.17.3.1-1.

Table 13.1.17.3.1–1: USIM Configuration

USIM field	Value
EF _{ACC}	Type "A" as defined in TS34.108 clause 8.3.2.15

Preamble:

- the UE is in state Registered, Idle Mode (State 2C) on cell 1 according to TS 36.508 [18];
- the UE has completed the 1xRTT CS pre-registration procedure on cell 19.

13.1.17.3.2 Test procedure sequence

Table 13.1.17.3.2-1: Main behaviour

St	Procedure	Message Sequence		TP	Verdict
		U - S	Message		
1	Cause the UE to originate an emergency CS call. (Note1)	-	-	-	-
2	Check: Does the UE transmit an <i>RRCConnectionRequest</i> message with <i>establishmentCause</i> set to 'emergency'?	-->	RRC: RRC CONNECTION REQUEST	1	P
3	The SS transmits an RRC CONNECTION SETUP message.	<--	RRC: RRC CONNECTION SETUP	-	-
4	Check: Does the UE transmit an RRC CONNECTION SETUP COMPLETE message?	-->	RRC: RRC CONNECTION SETUP COMPLETE	1	P
5	Check: Does the UE transmit an EXTENDED SERVICE REQUEST message with Service Type IE set to "mobile originating CS fallback emergency call or 1xCS fallback emergency call"?	-->	EXTENDED SERVICE REQUEST	1	P
6	The SS releases the RRC Connection on cell 1 redirecting the UE to Cell 19.	<--	<i>RRCConnectionRelease</i>	-	-
7	Check: Does the UE transmit an <i>Origination</i> message on Cell 19?	-->	<i>Origination</i>	2	P
8	The SS transmits an <i>Extended Channel Assignment</i> message on Cell 19.	<--	<i>Extended Channel Assignment</i>	-	-
9	After the SS detects that Traffic Channel Initialization is successful, it transmits an <i>Acknowledgement Order</i> message on Cell 19.	<--	<i>Acknowledgement Order</i>	-	-
10	The SS transmits a <i>Service Connect</i> message on Cell 19.	<--	<i>Service Connect</i>	-	-
11	The UE transmits a <i>Service Connect Completion</i> message on Cell 19.	-->	<i>Service Connect Completion</i>	2	P
12	Mobile originating 1xRTT emergency call is set up.	-	-	-	-

Note 1: This could be done by e.g. MMI or AT command.

13.1.17.3.3 Specific message contents

Table 13.1.17.3.3-1: SystemInformationBlockType8 for Cell 1 (all steps, Table 13.1.17.3.2-1)

Derivation Path: 36.508 Table 4.4.3.3-7, condition 1XRTT			
Information Element	Value/remark	Comment	Condition
SystemInformationBlockType8 ::= SEQUENCE {			
parameters1XRTT SEQUENCE {			
csfb-RegistrationParam1XRTT SEQUENCE {			
Sid	Set by SS	Sid of Cell 19	
Nid	Set by SS	Nid of Cell 19	
}			
longCodeState1XRTT	Set by SS	BIT STRING (SIZE (42)) OPTIONAL	
}			
cellReselectionParameters1XRTT SEQUENCE {			
bandClassList SEQUENCE (SIZE (1..maxCDMA-BandClass)) OF SEQUENCE {	1 entry		
cellReselectionPriority	3		
}			
}			
}			

Table 13.1.17.3.3-2: Message RRCConnectionRequest (step 2, Table 13.1.17.3.2-1)

Derivation path: 36.508 table 4.6.1-16			
Information Element	Value/Remark	Comment	Condition
RRCConnectionRequest ::= SEQUENCE {			
criticalExtensions CHOICE {			
rrcConnectionRequest-r8 SEQUENCE {			
establishmentCause	emergency		
}			
}			
}			

Table 13.1.17.3.3-3: Message EXTENDED SERVICE REQUEST (step 5, Table 13.1.17.3.2-1)

Derivation Path: 36.508 clause 4.7.2-14A			
Information Element	Value/remark	Comment	Condition
Service type	'0010'B	"mobile originating CS fallback emergency call or 1xCS fallback emergency call"	
CSFB response	Not present		

Table 13.1.17.3.3-4: RRCConnectionRelease (step 6, Table 13.1.17.3.2-1)

Derivation Path: 36.508 table 4.6.1-15			
Information Element	Value/remark	Comment	Condition
RRCConnectionRelease ::= SEQUENCE {			
criticalExtensions CHOICE {			
c1 CHOICE {			
rrcConnectionRelease-r8 SEQUENCE {			
redirectionInformation ::= CHOICE {			
interRAT-target CHOICE {			
cdma2000-1xRTT	cdma2000-CarrierInfo for Cell 19		
}			
}			
}			
}			
}			
}			

Table 13.1.17.3.3-5: Origination (step 7, Table 13.1.17.3.2-1)

Field	Value/remark	Comment	Condition
MSG_ID	'000100'B	Origination Message	this value shall be verified by TTCN
SPECIAL_SERVICE	'1'B		
SERVICE_OPTION	Any value mapping to a voice service option		

Table 13.1.17.3.3-6: Extended Channel Assignment (step 8, Table 13.1.17.3.2-1)

Field	Value/remark	Comment	Condition
MSG_ID	'010101'B	Extended Channel Assignment Message	
ASSIGN_MODE	'000'B	Traffic Channel Assignment	

Table 13.1.17.3.3-7: Acknowledgment Order (step 9, Table 13.1.17.3.2-1)

Field	Value/remark	Comment	Condition
MSG_ID	'00000001'B	Order Message	
ORDER	'010000'B	Base Station Acknowledgment Order	
ORDQ	'00000000'B		

Table 13.1.17.3.3-8: Service Connect (step 8, Table 13.1.17.3.2-1)

Field	Value/remark	Comment	Condition
MSG_ID	'00010100'B	Service Connect Message	
SERV_CON_SEQ	Set by SS		

Table 13.1.17.3.3-9: Service Connect Completion (step 9, Table 13.1.17.3.2-1)

Information Element	Value/remark	Comment	Condition
MSG_ID	'00001110'B	Service Connect Completion Message	this value shall be verified by TTCN
SERV_CON_SEQ	Same value as SERV_CON_SEQ received in Service Connect Message (Table 13.1.17.3.3-8)		

13.1.18 Call setup from E-UTRAN RRC_IDLE / mobile originating enhanced 1xCS fallback emergency call to 1xRTT

13.1.18.1 Test Purpose (TP)

(1)

```
with { UE in state EMM-REGISTERED and EMM-IDLE }
ensure that {
  when { UE initiates a mobile originating 1xCS fallback emergency call }
  then { UE establishes the RRC connection with the RRC establishmentCause set to 'emergency' and
transmits an EXTENDED SERVICE REQUEST message with Service Type IE set to "mobile originating CS
fallback emergency call or 1xCS fallback emergency call" }
}
```

(2)

```
with { UE having transmitted an EXTENDED SERVICE REQUEST message with Service Type IE set to "mobile
originating CS fallback emergency call or 1xCS fallback emergency call" }
ensure that {
  when { SS transmits HandoverFromEUTRAPreparationRequest message with cdma2000-type set to
'type1XRTT' }
  then { UE transmits an ULHandoverPreparationTransfer message containing a tunnelled 1xRTT GCSNA
Encapsulated Origination message}
```

(3)

```
with { UE in E-UTRA RRC_CONNECTED state }
ensure that {
  when { UE receives a MobilityFromEUTRACommand message containing a tunnelled 1xRTT GCSNA
Encapsulated Handoff Direction message }
  then { UE transmits a 1xRTT Handoff Completion message on the target 1xRTT cell }
}
```

13.1.18.2 Conformance requirements

References: The conformance requirements covered in the present TC are specified in: TS 23.272, clause B.2.3a.2.

[TS 23.272, clause B.2.3a.2]

The following figure describes the mobile originating call procedures for the enhanced CS Fallback to 1xRTT with concurrent non-optimised PS handover or optimised idle-mode PS handover, or without concurrent PS handover, in the normal case. Clause B.2.3b describes the procedure when the procedure is rejected by the MME.

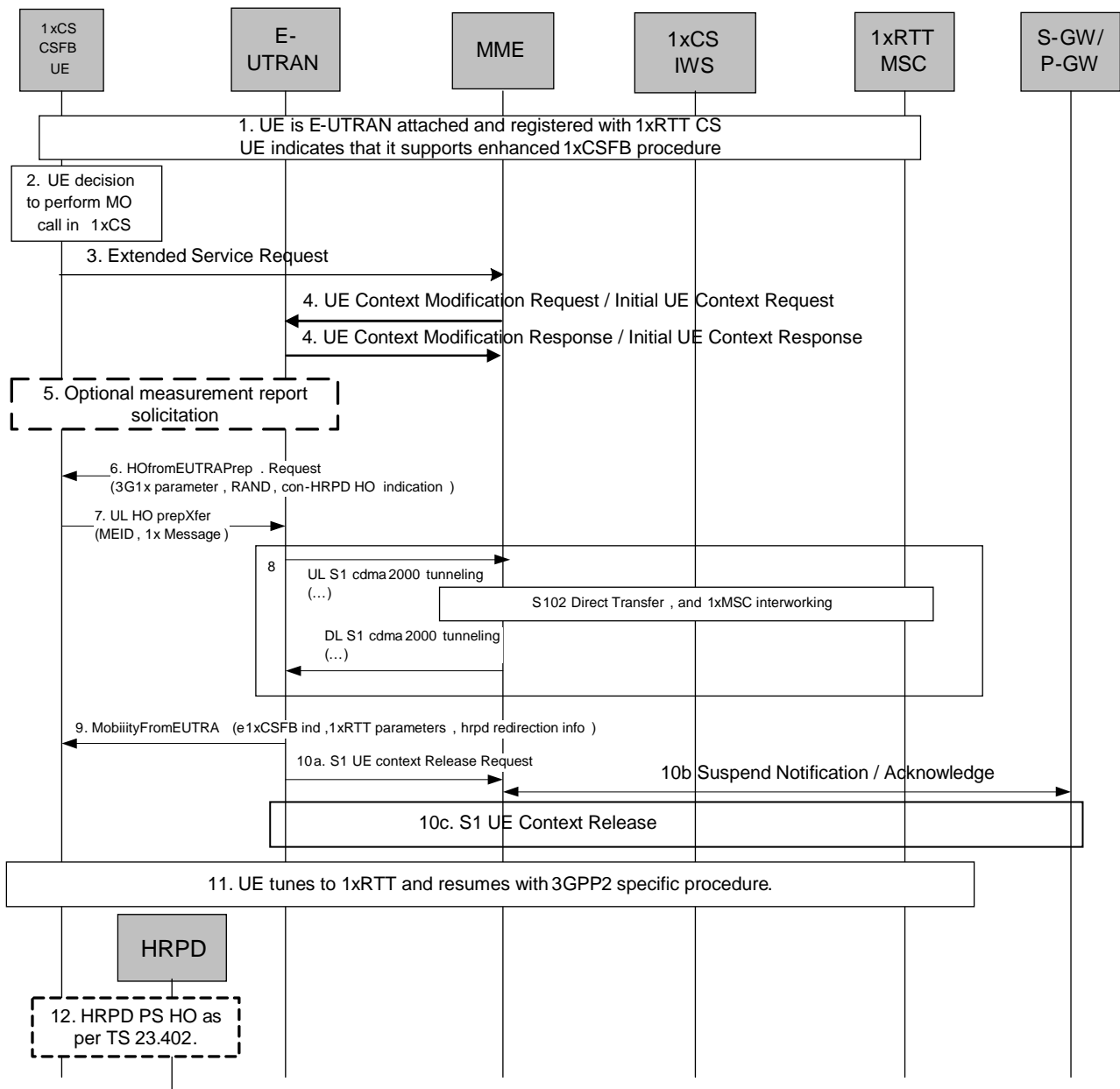

Figure B.2.3a.2-1: Enhanced CS fallback to 1xRTT MO Call with no PS handover, or with concurrent non-optimised PS handover or optimised idle-mode PS handover

1. UE is E UTRAN attached and registered with 1xRTT CS as defined in clause B.2.1.1 with enhanced CS fallback to 1xRTT capability indication to the network. The UE may also indicate that it supports concurrent 1xRTT and HRPD capability. The UE may also be pre-registered with HRPD access using procedures defined in TS 23.402 [27], clause 9.3.1.
2. UE makes a decision to perform a mobile originated CS call.
3. UE sends an Extended Service Request (CS Fallback Indicator) to the MME.
4. For a UE in active mode, MME sends UE Context Modification Request (CS Fallback Indicator) to E-UTRAN. CS Fallback Indicator indicates to the E UTRAN to move the UE to 1xRTT. E-UTRAN responds with UE Context Modification Response.

For a UE in idle mode, MME sends Initial UE Context Request (CS Fallback Indicator) to E-UTRAN. CS Fallback Indicator indicates to the E-UTRAN to move the UE to 1xRTT. E-UTRAN responds with Initial UE Context Response.

5. E-UTRAN may optionally solicit a 1xRTT measurement report from the UE to determine the target 1xRTT cell to which the CS Fallback will be performed.

If the network supports PS handover procedure to HRPD then E-UTRAN may optionally solicit an HRPD measurement report from the UE to determine whether the target HRPD candidates exist or not. If the network does not support PS handover procedure to HRPD or if no target HRPD candidates exist then E-UTRAN shall release the S1 UE context (see step 10a/b) after executing the enhanced CS fallback to 1xRTT procedure.

6. E-UTRAN sends a HandoverFromE-UTRANPreparation Request message to the UE to start the enhanced 1xCS fallback procedure. It includes 3G1x Overhead Parameters and RAND value. This message also includes an indication that concurrent HRPD handover preparation is not required.
7. The UE initiates signalling for establishment of the CS access leg by sending UL HandoverPreparation Transfer message which contains the 1xRTT Origination message with called party number.
8. Messages between MME and 1xIWS are tunnelled using the S102 interface. The 1xRTT MSC initiates the call with the called party number carried in the 1xRTT Origination message.
9. The E-UTRAN sends Mobility from EUTRA Command to the UE with indication that this is for enhanced 1x CS Fallback operation, 1xRTT related information, and optionally the HRPD redirection information. The 1xRTT information contains 1xRTT messages related to 1x channel assignment and cause the UE to tune to and acquire this 1x channel. This is perceived by the UE as a Handover Command message to 1xRTT. If 1xRTT CS network cannot support this CSFB request (for example due to resource availability), the DL information transfer message is sent instead, with an embedded 1x message that indicates failure to the UE.
- For either concurrent non-optimised PS handover procedure or optimised idle-mode PS handover procedure along with enhanced CS fallback to 1xRTT, E-UTRAN may also redirect the UE to HRPD as part of this procedure. This is indicated by the HRPD redirection information in the Mobility from EUTRA Command.
- 10a/b/c. If PS handover procedure is not performed then E-UTRAN sends an S1 UE Context Release Request (Cause) message to the MME. Cause indicates that the S1 UE Context Release was caused by CS fallback to 1xRTT. The S1-U bearers are released and the MME starts the preservation and suspension of non-GBR bearers and the deactivation of GBR bearers towards S-GW and P-GW(s). The MME sets the UE context to suspended status.
11. UE returns to the 1xRTT radio access network and performs 1xchannel acquisition with the 1xRTT CS access (e.g. 1xRTT BSS).
12. UE and Network follow the appropriate procedure for handling non-optimised PS handover procedure or optimised idle-mode PS handover as defined in TS 23.402 [27] if performed. S1 UE Context release procedure is as specified in TS 23.402 [27] for non-optimised PS handover (clause 8.2.2) or optimised idle-mode PS handover (clause 9.4). This step occurs in parallel with step 11.

[TS 24.301 clause D.1]

When EMM requests the establishment of a NAS-signalling connection, the RRC establishment cause used by the UE shall be selected according to the NAS procedure as specified in table D.1.1. The EMM shall also indicate to the lower layer for the purpose of access control, the call type associated with the RRC establishment cause as specified in table D.1.1.

Table D.1.1: Mapping of NAS procedure to establishment cause and call type

NAS procedure	RRC establishment cause (according 3GPP TS 36.331 [22])	Call type
...		
Service Request	If an EXTENDED SERVICE REQUEST has service type set to "mobile originating CS fallback emergency call or 1xCS fallback emergency call", the RRC establishment cause shall be set to Emergency call. (See Note1).	"emergency calls"
...		
Note 1: For these NAS procedures initiated by UEs of access class 12, 13 or 14 in their home country, the RRC establishment cause will be set to "High priority access AC 11 – 15". For this purpose the home country is defined as the country of the MCC part of the IMSI, see 3GPP TS 22.011 [1A]. For these NAS procedures initiated by UE of access class 11 or 15 in their HPLMN or EHPLMN, the RRC establishment cause will be set to "High priority access AC 11 – 15".		

13.1.18.3 Test description

13.1.18.3.1 Pre-test conditions

System Simulator:

- cell 1 and cell 19.
- cell 1 is "Serving cell" and cell 19 is "Suitable cell".
- System information combination 6 as defined in TS 36.508[18] clause 4.4.3.1 is used in E-UTRA cells.

UE:

- The UE is equipped with a USIM containing default values (as per TS 36.508) except for those shown in Table 13.1.18.3.1-1.

Table 13.1.18.3.1-1: USIM Configuration

USIM field	Value
EF _{Acc}	Type "A" as defined in TS34.108 clause 8.3.2.15

Preamble:

- The UE is in state pre-registered on 1xRTT (state 2C) on Cell 1 according to [18].

13.1.18.3.2 Test procedure sequence

Table 13.1.18.3.2-1 illustrates the downlink power levels and other changing parameters to be applied for the cells at various time instants of the test execution. Row marked "T0" denotes the initial conditions, while row marked "T1" is to be applied subsequently. The exact instants on which these values shall be applied are described in the texts in this clause.

Table 13.1.18.3.2-1: Cell configuration changes over time

	Parameter	Unit	Cell 1	Cell 19	Remark
T0	Cell-specific RS EPRE	dBm/15kHz	-60	-	S _{rxlev} _{Cell 1} > 0 and Cell 19 is off such that camping on Cell 1 is guaranteed.
	I _{or} /I _{oc}	dB	-	-	
	Pilot E _c /I _{or}	dB	-	-	
	I _{oc}	dBm/1.23 MHz	-	-	
	Pilot E _c /I _o (Note 1)	dB	-	-	
T1	Cell-specific RS EPRE	dBm/15kHz	-60	-	Cell 19 in on, with S _{ServingCell} > Thresh _{serv, low} and S _{nonServingCell, x} < Thresh _{x, low} .
	I _{or} /I _{oc}	dB	-	0	
	Pilot E _c /I _{or}	dB	-	-7	
	I _{oc}	dBm/1.23 MHz	-	-75	
	Pilot E _c /I _o (Note 1)	dB	-	-10	
Note 1: This parameter is not directly settable, but is derived by calculation from the other parameters set by the SS.					

Table 13.1.18.3.2-2: Main behaviour

St	Procedure	Message Sequence		TP	Verdict
		U - S	Message		
1	Cause the UE to originate an emergency CS call.(Note 1)	-	-	-	-
2	Check: Does the UE transmit an <i>RRCConnectionRequest</i> message with <i>establishmentCause</i> set to 'emergency'	-->	RRC: RRC CONNECTION REQUEST	1	P
3	The SS transmits an RRC CONNECTION SETUP message.	<--	RRC: RRC CONNECTION SETUP	-	-
4	Check: Does the UE transmit an RRC CONNECTION SETUP COMPLETE message?	-->	RRC: RRC CONNECTION SETUP COMPLETE	1	P
5	Check: Does the UE transmit an EXTENDED SERVICE REQUEST message with Service Type IE set to "mobile originating CS fallback emergency call or 1xCS fallback emergency call"?	-->	EXTENDED SERVICE REQUEST	1	P
6	The SS changes the cell power levels according to "T1" in Table 13.1.18.3.2-1.	-	-	-	-
7	The SS transmits an <i>RRCConnectionReconfiguration</i> message on Cell 1 to setup inter RAT measurement on Cell 19.	<--	<i>RRCConnectionReconfiguration</i>	-	-
8	The UE transmits an <i>RRCConnectionReconfigurationComplete</i> message on Cell 1 to confirm the setup of inter RAT measurement.	-->	<i>RRCConnectionReconfigurationComplete</i>	-	-
9	The UE transmits a <i>MeasurementReport</i> message on Cell 1 to report event B2 for Cell 19,	-->	<i>MeasurementReport</i>	-	-
10	The SS transmits a <i>HandoverFromEUTRAPreparationRequest</i> on Cell 1.	<--	<i>HandoverFromEUTRAPreparationRequest</i>	-	-
11	Check: Does the UE transmit a tunnelled <i>1xRTT GCSNA Encapsulated Origination</i> message contained in an <i>ULHandoverPreparationTransfer</i> message on Cell 1?	-->	<i>ULHandoverPreparationTransfer</i>	2	P
12	The SS transmits a tunnelled <i>1xRTT GCSNA Encapsulated Handoff Direction</i> message contained in a <i>MobilityFromEUTRACommand</i> on Cell1 to order the UE to perform inter RAT handover to Cell 19.	<--	<i>MobilityFromEUTRACommand</i>	-	-
13	The UE tunes to 1xRTT radio.	-	-	-	-
14	Check: Does the UE transmit a <i>1xRTT Handoff Completion</i> message on Cell 19?	-->	<i>Handoff Completion</i>	3	P
15	Mobile originating 1xRTT emergency call is set up.	-	-	-	-

Note 1: This could be done by e.g. MMI or AT command.

13.1.18.3.3 Specific message contents

Table 13.1.18.3.3-1: Message *RRCConnectionRequest* (step 2, Table 13.1.18.3.2-2)

Derivation path: 36.508 table 4.6.1-16			
Information Element	Value/Remark	Comment	Condition
<pre> RRCConnectionRequest ::= SEQUENCE { criticalExtensions CHOICE { rrcConnectionRequest-r8 SEQUENCE { establishmentCause } } } </pre>	emergency		

Table 13.1.18.3.3-2: EXTENDED SERVICE REQUEST (Step 5, Table 13.1.18.3.2-2)

Derivation Path: 36.508 Table 4.7.2-14A			
Information Element	Value/remark	Comment	Condition
Protocol discriminator	EMM		
Service type	'0010'B	"mobile originating CS fallback emergency call or 1xCS fallback emergency call"	
CSFB response	Not present		

Table 13.1.18.3.3-3: RRCConnectionReconfiguration (Step 7, Table 13.1.18.3.2-2)

Derivation Path: 36.508, Table 4.6.1-8, condition MEAS			
--	--	--	--

Table 13.1.18.3.3-5: MeasObjectCDMA2000-GENERIC (Step 7, Table 13.1.18.3.2-2)

Derivation Path: 36.508, Table 4.6.6-1C			
Information Element	Value/remark	Comment	Condition
MeasObjectCDMA2000-GENERIC ::= SEQUENCE {			
cdma2000-Type	Type1XRTT		
CarrierFreqCDMA2000 SEQUENCE {			
bandClass	Band Class of frequency under test		
arfcn	f17		
}			
SearchWindowSize	15		
offsetFreq	db0		
cellsToRemoveList	Not present		
cellsToAddModList CHOICE {}	Cell 19		
cellForWhichToReportCGI	Not present		
}			
}			

Table 13.1.18.3.3-6: MeasurementReport (Step 9, Table 13.1.18.3.2-2)

Derivation Path: 36.508, Table 4.6.1-5			
Information Element	Value/remark	Comment	Condition
MeasurementReport ::= SEQUENCE {			
criticalExtensions CHOICE {			
c1 CHOICE{			
measurementReport-r8 SEQUENCE {			
measResults SEQUENCE {			
measId	1		
measResultServCell SEQUENCE {			
rsrpResult	(0..97)		
rsrqResult	(0..34)		
}			
measResultNeighCells CHOICE {			
measResultsCDMA2000 ::=SEQUENCE {			
preRegistrationStatusHRPD	FALSE		
measResultListCDMA2000 ::=SEQUENCE	1 entry		
(SIZE (1..maxCellReport)) OF SEQUENCE {			
physCellId[1]	PhysicalCellIdentity of Cell 19		
cgi-Info[1]	Not present		
measResult[1] SEQUENCE {			
pilotPnPhase	(0..32767)		
pilotStrength	(0..63)		
}			
}			
}			
}			
}			
}			
}			

Table 13.1.18.3.3-7: HandoverFromEUTRAPreparationRequest (Step 10, Table 13.1.18.3.2-2)

Derivation Path: 36.508 Table 4.6.1-4			
Information Element	Value/remark	Comment	Condition
HandoverFromEUTRAPreparationRequest ::= SEQUENCE {			
criticalExtensions CHOICE {			
c1 CHOICE {			
handoverFromEUTRAPreparationRequest-r8 SEQUENCE {			
cdma2000-Type	Type1XRTT		
Rand	Set by SS	Random Challenge Data as broadcast on Cell 19	
mobilityParameters	Set according to 36.508 Table 4.5.2C.4-6	CDMA2000Parameters	
}			
}			
}			
}			

Table 13.1.18.3.3-8: ULHandoverPreparationTransfer (Step 11, Table 13.1.18.3.2-2)

Derivation Path: 36.508 Table 4.6.1-24			
Information Element	Value/remark	Comment	Condition
ULHandoverPreparationTransfer ::= SEQUENCE {			
criticalExtensions CHOICE {			
c1 CHOICE {			
ulHandoverPreparationTransfer-r8 SEQUENCE {			
cdma2000-Type	Type1XRTT		
Meid	UE's meid		
dedicatedInfo	Set according to Table 8.4.7.1.3.3-9	1xRTT GCSNA Encapsulated Origination message	
}			
}			
}			
}			

Table 13.1.18.3.3-9: 1xRTT GCSNA Encapsulated Origination (Step 11, Table 13.1.18.3.2-2)

Information Element	Value/remark	Comment	Condition
MessageID	'0000001'B	GCSNA1xCircuitService message	
GCSNAOption	'0000001'B		
AlternativeGCSNAOption_INCL	'0'B		
IWSIDIncl	'0'B		
AckRequired	'0'B		
StopDupDetect	'0'B		
MessageSequence	Set by UE		
NumTLACEncapsulated1xL3PDU	'00'B		
Reserved	'0000'B		
1xLogicalChannel	'0'B		
1xProtocolRevision	'00000110'B		
MsgType	'00000100'B	Origination message	this value shall be verified by TTCN
NumTLACHeaderRecords	'0001'B		
TLACHeaderRecordType	'0000'B		
TLACHeaderRecordLength	4 bits, Set by UE		
MSID_TYPE	3 bits, Set by UE	Should be matched with PREF_MSID_TYPE	
MSID_LEN	4 bits, Set by UE		
MSID	Variable, Set by UE		
Reserved	'0000000'B		
1xL3PDULength	16 bits, Set by UE		
MOB_TERM	'1'B		
SLOT_CYCLE_INDEX	'010'B		
MOB_P_REV	8 bits, Set by UE		
SCM	8 bits, Set by UE		
REQUEST_MODE	'001'B		
SPECIAL_SERVICE	'1'B		
SERVICE_OPTION	16 bits, any value mapping to a voice service option		
PM	'0'B		
DIGIT_MODE	'0'B		
NUMBER_TYPE	3 bits, Set by UE		
NUMBER_PLAN	4 bits, Set by UE		
MORE_FIELDS	'0'B		
NUM_FIELDS	8 bits, Set by UE		
CHARi	Variable, Set by UE		
NAR_AN_CAP	'0'B		
PACA_REORIG	'0'B		
RETURN_CAUSE	'0000'B		
MORE_RECORDS	'0'B		
ENCRYPTION_SUPPORTED	'0000'B		
PACA_SUPPORTED	'0'B		
NUM_ALT_SO	'000'B		
DRS	'1'B		
UZID_INCL	'0'B		
CH_IND	'01'B		
SR_ID	3 bits, Set by UE		
OTD_SUPPORTED	'1'B		
QPCH_SUPPORTED	'1'B		
ENHANCED_RC	'1'B		
FOR_RC_PREF	'00011'B		
REV_RC_PREF	'00011'B		
FCH_SUPPORTED	'1'B		
FCH Capability Type-specific fields	Variable		
DCCH_SUPPORTED	'1'B		

RESERVED	'0'B		
REV_FCH_GATING_REQ	'0'B		

Table 13.1.18.3.3-10: *MobilityFromEUTRACommand* (Step 12, Table 13.1.18.3.2-2)

Derivation Path: 36.508, Table 4.6.1-6			
Information Element	Value/remark	Comment	Condition
MobilityFromEUTRACommand ::= SEQUENCE {			
criticalExtensions CHOICE {			
c1 CHOICE{			
mobilityFromEUTRACommand-r9 SEQUENCE {			
csFallbackIndicator	False		
purpose CHOICE{			
e-CSFB-r9 SEQUENCE {			
messageContCDMA2000-1XRTT-r9	Set according to Table 8.4.7.6.3.3-11	1xRTT GCSNA Encapsulated Handoff Direction message	
}			
}			
}			
}			
}			

Table 13.1.18.3.3-11: 1xRTT GCSNA Encapsulated Handoff Direction (Step 12, Table 13.1.18.3.2-2)

Information Element	Value/remark	Comment	Condition
MessageID	'0000001'B		
GCSNAOption	'0000001'B		
AlternativeGCSNAOption_INCL	'0'B		
IWSIDIncl	'0'B		
AckRequired	'0'B		
StopDupDetect	'0'B		
MessageSequence	Set by SS		
NumTLACEncapsulated1xL3PDU	'00'B		
Reserved	'0000'B		
1xLogicalChannel	'1'B		
1xProtocolRevision	'0000110'B		
MsgType	'00100010'B	Universal Handoff Direction message	
NumTLACHeaderRecords	'0000'B		
Reserved	'000'B		
1xL3PDULength	16 bits, Set by SS		
USE_TIME	'0'B		
ACTION_TIME	'000000'B		
HDM_SEQ	2 bits, Set by SS		
PARMS_INCL	'1'B		
P_REV	'00000110'B		
SERV_NEG_TYPE	'1'B		
SEARCH_INCLUDED	'1'B		
SRCH_WIN_A	'1000'B		
SRCH_WIN_N	'1001'B		
SRCH_WIN_R	'1011'B		
T_ADD	'010100'B		
T_DROP	'011110'B		
T_COMP	'1010'B		
T_TDROP	'0100'B		
SOFT_SLOPE	'000000'B		
ADD_INTERCEPT	'000000'B		
DROP_INTERCEPT	'000000'B		
EXTRA_PARMS	'1'B		
PACKET_ZONE_ID	'00000000'B		
FRAME_OFFSET	4 bits, Set by SS		
PRIVATE_LCM	'0'B		
RESET_L2	'1'B		
RESET_FPC	'1'B		
ENCRYPT_MODE	'00'B		
NOM_PWR_EXT	'0'B		
NOM_PWR	'0000'B		
RLGAIN_TRAFFIC_PILOT	'000000'B		
DEFAULT_RLAG	'1'B		
NUM_PREAMBLE	'000'B		
BAND_CLASS	5 bits, Set by SS		
CDMA_FREQ	11 bits, Set by SS		
RETURN_IF_HANDOFF_FAIL	'0'B		
PERIODIC_SEARCH	'0'B		
SCR_INCLUDED	'1'B		
NNSCR_INCLUDED	'1'B		
USE_PWR_CNTL_STEP	'0'B		
CLEAR_RETRY_DELAY	'0'B		
SCH_INCL	'1'B		
FPC_SUBCHAN_GAIN	'01010'B		
USE_PC_TIME	'0'B		
CH_IND	'101'B		
ACTIVE_SET_REC_LEN	8 bits, Set by SS		
NUM_PILOTS	'001'B		
SRCH_OFFSET_INCL	'1'B		
PILOT_PN	'000000000'B		
SRCH_OFFSET	'010'B		

ADD_PILOT_REC_INCL	'0'B		
PWR_COMB_IND	'0'B		
CODE_CHAN_FCH	11 bits, Set by SS		
QOF_MASK_ID_FCH	'00'B		
RESERVED	0-7 bits		
REV_FCH_GATING_MODE	'0'B		

Table 13.1.18.3.3-12: 1xRTT Handoff Completion (Step 14, Table 13.1.18.3.2-2)

Information Element	Value/remark	Comment	Condition
MSG_ID	'00001010'		this value shall be verified by TTCN
ACK_SEQ	3 bits, Set by SS		
MSG_SEQ	3 bits, Set by SS		
ACK_REQ	'1'B		
ENCRYPTION	'00'B		
RESERVED	'0'B		
LAST_HDM_SEQ	Same value as HDM_SEQ in 1xRTT Handoff Direction message at Step 9		
PILOT_PN	Same value as PILOT_PN included in 1xRTT Handoff Direction message at Step 9		

13.2 RRC connection reconfiguration

13.2.1 RRC connection reconfiguration / E-UTRA to E-UTRA

13.2.1.1 Test Purpose (TP)

(1)

```
with { UE has a default EPS bearer context }
ensure that {
  when { UE receives downlink data on the radio bearer associated with the default EPS bearer context }
  then { UE delivers the downlink data to upper layers }
}
```

(2)

```
with { UE has a default EPS bearer context }
ensure that {
  when { uplink data are submitted for transmission }
  then { UE transmits the uplink data on the radio bearer associated with the default EPS bearer context }
}
```

(3)

```
with { UE has a default EPS bearer context and successful completion of the intra-frequency handover }
ensure that {
  when { UE receives downlink data on the radio bearer associated with the default EPS bearer context }
  then { UE delivers the downlink data to upper layers }
}
```

(4)

```
with { UE has a default EPS bearer context and successful completion of the intra-frequency handover }
ensure that {
  when { uplink data are submitted for transmission }
}
```

```

    then { UE transmits the uplink data on the radio bearer associated with the default EPS bearer
context }
}

```

13.2.1.2 Conformance requirements

Same Conformance requirements as in clause 8.2.4.2.

References: The conformance requirements covered in the present TC are specified in: TS23.401, clause 5.5.1.1.1.

[TS 23.401, clause 5.5.1.1.1]

These procedures are used to hand over a UE from a source eNodeB to a target eNodeB using the X2 reference point. In these procedures the MME is unchanged. Two procedures are defined depending on whether the Serving GW is unchanged or is relocated. In addition to the X2 reference point between the source and target eNodeB, the procedures rely on the presence of S1-MME reference point between the MME and the source eNodeB as well as between the MME and the target eNodeB.

The handover preparation and execution phases are performed as specified in TS 36.300 [5].

If the serving PLMN changes during handover, the source eNB shall initiate an S1-based handover instead of an X2-based handover.

When the UE receives the handover command it will remove any EPS bearers for which it did not receive the corresponding EPS radio bearers in the target cell. As part of handover execution, downlink packets are forwarded from the source eNodeB to the target eNodeB. When the UE has arrived to the target eNodeB, downlink data forwarded from the source eNodeB can be sent to it. Uplink data from the UE can be delivered via the (source) Serving GW to the PDN GW. Only the handover completion phase is affected by a potential change of the Serving GW, the handover preparation and execution phases are identical.

If the MME receives a rejection to a NAS procedure (e.g. dedicated bearer establishment/modification/release; location reporting control; NAS message transfer; etc.) from the eNodeB with an indication that an X2 handover is in progress (see TS 36.300 [5]), the MME shall reattempt the same NAS procedure either when the handover is complete or the handover is deemed to have failed. The failure is known by expiry of the timer guarding the NAS procedure.

13.2.1.3 Test description

13.2.1.3.1 Pre-test conditions

System Simulator:

- Cell 1 and Cell 2

UE:

None.

Preamble:

- The UE is in state Loopback Activated (state 4) on Cell 1 according to [18] using the UE TEST LOOP MODE B.

13.2.1.3.2 Test procedure sequence

Table 13.2.1.3.2-1 illustrates the downlink power levels and other changing parameters to be applied for the cells at various time instants of the test execution. Row marked "T0" denotes the initial conditions after Preamble, while columns marked "T1" is to be applied subsequently. The exact instants on which these values shall be applied are described in the texts in this clause.

Table 13.2.1.3.2-1: Time instances of cell power level and parameter changes

	Parameter	Unit	Cell 1	Cell 2	Remark
T0	Cell-specific RS EPRE	dBm/15k Hz	-85	-91	The power level value shall be such that measurement results for Cell 1 (M1) and Cell 2 (M2) satisfy exit condition for event A3 ($M2 + Hys < M1$).
T1	Cell-specific RS EPRE	dBm/15k Hz	-91	-85	The power level value shall be such that measurement results for Cell 1 (M1) and Cell 2 (M2) satisfy entry condition for event A3 ($M2 - Hys > M1$).

Table 13.2.1.3.2-2: Main behaviour

St	Procedure	Message Sequence		TP	Verdict
		U - S	Message		
1	The SS transmits one IP packet to the UE on the DRB associated with the default EPS bearer context on Cell 1.	<--	IP packet	-	-
2	Check: Does the UE loop back the IP packet on the DRB associated with the default EPS bearer context on Cell 1?	-	-	1,2	P
3	The SS transmits an <i>RRConnectionReconfiguration</i> message on Cell 1 to setup intra frequency measurement.	<--	<i>RRConnectionReconfiguration</i>	-	-
4	The UE transmits an <i>RRConnectionReconfigurationComplete</i> message on Cell 1.	-->	<i>RRConnectionReconfigurationComplete</i>	-	-
5	The SS changes Cell 1 and Cell 2 parameters according to the row "T1" in table 13.2.1.3.2-1	-	-	-	-
6	The UE transmits a <i>MeasurementReport</i> message on Cell 1 to report event A3 with the measured RSRP and RSRQ value for Cell 2.	-->	<i>MeasurementReport</i>	-	-
7	The SS transmits an <i>RRConnectionReconfiguration</i> message on Cell 1 to order the UE to perform intra frequency handover to Cell 2.	<--	<i>RRConnectionReconfiguration</i>	-	-
8	The UE transmits an <i>RRConnectionReconfigurationComplete</i> message on Cell 2 to confirm the successful completion of the intra frequency handover.	-->	<i>RRConnectionReconfigurationComplete</i>	-	-
9	The SS transmits one IP packet to the UE on the DRB associated with the default EPS bearer context on Cell 2.	<--	IP packet	-	-
10	Check: Does the UE loop back the IP packet on the DRB associated with the default EPS bearer context on Cell 2?	-	-	3,4	P

13.2.1.3.3 Specific message contents

Table 13.2.1.3.3-1: ACTIVATE TEST MODE (preamble)

Derivation Path: 36.508, Table 4.7A-1, condition UE TEST LOOP MODE B
--

Table 13.2.1.3.3-2: *RRConnectionReconfiguration* (Step 3, Table 13.2.1.3.2-2)

Derivation Path: 36.508 clause 4.6.1 table 4.6.1-8 with condition MEAS
--

Table 13.2.1.3.3-3: MeasurementConfiguration (Step 3, Table 13.2.1.3.2-2)

Derivation path: 36.508 clause 4.6.6 table 4.6.6-1			
Information Element	Value/Remark	Comment	Condition
measurementConfiguration ::= SEQUENCE {			
measObjectToAddModifyList SEQUENCE (SIZE (1..maxObjectId)) OF SEQUENCE {	1 entry		
measObjectId[1]	IdMeasObject-f1		
measObject[1]	MeasObjectEUTRA-GENERIC(f1)		
}			
reportConfigToAddModifyList SEQUENCE (SIZE (1..maxReportConfigId)) OF SEQUENCE {	1 entry		
reportConfigId[1]	IdReportConfig-A3		
reportConfig[1]	ReportConfig-A3		
}			
measIdToAddModifyList SEQUENCE (SIZE (1..maxMeasId)) OF SEQUENCE {	1 entry		
measId[1]	1		
measObjectId[1]	IdMeasObject-f1		
reportConfigId[1]	IdReportConfig-A3		
}			

Table 13.2.1.3.3-4: MeasurementReport (Step 6, Table 13.2.1.3.2-2)

Derivation Path: 36.508, Table 4.6.1-5			
Information Element	Value/remark	Comment	Condition
MeasurementReport ::= SEQUENCE {			
criticalExtensions CHOICE {			
c1 CHOICE{			
measurementReport-r8 SEQUENCE {			
measResults SEQUENCE {			
measId	1		
measResultServCell SEQUENCE {			
rsrpResult	(0..97)		
rsrqResult	(0..34)		
}			
measResultNeighCells CHOICE {			
measResultListEUTRA SEQUENCE (SIZE (1..maxCellReport)) OF SEQUENCE {	1 entry		
physCellId[1]	PhysicalCellId of Cell 2		
cgi-Info[1]	Not present		
measResult[1] SEQUENCE {			
rsrpResult	(0..97)		
rsrqResult	(0..34)		
}			
}			
}			
}			
}			
}			
}			

Table 13.2.1.3.3-5: RRCConnectionReconfiguration (Step 7, Table 13.2.1.3.2-2)

Derivation Path: 36.508, Table 4.6.1-8, condition HO
--

Table 13.2.1.3.3-6: *MobilityControlInfo* (step 7, Table 13.2.1.3.2-2)

Derivation Path: 36.508 clause 4.6.5-1			
Information Element	Value/remark	Comment	Condition
MobilityControlInfo ::= SEQUENCE {			
targetPhysCellId	PhysicalCellIdentity of Cell 2		
carrierFreq	Not present		
}			
}			

13.3 Connection re-establishment

13.3.1 Intra-system connection re-establishment

13.3.1.1 Intra-system connection re-establishment / Radio link recovery while T310 is running

13.3.1.1.1 Test Purpose (TP)

(1)

```
with { UE in E-UTRA RRC_CONNECTED state and has data to transmit}
ensure that {
  when { UE detects radio link recovery while T310 is running}
  then { UE resumes the RRC connection without explicit signalling and continues data transfer}
}
```

13.3.1.1.2 Conformance requirements

Refer to TS 36.523-1 clause 8.5.1.5.2.

13.3.1.1.3 Test description

13.3.1.1.3.1 Pre-test conditions

System Simulator:

- Cell 1

UE:

None.

Preamble:

- The condition SRB2-DRB(1,0) is used for step 8 in 4.5.3A.3 according to [18].
- The UE is in state Loopback Activated (state 4) on Cell 1 according to [18] using the UE TEST LOOP MODE B.

13.3.1.1.3.2 Test procedure sequence

Table 13.3.1.1.3.2-1 illustrates the downlink power levels and other changing parameters to be applied for the cells at various time instants of the test execution. Row marked "T0" denotes the initial conditions, while columns marked "T1" is to be applied subsequently. The exact instants on which these values shall be applied are described in the texts in this clause.

Table 13.3.1.1.3.2-1: Time instances of cell power level and parameter changes

	Parameter	Unit	Cell 1	Remark
T0	RS EPRE	dBm/1 5kHz	P _{default}	Power level from 36.508 clause 6.2.2.1. P _{default} as serving cell.
T1	RS EPRE	dBm/1 5kHz	P _{off}	P _{off} as non-suitable "Off" cell.
T2	RS EPRE	dBm/1 5kHz	P _{default}	P _{default} as serving cell.

Table 13.3.1.1.3.2-2: Main behaviour

St	Procedure	Message Sequence		TP	Verdict
		U - S	Message		
1	The SS transmits one IP packet to the UE on the DRB associated with the default EPS bearer context on Cell 1.	<--	IP packet	-	-
2	100 ms after step 1 the SS reduce DL RS TX power level of Cell 1 from "T0" to "T1" in table 13.3.1.1.3.2-1. Note: 100 ms delay after step 1 is to ensure that UE has time to transmit STATUS PDU for data received in step 1	-	-	-	-
3	The SS waits for 1.5s. T310 is 2s.	-	-	-	-
4	The SS recovers DL RS TX power level of Cell 1 from "T1" to "T2" in table 13.3.1.1.3.2-1.	-	-	-	-
5	Check: Does the UE loop back the IP packet on the DRB associated with the default EPS bearer context on Cell 1?(Note 1)	-->	IP packet	1	P

Note 1: Triggered when timer T_delay_modeB (IP PDU delay time) expires and pending uplink data exist in buffered PDCP SDUs according to [25] clause 5.4.4.3.

13.3.1.1.3.3 Specific message contents

Table 13.3.1.1.3.3-1: ACTIVATE TEST MODE (preamble, Table 13.3.1.1.3.2-2)

Derivation Path: 36.508, Table 4.7A-1, condition UE TEST LOOP MODE B
--

Table 13.3.1.1.3.3-2: CLOSE UE TEST LOOP (preamble, Table 13.3.1.1.3.2-2)

Derivation Path: 36.508, Table 4.7A-3, condition UE TEST LOOP MODE B			
Information Element	Value/remark	Comment	Condition
UE test loop mode B LB setup			
IP PDU delay	0 0 0 0 1 0 1	5 seconds	

Table 13.3.1.1.3.3-3: SystemInformationBlockType2 (preamble and all steps, Table 13.3.1.1.3.2-2)

Derivation path: 36.508 table 4.4.3.3-1			
Information Element	Value/Remark	Comment	Condition
SystemInformationBlockType2 ::= SEQUENCE {			
ue-TimersAndConstants {			
t310	ms2000		
}			
}			

Table 13.3.1.1.3.3-4: RRCConnectionReconfiguration (preamble: Table 4.5.3.3-1 [18], step 8)

Derivation path: 36.508 table 4.8.2.1.5-1			
Information Element	Value/Remark	Comment	Condition
RRCConnectionReconfiguration ::= SEQUENCE {			
criticalExtensions CHOICE {			
c1 CHOICE{			
rrcConnectionReconfiguration-r8 SEQUENCE {			
RadioResourceConfigDedicated SEQUENCE {			
mac-MainConfig CHOICE {			
timeAlignmentTimerDedicated	Infinity		
}			
}			
}			
}			
}			

13.3.1.2 Intra-system connection re-establishment / Re-establishment of a new connection when further data is to be transferred

13.3.1.2.1 Test Purpose (TP)

(1)

```
with { UE in E-UTRA RRC_CONNECTED state }
ensure that {
  when { UE detects radio link failure on expiry of timer T310 }
  then { UE starts timer T311 and UE initiates the RRC Connection re-establishment procedure }
}
```

(2)

```
with { UE in E-UTRA RRC_CONNECTED state }
ensure that {
  when { UE detects radio link failure and successfully completes the RRC Connection re-establishment procedure and has data available for transmission }
  then { UE use the DRB configured by network side and resume the data transfer }
}
```

13.3.1.2.2 Conformance requirements

Refer to TS 36.523-1 clause 8.5.1.1.2.

13.3.1.2.3 Test description

13.3.1.2.3.1 Pre-test conditions

System Simulator:

- 2 cells on same E-UTRA frequency:
 - Cell 1 (default parameters) serving cell
 - Cell 2 intra-frequency cell

UE:

None.

Preamble:

- The condition SRB2-DRB(1,0) is used for step 8 in 4.5.3A.3 according to [18].
- The UE is in state Loopback Activated (state 4) on Cell 1 according to [18] using the UE TEST LOOP MODE B.

13.3.1.2.3.2 Test procedure sequence

Table 13.3.1.2.3.2-2: Main behaviour

St	Procedure	Message Sequence		TP	Verdict
		U - S	Message		
0	Void	-	-	-	-
1	The SS transmits one IP packet to the UE on the DRB associated with the default EPS bearer context on Cell 1.	<--	IP packet	-	-
2	100 ms after step 1 the SS changes the power level of cell 1 to non-suitable "Off" and changes the power level of cell 2 to suitable according to TS 36.508 subclause 6.2.2.1 in order that the radio link quality of Cell 1 is degraded. Note: 100 ms delay after step 1 is to ensure that UE has time to transmit STATUS PDU for data received in step 1	-	-	-	-
3	Check: Does the UE initiate an RRC connection re-establishment procedure and transmit an <i>RRCCoNNECTIONReestablishmentRequest</i> message on Cell 2?	-->	<i>RRCCoNNECTIONReestablishmentRequest</i>	1	P
4	The SS transmits <i>RRCCoNNECTIONReestablishment</i> message	<--	<i>RRCCoNNECTIONReestablishment</i>	-	-
5	UE transmits an <i>RRCCoNNECTIONReestablishmentComplete</i> message	-->	<i>RRCCoNNECTIONReestablishmentComplete</i>	-	-
6	The SS transmits <i>RRCCoNNECTIONReconfiguration</i> message	<--	<i>RRCCoNNECTIONReconfiguration</i>	-	-
-	EXCEPTION : the steps 7 and 8 can happen in any order	-	-	-	-
7	UE transmits an <i>RRCCoNNECTIONReconfigurationComplete</i> message	-->	<i>RRCCoNNECTIONReconfigurationComplete</i>	-	-
8	Check: Does the UE loop back the IP packet on the DRB associated with the default EPS bearer context on Cell 2?	-->	IP packet	2	P

13.3.1.2.3.3 Specific message contents

Table 13.3.1.2.3.3-0: ACTIVATE TEST MODE (preamble, Table 13.3.1.2.3.2-2)

Derivation Path: 36.508, Table 4.7A-1, condition UE TEST LOOP MODE B
--

Table 13.3.1.2.3.3-0A: CLOSE UE TEST LOOP (preamble, Table 13.3.1.2.3.2-2)

Derivation Path: 36.508, Table 4.7A-3, condition UE TEST LOOP MODE B			
Information Element	Value/remark	Comment	Condition
UE test loop mode B LB setup			
IP PDU delay	00000101	5 seconds	

Table 13.3.1.2.3.3-1: SchedulingRequest-Configuration (RRCCoNNECTIONReconfiguration, preamble : Table 4.5.3.3-1 [18], step 8)

Derivation Path: 36.508 clause 4.6.3-20			
Information Element	Value/remark	Comment	Condition
SchedulingRequest-Configuration ::= CHOICE { setup SEQUENCE { dsr-TransMax	n64	Max value allowed	
}			
}			

Table 13.3.1.2.3.3-2: RRCConnectionReestablishmentRequest (step 3, Table 13.3.1.2.3.2-2)

Derivation Path: 36.508, Table 4.6.1-13			
Information Element	Value/remark	Comment	Condition
RRCConnectionReestablishmentRequest ::= SEQUENCE {			
criticalExtensions CHOICE {			
rrcConnectionReestablishmentRequest-r8			
SEQUENCE {			
ue-Identity SEQUENCE {			
c-RNTI	the value of the C-RNTI of the UE		
physCellId	PhysicalCellIdentity of Cell 1		
shortMAC-I	The same value as the 16 least significant bits of the XMAC-I value calculated by SS		
}			
reestablishmentCause	otherFailure		
}			
}			

Table 13.3.1.2.3.3-3: RRCConnectionReconfiguration (step 6, Table 13.3.1.2.3.2-2)

Derivation Path: 36.508, Table 4.6.1-8			
Information Element	Value/remark	Comment	Condition
RRCConnectionReconfiguration ::= SEQUENCE {			
criticalExtensions CHOICE {			
c1 CHOICE{			
rrcConnectionReconfiguration-r8 SEQUENCE {			
radioResourceConfigDedicated	RadioResourceConfigDedicated-HO		
}			
}			
}			
}			

13.3.1.3 RRC connection reconfiguration / Full configuration / DRB establishment

13.3.1.3.1 Test Purpose (TP)

(1)

```

with { UE in E-UTRA RRC_CONNECTED state and has data to transmit }
ensure that {
  when { UE detects radio link failure and successfully completed the RRC Connection re-
  establishment procedure and receives an RRCConnectionReconfiguration message including fullConfig-r9
  }
  then { UE release and re-setup DRB and resume data transfer }
}

```

13.3.1.3.2 Conformance requirements

References: The conformance requirements covered in the present TC are specified in: TS 36.331, clauses 5.3.5.3 and 5.3.5.8.

[TS 36.331, clause 5.3.5.3]

If the *RRCConnectionReconfiguration* message does not include the *mobilityControlInfo* and the UE is able to comply with the configuration included in this message, the UE shall:

- 1> if this is the first *RRCConnectionReconfiguration* message after successful completion of the RRC Connection Re-establishment procedure:

- 2> re-establish PDCP for SRB2 and for all DRBs that are established, if any;
- 2> re-establish RLC for SRB2 and for all DRBs that are established, if any;
- 2> if the *RRCCConnectionReconfiguration* message includes the *fullConfig*:
 - 3> perform the radio configuration procedure as specified in section 5.3.5.8;
- 2> if the *RRCCConnectionReconfiguration* message includes the *radioResourceConfigDedicated*:
 - 3> perform the radio resource configuration procedure as specified in 5.3.10;
- 2> resume SRB2 and all DRBs that are suspended, if any;

NOTE 1: The handling of the radio bearers after the successful completion of the PDCP re-establishment, e.g. the re-transmission of unacknowledged PDCP SDUs (as well as the associated status reporting), the handling of the SN and the HFN, is specified in TS 36.323 [8].

1> else:

...

1> submit the *RRCCConnectionReconfigurationComplete* message to lower layers for transmission using the new configuration, upon which the procedure ends;

[TS 36.331, clause 5.3.5.8]

The UE shall:

1> release/ clear all current dedicated radio configurations except the C-RNTI, the security configuration and the PDCP, RLC and logical channel configurations for the RBs;

NOTE 2: Radio configuration is not just the resource configuration but includes other configurations like *MeasConfig* and *OtherConfig*.

1> if the *RRCCConnectionReconfiguration* message includes the *mobilityControlInfo*:

- 2> release/ clear all current common radio configurations;
- 2> use the default values specified in 9.2.5 for timer T310, T311 and constant N310, N311;

1> else:

2> use values for timers T301, T310, T311 and constants N310, N311, as included in *ue-TimersAndConstants* received in *SystemInformationBlockType2*;

1> apply the default physical channel configuration as specified in 9.2.4;

1> apply the default semi-persistent scheduling configuration as specified in 9.2.3;

1> apply the default MAC main configuration as specified in 9.2.2;

1> for each *srb-Identity* value included in the *srb-ToAddModList* (SRB reconfiguration):

- 2> apply the specified configuration defined in 9.1.2 for the corresponding SRB;
- 2> apply the corresponding default RLC configuration for the SRB specified in 9.2.1.1 for SRB1 or in 9.2.1.2 for SRB2;
- 2> apply the corresponding default logical channel configuration for the SRB as specified in 9.2.1.1 for SRB1 or in 9.2.1.2 for SRB2;

NOTE 3: This is to get the SRBs (SRB1 and SRB2 for handover and SRB2 for reconfiguration after reestablishment) to a known state from which the reconfiguration message can do further configuration.

1> for each *eps-BearerIdentity* value included in the *drb-ToAddModList* that is part of the current UE configuration:

- 2> release the PDCP entity;

- 2> release the RLC entity or entities;
- 2> release the DTCH logical channel;
- 2> release the *drb-identity*;

NOTE 4: This will retain the *eps-bearerIdentity* but remove the DRBs including *drb-identity* of these bearers from the current UE configuration and trigger the setup of the DRBs within the AS in Section 5.3.10.3 using the new configuration. The *eps-bearerIdentity* acts as the anchor for associating the released and re-setup DRB.

- 1> for each *eps-BearerIdentity* value that is part of the current UE configuration but not part of the *drb-ToAddModList*:
- 2> perform DRB release as specified in 5.3.10.2;

13.3.1.3.3 Test description

13.3.1.3.3.1 Pre-test conditions

System Simulator:

- Cell 1 and Cell 2.

UE:

None.

Preamble:

- The UE is in state Generic RB Established (state 3) on Cell 1 according to [18].
- The condition SRB2-DRB(1, 0) is used for step 8 in 4.5.3A.3 on Cell 1 according to [18].
- The UE is in state Loopback Activated (state 4) on Cell 1 according to [18] using the UE TEST LOOP MODE B.

13.3.1.3.3.2 Test procedure sequence

Table 13.3.1.3.3.2-1: Time instances of cell power level and parameter changes

	Parameter	Unit	Cell 1	Cell 2
T1	Cell-specific RS EPRE	dBm/15k Hz	"Off"	-85
Power level "Off" is defined in TS36.508 Table 6.2.2.1-1.				

Table 13.3.1.3.3.2-2: Main behaviour

St	Procedure	Message Sequence		TP	Verdict
		U - S	Message		
1	The SS transmits one IP packet to the UE on the DRB associated with the default EPS bearer context on Cell 1.	<--	IP packet	-	-
2	The SS changes Cell 1 and Cell 2 parameters according to the row "T1" in table 13.3.1.3.3.2-1 in order that the radio link quality of Cell 1 is degraded and Cell 2 is suitable for camping.	-	-	-	-
3	The UE send <i>RRCCoNNECTIONReestablishmentRequest</i> message on Cell 2.	-->	<i>RRCCoNNECTIONReestablishmentRequest</i>	-	-
4	The SS transmits <i>RRCCoNNECTIONReestablishment</i> message.	<--	<i>RRCCoNNECTIONReestablishment</i>	-	-
5	The UE transmits <i>RRCCoNNECTIONReestablishmentComplete</i> message.	-->	<i>RRCCoNNECTIONReestablishmentComplete</i>	-	-
6	The SS transmits an <i>RRCCoNNECTIONReconfiguration</i> message to perform full configuration option to Cell 2.	<--	<i>RRCCoNNECTIONReconfiguration</i>	-	-
7	The UE transmit an <i>RRCCoNNECTIONReconfigurationComplete</i> message on Cell 2?	-->	<i>RRCCoNNECTIONReconfigurationComplete</i>	-	-
8	Check: Does the UE loop back the IP packet on the DRB associated with the default EPS bearer context on Cell 2?	-->	IP packet	1	P

13.3.1.3.3.3 Specific message contents

Table 13.3.1.3.3.3-1: ACTIVATE TEST MODE (preamble, Table 13.3.1.3.3.2-2)

Derivation Path: 36.508, Table 4.7A-1, condition UE TEST LOOP MODE B
--

Table 13.3.1.3.3.3-2: CLOSE UE TEST LOOP (preamble, Table 13.3.1.3.3.2-2)

Derivation Path: 36.508, Table 4.7A-3, condition UE TEST LOOP MODE B			
Information Element	Value/remark	Comment	Condition
UE test loop mode B LB setup			
IP PDU delay	00000101	5 seconds	

Table 13.3.1.3.3.3-3: RRCConnectionReestablishmentRequest (step 3, Table 13.3.1.3.3.2-2)

Derivation Path: 36.508, Table 4.6.1-13			
Information Element	Value/remark	Comment	Condition
RRCConnectionReestablishmentRequest ::= SEQUENCE {			
criticalExtensions CHOICE {			
rrcConnectionReestablishmentRequest-r8			
SEQUENCE {			
ue-Identity SEQUENCE {			
c-RNTI	the value of the C-RNTI of the UE		
physCellId	PhysicalCellIdentity of Cell 1		
shortMAC-I	The same value as the 16 least significant bits of the XMAC-I value calculated by SS		
}			
reestablishmentCause	otherFailure		
}			
}			

Table 13.3.1.3.3.3-4: RRCConnectionReconfiguration (step 6, Table 13.3.1.3.3.2-2)

Derivation Path: 36.508, Table 4.6.1-8			
Information Element	Value/remark	Comment	Condition
RRCConnectionReconfiguration ::= SEQUENCE {			
criticalExtensions CHOICE {			
c1 CHOICE{			
rrcConnectionReconfiguration-r8 SEQUENCE {			
radioResourceConfigDedicated	RadioResourceConfigDedicated-RECONFIG		
nonCriticalExtension SEQUENCE {			
lateNonCriticalExtension	Not present		
nonCriticalExtension SEQUENCE {			
otherConfig-r9	Not present		
fullConfig-r9	true		
nonCriticalExtension SEQUENCE {}	Not present		
}			
}			
}			
}			

Table 13.3.1.3.3.3-5: RadioResourceConfigDedicated-RECONFIG (Table 13.3.1.3.3.3-4)

Derivation Path: 36.331 clause 6.3.2			
Information Element	Value/remark	Comment	Condition
RadioResourceConfigDedicated ::= SEQUENCE {			
srb-ToAddModList	SRB-ToAddModList-DEFAULT	TS 36.508 Table 4.8.2.1.1-1	
drb-ToAddModList	DRB-ToAddModList-DEFAULT (1) using condition AM	TS 36.508 Table 4.8.2.1.7-1	
drb-ToReleaseList	Not present		
mac-MainConfig CHOICE {			
explicitValue	MAC-MainConfig-DEFAULT		
}			
sps-Config	Not present		
physicalConfigDedicated	PhysicalConfigDedicated-DEFAULT		SRB1
}			

Table 13.3.1.3.3.3-6: MAC-MainConfig-DEFAULT (Table 13.3.1.3.3.3-5)

Derivation Path: 36.508 table 4.8.2.1.5-1			
Information Element	Value/remark	Comment	Condition
MAC-MainConfig ::= SEQUENCE {			
ul-SCH-Config SEQUENCE {			
periodicBSR-Timer	infinity		
retxBSR-Timer	sf2560		
}			
drx-Config	Not present		
pbr-Config CHOICE {			
release	NULL		
}			
sr-ProhibitTimer-r9	0		
}			

13.3.2 Inter-system connection re-establishment

13.3.2.1 Inter-system connection re-establishment / E-UTRAN to UTRAN / Further data are to be transferred

13.3.2.1.1 Test Purpose (TP)

(1)

```
with { UE in E-UTRA RRC_CONNECTED state }
ensure that {
  when { UE detects radio link failure }
  then { UE successfully selects the available strongest UTRAN cell and further data is transferred
in the target cell}
}
```

13.3.2.1.2 Conformance requirements

References: The conformance requirements covered in the current TC are specified in: TS 36.331 clause 5.3.7.2, TS 36.304, clause 4.1.

[TS 36.331 clause 5.3.7.2]

The UE shall only initiate the procedure when AS security has been activated. The UE initiates the procedure when one of the following conditions is met:

- 1> upon detecting radio link failure, in accordance with 5.3.11; or

- 1> upon handover failure, in accordance with 5.3.5.6; or
- 1> upon mobility from E-UTRA failure, in accordance with 5.4.3.5; or
- 1> upon integrity check failure indication from lower layers; or
- 1> upon an RRC connection reconfiguration failure, in accordance with 5.3.5.5;

Upon initiation of the procedure, the UE shall:

- 1> stop timer T310, if running;
- 1> start timer T311;
- 1> suspend all RBs except SRB0;
- 1> reset MAC;
- 1> apply the default physical channel configuration as specified in 9.2.4;
- 1> apply the default semi-persistent scheduling configuration as specified in 9.2.3;
- 1> apply the default MAC main configuration as specified in 9.2.2;
- 1> perform cell selection in accordance with the cell selection process as specified in TS 36.304 [4];

[TS 36.331, clause 5.3.7.3]

Upon selecting an inter-RAT cell, the UE shall:

- 1> perform the actions upon leaving RRC_CONNECTED as specified in 5.3.12, with release cause 'RRC connection failure';

[TS 36.331, clause 5.3.12]

Upon leaving RRC_CONNECTED, the UE shall:

- 1> reset MAC;
- 1> stop all timers that are running except T320 and T330;
- 1> release all radio resources, including release of the RLC entity, the MAC configuration and the associated PDCP entity for all established RBs;
- 1> indicate the release of the RRC connection to upper layers together with the release cause;
- 1> if leaving RRC_CONNECTED was not triggered by reception of the *MobilityFromEUTRACommand* message:
 - 2> enter RRC_IDLE and perform procedures as specified in TS 36.304 [4, 5.2.7];

[TS 36.304, clause 4.1]

With the cell selection, the UE searches for a suitable cell of the selected PLMN and chooses that cell to provide available services, further the UE shall tune to its control channel. This choosing is known as "camping on the cell".

13.3.2.1.3 Test description

13.3.2.1.3.1 Pre-test conditions

System Simulator:

- 2 cells :
 - Cell 1 (default parameters) E-UTRAN serving cell
 - Cell 5 UTRAN cell
- System information combination 4 as defined in TS 36.508[18] clause 4.4.3.1 is used in E-UTRA cells;

UE:

None.

Preamble:

- The UE is in state Loopback Activated (state 4) on Cell 1 according to [18] using the UE TEST LOOP MODE B with T_delay_modeB timer set according to PIXIT parameter px_TestLoopModeB_Delay.

13.3.2.1.3.2 Test procedure sequence

Table 13.3.2.1.3.2-1: Main behaviour

St	Procedure	Message Sequence		TP	Verdict
		U - S	Message		
1	The SS transmits one IP packet to the UE on the DRB associated with the default EPS bearer context on Cell 1.	<--	IP packet	-	-
2	The SS changes the power level of cell 1 to non-suitable "Off" and changes the power level of cell 5 to suitable according to TS 36.508 subclause 6.2.2.1 in order that the radio link quality of Cell 1 is degraded.	-	-	-	-
3	Check: does the test result in generic test procedure in TS 36.508 subclause 6.4.2.8 indicate that the UE is camped on UTRAN Cell 5? NOTE: The UE performs a RAU procedure and the RRC connection is released.			1	P
4	The UE transmits a RRC CONNECTION REQUEST on Cell 5.	-->	RRC CONNECTION REQUEST	-	-
5	The SS transmits a RRC CONNECTION SETUP on Cell 5.	<--	RRC CONNECTION SETUP	-	-
6	The UE transmits a RRC CONNECTION SETUP COMPLETE message on Cell 5.	-->	RRC CONNECTION SETUP COMPLETE	-	-
7	The UE transmits a SERVICE REQUEST message on Cell 5.	-->	SERVICE REQUEST	-	-
8	void				
9	void				
10	The SS transmits a SECURITY MODE COMMAND message on Cell 5.	<--	SECURITY MODE COMMAND	-	-
11	The UE transmits a SECURITY MODE COMPLETE message on Cell 5.	-->	SECURITY MODE COMPLETE	-	-
12	void				
13	The SS transmits a RADIO BEARER SETUP message on Cell 5.	<--	RADIO BEARER SETUP	-	-
14	The UE transmits a RADIO BEARER SETUP COMPLETE message on Cell 5.	-->	RADIO BEARER SETUP COMPLETE	-	-
15	Void				
16	Void				
17	Check: UE loops back the IP packet on Cell 5?	-->	IP packet	1	P

13.3.2.1.3.3 Specific message contents

Table 13.3.2.1.3.3-1: ACTIVATE TEST MODE -->preamble)

Derivation Path: 36.508, Table 4.7A-3, condition UE TEST LOOP MODE B			
Information Element	Value/remark	Comment	Condition
UE test loop mode B LB setup			
IP PDU delay	Set according to PIXIT parameter px_TestLoopModeB_Delay		

13.3.2.2 Inter-system connection re-establishment / E-UTRAN to GPRS / Further data are to be transferred

13.3.2.2.1 Test Purpose (TP)

(1)

```
with { UE in E-UTRA RRC_CONNECTED state }
ensure that {
  when { UE detects radio link failure }
  then { UE successfully selects the available strongest GERAN cell and further data is transferred
in the target cell}
}
```

13.3.2.2.2 Conformance requirements

References: The conformance requirements covered in the current TC are specified in: TS 36.331 clause 5.3.7.2, TS 36.304, clause 4.1.

[TS 36.331 clause 5.3.7.2]

The UE shall only initiate the procedure when AS security has been activated. The UE initiates the procedure when one of the following conditions is met:

- 1> upon detecting radio link failure, in accordance with 5.3.11; or
- 1> upon handover failure, in accordance with 5.3.5.6; or
- 1> upon mobility from E-UTRA failure, in accordance with 5.4.3.5; or
- 1> upon integrity check failure indication from lower layers; or
- 1> upon an RRC connection reconfiguration failure, in accordance with 5.3.5.5;

Upon initiation of the procedure, the UE shall:

- 1> stop timer T310, if running;
- 1> start timer T311;
- 1> suspend all RBs except SRB0;
- 1> reset MAC;
- 1> apply the default physical channel configuration as specified in 9.2.4;
- 1> apply the default semi-persistent scheduling configuration as specified in 9.2.3;
- 1> apply the default MAC main configuration as specified in 9.2.2;
- 2> perform cell selection in accordance with the cell selection process as specified in TS 36.304 [4];

[TS 36.331, clause 5.3.7.3]

Upon selecting an inter-RAT cell, the UE shall:

- 1> perform the actions upon leaving RRC_CONNECTED as specified in 5.3.12, with release cause 'RRC connection failure';

[TS 36.331, clause 5.3.12]

Upon leaving RRC_CONNECTED, the UE shall:

- 1> reset MAC;
- 1> stop all timers that are running except T320 and T330;

- 1> release all radio resources, including release of the RLC entity, the MAC configuration and the associated PDCP entity for all established RBs;
- 1> indicate the release of the RRC connection to upper layers together with the release cause;
- 1> if leaving RRC_CONNECTED was not triggered by reception of the *MobilityFromEUTRACommand* message:
 - 2> enter RRC_IDLE and perform procedures as specified in TS 36.304 [4, 5.2.7];

[TS 36.304, clause 4.1]

With the cell selection, the UE searches for a suitable cell of the selected PLMN and chooses that cell to provide available services, further the UE shall tune to its control channel. This choosing is known as "camping on the cell".

13.3.2.2.3 Test description

13.3.2.2.3.1 Pre-test conditions

System Simulator:

- 2 cells:
 - Cell 1 (default parameters) E-UTRAN serving cell
 - Cell 24 GERAN cell
- System information combination 5 as defined in TS 36.508[18] clause 4.4.3.1 is used in E-UTRA cells;

UE:

None.

Preamble:

- The UE is in state Loopback Activated (state 4) on Cell 1 according to [18] using the UE TEST LOOP MODE B with T_delay_modeB timer set according to PIXIT parameter px_TestLoopModeB_Delay.

13.3.2.2.3.2 Test procedure sequence

Table 13.3.2.2.3.2-1: Main behaviour

St	Procedure	Message Sequence		TP	Verdict
		U - S	Message		
1	The SS transmits one IP packet to the UE on the DRB associated with the default EPS bearer context on Cell 1.	<--	IP packet	-	-
2	The SS changes the power level of cell 1 to non-suitable "Off" and changes the power level of cell 24 to suitable according to TS 36.508 subclause 6.2.2.1	-	-	-	-
3	Check: does the test result in generic test procedure in TS 36.508 subclause 6.4.2.9 indicate that the UE is camped on GERAN Cell 24?	-	-	1	P
4-14	The UE performs RAU steps 1-11 according to TS36.508 subclause 6.4.2.9				
15	Check: Does the UE loop back the IP packet on Cell 24?	-->	IP packet	1	P

13.3.2.2.3.3 Specific message contents

Table 13.3.2.2.3.3-1: ACTIVATE TEST MODE (preamble)

Derivation Path: 36.508, Table 4.7A-3, condition UE TEST LOOP MODE B			
Information Element	Value/remark	Comment	Condition
UE test loop mode B LB setup			
IP PDU delay	Set according to PIXIT parameter px_TestLoopModeB_Delay		

Table 13.3.2.2.3.3-2: ROUTING AREA UPDATE REQUEST (step 6, Table 13.3.2.2.3.2-1)

Derivation Path: Derivation path: 36.508 table 4.7B.2-1			
Information Element	Value/remark	Comment	Condition
PDP context status	The SM state of the PDP context established on the NSAPI used in the E-UTRA data transfer shall be indicated as not PDP-INACTIVE	The UE indicates that the default bearer context is still active.	

Table 13.3.2.2.3.3-3: ROUTING AREA UPDATE ACCEPT (step 12, Table 13.3.2.2.3.2-1)

Derivation Path: Derivation path: 36.508 table 4.7B.2-2			
Information Element	Value/remark	Comment	Condition
PDP context status	The SM state of the PDP context established on the NSAPI used in the E-UTRA data transfer shall be indicated as not PDP-INACTIVE	The network confirms that the default bearer context is still active.	

13.4 Mobility

13.4.1 Intra-system mobility

13.4.1.1

13.4.1.2 Inter-frequency mobility / E-UTRA to E-UTRA packet

13.4.1.2.1 Test Purpose (TP)

(1)

```
with { UE has a default EPS bearer context }
ensure that {
  when { UE receives downlink data on the radio bearer associated with the default EPS bearer context }
  then { UE delivers the downlink data to upper layers }
}
```

(2)

```
with { UE has a default EPS bearer context }
ensure that {
  when { uplink data are submitted for transmission }
  then { UE transmits the uplink data on the radio bearer associated with the default EPS bearer context }
}
```

(3)

```

with { UE has a default EPS bearer context and successful completion of the inter-frequency handover
}
ensure that {
  when { UE receives downlink data on the radio bearer associated with the default EPS bearer
context }
  then { UE delivers the downlink data to upper layers }
}

```

(4)

```

with { UE has a default EPS bearer context and successful completion of the inter-frequency handover
}
ensure that {
  when { uplink data are submitted for transmission }
  then { UE transmits the uplink data on the radio bearer associated with the default EPS bearer
context }
}

```

13.4.1.2.2 Conformance requirements

References: The conformance requirements covered in the present TC are specified in: TS 23.401, clauses 5.5.1.1.1.

[TS 23.401, clause 5.5.1.1.1]

These procedures are used to hand over a UE from a source eNodeB to a target eNodeB using the X2 reference point. In these procedures the MME is unchanged. Two procedures are defined depending on whether the Serving GW is unchanged or is relocated. In addition to the X2 reference point between the source and target eNodeB, the procedures rely on the presence of S1-MME reference point between the MME and the source eNodeB as well as between the MME and the target eNodeB.

The handover preparation and execution phases are performed as specified in TS 36.300 [5].

If the serving PLMN changes during handover, the source eNB shall initiate an S1-based handover instead of an X2-based handover.

When the UE receives the handover command it will remove any EPS bearers for which it did not receive the corresponding EPS radio bearers in the target cell. As part of handover execution, downlink packets are forwarded from the source eNodeB to the target eNodeB. When the UE has arrived to the target eNodeB, downlink data forwarded from the source eNodeB can be sent to it. Uplink data from the UE can be delivered via the (source) Serving GW to the PDN GW. Only the handover completion phase is affected by a potential change of the Serving GW, the handover preparation and execution phases are identical.

If the MME receives a rejection to a NAS procedure (e.g. dedicated bearer establishment/modification/release; location reporting control; NAS message transfer; etc.) from the eNodeB with an indication that an X2 handover is in progress (see TS 36.300 [5]), the MME shall reattempt the same NAS procedure either when the handover is complete or the handover is deemed to have failed. The failure is known by expiry of the timer guarding the NAS procedure.

13.4.1.2.3 Test description

13.4.1.2.3.1 Pre-test conditions

System Simulator:

- Cell 1 and Cell 3
- System information combination 3 as defined in TS 36.508 [18] clause 4.4.3.1 is used in E-UTRA cells.

UE:

None.

Preamble:

- The UE is in state Loopback Activated (state 4) on Cell 1 according to [18] using the UE TEST LOOP MODE B.

13.4.1.2.3.2 Test procedure sequence

Table 13.4.1.2.3.2-1 illustrates the downlink power levels and other changing parameters to be applied for the cells at various time instants of the test execution. Row marked "T0" denotes the initial conditions after preamble, while columns marked "T1" is to be applied subsequently. The exact instants on which these values shall be applied are described in the texts in this clause.

Table 13.4.1.2.3.2-1: Time instances of cell power level and parameter changes

	Parameter	Unit	Cell 1	Cell 3	Remark
T0	Cell-specific RS EPRE	dBm/15k Hz	-85	-97	The power level values are such that measurement results for Cell 1 (M1) and Cell 3 (M3) satisfy exit condition for event A3 ($M3 < M1$).
T1	Cell-specific RS EPRE	dBm/15k Hz	-85	-73	The power level values are such that measurement results for Cell 1 (M1) and Cell 3 (M3) satisfy entry condition for event A3 ($M3 > M1$).

Table 13.4.1.2.3.2-2: Main behaviour

St	Procedure	Message Sequence		TP	Verdict
		U - S	Message		
1	The SS transmits one IP packet to the UE on the DRB associated with the default EPS bearer context on Cell 1.	<--	IP packet	-	-
2	Check: Does the UE loop back the IP packet on the DRB associated with the default EPS bearer context on Cell 1?	-->	IP packet	1,2	P
3	The SS transmits an <i>RRCCONNECTIONRECONFIGURATION</i> message on Cell 1 to setup inter frequency measurement and reporting for event A3.	<--	<i>RRCCONNECTIONRECONFIGURATION</i>	-	-
4	The UE transmits an <i>RRCCONNECTIONRECONFIGURATIONCOMPLETE</i> message on Cell 1.	-->	<i>RRCCONNECTIONRECONFIGURATIONCOMPLETE</i>	-	-
5	The SS changes Cell 3 parameters according to the row "T1" in table 13.4.1.2.3.2-1	-	-	-	-
6	The UE transmits a <i>MEASUREMENTREPORT</i> message on Cell 1 to report event A3 with the measured RSRP and RSRQ value for Cell 3.	-->	<i>MEASUREMENTREPORT</i>	-	-
7	The SS transmits an <i>RRCCONNECTIONRECONFIGURATION</i> message on Cell 1 to order the UE to perform inter frequency handover to Cell 3.	<--	<i>RRCCONNECTIONRECONFIGURATION</i>	-	-
8	The UE transmit an <i>RRCCONNECTIONRECONFIGURATIONCOMPLETE</i> message on Cell 3 to confirm the successful completion of the inter frequency handover.	-->	<i>RRCCONNECTIONRECONFIGURATIONCOMPLETE</i>	-	-
9	The SS transmits one IP packet to the UE on the DRB associated with the default EPS bearer context on Cell 3.	<--	IP packet	-	-
10	Check: Does the UE loop back the IP packet on the DRB associated with the default EPS bearer context on Cell 3?	-->	IP packet	3,4	P

13.4.1.2.3.3 Specific message contents

Table 13.4.1.2.3.3-1: ACTIVATE TEST MODE (preamble)

Derivation Path: 36.508, Table 4.7A-1, condition UE TEST LOOP MODE B
--

Table 13.4.1.2.3.3-2: RRCConnectionReconfiguration (step 3, Table 13.4.1.2.3.2-2)

Derivation Path: 36.508 clause 4.6.1 table 4.6.1-8 with condition MEAS
--

Table 13.4.1.2.3.3-3: MeasConfig (step 3, Table 13.4.1.2.3.2-2)

Derivation path: 36.508 clause 4.6.6 table 4.6.6-1 with condition INTER-FREQ			
Information Element	Value/Remark	Comment	Condition
MeasConfig ::= SEQUENCE {			
measObjectToAddModifyList SEQUENCE (SIZE (1..maxObjectld)) OF SEQUENCE {	2 entries		
measObjectld[1]	ldMeasObject-f1		
measObject[1]	MeasObjectEUTRA-GENERIC(f1)		
measObjectld[2]	ldMeasObject-f2		
measObject[2]	MeasObjectEUTRA-GENERIC(f2)		
}			
reportConfigToAddModifyList SEQUENCE (SIZE (1..maxReportConfigld)) OF SEQUENCE {	1 entry		
reportConfigld[1]	ldReportConfigEUTRA-A3		
reportConfig[1]	ReportConfigEUTRA-A3		
}			
measldToAddModifyList SEQUENCE (SIZE (1..maxMeasld)) OF SEQUENCE {	1 entry		
measld[1]	1		
measObjectld[1]	ldMeasObject-f2		
reportConfigld[1]	ldReportConfigEUTRA-A3		
}			
}			

Table 13.4.1.2.3.3-4: MeasurementReport (step 6, Table 13.4.1.2.3.2-2)

Derivation Path: 36.508, Table 4.6.1-5			
Information Element	Value/remark	Comment	Condition
MeasurementReport ::= SEQUENCE {			
criticalExtensions CHOICE {			
c1 CHOICE{			
measurementReport-r8 SEQUENCE {			
measResults SEQUENCE {			
measId	1		
measResultServCell SEQUENCE {			
rsrpResult	(0..97)		
rsrqResult	(0..34)		
}			
measResultNeighCells CHOICE {			
measResultListEUTRA SEQUENCE (SIZE (1..maxCellReport)) OF SEQUENCE {	1 entry		
physCellId[1]	PhysicalCellIdentity of Cell 3		
cgi-Info[1]	Not present		
measResult[1] SEQUENCE {			
rsrpResult	(0..97)		
rsrqResult	(0..34)		
}			
}			
}			
}			
}			
}			
}			

Table 13.4.1.2.3.3-5: RRCConnectionReconfiguration (step 7, Table 13.4.1.2.3.2-2)

Derivation Path: 36.508, Table 4.6.1-8, condition HO
--

Table 13.4.1.2.3.3-6: MobilityControlInfo (step 7, Table 13.4.1.2.3.2-2)

Derivation Path: 36.508 clause 4.6.5-1			
Information Element	Value/remark	Comment	Condition
MobilityControlInfo ::= SEQUENCE {			
targetPhysCellId	PhysicalCellIdentity of Cell 3		
carrierFreq SEQUENCE {			
dl-CarrierFreq	Same downlink EARFCN as used for Cell 3		
ul-CarrierFreq	Not present		
}			
}			

13.4.1.3 Intra-system mobility / E-UTRA FDD to E-UTRA TDD to E-UTRA FDD packet

13.4.1.3.1 Test Purpose (TP)

(1)

```

with { UE has a default EPS bearer context }
ensure that {
when { UE receives downlink data on the radio bearer associated with the default EPS bearer context
}
then { UE delivers the downlink data to upper layers }
}

```

(2)

```

with { UE has a default EPS bearer context }
ensure that {
when { uplink data are submitted for transmission }
  then { UE transmits the uplink data on the radio bearer associated with the default EPS bearer
context }
}

```

(3)

```

with { UE has a default EPS bearer context and successful completion of the inter-frequency handover
from E-UTRA FDD to E-UTRA TDD }
ensure that {
when { UE receives downlink data on the radio bearer associated with the default EPS bearer context
}
  then { UE delivers the downlink data to upper layers }
}

```

(4)

```

with { UE has a default EPS bearer context and successful completion of the inter-frequency handover
from E-UTRA FDD to E-UTRA TDD }
ensure that {
when { uplink data are submitted for transmission }
  then { UE transmits the uplink data on the radio bearer associated with the default EPS bearer
context }
}

```

(5)

```

with { UE has a default EPS bearer context and successful completion of the inter-frequency handover
from E-UTRA TDD to E-UTRA FDD }
ensure that {
when { UE receives downlink data on the radio bearer associated with the default EPS bearer context
}
  then { UE delivers the downlink data to upper layers }
}

```

(6)

```

with { UE has a default EPS bearer context and successful completion of the inter-frequency handover
from E-UTRA TDD to E-UTRA FDD }
ensure that {
when { uplink data are submitted for transmission }
  then { UE transmits the uplink data on the radio bearer associated with the default EPS bearer
context }
}

```

13.4.1.3.2 Conformance requirements

References: The conformance requirements covered in the present TC are specified in: TS 23.401, clauses 5.5.1.1.1.

[TS 23.401, clause 5.5.1.1.1]

These procedures are used to hand over a UE from a source eNodeB to a target eNodeB using the X2 reference point. In these procedures the MME is unchanged. Two procedures are defined depending on whether the Serving GW is unchanged or is relocated. In addition to the X2 reference point between the source and target eNodeB, the procedures rely on the presence of S1-MME reference point between the MME and the source eNodeB as well as between the MME and the target eNodeB.

The handover preparation and execution phases are performed as specified in TS 36.300 [5].

If the serving PLMN changes during handover, the source eNB shall initiate an S1-based handover instead of an X2-based handover.

When the UE receives the handover command it will remove any EPS bearers for which it did not receive the corresponding EPS radio bearers in the target cell. As part of handover execution, downlink packets are forwarded from the source eNodeB to the target eNodeB. When the UE has arrived to the target eNodeB, downlink data forwarded from the source eNodeB can be sent to it. Uplink data from the UE can be delivered via the (source) Serving GW to the PDN

GW. Only the handover completion phase is affected by a potential change of the Serving GW, the handover preparation and execution phases are identical.

If the MME receives a rejection to a NAS procedure (e.g. dedicated bearer establishment/modification/release; location reporting control; NAS message transfer; etc.) from the eNodeB with an indication that an X2 handover is in progress (see TS 36.300 [5]), the MME shall reattempt the same NAS procedure either when the handover is complete or the handover is deemed to have failed. The failure is known by expiry of the timer guarding the NAS procedure.

13.4.1.3.3 Test description

13.4.1.3.3.1 Pre-test conditions

System Simulator:

- Cell 1 (E-UTRA FDD Cell)
- Cell 10 (E-UTRA TDD Cell)
- System information combination 3 as defined in TS 36.508 [18] clause 4.4.3.1 is used in E-UTRA cells.

UE:

None.

Preamble:

- The UE is in state Loopback Activated (state 4) on Cell 1 according to [18] using the UE TEST LOOP MODE B.

13.4.1.3.3.2 Test procedure sequence

Table 13.4.1.3.3.2-1 illustrates the downlink power levels and other changing parameters to be applied for the cells at various time instants of the test execution. Row marked "T0" denotes the initial conditions after preamble, while columns marked "T1" and "T2" are to be applied subsequently. The exact instants on which these values shall be applied are described in the texts in this clause.

Table 13.4.1.3.3.2-1: Time instances of cell power level and parameter changes

	Parameter	Unit	Cell 1	Cell 10	Remark
T0	Cell-specific RS EPRE	dBm/15k Hz	-85	-97	The power level values are such that measurement results for Cell 1 (M1) and Cell 10 (M10) satisfy exit condition for event A3 ($M10 < M1$).
T1	Cell-specific RS EPRE	dBm/15k Hz	-85	-73	The power level values are such that measurement results for Cell 1 (M1) and Cell 10 (M10) satisfy entry condition for event A3 ($M10 > M1$).
T2	Cell-specific RS EPRE	dBm/15k Hz	-73	-85	The power level values are such that measurement results for Cell 1 (M1) and Cell 10 (M10) satisfy entry condition for event A3 ($M1 > M10$).

Table 13.4.1.3.3.2-2: Main behaviour

St	Procedure	Message Sequence		TP	Verdict
		U - S	Message		
1	The SS transmits one IP packet to the UE on the DRB associated with the default EPS bearer context on Cell 1.	<--	IP packet	-	-
2	Check: Does the UE loop back the IP packet on the DRB associated with the default EPS bearer context on Cell 1?	-->	IP packet	1,2	P
3	The SS transmits an <i>RRCCoRectionReconfiguration</i> message on Cell 1 to setup inter frequency measurement and reporting for event A3.	<--	<i>RRCCoRectionReconfiguration</i>	-	-
4	The UE transmits an <i>RRCCoRectionReconfigurationComplete</i> message on Cell 1.	-->	<i>RRCCoRectionReconfigurationComplete</i>	-	-
5	The SS changes Cell 10 parameters according to the row "T1" in table 13.4.1.3.3.2-1	-	-	-	-
6	The UE transmits a <i>MeasurementReport</i> message on Cell 1 to report event A3 with the measured RSRP and RSRQ value for Cell 10.	-->	<i>MeasurementReport</i>	-	-
7	The SS transmits an <i>RRCCoRectionReconfiguration</i> message on Cell 1 to order the UE to perform inter frequency handover to Cell 10 and to activate the measurement gaps..	<--	<i>RRCCoRectionReconfiguration</i>	-	-
8	The UE transmit an <i>RRCCoRectionReconfigurationComplete</i> message on Cell 10 to confirm the successful completion of the inter frequency handover.	-->	<i>RRCCoRectionReconfigurationComplete</i>	-	-
9	The SS transmits one IP packet to the UE on the DRB associated with the default EPS bearer context on Cell 10.	<--	IP packet	-	-
10	Check: Does the UE loop back the IP packet on the DRB associated with the default EPS bearer context on Cell 10?	-->	IP packet	3,4	P
11	The SS changes Cell 10 parameters according to the row "T2" in table 13.4.1.3.3.2-1	-	-	-	-
12	The UE transmits a <i>MeasurementReport</i> message on Cell 10 to report event A3 with the measured RSRP and RSRQ value for Cell 1.	-->	<i>MeasurementReport</i>	-	-
13	The SS transmits an <i>RRCCoRectionReconfiguration</i> message on Cell 10 to order the UE to perform inter frequency handover to Cell 1.	<--	<i>RRCCoRectionReconfiguration</i>	-	-
14	The UE transmit an <i>RRCCoRectionReconfigurationComplete</i> message on Cell 1 to confirm the successful completion of the inter frequency handover.	-->	<i>RRCCoRectionReconfigurationComplete</i>	-	-
15	The SS transmits one IP packet to the UE on the DRB associated with the default EPS bearer context on Cell 1.	<--	IP packet	-	-
16	Check: Does the UE loop back the IP packet on the DRB associated with the default EPS bearer context on Cell 1?	-->	IP packet	5,6	P

13.4.1.3.3.3

Specific message contents

Table 13.4.1.3.3.3-1: ACTIVATE TEST MODE (preamble)

Derivation Path: 36.508, Table 4.7A-1, condition UE TEST LOOP MODE B
--

Table 13.4.1.3.3.3-2: RRCConnectionReconfiguration (step 3, Table 13.4.1.3.3.2-2)

Derivation Path: 36.508 clause 4.6.1 table 4.6.1-8 with condition MEAS

Table 13.4.1.3.3.3-3: MeasConfig (step 3, Table 13.4.1.3.3.2-2)

Derivation path: 36.508 clause 4.6.6 table 4.6.6-1 with condition INTER-FREQ			
Information Element	Value/Remark	Comment	Condition
MeasConfig ::= SEQUENCE {			
measObjectToAddModList SEQUENCE (SIZE (1..maxObjectId)) OF SEQUENCE {	2 entries		
measObjectId[1]	IdMeasObject-f5		
measObject[1]	MeasObjectEUTRA-GENERIC(f5)		
measObjectId[2]	IdMeasObject-f1		
measObject[2]	MeasObjectEUTRA-GENERIC(f1)		
}			
reportConfigToAddModList SEQUENCE (SIZE (1..maxReportConfigId)) OF SEQUENCE {	1 entry		
reportConfigId[1]	IdReportConfigEUTRA-A3		
reportConfig[1]	ReportConfigEUTRA-A3		
}			
measIdToAddModList SEQUENCE (SIZE (1..maxMeasId)) OF SEQUENCE {	1 entry		
measId[1]	1		
measObjectId[1]	IdMeasObject-f5		
reportConfigId[1]	IdReportConfigEUTRA-A3		
}			
}			

Table 13.4.1.3.3.3-4: MeasurementReport (step 6, Table 13.4.1.3.3.2-2)

Derivation Path: 36.508, Table 4.6.1-5			
Information Element	Value/remark	Comment	Condition
MeasurementReport ::= SEQUENCE {			
criticalExtensions CHOICE {			
c1 CHOICE{			
measurementReport-r8 SEQUENCE {			
measResults SEQUENCE {			
measId	1		
measResultServCell SEQUENCE {			
rsrpResult	(0..97)		
rsrqResult	(0..34)		
}			
measResultNeighCells CHOICE {			
measResultListEUTRA SEQUENCE (SIZE (1..maxCellReport)) OF SEQUENCE {	1 entry		
physCellId[1]	PhysicalCellIdentity of Cell 10		
cgi-Info[1]	Not present		
measResult[1] SEQUENCE {			
rsrpResult	(0..97)		
rsrqResult	(0..34)		
}			
}			
}			
}			
}			
}			
}			

Table 13.4.1.3.3.3-5: RRCConnectionReconfiguration (step 7, Table 13.4.1.3.3.2-2)

Derivation Path: 36.508 clause 4.6.1-8			
Information Element	Value/remark	Comment	Condition
RRCConnectionReconfiguration ::= SEQUENCE {			
criticalExtensions CHOICE {			
c1 CHOICE{			
rrcConnectionReconfiguration-r8 SEQUENCE {			
measConfig	MeasConfig		
mobilityControlInfo	MobilityControlInfo		
}			
}			
}			
}			

Table 13.4.1.3.3.3-6: MeasConfig (step 7, Table 13.4.1.3.3.2-2)

Derivation path: 36.508 clause 4.6.6 table 4.6.6-1, condition INTER-FREQ
--

Table 13.4.1.3.3.3-7: *MobilityControlInfo* (step 7, Table 13.4.1.3.3.2-2)

Derivation Path: 36.508 clause 4.6.5-1			
Information Element	Value/remark	Comment	Condition
MobilityControlInfo ::= SEQUENCE {			
targetPhysCellId	PhysicalCellIdentity of Cell 10		
carrierFreq SEQUENCE {			
dl-CarrierFreq	Same downlink EARFCN as used for Cell 10		
ul-CarrierFreq	Not present		
}			
}			

Table 13.4.1.3.3.3-8: *MeasurementReport* (step 12, Table 13.4.1.3.3.2-2)

Derivation Path: 36.508, Table 4.6.1-5			
Information Element	Value/remark	Comment	Condition
MeasurementReport ::= SEQUENCE {			
criticalExtensions CHOICE {			
c1 CHOICE{			
measurementReport-r8 SEQUENCE {			
measResults SEQUENCE {			
measId	1		
measResultServCell SEQUENCE {			
rsrpResult	(0..97)		
rsrqResult	(0..34)		
}			
measResultNeighCells CHOICE {			
measResultListEUTRA SEQUENCE (SIZE (1..maxCellReport)) OF SEQUENCE {	1 entry		
physCellId[1]	PhysicalCellIdentity of Cell 1		
cgi-Info[1]	Not present		
measResult[1] SEQUENCE {			
rsrpResult	(0..97)		
rsrqResult	(0..34)		
}			
}			
}			
}			
}			
}			
}			
}			
}			

Table 13.4.1.3.3.3-9: *RRCConnectionReconfiguration* (step 13, Table 13.4.1.3.3.2-2)

Derivation Path: 36.508, Table 4.6.1-8, condition HO
--

Table 13.4.1.3.3-10: *MobilityControlInfo* (step 13, Table 13.4.1.3.3.2-2)

Derivation Path: 36.508 clause 4.6.5-1			
Information Element	Value/remark	Comment	Condition
MobilityControlInfo ::= SEQUENCE {			
targetPhysCellId	PhysicalCellId of Cell 1		
carrierFreq SEQUENCE {			
dl-CarrierFreq	Same downlink EARFCN as used for Cell 1		
ul-CarrierFreq	Same uplink EARFCN as used for Cell 1		
}			
}			

13.4.1.4 Inter-band mobility / E-UTRA to E-UTRA packet

13.4.1.4.1 Test Purpose (TP)

(1)

```
with { UE has a default EPS bearer context }
ensure that {
  when { UE receives downlink data on the radio bearer associated with the default EPS bearer context }
  then { UE delivers the downlink data to upper layers }
}
```

(2)

```
with { UE has a default EPS bearer context }
ensure that {
  when { uplink data are submitted for transmission }
  then { UE transmits the uplink data on the radio bearer associated with the default EPS bearer context }
}
```

(3)

```
with { UE has a default EPS bearer context and successful completion of the inter-band handover }
ensure that {
  when { UE receives downlink data on the radio bearer associated with the default EPS bearer context }
  then { UE delivers the downlink data to upper layers }
}
```

(4)

```
with { UE has a default EPS bearer context and successful completion of the inter-band handover }
ensure that {
  when { uplink data are submitted for transmission }
  then { UE transmits the uplink data on the radio bearer associated with the default EPS bearer context }
}
```

13.4.1.4.2 Conformance requirements

References: The conformance requirements covered in the present TC are specified in: TS 23.401, clause 5.5.1.1.1.

[TS 23.401, clause 5.5.1.1.1]

These procedures are used to hand over a UE from a source eNodeB to a target eNodeB using the X2 reference point. In these procedures the MME is unchanged. Two procedures are defined depending on whether the Serving GW is unchanged or is relocated. In addition to the X2 reference point between the source and target eNodeB, the procedures rely on the presence of S1-MME reference point between the MME and the source eNodeB as well as between the MME and the target eNodeB.

The handover preparation and execution phases are performed as specified in TS 36.300 [5]. If emergency bearer services are ongoing for the UE handover to the target eNodeB is performed independent of the Handover Restriction List. The MME checks, as part of the Tracking Area Update in the execution phase, if the handover is to a restricted area and if so MME releases the non-emergency bearers as specified in clause 5.10.3.

If the serving PLMN changes during X2-based handover, the source eNodeB shall indicate to the target eNodeB (in the Handover Restriction List) the PLMN selected to be the new Serving PLMN.

When the UE receives the handover command it will remove any EPS bearers for which it did not receive the corresponding EPS radio bearers in the target cell. As part of handover execution, downlink and optionally also uplink packets are forwarded from the source eNodeB to the target eNodeB. When the UE has arrived to the target eNodeB, downlink data forwarded from the source eNodeB can be sent to it. Uplink data from the UE can be delivered via the (source) Serving GW to the PDN GW or optionally forwarded from the source eNodeB to the target eNodeB. Only the handover completion phase is affected by a potential change of the Serving GW, the handover preparation and execution phases are identical.

If the MME receives a rejection to a NAS procedure (e.g. dedicated bearer establishment/modification/release; location reporting control; NAS message transfer; etc.) from the eNodeB with an indication that an X2 handover is in progress (see TS 36.300 [5]), the MME shall reattempt the same NAS procedure either when the handover is complete or the handover is deemed to have failed, except in the case of Serving GW relocation. The failure is known by expiry of the timer guarding the NAS procedure.

13.4.1.4.3 Test description

13.4.1.4.3.1 Pre-test conditions

System Simulator:

- Cell 1 and Cell 10.
- System information combination 3 as defined in TS 36.508 [18] clause 4.4.3.1 is used in E-UTRA cells.

UE:

None.

Preamble:

- The UE is in state Loopback Activated (state 4) on Cell 1 according to [18] using the UE TEST LOOP MODE B.

13.4.1.4.3.2 Test procedure sequence

Table 13.4.1.4.3.2-1 illustrates the downlink power levels and other changing parameters to be applied for the cells at various time instants of the test execution. Row marked "T0" denotes the initial conditions after preamble, while columns marked "T1" is to be applied subsequently. The exact instants on which these values shall be applied are described in the texts in this clause.

Table 13.4.1.4.3.2-1: Time instances of cell power level and parameter changes

	Parameter	Unit	Cell 1	Cell 10	Remark
T0	Cell-specific RS EPRE	dBm/15 kHz	-85	-97	The power level values are such that measurement results for Cell 1 (M1) and Cell 10 (M10) satisfy exit condition for event A3 ($M10 < M1$).
T1	Cell-specific RS EPRE	dBm/15 kHz	-85	-73	The power level values are such that measurement results for Cell 1 (M1) and Cell 10 (M10) satisfy entry condition for event A3 ($M10 > M1$).

Table 13.4.1.4.3.2-2: Main behaviour

St	Procedure	Message Sequence		TP	Verdict
		U - S	Message		
1	The SS transmits one IP packet to the UE on the DRB associated with the default EPS bearer context on Cell 1.	<--	IP packet	-	-
2	Check: Does the UE loop back the IP packet on the DRB associated with the default EPS bearer context on Cell 1?	-->	IP packet	1,2	P
3	The SS transmits an <i>RRCCONNECTIONRECONFIGURATION</i> message on Cell 1 to setup inter-band measurement and reporting for event A3.	<--	<i>RRCCONNECTIONRECONFIGURATION</i>	-	-
4	The UE transmits an <i>RRCCONNECTIONRECONFIGURATIONCOMPLETE</i> message on Cell 1.	-->	<i>RRCCONNECTIONRECONFIGURATIONCOMPLETE</i>	-	-
5	The SS changes Cell 10 parameter according to the row "T1" in table 13.4.1.4.3.2-1	-	-	-	-
6	The UE transmits a <i>MEASUREMENTREPORT</i> message on Cell 1 to report event A3 with the measured RSRP and RSRQ value for Cell 10.	-->	<i>MEASUREMENTREPORT</i>	-	-
7	The SS transmits an <i>RRCCONNECTIONRECONFIGURATION</i> message on Cell 1 to order the UE to perform inter-band handover to Cell 10.	<--	<i>RRCCONNECTIONRECONFIGURATION</i>	-	-
8	The UE transmit an <i>RRCCONNECTIONRECONFIGURATIONCOMPLETE</i> message on Cell 10 to confirm the successful completion of the inter-band handover.	-->	<i>RRCCONNECTIONRECONFIGURATIONCOMPLETE</i>	-	-
9	The SS transmits one IP packet to the UE on the DRB associated with the default EPS bearer context on Cell 10.	<--	IP packet	-	-
10	Check: Does the UE loop back the IP packet on the DRB associated with the default EPS bearer context on Cell 10?	-->	IP packet	3,4	P

13.4.1.4.3.3 Specific message contents

Table 13.4.1.4.3.3-1: *RRCCONNECTIONRECONFIGURATION* (step 3, Table 13.4.1.4.3.2-2)

Derivation Path: 36.508, Table 4.6.1-8, condition MEAS
--

Table 13.4.1.4.3.3-2: *MeasConfig* (Table 13.4.1.4.3.3-1)

Derivation Path: 36.508, Table 4.6.6-1, condition INTER-FREQ			
Information Element	Value/remark	Comment	Condition
MeasConfig ::= SEQUENCE {			
measObjectToAddModList SEQUENCE (SIZE (1..maxObjectId)) OF SEQUENCE {	2 entries		
measObjectId[1]	IdMeasObject-f1		
measObject[1]	MeasObjectEUTRA-GENERIC(f1)		
measObjectId[2]	IdMeasObject-f5		
measObject[2]	MeasObjectEUTRA-GENERIC(f5)		
}			
reportConfigToAddModList SEQUENCE (SIZE (1..maxReportConfigId)) OF SEQUENCE {	1 entry		
reportConfigId[1]	IdReportConfig-A3		
reportConfig[1]	ReportConfigEUTRA-A3		
}			
measIdToAddModList SEQUENCE (SIZE (1..maxMeasId)) OF SEQUENCE {	1 entry		
measId[1]	1		
measObjectId[1]	IdMeasObject-f5		
reportConfigId[1]	IdReportConfig-A3		
}			
}			

Table 13.4.1.4.3.3-3: *MeasurementReport* (step 6, Table 13.4.1.4.3.2-2)

Derivation Path: 36.508, Table 4.6.1-5			
Information Element	Value/remark	Comment	Condition
MeasurementReport ::= SEQUENCE {			
criticalExtensions CHOICE {			
c1 CHOICE{			
measurementReport-r8 SEQUENCE {			
measResults SEQUENCE {			
measId	1		
measResultServCell SEQUENCE {			
rsrpResult	(0..97)		
rsrqResult	(0..34)		
}			
measResultNeighCells CHOICE {			
measResultListEUTRA SEQUENCE (SIZE (1..maxCellReport)) OF SEQUENCE {	1 entry		
physCellId	PhysicalCellIdentity of Cell 10		
cgi-Info	Not present		
measResult SEQUENCE {			
rsrpResult	(0..97)		
rsrqResult	(0..34)		
additionalSI-Info-r9	Not present		
}			
}			
}			
measResultForECID-r9	Not present		
}			
}			
}			

Table 13.4.1.4.3.3-4: RRCConnectionReconfiguration (step 7, Table 13.4.1.4.3.2-2)

Derivation Path: 36.508, Table 4.6.1-8, condition HO
--

Table 13.4.1.4.3.3-5: MobilityControlInfo (Table 13.4.1.4.3.3-4)

Derivation Path: 36.508, Table 4.6.5-1			
Information Element	Value/remark	Comment	Condition
MobilityControlInfo ::= SEQUENCE {			
targetPhysCellId	PhysicalCellId of Cell 10		
carrierFreq SEQUENCE {			
dl-CarrierFreq	Same downlink EARFCN as used for Cell 10		
ul-CarrierFreq	Not present		
}			
}			

13.4.1.5 RRC connection reconfiguration / Handover/ Full configuration / DRB establishment

13.4.1.5.1 Test Purpose (TP)

(1)

```

with { UE in E-UTRA RRC_CONNECTED state and has data transmit }
ensure that {
  when { UE receives an RRCConnectionReconfiguration message including mobilityControlInfo and
fullConfig-r9 }
    then { UE release and re-setup DRB and resume data transfer }
}

```

13.4.1.5.2 Conformance requirements

References: The conformance requirements covered in the present TC are specified in: TS 36.331, clauses 5.3.5.4 and 5.3.5.8.

[TS 36.331, clause 5.3.5.4]

If the *RRCConnectionReconfiguration* message includes the *mobilityControlInfo* and the UE is able to comply with the configuration included in this message, the UE shall:

- 1> stop timer T310, if running;
- 1> start timer T304 with the timer value set to *t304*, as included in the *mobilityControlInfo*;
- ...
- 1> else:
 - 2> consider the target cell to be one on the current frequency with a physical cell identity indicated by the *targetPhysCellId*;
- 1> start synchronising to the DL of the target cell;

NOTE 1: The UE should perform the handover as soon as possible following the reception of the RRC message triggering the handover, which could be before confirming successful reception (HARQ and ARQ) of this message.

- 1> reset MAC;
- 1> re-establish PDCP for all RBs that are established;

NOTE 2: The handling of the radio bearers after the successful completion of the PDCP re-establishment, e.g. the re-transmission of unacknowledged PDCP SDUs (as well as the associated status reporting), the handling of the SN and the HFN, is specified in TS 36.323 [8].

- 1> re-establish RLC for all RBs that are established;
 - 1> apply the value of the *newUE-Identity* as the C-RNTI;
 - 1> if the *RRCCONNECTIONRECONFIGURATION* message includes the *fullConfig*:
 - 2> perform the radio configuration procedure as specified in section 5.3.5.8;
 - 1> configure lower layers in accordance with the received *radioResourceConfigCommon*;
 - 1> configure lower layers in accordance with any additional fields, not covered in the previous, if included in the received *mobilityControlInfo*;
 - 1> if the *RRCCONNECTIONRECONFIGURATION* message includes the *radioResourceConfigDedicated*:
 - 2> perform the radio resource configuration procedure as specified in 5.3.10;
 - ...
 - 1> else:
 - 2> update the K_{eNB} key based on the current K_{eNB} or the NH, using the *nextHopChainingCount* value indicated in the *securityConfigHO*, as specified in TS 33.401 [32];
 - 1> store the *nextHopChainingCount* value;
 - 1> if the *securityAlgorithmConfig* is included in the *securityConfigHO*:
 - 2> derive the K_{RRcint} key associated with the *integrityProtAlgorithm*, as specified in TS 33.401 [32];
 - 2> derive the K_{RRcenc} key and the K_{UPenc} key associated with the *cipheringAlgorithm*, as specified in TS 33.401 [32];
 - ...
 - 1> configure lower layers to apply the integrity protection algorithm and the K_{RRcint} key, i.e. the integrity protection configuration shall be applied to all subsequent messages received and sent by the UE, including the message used to indicate the successful completion of the procedure;
 - 1> configure lower layers to apply the ciphering algorithm, the K_{RRcenc} key and the K_{UPenc} key, i.e. the ciphering configuration shall be applied to all subsequent messages received and sent by the UE, including the message used to indicate the successful completion of the procedure;
 - 1> perform the measurement related actions as specified in 5.5.6.1;
 - ...
 - 1> submit the *RRCCONNECTIONRECONFIGURATIONCOMPLETE* message to lower layers for transmission;
 - 1> if MAC successfully completes the random access procedure:
 - 2> stop timer T304;
 - 2> apply the parts of the CQI reporting configuration, the scheduling request configuration and the sounding RS configuration that do not require the UE to know the SFN of the target cell, if any;
 - 2> apply the parts of the measurement and the radio resource configuration that require the UE to know the SFN of the target cell (e.g. measurement gaps, periodic CQI reporting, scheduling request configuration, sounding RS configuration), if any, upon acquiring the SFN of the target cell;
- NOTE 3: Whenever the UE shall setup or reconfigure a configuration in accordance with a field that is received it applies the new configuration, except for the cases addressed by the above statements.
- 2> the procedure ends;

NOTE 4: The UE is not required to determine the SFN of the target cell by acquiring system information from that cell before performing RACH access in the target cell.

[TS 36.331, clause 5.3.5.8]

The UE shall:

- 1> release/ clear all current dedicated radio configurations except the C-RNTI, the security configuration and the PDCP, RLC and logical channel configurations for the RBs;

NOTE 1: Radio configuration is not just the resource configuration but includes other configurations like *MeasConfig* and *OtherConfig*.

- 1> if the *RRCConnectionReconfiguration* message includes the *mobilityControlInfo*:

- 2> release/ clear all current common radio configurations;
- 2> use the default values specified in 9.2.5 for timer T310, T311 and constant N310, N311;

- 1> else:

- 2> use values for timers T301, T310, T311 and constants N310, N311, as included in *ue-TimersAndConstants* received in *SystemInformationBlockType2*;

- 1> apply the default physical channel configuration as specified in 9.2.4;

- 1> apply the default semi-persistent scheduling configuration as specified in 9.2.3;

- 1> apply the default MAC main configuration as specified in 9.2.2;

- 1> for each *srb-Identity* value included in the *srb-ToAddModList* (SRB reconfiguration):

- 2> apply the specified configuration defined in 9.1.2 for the corresponding SRB;
- 2> apply the corresponding default RLC configuration for the SRB specified in 9.2.1.1 for SRB1 or in 9.2.1.2 for SRB2;
- 2> apply the corresponding default logical channel configuration for the SRB as specified in 9.2.1.1 for SRB1 or in 9.2.1.2 for SRB2;

NOTE 2: This is to get the SRBs (SRB1 and SRB2 for handover and SRB2 for reconfiguration after reestablishment) to a known state from which the reconfiguration message can do further configuration.

- 1> for each *eps-BearerIdentity* value included in the *drb-ToAddModList* that is part of the current UE configuration:

- 2> release the PDCP entity;
- 2> release the RLC entity or entities;
- 2> release the DTCH logical channel;
- 2> release the *drb-identity*;

NOTE 3: This will retain the *eps-bearerIdentity* but remove the DRBs including *drb-identity* of these bearers from the current UE configuration and trigger the setup of the DRBs within the AS in Section 5.3.10.3 using the new configuration. The *eps-bearerIdentity* acts as the anchor for associating the released and re-setup DRB.

- 1> for each *eps-BearerIdentity* value that is part of the current UE configuration but not part of the *drb-ToAddModList*:

- 2> perform DRB release as specified in 5.3.10.2;

13.4.1.5.3 Test description

13.4.1.5.3.1 Pre-test conditions

System Simulator:

- Cell 1 and Cell 2.

UE:

None.

Preamble:

- The UE is in state Generic RB Established (state 3) on Cell 1 according to [18].
- The condition SRB2-DRB(1, 0) is used for step 8 in 4.5.3A.3 on Cell 1 according to [18].
- The UE is in state Loopback Activated (state 4) on Cell 1 according to [18] using the UE TEST LOOP MODE B.

13.4.1.5.3.2 Test procedure sequence

Table 13.4.1.5.3.2-1: Main behaviour

St	Procedure	Message Sequence		TP	Verdict
		U - S	Message		
1	The SS transmits one IP packet to the UE on the DRB associated with the default EPS bearer context on Cell 1.	<--	IP packet	-	-
2	The SS transmits an <i>RRCCONNECTIONRECONFIGURATION</i> message on Cell 1 to order the UE to perform handover with full configuration option to Cell 2.	<--	<i>RRCCONNECTIONRECONFIGURATION</i>	-	-
3	The UE transmit an <i>RRCCONNECTIONRECONFIGURATIONCOMPLETE</i> message on Cell 2.	-->	<i>RRCCONNECTIONRECONFIGURATIONCOMPLETE</i>	-	-
4	Check: Does the UE loop back the IP packet on the DRB associated with the default EPS bearer context on Cell 2?	-->	IP packet	1	P

13.4.1.5.3.3 Specific message contents

Table 13.4.1.5.3.3-1: ACTIVATE TEST MODE (preamble, Table 13.4.1.5.3.2-1)

Derivation Path: 36.508, Table 4.7A-1, condition UE TEST LOOP MODE B

Table 13.4.1.5.3.3-2: CLOSE UE TEST LOOP (preamble, Table 13.4.1.5.3.2-1)

Derivation Path: 36.508, Table 4.7A-3, condition UE TEST LOOP MODE B

Information Element	Value/remark	Comment	Condition
UE test loop mode B LB setup			
IP PDU delay	00000101	5 seconds	

Table 13.4.1.5.3.3-3: RRCConnectionReconfiguration (step 2, Table 13.4.1.5.3.2-1)

Derivation Path: 36.508, Table 4.6.1-8, condition HO			
Information Element	Value/remark	Comment	Condition
RRCConnectionReconfiguration ::= SEQUENCE {			
criticalExtensions CHOICE {			
c1 CHOICE {			
rrcConnectionReconfiguration-r8 SEQUENCE {			
radioResourceConfigDedicated	RadioResourceConfigDe dedicated-RECONFIG		
nonCriticalExtension SEQUENCE {			
lateNonCriticalExtension	Not present		
nonCriticalExtension SEQUENCE {			
otherConfig-r9	Not present		
fullConfig-r9	true		
nonCriticalExtension SEQUENCE {}	Not present		
}			
}			
}			
}			
}			

Table 13.4.1.5.3.3-4: MobilityControlInfo (Table 13.4.1.5.3.3-3)

Derivation Path: 36.508, Table 4.6.5-1			
Information Element	Value/remark	Comment	Condition
MobilityControlInfo ::= SEQUENCE {			
targetPhysCellId	PhysicalCellIdentity of Cell 2		
carrierFreq SEQUENCE {			
dl-CarrierFreq	Same downlink EARFCN as used for Cell 2		
ul-CarrierFreq	Not present		
}			
radioResourceConfigCommon	RadioResourceConfigCo mmon-DEFAULT		
}			

Table 13.4.1.5.3.3-5: RadioResourceConfigCommon-DEFAULT (Table 13.4.1.5.3.3-4)

Derivation Path: 36.508 table 4.6.3-13 with condition FullConfig

Table 13.4.1.5.3.3-6: SecurityConfigHO (Table 13.4.1.5.3.3-3)

Derivation Path: 36.508, Table 4.6.4-1			
Information Element	Value/remark	Comment	Condition
SecurityConfigHO ::= SEQUENCE {			
handoverType CHOICE {			
intraLTE SEQUENCE {			
securityAlgorithmConfig	SecurityConfigSMC- DEFAULT	TS 36.508, Table 4.6.4-2	
}			
}			
}			

Table 13.4.1.5.3.3-7: RadioResourceConfigDedicated-RECONFIG (Table 13.4.1.5.3.3-3)

Derivation Path: 36.331 clause 6.3.2			
Information Element	Value/remark	Comment	Condition
RadioResourceConfigDedicated ::= SEQUENCE {			
srb-ToAddModList	SRB-ToAddModList-DEFAULT	TS 36.508 Table 4.8.2.1.1-1	
drb-ToAddModList	DRB-ToAddModList-DEFAULT (1) using condition AM	TS 36.508 Table 4.8.2.1.7-1	
drb-ToReleaseList	Not present		
mac-MainConfig CHOICE {			
explicitValue	MAC-MainConfig-DEFAULT		
}			
sps-Config	Not present		
physicalConfigDedicated	Not present		
}			

Table 13.4.1.5.3.3-8: MAC-MainConfig-DEFAULT (Table 13.4.1.5.3.3-6)

Derivation Path: 36.508 table 4.8.2.1.5-1			
Information Element	Value/remark	Comment	Condition
MAC-MainConfig ::= SEQUENCE {			
ul-SCH-Config SEQUENCE {			
periodicBSR-Timer	infinity		
retxBSR-Timer	sf2560		
}			
drx-Config	Not present		
pbr-Config CHOICE {			
release	NULL		
}			
sr-ProhibitTimer-r9	0		
}			

13.4.2 Inter-system mobility packet

13.4.2.1 Inter-system mobility / E-UTRA to UTRA packet

13.4.2.1.1 Test Purpose (TP)

(1)

```
with { UE has a default EPS bearer context }
ensure that {
  when { UE receives downlink data on the radio bearer associated with the default EPS bearer context }
  then { UE delivers the downlink data to upper layers }
}
```

(2)

```
with { UE has a default EPS bearer context }
ensure that {
  when { uplink data are submitted for transmission }
  then { UE transmits the uplink data on the radio bearer associated with the default EPS bearer context }
}
```

(3)

```
with { UE has a radio access bearer context and successful completion of the inter-system handover }
ensure that {
  when { UE receives downlink data on the radio bearer associated with the radio access bearer context }
  then { UE delivers the downlink data to upper layers }
}
```

(4)

```

with { UE has a radio access bearer context and successful completion of the inter-system handover }
ensure that {
  when { uplink data are submitted for transmission }
  then { UE transmits the uplink data on the radio bearer associated with the radio access bearer context }
}
    
```

13.4.2.1.2 Conformance requirements

References: The conformance requirements covered in the current TC are those listed in TC 8.4.1.2, plus those specified in: TS 23.401, clauses 5.5.2.1.2, 5.5.2.1.3.

[TS 23.401, clause 5.5.2.1.2]

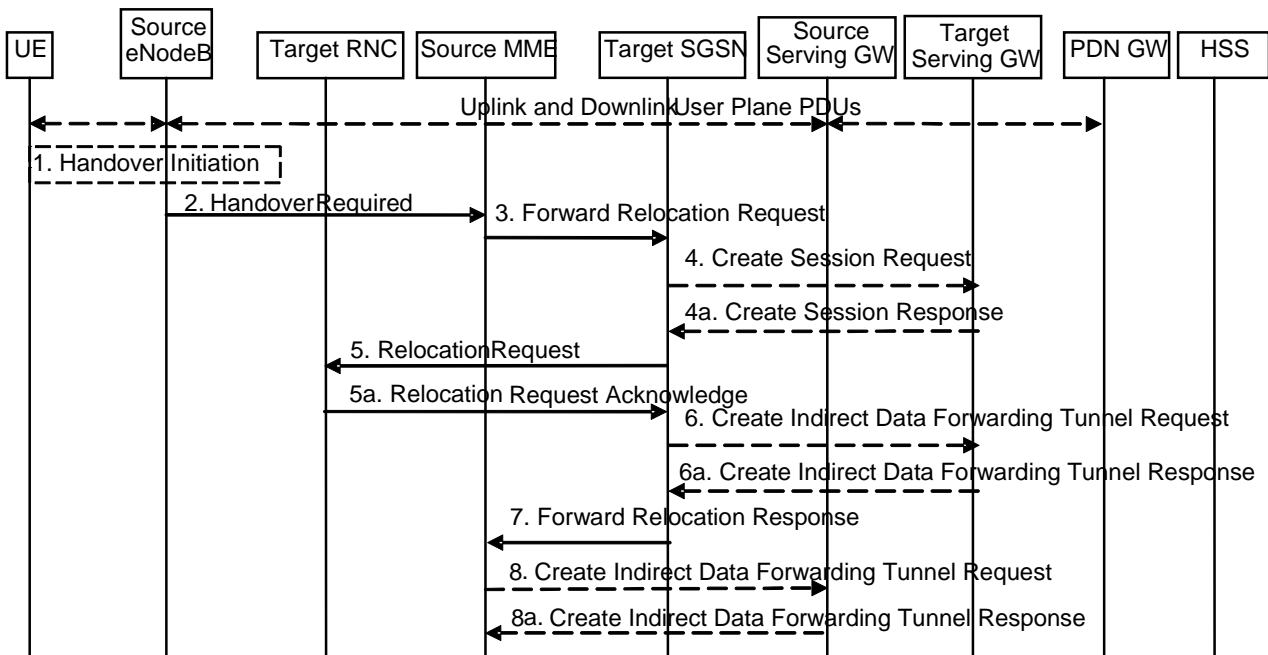

Figure 5.5.2.1.2-1: E-UTRAN to UTRAN Iu mode Inter RAT HO, preparation phase

1. The source eNodeB decides to initiate an Inter-RAT handover to the target access network, UTRAN Iu mode. At this point both uplink and downlink user data is transmitted via the following: Bearer(s) between UE and source eNodeB, GTP tunnel(s) between source eNodeB, Serving GW and PDN GW.

NOTE 1: The process leading to the handover decision is outside of the scope of this specification.

2. The source eNodeB sends a Handover Required (S1AP Cause, Target RNC Identifier, Source eNodeB Identifier, Source to Target Transparent Container) message to the source MME to request the CN to establish resources in the target RNC, target SGSN and the Serving GW. The bearers that will be subject to data forwarding (if any) are identified by the target SGSN in a later step (see step 7 below).
3. The source MME determines from the 'Target RNC Identifier' IE that the type of handover is IRAT Handover to UTRAN Iu mode. The Source MME initiates the Handover resource allocation procedure by sending a Forward Relocation Request (IMSI, Target Identification, MM Context, PDN Connections, MME Tunnel Endpoint Identifier for Control Plane, MME Address for Control plane, Source to Target Transparent Container, RAN Cause, MS Info Change Reporting Action (if available), ISR Supported, TI(s)) message to the target SGSN. The information ISR Supported is indicated if the source MME is capable to activate ISR for the UE. When ISR is activated the message should be sent to the SGSN that maintains ISR for the UE when this SGSN is serving the target identified by the Target Identification. This message includes all PDN Connections active in the source system and for each PDN Connection includes the associated APN, the address and the uplink Tunnel endpoint parameters of the Serving GW for control plane, and a list of EPS Bearer Contexts. RAN Cause indicates the S1AP Cause as received from source eNodeB.

The target SGSN maps the EPS bearers to PDP contexts 1-to-1 and maps the EPS Bearer QoS parameter values of an EPS bearer to the pre-Rel-8 QoS parameter values of a bearer context as defined in Annex E

Prioritization of PDP Contexts is performed by the target core network node, i.e. target SGSN.

The MM context contains security related information, e.g. supported ciphering algorithms as described in TS 29.274 [43]. Handling of security keys is described in TS 33.401 [41].

The target SGSN shall determine the Maximum APN restriction based on the APN Restriction of each bearer context in the Forward Relocation Request, and shall subsequently store the new Maximum APN restriction value.

4. The target SGSN determines if the Serving GW is to be relocated, e.g., due to PLMN change. If the Serving GW is to be relocated, the target SGSN selects the target Serving GW as described under clause 4.3.8.2 on "Serving GW selection function", and sends a Create Session Request message (IMSI, SGSN Tunnel Endpoint Identifier for Control Plane, SGSN Address for Control plane, PDN GW address(es) for user plane, PDN GW UL TEID(s) for user plane, PDN GW address(es) for control plane, and PDN GW TEID(s) for control plane, the Protocol Type over S5/S8) per PDN connection to the target Serving GW. The Protocol Type over S5/S8 is provided to Serving GW which protocol should be used over S5/S8 interface.

The target SGSN establishes the EPS Bearer context(s) in the indicated order. The SGSN deactivates the EPS Bearer contexts which cannot be established.

- 4a. The target Serving GW allocates its local resources and returns a Create Session Response (Serving GW address(es) for user plane, Serving GW UL TEID(s) for user plane, Serving GW Address for control plane, Serving GW TEID for control plane) message to the target SGSN.
5. The target SGSN requests the target RNC to establish the radio network resources (RABs) by sending the message Relocation Request (UE Identifier, Cause, CN Domain Indicator, Integrity protection information (i.e. IK and allowed Integrity Protection algorithms), Encryption information (i.e. CK and allowed Ciphering algorithms), RAB to be setup list, Source RNC to Target RNC Transparent Container, Service Handover related information). If the Access Restriction is present in the MM context, the Service Handover related information shall be included by the target SGSN for the Relocation Request message in order for RNC to restrict the UE in connected mode to handover to the RAT prohibited by the Access Restriction.

For each RAB requested to be established, RABs To Be Setup shall contain information such as RAB ID, RAB parameters, Transport Layer Address, and Iu Transport Association. The RAB ID information element contains the NSAPI value, and the RAB parameters information element gives the QoS profile. The Transport Layer Address is the Serving GW Address for user plane (if Direct Tunnel is used) or the SGSN Address for user plane (if Direct Tunnel is not used), and the Iu Transport Association corresponds to the uplink Tunnel Endpoint Identifier Data in Serving GW or SGSN respectively.

Ciphering and integrity protection keys are sent to the target RNC to allow data transfer to continue in the new RAT/mode target cell without requiring a new AKA (Authentication and Key Agreement) procedure. Information that is required to be sent to the UE (either in the Relocation Command message or after the handover completion message) from RRC in the target RNC shall be included in the RRC message sent from the target RNC to the UE via the transparent container. More details are described in TS 33.401 [41].

In the target RNC radio and Iu user plane resources are reserved for the accepted RABs. Cause indicates the RAN Cause as received from source MME. The Source RNC to Target RNC Transparent Container includes the value from the Source to Target Transparent Container received from the source eNodeB.

- 5a. The target RNC allocates the resources and returns the applicable parameters to the target SGSN in the message Relocation Request Acknowledge (Target RNC to Source RNC Transparent Container, RABs setup list, RABs failed to setup list).

Upon sending the Relocation Request Acknowledge message the target RNC shall be prepared to receive downlink GTP PDUs from the Serving GW, or Target SGSN if Direct Tunnel is not used, for the accepted RABs.

Each RAB in the RABs setup list is defined by a Transport Layer Address, which is the target RNC Address for user data, and the Iu Transport Association, which corresponds to the downlink Tunnel Endpoint Identifier for user data.

Any EPS Bearer contexts for which a RAB was not established are maintained in the target SGSN and the UE. These EPS Bearer contexts shall be deactivated by the target SGSN via explicit SM procedures upon the completion of the routing area update (RAU) procedure.

6. If 'Indirect Forwarding' and relocation of Serving GW apply and Direct Tunnel is used, the target SGSN sends a Create Indirect Data Forwarding Tunnel Request message (Target RNC Address and TEID(s) for data forwarding) to the Serving GW. If 'Indirect Forwarding' and relocation of Serving GW apply and Direct Tunnel is not used, then the target SGSN sends a Create Indirect Data Forwarding Tunnel Request message (SGSN Address and TEID(s) for data forwarding) to the Serving GW.

Indirect forwarding may be performed via a Serving GW which is different from the Serving GW used as the anchor point for the UE.

- 6a. The Serving GW returns a Create Indirect Data Forwarding Tunnel Response (Cause, Serving GW Address(es) and TEID(s) for data forwarding) message to the target SGSN.
7. The target SGSN sends the message Forward Relocation Response (Cause, SGSN Tunnel Endpoint Identifier for Control Plane, SGSN Address for Control Plane, Target to Source Transparent Container, Cause, RAB Setup Information, Additional RAB Setup Information, Address(es) and TEID(s) for User Traffic Data Forwarding, Serving GW change indication) to the source MME. Serving GW change indication indicates a new Serving GW has been selected. The Target to Source Transparent Container contains the value from the Target RNC to Source RNC Transparent Container received from the target RNC.

The IE 'Address(es) and TEID(s) for User Traffic Data Forwarding' defines the destination tunnelling endpoint for data forwarding in target system, and it is set as follows:

- If 'Direct Forwarding' applies, or if 'Indirect Forwarding' and no relocation of Serving GW apply and Direct Tunnel is used, then the IE 'Address(es) and TEID(s) for User Traffic Data Forwarding' contains the addresses and GTP-U tunnel endpoint parameters to the Target RNC received in step 5a.
 - If 'Indirect Forwarding' and relocation of Serving GW apply, then the IE 'Address(es) and TEID(s) for User Traffic Data Forwarding' contains the addresses and GTP-U tunnel endpoint parameters to the Serving GW received in step 6a. This is independent from using Direct Tunnel or not.
 - If 'Indirect Forwarding' applies and Direct Tunnel is not used and relocation of Serving GW does not apply, then the IE 'Address(es) and TEID(s) for User Traffic Data Forwarding' contains the addresses and GTP-U tunnel endpoint parameters to the Target SGSN.
8. If "Indirect Forwarding" applies, the Source MME sends the message Create Indirect Data Forwarding Tunnel Request (Address(es) and TEID(s) for Data Forwarding (received in step 7)), EPS Bearer ID(s)) to the Serving GW used for indirect forwarding.

Indirect forwarding may be performed via a Serving GW which is different from the Serving GW used as the anchor point for the UE.

- 8a. The Serving GW returns the forwarding parameters by sending the message Create Indirect Data Forwarding Tunnel Response (Cause, Serving GW Address(es) and TEID(s) for Data Forwarding). If the Serving GW doesn't support data forwarding, an appropriate cause value shall be returned and the Serving GW Address(es) and TEID(s) will not be included in the message.

[TS 23.401, clause 5.5.2.1.3]

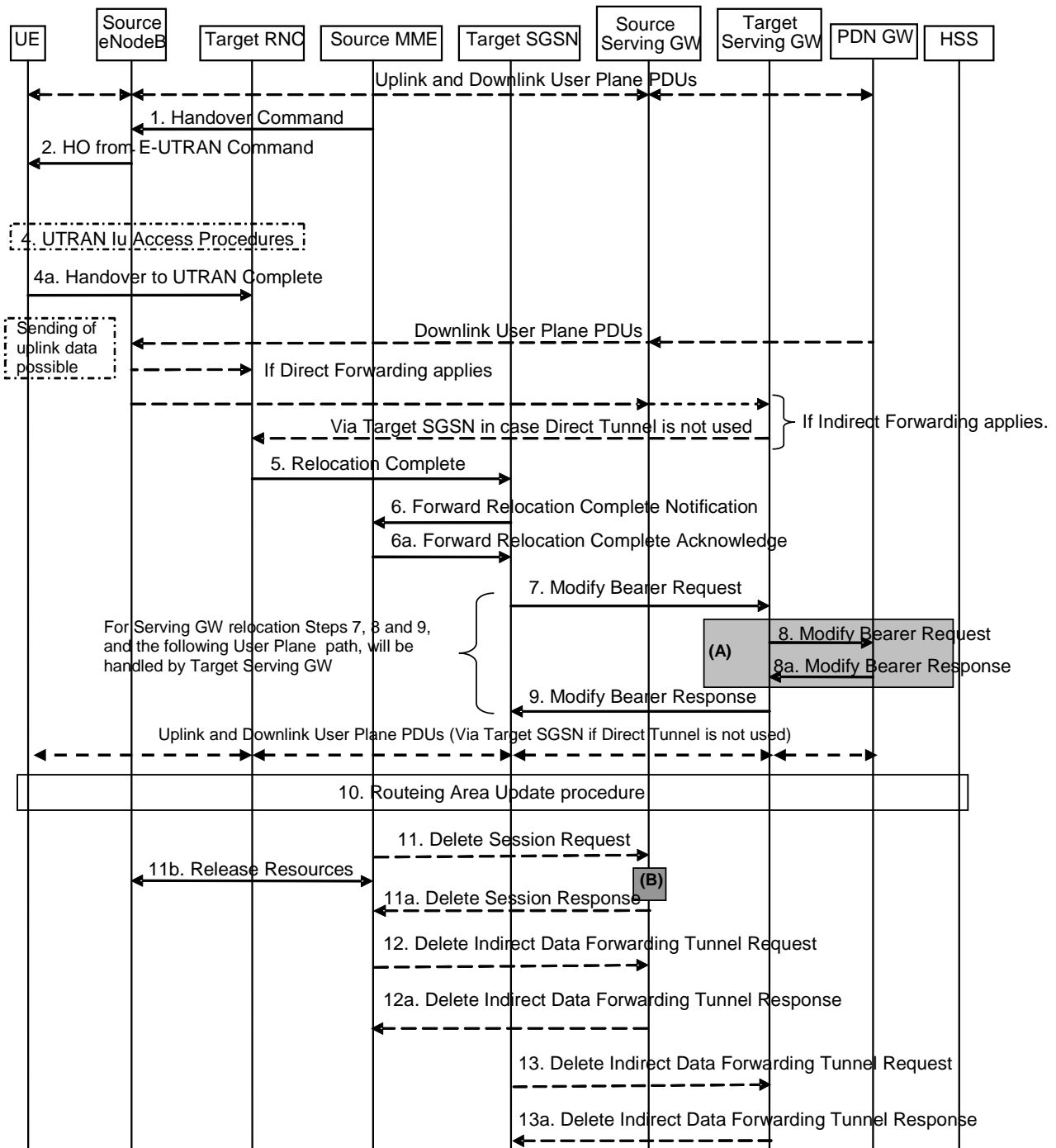

Figure 5.5.2.1.3-1: E-UTRAN to UTRAN lu mode Inter RAT HO, execution phase

NOTE: For a PMIP-based S5/S8, procedure steps (A) and (B) are defined in TS 23.402 [2]. Step (B) shows PCRF interaction in the case of PMIP-based S5/S8. Steps 8 and 8a concern GTP based S5/S8

The source eNodeB continues to receive downlink and uplink user plane PDUs.

1. The source MME completes the preparation phase towards source eNodeB by sending the message Handover Command (Target to Source Transparent Container, E-RABs to Release List, Bearers Subject to Data Forwarding List). The "Bearers Subject to Data forwarding list" IE may be included in the message and it shall be a list of 'Address(es) and TEID(s) for user traffic data forwarding' received from target side in the preparation phase (Step 7 of the preparation phase) when 'Direct Forwarding' applies, or the parameters received in Step 8a of the preparation phase when 'Indirect Forwarding' applies.

The source eNodeB initiates data forwarding for bearers specified in the "Bearers Subject to Data Forwarding List". The data forwarding may go directly to target RNC or alternatively go via the Serving GW if so decided by source MME and or/ target SGSN in the preparation phase.

2. The source eNodeB will give a command to the UE to handover to the target access network via the message HO from E-UTRAN Command. This message includes a transparent container including radio aspect parameters that the target RNC has set-up in the preparation phase. The details of this E-UTRAN specific signalling are described in TS 36.300 [5].

Upon the reception of the HO from E-UTRAN Command message containing the Handover Command message, the UE shall associate its bearer IDs to the respective RABs based on the relation with the NSAPI and shall suspend the uplink transmission of the user plane data.

3. Void.
4. The UE moves to the target UTRAN Iu (3G) system and executes the handover according to the parameters provided in the message delivered in step 2. The procedure is the same as in step 6 and 8 in clause 5.2.2.2 in TS 43.129 [8] with the additional function of association of the received RABs and existing Bearer Id related to the particular NSAPI.

The UE may resume the user data transfer only for those NSAPIs for which there are radio resources allocated in the target RNC.

The UE locally deactivates ISR by setting its TIN from "RAT-related TMSI" to "GUTI", if any EPS bearer context activated after the ISR was activated in the UE exists.

13.4.2.1.3 Test description

13.4.2.1.3.1 Pre-test conditions

System Simulator:

- Cell 1 and Cell 5
- System information combination 4 as defined in TS 36.508 [18] clause 4.4.3.1 is used in E-UTRA cells.

UE:

None.

Preamble:

- The UE is in state Generic RB Established (state 4) on Cell 1 according to [18] using the UE TEST LOOP MODE B.

13.4.2.1.3.2 Test procedure sequence

Table 13.4.2.1.3.2-1 illustrates the downlink power levels and other changing parameters to be applied for the cells at various time instants of the test execution. Row marked "T0" denotes the initial conditions after preamble, while columns marked "T1" is to be applied subsequently. The exact instants on which these values shall be applied are described in the texts in this clause.

Table 13.4.2.1.3.2-1: Time instances of cell power level and parameter changes

	Parameter	Unit	Cell 1	Cell 5	Remark
T0	Cell-specific RS EPRE	dBm/15k Hz	-85	-	The power level values are such that entering conditions for event B2 are not satisfied.
	CPICH_Ec (UTRA FDD)	dBm/3.8 4 MHz	-	-82	
	PCCPCH_Ec (UTRA LCR TDD)	dBm/1.2 8 MHz	-	-82	
T1	Cell-specific RS EPRE	dBm/15k Hz	-100	-	The power level values are such that entering conditions for event B2 are satisfied.
	CPICH_Ec (UTRA FDD)	dBm/3.8 4 MHz	-	-72	
	PCCPCH_Ec (UTRA LCR TDD)	dBm/1.2 8 MHz	-	-72	

Table 13.4.2.1.3.2-2: Main behaviour

St	Procedure	Message Sequence		TP	Verdict
		U - S	Message		
1	The SS transmits one IP packet to the UE on the DRB associated with the default EPS bearer context on Cell 1.	<--	IP packet	-	-
2	Check: Does the UE loop back the IP packet on the DRB associated with the default EPS bearer context on Cell 1?	-->	IP packet	1,2	P
3	The SS transmits an <i>RRCCoReonfiguration</i> message on Cell 1 to setup inter RAT measurement and reporting for event B2.	<--	<i>RRCCoReonfiguration</i>	-	-
4	The UE transmits an <i>RRCCoReonfigurationComplete</i> message on Cell 1.	-->	<i>RRCCoReonfigurationComplete</i>	-	-
5	The SS changes the power level for Cell 1 and Cell 5 according to the row "T1" in table 13.4.2.1.3.2-1	-	-	-	-
6	The UE transmits a <i>MeasurementReport</i> message on Cell 1 to report event B2 for Cell 5.	-->	<i>MeasurementReport</i>	-	-
6A	The SS transmits a <i>UECapabilityEnquiry</i> message to request UE radio access capability information for E-UTRA and UTRA.	<--	<i>UECapabilityEnquiry</i>	-	-
6B	The UE transmit a <i>UECapabilityInformation</i> message on Cell 1. NOTE: The start-PS values received, should be used to configure ciphering on cell 5.	-->	<i>UECapabilityInformation</i>	-	-
7	The SS transmits an <i>MobilityFromEUTRACommand</i> message on Cell 1 to order the UE to perform inter system handover to Cell 5.	<--	<i>MobilityFromEUTRACommand</i>	-	-
8	The UE transmit a HANDOVER TO UTRAN COMPLETE message on Cell 5 to confirm the successful completion of the inter system handover.	-->	HANDOVER TO UTRAN COMPLETE	-	-
-	EXCEPTION: The behaviour in table 13.4.2.1.3.2-3 may occur in parallel with steps 8A-8D.	-	-	-	-
8A	The SS transmits a SECURITY MODE COMMAND message on Cell 5 in order to activate integrity protection. Note: Ciphering has already been activated in steps 7/8	<--	SECURITY MODE COMMAND	-	-
8B	The UE transmits a SECURITY MODE COMPLETE message on Cell 5.	-->	SECURITY MODE COMPLETE	-	-
8C	The SS transmits a UTRAN MOBILITY INFORMATION message to notify CN information on Cell 5.	<--	UTRAN MOBILITY INFORMATION	-	-
8D	The UE transmits an UTRAN MOBILITY INFORMATION CONFIRM message on Cell 5.	-->	UTRAN MOBILITY INFORMATION CONFIRM	-	-
9-11	Void	-	-	-	-
12	The SS transmits a ROUTING AREA UPDATE ACCEPT message.	<--	ROUTING AREA UPDATE ACCEPT	-	-
13	The UE transmits a ROUTING AREA UPDATE COMPLETE message.	-->	ROUTING AREA UPDATE COMPLETE	-	-
14	The SS transmits one IP packet to the UE on the DRB associated with the RAB context on Cell 5.	<--	IP packet	-	-
15	Check: Does the UE loop back the IP packet on the DRB associated with the RAB context on Cell 5?	-->	IP packet	3,4	P

Table 13.4.2.1.3.2-3: Parallel behaviour

St	Procedure	Message Sequence		TP	Verdict
		U - S	Message		
1	UE transmits a ROUTING AREA UPDATE REQUEST message.	-->	ROUTING AREA UPDATE REQUEST	-	-

13.4.2.1.3.3 Specific message contents

Table 13.4.2.1.3.3-1: ACTIVATE TEST MODE (preamble)

Derivation Path: 36.508, Table 4.7A-1, condition UE TEST LOOP MODE B
--

Table 13.4.2.1.3.3-2: RRCConnectionReconfiguration (step 3, Table 13.4.2.1.3.2-2)

Derivation Path: 36.508 clause 4.6.1 table 4.6.1-8 with condition MEAS
--

Table 13.4.2.1.3.3-3: MeasConfig (step 3, Table 13.4.2.1.3.2-2)

Derivation path: 36.508 clause 4.6.6 table 4.6.6-1 with condition UTRAN			
Information Element	Value/Remark	Comment	Condition
measurementConfiguration ::= SEQUENCE {			
measObjectToAddModifyList SEQUENCE (SIZE (1..maxObjectId)) OF SEQUENCE {	2 entries		
measObjectId[1]	IdMeasObject-f1	Serving frequency	
measObject[1]	MeasObjectEUTRA-GENERIC(f1)		
measObjectId[2]	IdMeasObject-f8		
measObject[2]	MeasObjectEUTRA-GENERIC(f8)		
}			
reportConfigToAddModifyList SEQUENCE (SIZE (1..maxReportConfigId)) OF SEQUENCE {	1 entry		
reportConfigId[1]	IdReportConfigInterRAT-B2-UTRA		
reportConfig[1]	ReportConfigInterRAT-B2-UTRA (-90, -78)		
}			
measIdToAddModifyList SEQUENCE (SIZE (1..maxMeasId)) OF SEQUENCE {	1 entry		
measId[1]	1		
measObjectId[1]	IdMeasObject-f8		
reportConfigId[1]	IdReportConfigInterRAT-B2-UTRA		
}			
quantityConfig SEQUENCE {			
quantityConfigUTRA SEQUENCE {			
measQuantityUTRA-FDD	cpich-RSCP		UTRA-FDD
measQuantityUTRA-TDD	pccpch-RSCP		UTRA-TDD
}			
}			
}			

Table 13.4.2.1.3.3-4: *MeasurementReport* (step 6, Table 13.4.2.1.3.2-2)

Derivation Path: 36.508, table 4.6.1-5			
Information Element	Value/remark	Comment	Condition
MeasurementReport ::= SEQUENCE {			
criticalExtensions CHOICE {			
c1 CHOICE{			
measurementReport-r8 SEQUENCE {			
measResults SEQUENCE {			
measId	1		
measResultServCell SEQUENCE {			
rsrpResult	(0..97)		
rsrqResult	(0..34)		
}			
measResultNeighCells CHOICE {			
measResultListUTRA SEQUENCE (SIZE (1..maxCellReport)) OF SEQUENCE {	1 entry		
physCellId[1]	PhysicalCellIdentity of Cell 5		
cgi-Info[1]	Not present		
measResult[1] SEQUENCE {			
utra-RSCP	(-5..91)		
}			
}			
}			
}			
}			
}			
}			

Table 13.4.2.1.3.3-5: *MobilityFromEUTRACommand* (step 7, Table 13.4.2.1.3.2-2)

Derivation Path: 36.508 table 4.6.1-6			
Information Element	Value/remark	Comment	Condition
MobilityFromEUTRACommand ::= SEQUENCE {			
criticalExtensions CHOICE {			
c1 CHOICE{			
mobilityFromEUTRACommand-r8 SEQUENCE {			
purpose CHOICE {			
handover SEQUENCE {			
targetRAT-Type	utra		
targetRAT-MessageContainer	HANDOVER TO UTRAN COMMAND		
Nas-SecurityParamFromEUTRA	The 4 least significant bits of the NAS downlink COUNT value		
systemInformation	Not present		
}			
}			
}			
}			
}			

Table 13.4.2.1.3.3-6: HANDOVER TO UTRAN COMMAND (Table 13.4.2.1.3.3-5)

Derivation Path: 36.508 table 4.7B.1-1, condition UTRA PS RB
--

Table 13.4.2.1.3.3-7: UECapabilityEnquiry (step 6A, Table 13.4.2.1.3.2-2)

Derivation path: 36.508 clause 4.6.1 table 4.6.1-22			
Information Element	Value/Remark	Comment	Condition
UECapabilityEnquiry ::= SEQUENCE {			
criticalExtensions CHOICE {			
c1 CHOICE {			
ueCapabilityEnquiry-r8 SEQUENCE {			
ue-CapabilityRequest SEQUENCE (SIZE (1..maxRAT-Capabilities)) OF SEQUENCE {	2 entry		
RAT-Type[1]	Eutra		
RAT-Type[2]	Utra		
}			
}			
}			
}			
}			

Table 13.4.2.1.3.3-8: MeasObjectUTRA-GENERIC(f8) (Table 13.4.2.1.3.3-3)

Derivation path: 36.508 table 4.6.6-3 MeasObjectUTRA-GENERIC(f8)			
Information Element	Value/remark	Comment	Condition
cellsToAddModList CHOICE {			
cellsToAddModListUTRA-FDD ::= SEQUENCE (SIZE (1.. maxCellMeas)) OF SEQUENCE {			UTRA-FDD
cellIndex [1]	1		
physCellId [1]	physicalCellIdentity – Cell 5		
}			
cellsToAddModListUTRA-TDD ::= SEQUENCE (SIZE (1..maxMeasId)) OF SEQUENCE {			UTRA-TDD
cellIndex [1]	1		
physCellId [1]	physicalCellIdentity – Cell 5		
}			
}			

Table 13.4.2.1.3.3-9: UTRAN MOBILITY INFORMATION (step 8C, Table 13.4.2.1.3.2-2)

Derivation Path: 34.108 clause 9.1.1 (UTRAN MOBILITY INFORMATION message)	
Information Element	Value/remark
CN information info	
- PLMN identity	
- MCC	001
- MNC	01
- CN common GSM-MAP NAS system information	00 01H
- CN domain information list full	
- CN domain identity	PS
- CN domain specific NAS system information	01 00H
- DRX cycle length coefficient	7
- CN domain identity	CS
- CN domain specific NAS system information	1E 01H
- DRX cycle length coefficient	7

13.4.2.2 Inter-system mobility / E-UTRAN to GPRS packet

13.4.2.2.1 Test Purpose(TP)

(1)

```
with { UE has a default EPS bearer context}
ensure that {
  when { UE receives downlink data on the radio bearer associated with the default EPS bearer context }
}
```

```

    then { UE delivers the downlink data to upper layers }
}

```

(2)

```

with { UE has a default EPS bearer context }
ensure that {
  when { uplink data are submitted for transmission }
    then { UE transmits the uplink data on the radio bearer associated with the default EPS
bearer context }
}

```

(3)

```

with { UE has a radio access bearer context and successful completion of the inter-system handover }
ensure that {
  when { UE receives downlink data on the radio bearer associated with the radio access bearer
context }
    then { UE delivers the downlink data to upper layers }
}

```

(4)

```

with { UE has a radio access bearer context and successful completion of the inter-system handover }
ensure that {
  when { uplink data are submitted for transmission }
    then { UE transmits the uplink data on the radio bearer associated with the radio access
bearer context }
}

```

13.4.2.2.2 Conformance requirements

References: The conformance requirements covered in the current TC are those listed in TC 8.4.1.2, plus those specified in TS 23.401, clauses 5.5.2.3.2, 5.5.2.3.3.

[TS 23.401, clause 5.5.2.3.2]

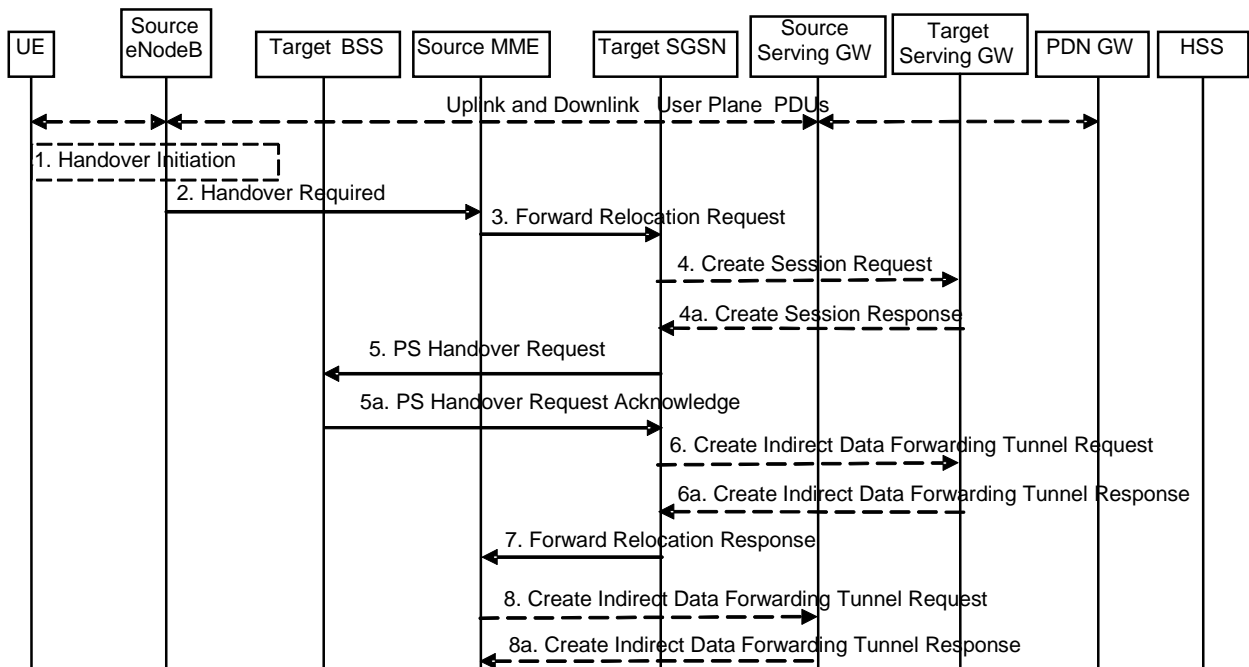

Figure 5.5.2.3.2-1: E-UTRAN to GERAN A/Gb Inter RAT HO, preparation phase

1. The source eNodeB decides to initiate an Inter RAT Handover to the target GERAN A/Gb mode (2G) system. At this point both uplink and downlink user data is transmitted via the following: Bearer(s) between UE and Source eNodeB, GTP tunnel(s) between Source eNodeB, Serving GW and PDN GW.

If the UE has an ongoing emergency bearer service the source eNodeB shall not initiate PS handover to GERAN.

NOTE 1: The process leading to the handover decision is outside of the scope of this specification

2. The source eNodeB sends a Handover Required (S1AP Cause, Target System Identifier, Source eNodeB Identifier, Source to Target Transparent Container) message to the Source MME to request the CN to establish resources in the Target BSS, Target SGSN and the Serving GW. The bearers that will be subject to data forwarding (if any) are identified by the target SGSN in a later step (see step 7 below).

The 'Target System Identifier' IE contains the identity of the target global cell Id.

3. The Source MME determines from the 'Target System Identifier' IE that the type of handover is IRAT Handover to GERAN A/Gb mode. The Source MME initiates the Handover resource allocation procedure by sending a Forward Relocation Request (IMSI, Target Identification (shall be set to "empty"), MM Context, PDN Connections, MME Tunnel Endpoint Identifier for Control Plane, MME Address for Control plane, Source to Target Transparent Container, Packet Flow ID, XID parameters (if available), Target Cell Identification, MS Info Change Reporting Action (if available), CSG Information Reporting Action (if available), UE Time Zone, ISR Supported, RAN Cause) message to the target SGSN. If the information ISR Supported is indicated, this indicates that the source MME and associated Serving GW are capable to activate ISR for the UE. When ISR is activated the message should be sent to the SGSN that maintains ISR for the UE when this SGSN is serving the target identified by the Target Identification. This message includes all PDN Connections active in the source system and for each PDN Connection includes the associated APN, the address and the uplink Tunnel endpoint parameters of the Serving GW for control plane, and a list of EPS Bearer Contexts.

The target SGSN maps the EPS bearers to PDP contexts 1-to-1 and maps the EPS Bearer QoS parameter values of an EPS bearer to the Release 99 QoS parameter values of a bearer context as defined in Annex E.

Prioritization of PDP Contexts is performed by the target core network node, i.e. target SGSN.

If the Source MME supports IRAT Handover to GERAN A/Gb procedure it has to allocate a valid PFI during the bearer activation procedure. RAN Cause indicates the S1AP Cause as received from the source eNodeB. The Source to Target Transparent Container includes the value from the Source to Target Transparent Container received from the source eNodeB.

The MM context contains security related information, e.g. supported ciphering algorithms, as described in TS 29.274 [43]. Handling of security keys is described in TS 33.401 [41].

The target SGSN selects the ciphering algorithm to use. This algorithm will be sent transparently from the target SGSN to the UE in the NAS container for Handover (part of the Target to Source Transparent Container). The IOV-UI parameter, generated in the target SGSN, is used as input to the ciphering procedure and it will also be transferred transparently from the target SGSN to the UE in the NAS container for Handover. More details are described in TS 33.401 [41].

When the target SGSN receives the Forward Relocation Request message the required EPS Bearer, MM, SMDCP and LLC contexts are established and a new P-TMSI is allocated for the UE. When this message is received by the target SGSN, it begins the process of establishing PFCs for all EPS Bearer contexts.

When the target SGSN receives the Forward Relocation Request message it extracts from the EPS Bearer Contexts the NSAPIs and SAPIs and PFIs to be used in the target SGSN. If for a given EPS Bearer Context the target SGSN does not receive a PFI from the source MME, it shall not request the target BSS to allocate TBF resources corresponding to that EPS Bearer Context. If none of the EPS Bearer Contexts forwarded from the source MME has a valid PFI allocated the target SGSN shall consider this as a failure case and the request for Handover shall be rejected.

If when an SAPI and PFI was available at the source MME but the target SGSN does not support the same SAPI and PFI for a certain NSAPI as the source MME, the target SGSN shall continue the Handover procedure only for those NSAPIs for which it can support the same PFI and SAPI as the source MME. All EPS Bearer contexts for which no resources are allocated by the target SGSN or for which it cannot support the same SAPI and PFI (i.e. the corresponding NSAPIs are not addressed in the response message of the target SGSN), are maintained

and the related SAPIs and PFIs are kept. These EPS Bearer contexts may be modified or deactivated by the target SGSN via explicit SM procedures upon RAU procedure.

The source MME shall indicate the current XID parameter settings if available (i.e. those XID parameters received during a previous IRAT Handover procedure) to the target SGSN. If the target SGSN can accept all XID parameters as indicated by the source MME, the target SGSN shall create a NAS container for Handover indicating 'Reset to the old XID parameters'. Otherwise, if the target SGSN cannot accept all XID parameters indicated by the source MME or if no XID parameters were indicated by the source MME, the target SGSN shall create a NAS container for Handover indicating Reset (i.e. reset to default parameters).

The target SGSN shall determine the Maximum APN restriction based on the APN Restriction of each bearer context received in the Forward Relocation Request, and shall subsequently store the new Maximum APN restriction value.

4. The target SGSN determines if the Serving GW is to be relocated, e.g., due to PLMN change. If the Serving GW is to be relocated, the target SGSN selects the target Serving GW as described under clause 4.3.8.2 on "Serving GW selection function", and sends a Create Session Request message (IMSI, SGSN Tunnel Endpoint Identifier for Control Plane, SGSN Address for Control plane, PDN GW address(es) for user plane, PDN GW UL TEID(s) for user plane, PDN GW address(es) for control plane, and PDN GW TEID(s) for control plane, the Protocol Type over S5/S8, Serving Network) per PDN connection to the target Serving GW. The Protocol Type over S5/S8 is provided to Serving GW which protocol should be used over S5/S8 interface.
- 4a. The target Serving GW allocates its local resources and returns a Create Session Response (Serving GW address(es) for user plane, Serving GW UL TEID(s) for user plane, Serving GW Address for control plane, Serving GW TEID for control plane) message to the target SGSN.
5. The target SGSN establishes the EPS Bearer context(s) in the indicated order. The SGSN deactivates, as provided in step 9 of the execution phase, the EPS Bearer contexts which cannot be established.

The Target SGSN requests the Target BSS to establish the necessary resources (PFCs) by sending the message PS Handover Request (Local TLLI, IMSI, Cause, Target Cell Identifier, PFCs to be set-up list, Source RNC to Target BSS Transparent Container and NAS container for handover). The target SGSN shall not request resources for which the Activity Status Indicator within a EPS Bearer Context indicates that no active bearer exists on the source side for that PDP context. The Cause indicates the RAN Cause as received from the source MME. The Source RNC to Target BSS Transparent Container contains the value from the Source to Target Transparent Container received from the source MME. All EPS Bearer Contexts indicate active status because E-UTRAN does not support selective RAB handling.

Based upon the ABQP for each PFC the target BSS makes a decision about which PFCs to assign radio resources. The algorithm by which the BSS decides which PFCs that need resources is implementation specific. Due to resource limitations not all downloaded PFCs will necessarily receive resource allocation. The target BSS allocates TBFs for each PFC that it can accommodate.

The target BSS shall prepare the 'Target to Source Transparent Container' which contains a PS Handover Command including the EPC part (NAS container for Handover) and the RN part (Handover Radio Resources).

- 5a. The Target BSS allocates the requested resources and returns the applicable parameters to the Target SGSN in the message PS Handover Request Acknowledge (Local TLLI, List of set-up PFCs, Target BSS to Source RNC Transparent Container, Cause). Upon sending the PS Handover Request Acknowledge message the target BSS shall be prepared to receive downlink LLC PDUs from the target SGSN for the accepted PFCs.

Any EPS Bearer contexts for which a PFC was not established are maintained in the target SGSN and the related SAPIs and PFIs are kept. These EPS Bearer contexts shall be deactivated by the target SGSN via explicit SM procedures upon the completion of the routing area update (RAU) procedure.

6. If indirect forwarding and relocation of Serving GW applies the target SGSN sends a Create Indirect Data Forwarding Tunnel Request message (Target SGSN Address(es) and TEID(s) for DL data forwarding) to the Serving GW used for indirect packet forwarding.

Indirect forwarding may be performed via a Serving GW which is different from the Serving GW used as the anchor point for the UE.

- 6a. The Serving GW returns a Create Indirect Data Forwarding Tunnel Response (Cause, Serving GW DL Address(es) and TEID(s) for data forwarding) message to the target SGSN.

7. The Target SGSN sends the message Forward Relocation Response (Cause, SGSN Tunnel Endpoint Identifier for Control Plane, SGSN Address for Control Plane, Target to Source Transparent Container, RAN Cause, List of set-up PFIs, Address(es) and TEID(s) for User Traffic Data Forwarding, Serving GW change indication) to the Source MME. Serving GW change indication indicates a new Serving GW has been selected. RAN Cause indicates the Cause as received from the target BSS. The Target to Source Transparent Container includes the value from the Target BSS to Source RNC Transparent Container received from the target BSS.

If 'Indirect Forwarding' and relocation of Serving GW applies, then the IEs 'Address(es) and TEID(s) for User Traffic Data Forwarding' contain the DL GTP-U tunnel endpoint parameters received in step 6a. Otherwise the IEs 'Address(es) and TEID(s) for User Traffic Data Forwarding' contains the DL GTP-U tunnel endpoint parameters to the Target SGSN.

The target SGSN activates the allocated LLC/SNDCP engines as specified in TS 44.064 [23] for an SGSN originated Reset or 'Reset to the old XID parameters'.

8. If "Indirect Forwarding" applies, the Source MME sends the message Create Indirect Data Forwarding Tunnel Request (Address(es) and TEID(s) for Data Forwarding (received in step 7)) to the Serving GW used for indirect packet forwarding.

Indirect forwarding may be performed via a Serving GW which is different from the Serving GW used as the anchor point for the UE.

- 8a. The Serving GW returns the forwarding user plane parameters by sending the message Create Indirect Data Forwarding Tunnel Response (Cause, Serving GW Address(es) and TEID(s) for Data Forwarding). If the Serving GW doesn't support data forwarding, an appropriate cause value shall be returned and the Serving GW Address(es) and TEID(s) will not be included in the message.

[TS 23.401, clause 5.5.2.3.3]

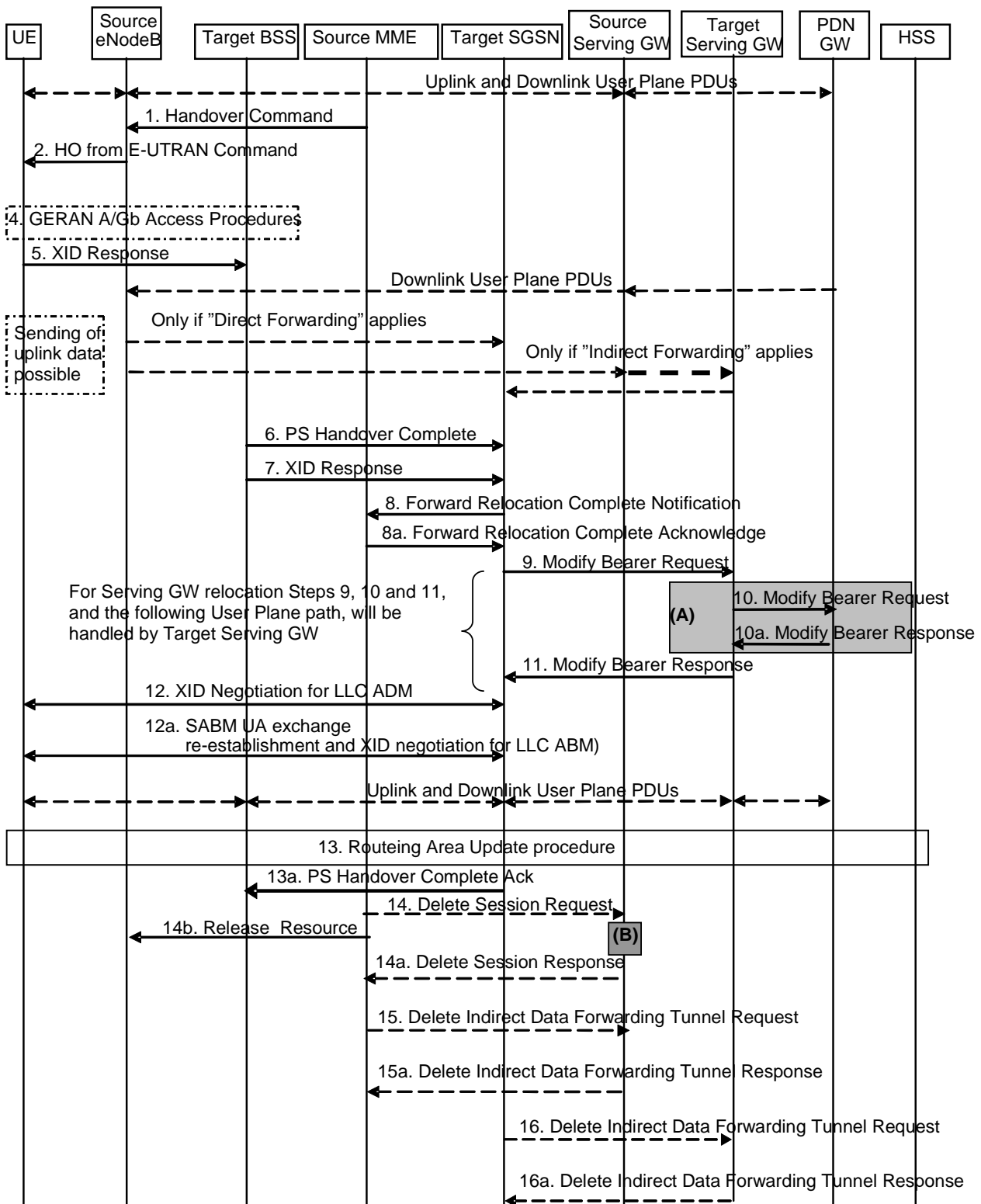

Figure 5.5.2.3.3-1: E-UTRAN to GERAN A/Gb mode Inter RAT HO, execution phase

NOTE 1: For a PMIP-based S5/S8, procedure steps (A) and (B) are defined in TS 23.402 [2]. Step (B) shows PCRF interaction in the case of PMIP-based S5/S8. Steps 10 and 10a concern GTP based S5/S8

The source eNodeB continues to receive downlink and uplink user plane PDUs.

1. The Source MME completes the preparation phase towards Source eNodeB by sending the message Handover Command (Target to Source Transparent Container (PS Handover Command with RN part and EPC part),

E-RABs to Release List, Bearers Subject to Data Forwarding List), S1AP Cause. The "Bearers Subject to Data forwarding list" may be included in the message and it shall be a list of 'Address(es) and TEID(s) for user traffic data forwarding' received from target side in the preparation phase (Step 7 of the preparation phase for Direct Forwarding, else parameters received in Step 8a of the preparation phase). S1AP Cause indicates the RAN Cause as received from the target SGSN.

Source eNodeB initiate data forwarding for the bearers specified in the "Bearers Subject to Data Forwarding List". The data forwarding may go directly i.e. to target SGSN or alternatively go via the Serving GW if so decided by source MME and/or target SGSN in the preparation phase.

2. The Source eNodeB will give a command to the UE to handover to the Target Access System via the message HO from E-UTRAN Command. This message includes a transparent container including radio aspect parameters that the Target BSS has set-up in the preparation phase (RN part). This message also includes the XID and IOV-UI parameters received from the Target SGSN (EPC part).

Upon the reception of the HO from E-UTRAN Command message containing the Handover Command message, the UE shall associate its bearer IDs to the respective PFIs based on the relation with the NSAPI and shall suspend the uplink transmission of the user plane data.

3. Void.
4. The UE moves to the Target GERAN A/Gb (2G) system and performs executes the handover according to the parameters provided in the message delivered in step 2. The procedure is the same as in step 6 in clause 5.3.2.2 in TS 43.129 [8] with the additional function of association of the received PFI and existing Bearer Id related to the particular NSAPI.

The UE locally deactivates ISR by setting its TIN from "RAT-related TMSI" to "GUTI", if any EPS bearer context activated after the ISR was activated in the UE exists.

5. After accessing the cell using access bursts and receiving timing advance information from the BSS in step 4, the UE processes the NAS container and then sends one XID response message to the target SGSN via target BSS. The UE sends this message immediately after receiving the Packet Physical Information message containing the timing advance or, in the synchronised network case, immediately if the PS Handover Access message is not required to be sent.

Upon sending the XID Response message, the UE shall resume the user data transfer only for those NSAPIs for which there are radio resources allocated in the target cell. For NSAPIs using LLC ADM, for which radio resources were not allocated in the target cell, the MS may request for radio resources using the legacy procedures.

If the Target SGSN indicated XID Reset (i.e. reset to default XID parameters) in the NAS container included in the HO from E-UTRAN Command message, and to avoid collision cases the mobile station may avoid triggering XID negotiation for any LLC SAPI used in LLC ADM, but wait for the SGSN to do so (see step 12). In any case the mobile station may avoid triggering XID negotiation for any LLC SAPI used in LLC ABM, but wait for the SGSN to do so (see step 12a).

This step is the same as specified in clause 5.3.2.2 in TS 43.129 [8].

6. Upon reception of the first correct RLC/MAC block (sent in normal burst format) from the UE to the Target BSS, the Target BSS informs the Target SGSN by sending the message PS Handover Complete (IMSI, and Local TLLI, Request for Inter RAT Handover Info). The target BSS that supports inter-RAT PS handover to UTRAN shall, when the INTER RAT HANDOVER INFO was not included in the Source BSS to Target BSS transparent container received in the PS HANDOVER REQUEST message as specified in TS 48.018 [42], request the INTER RAT HANDOVER INFO from the target SGSN by setting the 'Request for Inter RAT Handover Info' to '1'.
7. The Target BSS also relays the message XID Response to the Target SGSN. Note, the message in step 6 and 7 may arrive in any order in the Target SGSN.
8. Then the Target SGSN knows that the UE has arrived to the target side and Target SGSN informs the Source MME by sending the Forward Relocation Complete Notification (ISR Activated, Serving GW change) message. If ISR Activated is indicated, the source MME shall maintain the UE's contexts and activate ISR, which is only possible when the S-GW is not changed. The Source MME will also acknowledge that information. A timer in

source MME is started to supervise when resources in Source eNodeB and Source Serving GW (for Serving GW relocation) shall be released.

Upon receipt of the Forward Relocation Complete Acknowledge message the target SGSN starts a timer if the target SGSN allocated S-GW resources for indirect forwarding.

9. The Target SGSN will now complete the Handover procedure by informing the Serving GW (for Serving GW relocation this will be the Target Serving GW) that the Target SGSN is now responsible for all the EPS Bearer Context(s) the UE has established. This is performed in the message Modify Bearer Request (SGSN Tunnel Endpoint Identifier for Control Plane, NSAPI(s), SGSN Address for Control Plane, SGSN Address(es) and TEID(s) for User Traffic for the accepted EPS bearers and RAT type, ISR Activated) per PDN connection. If the PDN GW requested UE's location and/or User CSG information (determined from the UE context), the SGSN also includes the User Location Information IE and/or User CSG Information IE in this message. If the UE Time Zone has changed, the SGSN includes the UE Time Zone IE in this message. If indicated, ISR Activated indicates that ISR is activated, which is only possible when the S-GW was not changed. When the Modify Bearer Request does not indicate ISR Activated and S-GW is not changed, the S-GW deletes any ISR resources by sending a Delete Bearer Request to the other CN node that has bearer resources on the S-GW reserved.

The SGSN releases the non-accepted EPS Bearer contexts by triggering the EPS Bearer context deactivation procedure. If the Serving GW receives a DL packet for a non-accepted bearer, the Serving GW drops the DL packet and does not send a Downlink Data Notification to the SGSN.

10. The Serving GW (for Serving GW relocation this will be the Target Serving GW) may inform the PDN GW the change of, for example, for Serving GW relocation or the RAT type, that e.g. can be used for charging, by sending the message Modify Bearer Request per PDN connection. The S-GW also includes User Location Information IE and/or UE Time Zone IE and/or User CSG Information IE if they are present in step 9. Serving Network should be included if it is received in step 4. For Serving GW relocation, the Serving GW allocates DL TEIDs on S5/S8 even for non-accepted bearers. The PDN GW must acknowledge the request with the message Modify Bearer Response. In the case of Serving GW relocation, the PDN GW updates its context field and returns a Modify Bearer Response (Charging Id, MSISDN, etc.) message to the Serving GW. The MSISDN is included if the PDN GW has it stored in its UE context.

If PCC infrastructure is used, the PDN GW informs the PCRF about the change of, for example, the RAT type.

11. The Serving GW (for Serving GW relocation this will be the Target Serving GW) acknowledges the user plane switch to the Target SGSN via the message Modify Bearer Response (Cause, Serving GW Tunnel Endpoint Identifier for Control Plane, Serving GW Address for Control Plane, Protocol Configuration Options). At this stage the user plane path is established for all EPS Bearer contexts between the UE, Target BSS, Target SGSN, Serving GW (for Serving GW relocation this will be the Target Serving GW) and PDN GW.

If the Serving GW does not change, the Serving GW shall send one or more "end marker" packets on the old path immediately after switching the path.

12. If the Target SGSN indicated XID Reset (i.e. reset to default XID parameters) in the NAS container included in the HO from E-UTRAN Command message, then on receipt of the PS Handover Complete the Target SGSN initiates an LLC/SNDCP XID negotiation for each LLC SAPI used in LLC ADM. In this case if the Target SGSN wants to use the default XID parameters, it shall send an empty XID Command. If the Target SGSN indicated 'Reset to the old XID parameters' in the NAS container, no further XID negotiation is required for LLC SAPIs used in LLC ADM only.

- 12a. The Target SGSN (re-)establishes LLC ABM for the EPS Bearer contexts which use acknowledged information transfer. During the exchange of SABM and UA the SGSN shall perform LLC/SNDCP XID negotiation.

These steps (12 and 12a) are the same as specified in clause 5.3.2.2 in TS 43.129 [8].

13. After the UE has finished the reconfiguration procedure the UE shall initiate the Routing Area Update procedure.

NOTE 1: The RAU procedure is performed regardless if the UE has this routing area registered or not, as specified by TS 43.129 [8]. This is needed e.g. to update the START-PS value stored in the 2G-SGSN. The START_PS is delivered to SGSN in INTER RAT HANDOVER INFO parameter of RAU Complete message when requested by SGSN in RAU Accepted.

The target SGSN knows that an IRAT Handover has been performed for this UE as it received the bearer context(s) by handover messages and therefore the target SGSN performs only a subset of the RAU procedure, specifically it excludes the context transfer procedures between source MME and target SGSN.

- 13a. Upon reception of the PS Handover Complete message with the 'Request for Inter RAT Handover Info' set to '1', the SGSN should send then PS Handover Complete Acknowledge (TLLI, INTER RAT HANDOVER INFO) to the target BSS.

NOTE 2: An SGSN that does not recognize the "Request for Inter RAT Handover Info" in the PS Handover Complete message will not send the PS Handover Complete Acknowledge message back to the BSS.

The target BSS receiving the PS Handover Complete Acknowledge message shall set the 'Reliable INTER RAT HANDOVER' to '1' in the PS Handover Required message in any subsequent PS handover to GERAN A/Gb mode. The target BSS failing to receive the PS Handover Complete Acknowledge message shall set the 'Reliable INTER RAT HANDOVER' to '0' in the PS Handover Required message in any subsequent PS handover to GERAN A/Gb mode. The Target BSS shall, upon receipt of the INTER RAT HANDOVER INFO in the PS Handover Complete Acknowledge message, overwrite its current INTER RAT HANDOVER INFO with this new one.

14. When the timer started at step 8 expires, the source MME sends a Release Resources message to the source eNodeB. The Source eNodeB releases its resources related to the UE.

When the timer started in step 8 expires and if the source MME received the Serving GW change indication in the Forward Relocation Response message, it deletes the EPS bearer resources by sending Delete Session Request (Cause) messages to the Source Serving GW. Cause indicates to the Source Serving GW that the Serving GW changes and the Source Serving GW shall not initiate a delete procedure towards the PDN GW. The Source Serving GW acknowledges with Delete Session Response (Cause) messages. If ISR has been activated before this procedure, the cause also indicates to the Source S-GW that the Source S-GW shall delete the bearer resources on the other old CN node by sending Delete Bearer Request message(s) to that CN node.

15. If indirect forwarding was used then the expiry of the timer at source MME started at step 8 triggers the source MME to send a Delete Indirect Data Forwarding Tunnel Request message to the S-GW to release the temporary resources used for indirect forwarding.
16. If indirect forwarding was used and the Serving GW is relocated, then the expiry of the timer at target SGSN started at step 8 triggers the target SGSN to send a Delete Indirect Data Forwarding Tunnel Request message to the target S-GW to release temporary resources used for indirect forwarding.

13.4.2.2.3.1 Pre-test conditions

System Simulator:

- Cell 1 and Cell 24
- System information combination 5 as defined in TS 36.508[18] clause 4.4.3.1 is used in E-UTRA cell;

UE:

None.

Preamble:

- The UE is in state Loopback Activated (state 4) on Cell 1 according to [18] using the UE TEST LOOP MODE B.

13.4.2.2.3.2 Test procedure sequence

Table 13.4.2.3.2-1 illustrates the downlink power levels and other changing parameters to be applied for the cells at various time instants of the test execution. Row marked "T0" DENOTES THE INITIAL CONDITIONS AFTER PREAMBLE WHILE COLUMNS MARKED "T1" is to be applied subsequently. The exact instants on which these values shall be applied are described in the texts in this clause.

Table 13.4.2.3.2-1: Time instances of cell power level and parameter changes

	Parameter	Unit	Cell 1	Cell 24	Remark
T0	Cell-specific RS EPRE	dBm/15k Hz	-60	-	The power level values are such that entering conditions for event B2 are not satisfied.
	RSSI	dBm	-	-85	
T1	Cell-specific RS EPRE	dBm/15k Hz	-80	-	The power level values are such that entering conditions for event B2 are satisfied.
	RSSI	dBm	-	-65	

Table 13.4.2.3.2-2: Main behaviour

St	Procedure	Message Sequence		TP	Verdict
		U - S	Message		
1	The SS transmits one IP packet to the UE on the DRB associated with the default EPS bearer context on Cell 1.	<--	IP packet	-	-
2	Check: Does the UE loop back the IP packet on the DRB associated with the default EPS bearer context on Cell 1?	-->	IP packet	1,2	P
3	The SS transmits an <i>RRCCONNECTIONRECONFIGURATION</i> message on Cell 1 to setup inter RAT measurement and reporting for event B2.	<--	<i>RRCCONNECTIONRECONFIGURATION</i>	-	-
4	The UE transmits an <i>RRCCONNECTIONRECONFIGURATIONCOMPLETE</i> message on Cell 1.	-->	<i>RRCCONNECTIONRECONFIGURATIONCOMPLETE</i>	-	-
5	The SS changes the power level for Cell 1 and Cell 24 according to the row "T1" in table 13.4.2.3.2-1	-	-	-	-
6	The UE transmits a <i>MEASUREMENTREPORT</i> message on Cell 1 to report event B2 for Cell 24.	-->	<i>MEASUREMENTREPORT</i>	-	-
7	The SS transmits a <i>MOBILITYFROMEUTRACOMMAND</i> message on Cell 1 to order the UE to perform inter system handover to Cell 24.	<--	<i>MOBILITYFROMEUTRACOMMAND</i>	-	-
8	The UE transmits a HANOVER ACCESS message on Cell 24 to switch to GSM cell.	-->	HANOVER ACCESS	-	-
9	The SS transmits a PHYSICAL INFORMATION message on Cell 24 to indicate parameters	<--	PHYSICAL INFORMATION	-	-
10-18	Steps 3 to 11 of the Routing Area Update procedure described in TS 36.508 subclause 6.4.2.9 are performed on Cell 24. NOTE: The UE performs RAU procedure.	-	-	-	-
19	The SS transmits one IP packet to the UE on the DRB associated with the RAB context on Cell 24.	<--	IP packet	-	-
20	Check: Does the UE loop back the IP packet on the DRB associated with the RAB context on Cell 24?	-->	IP packet	3,4	P

13.4.2.3.3 Specific message contents

Table 13.4.2.3.3-1: ACTIVATE TEST MODE (preamble)

Derivation Path: 36.508, Table 4.7A-1, condition UE TEST LOOP MODE B
--

Table 13.4.2.3.3-2: *RRCCONNECTIONRECONFIGURATION* (step 3, Table 13.4.2.3.2-2)

Derivation Path: 36.508 clause 4.6.1 table 4.6.1-8 with condition MEAS
--

Table 13.4.2.2.3.3-3: *MeasConfig* (step 3, Table 13.4.2.2.3.2-2)

Derivation Path: 36.508, Table 4.6.6-1, condition GERAN			
Information Element	Value/remark	Comment	Condition
MeasConfig ::= SEQUENCE {			
measObjectToAddModList SEQUENCE (SIZE (1..maxObjectId)) OF SEQUENCE {	2entry		
measObjectId[1]	IdMeasObject-EUTRA		
measObject[1]	MeasObjectEUTRA-GENERIC(f1)		
measObjectId[2]	IdMeasObject-f11		
measObject[2]	MeasObjectGERAN-GENERIC(f11)		
}			
reportConfigToAddModList SEQUENCE (SIZE (1..maxReportConfigId)) OF SEQUENCE {	2entry		
reportConfigId[1]	IdReportConfig-A2		
reportConfig[1]	ReportConfigEUTRA-A2(-95)		
reportConfigId[2]	IdReportConfig-B2-GERAN		
reportConfig[2]	ReportConfigInterRAT-B2-GERAN(-69, -79)		
}			
measIdToAddModList SEQUENCE (SIZE (1..maxMeasId)) OF SEQUENCE {	2 entry		
measId[1]	1		
measObjectId[1]	IdMeasObject-EUTRA		
reportConfigId[1]	IdReportConfig-A2		
measId[2]	2		
measObjectId[2]	IdMeasObject-f11		
reportConfigId[2]	IdReportConfig-B2-GERAN		
}			
quantityConfig SEQUENCE {			
quantityConfigGERAN SEQUENCE {			
measQuantityGERAN	rssI		
filterCoefficient	fc0		
}			
}			
}			

Table 13.4.2.2.3.3-4: MeasurementReport (step 6, Table 13.4.2.2.3.2-2)

Derivation Path: 36.508, table 4.6.1-5			
Information Element	Value/remark	Comment	Condition
MeasurementReport ::= SEQUENCE {			
criticalExtensions CHOICE {			
c1 CHOICE{			
measurementReport-r8 SEQUENCE {			
measResults SEQUENCE {			
measId	1		
measResultServCell SEQUENCE {			
rsrpResult	(0..97)		
rsrqResult	(0..34)		
}			
measResultNeighCells CHOICE {			
measResultListGERAN SEQUENCE (SIZE (1..maxCellReport)) OF SEQUENCE {	1 entry		
physCellId[1]	PhysicalCellIdentity of Cell 24		
cgi-Info[1]	Not present		
measResult[1] SEQUENCE {			
rssi	(0..63)		
}			
}			
}			
}			
}			
}			

Table 13.4.2.2.3.3-5: MobilityFromEUTRACommand (step 7, Table 13.4.2.2.3.2-2)

Derivation Path: 36.508 table 4.6.1-6			
Information Element	Value/remark	Comment	Condition
MobilityFromEUTRACommand ::= SEQUENCE {			
criticalExtensions CHOICE {			
c1 CHOICE{			
mobilityFromEUTRACommand-r8 SEQUENCE {			
csFallbackIndicator	false		
purpose CHOICE {			
handover SEQUENCE {			
targetRAT-Type	geran		
targetRAT-MessageContainer	PS HANDOVER COMMAND		
nas-SecurityParamFromEUTRA	Not present		
systemInformation	Not present		
}			
}			
}			
}			
}			

Table 13.4.2.2.3.3-6: PS HANDOVER COMMAND (step 7, Table 13.4.2.2.3.2-2)

Derivation Path from TS 36.508, Table 4.7D.1-1.

13.4.2.3

13.4.2.4 Inter-system mobility / Service based redirection from UTRA to E-UTRA

13.4.2.4.1 Test Purpose (TP)

(1)

```
with { UE in UTRA RRC idle state and pdp-active state }
ensure that {
  when { UE is requested to initiate uplink data traffic. }
  then { UE includes in the RRC CONNECTION REQUEST the IE Pre-Redirection info and the IE Domain indicator is set to PS Domain }
}
```

(2)

```
with { UE has a default EPS bearer context upon redirection }
ensure that {
  when { UE receives downlink data on the radio bearer associated with the default EPS bearer context }
  then { UE delivers the downlink data to upper layers }
}
```

(3)

```
with { UE has a default EPS bearer context upon redirection }
ensure that {
  when { uplink data are submitted for transmission }
  then { UE transmits the uplink data on the radio bearer associated with the default EPS bearer context }
}
```

13.4.2.4.2 Conformance requirements

References: The conformance requirements covered in the current TC are those listed in TC 8.1.3.7, plus those specified in: TS 24.008, clause 4.7.13.5.

[TS 24.008, clause 4.7.13.5]

The following abnormal cases can be identified:

a) Access barred because of access class control

The Service request procedure shall not be started. The MS stays in the current serving cell and applies normal cell reselection process. The Service request procedure may be started by CM layer if it is still necessary, i.e. when access is granted or because of a cell change.

b) Lower layer failure before the security mode control procedure is completed, SERVICE ACCEPT or SERVICE REJECT message is received

The procedure shall be aborted except in the following implementation option cases b.1, b.2 and b.3.

b.1) Release of PS signalling connection in Iu mode (i.e. RRC connection release) before the completion of the service request procedure

The service request procedure shall be initiated again, if the following conditions apply:

- i) The original service request procedure was initiated over an existing PS signalling connection; and
- ii) No SECURITY MODE COMMAND message and no Non-Access Stratum (NAS) messages relating to the PS signalling connection were received after the SERVICE REQUEST message was transmitted.

b.2) RR release in Iu mode (i.e. RRC connection release) with cause different than "Directed signalling connection re-establishment", for example, "Normal", or "User inactivity" (see 3GPP TS 25.331 [32c] and 3GPP TS 44.118 [111])

The service request procedure shall be initiated again, if the following conditions apply:

- i) The original service request procedure was initiated over an existing RRC connection and,

- ii) No SECURITY MODE COMMAND message and no Non-Access Stratum (NAS) messages relating to the PS signalling connection were received after the SERVICE REQUEST message was transmitted.

NOTE: The RRC connection release cause different than "Directed signalling connection re-establishment" that triggers the re-initiation of the service request procedure is implementation specific.

- b.3) RR release in Iu mode (i.e. RRC connection release) with cause "Directed signalling connection re-establishment" (see 3GPP TS 25.331 [32c] and 3GPP TS 44.118 [111])

The routing area updating procedure shall be initiated followed by a rerun of the service request procedure if the following condition applies:

- i) The service request procedure was not due to a rerun of the procedure due to "Directed signalling connection re-establishment".

13.4.2.4.3 Test description

13.4.2.4.3.1 Pre-test conditions

System Simulator:

- Cell 1 and Cell 5
- System information combination 4 as defined in TS 36.508 [18] clause 4.4.3.1 is used in E-UTRA cells.

UE:

None.

Preamble:

- The UE is in state Generic RB Established, UE test mode activated (state 3A) according to [18] using the UE TEST LOOP MODE B and then moved to RRC idle state, GMM-Registered and pdp-active State on Cell 5

13.4.2.4.3.2 Test procedure sequence

Table 13.4.2.4.3.2-1 illustrates the downlink power levels and other changing parameters to be applied for the cells at various time instants of the test execution. Row marked "T0" denotes the initial conditions after preamble, while columns marked "T1" is to be applied subsequently. The exact instants on which these values shall be applied are described in the texts in this clause.

Table 13.4.2.4.3.2-1: Time instances of cell power level and parameter changes

	Parameter	Unit	Cell 1	Cell 5	Remark
T1	Cell-specific RS EPRE	dBm/15k Hz	-75	-	
	CPICH Ec (UTRA FDD)	dBm/3.8 4 MHz	-	-70	
	PCCPCH Ec (UTRA LCR TDD)	dBm/1.2 8 MHz	-	-72	

Table 13.4.2.4.3.2-2: Main behaviour

St	Procedure	Message Sequence		TP	Verdict
		U - S	Message		
1	The SS sends a PAGING TYPE 1 message.	<--	PAGING TYPE 1	-	-
2	Check: does the UE include the IE include the IE Pre-redirection info with Support of E-UTRA set to TRUE and the Domain indicator is set to PS domain?	-->	RRC CONNECTION REQUEST	1	P
3	The SS transmit a RRC CONNECTION SETUP on SRB1 on Cell 5.	<--	RRC CONNECTION SETUP	-	-
4	The UE transmits an RRC CONNECTION SETUP COMPLETE message	-->	RRC CONNECTION SETUP COMPLETE	-	-
5	The UE transmits the SERVICE REQUEST message for Paging Response	-->	RRC: INITIAL DIRECT TRANSFER NAS: SERVICE REQUEST	-	-
6	The SS transmits an RRC CONNECTION RELEASE message (IE E-UTRA target info including DL Carrier frequency of Cell 1).	<--	RRC CONNECTION RELEASE	-	-
7	The UE transmits a RRC CONNECTION RELEASE COMPLETE message	-->	RRC CONNECTION RELEASE COMPLETE	-	-
8	The UE transmits a RRC CONNECTION RELEASE COMPLETE message	-->	RRC CONNECTION RELEASE COMPLETE	-	-
9-15	Steps 1 to 7 of the generic test procedure in TS 36.508 [18] subclause 6.4.2.7A-1 are performed on Cell 1. Note: The UE performs a TAU procedure.	-	-	-	-
15A1	The SS starts timer Timer_1 = 1 s	-	-	-	-
-	EXCEPTION: Steps 15Ba1 to 15Bb1 describe a transaction that depends on the UE behaviour; the "lower case letter" identifies a step sequence that takes place if a specific behaviour happens.	-	-	-	-
15Ba1	The UE transmits a SERVICE REQUEST message.	-->	RRC: <i>ULInformationTransfer</i> NAS: SERVICE REQUEST	-	-
15Bb1	The SS waits for Timer_1 expiry	-	-	-	-
15C	The SS transmits a <i>SecurityModeCommand</i> message to activate AS security.	<--	<i>SecurityModeCommand</i>	-	-
15D	The UE transmits a <i>SecurityModeComplete</i> message and establishes the initial security configuration.	-->	<i>SecurityModeComplete</i>	-	-
15E	The SS transmits an <i>RRCCONNECTIONReconfiguration</i> message to establish the default bearer with condition SRB2-DRB(1, 0) according to 4.8.2.2.1.1.	<--	<i>RRCCONNECTIONReconfiguration</i>	-	-
15F	The UE transmits an <i>RRCCONNECTIONReconfigurationComplete</i> message to confirm the establishment of default bearer.	-->	<i>RRCCONNECTIONReconfigurationComplete</i>	-	-
16	The SS closes the UE test loop mode.	-	-	-	-
17	The SS transmits one IP packet to the UE on the DRB associated with the default EPS bearer context.	<--	IP packet	-	-
18	Check: Does the UE loop back the IP packet on the DRB associated with the default EPS bearer context?	-->	IP packet	2, 3	P

13.4.2.4.3.3 Specific message contents

Table 13.4.2.4.3.3-1: System Information Block type 19 for Cell 5 (preamble and all steps, Table 13.4.2.4.3.2-2)

Derivation Path: 36.508 table Table 4.4.4.1-1			
Information Element	Value/remark	Comment	Condition
SysInfoType19 ::= SEQUENCE {			
utra-PriorityInfoList SEQUENCE {			
utra-ServingCell SEQUENCE {			
Priority	4		
}			
}			
utra-FrequencyAndPriorityInfoList SEQUENCE (SIZE (1..maxNumEUTRAFreqs)) OF SEQUENCE	1 entry		
earfcn[1]	Downlink EARFCN of Cell 1		
priority[1]	3		
}			
}			

Table 13.4.2.4.3.3-2: PAGING TYPE 1 (step 1, Table 13.4.2.4.3.2-2)

Derivation path: 34.108 default PAGING TYPE 1 in section 9.1.1 for UTRA FDD or 9.1.2 for UTRA TDD			
Information Element	Value/Remark	Comment	Condition
Paging record list	1 Entry		
Paging record	Present		
Paging cause	Terminating High Priority Signalling,		
CN domain identity	PS domain		

Table 13.4.2.4.3.3-3: RRC CONNECTION REQUEST (step 2, Table 13.4.2.4.3.2-2)

Derivation path: 34.108 default RRC CONNECTION REQUEST in section 9.1.1 for UTRA FDD or 9.1.2 for UTRA TDD			
Information Element	Value/Remark	Comment	Condition
Establishment cause	Terminating High Priority Signalling		
Domain indicator	PS domain		
Pre-redirection info	Present	The presence of this IE indicates the UE support of radio access technologies that the UE could be directed to	
Support of E-UTRA FDD	TRUE		E-UTRA-FDD
Support of E-UTRA TDD	TRUE		E-UTRA-TDD

Table 13.4.2.4.3.3-4: SERVICE REQUEST (step 5, Table 13.4.2.4.3.2-2)

Derivation path: 24.008 table 9.4.20			
Information Element	Value/Remark	Comment	Condition
Service Type	010 (Paging Response)		

Table 13.4.2.4.3.3-5: RRC CONNECTION RELEASE (step 6, Table 13.4.2.4.3.2-2)

Derivation path: 34.108 default RRC CONNECTION RELEASE in section 9.1.1 for UTRA FDD or 9.1.2 for UTRA TDD			
Information Element	Value/Remark	Comment	Condition
N308	1		
Release cause	Directed signalling connection reestablishment		
Redirection info			
Frequency info	Omitted		
Inter-RAT info	E-UTRA		
E-UTRA target info			
E-UTRA Target Frequency Info List	1 Entry		
FDD			E-UTRA-FDD
DL Carrier frequency	The DL Carrier frequency of Cell 1		
Blacklisted cells per freq list	Omitted		
TDD			E-UTRA-TDD
DL Carrier frequency	The DL Carrier frequency of Cell 1		
Blacklisted cells per freq list	Omitted		

13.4.2.5 Inter-system mobility/Service based redirection from GSM/GPRS to E-UTRA

13.4.2.5.1 Test Purpose (TP)

(1)

```
with { UE in GPRS Registered state }
ensure that {
  when { UE is requested to initiate a service based redirection to E-UTRA }
  then { UE performs service based redirection to E-UTRA cell }
}
```

13.4.2.5.2 Conformance requirements

References: The conformance requirements covered in the present TC are specified in: TS 44.060 section 7.4.2

[TS 44.060, section 7.4.2]

The network may initiate the cell change order procedure by sending an IMMEDIATE ASSIGNMENT message for single block assignment in a CCCH block monitored by the mobile station. No TBF shall be established. The single block assignment procedure is specified in 3GPP TS 44.018.

The network shall then send the PACKET CELL CHANGE ORDER message in the assigned downlink block to the mobile station. The PACKET CELL CHANGE ORDER message contains:

- the characteristics of the new cell that are necessary to identify it (i.e. BSIC + BCCH frequency);
- the NC measurement parameters valid for the mobile station in the new cell (NETWORK_CONTROL_ORDER and optionally: NC_NON_DRX_PERIOD, NC_REPORTING_PERIOD_I and NC_REPORTING_PERIOD_T).

For a multi-RAT mobile station supporting UTRAN, the PACKET CELL CHANGE ORDER message may contain information on a UTRAN target cell; in this case, the establishment of channel(s) and subsequent measurement reporting are defined in 3GPP TS 25.331.

For a multi-RAT mobile station supporting “CCN towards E-UTRAN, E-UTRAN Neighbour Cell measurement reporting and Network controlled cell reselection to E-UTRAN”, the PACKET CELL CHANGE ORDER message may contain information on an E-UTRAN target cell; in this case, the establishment of channel(s) and subsequent measurement reporting are defined in 3GPP TS 36.331.

Upon receipt of the PACKET CELL CHANGE ORDER message, the mobile station shall stop all relevant RLC/MAC timers except for timers related to measurement reporting and start timer T3174. The mobile station shall then switch to

the specified new cell and obey the relevant RLC/MAC procedures on this new cell. If a valid RRBP field was received in the PACKET CELL CHANGE ORDER message then the MS shall send a PACKET CONTROL ACKNOWLEDGMENT message in the reserved uplink radio block specified by the RRBP field before switching to the new cell. If the timers related to measurement reporting expire while the reselection procedure has not yet been completed, these timers shall be restarted so that the mobile station resumes the measurement reporting procedures once camped on the new cell. A UTRAN capable mobile station ordered to a UTRAN cell shall obey the PACKET CELL CHANGE ORDER message irrespective of whether or not the target cell is known (see 3GPP TS 25.133 and 3GPP TS 25.123); an E-UTRAN capable mobile station ordered to an E-UTRAN cell shall obey the PACKET CELL CHANGE ORDER message irrespective of whether the target cell is known or not known (see 3GPP TS 36.133).

13.4.2.5.3 Test description

13.4.2.5.3.1 Pre-test conditions

System Simulator:

- Cell 24 is serving GERAN Cell
- Cell 1 is suitable E-UTRAN Cell

UE:

None.

Preamble:

- The UE is in state Generic RB Established, UE test mode activated (state 4) according to [18] using the UE TEST LOOP MODE B and then moved to GPRS packet idle state, with power levels as in Table 13.4.2.5.3.2-1 T0, on Cell 24.

13.4.2.5.3.2 Test procedure sequence

Table 13.4.2.5.3.2-1 illustrates the downlink power levels and other changing parameters to be applied for the cells at various time instants of the test execution. The exact instants on which these values shall be applied are described in the texts in this clause.

Table 13.4.2.5.3.2-1: Time instances of cell power level and parameter changes for E-UTRA cell

	Parameter	Unit	Cell 1	Cell24	Remark
T0	Cell-specific RS EPRE	dBm/15kHz	off	-60	Camping on Cell 24 is guaranteed
T1	Cell-specific RS EPRE	dBm/15kHz	-60	Same as before	The power level is such that $SrxlevCell\ 1 > 0$
Note: $Srxlev$ is calculated in the UE					

Table 13.4.2.5.3.2-2: Main behaviour

St	Procedure	Message Sequence		TP	Verdict
		U - S	Message		
1	The SS changes Cell 1 levels according to the row "T1" in table 13.4.2.5.3.2-1.				
2	SS sends IMMEDIATE ASSIGNMENT	<--	IMMEDIATE ASSIGNMENT	-	-
3	The SS sends PACKET CELL CHANGE ORDER for cell 1 as the target cell on cell 24	<--	PACKET CELL CHANGE ORDER	-	-
4	Steps 1 to 7 of the generic test procedure in TS 36.508 [18] subclause 6.4.2.7A-1 are performed on Cell 1. Note: The UE performs a TAU procedure and a default EPS Bearer is setup.	-	-	.	-
5	The SS transmits one IP packet to the UE on the DRB associated with the default EPS bearer context.	<--	IP packet	-	-
6	Check: Does the UE loop back the IP packet on the DRB associated with the default EPS bearer context?	-->	IP packet	1	P

13.4.2.5.3.3 Specific message contents

Table 13.4.2.5.3.3-2: PACKET CELL CHANGE ORDER (step 5, Table 13.4.2.5.3.2-2)

Information element	Value/remark
< PAGE_MODE : bit (2) >	00 (Normal Paging)
0 10	0
< GLOBAL_TFI : Global TFI IE >	<5 bit Uplink TFI>
0 1	1
Message Escape	00
< IMMEDIATE_REL >	1 (Immediate abort of operation in the old cell is required)
0 1<UTRAN FDD Target cell IE>	0 (not present)
0 1<UTRAN TDD Target cell IE>	0 (not present)
Additions in Rel-5	1
0 1 < G-RNTI extension	0 (not present)
Additions in Rel-8	1
0 1<E-UTRAN Target cell IE>	1
EARFCN	EARFCN of the cell 1
0 1 < Measurement Bandwidth	0 (not present)
Physical Layer Cell identity	PCID of the cell 1
0 1 < Individual Priorities	0 (not present)

Table 13.4.2.5.3.3-3: Message ROUTING AREA UPDATE REQUEST (Preamble)

Derivation Path: Table 9.4.1/3GPP TS 24.008			
Information Element	Value/remark	Comment	Condition
MS Radio Access capability			
GERAN to E-UTRA support in GERAN packet transfer mode	'10'B or '11'B	CCN towards E-UTRAN, E-UTRAN Neighbour Cell measurement reporting and Network controlled cell reselection to E-UTRAN supported	
E-UTRA FDD support	'0'B or '1'B		C1
E-UTRA TDD support	'0'B or '1'B		C1
Note C1: At least one of these fields shall be set to '1'B			

13.4.2.6 Inter-RAT PS Handover / from GPRS Packet_transfer to E-UTRA cell

13.4.2.6.1 Test Purpose (TP)

(1)

```
with { UE in GPRS Registered state with active packet data transfer in NC2 mode }
ensure that {
  when { UE receives a PS HANDOVER COMMAND message configured for a EUTRAN Cell.Blind PS HANDOVER
sceanrio }
  then { UE transmits a RRCConnectionReconfigurationComplete message and performs Tracking Area
update on EUTRAN cell to continue the data transfer }
}
```

13.4.2.6.2 Conformance requirements

References: The conformance requirements covered in the current TC are specified in: TS 43.129, clause 5.3a.

[TS 43.129, clause 5.3a.1]

For performing the inter-RAT handover from GERAN *A/Gb mode* to E-UTRAN the pre-conditions are:

- The MS is in packet transfer mode (GERAN A/Gb mode);
- The MS has at least one PDP Context established;
- The BSS supports PFM (Packet Flow Management) procedures.

[TS 43.129, clause 5.3a.2]

The detailed signalling flows are specified in 3GPP TS 23.401 [33] in sub-clause 5.5.2.4.2.

[TS 43.129, clause 5.3a.3]

The detailed signalling flows are specified in 3GPP TS 23.401 [33] in sub-clause 5.5.2.4.3.

13.4.2.6.3 Test description

13.4.2.6.3.1 Pre-test conditions

System Simulator:

- 2 cells, one GSM and one E-UTRA cell:
 - Cell 24 GSM serving cell
 - Cell 1 suitable neighbour E-UTRA Cell 1 is off.

UE:

None.

Preamble:

- The UE is in state Generic RB Established, UE test mode activated (state 4) according to [18] using the UE TEST LOOP MODE B and then moved to GPRS packet idle state with PDP context 2 activated State according to [23], on Cell 24.

13.4.2.6.3.2 Test procedure sequence

Table 13.4.2.6.3.2-1 illustrates the downlink power levels and other changing parameters to be applied for the cells at various time instants of the test execution. The exact instants on which these values shall be applied are described in the texts in this clause.

Table 13.4.2.6.3.2-1: Time instances of cell power level and parameter changes for E-UTRA cell

Parameter	Unit	Cell 1	Remark
Cell-specific RS EPRE	dBm/15kHz	-70	
Srxlev*	dB	36	
Note: Srxlev is calculated in the UE			

Table 13.4.2.6.3.2-2: Main behaviour

St	Procedure	Message Sequence		TP	Verdict
		U – S	Message		
1	UE is brought into downlink packet transfer mode according to TS 51.010 clause 40.4.3.14 Note: The delay timer for the Test Loop in the preamble is set so that the UE would not loop any packets back before the UE camps on E-UTRA	-	-	-	-
2	SS transmits 1 IP Packet	-	-	-	-
-	EXCEPTION: In parallel to steps 3 to 5 the events described in Table 13.4.2.6.3.2-3 take place	-	-	-	-
3	SS adjusts power level for Cell 1 according to table 13.4.2.6.3.2-1	-	-	-	-
4	The SS transmits PS HANDOVER COMMAND on Cell24	<--	PS HANDOVER COMMAND	-	-
5	Check: Does the UE transmit a <i>RRCCConnectionReconfigurationComplete</i> message on cell 1?	-->	<i>RRCCConnectionReconfigurationComplete</i>	1	P
6	The UE transmits a TRACKING AREA UPDATE REQUEST message to update the registration of the actual tracking area.	-->	RRC: <i>ULInformationTransfer</i> NAS: TRACKING AREA UPDATE REQUEST	-	-
7	The SS transmits a NAS SECURITY MODE COMMAND message to activate NAS security (mapped security context)	<--	RRC: <i>DLInformationTransfer</i> NAS: SECURITY MODE COMMAND	-	-
8	The UE transmits a NAS SECURITY MODE COMPLETE message and establishes the initial security configuration.	-->	RRC: <i>ULInformationTransfer</i> NAS: SECURITY MODE COMPLETE	-	-
9	SS responds with TRACKING AREA UPDATE ACCEPT message.	<--	RRC: <i>DLInformationTransfer</i> NAS: TRACKING AREA UPDATE ACCEPT	-	-
10	Check: Does the UE send a TRACKING AREA UPDATE COMPLETE on the cell specified in the test case?	-->	RRC: <i>ULInformationTransfer</i> NAS: TRACKING AREA UPDATE COMPLETE	-	-
11	The SS transmits an <i>RRCCConnectionRelease</i> message to release RRC connection and move to RRC_IDLE.	<--	RRC: <i>RRCCConnectionRelease</i>	-	-
12	Check: Does the UE loop back the IP packets received when on GERAN on the DRB associated with the default EPS bearer context?	-->	IP Packet	1	P

Table 13.4.2.6.3.2-3: Parallel behaviour

St	Procedure	Message Sequence		TP	Verdict
		U – S	Message		
1	UE is in downlink packet transfer mode and transmits 3 IP Packets	-	-	-	-

13.4.2.6.3.3 Specific message or IE contents

Table 13.4.2.6.3.3-1: PS HANDOVER COMMAND [Table 13.4.2.6.3.2-1, Step 5]

Derivation Path: 44.060, Table 11.2.43.1			
Information Element	Value/remark	Comment	Condition
PAGE MODE	'00'B	Normal Paging	
Global TFI	TFI of the downlink TBF		
CONTAINER_ID	0		
PS Handover to E-UTRAN Payload	'10'B		
RRC Container IE			
RRC_CONTAINER_LENGTH	Length of the container data		
RRC_CONTAINER_DATA			
RRCConnectionReconfiguration message			HO-TO-EUTRA
RRCConnectionReconfiguration ::= SEQUENCE {			Derivation Path: 36.331 clause 6.2.2
rrc-TransactionIdentifier	RRC-TransactionIdentifier-DL		
criticalExtensions CHOICE {			
c1 CHOICE {			
rrcConnectionReconfiguration-r8 SEQUENCE {			
measConfig	Not present		
mobilityControllInfo	MobilityControllInfo		HO-TO-EUTRA Ref Table 13.4.2.6.3.3-2
dedicatedInfoNASList	Not present		
radioResourceConfigDedicated	RadioResourceConfigDedicated-HO-TO-EUTRA(n, m)		HO-TO-EUTRA(n, m)
securityConfigHO	SecurityConfigHO		HO-TO-EUTRA Ref Table 13.4.2.6.3.3-3
nonCriticalExtension SEQUENCE {	Not present		
}			
}			
}			
}			

Table 13.4.2.6.3.3-2: MobilityControllInfo (Table 13.4.2.6.3.3-1)

Derivation Path: 36.508, Table 4.6.5-1			
Information Element	Value/remark	Comment	Condition
MobilityControllInfo			
targetPhysCellId	PhysicalCellId of Cell 1.		
carrierFreq			
dl-CarrierFreq	Same downlink EARFCN as used for Cell 1.		
ul-CarrierFreq	Not present		
carrierBandwidth			
dl-Bandwidth	Downlink system bandwidth under test.		
ul-Bandwidth	Uplink Bandwidth under test.		FDD
ul-Bandwidth	Not present		TDD
additionalSpectrumEmission	1		

Condition	Explanation
FDD	FDD cell environment
TDD	TDD cell environment

Table 13.4.2.6.3.3-3: SecurityConfigHO (Table 13.4.2.6.3.3-1)

Derivation Path: 36.508, Table 4.6.4-1			
Information Element	Value/remark	Comment	Condition
SecurityConfigHO			
handoverType			
interRAT			
securityAlgorithmConfig			
cipheringAlgorithm	Set according to PIXIT parameter for default ciphering protection algorithm		
integrityProtAlgorithm	Set according to PIXIT parameter for default integrity algorithm		
nas-SecurityParamToEUTRA	<p>Octets 1 to 4 are arbitrarily selected.</p> <p>Bits 1 to 3 of octet 5 are set according to PIXIT parameter for default integrity protection algorithm.</p> <p>Bits 5 to 7 of octet 5 are set according to PIXIT parameter for default ciphering algorithm.</p> <p>Bits 1 to 3 of octet 6 are arbitrarily selected between '000'B and '110'B, different from the valid NAS key set identifier of the UE if such a value exists.</p> <p>Bit 4 of octet 6 is set to 1.</p>	<p>Octets 1 to 4 include the NonceMME value.</p> <p>Bits 1 to 3 of octet 5 include the Type of integrity protection algorithm</p> <p>Bits 5 to 7 of octet 5 include the Type of ciphering algorithm.</p> <p>Bits 1 to 4 of octet 6 include the NAS key set identifier.</p>	

Table 13.4.2.6.3.3-3: ACTIVATE TEST MODE (preamble, Table 13.4.2.6.3.2-2)

Derivation Path: 36.508, Table 4.7A-1, condition UE TEST LOOP MODE B
--

Table 13.4.2.6.3.3-4: CLOSE UE TEST LOOP (preamble, Table 13.4.2.6.3.2-2)

Derivation Path: 36.508, Table 4.7A-3, condition UE TEST LOOP MODE B			
Information Element	Value/remark	Comment	Condition
UE test loop mode B LB setup			
IP PDU delay	0 0 0 0 0 1 0 1	5 seconds	

13.4.2.7 Inter-RAT PS Handover / Synchronised / From GPRS Packet_transfer to E-UTRA cell (CCN mode)

13.4.2.7.1 Test Purpose (TP)

(1)

```

with { UE in GPRS Registered state with active packet data transfer in NC1 mode }
ensure that {
  when { UE enters CCN mode by transmitting Packet Cell Change Notification message and subsequently
receives PS HANDOVER COMMAND message configured for already synchronised Target EUTRAN
Cell, indicating CCN support }
    then { UE performs Tracking Area update on EUTRAN cell and continues data transfer }
}

```

13.4.2.7.2 Conformance requirements

References: The conformance requirements covered in the current TC are specified in: TS 43.129, clause 5.3a, TS 44.060, clause 5.5.1.1a.2 and TS 45.008, clause 10.1.4.

[TS 43.129, clause 5.3a.1]

For performing the inter-RAT handover from GERAN *A/Gb mode* to E-UTRAN the pre-conditions are:

- The MS is in packet transfer mode (GERAN *A/Gb mode*);
- The MS has at least one PDP Context established;
- The BSS supports PFM (Packet Flow Management) procedures.

[TS 43.129, clause 5.3a.2]

The detailed signalling flows are specified in 3GPP TS 23.401 [33] in sub-clause 5.5.2.4.2.

[TS 43.129, clause 5.3a.3]

The detailed signalling flows are specified in 3GPP TS 23.401 [33] in sub-clause 5.5.2.4.3.

[TS 44.060, section 5.5.1.1a.2]

A mobile station, which has *CCN Enabled*, can enter *CCN Mode*.

The mobile station shall enable CCN when the following criteria are fulfilled:

- the mobile station is camping on a cell (see 3GPP TS 45.008); and
- the network indicates CCN ACTIVE/3G CCN ACTIVE/E-UTRAN CCN ACTIVE either in system information to all mobile stations in the cell or in an individual order to a certain mobile station; and
- the mobile station is neither in dedicated mode nor Dual Transfer Mode; and
- the mobile station is in NC0 or in NC1 mode; and
- the mobile station is in Packet Transfer mode.

The CCN procedures and the criteria for entering and leaving CCN mode are specified in sub-clauses 8.8.2 and 8.8.3.

[TS 45.008, clause 10.1.4]

The network may request measurement reports from the MS and control its cell re-selection. This is indicated by the parameter NETWORK_CONTROL_ORDER. The meaning of the different parameter values is specified as follows:

...

NC1 MS control with measurement reports
The MS shall send measurement reports to the network as defined in subclause 10.1.4.1.
The MS shall perform autonomous cell re-selection.

13.4.2.7.3 Test description

13.4.2.7.3.1 Pre-test conditions

System Simulator:

- 2 cells, one GSM and one E-UTRA cell:
 - Cell 24 GSM serving cell
 - Cell 1 is suitable neighbour E-UTRAN Cell

UE:

None.

Preamble:

- The UE is in state Generic RB Established, UE test mode activated (state 4) according to [18] using the UE TEST LOOP MODE B and then moved to GPRS packet idle state with PDP context 2 activated State according to [23], on Cell 24.

13.4.2.7.3.2 Test procedure sequence

Table 13.4.2.7.3.2-1 illustrates the downlink power levels and other changing parameters to be applied for the cells at various time instants of the test execution. The exact instants on which these values shall be applied are described in the texts in this clause.

Table 13.4.2.7.3.2-1: Time instances of cell power level and parameter changes for E-UTRA cell

	Parameter	Unit	Cell 1	Cell24	Remark
T1	Cell-specific RS EPRE	dBm/15kHz	-60	No change	The power level is such that SrxlevCell 1 > 0
Note: Srxlev is calculated in the UE					

Table 13.4.2.7.3.2-2: Main behaviour

St	Procedure	Message Sequence		TP	Verdict
		U – S	Message		
1	UE is brought into downlink packet transfer mode according to TS 51.010 clause 40.4.3.14 Note: The delay timer for the Test Loop in the preamble is set so that the UE would not loop any packets back before the UE camps on E-UTRA	-	-	-	-
2	SS transmits 1 IP Packet	-	-	-	-
-	EXCEPTION: In parallel to steps 3 to 7 the events described in Table 13.4.2.7.3.2-3 take place	-	-	-	-
3	UE continues data transfer and send measurement reports for cell 1 in PACKET MEASUREMENT REPORT in parallel to data transfer.	-	-	-	-
4	SS adjusts power level for Cell 1 according to table 13.4.2.7.3.2-1	-	-	-	-
5	UE transmits PACKET CELL CHANGE NOTIFICATION to E_UTRA cell on cell 24. PCCN message should be received with in 15 s after step 3. In parallel the UE continues data transfer and send measurement reports for cell 1 in PACKET MEASUREMENT REPORT.	-->	PACKET CELL CHANGE NOTIFICATION	-	-
6	The SS transmits PS HANDOVER COMMAND on Cell24, with CCN enabled towards target cell.	<--	PS HANDOVER COMMAND	-	-
7	Check: Does the UE transmit a <i>RRCConnectionReconfigurationComplete</i> message on cell 1?	-->	<i>RRCConnectionReconfigurationComplete</i>	1	P
8	The UE transmits a TRACKING AREA UPDATE REQUEST message to update the registration of the actual tracking area.	-->	RRC: <i>ULInformationTransfer</i> NAS: TRACKING AREA UPDATE REQUEST	-	-
9	The SS transmits a NAS SECURITY MODE COMMAND message to activate NAS security (mapped security context)	<--	RRC: <i>DLInformationTransfer</i> NAS: SECURITY MODE COMMAND	-	-
10	The UE transmits a NAS SECURITY MODE COMPLETE message and establishes the initial security configuration.	-->	RRC: <i>ULInformationTransfer</i> NAS: SECURITY MODE COMPLETE	-	-
11	SS responds with TRACKING AREA UPDATE ACCEPT message.	<--	RRC: <i>DLInformationTransfer</i> NAS: TRACKING AREA UPDATE ACCEPT	-	-
12	Check: Does the UE send a TRACKING AREA UPDATE COMPLETE on the cell specified in the test case?	-->	RRC: <i>ULInformationTransfer</i> NAS: TRACKING AREA UPDATE COMPLETE	-	-
13	The SS transmits an <i>RRCConnectionRelease</i> message to release RRC connection and move to RRC_IDLE.	<--	RRC: <i>RRCConnectionRelease</i>	-	-
14	Check: Does the UE loop back the IP packets received when on GERAN on the DRB associated with the default EPS bearer context?	-->	IP Packet	1	P

Table 13.4.2.7.3.2-3: Parallel behaviour

St	Procedure	Message Sequence		TP	Verdict
		U – S	Message		
1	UE is in downlink packet transfer mode and transmits 3 IP Packets	-	-	-	-

13.4.2.7.3.3 Specific message or IE contents

Table 13.4.2.7.3.3-1: Repeated E-UTRAN Neighbour Cells structure of SI2Quater for Cell 24[Preamble]

Derivation Path: 36.508 table 4.4.5-1			
Information Element	Value/remark	Comment	Condition
E-UTRAN Parameters Description	1	Present	
E-UTRAN_CCN_ACTIVE	1	CCN is enabled in the cell	

Table 13.4.2.7.3.3-2: Message ROUTING AREA UPDATE REQUEST(Preamble)

Derivation Path: Table 9.4.1/3GPP TS 24.008			
Information Element	Value/remark	Comment	Condition
MS Radio Access capability			
GERAN to E-UTRA support in GERAN packet transfer mode	'11'B	PS Handover to E-UTRAN supported	

Table 13.4.2.7.3.3-3: PS HANDOVER COMMAND [Table 13.4.2.7.3.2-2, Step 5]

Derivation Path: 44.060, Table 11.2.43.1			
Information Element	Value/remark	Comment	Condition
PAGE MODE	'00'B	Normal Paging	
Global TFI	TFI of the downlink TBF		
CONTAINER_ID	0		
PS Handover to E-UTRAN Payload	'10'B		
RRC Container IE			
RRC_CONTAINER_LENGTH	Length of the container data		
RRC_CONTAINER_DATA			
RRCConnectionReconfiguration message			HO-TO-EUTRA
RRCConnectionReconfiguration ::= SEQUENCE {			Derivation Path: 36.331 clause 6.2.2
rrc-TransactionIdentifier	RRC-TransactionIdentifier-DL		
criticalExtensions CHOICE {			
c1 CHOICE{			
rrcConnectionReconfiguration-r8 SEQUENCE {			
measConfig	Not present		
mobilityControllInfo	MobilityControllInfo		HO-TO-EUTRA Ref Table 13.4.2.7.3.3-4
dedicatedInfoNASList	Not present		
radioResourceConfigDedicated	RadioResourceConfigDedicated-HO-TO-EUTRA(n, m)		HO-TO-EUTRA(n, m)
securityConfigHO	SecurityConfigHO		HO-TO-EUTRA Ref Table 13.4.2.7.3.3-5
nonCriticalExtension SEQUENCE {}	Not present		
}			
}			
}			
}			

Table 13.4.2.7.3.3-4: MobilityControllInfo (Table 13.4.2.7.3.3-3)

Derivation Path: 36.508, Table 4.6.5-1			
Information Element	Value/remark	Comment	Condition
MobilityControllInfo			
targetPhysCellId	PhysicalCellIdentity of Cell 1.		
carrierFreq			
dl-CarrierFreq	Same downlink EARFCN as used for Cell 1.		
ul-CarrierFreq	Not present		
carrierBandwidth			
dl-Bandwidth	Downlink system bandwidth under test.		
ul-Bandwidth	Uplink Bandwidth under test.		FDD
ul-Bandwidth	Not present		TDD
additionalSpectrumEmission	1		

Condition	Explanation
-----------	-------------

FDD	FDD cell environment
TDD	TDD cell environment

Table 13.4.2.7.3.3-5: SecurityConfigHO (Table 13.4.2.7.3.3-3)

Derivation Path: 36.508, Table 4.6.4-1			
Information Element	Value/remark	Comment	Condition
SecurityConfigHO			
handoverType			
interRAT			
securityAlgorithmConfig			
cipheringAlgorithm	Set according to PIXIT parameter for default ciphering protection algorithm		
integrityProtAlgorithm	Set according to PIXIT parameter for default integrity algorithm		
nas-SecurityParamToEUTRA	<p>Octets 1 to 4 are arbitrarily selected.</p> <p>Bits 1 to 3 of octet 5 are set according to PIXIT parameter for default integrity protection algorithm.</p> <p>Bits 5 to 7 of octet 5 are set according to PIXIT parameter for default ciphering algorithm.</p> <p>Bits 1 to 3 of octet 6 are arbitrarily selected between '000'B and '110'B, different from the valid NAS key set identifier of the UE if such a value exists.</p> <p>Bit 4 of octet 6 is set to 1.</p>	<p>Octets 1 to 4 include the NonceMME value.</p> <p>Bits 1 to 3 of octet 5 include the Type of integrity protection algorithm</p> <p>Bits 5 to 7 of octet 5 include the Type of ciphering algorithm.</p> <p>Bits 1 to 4 of octet 6 include the NAS key set identifier.</p>	

Table 13.4.2.7.3.3-6: ACTIVATE TEST MODE (preamble, Table 13.4.2.7.3.2-2)

Derivation Path: 36.508, Table 4.7A-1, condition UE TEST LOOP MODE B
--

Table 13.4.2.7.3.3-7: CLOSE UE TEST LOOP (preamble, Table 13.4.2.7.3.2-2)

Derivation Path: 36.508, Table 4.7A-3, condition UE TEST LOOP MODE B			
Information Element	Value/remark	Comment	Condition
UE test loop mode B LB setup			
IP PDU delay	0 0 0 0 0 1 0 1	5 seconds	

13.4.2.8 Inter-RAT PS Handover / Synchronised / From GPRS Packet_transfer to E-UTRA cell (NC2 mode)

13.4.2.8.1 Test Purpose (TP)

(1)

```
with { UE in GPRS Registered state with active packet data transfer in NC2 mode }
ensure that {
  when { UE receives a PS HANDOVER COMMAND message configured for already synchronised EUTRAN Cell}
```

```

then { UE performs Tracking Area update on EUTRAN cell and continues data transfer }
}

```

13.4.2.8.2 Conformance requirements

References: The conformance requirements covered in the current TC are specified in: TS 43.129, clause 5.3a and TS 45.008 clause 10.1.4.

[TS 43.129, clause 5.3a.1]

For performing the inter-RAT handover from GERAN *A/Gb mode* to E-UTRAN the pre-conditions are:

- The MS is in packet transfer mode (GERAN *A/Gb mode*);
- The MS has at least one PDP Context established;
- The BSS supports PFM (Packet Flow Management) procedures.

[TS 43.129, clause 5.3a.2]

The detailed signalling flows are specified in 3GPP TS 23.401 [33] in sub-clause 5.5.2.4.2.

[TS 43.129, clause 5.3a.3]

The detailed signalling flows are specified in 3GPP TS 23.401 [33] in sub-clause 5.5.2.4.3.

[TS 45.008, clause 10.1.4]

The network may request measurement reports from the MS and control its cell re-selection. This is indicated by the parameter NETWORK_CONTROL_ORDER. The meaning of the different parameter values is specified as follows:

...

NC2	<p>Network control</p> <p>The MS shall send measurement reports to the network as defined in subclause 10.1.4.1.</p> <p>The MS shall only perform autonomous cell re-selection when the reselection is triggered by a downlink signalling failure as defined in subclause 6.5 or a random access failure as defined in 3GPP TS 44.018 and 3GPP TS 44.060 or if the cell is barred or the C1 criterion falls below zero.</p> <p>The MS shall only determine whether the cell is barred once camped on the cell.</p>
-----	--

13.4.2.8.3 Test description

13.4.2.8.3.1 Pre-test conditions

System Simulator:

- 2 cells, one GSM and one E-UTRA cell:
 - Cell 24 GSM serving cell
 - Cell 1 suitable neighbour E-UTRA Cell 1.

UE:

None.

Preamble:

- The UE is in state Generic RB Established, UE test mode activated (state 4) according to [18] using the UE TEST LOOP MODE B and then moved to GPRS packet idle state with PDP context 2 activated State according to [23], on Cell 24.

13.4.2.8.3.2 Test procedure sequence

Table 13.4.2.8.3.2-1 illustrates the downlink power levels and other changing parameters to be applied for the cells at various time instants of the test execution. The exact instants on which these values shall be applied are described in the texts in this clause.

Table 13.4.2.8.3.2-1: Time instances of cell power level and parameter changes for E-UTRA cell

	Parameter	Unit	Cell 1	Cell24	Remark
T1	Cell-specific RS EPRE	dBm/15kHz	-60	No change	The power level is such that $SrxlevCell\ 1 > 0$
Note: Srxlev is calculated in the UE					

Table 13.4.2.8.3.2-2: Main behaviour

St	Procedure	Message Sequence		TP	Verdict
		U – S	Message		
1	UE is brought into downlink packet transfer mode according to TS 51.010 clause 40.4.3.14 Note: The delay timer for the Test Loop in the preamble is set so that the UE would not loop any packets back before the UE camps on E-UTRA	-	-	-	-
2	SS transmits 1 IP Packet	-	-	-	-
-	EXCEPTION: In parallel to steps 3 to 6 the events described in Table 13.4.2.8.3.2-3 take place	-	-	-	-
3	MS continues data transfer and send measurement reports for cell 1 in PACKET MEASUREMENT REPORT in parallel to data transfer.	-	-	-	-
4	SS adjusts power level for Cell 1 according to table 13.4.2.8.3.2-1	-	-	-	-
5	The SS transmits PS HANDOVER COMMAND on Cell24	<--	PS HANDOVER COMMAND	-	-
6	Check: Does the UE transmit a <i>RRCCONNECTIONRECONFIGURATIONCOMPLETE</i> message on cell 1?	-->	<i>RRCCONNECTIONRECONFIGURATIONCOMPLETE</i>	1	P
7	The UE transmits a TRACKING AREA UPDATE REQUEST message to update the registration of the actual tracking area.	-->	RRC: <i>ULInformationTransfer</i> NAS: TRACKING AREA UPDATE REQUEST	-	-
8	The SS transmits a NAS SECURITY MODE COMMAND message to activate NAS security (mapped security context)	<--	RRC: <i>DLInformationTransfer</i> NAS: SECURITY MODE COMMAND	-	-
9	The UE transmits a NAS SECURITY MODE COMPLETE message and establishes the initial security configuration.	-->	RRC: <i>ULInformationTransfer</i> NAS: SECURITY MODE COMPLETE	-	-
10	SS responds with TRACKING AREA UPDATE ACCEPT message.	<--	RRC: <i>DLInformationTransfer</i> NAS: TRACKING AREA UPDATE ACCEPT	-	-
11	Check: Does the UE send a TRACKING AREA UPDATE COMPLETE on the cell specified in the test case?	-->	RRC: <i>ULInformationTransfer</i> NAS: TRACKING AREA UPDATE COMPLETE	-	-
12	The SS transmits an <i>RRCCONNECTIONRELEASE</i> message to release RRC connection and move to RRC_IDLE.	<--	RRC: <i>RRCCONNECTIONRELEASE</i>	-	-
13	Check: Does the UE loop back the IP packets received when on GERAN on the DRB associated with the default EPS bearer context?	-->	IP Packet	1	P

Table 13.4.2.8.3.2-3: Parallel behaviour

St	Procedure	Message Sequence		TP	Verdict
		U – S	Message		

1	UE is in downlink packet transfer mode and transmits 3 IP Packets	-	-	-	-
---	---	---	---	---	---

13.4.2.8.3.3 Specific message or IE contents

Table 13.4.2.8.3.3-1: Message ROUTING AREA UPDATE REQUEST (Preamble)

Derivation Path: Table 9.4.1/3GPP TS 24.008			
Information Element	Value/remark	Comment	Condition
MS Radio Access capability			
GERAN to E-UTRA support in GERAN packet transfer mode	'11'B	PS Handover to E-UTRAN supported	

Table 13.4.2.8.3.3-2: PS HANDOVER COMMAND [Table 13.4.2.8.3.2-2, Step 5]

Derivation Path: 44.060, Table 11.2.43.1			
Information Element	Value/remark	Comment	Condition
PAGE MODE	'00'B	Normal Paging	
Global TFI	TFI of the downlink TBF		
CONTAINER_ID	0		
PS Handover to E-UTRAN Payload	'10'B		
RRC Container IE			
RRC_CONTAINER_LENGTH	Length of the container data		
RRC_CONTAINER_DATA			
RRConnectionReconfiguration message			HO-TO-EUTRA
RRConnectionReconfiguration ::= SEQUENCE {			Derivation Path: 36.331 clause 6.2.2
rrc-TransactionIdentifier	RRC-TransactionIdentifier-DL		
criticalExtensions CHOICE {			
c1 CHOICE{			
rrcConnectionReconfiguration-r8 SEQUENCE {			
measConfig	Not present		
mobilityControlInfo	MobilityControlInfo		HO-TO-EUTRA Ref Table 13.4.2.8.3.3-3
dedicatedInfoNASList	Not present		
radioResourceConfigDedicated	RadioResourceConfigDedicated-HO-TO-EUTRA(n, m)		HO-TO-EUTRA(n, m)
securityConfigHO	SecurityConfigHO		HO-TO-EUTRA Ref Table 13.4.2.8.3.3-4
nonCriticalExtension SEQUENCE {}	Not present		
}			
}			
}			
}			

Table 13.4.2.8.3.3-3: MobilityControllInfo (Table 13.4.2.8.3.3-2)

Derivation Path: 36.508, Table 4.6.5-1			
Information Element	Value/remark	Comment	Condition
MobilityControllInfo			
targetPhysCellId	PhysicalCellId of Cell 1.		
carrierFreq			
dl-CarrierFreq	Same downlink EARFCN as used for Cell 1.		
ul-CarrierFreq	Not present		
carrierBandwidth			
dl-Bandwidth	Downlink system bandwidth under test.		
ul-Bandwidth	Uplink Bandwidth under test.		FDD
ul-Bandwidth	Not present		TDD
additionalSpectrumEmission	1		

Condition	Explanation
FDD	FDD cell environment
TDD	TDD cell environment

Table 13.4.2.8.3.3-4: SecurityConfigHO (Table 13.4.2.8.3.3-2)

Derivation Path: 36.508, Table 4.6.4-1			
Information Element	Value/remark	Comment	Condition
SecurityConfigHO			
handoverType			
interRAT			
securityAlgorithmConfig			
cipheringAlgorithm	Set according to PIXIT parameter for default ciphering protection algorithm		
integrityProtAlgorithm	Set according to PIXIT parameter for default integrity algorithm		
nas-SecurityParamToEUTRA	<p>Octets 1 to 4 are arbitrarily selected.</p> <p>Bits 1 to 3 of octet 5 are set according to PIXIT parameter for default integrity protection algorithm.</p> <p>Bits 5 to 7 of octet 5 are set according to PIXIT parameter for default ciphering algorithm.</p> <p>Bits 1 to 3 of octet 6 are arbitrarily selected between '000'B and '110'B, different from the valid NAS key set identifier of the UE if such a value exists.</p> <p>Bit 4 of octet 6 is set to 1.</p>	<p>Octets 1 to 4 include the NonceMME value.</p> <p>Bits 1 to 3 of octet 5 include the Type of integrity protection algorithm</p> <p>Bits 5 to 7 of octet 5 include the Type of ciphering algorithm.</p> <p>Bits 1 to 4 of octet 6 include the NAS key set identifier.</p>	

Table 13.4.2.8.3.3-5: ACTIVATE TEST MODE (preamble, Table 13.4.2.8.3.2-2)

Derivation Path: 36.508, Table 4.7A-1, condition UE TEST LOOP MODE B

Table 13.4.2.8.3.3-6: CLOSE UE TEST LOOP (preamble, Table 13.4.2.8.3.2-2)

Derivation Path: 36.508, Table 4.7A-3, condition UE TEST LOOP MODE B			
Information Element	Value/remark	Comment	Condition
UE test loop mode B LB setup			
IP PDU delay	0 0 0 0 1 0 1	5 seconds	

13.4.3 Inter-system mobility voice

13.4.3.0 General

Unless stated otherwise in a test case, for all test cases in this clause, the UE shall contain either ISIM and USIM applications or only a USIM application on UICC.

13.4.3.1 Inter-system mobility / E-UTRA voice to UTRA CS voice / SRVCC

13.4.3.1.1 Test Purpose (TP)

(1)

```
with { UE in E-UTRA RRC_CONNECTED state }
ensure that {
  when { UE receives a MobilityFromEUTRACommand message and an IMS voice call is ongoing and an UTRA
  Speech RAB combination is configured for an UTRA cell }
  then { UE transmits a HANDOVER TO UTRAN COMPLETE message on the utra cell }
}
```

13.4.3.1.2 Conformance requirements

References: The conformance requirements covered in the present TC are specified in: TS 36.331, clause 5.4.3.3, TS 23.216, clause 6.2.2. 1 and clause 6.2.2.1A.

[TS 36.331, clause 5.4.3.3]

The UE shall be able to receive a *MobilityFromEUTRACommand* message and perform a cell change order to GERAN, even if no prior UE measurements have been performed on the target cell.

The UE shall:

- 1> stop timer T310, if running;
- 1> if the *MobilityFromEUTRACommand* message includes the *purpose* set to 'handover':
 - 2> if the *targetRAT-Type* is set to 'utra' or 'geran':
 - 3> consider inter-RAT mobility as initiated towards the RAT indicated by the *targetRAT-Type* included in the *MobilityFromEUTRACommand* message;
 - 3> forward the *nas-SecurityParamFromEUTRA* to the upper layers;
 - 3> access the target cell indicated in the inter-RAT message in accordance with the specifications of the target RAT;

[TS 23.216, clause 6.2.2. 1]

Depicted in figure 6.2.2.1-1 is a call flow for SRVCC from E-UTRAN to GERAN without DTM support. The flow requires that eNB can determine that the target is GERAN without DTM support or that the UE is without DTM support.

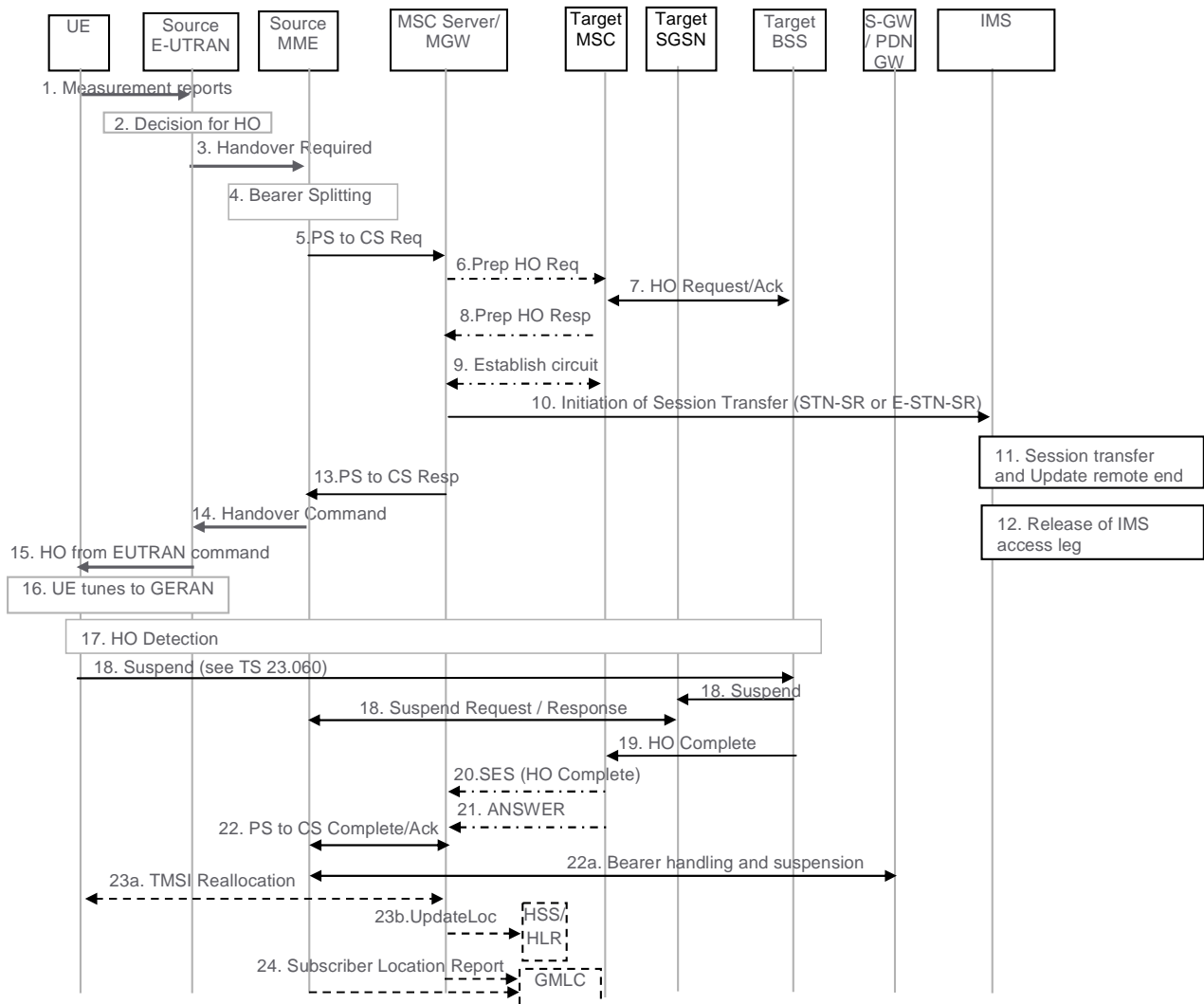

Figure 6.2.2.1-1: SRVCC from E-UTRAN to GERAN without DTM support

1. UE sends measurement reports to E-UTRAN.
2. Based on UE measurement reports the source E-UTRAN decides to trigger an SRVCC handover to GERAN.
3. Source E-UTRAN sends Handover Required (Target ID, generic Source to Target Transparent Container, SRVCC HO Indication) message to the source MME. The E-UTRAN places the "old BSS to new BSS information IE" for the CS domain in the generic Source to Target Transparent Container. The SRVCC HO indication indicates to the MME that target is only CS capable, hence this is a SRVCC handover operation only towards the CS domain. The message includes an indication that the UE is not available for the PS service in the target cell.
4. Based on the QCI associated with the voice bearer (QCI 1) and the SRVCC HO indication, the source MME splits the voice bearer from the non voice bearers and initiates the PS-CS handover procedure for the voice bearer only towards MSC Server.
5. The MME sends a SRVCC PS to CS Request (IMSI, Target ID, STN-SR, C-MSISDN, generic Source to Target Transparent Container, MM Context, Emergency Indication) message to the MSC Server. The Emergency Indication and the equipment identifier are included if the ongoing session is emergency session. Authenticated IMSI and C-MSISDN shall also be included, if available. The MME received STN-SR and C-MSISDN from the HSS as part of the subscription profile downloaded during the E-UTRAN attach procedure. The MM Context contains security related information. CS security key is derived by the MME from the E-UTRAN/EPS domain key as defined in TS 33.401 [22]. The CS Security key is sent in the MM Context.

6. The MSC Server interworks the PS-CS handover request with a CS inter-MSC handover request by sending a Prepare Handover Request message to the target MSC. The MSC Server assigns a default SAI as Source ID on the interface to the target BSS and uses BSSMAP encapsulated for the Prepare Handover Request.

NOTE 1: The value of the default SAI is configured in the MSC and allows a release 8 and later BSC to identify that the source for the SRVCC Handover is E-UTRAN. To ensure correct statistics in the target BSS the default SAI should be different from the SAIs used in UTRAN.

7. Target MSC performs resource allocation with the target BSS by exchanging Handover Request/ Acknowledge messages.
8. Target MSC sends a Prepare Handover Response message to the MSC Server.
9. Establishment of circuit connection between the target MSC and the MGW associated with the MSC Server e.g. using ISUP IAM and ACM messages.
10. For non-emergency session, the MSC Server initiates the Session Transfer by using the STN-SR e.g. by sending an ISUP IAM (STN-SR) message towards the IMS. For emergency session, the MSC Server initiates the Session Transfer by using the locally configured E-STN-SR and by including the equipment identifier. Standard IMS Service Continuity or Emergency IMS Service Continuity procedures are applied for execution of the Session Transfer, see TS 23.237 [14].

NOTE 2: This step can be started after step 8.

NOTE 3: If the MSC Server is using an ISUP interface, then the initiation of the session transfer for non-emergency session may fail if the subscriber profile including CAMEL triggers is not available prior handover (see clause 7.3.2.1.3 in TS 23.292 [13]).

11. During the execution of the Session Transfer procedure the remote end is updated with the SDP of the CS access leg. The downlink flow of VoIP packets is switched towards the CS access leg at this point.
12. Source IMS access leg is released as per TS 23.237 [14].

NOTE 4: Steps 11 and 12 are independent of step 13.

13. MSC Server sends a SRVCC PS to CS Response (Target to Source Transparent Container) message to the source MME.
14. Source MME sends a Handover Command (Target to Source Transparent Container) message to the source E-UTRAN. The message includes information about the voice component only.
15. Source E-UTRAN sends a Handover from E-UTRAN Command message to the UE.
16. UE tunes to GERAN.
17. Handover Detection at the target BSS occurs. The UE sends a Handover Complete message via the target BSS to the target MSC. If the target MSC is not the MSC Server, then the Target MSC sends an SES (Handover Complete) message to the MSC Server.
18. The UE starts the Suspend procedure specified in TS 23.060 [10], clause 16.2.1.1.2. The TLLI and RAI pair are derived from the GUTI as described in TS 23.003 [27]. This triggers the Target SGSN to send a Suspend Notification message to the Source MME. The MME returns a Suspend Acknowledge to the Target SGSN.

NOTE 5: The MME might not be able to derive the GUTI from the received P-TMSI and RAI pair and therefore it might not be able to identify which UE context is associated with the Suspend Notification message. Also in this case the bearers are deactivated and/or suspended as in step 22a.

19. Target BSS sends a Handover Complete message to the target MSC.
20. Target MSC sends an SES (Handover Complete) message to the MSC Server. The speech circuit is through connected in the MSC Server/MGW according to TS 23.009 [18].
21. Completion of the establishment procedure with ISUP Answer message to the MSC Server according to TS 23.009 [18].

22. MSC Server sends a SRVCC PS to CS Complete Notification message to the source MME, informing it that the UE has arrived on the target side. Source MME acknowledges the information by sending a SRVCC PS to CS Complete Acknowledge message to the MSC Server.

22a. The MME deactivates bearers used for voice and other GBR bearers. All GBR bearers are deactivated towards S-GW and P-GW by initiating MME-initiated Dedicated Bearer Deactivation procedure as specified in TS 23.401 [2]. The MME does not send deactivation request toward the eNodeB on receiving PS-to-CS Complete Notification in step 22. PS-to-CS handover indicator is notified to P-GW for voice bearer during the bearer deactivation procedure. For GTP-based S5/S8, the S-GW requests the P-GW to delete all GBR bearer contexts by sending a Delete Bearer Command message. If dynamic PCC is deployed, the P-GW may interact with PCRF as defined in TS 23.203 [31]. For PMIP-based S5/S8, S-GW interacts with the PCRF which in turn updates PCC rules for GBR traffic in the P-GW.

The MME starts preservation and suspension of non-GBR bearers by sending Suspend Notification message towards S-GW. For these non-GBR bearers, the S-GW releases S1-U bearers for the UE and sends Suspend Notification message to the P-GW(s). The MME stores in the UE context that UE is in suspended status. All the preserved non-GBR bearers are marked as suspended status in the S-GW and P-GW. The P-GW should discard packets if received for the suspended UE.

23a. If the HLR is to be updated, i.e. if the IMSI is authenticated but unknown in the VLR, the MSC Server performs a TMSI reallocation towards the UE using its own non-broadcast LAI and, if the MSC Server and other MSC/VLRs serve the same (target) LAI, with its own Network Resource Identifier (NRI).

NOTE 5: The TMSI reallocation is performed by the MSC Server towards the UE via target MSC.

23b. If the MSC Server performed a TMSI reallocation in step 23a, and if this TMSI reallocation was completed successfully, the MSC Server performs a MAP Update Location to the HSS/HLR.

NOTE 6: This Update Location is not initiated by the UE.

24. For an emergency services session after handover is complete, the source MME or the MSC Server may send a Subscriber Location Report carrying the identity of the MSC Server to a GMLC associated with the source or target side, respectively, as defined in TS 23.271 [29] to support location continuity.

NOTE 7: Any configuration of the choice between a source MME versus MSC Server update to a GMLC needs to ensure that a single update occurs from one of these entities when the control plane location solution is used on the source and/or target sides.

After the CS voice call is terminated and if the UE is still in GERAN (or for any other reason specified in TS 24.008), then the UE shall resume PS services as specified in TS 23.060 [10]. A Gn SGSN will follow TS 23.060 [10] to resume the PDP Context(s). An S4 SGSN will follow TS 23.060 [10] to resume the bearers, and will in addition inform S-GW and P-GW(s) to resume the suspended bearers. If the UE has returned to E-UTRAN after the CS voice call was terminated, then the UE shall resume PS service by sending TAU to MME. The MME will in addition inform S-GW and P-GW(s) to resume the suspended bearers. Resuming the suspended bearers in the S-GW and in the P-GW should be done by implicit resume using the Modify Bearer request message if it is triggered by the procedure in operation, e.g. RAU, TAU or Service Request. The S-GW is aware of the suspend state of the bearers and will forward the Modify Bearer request to the P-GW. Explicit resume using the Resume Notification message should be used in cases when Modify Bearer Request is not triggered by the procedure in operation.

[TS 23.216, clause 6.2.2.1A]

The call flow for this scenario is similar to the call flow depicted in figure 6.2.2.1-1, with the exceptions that the Suspend procedure (step 18 and step 22a in figure 6.2.2.1-1) is not performed and that the MME only deactivates bearers used for voice (step 22a in figure 6.2.2.1-1) and sets the PS-to-CS handover indicator. The scenario requires that eNB can determine that the target is either GERAN with DTM but without DTM HO support and that the UE is supporting DTM or that the target is UTRAN (HSPA) without PS HO support. The message in step 3 in figure 6.2.2.1-1 includes an indication to the MME that the UE is available for PS service in the target cell. Furthermore, if the target is GERAN, the E-UTRAN places in the generic Source to Target Transparent Container the "old BSS to new BSS information IE", while if the target is UTRAN, the generic Source to Target Transparent container is encoded according to the Source RNC to Target RNC Transparent Container IE definition. At the end of the procedure described in figure 6.2.2.1-1, the remaining PS resources are re-established when the UE performs the Routeing Area update procedure. Triggers for performing Routeing Area update procedure are described in TS 23.060 [10]. The target SGSN may deactivate the PDP contexts that cannot be established as described in TS 23.060 [10].

13.4.3.1.3 Test description

13.4.3.1.3.1 Pre-test conditions

System Simulator:

- Cell 1 and Cell 5.
- System information combination 4 as defined in TS 36.508 [18] clause 4.4.3.1 is used in E-UTRA cells.

UE:

None.

Preamble:

- The UE is in state Registered, Idle mode (state 2) on Cell 1 according to [18].

13.4.3.1.3.2 Test procedure sequence

Table 13.4.3.1.3.2-1 illustrates the downlink power levels and other changing parameters to be applied for the cells at various time instants of the test execution. Row marked "T0" denotes the initial conditions after preamble, while columns marked "T1" is to be applied subsequently. The exact instants on which these values shall be applied are described in the texts in this clause.

Table 13.4.3.1.3.2-1: Time instances of cell power level and parameter changes

	Parameter	Unit	Cell 1	Cell 5	Remark
T0	Cell-specific RS EPRE	dBm/15k Hz	-60	-	The power level values are such that entering conditions for event B2 are not satisfied.
	CPICH_Ec (UTRA FDD)	dBm/3.8 4 MHz	-	-88	
	PCCPCH_Ec (UTRA LCR TDD)	dBm/1.2 8 MHz	-	-88	
T1	Cell-specific RS EPRE	dBm/15k Hz	-84	-	The power level values are such that entering conditions for event B2 are satisfied.
	CPICH_Ec (UTRA FDD)	dBm/3.8 4 MHz	-	-64	
	PCCPCH_Ec (UTRA LCR TDD)	dBm/1.2 8 MHz	-	-64	

Table 13.4.3.1.3.2-2: Main behaviour

St	Procedure	Message Sequence		TP	Verdict
		U - S	Message		
1	The SS configures UTRA cell 5 to reference configuration according 36.508 table 4.8.3-1, condition UTRA Speech.	-	-	-	-
2-25	Steps 1 to 24 of the generic test procedure for IMS MT speech call (TS 36.508 4.5A.7.3-1).	-	-	-	-
26-27	Void	-	-	-	-
28	The SS transmits an <i>RRConnectionReconfiguration</i> message on Cell 1 to setup inter RAT measurement and reporting for event B2.	<--	<i>RRConnectionReconfiguration</i>	-	-
29	The UE transmits an <i>RRConnectionReconfigurationComplete</i> message on Cell 1.	-->	<i>RRConnectionReconfigurationComplete</i>	-	-
30	The SS changes the power level for Cell 1 and Cell 5 according to the row "T1" in table 13.4.3.1.3.2-1	-	-	-	-
31	The UE transmits a <i>MeasurementReport</i> message on Cell 1 to report event B2 for Cell 5.	-->	<i>MeasurementReport</i>	-	-
31A	The SS transmits a <i>UECapabilityEnquiry</i> message to request UE radio access capability information for E-UTRA and UTRA.	<--	<i>UECapabilityEnquiry</i>	-	-
31B	The UE transmit a <i>UECapabilityInformation</i> message on Cell 1. NOTE: The start-CS values received, should be used to configure ciphering on cell 5.	-->	<i>UECapabilityInformation</i>	-	-
32	The SS transmits a <i>MobilityFromEUTRACommand</i> message on Cell 1.	<--	<i>MobilityFromEUTRACommand</i>	-	-
33	Check: Does the UE transmit a HANDOVER TO UTRAN COMPLETE message on cell 5?	-->	HANDOVER TO UTRAN COMPLETE	1	P
-	EXCEPTION: In parallel to the events described in step 34 to 39 the steps specified in table 13.4.3.1.3.2-5 takes place.	-	-	-	-
34	The SS transmits a SECURITY MODE COMMAND message for the CS domain.	<--	SECURITY MODE COMMAND	-	-
35	The UE transmits a SECURITY MODE COMPLETE message.	-->	SECURITY MODE COMPLETE	-	-
36	The SS transmits an UTRAN MOBILITY INFORMATION message to notify CN information.	<--	UTRAN MOBILITY INFORMATION	-	-
37	The UE transmits an UTRAN MOBILITY INFORMATION CONFIRM message.	-->	UTRAN MOBILITY INFORMATION CONFIRM	-	-
38	The SS transmits a TMSI REALLOCATION COMMAND message.	<--	TMSI REALLOCATION COMMAND	-	-
39	The UE transmits a TMSI REALLOCATION COMPLETE message.	-->	TMSI REALLOCATION COMPLETE	-	-

Table 13.4.3.1.3.2-3: Void

Table 13.4.3.1.3.2-4: Void

Table 13.4.3.1.3.2-5: Parallel behaviour

St	Procedure	Message Sequence		TP	Verdict
		U - S	Message		
1	Check: Does the UE transmit a ROUTING AREA UPDATE REQUEST message?	-->	ROUTING AREA UPDATE REQUEST	-	P
2	The SS transmits a ROUTING AREA UPDATE ACCEPT message.	<--	ROUTING AREA UPDATE ACCEPT	-	-
3	The UE transmits a ROUTING AREA UPDATE COMPLETE message.	-->	ROUTING AREA UPDATE COMPLETE	-	-

13.4.3.1.3.3 Specific message contents

Table 13.4.3.1.3.3-1: ATTACH REQUEST (preamble)

Derivation path: 36.508 table 4.7.2-4			
Information Element	Value/remark	Comment	Condition
MS network capability	SRVCC from UTRAN HSPA or E-UTRAN to GERAN/UTRAN supported		
Mobile station classmark 2	Any allowed value		
Supported Codecs	Any allowed value		

Table 13.4.3.1.3.3-2: *RRCConnectionReconfiguration* (step 28, Table 13.4.3.1.3.2-2)

Derivation Path: 36.508 clause 4.6.1 table 4.6.1-8 with condition MEAS
--

Table 13.4.3.1.3.3-3: *MeasConfig* (step 28, Table 13.4.3.1.3.2-2)

Derivation path: 36.508 clause 4.6.6 table 4.6.6-1 with condition UTRAN			
Information Element	Value/Remark	Comment	Condition
measurementConfiguration ::= SEQUENCE {			
measObjectToAddModifyList SEQUENCE (SIZE (1..maxObjectId)) OF SEQUENCE {	2 entries		
measObjectId[1]	IdMeasObject-f8		
measObject[1]	MeasObjectUTRA-GENERIC(f8)		
measObjectId[2]	IdMeasObject-f1		
measObject[2]	MeasObjectEUTRA-GENERIC(f1)		
}			
reportConfigToAddModifyList SEQUENCE (SIZE (1..maxReportConfigId)) OF SEQUENCE {	1 entry		
reportConfigId[1]	IdReportConfigInterRAT-B2-UTRA		
reportConfig[1]	ReportConfigInterRAT-B2-UTRA (-72, -76)		
}			
measIdToAddModifyList SEQUENCE (SIZE (1..maxMeasId)) OF SEQUENCE {	1 entry		
measId[1]	1		
measObjectId[1]	IdMeasObject-f8		
reportConfigId[1]	IdReportConfigInterRAT-B2-UTRA		
}			

Table 13.4.3.1.3.3-4: MeasurementReport (step 31, Table 13.4.3.1.3.2-2)

Derivation Path: 36.508, table 4.6.1-5			
Information Element	Value/remark	Comment	Condition
MeasurementReport ::= SEQUENCE {			
criticalExtensions CHOICE {			
c1 CHOICE{			
measurementReport-r8 SEQUENCE {			
measResults SEQUENCE {			
measId	1		
measResultServCell SEQUENCE {			
rsrpResult	(0..97)		
rsrqResult	(0..34)		
}			
measResultNeighCells CHOICE {			
measResultListUTRA SEQUENCE (SIZE (1..maxCellReport)) OF SEQUENCE {	1 entry		
physCellId[1]	PhysicalCellIdentity of Cell 5		
cgi-Info[1]	Not present		
measResult[1] SEQUENCE {			
utra-RSCP	(-5..91)		
}			
}			
}			
}			
}			
}			
}			
}			
}			
}			

Table 13.4.3.1.3.3-5: MobilityFromEUTRACommand (step 32, Table 13.4.3.1.3.2-2)

Derivation Path: 36.508, Table 4.6.1-6			
Information Element	Value/remark	Comment	Condition
MobilityFromEUTRACommand ::= SEQUENCE {			
criticalExtensions CHOICE {			
c1 CHOICE{			
mobilityFromEUTRACommand-r8 SEQUENCE {			
cs-FallbackIndicator	True		
purpose CHOICE{			
handover SEQUENCE {			
targetRAT-Type	Utra		
targetRAT-MessageContainer	HANDOVER TO UTRAN COMMAND(UTRA RRC message)		
nas-SecurityParamFromEUTRA	The 4 least significant bits of the NAS downlink COUNT value		
systemInformation	Not present		
}			
}			
}			
}			
}			
}			
}			

Table 13.4.3.1.3.3-6: HANDOVER TO UTRAN COMMAND (step 32, Table 13.4.3.1.3.3-5)

Derivation Path: 36.508, Table 4.7B.1-1, condition UTRA Speech
--

Table 13.4.3.1.3.3-7: UECapabilityEnquiry (step 31A, Table 13.4.3.1.3.2-2)

Derivation path: 36.508 clause 4.6.1 table 4.6.1-22			
Information Element	Value/Remark	Comment	Condition
UECapabilityEnquiry ::= SEQUENCE {			
criticalExtensions CHOICE {			
c1 CHOICE {			
ueCapabilityEnquiry-r8 SEQUENCE {			
ue-CapabilityRequest SEQUENCE (SIZE (1..maxRAT-Capabilities)) OF SEQUENCE {	2 entry		
RAT-Type[1]	eutra		
RAT-Type[2]	utra		
}			
}			
}			
}			
}			

Table 13.4.3.1.3.3-8: SECURITY MODE COMMAND (step 34, Table 13.4.3.1.3.2-2)

Derivation Path: 36.508, Table 4.7B.1-n		
Information Element	Condition	Value/remark
Ciphering mode info		Not Present

Table 13.4.3.1.3.3-9: Void

Table 13.4.3.1.3.3-10: QuantityConfig-DEFAULT-RSCP (Table 13.4.3.1.3.3-3)

Derivation Path: 36.508, Table 4.6.6-3A			
Information Element	Value/remark	Comment	Condition
quantityConfigUTRA SEQUENCE {			
measQuantityUTRA-FDD	cpich-RSCP		
measQuantityUTRA-TDD	pccpch-RSCP		
filterCoefficient	Not present	DEFAULT fc4	
}			

Table 13.4.3.1.3.3-11: ROUTING AREA UPDATE ACCEPT (step 2, Table 13.4.3.1.3.2-5)

Derivation path: 36.508, Table 4.7B.2-2			
Information Element	Value/Remark	Comment	Condition
PDP context status	0	NSAPI(0) - NSAPI(15) is set to 0, which means that the SM state of all PDP contexts is PDP-INACTIVE	

13.4.3.2 Inter-system mobility / E-UTRA PS voice + PS data to UTRA CS voice + PS data / SRVCC

13.4.3.2.1 Test Purpose (TP)

(1)

```

with { UE in E-UTRA RRC_CONNECTED state }
ensure that {
  when { UE receives a MobilityFromEUTRACommand message and an IMS voice call is ongoing and an UTRA PS RB + Speech combination is configured for an UTRA cell }
  then { UE transmits a HANDOVER TO UTRAN COMPLETE message on the utra cell }
}

```

13.4.3.2.2 Conformance requirements

References: The conformance requirements covered in the present TC are specified in: TS 36.331, clause 5.4.3.3 and TS 23.216, clause 6.2.2.2.

[TS 36.331, clause 5.4.3.3]

The UE shall be able to receive a *MobilityFromEUTRACommand* message and perform a cell change order to GERAN, even if no prior UE measurements have been performed on the target cell.

The UE shall:

- 1> stop timer T310, if running;
- 1> if the *MobilityFromEUTRACommand* message includes the *purpose* set to 'handover':
 - 2> if the *targetRAT-Type* is set to 'utra' or 'geran':
 - 3> consider inter-RAT mobility as initiated towards the RAT indicated by the *targetRAT-Type* included in the *MobilityFromEUTRACommand* message;
 - 3> forward the *nas-SecurityParamFromEUTRA* to the upper layers;
 - 3> access the target cell indicated in the inter-RAT message in accordance with the specifications of the target RAT;

[TS 23.216, clause 6.2.2.2]

Depicted in figure 6.2.2.2-1 is a call flow for SRVCC from E-UTRAN to UTRAN or GERAN with DTM HO support, including the handling of the non-voice component. The flow requires that eNB can determine that either the target is UTRAN with PS HO or the target is GERAN with DTM support and the UE is supporting DTM.

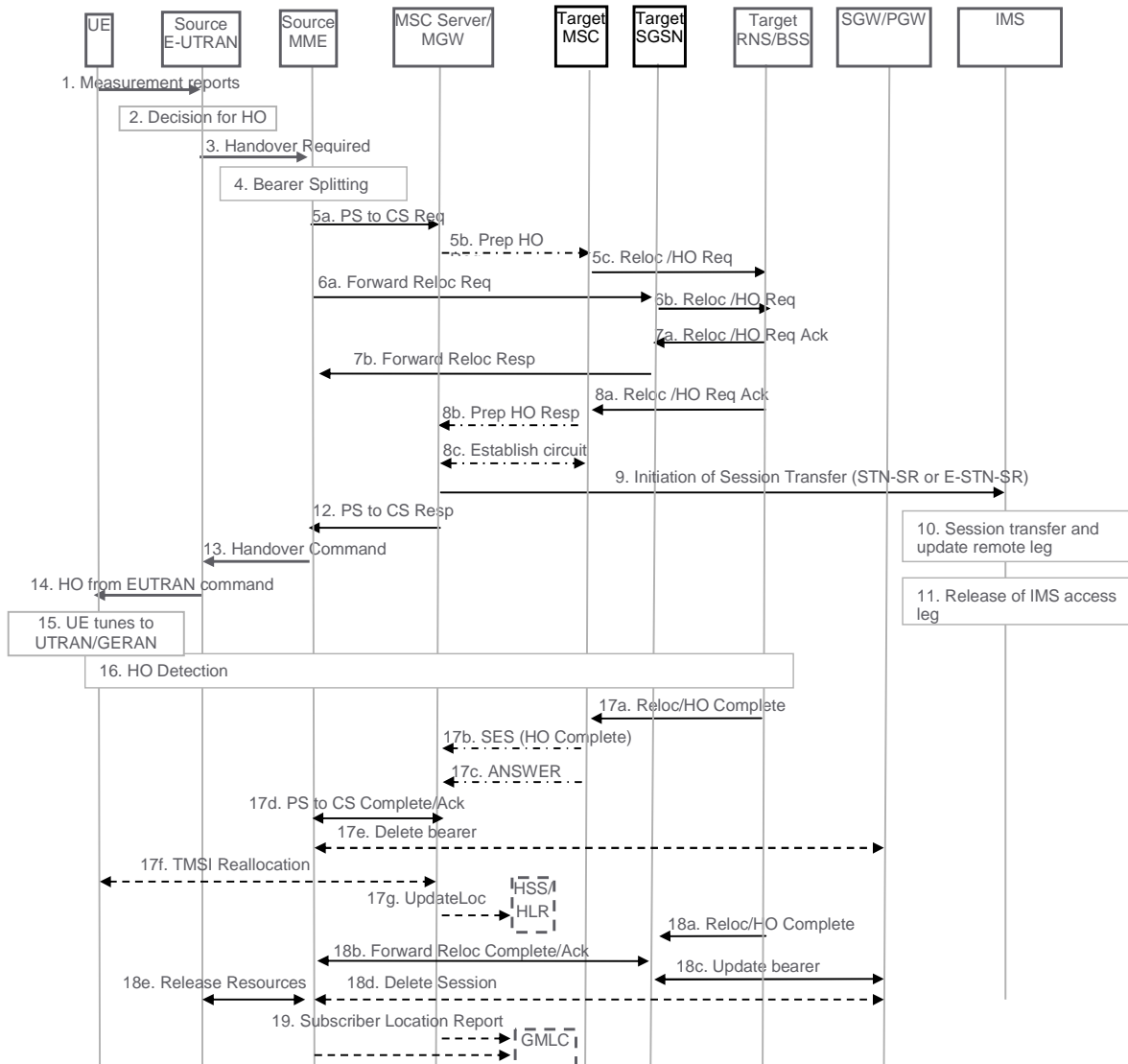

Figure 6.2.2.2-1: SRVCC from E-UTRAN to UTRAN with PS HO or GERAN with DTM HO support

1. UE sends measurement reports to E-UTRAN.
2. Based on UE measurement reports the source E-UTRAN decides to trigger an SRVCC handover to UTRAN/GERAN.
3. If target is UTRAN, the source E-UTRAN sends a Handover Required (Target ID, generic Source to Target Transparent Container, SRVCC HO indication) message to the source MME. SRVCC HO indication indicates to MME that this is for CS+PS HO.

NOTE 1: When the source E-UTRAN indicates using SRVCC HO Indication that target is both CS and PS capable and this is a CS+PS HO request, the source MME sends the single received transparent container to both the target CS domain and the target PS domain.

If target is GERAN, the source E-UTRAN sends a Handover Required (Target ID, generic Source to Target Transparent Container, additional Source to Target Transparent Container, SRVCC HO Indication) message to the source MME. The E-UTRAN places the "old BSS to new BSS information IE" for the CS domain in the additional Source to Target Transparent Container. The differentiation between CS and PS containers is described in TS 36.413 [30]. In this case, the MME identifies from SRVCC HO Indication that this is a request for a CS+PS handover.

4. Based on the QCI associated with the voice bearer (QCI 1) and the SRVCC HO Indication, the source MME splits the voice bearer from all other PS bearers and initiates their relocation towards MSC Server and SGSN, respectively.
- 5a) Source MME initiates the PS-CS handover procedure for the voice bearer by sending a SRVCC PS to CS Request (IMSI, Target ID, STN-SR, C-MSISDN, Source to Target Transparent Container, MM Context, Emergency Indication) message to the MSC Server. The Emergency Indication and the equipment identifier are included if the ongoing session is emergency session. Authenticated IMSI and C-MSISDN shall also be included if available. The message includes information relevant to the CS domain only. MME received STN-SR and C-MSISDN from the HSS as part of the subscription profile downloaded during the E-UTRAN attach procedure. MM Context contains security related information. CS security key is derived by the MME from the E-UTRAN/EPS domain key as defined in TS 33.401 [22]. The CS Security key is sent in the MM Context.
- 5b) MSC Server interworks the PS-CS handover request with a CS inter-MSC handover request by sending a Prepare Handover Request message to the target MSC. If the target system is GERAN, the MSC Server assigns a default SAI as Source ID on the interface to the target BSS and uses BSSMAP encapsulated for the Prepare Handover Request. If the target system is UTRAN, the MSC Server uses RANAP encapsulated for the Prepare Handover Request.

NOTE 2: The value of the default SAI is configured in the MSC and allows a release 8 and later BSC to identify that the source for the SRVCC Handover is E-UTRAN. To ensure correct statistics in the target BSS the default SAI should be different from the SAIs used in UTRAN.

- 5c) Target MSC requests resource allocation for the CS relocation by sending the Relocation Request/Handover Request message to the target RNS/BSS. If the target RAT is UTRAN, Relocation Request/Handover Request message contains the generic Source to Target Transparent Container. If the target RAT is GERAN, Relocation Request/Handover Request message contains the additional Source to Target Transparent Container.
6. In parallel to the previous step the source MME initiates relocation of the PS bearers. The following steps are performed (for details see TS 23.401 [2] clauses 5.5.2.1 and 5.5.2.3):
 - a) Source MME sends a Forward Relocation Request (generic Source to Target Transparent Container, MM Context, PDN Connections IE) message to the target SGSN. If the target SGSN uses S4 based interaction with S-GW and P-GW, the PDN Connections IE includes bearer information for all bearers except the voice bearer. The handling of security keys for PS handover of the remaining non-voice PS bearers is specified in TS 33.401 [22].

NOTE 3: If the target SGSN uses Gn/Gp based interaction with GGSN the Forward Relocation Request will contain PDP Contexts, instead of PDN Connections IE, including bearer information for all bearers except the voice bearer.

- b) Target SGSN requests resource allocation for the PS relocation by sending the Relocation Request/Handover Request (Source to Target Transparent Container) message to the target RNS/BSS.
7. After the target RNS/BSS receives both the CS relocation/handover request with the PS relocation/handover request, it assigns the appropriate CS and PS resources. The following steps are performed:
 - a) Target RNS/BSS acknowledges the prepared PS relocation/handover by sending the Relocation Request Acknowledge/Handover Request Acknowledge (Target to Source Transparent Container) message to the target SGSN.
 - b) Target SGSN sends a Forward Relocation Response (Target to Source Transparent Container) message to the source MME.
8. In parallel to the previous step the following steps are performed:
 - a) Target RNS/BSS acknowledges the prepared CS relocation/handover by sending the Relocation Request Acknowledge/Handover Request Acknowledge (Target to Source Transparent Container) message to the target MSC.
 - b) Target MSC sends a Prepare Handover Response (Target to Source Transparent Container) message to the MSC Server.
 - c) Establishment of circuit connection between the target MSC and the MGW associated with the MSC Server e.g. using ISUP IAM and ACM messages.

NOTE 4: The Target to Source Transparent Container sent to the target SGSN is step 7a and the Target to Source Transparent Container sent to the target MSC in step 8a, include the same allocation of CS and PS resources (e.g. the target BSS includes the same DTM Handover Command in both containers).

9. For non-emergency session, the MSC Server initiates the Session Transfer by using the STN-SR e.g. by sending an ISUP IAM (STN-SR) message towards the IMS. For emergency session, the MSC Server initiates the Session Transfer by using the locally configured E-STN-SR and by including the equipment identifier. Standard IMS Service Continuity or Emergency IMS Service Continuity procedures are applied for execution of the Session Transfer, TS 23.237 [14].

NOTE 5: This step can be started after step 8b.

NOTE 6: If the MSC Server is using an ISUP interface, then the initiation of the session transfer for non-emergency sessions may fail if the subscriber profile including CAMEL triggers is not available prior handover (see clause 7.3.2.1.3 of TS 23.292 [13]).

10. During the execution of the Session Transfer procedure the remote end is updated with the SDP of the CS access leg according to TS 23.237 [14]. The downlink flow of VoIP packets is switched towards the CS access leg at this point.

11. The source IMS access leg is released according to TS 23.237 [14].

NOTE 7: Steps 10 and 11 are independent of step 12.

12. The MSC Server sends a SRVCC PS to CS Response (Target to Source Transparent Container) message to the source MME.

13. Source MME synchronises the two prepared relocations and sends a Handover Command (Target to Source Transparent Container) message to the source E-UTRAN.

NOTE 8: When the target cell is GERAN, the MME may receive different Target to Source Transparent Containers from the MSC Server and from the SGSN, i.e. a "New BSS to Old BSS Information" (see TS 48.008 [23]) may be received from the MSC Server and a "Target BSS to Source BSS Transparent Container" (see TS 48.018 [24]) may be received from the SGSN.

14. E-UTRAN sends a Handover from E-UTRAN Command message to the UE.

15. UE tunes to the target UTRAN/GERAN cell.

16. Handover Detection at the target RNS/BSS occurs. The UE sends a Handover Complete message via the target RNS/BSS to the target MSC. If the target MSC is not the MSC Server, then the Target MSC sends an SES (Handover Complete) message to the MSC Server. At this stage, the UE re-establishes the connection with the network and can send/receive voice data.

17. The CS relocation/handover is complete. The following steps are performed:

- a) Target RNS/BSS sends Relocation Complete/Handover Complete message to the target MSC.
- b) Target MSC sends an SES (Handover Complete) message to the MSC Server. The speech circuit is through connected in the MSC Server/MGW according to TS 23.009 [18].
- c) Completion of the establishment procedure with ISUP Answer message to the MSC Server according to TS 23.009 [18].
- d) MSC Server sends a SRVCC PS to CS Complete Notification message to the source MME. Source MME acknowledges the information by sending a SRVCC PS to CS Complete Acknowledge message to the MSC Server.
- e) The source MME deactivates the voice bearer towards S-GW/P-GW and sets the PS-to-CS handover indicator to Delete Bearer Command message. This triggers MME-initiated Dedicated Bearer Deactivation procedure as specified in TS 23.401 [2]. The MME does not send deactivation request toward the eNodeB on receiving PS-to-CS Complete Notification in step 17d. If dynamic PCC is deployed, the PGW may interact with PCRF as defined in TS 23.203 [31].

- f) If the HLR is to be updated, i.e. if the IMSI is authenticated but unknown in the VLR, the MSC Server performs a TMSI reallocation towards the UE using its own non-broadcast LAI and, if the MSC Server and other MSC/VLRs serve the same (target) LAI, with its own Network Resource Identifier (NRI).

NOTE 9: The TMSI reallocation is performed by the MSC Server towards the UE via target MSC.

- g) If the MSC Server performed a TMSI reallocation in step 17f, and if this TMSI reallocation was completed successfully, the MSC Server performs a MAP Update Location to the HSS/HLR.

NOTE 10: This Update Location is not initiated by the UE.

18. In parallel to the previous step, the PS relocation/handover is completed. The following steps are performed:

- a) Target RNS/BSS sends Relocation Complete/Handover Complete message to target SGSN.
- b) Target SGSN sends a Forward Relocation Complete message to the source MME. After having completed step 17e, the source MME acknowledges the information by sending a Forward Relocation Complete Acknowledge message to the target SGSN.
- c) Target SGSN updates the bearer with S-GW/P-GW/GGSN as specified in TS 23.401 [2].
- d) The MME sends Delete Session Request to the SGW as defined in TS 23.401 [2].
- e) The source MME sends a Release Resources message to the Source eNodeB as defined in TS 23.401 [2]. The Source eNodeB releases its resources related to the UE.

NOTE 11: Routing Area Update procedures by the UE are done in accordance with TS 23.401 [2].

19. For an emergency services session after handover is complete, the source MME or the MSC Server may send a Subscriber Location Report carrying the identity of the MSC Server to a GMLC associated with the source or target side, respectively, as defined in TS 23.271 [29] to support location continuity.

NOTE 12: Any configuration of the choice between a source MME versus MSC Server update to a GMLC needs to ensure that a single update occurs from one of these entities when the control plane location solution is used on the source and/or target sides.

In case the MME determines that only the relocation of the voice bearer but not the relocation of one or more PS bearers succeeds, then the MME proceeds with step 13 after receiving SRVCC PS to CS Response from the MSC Server in step 12 and both UE and MME continue the procedure as described in clause 6.2.2.1A.

13.4.3.2.3 Test description

13.4.3.2.3.1 Pre-test conditions

System Simulator:

- Cell 1 and Cell 5.
- System information combination 4 as defined in TS 36.508 [18] clause 4.4.3.1 is used in E-UTRA cells.

UE:

None.

Preamble:

- The UE is in state Registered, Idle mode (state 2) on Cell 1 according to [18].

13.4.3.2.3.2 Test procedure sequence

Table 13.4.3.2.3.2-1 illustrates the downlink power levels and other changing parameters to be applied for the cells at various time instants of the test execution. Row marked "T0" denotes the initial conditions after preamble, while columns marked "T1" is to be applied subsequently. The exact instants on which these values shall be applied are described in the texts in this clause.

Table 13.4.3.2.3.2-1: Time instances of cell power level and parameter changes

	Parameter	Unit	Cell 1	Cell 5	Remark
T0	Cell-specific RS EPRE	dBm/15k Hz	-60	-	The power level values are such that entering conditions for event B2 are not satisfied.
	CPICH_Ec (UTRA FDD)	dBm/3.8 4 MHz	-	-88	
	PCCPCH_Ec (UTRA LCR TDD)	dBm/1.2 8 MHz	-	-88	
T1	Cell-specific RS EPRE	dBm/15k Hz	-84	-	The power level values are such that entering conditions for event B2 are satisfied.
	CPICH_Ec (UTRA FDD)	dBm/3.8 4 MHz	-	-64	
	PCCPCH_Ec (UTRA LCR TDD)	dBm/1.2 8 MHz	-	-64	

Table 13.4.3.2.3.2-2: Main behaviour

St	Procedure	Message Sequence		TP	Verdict
		U - S	Message		
1	The SS configures UTRA cell 5 to reference configuration according 36.508 table 4.8.3-1, condition UTRA PS RB + Speech.	-	-	-	-
2-25	Steps 1 to 24 of the generic test procedure for IMS MT speech call (TS 36.508 4.5A.7.3-1).	-	-	-	-
26-27	Void				
28	The SS transmits an <i>RRConnectionReconfiguration</i> message on Cell 1 to setup inter RAT measurement and reporting for event B2.	<--	<i>RRConnectionReconfiguration</i>	-	-
29	The UE transmits an <i>RRConnectionReconfigurationComplete</i> message on Cell 1.	-->	<i>RRConnectionReconfigurationComplete</i>	-	-
30	The SS changes the power level for Cell 1 and Cell 5 according to the row "T1" in table 13.4.3.2.3.2-1	-	-	-	-
31	The UE transmits a <i>MeasurementReport</i> message on Cell 1 to report event B2 for Cell 5.	-->	<i>MeasurementReport</i>	-	-
32	The SS transmits a <i>MobilityFromEUTRACommand</i> message on Cell 1.	<--	<i>MobilityFromEUTRACommand</i>	-	-
32A	The SS transmits a <i>UECapabilityEnquiry</i> message to request UE radio access capability information for E-UTRA and UTRA.	<--	<i>UECapabilityEnquiry</i>	-	-
32B	The UE transmit a <i>UECapabilityInformation</i> message on Cell 1. NOTE: The start-CS values received, should be used to configure ciphering on cell 5.	-->	<i>UECapabilityInformation</i>	-	-
33	Check: Does the UE transmit a HANDOVER TO UTRAN COMPLETE message on cell 5?	-->	HANDOVER TO UTRAN COMPLETE	1	P
-	EXCEPTION: In parallel to the events described in step 34 to 39 the steps specified in table 13.4.3.2.3.2-5 takes place.	-	-	-	-
-	EXCEPTION: In parallel to the events described in step 34 to 39 the steps specified in table 13.4.3.2.3.2-6 takes place if requested by the UE.	-	-	-	-
34	The SS transmits a SECURITY MODE COMMAND message for the CS domain.	<--	SECURITY MODE COMMAND	-	-
35	The UE transmits a SECURITY MODE COMPLETE message.	-->	SECURITY MODE COMPLETE	-	-
36	The SS transmits an UTRAN MOBILITY INFORMATION message to notify CN information.	<--	UTRAN MOBILITY INFORMATION	-	-
37	The UE transmits an UTRAN MOBILITY INFORMATION CONFIRM message.	-->	UTRAN MOBILITY INFORMATION CONFIRM	-	-
38	The SS transmits a TMSI REALLOCATION COMMAND message.	<--	TMSI REALLOCATION COMMAND	-	-
39	The UE transmits a TMSI REALLOCATION COMPLETE message.	-->	TMSI REALLOCATION COMPLETE	-	-

Table 13.4.3.2.3.2-3: Void

Table 13.4.3.2.3.2-4: Void

Table 13.4.3.2.3.2-5: Parallel behaviour

St	Procedure	Message Sequence		TP	Verdict
		U - S	Message		
1	Check: Does the UE transmit a ROUTING AREA UPDATE REQUEST message?	-->	ROUTING AREA UPDATE REQUEST	-	P
2	The SS transmits a ROUTING AREA UPDATE ACCEPT message.	<--	ROUTING AREA UPDATE ACCEPT	-	-
3	The UE transmits a ROUTING AREA UPDATE COMPLETE message.	-->	ROUTING AREA UPDATE COMPLETE	-	-

Table 13.4.3.2.3.2-6: Parallel behaviour

St	Procedure	Message Sequence		TP	Verdict
		U - S	Message		
1-4	Steps 1-4 defined in annex C.24 of TS 34.229-1 [35]. SRVCC media removal.	-	-	-	-

13.4.3.2.3.3 Specific message contents

Table 13.4.3.2.3.3-1: ATTACH REQUEST (preamble)

Derivation path: 36.508 table 4.7.2-4			
Information Element	Value/remark	Comment	Condition
MS network capability	SRVCC from UTRAN HSPA or E-UTRAN to GERAN/UTRAN supported		
Mobile station classmark 2	Any allowed value		
Supported Codecs	Any allowed value		

Table 13.4.3.2.3.3-2: *RRCConnectionReconfiguration* (step 28, Table 13.4.3.2.3.2-2)

Derivation Path: 36.508 clause 4.6.1 table 4.6.1-8 with condition MEAS
--

Table 13.4.3.2.3.3-3: MeasConfig (step 28, Table 13.4.3.2.3.2-2)

Derivation path: 36.508 clause 4.6.6 table 4.6.6-1 with condition UTRAN			
Information Element	Value/Remark	Comment	Condition
measurementConfiguration ::= SEQUENCE {			
measObjectToAddModifyList SEQUENCE (SIZE (1..maxObjectId)) OF SEQUENCE {	2 entries		
measObjectId[1]	IdMeasObject-f8		
measObject[1]	MeasObjectUTRA-GENERIC(f8)		
measObjectId[2]	IdMeasObject-f1		
measObject[2]	MeasObjectEUTRA-GENERIC(f1)		
}			
reportConfigToAddModifyList SEQUENCE (SIZE (1..maxReportConfigId)) OF SEQUENCE {	1 entry		
reportConfigId[1]	IdReportConfigInterRAT-B2-UTRA		
reportConfig[1]	ReportConfigInterRAT-B2-UTRA (-72, -76)		
}			
measIdToAddModifyList SEQUENCE (SIZE (1..maxMeasId)) OF SEQUENCE {	1 entry		
measId[1]	1		
measObjectId[1]	IdMeasObject-f8		
reportConfigId[1]	IdReportConfigInterRAT-B2-UTRA		
}			
}			

Table 13.4.3.2.3.3-4: MeasurementReport (step 31, Table 13.4.3.2.3.2-2)

Derivation Path: 36.508, table 4.6.1-5			
Information Element	Value/remark	Comment	Condition
MeasurementReport ::= SEQUENCE {			
criticalExtensions CHOICE {			
c1 CHOICE{			
measurementReport-r8 SEQUENCE {			
measResults SEQUENCE {			
measId	1		
measResultServCell SEQUENCE {			
rsrpResult	(0..97)		
rsrqResult	(0..34)		
}			
measResultNeighCells CHOICE {			
measResultListUTRA SEQUENCE (SIZE (1..maxCellReport)) OF SEQUENCE {	1 entry		
physCellId[1]	PhysicalCellIdentity of Cell 5		
cgi-Info[1]	Not present		
measResult[1] SEQUENCE {			
utra-RSCP	(-5..91)		
}			
}			
}			
}			
}			
}			
}			

Table 13.4.3.2.3.3-5: MobilityFromEUTRACommand (step 32, Table 13.4.3.2.3.2-2)

Derivation Path: 36.508, Table 4.6.1-6			
Information Element	Value/remark	Comment	Condition
MobilityFromEUTRACommand ::= SEQUENCE {			
criticalExtensions CHOICE {			
c1 CHOICE{			
mobilityFromEUTRACommand-r8 SEQUENCE {			
cs-FallbackIndicator	True		
purpose CHOICE{			
handover SEQUENCE {			
targetRAT-Type	Utra		
targetRAT-MessageContainer	HANDOVER TO UTRAN COMMAND(UTRA RRC message)		
nas-SecurityParamFromEUTRA	The 4 least significant bits of the NAS downlink COUNT value		
systemInformation	Not present		
}			
}			
}			
}			
}			
}			
}			

Table 13.4.3.2.3.3-6: HANDOVER TO UTRAN COMMAND (step 32, Table 13.4.3.2.3.3-5)

Derivation Path: 36.508, Table 4.7B.1-1, condition [UTRA Speech + Packet RAB Setup after Speech RAB Setup in CELL_DCH](#)

Table 13.4.3.2.3.3-7: UECapabilityEnquiry (step 32A, Table 13.4.3.2.3.2-2)

Derivation path: 36.508 clause 4.6.1 table 4.6.1-22			
Information Element	Value/Remark	Comment	Condition
UECapabilityEnquiry ::= SEQUENCE {			
criticalExtensions CHOICE {			
c1 CHOICE {			
ueCapabilityEnquiry-r8 SEQUENCE {			
ue-CapabilityRequest SEQUENCE (SIZE (1..maxRAT-Capabilities)) OF SEQUENCE {	2 entry		
RAT-Type[1]	eutra		
RAT-Type[2]	utra		
}			
}			
}			
}			
}			

Table 13.4.3.2.3.3-8: SECURITY MODE COMMAND (step 34, Table 13.4.3.2.3.2-2)

Derivation Path: 36.508, Table 4.7B.1-n		
Information Element	Condition	Value/remark
Ciphering mode info		Not Present

Table 13.4.3.2.3.3-9: Void**Table 13.4.3.2.3.3-10: Void****13.4.3.3 Inter-system mobility / E-UTRA voice to GSM CS voice / SRVCC****13.4.3.3.1 Test Purpose (TP)**

(1)

```

with { UE in E-UTRA RRC_CONNECTED state }
ensure that {
  when { UE receives a MobilityFromEUTRACommand message and an IMS voice call is ongoing and an
GERAN Speech RAB combination is configured for an GERAN cell}
  then { UE transmits a HANDOVER COMPLETE message on the geran cell}
}

```

13.4.3.3.2 Conformance requirements

References: The conformance requirements covered in the present TC are specified in: TS 36.331, clause 5.4.3.3 and TS 23.216, clause 6.2.2.1.

[TS 36.331, clause 5.4.3.3]

The UE shall be able to receive a *MobilityFromEUTRACommand* message and perform a cell change order to GERAN, even if no prior UE measurements have been performed on the target cell.

The UE shall:

- 1> stop timer T310, if running;
- 1> if the *MobilityFromEUTRACommand* message includes the *purpose* set to 'handover':
 - 2> if the *targetRAT-Type* is set to 'utra' or 'geran':
 - 3> consider inter-RAT mobility as initiated towards the RAT indicated by the *targetRAT-Type* included in the *MobilityFromEUTRACommand* message;
 - 3> forward the *nas-SecurityParamFromEUTRA* to the upper layers;
 - 3> access the target cell indicated in the inter-RAT message in accordance with the specifications of the target RAT;

[TS 23.216, clause 6.2.2.1]

Depicted in figure 6.2.2.1-1 is a call flow for SRVCC from E-UTRAN to GERAN without DTM support. The flow requires that eNB can determine that the target is GERAN without DTM support or that the UE is without DTM support.

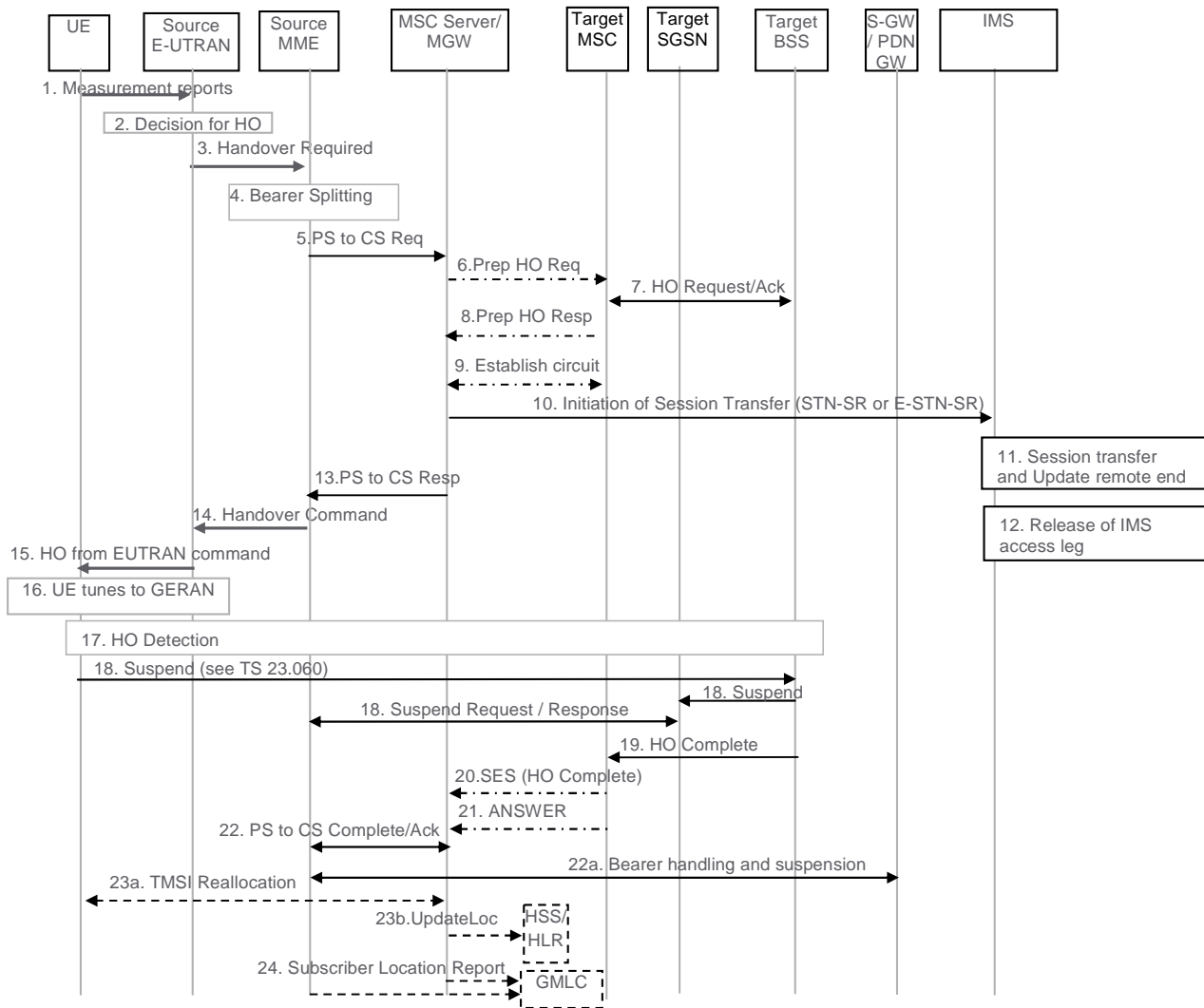

Figure 6.2.2.1-1: SRVCC from E-UTRAN to GERAN without DTM support

1. UE sends measurement reports to E-UTRAN.
2. Based on UE measurement reports the source E-UTRAN decides to trigger an SRVCC handover to GERAN.
3. Source E-UTRAN sends Handover Required (Target ID, generic Source to Target Transparent Container, SRVCC HO Indication) message to the source MME. The E-UTRAN places the "old BSS to new BSS information IE" for the CS domain in the generic Source to Target Transparent Container. The SRVCC HO indication indicates to the MME that target is only CS capable, hence this is a SRVCC handover operation only towards the CS domain. The message includes an indication that the UE is not available for the PS service in the target cell.
4. Based on the QCI associated with the voice bearer (QCI 1) and the SRVCC HO indication, the source MME splits the voice bearer from the non voice bearers and initiates the PS-CS handover procedure for the voice bearer only towards MSC Server.
5. The MME sends a SRVCC PS to CS Request (IMSI, Target ID, STN-SR, C-MSISDN, generic Source to Target Transparent Container, MM Context, Emergency Indication) message to the MSC Server. The Emergency Indication and the equipment identifier are included if the ongoing session is emergency session. Authenticated IMSI and C-MSISDN shall also be included, if available. The MME received STN-SR and C-MSISDN from the HSS as part of the subscription profile downloaded during the E-UTRAN attach procedure. The MM Context contains security related information. CS security key is derived by the MME from the E-UTRAN/EPS domain key as defined in TS 33.401 [22]. The CS Security key is sent in the MM Context.

6. The MSC Server interworks the PS-CS handover request with a CS inter-MSC handover request by sending a Prepare Handover Request message to the target MSC. The MSC Server assigns a default SAI as Source ID on the interface to the target BSS and uses BSSMAP encapsulated for the Prepare Handover Request.

NOTE 1: The value of the default SAI is configured in the MSC and allows a release 8 and later BSC to identify that the source for the SRVCC Handover is E-UTRAN. To ensure correct statistics in the target BSS the default SAI should be different from the SAIs used in UTRAN.

7. Target MSC performs resource allocation with the target BSS by exchanging Handover Request/ Acknowledge messages.
8. Target MSC sends a Prepare Handover Response message to the MSC Server.
9. Establishment of circuit connection between the target MSC and the MGW associated with the MSC Server e.g. using ISUP IAM and ACM messages.
10. For non-emergency session, the MSC Server initiates the Session Transfer by using the STN-SR e.g. by sending an ISUP IAM (STN-SR) message towards the IMS. For emergency session, the MSC Server initiates the Session Transfer by using the locally configured E-STN-SR and by including the equipment identifier. Standard IMS Service Continuity or Emergency IMS Service Continuity procedures are applied for execution of the Session Transfer, see TS 23.237 [14].

NOTE 2: This step can be started after step 8.

NOTE 3: If the MSC Server is using an ISUP interface, then the initiation of the session transfer for non-emergency session may fail if the subscriber profile including CAMEL triggers is not available prior handover (see clause 7.3.2.1.3 in TS 23.292 [13]).

11. During the execution of the Session Transfer procedure the remote end is updated with the SDP of the CS access leg. The downlink flow of VoIP packets is switched towards the CS access leg at this point.
12. Source IMS access leg is released as per TS 23.237 [14].

NOTE 4: Steps 11 and 12 are independent of step 13.

13. MSC Server sends a SRVCC PS to CS Response (Target to Source Transparent Container) message to the source MME.
14. Source MME sends a Handover Command (Target to Source Transparent Container) message to the source E-UTRAN. The message includes information about the voice component only.
15. Source E-UTRAN sends a Handover from E-UTRAN Command message to the UE.
16. UE tunes to GERAN.
17. Handover Detection at the target BSS occurs. The UE sends a Handover Complete message via the target BSS to the target MSC. If the target MSC is not the MSC Server, then the Target MSC sends an SES (Handover Complete) message to the MSC Server.
18. The UE starts the Suspend procedure specified in TS 23.060 [10], clause 16.2.1.1.2. The TLLI and RAI pair are derived from the GUTI as described in TS 23.003 [27]. This triggers the Target SGSN to send a Suspend Notification message to the Source MME. The MME returns a Suspend Acknowledge to the Target SGSN.

NOTE 5: The MME might not be able to derive the GUTI from the received P-TMSI and RAI pair and therefore it might not be able to identify which UE context is associated with the Suspend Notification message. Also in this case the bearers are deactivated and/or suspended as in step 22a.

19. Target BSS sends a Handover Complete message to the target MSC.
20. Target MSC sends an SES (Handover Complete) message to the MSC Server. The speech circuit is through connected in the MSC Server/MGW according to TS 23.009 [18].
21. Completion of the establishment procedure with ISUP Answer message to the MSC Server according to TS 23.009 [18].

22. MSC Server sends a SRVCC PS to CS Complete Notification message to the source MME, informing it that the UE has arrived on the target side. Source MME acknowledges the information by sending a SRVCC PS to CS Complete Acknowledge message to the MSC Server.

22a. The MME deactivates bearers used for voice and other GBR bearers. All GBR bearers are deactivated towards S-GW and P-GW by initiating MME-initiated Dedicated Bearer Deactivation procedure as specified in TS 23.401 [2]. The MME does not send deactivation request toward the eNodeB on receiving PS-to-CS Complete Notification in step 22. PS-to-CS handover indicator is notified to P-GW for voice bearer during the bearer deactivation procedure. For GTP-based S5/S8, the S-GW requests the P-GW to delete all GBR bearer contexts by sending a Delete Bearer Command message. If dynamic PCC is deployed, the P-GW may interact with PCRF as defined in TS 23.203 [31]. For PMIP-based S5/S8, S-GW interacts with the PCRF which in turn updates PCC rules for GBR traffic in the P-GW.

The MME starts preservation and suspension of non-GBR bearers by sending Suspend Notification message towards S-GW. For these non-GBR bearers, the S-GW releases S1-U bearers for the UE and sends Suspend Notification message to the P-GW(s). The MME stores in the UE context that UE is in suspended status. All the preserved non-GBR bearers are marked as suspended status in the S-GW and P-GW. The P-GW should discard packets if received for the suspended UE.

23a. If the HLR is to be updated, i.e. if the IMSI is authenticated but unknown in the VLR, the MSC Server performs a TMSI reallocation towards the UE using its own non-broadcast LAI and, if the MSC Server and other MSC/VLRs serve the same (target) LAI, with its own Network Resource Identifier (NRI).

NOTE 5: The TMSI reallocation is performed by the MSC Server towards the UE via target MSC.

23b. If the MSC Server performed a TMSI reallocation in step 23a, and if this TMSI reallocation was completed successfully, the MSC Server performs a MAP Update Location to the HSS/HLR.

NOTE 6: This Update Location is not initiated by the UE.

24. For an emergency services session after handover is complete, the source MME or the MSC Server may send a Subscriber Location Report carrying the identity of the MSC Server to a GMLC associated with the source or target side, respectively, as defined in TS 23.271 [29] to support location continuity.

NOTE 7: Any configuration of the choice between a source MME versus MSC Server update to a GMLC needs to ensure that a single update occurs from one of these entities when the control plane location solution is used on the source and/or target sides.

13.4.3.3.3 Test description

13.4.3.3.3.1 Pre-test conditions

System Simulator:

- Cell 1 and Cell 24.
- System information combination 5 as defined in TS 36.508 [18] clause 4.4.3.1 is used in E-UTRA cells.

UE:

None.

Preamble:

- The UE is in state Registered, Idle mode (state 2) on Cell 1 according to [18].

13.4.3.3.3.2 Test procedure sequence

Table 13.4.3.3.3.2-1 illustrates the downlink power levels and other changing parameters to be applied for the cells at various time instants of the test execution. Row marked "T0" denotes the initial conditions after preamble, while columns marked "T1" is to be applied subsequently. The exact instants on which these values shall be applied are described in the texts in this clause.

Table 13.4.3.3.2-1: Time instances of cell power level and parameter changes

	Parameter	Unit	Cell 1	Cell 24	Remark
T0	Cell-specific RS EPRE	dBm/15k Hz	-85	-	The power level values are such that entering conditions for event B2 are not satisfied.
	RSSI	dBm	-	-85	
T1	Cell-specific RS EPRE	dBm/15k Hz	-100	-	The power level values are such that entering conditions for event B2 are satisfied.
	RSSI	dBm	-	-65	

Table 13.4.3.3.2-2: Main behaviour

St	Procedure	Message Sequence		TP	Verdict
		U - S	Message		
1-26	Steps 1 to 26 of the generic test procedure for IMS MT speech call (TS 36.508 4.5A.7.3-1).	-	-	-	-
27	The SS transmits an <i>RRCCONNECTIONRECONFIGURATION</i> message on Cell 1 to setup inter RAT measurement and reporting for event B2.	<--	<i>RRCCONNECTIONRECONFIGURATION</i>	-	-
28	The UE transmits an <i>RRCCONNECTIONRECONFIGURATIONCOMPLETE</i> message on Cell 1.	-->	<i>RRCCONNECTIONRECONFIGURATIONCOMPLETE</i>	-	-
29	The SS changes the power level for Cell 1 and Cell 5 according to the row "T1" in table 13.4.3.3.2-1	-	-	-	-
30	The UE transmits a <i>MEASUREMENTREPORT</i> message on Cell 1 to report event B2 for Cell 24.	-->	<i>MEASUREMENTREPORT</i>	-	-
31	The SS transmits a <i>MOBILITYFROMEUTRACOMMAND</i> message on Cell 1.	<--	<i>MOBILITYFROMEUTRACOMMAND</i>	-	-
32	Check: Does the UE transmit a HANOVER COMPLETE message on cell 24?	-->	HANOVER COMPLETE	1	P
33	The UE transmits a GPRS SUSPENSION REQUEST message	-->	GPRS SUSPENSION REQUEST	-	-
34	The SS transmits a TMSI REALLOCATION COMMAND message.	<--	TMSI REALLOCATION COMMAND	-	-
35	The UE transmits a TMSI REALLOCATION COMPLETE message.	-->	TMSI REALLOCATION COMPLETE	-	-

Table 13.4.3.3.2-4: Void

13.4.3.3.3 Specific message contents

Table 13.4.3.3.3-1: ATTACH REQUEST (preamble)

Derivation path: 36.508 table 4.7.2-4			
Information Element	Value/remark	Comment	Condition
MS network capability	SRVCC from UTRAN HSPA or E-UTRAN to GERAN/UTRAN supported		
Mobile station classmark 2	Any allowed value		
Supported Codecs	Any allowed value		

Table 13.4.3.3.3-2: *RRCCONNECTIONRECONFIGURATION* (step 27, Table 13.4.3.3.2-2)

Derivation Path: 36.508 clause 4.6.1 table 4.6.1-8 with condition MEAS
--

Table 13.4.3.3.3-3: MeasConfig (step 27, Table 13.4.3.3.2-2)

Derivation path: 36.508 clause 4.6.6 table 4.6.6-1 with condition GERAN			
Information Element	Value/Remark	Comment	Condition
measurementConfiguration ::= SEQUENCE {			
measObjectToAddModifyList SEQUENCE (SIZE (1..maxObjectId)) OF SEQUENCE {	2 entries		
measObjectId[1]	IdMeasObject-f11		
measObject[1]	MeasObjectGERAN-GENERIC(f11)		
measObjectId[2]	IdMeasObject-f1		
measObject[2]	MeasObjectEUTRA-GENERIC(f1)		
}			
reportConfigToAddModifyList SEQUENCE (SIZE (1..maxReportConfigId)) OF SEQUENCE {	1 entry		
reportConfigId[1]	IdReportConfigInterRAT-B2-GERAN		
reportConfig[1]	ReportConfigInterRAT-B2-GERAN (-90, -100)		
}			
measIdToAddModifyList SEQUENCE (SIZE (1..maxMeasId)) OF SEQUENCE {	1 entry		
measId[1]	1		
measObjectId[1]	IdMeasObject-f8		
reportConfigId[1]	IdReportConfigInterRAT-B2-GERAN		
}			
}			

Table 13.4.3.3.3-4: MeasurementReport (step 30, Table 13.4.3.3.2-2)

Derivation Path: 36.508, table 4.6.1-5			
Information Element	Value/remark	Comment	Condition
MeasurementReport ::= SEQUENCE {			
criticalExtensions CHOICE {			
c1 CHOICE{			
measurementReport-r8 SEQUENCE {			
measResults SEQUENCE {			
measId	1		
measResultServCell SEQUENCE {			
rsrpResult	(0..97)		
rsrqResult	(0..34)		
}			
measResultNeighCells CHOICE {			
measResultListGERAN SEQUENCE (SIZE (1..maxCellReport)) OF SEQUENCE {	1 entry		
physCellId	PhysicalCellIdentity of Cell 24		
cgi-Info[1]	Not present		
measResult[1] SEQUENCE {			
rssi	The value of rssi is present but contents not checked		
}			
}			
}			
}			
}			
}			

Table 13.4.3.3.3-5: *MobilityFromEUTRACommand* (step 31, Table 13.4.3.3.2-2)

Derivation Path: 36.508, Table 4.6.1-6			
Information Element	Value/remark	Comment	Condition
MobilityFromEUTRACommand ::= SEQUENCE {			
criticalExtensions CHOICE {			
c1 CHOICE{			
mobilityFromEUTRACommand-r8 SEQUENCE {			
cs-FallbackIndicator	True		
purpose CHOICE{			
handover SEQUENCE {			
targetRAT-Type	geran		
targetRAT-MessageContainer	HANDOVER COMMAND(GERAN RRC message), see Table 13.4.3.3.3-6		
nas-SecurityParamFromEUTRA	The 4 least significant bits of the NAS downlink COUNT value		
systemInformation	Not present		
}			
}			
}			
}			

Table 13.4.3.3.3-6: HANDOVER COMMAND (step 31, Table 13.4.3.3.2-2)

Derivation Path: 51.010, Table 40.2.4.33			
Information Element	Value/remark	Comment	Condition
Cell Description			
Network Colour Code	1		
Base Station Colour Code	5		
BCCH Carrier Number	The BCCH Carrier ARFCN as per table in clause 40.1.1 of 51.010- 1.		
Description of the First Channel, after time			
Channel Description			
Channel Type and TDMA offset	TCH/F + ACCH's		
Timeslot Number	Chosen arbitrarily, but not Zero.		
Training Sequence Code	Same as the BCCH		
Hopping channel	Single RF channel		
ARFCN	The first ARFCN in the cell allocation as per table in clause 40.2.1.1.1 of 51.010-1		
Cipher Mode Setting	1001xxxy	See TS 44.018 §9.1.15.10 xxx - px_GSM_CipherAl g y - px_GSM_Cipherin gOnOff	

13.4.3.4 Inter-system mobility / E-UTRA voice to UTRA CS voice / Unsuccessful case / Retry on old cell / SRVCC

13.4.3.4.1 Test Purpose (TP)

(1)

```
with { UE in E-UTRA RRC_CONNECTED state }
ensure that {
  when { UE receives a MobilityFromEUTRACommand message and an IMS voice call is ongoing and the UE
  does not succeed in establishing the connection to the target radio access technology }
  then { UE initiates the connection re-establishment procedure }
}
```

13.

(2)

```
with { UE in E-UTRA RRC_CONNECTED state }
ensure that {
  when { UE successfully completes the RRC Connection re-establishment procedure }
  then { UE is in E-UTRA RRC_CONNECTED state }
}
```

4.3.4.2 Conformance requirements

References: The conformance requirements covered in the present TC are specified in: TS 36.331, clause 5.4.3.3, 5.4.3.5, 5.3.7.2, 5.3.7.3, 5.3.7.4, 5.3.7.5, TS 23.216, clause 6.2.2. 1 and 6.2.2.1A.

[TS 36.331, clause 5.4.3.3]

The UE shall be able to receive a *MobilityFromEUTRACommand* message and perform a cell change order to GERAN, even if no prior UE measurements have been performed on the target cell.

The UE shall:

- 1> stop timer T310, if running;
- 1> if the *MobilityFromEUTRACommand* message includes the *purpose* set to 'handover':
 - 2> if the *targetRAT-Type* is set to 'utra' or 'geran':
 - 3> consider inter-RAT mobility as initiated towards the RAT indicated by the *targetRAT-Type* included in the *MobilityFromEUTRACommand* message;
 - 3> forward the *nas-SecurityParamFromEUTRA* to the upper layers;
 - 3> access the target cell indicated in the inter-RAT message in accordance with the specifications of the target RAT;

[TS 36.331, clause 5.4.3.5]

The UE shall:

- 1> if T304 expires (mobility from E-UTRA failure); or
- 1> if the UE does not succeed in establishing the connection to the target radio access technology; or
- 1> if the UE is unable to comply with (part of) the configuration included in the *MobilityFromEUTRACommand* message; or
- 1> if there is a protocol error in the inter RAT information included in the *MobilityFromEUTRACommand* message, causing the UE to fail the procedure according to the specifications applicable for the target RAT:
 - 2> stop T304, if running;
 - 2> if the *cs-FallbackIndicator* in the *MobilityFromEUTRACommand* message was set to 'TRUE':
 - 3> indicate to upper layers that the CS Fallback procedure has failed;

- 2> revert back to the configuration used in the source cell, excluding the configuration configured by the *physicalConfigDedicated*, *mac-MainConfig* and *sps-Config*;
- 2> initiate the connection re-establishment procedure as specified in 5.3.7;

[TS 36.331, clause 5.3.7.2]

The UE shall only initiate the procedure when AS security has been activated. The UE initiates the procedure when one of the following conditions is met:

...

- 1> upon mobility from E-UTRA failure, in accordance with 5.4.3.5; or

...

Upon initiation of the procedure, the UE shall:

- 1> stop timer T310, if running;
- 1> start timer T311;
- 1> suspend all RBs except SRB0;
- 1> reset MAC;
- 1> apply the default physical channel configuration as specified in 9.2.4;
- 1> apply the default semi-persistent scheduling configuration as specified in 9.2.3;
- 1> apply the default MAC main configuration as specified in 9.2.2;
- 1> perform cell selection in accordance with the cell selection process as specified in TS 36.304 [4];

[TS 36.331, clause 5.3.7.3]

Upon selecting a suitable E-UTRA cell, the UE shall:

- 1> stop timer T311;
- 1> start timer T301;
- 1> apply the *timeAlignmentTimerCommon* included in *SystemInformationBlockType2*;
- 1> initiate transmission of the *RRCCConnectionReestablishmentRequest* message in accordance with 5.3.7.4;

[TS 36.331, clause 5.3.7.4]

The UE shall set the contents of *RRCCConnectionReestablishmentRequest* message as follows:

- 1> set the *ue-Identity* as follows:
 - 2> set the *c-RNTI* to the C-RNTI used in the source cell (handover and mobility from E-UTRA failure) or used in the cell in which the trigger for the re-establishment occurred (other cases);
 - 2> set the *physCellId* to the physical cell identity of the source cell (handover and mobility from E-UTRA failure) or of the cell in which the trigger for the re-establishment occurred (other cases);
 - 2> set the *shortMAC-I* to the 16 least significant bits of the MAC-I calculated:
 - 3> over the ASN.1 encoded as per section 8 (i.e., a multiple of 8 bits) *VarShortMAC-Input*;
 - 3> with the $K_{RRCCint}$ key and integrity protection algorithm that was used in the source cell (handover and mobility from E-UTRA failure) or of the cell in which the trigger for the re-establishment occurred (other cases); and
 - 3> with all input bits for COUNT, BEARER and DIRECTION set to binary ones;

1> set the *reestablishmentCause* as follows:

...

2> else if the re-establishment procedure was initiated due to handover failure as specified in 5.3.5.6 (intra-LTE handover failure) or 5.4.3.5 (inter-RAT mobility from EUTRA failure):

3> set the *reestablishmentCause* to the value '*handoverFailure*';

...

The UE shall submit the *RRCConnectionReestablishmentRequest* message to lower layers for transmission.

[TS 36.331, clause 5.3.7.5]

The UE shall:

1> stop timer T301;

1> re-establish PDCP for SRB1;

1> re-establish RLC for SRB1;

1> perform the radio resource configuration procedure in accordance with the received *radioResourceConfigDedicated* and as specified in 5.3.10;

1> resume SRB1;

1> update the K_{eNB} key based on the K_{ASME} key to which the current K_{eNB} is associated, using the *nextHopChainingCount* value indicated in the *RRCConnectionReestablishment* message, as specified in TS 33.401 [32];

1> store the *nextHopChainingCount* value;

1> derive the K_{RRCint} key associated with the previously configured integrity algorithm, as specified in TS 33.401 [32];

1> derive the K_{RRCenc} key and the K_{UPenc} key associated with the previously configured ciphering algorithm, as specified in TS 33.401 [32];

1> configure lower layers to activate integrity protection using the previously configured algorithm and the K_{RRCint} key immediately, i.e., integrity protection shall be applied to all subsequent messages received and sent by the UE, including the message used to indicate the successful completion of the procedure;

1> configure lower layers to apply ciphering using the previously configured algorithm, the K_{RRCenc} key and the K_{UPenc} key immediately, i.e., ciphering shall be applied to all subsequent messages received and sent by the UE, including the message used to indicate the successful completion of the procedure;

1> perform the measurement related actions as specified in 5.5.6.1;

1> submit the *RRCConnectionReestablishmentComplete* message to lower layers for transmission, upon which the procedure ends;

[TS 23.216, clause 6.2.2. 1]

Depicted in figure 6.2.2.1-1 is a call flow for SRVCC from E-UTRAN to GERAN without DTM support. The flow requires that eNB can determine that the target is GERAN without DTM support or that the UE is without DTM support.

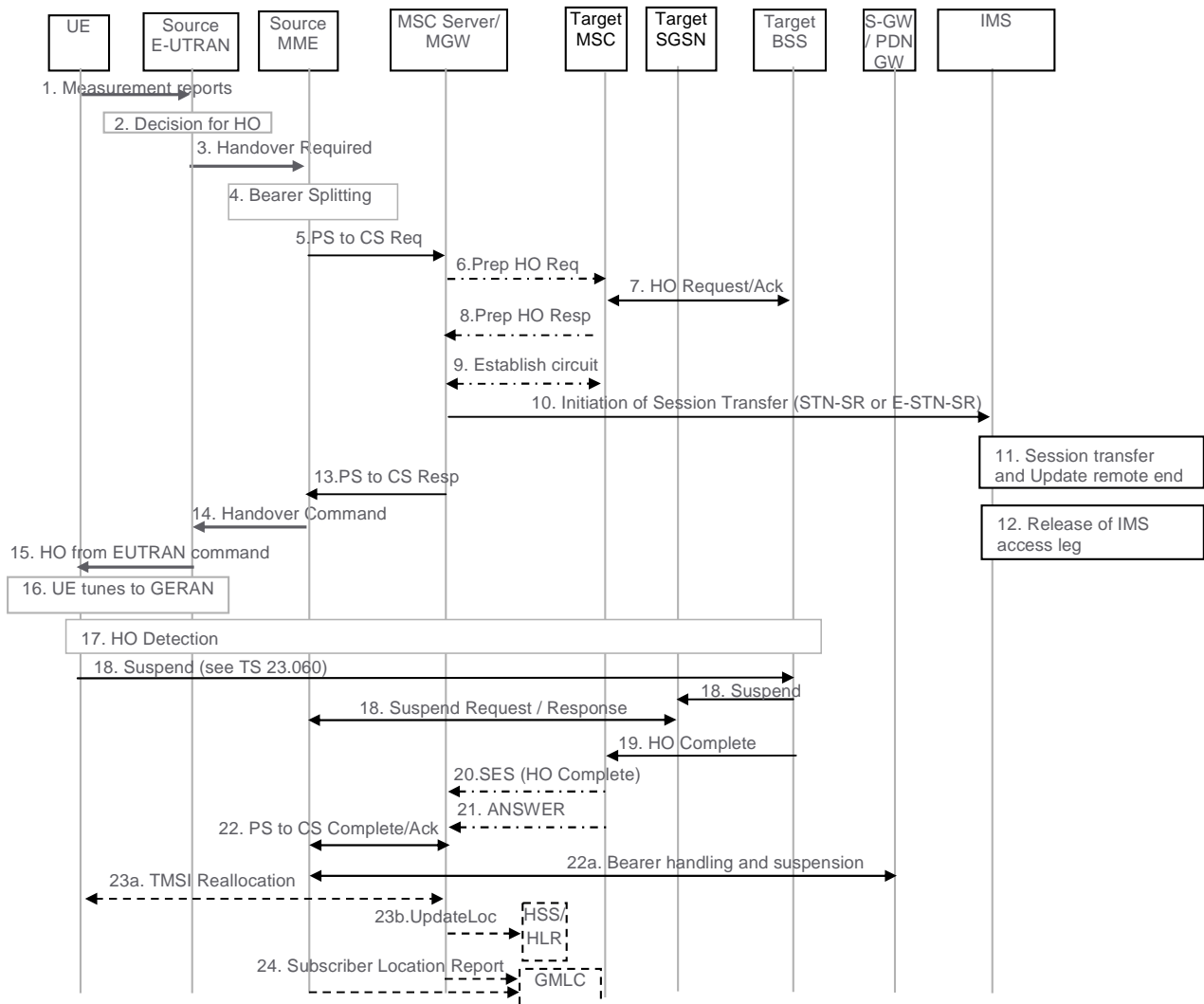

Figure 6.2.2.1-1: SRVCC from E-UTRAN to GERAN without DTM support

1. UE sends measurement reports to E-UTRAN.
2. Based on UE measurement reports the source E-UTRAN decides to trigger an SRVCC handover to GERAN.
3. Source E-UTRAN sends Handover Required (Target ID, generic Source to Target Transparent Container, SRVCC HO Indication) message to the source MME. The E-UTRAN places the "old BSS to new BSS information IE" for the CS domain in the generic Source to Target Transparent Container. The SRVCC HO indication indicates to the MME that target is only CS capable, hence this is a SRVCC handover operation only towards the CS domain. The message includes an indication that the UE is not available for the PS service in the target cell.
4. Based on the QCI associated with the voice bearer (QCI 1) and the SRVCC HO indication, the source MME splits the voice bearer from the non voice bearers and initiates the PS-CS handover procedure for the voice bearer only towards MSC Server.
5. The MME sends a SRVCC PS to CS Request (IMSI, Target ID, STN-SR, C-MSISDN, generic Source to Target Transparent Container, MM Context, Emergency Indication) message to the MSC Server. The Emergency Indication and the equipment identifier are included if the ongoing session is emergency session. Authenticated IMSI and C-MSISDN shall also be included, if available. The MME received STN-SR and C-MSISDN from the HSS as part of the subscription profile downloaded during the E-UTRAN attach procedure. The MM Context contains security related information. CS security key is derived by the MME from the E-UTRAN/EPS domain key as defined in TS 33.401 [22]. The CS Security key is sent in the MM Context.

6. The MSC Server interworks the PS-CS handover request with a CS inter-MSC handover request by sending a Prepare Handover Request message to the target MSC. The MSC Server assigns a default SAI as Source ID on the interface to the target BSS and uses BSSMAP encapsulated for the Prepare Handover Request.

NOTE 1: The value of the default SAI is configured in the MSC and allows a release 8 and later BSC to identify that the source for the SRVCC Handover is E-UTRAN. To ensure correct statistics in the target BSS the default SAI should be different from the SAIs used in UTRAN.

7. Target MSC performs resource allocation with the target BSS by exchanging Handover Request/ Acknowledge messages.
8. Target MSC sends a Prepare Handover Response message to the MSC Server.
9. Establishment of circuit connection between the target MSC and the MGW associated with the MSC Server e.g. using ISUP IAM and ACM messages.
10. For non-emergency session, the MSC Server initiates the Session Transfer by using the STN-SR e.g. by sending an ISUP IAM (STN-SR) message towards the IMS. For emergency session, the MSC Server initiates the Session Transfer by using the locally configured E-STN-SR and by including the equipment identifier. Standard IMS Service Continuity or Emergency IMS Service Continuity procedures are applied for execution of the Session Transfer, see TS 23.237 [14].

NOTE 2: This step can be started after step 8.

NOTE 3: If the MSC Server is using an ISUP interface, then the initiation of the session transfer for non-emergency session may fail if the subscriber profile including CAMEL triggers is not available prior handover (see clause 7.3.2.1.3 in TS 23.292 [13]).

11. During the execution of the Session Transfer procedure the remote end is updated with the SDP of the CS access leg. The downlink flow of VoIP packets is switched towards the CS access leg at this point.
12. Source IMS access leg is released as per TS 23.237 [14].

NOTE 4: Steps 11 and 12 are independent of step 13.

13. MSC Server sends a SRVCC PS to CS Response (Target to Source Transparent Container) message to the source MME.
14. Source MME sends a Handover Command (Target to Source Transparent Container) message to the source E-UTRAN. The message includes information about the voice component only.
15. Source E-UTRAN sends a Handover from E-UTRAN Command message to the UE.
16. UE tunes to GERAN.
17. Handover Detection at the target BSS occurs. The UE sends a Handover Complete message via the target BSS to the target MSC. If the target MSC is not the MSC Server, then the Target MSC sends an SES (Handover Complete) message to the MSC Server.
18. The UE starts the Suspend procedure specified in TS 23.060 [10], clause 16.2.1.1.2. The TLLI and RAI pair are derived from the GUTI as described in TS 23.003 [27]. This triggers the Target SGSN to send a Suspend Notification message to the Source MME. The MME returns a Suspend Acknowledge to the Target SGSN.

NOTE 5: The MME might not be able to derive the GUTI from the received P-TMSI and RAI pair and therefore it might not be able to identify which UE context is associated with the Suspend Notification message. Also in this case the bearers are deactivated and/or suspended as in step 22a.

19. Target BSS sends a Handover Complete message to the target MSC.
20. Target MSC sends an SES (Handover Complete) message to the MSC Server. The speech circuit is through connected in the MSC Server/MGW according to TS 23.009 [18].
21. Completion of the establishment procedure with ISUP Answer message to the MSC Server according to TS 23.009 [18].

22. MSC Server sends a SRVCC PS to CS Complete Notification message to the source MME, informing it that the UE has arrived on the target side. Source MME acknowledges the information by sending a SRVCC PS to CS Complete Acknowledge message to the MSC Server.

22a. The MME deactivates bearers used for voice and other GBR bearers. All GBR bearers are deactivated towards S-GW and P-GW by initiating MME-initiated Dedicated Bearer Deactivation procedure as specified in TS 23.401 [2]. The MME does not send deactivation request toward the eNodeB on receiving PS-to-CS Complete Notification in step 22. PS-to-CS handover indicator is notified to P-GW for voice bearer during the bearer deactivation procedure. For GTP-based S5/S8, the S-GW requests the P-GW to delete all GBR bearer contexts by sending a Delete Bearer Command message. If dynamic PCC is deployed, the P-GW may interact with PCRF as defined in TS 23.203 [31]. For PMIP-based S5/S8, S-GW interacts with the PCRF which in turn updates PCC rules for GBR traffic in the P-GW.

The MME starts preservation and suspension of non-GBR bearers by sending Suspend Notification message towards S-GW. For these non-GBR bearers, the S-GW releases S1-U bearers for the UE and sends Suspend Notification message to the P-GW(s). The MME stores in the UE context that UE is in suspended status. All the preserved non-GBR bearers are marked as suspended status in the S-GW and P-GW. The P-GW should discard packets if received for the suspended UE.

23a. If the HLR is to be updated, i.e. if the IMSI is authenticated but unknown in the VLR, the MSC Server performs a TMSI reallocation towards the UE using its own non-broadcast LAI and, if the MSC Server and other MSC/VLRs serve the same (target) LAI, with its own Network Resource Identifier (NRI).

NOTE 5: The TMSI reallocation is performed by the MSC Server towards the UE via target MSC.

23b. If the MSC Server performed a TMSI reallocation in step 23a, and if this TMSI reallocation was completed successfully, the MSC Server performs a MAP Update Location to the HSS/HLR.

NOTE 6: This Update Location is not initiated by the UE.

24. For an emergency services session after handover is complete, the source MME or the MSC Server may send a Subscriber Location Report carrying the identity of the MSC Server to a GMLC associated with the source or target side, respectively, as defined in TS 23.271 [29] to support location continuity.

NOTE 7: Any configuration of the choice between a source MME versus MSC Server update to a GMLC needs to ensure that a single update occurs from one of these entities when the control plane location solution is used on the source and/or target sides.

After the CS voice call is terminated and if the UE is still in GERAN (or for any other reason specified in TS 24.008), then the UE shall resume PS services as specified in TS 23.060 [10]. A Gn SGSN will follow TS 23.060 [10] to resume the PDP Context(s). An S4 SGSN will follow TS 23.060 [10] to resume the bearers, and will in addition inform S-GW and P-GW(s) to resume the suspended bearers. If the UE has returned to E-UTRAN after the CS voice call was terminated, then the UE shall resume PS service by sending TAU to MME. The MME will in addition inform S-GW and P-GW(s) to resume the suspended bearers. Resuming the suspended bearers in the S-GW and in the P-GW should be done by implicit resume using the Modify Bearer request message if it is triggered by the procedure in operation, e.g. RAU, TAU or Service Request. The S-GW is aware of the suspend state of the bearers and will forward the Modify Bearer request to the P-GW. Explicit resume using the Resume Notification message should be used in cases when Modify Bearer Request is not triggered by the procedure in operation.

[TS 23.216, clause 6.2.2.1A]

The call flow for this scenario is similar to the call flow depicted in figure 6.2.2.1-1, with the exceptions that the Suspend procedure (step 18 and step 22a in figure 6.2.2.1-1) is not performed and that the MME only deactivates bearers used for voice (step 22a in figure 6.2.2.1-1) and sets the PS-to-CS handover indicator. The scenario requires that eNB can determine that the target is either GERAN with DTM but without DTM HO support and that the UE is supporting DTM or that the target is UTRAN (HSPA) without PS HO support. The message in step 3 in figure 6.2.2.1-1 includes an indication to the MME that the UE is available for PS service in the target cell. Furthermore, if the target is GERAN, the E-UTRAN places in the generic Source to Target Transparent Container the "old BSS to new BSS information IE", while if the target is UTRAN, the generic Source to Target Transparent container is encoded according to the Source RNC to Target RNC Transparent Container IE definition. At the end of the procedure described in figure 6.2.2.1-1, the remaining PS resources are re-established when the UE performs the Routeing Area update procedure. Triggers for performing Routeing Area update procedure are described in TS 23.060 [10]. The target SGSN may deactivate the PDP contexts that cannot be established as described in TS 23.060 [10].

13.4.3.4.3 Test description

13.4.3.4.3.1 Pre-test conditions

System Simulator:

- Cell 1 and Cell 5.
- System information combination 4 as defined in TS 36.508 [18] clause 4.4.3.1 is used in E-UTRA cells.

UE:

None.

Preamble:

- The UE is in state Registered, Idle mode (state 2) on Cell 1 according to [18].

13.4.3.4.3.2 Test procedure sequence

Table 13.4.3.5.3.2-1 illustrates the downlink power levels and other changing parameters to be applied for the cells at various time instants of the test execution. Row marked "T0" denotes the initial conditions after preamble, while columns marked "T1" is to be applied subsequently. The exact instants on which these values shall be applied are described in the texts in this clause.

Table 13.4.3.4.3.2-1: Time instances of cell power level and parameter changes

	Parameter	Unit	Cell 1	Cell 5	Remark
T0	Cell-specific RS EPRE	dBm/15k Hz	-60	-	The power level values are such that entering conditions for event B2 are not satisfied.
	CPICH_Ec (UTRA FDD)	dBm/3.8 4 MHz	-	-88	
	PCCPCH_Ec (UTRA LCR TDD)	dBm/1.2 8 MHz	-	-88	
T1	Cell-specific RS EPRE	dBm/15k Hz	-84	-	The power level values are such that entering conditions for event B2 are satisfied.
	CPICH_Ec (UTRA FDD)	dBm/3.8 4 MHz	-	-64	
	PCCPCH_Ec (UTRA LCR TDD)	dBm/1.2 8 MHz	-	-64	
T2	Cell-specific RS EPRE	dBm/15k Hz	-60	-	
	CPICH_Ec (UTRA FDD)	dBm/3.8 4 MHz	-	"Off"	
	PCCPCH_Ec (UTRA LCR TDD)	dBm/1.2 8 MHz	-	"Off"	
NOTE 1: Power level "Off" for Cell 5 is defined in TS 34.108 [5] Table 6.1.4					

Table 13.4.3.4.3.2-2: Main behaviour

St	Procedure	Message Sequence		TP	Verdict
		U - S	Message		
1	The SS configures UTRA cell 5 to reference configuration according 36.508 table 4.8.3-1, condition UTRA Speech.	-	-	-	-
2-25	Steps 1 to 24 of the generic test procedure for IMS MT speech call (TS 36.508 4.5A.7.3-1).	-	-	-	-
26-27	Void	-	-	-	-
28	The SS transmits an <i>RRCCONNECTIONRECONFIGURATION</i> message on Cell 1 to setup inter RAT measurement and reporting for event B2.	<--	<i>RRCCONNECTIONRECONFIGURATION</i>	-	-
29	The UE transmits an <i>RRCCONNECTIONRECONFIGURATIONCOMPLETE</i> message on Cell 1.	-->	<i>RRCCONNECTIONRECONFIGURATIONCOMPLETE</i>	-	-
30	The SS changes the power level for Cell 1 and Cell 5 according to the row "T1" in table 13.4.3.4.3.2-1	-	-	-	-
31	The UE transmits a <i>MEASUREMENTREPORT</i> message on Cell 1 to report event B2 for Cell 5.	-->	<i>MEASUREMENTREPORT</i>	-	-
32	The SS changes the power level for Cell 1 and Cell 5 according to the row "T2" in table 13.4.3.4.3.2-1	-	-	-	-
33	The SS transmits a <i>MOBILITYFROMEUTRACOMMAND</i> message on Cell 1.	<--	<i>MOBILITYFROMEUTRACOMMAND</i>	-	-
34A	EXCEPTION: In parallel to the events described in step 34 to 39 the step specified in table 13.4.3.4.3.2-4 takes place if requested by the UE.	-	-	-	-
34	The UE transmits an <i>RRCCONNECTIONREESTABLISHMENTREQUEST</i> on Cell 1.	-->	<i>RRCCONNECTIONREESTABLISHMENTREQUEST</i>	1	P
35	The SS transmits an <i>RRCCONNECTIONREESTABLISHMENT</i> message on Cell 1.	<--	<i>RRCCONNECTIONREESTABLISHMENT</i>	-	-
36	The UE transmits an <i>RRCCONNECTIONREESTABLISHMENTCOMPLETE</i> on Cell 1	-->	<i>RRCCONNECTIONREESTABLISHMENTCOMPLETE</i>	-	-
37	The SS transmits an <i>RRCCONNECTIONRECONFIGURATION</i> message to resume existing radio bearer.	<--	<i>RRCCONNECTIONRECONFIGURATION</i>	-	-
38	The UE transmits an <i>RRCCONNECTIONRECONFIGURATIONCOMPLETE</i> message.	-->	<i>RRCCONNECTIONRECONFIGURATIONCOMPLETE</i>	-	-
39	Check: Does the test result of generic test procedure in TS 36.508 subclause 6.4.2.3 indicate that the UE is in E-UTRA RRC_CONNECTED state on Cell 1?	-	-	2	P

Table 13.4.3.4.3.2-3: Void

Table 13.4.3.4.3.2-4: Parallel behaviour

St	Procedure	Message Sequence		TP	Verdict
		U - S	Message		
1	The UE transmits a re-INVITE according annex A.2.1 of TS 34.229-1 [35].	-	-	-	-

13.4.3.4.3.3 Specific message contents

Table 13.4.3.4.3.3-1: ATTACH REQUEST (preamble)

Derivation path: 36.508 table 4.7.2-4			
Information Element	Value/remark	Comment	Condition
MS network capability	SRVCC from UTRAN HSPA or E-UTRAN to GERAN/UTRAN supported		
Mobile station classmark 2	Any allowed value		
Supported Codecs	Any allowed value		

Table 13.4.3.4.3.3-2: RRCConnectionReconfiguration (step28, Table 13.4.3.4.3.2-2)

Derivation Path: 36.508 clause 4.6.1 table 4.6.1-8 with condition MEAS
--

Table 13.4.3.4.3.3-3: MeasConfig (step28, Table 13.4.3.4.3.2-2)

Derivation path: 36.508 clause 4.6.6 table 4.6.6-1 with condition UTRAN			
Information Element	Value/Remark	Comment	Condition
measurementConfiguration ::= SEQUENCE {			
measObjectToAddModifyList SEQUENCE (SIZE (1..maxObjectId)) OF SEQUENCE {	2 entries		
measObjectId[1]	IdMeasObject-f8		
measObject[1]	MeasObjectUTRA-GENERIC(f8)		
measObjectId[2]	IdMeasObject-f1		
measObject[2]	MeasObjectEUTRA-GENERIC(f1)		
}			
reportConfigToAddModifyList SEQUENCE (SIZE (1..maxReportConfigId)) OF SEQUENCE {	1 entry		
reportConfigId[1]	IdReportConfigInterRAT-B2-UTRA		
reportConfig[1]	ReportConfigInterRAT-B2-UTRA (-72, -76)		
}			
measIdToAddModifyList SEQUENCE (SIZE (1..maxMeasId)) OF SEQUENCE {	1 entry		
measId[1]	1		
measObjectId[1]	IdMeasObject-f8		
reportConfigId[1]	IdReportConfigInterRAT-B2-UTRA		
}			
}			

Table 13.4.3.4.3.3-4: MeasurementReport (step31, Table 13.4.3.4.3.2-2)

Derivation Path: 36.508, table 4.6.1-5			
Information Element	Value/remark	Comment	Condition
MeasurementReport ::= SEQUENCE {			
criticalExtensions CHOICE {			
c1 CHOICE{			
measurementReport-r8 SEQUENCE {			
measResults SEQUENCE {			
measId	1		
measResultServCell SEQUENCE {			
rsrpResult	(0..97)		
rsrqResult	(0..34)		
}			
measResultNeighCells CHOICE {			
measResultListUTRA SEQUENCE (SIZE (1..maxCellReport)) OF SEQUENCE {	1 entry		
physCellId[1]	PhysicalCellIdentity of Cell 5		
cgi-Info[1]	Not present		
measResult[1] SEQUENCE {			
utra-RSCP	(-5..91)		
}			
}			
}			
}			
}			
}			
}			
}			
}			

Table 13.4.3.4.3.3-5: MobilityFromEUTRACommand (step 33, Table 13.4.3.4.3.2-2)

Derivation Path: 36.508, Table 4.6.1-6			
Information Element	Value/remark	Comment	Condition
MobilityFromEUTRACommand ::= SEQUENCE {			
criticalExtensions CHOICE {			
c1 CHOICE{			
mobilityFromEUTRACommand-r8 SEQUENCE {			
cs-FallbackIndicator	True		
purpose CHOICE{			
handover SEQUENCE {			
targetRAT-Type	Utra		
targetRAT-MessageContainer	HANDOVER TO UTRAN COMMAND(UTRA RRC message)		
nas-SecurityParamFromEUTRA	The 4 least significant bits of the NAS downlink COUNT value		
systemInformation	Not present		
}			
}			
}			
}			
}			
}			

Table 13.4.3.4.3.3-6: HANDOVER TO UTRAN COMMAND (step33, Table 13.4.3.4.3.2-2)

Derivation Path: 36.508, Table 4.7B.1-1, condition UTRA Speech
--

Table 13.4.3.4.3.3-7: RRCConnectionReestablishmentRequest (step34, Table 13.4.3.4.3.2-2)

Derivation Path: 36.508, Table 4.6.1-6			
Information Element	Value/remark	Comment	Condition
RRCConnectionReestablishmentRequest ::= SEQUENCE {			
criticalExtensions CHOICE {			
rrcConnectionReestablishmentRequest-r8			
SEQUENCE {			
ue-Identity SEQUENCE {			
c-RNTI	the value of the C-RNTI of the UE		
physCellId	PhysicalCellIdentity of Cell 1		
shortMAC-I	The same value as the 16 least significant bits of the XMAC-I value calculated by SS.		
}			
reestablishmentCause	handoverFailure		
spare	Present but contents not checked		
}			
}			

Table 13.4.3.4.3.3-8: RRCConnectionReconfiguration (step 37, Table 13.4.3.4.3.2-2)

Derivation Path: 36.508, Table 4.6.1-8			
Information Element	Value/remark	Comment	Condition
RRCConnectionReconfiguration ::= SEQUENCE {			
criticalExtensions CHOICE {			
c1 CHOICE{			
rrcConnectionReconfiguration-r8 SEQUENCE {			
radioResourceConfigDedicated	RadioResourceConfigDedicated-SRB2-DRB(1, 1)		
}			
}			
}			
}			

Table 13.4.3.4.3.3-9: Void**Table 13.4.3.4.3.3-10: Void**

13.4.3.5 Inter-system mobility / E-UTRA voice to GSM CS voice / Unsuccessful case / Retry on old cell / SRVCC

13.4.3.5.1 Test Purpose (TP)

(1)

```

with { UE in E-UTRA RRC_CONNECTED state }
ensure that {
when { UE receives a MobilityFromEUTRACommand message and an IMS voice call is ongoing and the UE
does not succeed in establishing the connection to the target radio access technology }
then { UE initiates the connection re-establishment procedure }
}

```

(2)

```

with { UE in E-UTRA RRC_CONNECTED state }
ensure that {
when { UE successfully completes the RRC Connection re-establishment procedure }
then { UE is in E-UTRA RRC_CONNECTED state }
}

```

13.4.3.5.2 Conformance requirements

References: The conformance requirements covered in the present TC are specified in: TS 36.331, clause 5.4.3.3, 5.4.3.5, 5.3.7.2, 5.3.7.3, 5.3.7.4, 5.3.7.5 and TS 23.216, clause 6.2.2.1.

[TS 36.331, clause 5.4.3.3]

The UE shall be able to receive a *MobilityFromEUTRACommand* message and perform a cell change order to GERAN, even if no prior UE measurements have been performed on the target cell.

The UE shall:

- 1> stop timer T310, if running;
- 1> if the *MobilityFromEUTRACommand* message includes the *purpose* set to 'handover':
 - 2> if the *targetRAT-Type* is set to 'utra' or 'geran':
 - 3> consider inter-RAT mobility as initiated towards the RAT indicated by the *targetRAT-Type* included in the *MobilityFromEUTRACommand* message;
 - 3> forward the *nas-SecurityParamFromEUTRA* to the upper layers;
 - 3> access the target cell indicated in the inter-RAT message in accordance with the specifications of the target RAT;

[TS 36.331, clause 5.4.3.5]

The UE shall:

- 1> if T304 expires (mobility from E-UTRA failure); or
- 1> if the UE does not succeed in establishing the connection to the target radio access technology; or
- 1> if the UE is unable to comply with (part of) the configuration included in the *MobilityFromEUTRACommand* message; or
- 1> if there is a protocol error in the inter RAT information included in the *MobilityFromEUTRACommand* message, causing the UE to fail the procedure according to the specifications applicable for the target RAT:
 - 2> stop T304, if running;
 - 2> if the *cs-FallbackIndicator* in the *MobilityFromEUTRACommand* message was set to 'TRUE':
 - 3> indicate to upper layers that the CS Fallback procedure has failed;
 - 2> revert back to the configuration used in the source cell, excluding the configuration configured by the *physicalConfigDedicated*, *mac-MainConfig* and *sps-Config*;
 - 2> initiate the connection re-establishment procedure as specified in 5.3.7;

...

[TS 36.331, clause 5.3.7.2]

The UE shall only initiate the procedure when AS security has been activated. The UE initiates the procedure when one of the following conditions is met:

...

- 1> upon mobility from E-UTRA failure, in accordance with 5.4.3.5; or

...

Upon initiation of the procedure, the UE shall:

- 1> stop timer T310, if running;

- 1> start timer T311;
- 1> suspend all RBs except SRB0;
- 1> reset MAC;
- 1> apply the default physical channel configuration as specified in 9.2.4;
- 1> apply the default semi-persistent scheduling configuration as specified in 9.2.3;
- 1> apply the default MAC main configuration as specified in 9.2.2;
- 1> release *reportProximityConfig* and clear any associated proximity status reporting timer;
- 1> perform cell selection in accordance with the cell selection process as specified in TS 36.304 [4];

[TS 36.331, clause 5.3.7.3]

Upon selecting a suitable E-UTRA cell, the UE shall:

- 1> stop timer T311;
- 1> start timer T301;
- 1> apply the *timeAlignmentTimerCommon* included in *SystemInformationBlockType2*;
- 1> initiate transmission of the *RRCCConnectionReestablishmentRequest* message in accordance with 5.3.7.4;

NOTE: This procedure applies also if the UE returns to the source cell.

Upon selecting an inter-RAT cell, the UE shall:

- 1> perform the actions upon leaving RRC_CONNECTED as specified in 5.3.12, with release cause 'RRC connection failure';

[TS 36.331, clause 5.3.7.4]

The UE shall set the contents of *RRCCConnectionReestablishmentRequest* message as follows:

- 1> set the *ue-Identity* as follows:
 - 2> set the *c-RNTI* to the C-RNTI used in the source cell (handover and mobility from E-UTRA failure) or used in the cell in which the trigger for the re-establishment occurred (other cases);
 - 2> set the *physCellId* to the physical cell identity of the source cell (handover and mobility from E-UTRA failure) or of the cell in which the trigger for the re-establishment occurred (other cases);
 - 2> set the *shortMAC-I* to the 16 least significant bits of the MAC-I calculated:
 - 3> over the ASN.1 encoded as per section 8 (i.e., a multiple of 8 bits) *VarShortMAC-Input*;
 - 3> with the $K_{RRCCint}$ key and integrity protection algorithm that was used in the source cell (handover and mobility from E-UTRA failure) or of the cell in which the trigger for the re-establishment occurred (other cases); and
 - 3> with all input bits for COUNT, BEARER and DIRECTION set to binary ones;
- 1> set the *reestablishmentCause* as follows:

...

- 2> else if the re-establishment procedure was initiated due to handover failure as specified in 5.3.5.6 (intra-LTE handover failure) or 5.4.3.5 (inter-RAT mobility from EUTRA failure):
 - 3> set the *reestablishmentCause* to the value 'handoverFailure';

...

The UE shall submit the *RRCConnectionReestablishmentRequest* message to lower layers for transmission.

[TS 36.331, clause 5.3.7.5]

...

The UE shall:

- 1> stop timer T301;
- 1> re-establish PDCP for SRB1;
- 1> re-establish RLC for SRB1;
- 1> perform the radio resource configuration procedure in accordance with the received *radioResourceConfigDedicated* and as specified in 5.3.10;
- 1> resume SRB1;
- 1> update the K_{eNB} key based on the K_{ASME} key to which the current K_{eNB} is associated, using the *nextHopChainingCount* value indicated in the *RRCConnectionReestablishment* message, as specified in TS 33.401 [32];
- 1> store the *nextHopChainingCount* value;
- 1> derive the K_{RRCint} key associated with the previously configured integrity algorithm, as specified in TS 33.401 [32];
- 1> derive the K_{RRCenc} key and the K_{UPenc} key associated with the previously configured ciphering algorithm, as specified in TS 33.401 [32];
- 1> configure lower layers to activate integrity protection using the previously configured algorithm and the K_{RRCint} key immediately, i.e., integrity protection shall be applied to all subsequent messages received and sent by the UE, including the message used to indicate the successful completion of the procedure;
- 1> configure lower layers to apply ciphering using the previously configured algorithm, the K_{RRCenc} key and the K_{UPenc} key immediately, i.e., ciphering shall be applied to all subsequent messages received and sent by the UE, including the message used to indicate the successful completion of the procedure;
- 1> set the content of *RRCConnectionReestablishmentComplete* message as follows:
 - 2> include the *rlf-InfoAvailable* and set it to *true*, if the UE has radio link failure information available that is related to the last occurrence of radio link failure;
- 1> perform the measurement related actions as specified in 5.5.6.1;
- 1> submit the *RRCConnectionReestablishmentComplete* message to lower layers for transmission, upon which the procedure ends;

[TS 23.216, clause 6.2.2.1]

Depicted in figure 6.2.2.1-1 is a call flow for SRVCC from E-UTRAN to GERAN without DTM support. The flow requires that eNB can determine that the target is GERAN without DTM support or that the UE is without DTM support.

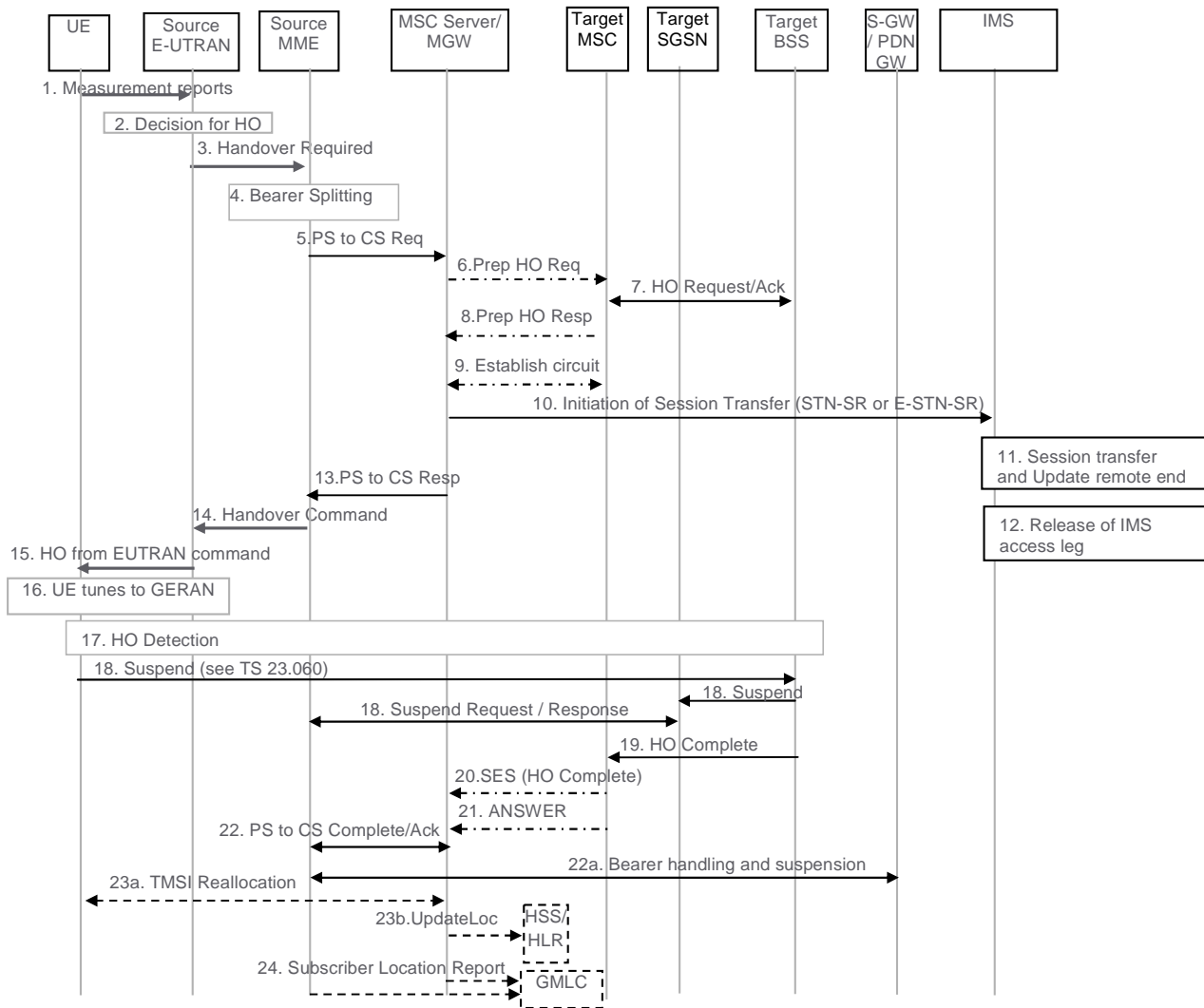

Figure 6.2.2.1-1: SRVCC from E-UTRAN to GERAN without DTM support

1. UE sends measurement reports to E-UTRAN.
2. Based on UE measurement reports the source E-UTRAN decides to trigger an SRVCC handover to GERAN.
3. Source E-UTRAN sends Handover Required (Target ID, generic Source to Target Transparent Container, SRVCC HO Indication) message to the source MME. The E-UTRAN places the "old BSS to new BSS information IE" for the CS domain in the generic Source to Target Transparent Container. The SRVCC HO indication indicates to the MME that target is only CS capable, hence this is a SRVCC handover operation only towards the CS domain. The message includes an indication that the UE is not available for the PS service in the target cell.
4. Based on the QCI associated with the voice bearer (QCI 1) and the SRVCC HO indication, the source MME splits the voice bearer from the non voice bearers and initiates the PS-CS handover procedure for the voice bearer only towards MSC Server.
5. The MME sends a SRVCC PS to CS Request (IMSI, Target ID, STN-SR, C-MSISDN, generic Source to Target Transparent Container, MM Context, Emergency Indication) message to the MSC Server. The Emergency Indication and the equipment identifier are included if the ongoing session is emergency session. Authenticated IMSI and C-MSISDN shall also be included, if available. The MME received STN-SR and C-MSISDN from the HSS as part of the subscription profile downloaded during the E-UTRAN attach procedure. The MM Context contains security related information. CS security key is derived by the MME from the E-UTRAN/EPS domain key as defined in TS 33.401 [22]. The CS Security key is sent in the MM Context.

6. The MSC Server interworks the PS-CS handover request with a CS inter-MSC handover request by sending a Prepare Handover Request message to the target MSC. The MSC Server assigns a default SAI as Source ID on the interface to the target BSS and uses BSSMAP encapsulated for the Prepare Handover Request.

NOTE 1: The value of the default SAI is configured in the MSC and allows a release 8 and later BSC to identify that the source for the SRVCC Handover is E-UTRAN. To ensure correct statistics in the target BSS the default SAI should be different from the SAIs used in UTRAN.

7. Target MSC performs resource allocation with the target BSS by exchanging Handover Request/ Acknowledge messages.
8. Target MSC sends a Prepare Handover Response message to the MSC Server.
9. Establishment of circuit connection between the target MSC and the MGW associated with the MSC Server e.g. using ISUP IAM and ACM messages.
10. For non-emergency session, the MSC Server initiates the Session Transfer by using the STN-SR e.g. by sending an ISUP IAM (STN-SR) message towards the IMS. For emergency session, the MSC Server initiates the Session Transfer by using the locally configured E-STN-SR and by including the equipment identifier. Standard IMS Service Continuity or Emergency IMS Service Continuity procedures are applied for execution of the Session Transfer, see TS 23.237 [14].

NOTE 2: This step can be started after step 8.

NOTE 3: If the MSC Server is using an ISUP interface, then the initiation of the session transfer for non-emergency session may fail if the subscriber profile including CAMEL triggers is not available prior handover (see clause 7.3.2.1.3 in TS 23.292 [13]).

11. During the execution of the Session Transfer procedure the remote end is updated with the SDP of the CS access leg. The downlink flow of VoIP packets is switched towards the CS access leg at this point.
12. Source IMS access leg is released as per TS 23.237 [14].

NOTE 4: Steps 11 and 12 are independent of step 13.

13. MSC Server sends a SRVCC PS to CS Response (Target to Source Transparent Container) message to the source MME.
14. Source MME sends a Handover Command (Target to Source Transparent Container) message to the source E-UTRAN. The message includes information about the voice component only.
15. Source E-UTRAN sends a Handover from E-UTRAN Command message to the UE.
16. UE tunes to GERAN.
17. Handover Detection at the target BSS occurs. The UE sends a Handover Complete message via the target BSS to the target MSC. If the target MSC is not the MSC Server, then the Target MSC sends an SES (Handover Complete) message to the MSC Server.
18. The UE starts the Suspend procedure specified in TS 23.060 [10], clause 16.2.1.1.2. The TLLI and RAI pair are derived from the GUTI as described in TS 23.003 [27]. This triggers the Target SGSN to send a Suspend Notification message to the Source MME. The MME returns a Suspend Acknowledge to the Target SGSN.

NOTE 5: The MME might not be able to derive the GUTI from the received P-TMSI and RAI pair and therefore it might not be able to identify which UE context is associated with the Suspend Notification message. Also in this case the bearers are deactivated and/or suspended as in step 22a.

19. Target BSS sends a Handover Complete message to the target MSC.
20. Target MSC sends an SES (Handover Complete) message to the MSC Server. The speech circuit is through connected in the MSC Server/MGW according to TS 23.009 [18].
21. Completion of the establishment procedure with ISUP Answer message to the MSC Server according to TS 23.009 [18].

22. MSC Server sends a SRVCC PS to CS Complete Notification message to the source MME, informing it that the UE has arrived on the target side. Source MME acknowledges the information by sending a SRVCC PS to CS Complete Acknowledge message to the MSC Server.

22a. The MME deactivates bearers used for voice and other GBR bearers. All GBR bearers are deactivated towards S-GW and P-GW by initiating MME-initiated Dedicated Bearer Deactivation procedure as specified in TS 23.401 [2]. The MME does not send deactivation request toward the eNodeB on receiving PS-to-CS Complete Notification in step 22. PS-to-CS handover indicator is notified to P-GW for voice bearer during the bearer deactivation procedure. For GTP-based S5/S8, the S-GW requests the P-GW to delete all GBR bearer contexts by sending a Delete Bearer Command message. If dynamic PCC is deployed, the P-GW may interact with PCRF as defined in TS 23.203 [31]. For PMIP-based S5/S8, S-GW interacts with the PCRF which in turn updates PCC rules for GBR traffic in the P-GW.

The MME starts preservation and suspension of non-GBR bearers by sending Suspend Notification message towards S-GW. For these non-GBR bearers, the S-GW releases S1-U bearers for the UE and sends Suspend Notification message to the P-GW(s). The MME stores in the UE context that UE is in suspended status. All the preserved non-GBR bearers are marked as suspended status in the S-GW and P-GW. The P-GW should discard packets if received for the suspended UE.

23a. If the HLR is to be updated, i.e. if the IMSI is authenticated but unknown in the VLR, the MSC Server performs a TMSI reallocation towards the UE using its own non-broadcast LAI and, if the MSC Server and other MSC/VLRs serve the same (target) LAI, with its own Network Resource Identifier (NRI).

NOTE 5: The TMSI reallocation is performed by the MSC Server towards the UE via target MSC.

23b. If the MSC Server performed a TMSI reallocation in step 23a, and if this TMSI reallocation was completed successfully, the MSC Server performs a MAP Update Location to the HSS/HLR.

NOTE 6: This Update Location is not initiated by the UE.

24. For an emergency services session after handover is complete, the source MME or the MSC Server may send a Subscriber Location Report carrying the identity of the MSC Server to a GMLC associated with the source or target side, respectively, as defined in TS 23.271 [29] to support location continuity.

NOTE 7: Any configuration of the choice between a source MME versus MSC Server update to a GMLC needs to ensure that a single update occurs from one of these entities when the control plane location solution is used on the source and/or target sides.

13.4.3.5.3 Test description

13.4.3.5.3.1 Pre-test conditions

System Simulator:

- Cell 1 and Cell 24.
- System information combination 5 as defined in TS 36.508 [18] clause 4.4.3.1 is used in E-UTRA cells.

UE:

None.

Preamble:

- The UE is in state Registered, Idle mode (state 2) on Cell 1 according to [18].

13.4.3.5.3.2 Test procedure sequence

Table 13.4.3.5.3.2-1 illustrates the downlink power levels and other changing parameters to be applied for the cells at various time instants of the test execution. Row marked "T0" denotes the initial conditions after preamble, while columns marked "T1" is to be applied subsequently. The exact instants on which these values shall be applied are described in the texts in this clause.

Table 13.4.3.5.3.2-1: Time instances of cell power level and parameter changes

	Parameter	Unit	Cell 1	Cell 24	Remark
T0	Cell-specific RS EPRE	dBm/15k Hz	-85	-	The power level values are such that entering conditions for event B2 are not satisfied.
	RSSI	dBm	-	-85	
T1	Cell-specific RS EPRE	dBm/15k Hz	-100	-	The power level values are such that entering conditions for event B2 are satisfied.
	RSSI	dBm	-	-65	
T2	Cell-specific RS EPRE	dBm/15k Hz	-85	-	
	RSSI	dBm	-	"Off"	

Table 13.4.3.5.3.2-2: Main behaviour

St	Procedure	Message Sequence		TP	Verdict
		U - S	Message		
1-24	Steps 1 to 24 of the generic test procedure for IMS MT speech call (TS 36.508 4.5A.7.3-1).	-	-	-	-
25-26	Void	-	-	-	-
27	The SS transmits an <i>RRCCONNECTIONRECONFIGURATION</i> message on Cell 1 to setup inter RAT measurement and reporting for event B2.	<--	<i>RRCCONNECTIONRECONFIGURATION</i>	-	-
28	The UE transmits an <i>RRCCONNECTIONRECONFIGURATIONCOMPLETE</i> message on Cell 1.	-->	<i>RRCCONNECTIONRECONFIGURATIONCOMPLETE</i>	-	-
29	The SS changes the power level for Cell 1 and Cell 24 according to the row "T1" in table 13.4.3.5.3.2-1	-	-	-	-
30	The UE transmits a <i>MEASUREMENTREPORT</i> message on Cell 1 to report event B2 for Cell 24.	-->	<i>MEASUREMENTREPORT</i>	-	-
31	The SS changes the power level for Cell 1 and Cell 24 according to the row "T2" in table 13.4.3.5.3.2-1	-	-	-	-
32	The SS transmits a <i>MOBILITYFROMEUTRACOMMAND</i> message on Cell 1.	<--	<i>MOBILITYFROMEUTRACOMMAND</i>	-	-
33A	EXCEPTION: In parallel to the events described in step 34 to 39 the step specified in table 13.4.3.5.3.2-3 takes place if requested by the UE.	-	-	-	-
33	The UE transmits an <i>RRCCONNECTIONREESTABLISHMENTREQUEST</i> on Cell 1.	-->	<i>RRCCONNECTIONREESTABLISHMENTREQUEST</i>	1	P
34	The SS transmits an <i>RRCCONNECTIONREESTABLISHMENT</i> message on Cell 1.	<--	<i>RRCCONNECTIONREESTABLISHMENT</i>	-	-
35	The UE transmits an <i>RRCCONNECTIONREESTABLISHMENTCOMPLETE</i> on Cell 1	-->	<i>RRCCONNECTIONREESTABLISHMENTCOMPLETE</i>	-	-
36	The SS transmits an <i>RRCCONNECTIONRECONFIGURATION</i> message to resume existing radio bearer.	<--	<i>RRCCONNECTIONRECONFIGURATION</i>	-	-
37	The UE transmits an <i>RRCCONNECTIONRECONFIGURATIONCOMPLETE</i> message.	-->	<i>RRCCONNECTIONRECONFIGURATIONCOMPLETE</i>	-	-
38	Check: Does the test result of generic test procedure in TS 36.508 subclause 6.4.2.3 indicate that the UE is in E-UTRA RRC_CONNECTED state on Cell 1?	-		2	P

Table 13.4.3.5.3.2-3: Parallel behaviour

St	Procedure	Message Sequence		TP	Verdict
		U – S	Message		
1	The UE transmits a re-INVITE according annex A.2.1 of TS 34.229-1 [35].	-	-	-	-

13.4.3.5.3.3 Specific message contents

Table 13.4.3.5.3.3-1: ATTACH REQUEST (preamble)

Derivation path: 36.508 table 4.7.2-4			
Information Element	Value/remark	Comment	Condition
MS network capability	SRVCC from UTRAN HSPA or E-UTRAN to GERAN/UTRAN supported		
Mobile station classmark 2	Any allowed value		
Supported Codecs	Any allowed value		

Table 13.4.3.5.3.3-2: RRCConnectionReconfiguration (step 27, Table 13.4.3.5.3.2-2)

Derivation Path: 36.508 clause 4.6.1 table 4.6.1-8 with condition MEAS
--

Table 13.4.3.5.3.3-3: MeasConfig (step 27, Table 13.4.3.5.3.2-2)

Derivation path: 36.508 clause 4.6.6 table 4.6.6-1 with condition GERAN			
Information Element	Value/Remark	Comment	Condition
measurementConfiguration ::= SEQUENCE {			
measObjectToAddModifyList SEQUENCE (SIZE (1..maxObjectId)) OF SEQUENCE {	2 entries		
measObjectId[1]	IdMeasObject-f11		
measObject[1]	MeasObjectGERAN-GENERIC(f11)		
measObjectId[2]	IdMeasObject-f1		
measObject[2]	MeasObjectEUTRA-GENERIC(f1)		
}			
reportConfigToAddModifyList SEQUENCE (SIZE (1..maxReportConfigId)) OF SEQUENCE {	1 entry		
reportConfigId[1]	IdReportConfigInterRAT-B2-GERAN		
reportConfig[1]	ReportConfigInterRAT-B2-GERAN (-90, -100)		
}			
measIdToAddModifyList SEQUENCE (SIZE (1..maxMeasId)) OF SEQUENCE {	1 entry		
measId[1]	1		
measObjectId[1]	IdMeasObject-f8		
reportConfigId[1]	IdReportConfigInterRAT-B2-GERAN		
}			
}			

Table 13.4.3.5.3.3-4: MeasurementReport (step 30, Table 13.4.3.5.3.2-2)

Derivation Path: 36.508, table 4.6.1-5			
Information Element	Value/remark	Comment	Condition
MeasurementReport ::= SEQUENCE {			
criticalExtensions CHOICE {			
c1 CHOICE{			
measurementReport-r8 SEQUENCE {			
measResults SEQUENCE {			
measId	1		
measResultServCell SEQUENCE {			
rsrpResult	(0..97)		
rsrqResult	(0..34)		
}			
measResultNeighCells CHOICE {			
measResultListGERAN SEQUENCE (SIZE (1..maxCellReport)) OF SEQUENCE {	1 entry		
physCellId	PhysicalCellIdentity of Cell 24		
cgi-Info[1]	Not present		
measResult[1] SEQUENCE {			
rssi	The value of rssi is present but contents not checked		
}			
}			
}			
}			
}			
}			

Table 13.4.3.5.3.3-5: MobilityFromEUTRACommand (step 32, Table 13.4.3.5.3.2-2)

Derivation Path: 36.508, Table 4.6.1-6			
Information Element	Value/remark	Comment	Condition
MobilityFromEUTRACommand ::= SEQUENCE {			
criticalExtensions CHOICE {			
c1 CHOICE{			
mobilityFromEUTRACommand-r8 SEQUENCE {			
cs-FallbackIndicator	True		
purpose CHOICE{			
handover SEQUENCE {			
targetRAT-Type	GERAN		
targetRAT-MessageContainer	HANDOVER COMMAND(GERAN RRC message) , see Table 13.4.3.5.3.3-5a		
nas-SecurityParamFromEUTRA	The 4 least significant bits of the NAS downlink COUNT value		
systemInformation	Not present		
}			
}			
}			
}			

Table 13.4.3.5.3.3-5a: HANDOVER COMMAND (step 32, Table 13.4.3.5.3.2-2)

Derivation Path: 51.01040.018, Table 40.2.4.339.1.15.1			
Information Element	Value/remark	Comment	Condition
Cell Description			
Network Colour Code	1		
Base Station Colour Code	5		
BCCH Carrier Number	The BCCH Carrier ARFCN as per table in clause 40.1.1 of 51.010-1.		
Description of the First Channel, after time			
Channel Description			
Channel Type and TDMA offset	TCH/F + ACCH's		
Timeslot Number	Chosen arbitrarily, but not Zero.		
Training Sequence Code	Same as the BCCH		
Hopping channel	Single RF channel		
ARFCN	The first ARFCN in the cell allocation as per table in clause 40.2.1.1.1 of 51.010-1		

Table 13.4.3.5.3.3-6: RRCConnectionReestablishmentRequest (step 33, Table 13.4.3.5.3.2-2)

Derivation Path: 36.508, Table 4.6.1-6			
Information Element	Value/remark	Comment	Condition
RRCConnectionReestablishmentRequest ::= SEQUENCE {			
criticalExtensions CHOICE {			
rrcConnectionReestablishmentRequest-r8 SEQUENCE {			
ue-Identity SEQUENCE {			
c-RNTI	the value of the C-RNTI of the UE		
physCellId	PhysicalCellIdentity of Cell 1		
shortMAC-I	The same value as the 16 least significant bits of the XMAC-I value calculated by SS.		
}			
reestablishmentCause	handoverFailure		
spare	Present but contents not checked		
}			
}			
}			

Table 13.4.3.5.3.3-7: RRCConnectionReconfiguration (step 36, Table 13.4.3.5.3.2-2)

Derivation Path: 36.508, Table 4.6.1-8			
Information Element	Value/remark	Comment	Condition
RRCConnectionReconfiguration ::= SEQUENCE {			
criticalExtensions CHOICE {			
c1 CHOICE{			
rrcConnectionReconfiguration-r8 SEQUENCE {			
radioResourceConfigDedicated	RadioResourceConfigDedicated-SRB2-DRB(1, 1)		
}			
}			
}			
}			

13.4.3.6 Inter-system mobility / E-UTRA PS voice + PS Data / HO cancelled / Notification procedure / SRVCC

13.4.3.6.1 Test Purpose (TP)

(1)

```

with { UE in E-UTRA RRC_CONNECTED state }
ensure that {
  when { UE receives a NOTIFICATION message and an IMS voice call is ongoing and an UTRA PS RB +
  Speech combination is configured for an UTRA cell }
  then { UE transmits a SIP re-INVITE message on the e-utra cell }
}
    
```

13.4.3.6.2 Conformance requirements

References: The conformance requirements covered in the present TC are specified in: TS 23.216, clauses 8.1.3; TS 24.237, clause 12.2.4.1, 12.2.4.2; TS 24.301, clause 6.6.2.2; TS 24.301, clause 6.6.2.3

[TS 23.216, clause 8.1.3]

...

If the source E-UTRAN/UTRAN decides to terminate the handover procedure before its completion, the MME/SGSN shall return to its state before the handover procedure was triggered. The MME/SGSN attempts to trigger, at the MSC Server enhanced for SRVCC, handover cancellation procedures according to TS 23.009 [18]. The MSC Server enhanced for SRVCC shall take no SRVCC-specific action towards IMS.

The MME/SGSN shall also send a session reestablishment trigger notification to UE to start the recovery procedure if it receives notification from the MSC Server that the Session Transfer procedure is in progress. Figure 8.1.3-1 shows the overall procedure for SRVCC handover cancellation.

For vSRVCC the MME and MSC also behave the same way as in the case of SRVCC handover cancellation.

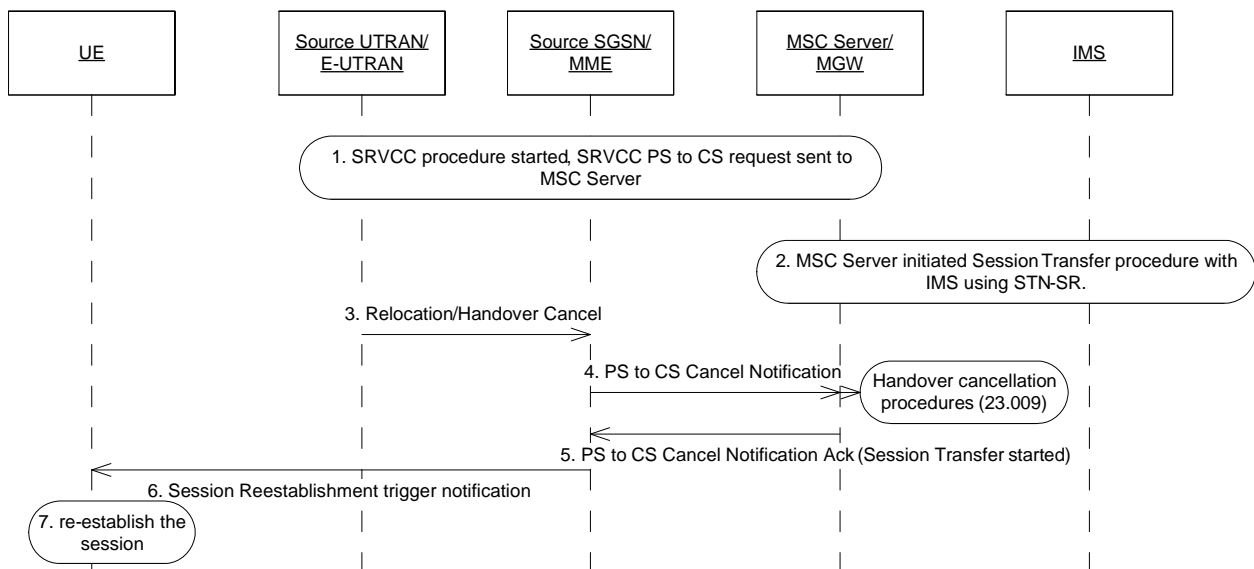

Figure 8.1.3-1: SRVCC Handover Cancellation Procedure

1. Network has started the SRVCC procedure. SGSN/MME has sent the SRVCC PS to CS request to MSC Server.
2. MSC Server is performing the CS HO procedure with target network, and has also started the Session Transfer procedure with IMS with STN-SR, see TS 23.237 [14].
3. Source UTRAN/E-UTRAN decides to cancel the SRVCC HO Procedure by sending a Cancel message to SGSN/MME.

4. Source SGSN/MME indicates SRVCC PS to CS Cancel Notification to MSC Server to start the HO cancellation procedure as according to TS 23.009 [18].
5. MSC Server acks the PS to CS Cancel Notification with an indication that Session Transfer procedure is in progress.
6. Due to the Session Transfer procedure in progress indication, the source SGSN/MME sends a Session Reestablishment trigger notification to UE to start the session re-establishment procedure
7. UE starts the re-establishment procedure, by attempting to return to E-UTRAN/UTRAN by sending a re-INVITE towards IMS for the related session. If the session is no longer active, then this session transfer request shall be rejected by the IMS.

[TS 24.237, clause 12.2.4.1]

...

If the SC UE engaged in one or more ongoing IMS sessions and:

- receives a SM NOTIFICATION message containing an "SRVCC handover cancelled, IMS session re-establishment required" as described in 3GPP TS 24.008 [8] or 3GPP TS 24.301 [52] depending on the access in use; or
- does not successfully retune to the 3GPP UTRAN or 3GPP GERAN after it receives the handover command from the eNodeB (as described in 3GPP TS 36.331 [62]) or from the NodeB (as described in 3GPP TS 25.331 [61]);

then the SC UE shall send a SIP re-INVITE request containing:

- 1) an SDP offer, including the media characteristics as used in the existing dialog; and
- 2) a Reason header field containing protocol "SIP" and reason parameter "cause" with value "487" as specified in IETF RFC 3326 [57] and with reason-text text set to either "handover cancelled" or "failure to transition to CS domain";

by following the rules of 3GPP TS 24.229 [2] in each transferred session.

[TS 24.237, clause 12.2.4.2]

...

If the SC UE is engaged in a session in early dialog state and:

- receives a SM NOTIFICATION message containing an "SRVCC handover cancelled, IMS session re-establishment required" as described in 3GPP TS 24.008 [8] or 3GPP TS 24.301 [52] depending on the access in use; or
- does not successfully retune to the 3GPP UTRAN or 3GPP GERAN after it receives the handover command from the eNodeB (as described in 3GPP TS 36.331 [62]) or from the NodeB (as described in 3GPP TS 25.331 [61]);

then the SC UE shall send a SIP UPDATE request containing:

- 1) an SDP offer, including the media characteristics as used in the existing dialog; and
- 2) a Reason header field containing protocol "SIP" and reason parameter "cause" with value "487" as specified in IETF RFC 3326 [57], and with reason-text set to either "handover cancelled" or "failure to transition to CS domain";

by following the rules of 3GPP TS 24.229 [2] in each transferred session.

[TS 24.301, clause 6.6.2.2]

...

The network initiates the notification procedure by sending a NOTIFICATION message to the UE (see example in figure 6.6.2.2.1).

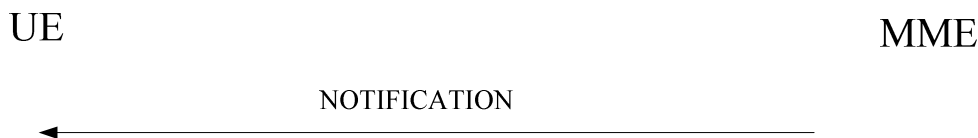

Figure 6.6.2.2.1: Notification procedure

[TS 24.301, clause 6.6.2.3]

...

When the UE receives a NOTIFICATION message, the ESM protocol entity in the UE shall provide the notification indicator to the upper layer.

The notification indicator can have the following value:

- #1: SRVCC handover cancelled, IMS session re-establishment required.

13.4.3.6.3 Test description

13.4.3.6.3.1 Pre-test conditions

System Simulator:

- Cell 1 and Cell 5.
- System information combination 4 as defined in TS 36.508 [18] clause 4.4.3.1 is used in E-UTRA cells.

UE:

None.

Preamble:

- The UE is in state Registered, Idle mode (state 2) on Cell 1 according to [18].

13.4.3.6.3.2 Test procedure sequence

Table 13.4.3.6.3.2-1 illustrates the downlink power levels and other changing parameters to be applied for the cells at various time instants of the test execution. Row marked "T0" denotes the initial conditions after preamble, while columns marked "T1" is to be applied subsequently. The exact instants on which these values shall be applied are described in the texts in this clause.

Table 13.4.3.6.3.2-1: Time instances of cell power level and parameter changes

	Parameter	Unit	Cell 1	Cell 5	Remark
T0	Cell-specific RS EPRE	dBm/15k Hz	-60	-	The power level values are such that entering conditions for event B2 are not satisfied.
	CPICH_Ec (UTRA FDD)	dBm/3.8 4 MHz	-	-88	
	PCCPCH_Ec (UTRA LCR TDD)	dBm/1.2 8 MHz	-	-88	
T1	Cell-specific RS EPRE	dBm/15k Hz	-84	-	The power level values are such that entering conditions for event B2 are satisfied.
	CPICH_Ec (UTRA FDD)	dBm/3.8 4 MHz	-	-64	
	PCCPCH_Ec (UTRA LCR TDD)	dBm/1.2 8 MHz	-	-64	

Table 13.4.3.6.3.2-2: Main behaviour

St	Procedure	Message Sequence		TP	Verdict
		U - S	Message		
1	The SS configures UTRA cell 5 to reference configuration according 36.508 table 4.8.3-1, condition UTRA PS RB + Speech .	-	-	-	-
2-27	Steps 1 to 26 of the generic test procedure for IMS MT speech call (TS 36.508 4.5A.7.3-1).	-	-	-	-
28	The SS transmits an <i>RRCCONNECTIONRECONFIGURATION</i> message on Cell 1 to setup inter RAT measurement and reporting for event B2.	<--	<i>RRCCONNECTIONRECONFIGURATION</i>	-	-
29	The UE transmits an <i>RRCCONNECTIONRECONFIGURATIONCOMPLETE</i> message on Cell 1.	-->	<i>RRCCONNECTIONRECONFIGURATIONCOMPLETE</i>	-	-
30	The SS changes the power level for Cell 1 and Cell 5 according to the row "T1" in table 13.4.3.6.3.2-1	-	-	-	-
31	The UE transmits a <i>MEASUREMENTREPORT</i> message on Cell 1 to report event B2 for Cell 5.	-->	<i>MEASUREMENTREPORT</i>	-	-
32	The SS transmits a NOTIFICATION message on Cell 1.	<--	NOTIFICATION	-	-
33	Check: Does the UE transmit a SIP re-INVITE. UE continues the call on EUTRAN.	-->	re-INVITE	1	P

13.4.3.6.3.3 Specific message contents

Table 13.4.3.6.3.3-1: ATTACH REQUEST (preamble)

Derivation path: 36.508 table 4.7.2-4			
Information Element	Value/remark	Comment	Condition
MS network capability	SRVCC from UTRAN HSPA or E-UTRAN to GERAN/UTRAN supported		
Mobile station classmark 2	Any allowed value		
Supported Codecs	Any allowed value		

Table 13.4.3.6.3.3-2: *RRCCONNECTIONRECONFIGURATION* (step28, Table 13.4.3.6.3.2-2)

Derivation Path: 36.508 clause 4.6.1 table 4.6.1-8 with condition MEAS
--

Table 13.4.3.6.3.3-3: MeasConfig (step28, Table 13.4.3.6.3.2-2)

Derivation path: 36.508 clause 4.6.6 table 4.6.6-1 with condition UTRAN			
Information Element	Value/Remark	Comment	Condition
measurementConfiguration ::= SEQUENCE {			
measObjectToAddModifyList SEQUENCE (SIZE (1..maxObjectId)) OF SEQUENCE {	2 entries		
measObjectId[1]	IdMeasObject-f8		
measObject[1]	MeasObjectUTRA-GENERIC(f8)		
measObjectId[2]	IdMeasObject-f1		
measObject[2]	MeasObjectEUTRA-GENERIC(f1)		
}			
reportConfigToAddModifyList SEQUENCE (SIZE (1..maxReportConfigId)) OF SEQUENCE {	1 entry		
reportConfigId[1]	IdReportConfigInterRAT-B2-UTRA		
reportConfig[1]	ReportConfigInterRAT-B2-UTRA(-72, -76)		
}			
measIdToAddModifyList SEQUENCE (SIZE (1..maxMeasId)) OF SEQUENCE {	1 entry		
measId[1]	1		
measObjectId[1]	IdMeasObject-f8		
reportConfigId[1]	IdReportConfigInterRAT-B2-UTRA		
}			
}			

Table 13.4.3.6.3.3-4: MeasurementReport (step31, Table 13.4.3.6.3.2-2)

Derivation Path: 36.508, table 4.6.1-5			
Information Element	Value/remark	Comment	Condition
MeasurementReport ::= SEQUENCE {			
criticalExtensions CHOICE {			
c1 CHOICE{			
measurementReport-r8 SEQUENCE {			
measResults SEQUENCE {			
measId	1		
measResultServCell SEQUENCE {			
rsrpResult	(0..97)		
rsrqResult	(0..34)		
}			
measResultNeighCells CHOICE {			
measResultListUTRA SEQUENCE (SIZE (1..maxCellReport)) OF SEQUENCE {	1 entry		
physCellId[1]	PhysicalCellIdentity of Cell 5		
cgi-Info[1]	Not present		
measResult[1] SEQUENCE {			
utra-RSCP	(-5..91)		
}			
}			
}			
}			
}			
}			
}			

Table 13.4.3.6.3.3-5: NOTIFICATION (step32, Table 13.4.3.6.3.2-2)

FFS

Table 13.4.3.6.3.3-6: re-INVITE (step33, Table 13.4.3.6.3.2-2)

FFS

13.4.3.7 Inter-system mobility / E-UTRA voice to UTRA CS voice / aSRVCC / MO call

13.4.3.7.1 Test Purpose (TP)

(1)

```
with { UE is in E-UTRA RRC_CONNECTED state and an IMS MO speech call is in alerting phase }
ensure that {
  when { UE receives a MobilityFromEUTRACommand message }
  then { UE transmits a HANDOVER TO UTRAN COMPLETE message on the UTRA cell }
}
```

(2)

```
with { UE is in UTRA CELL_DCH state and an SRVCC procedure for MO call in alerting phase is
completed }
ensure that {
  when { UE receives a CONNECT message }
  then { UE transmits a CONNECT ACKNOWLEDGE message }
}
```

13.4.3.7.2 Conformance requirements

References: The conformance requirements covered in the present TC are specified in: TS 36.331, clause 5.4.3.3, TS 23.237, clause 6.3.2.1.4d, TS 23.216, clause 6.2.2.2, TS 24.237, clauses 12.1, 12.2.3B.1, 12.2.3B.2, 12.2.3B.3.2, and TS 24.008, clause 5.2.4.2.

[TS 36.331, clause 5.4.3.3]

The UE shall:

- 1> stop timer T310, if running;
- 1> if the *MobilityFromEUTRACommand* message includes the *purpose* set to *handover*:
 - 2> if the *targetRAT-Type* is set to *utra* or *geran*:
 - 3> consider inter-RAT mobility as initiated towards the RAT indicated by the *targetRAT-Type* included in the *MobilityFromEUTRACommand* message;
 - 3> forward the *nas-SecurityParamFromEUTRA* to the upper layers;
 - 3> access the target cell indicated in the inter-RAT message in accordance with the specifications of the target RAT;

[TS 23.237, clause 6.3.2.1.4d]

Figure 6.3.2.1.4d-1 PS-CS: PS to CS - Single Radio, outgoing call in alerting phase, provides an information flow for Access Transfer of media of an IMS session in PS to CS direction for Access Transfers as specified in TS 23.216 [10].

The flow requires that the user is active in an outgoing IMS session and that the SIP session is in alerting state and there is no other ongoing session; procedures and capabilities specified in TS 23.216 [10], clause 6.2.1 are used for the switching of access networks at the transport layer. It further requires that the MSC Server supports I2 reference point.

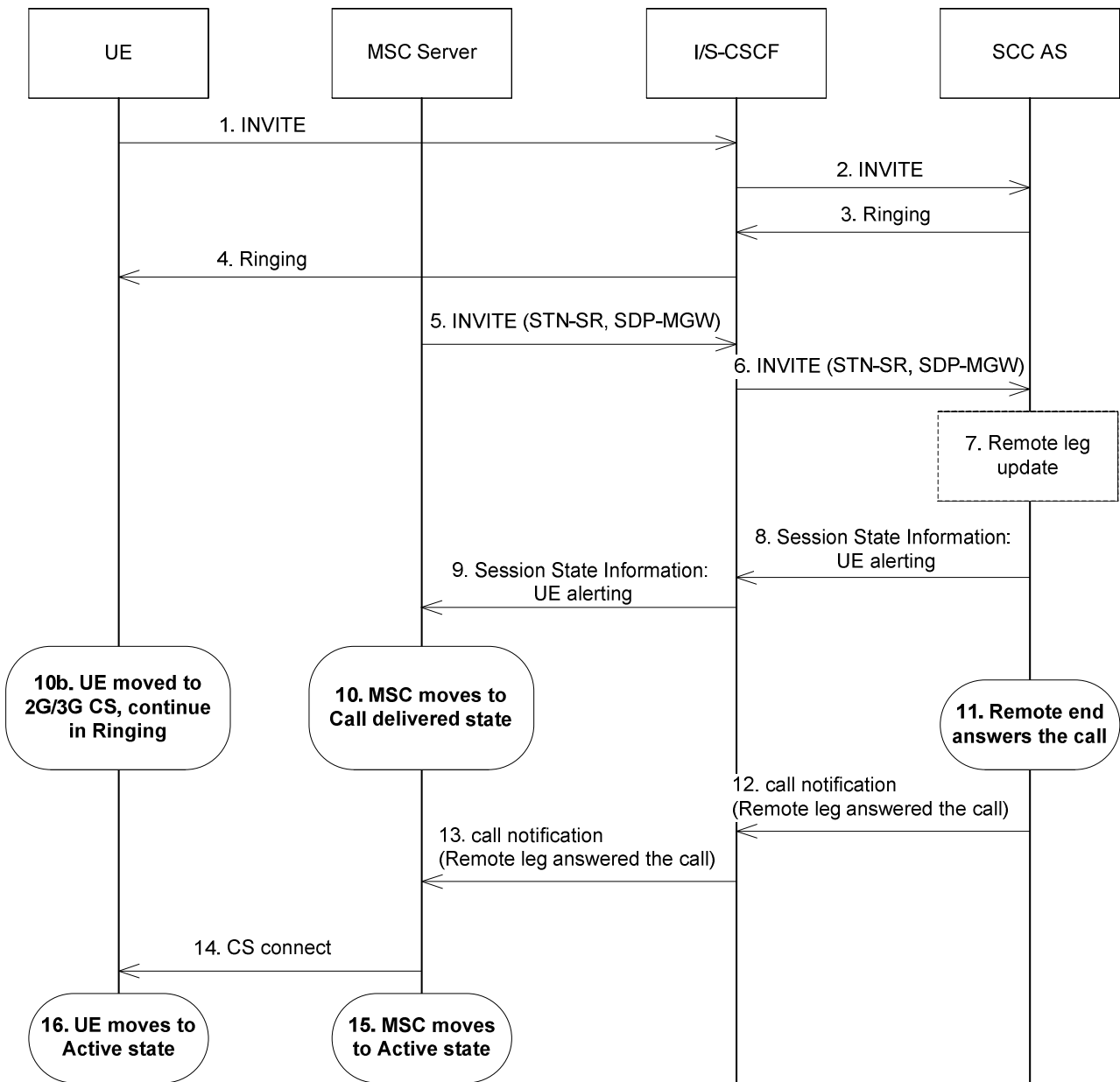

Figure 6.3.2.1.4d-1: PS-CS: PS to CS – Single Radio, outgoing call in alerting phase

1-4. Standard procedures are used to initiate a SIP session from the UE towards the remote end. The remote end is alerting the user for the incoming voice session.

...

10. The MSC moves to the corresponding CS call state, e.g. Call Delivered in TS 24.008 [24].

10b. In parallel to step 10, the UE has received the HO command as described in TS 23.216 [10]. The UE determines the local call state in the SIP session, and creates the corresponding CS call state, e.g. Call Delivered in TS 24.008 [24]. The UE ensures that the same ring back tone is played to the end user.

...

14. The MSC uses the standard procedure to send the CS connect message to UE as e.g. described in TS 24.008 [24].

15. The MSC moves to Active state.

16. The UE moves to Active state.

[TS 23.216, clause 6.2.2.2]

Depicted in figure 6.2.2.2-1 is a call flow for SRVCC from E-UTRAN to UTRAN or GERAN with DTM HO support, including the handling of the non-voice component. The flow requires that eNB can determine that either the target is UTRAN with PS HO or the target is GERAN with DTM support and the UE is supporting DTM.

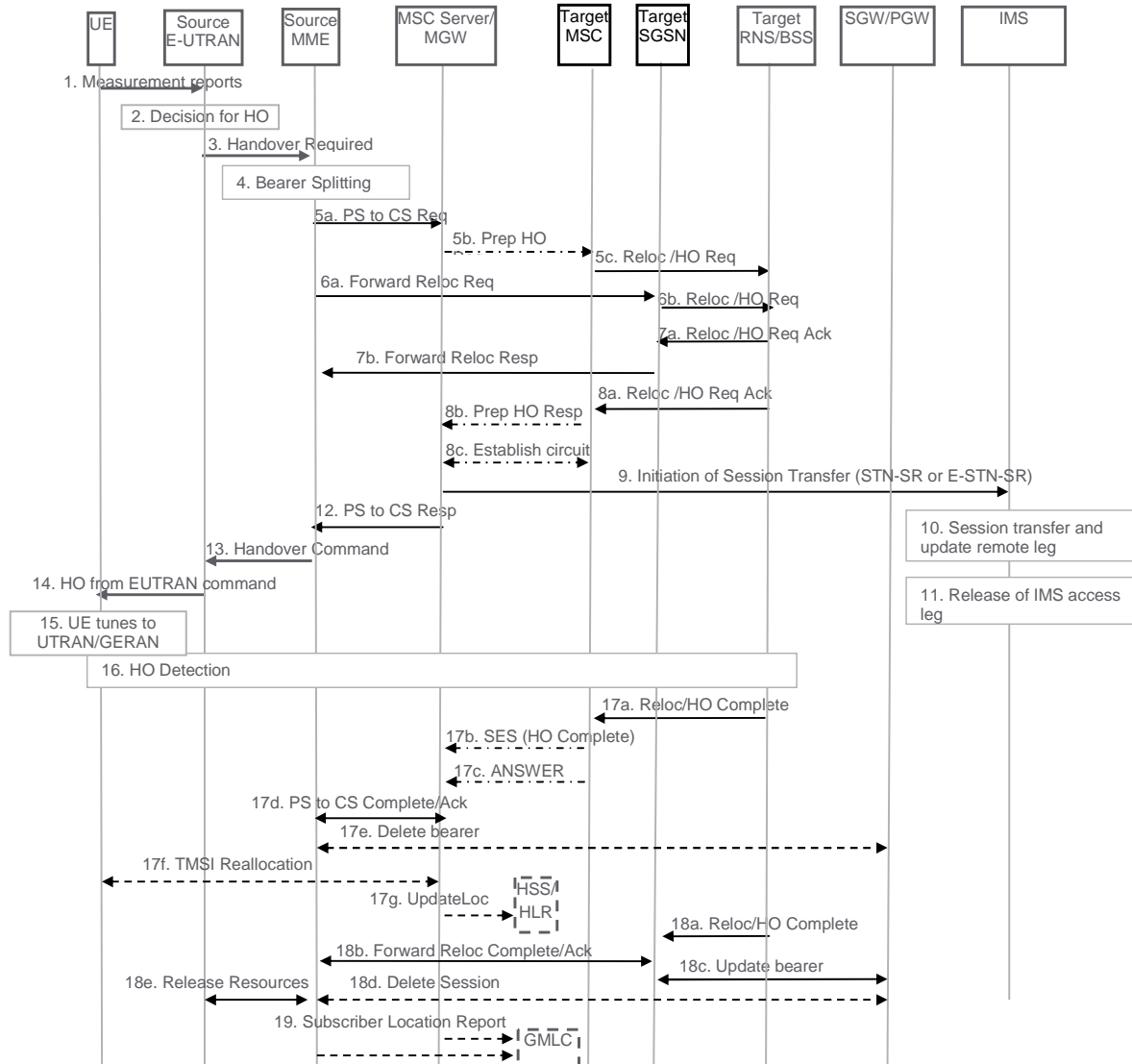

Figure 6.2.2.2-1: SRVCC from E-UTRAN to UTRAN with PS HO or GERAN with DTM HO support

1. UE sends measurement reports to E-UTRAN.

...

14. E-UTRAN sends a Handover from E-UTRAN Command message to the UE.

15. UE tunes to the target UTRAN/GERAN cell.

16. Handover Detection at the target RNS/BSS occurs. The UE sends a Handover Complete message via the target RNS/BSS to the target MSC. If the target MSC is not the MSC Server, then the Target MSC sends an SES (Handover Complete) message to the MSC Server. At this stage, the UE re-establishes the connection with the network and can send/receive voice data.

17. The CS relocation/handover is complete. The following steps are performed:

- a) Target RNS/BSS sends Relocation Complete/Handover Complete message to the target MSC.
- b) Target MSC sends an SES (Handover Complete) message to the MSC Server. The speech circuit is through connected in the MSC Server/MGW according to TS 23.009 [18].
- c) Completion of the establishment procedure with ISUP Answer message to the MSC Server according to TS 23.009 [18].
- d) MSC Server sends a SRVCC PS to CS Complete Notification message to the source MME. Source MME acknowledges the information by sending a SRVCC PS to CS Complete Acknowledge message to the MSC Server.
- e) The source MME deactivates the voice bearer towards S-GW/P-GW and sets the PS-to-CS handover indicator to Delete Bearer Command message. This triggers MME-initiated Dedicated Bearer Deactivation procedure as specified in TS 23.401 [2]. The MME does not send deactivation request toward the eNodeB on receiving PS-to-CS Complete Notification in step 17d. If dynamic PCC is deployed, the PGW may interact with PCRF as defined in TS 23.203 [31].
- f) If the HLR is to be updated, i.e. if the IMSI is authenticated but unknown in the VLR, the MSC Server performs a TMSI reallocation towards the UE using its own non-broadcast LAI and, if the MSC Server and other MSC/VLRs serve the same (target) LAI, with its own Network Resource Identifier (NRI).

NOTE 9: The TMSI reallocation is performed by the MSC Server towards the UE via target MSC.

- g) If the MSC Server performed a TMSI reallocation in step 17f, and if this TMSI reallocation was completed successfully, the MSC Server performs a MAP Update Location to the HSS/HLR.

NOTE 10: This Update Location is not initiated by the UE.

[TS 24.237, clause 12.1]

In order to fulfil the requirements for PS-CS access transfer in SR-VCC for calls in alerting state, the SC UE needs to be engaged in a session with speech media component in early dialog state according to the following conditions before SR-VCC access transfer is performed:

- a SIP 180 (Ringing) response for the initial SIP INVITE request to establish this session has been sent or received; and
- a SIP final response for the initial SIP INVITE request to establish this session has not been sent or received.

[TS 24.237, clause 12.2.3B.1]

The SC UE shall apply the procedures in subclauses 12.2.3B.3 for access transfer for calls in alerting state if:

- 1) the SC UE supports single radio PS to CS access transfer for calls in alerting state; and
- 2) there are one or more early dialogs created by the same SIP INVITE request with at least one dialog that is an early dialog supporting a session with active speech media component where the SC UE:
 - has sent a Contact header field in a SIP INVITE request or 180 (Ringing) response containing the g.3gpp.srvcc-alerting media feature tag (as described in annex C); and
 - has received a Feature-Caps header field in a SIP INVITE request or 180 (Ringing) response containing the g.3gpp.srvcc-alerting feature capability indicator (as described in annex C).

[TS 24.237, clause 12.2.3B.2]

If the SC UE applies the procedures in subclause 12.2.3B.3 and the SC UE only has a single call in alerting state following access transfer, then the SC UE shall associate this session with transaction identifier value and TI flag as described in 3GPP TS 24.008 [8].

[TS 24.237, clause 12.2.3B.3.2]

If the SC UE has initiated an outgoing call which is in the early dialog state according to the conditions in subclauses 12.1 and 12.2.3B.1 and the SC UE successfully performs access transfer to the CS domain, then the UE continues in Ringing state in CS, i.e. UE moves to Call Delivered (U4) state as described in 3GPP TS 24.008 [8].

[TS 24.008, clause 5.2.4.2]

If the MS supports single radio PS to CS access transfer for calls in alerting state as specified in 3GPP TS 24.237 [136] subclause 12.2.3B, and the MS has a single voice media stream over the PS domain that is handed over to the CS domain via SRVCC, and the call control entity in "null" state receives an indication "MM connection establishment due to SRVCC handover", then:

- if the voice media stream is associated with a mobile originated session in the "early" state (defined in IETF RFC 3261 [137]) according to the conditions specified in 3GPP TS 24.237 [136] subclause 12.2.3B.3.2, the call control entity of the MS shall enter the "call delivered" state for this transaction. The MS and the network shall locally set the TI value of the call to "000" and the TI flag value as in mobile terminated call; and

...

If the MS has additional voice media streams carried over the PS domain that are handed over to the CS domain via SRVCC, the state for the transactions and the setting of the TI value and TI flag for these additional media streams is described in 3GPP TS 24.237 [136].

13.4.3.7.3 Test description

13.4.3.7.3.1 Pre-test conditions

System Simulator:

- Cell 1 and Cell 5.
- System information combination 4 as defined in TS 36.508 [18] clause 4.4.3.1 is used in E-UTRA cell.

UE:

None.

Preamble:

- The UE is in state Registered, Idle mode (state 2) on Cell 1 according to [18].

13.4.3.7.3.2 Test procedure sequence

Table 13.4.3.7.3.2-1 illustrates the downlink power levels and other changing parameters to be applied for the cells at various time instants of the test execution. Row marked "T0" denotes the initial conditions after preamble, while columns marked "T1" is to be applied subsequently. The exact instants on which these values shall be applied are described in the texts in this clause.

Table 13.4.3.7.3.2-1: Time instances of cell power level and parameter changes

	Parameter	Unit	Cell 1	Cell 5	Remark
T0	Cell-specific RS EPRE	dBm/15k Hz	-60	-	The power level values are such that entering conditions for event B2 are not satisfied.
	CPICH_Ec (UTRA FDD)	dBm/3.8 4 MHz	-	-88	
	PCCPCH_Ec (UTRA LCR TDD)	dBm/1.2 8 MHz	-	-88	
T1	Cell-specific RS EPRE	dBm/15k Hz	-84	-	The power level values are such that entering conditions for event B2 are satisfied.
	CPICH_Ec (UTRA FDD)	dBm/3.8 4 MHz	-	-64	
	PCCPCH_Ec (UTRA LCR TDD)	dBm/1.2 8 MHz	-	-64	

Table 13.4.3.7.3.2-2: Main behaviour

St	Procedure	Message Sequence		TP	Verdict
		U - S	Message		
1	The SS configures UTRA Cell 5 to reference configuration according 36.508 Table 4.8.3-1, condition UTRA Speech.	-	-	-	-
2-13	Steps 1 to 12 of the generic test procedure for IMS MO speech call (TS 36.508 4.5A.6.3-1).	-	-	-	-
-	EXCEPTION: In parallel to the events described in steps 14 to 15 the steps specified in Table 13.4.3.7.3.2-3 should take place.	-	-	-	-
14	The UE transmits an <i>RRConnectionReconfigurationComplete</i> message on Cell 1 to confirm the establishment of the new data radio bearer, associated with the dedicated EPS bearer.	-->	<i>RRConnectionReconfigurationComplete</i>	-	-
15	The UE transmits an ACTIVATE DEDICATED EPS BEARER CONTEXT ACCEPT message on Cell 1.	-->	ACTIVATE DEDICATED EPS BEARER CONTEXT ACCEPT	-	-
16	The SS transmits an <i>RRConnectionReconfiguration</i> message on Cell 1 to setup inter-RAT measurement and reporting for event B2.	<--	<i>RRConnectionReconfiguration</i>	-	-
17	The UE transmits an <i>RRConnectionReconfigurationComplete</i> message on Cell 1.	-->	<i>RRConnectionReconfigurationComplete</i>	-	-
18	The SS changes the power level for Cell 1 and Cell 5 according to the row "T1" in Table 13.4.3.7.3.2-1.	-	-	-	-
19	The UE transmits a <i>MeasurementReport</i> message on Cell 1 to report event B2 for Cell 5.	-->	<i>MeasurementReport</i>	-	-
20	The SS transmits a <i>UECapabilityEnquiry</i> message on Cell 1 to request UE radio access capability information for E-UTRA and UTRA.	<--	<i>UECapabilityEnquiry</i>	-	-
21	The UE transmit a <i>UECapabilityInformation</i> message on Cell 1. NOTE: The start-CS values received, should be used to configure ciphering on Cell 5.	-->	<i>UECapabilityInformation</i>	-	-
22	The SS transmits a <i>MobilityFromEUTRACommand</i> message on Cell 1.	<--	<i>MobilityFromEUTRACommand</i>	-	-
23	Check: Does the UE transmit a HANDOVER TO UTRAN COMPLETE message on Cell 5?	-->	HANDOVER TO UTRAN COMPLETE	1	P
-	EXCEPTION: In parallel to the events described in step 24 to 29 the steps specified in Table 13.4.3.7.3.2-4 takes place.	-	-	-	-
24	The SS transmits a SECURITY MODE COMMAND message for the CS domain on Cell 5.	<--	SECURITY MODE COMMAND	-	-
25	The UE transmits a SECURITY MODE COMPLETE message on Cell 5.	-->	SECURITY MODE COMPLETE	-	-
26	The SS transmits an UTRAN MOBILITY INFORMATION message on Cell 5 to notify CN information.	<--	UTRAN MOBILITY INFORMATION	-	-
27	The UE transmits an UTRAN MOBILITY INFORMATION CONFIRM message on Cell 5.	-->	UTRAN MOBILITY INFORMATION CONFIRM	-	-
28	The SS transmits a TMSI REALLOCATION COMMAND message on Cell 5.	<--	TMSI REALLOCATION COMMAND	-	-
29	The UE transmits a TMSI REALLOCATION COMPLETE message on Cell 5.	-->	TMSI REALLOCATION COMPLETE	-	-
30	The SS transmits a CONNECT message on Cell 5.	<--	CONNECT	-	-
31	Check: Does the UE transmit a CONNECT ACKNOWLEDGE message on Cell 5?	-->	CONNECT ACKNOWLEDGE	2	P

Table 13.4.3.7.3.2-3: Parallel behaviour

St	Procedure	Message Sequence		TP	Verdict
		U - S	Message		
1-7	Steps 5-11 expected sequence defined in annex C.21 of TS 34.229-1 [35]. NOTE: IMS MO speech call is in alerting phase.	-	-	-	-

Table 13.4.3.7.3.2-4: Parallel behaviour

St	Procedure	Message Sequence		TP	Verdict
		U - S	Message		
1	The UE transmits a ROUTING AREA UPDATE REQUEST message on Cell 5.	-->	ROUTING AREA UPDATE REQUEST	-	-
2	The SS transmits a SECURITY MODE COMMAND message for the PS domain on Cell 5.	<--	SECURITY MODE COMMAND	-	-
3	The UE transmits a SECURITY MODE COMPLETE message on Cell 5.	-->	SECURITY MODE COMPLETE	-	-
4	The SS transmits a ROUTING AREA UPDATE ACCEPT message on Cell 5.	<--	ROUTING AREA UPDATE ACCEPT	-	-
5	The UE transmits a ROUTING AREA UPDATE COMPLETE message on Cell 5.	-->	ROUTING AREA UPDATE COMPLETE	-	-

13.4.3.7.3.3 Specific message contents

Table 13.4.3.7.3.3-1: ATTACH REQUEST (preamble)

Derivation path: 36.508 Table 4.7.2-4			
Information Element	Value/remark	Comment	Condition
MS network capability	SRVCC from UTRAN HSPA or E-UTRAN to GERAN/UTRAN supported		
Mobile station classmark 2	Any allowed value		
Supported Codecs	Any allowed value		
Old GUTI type	Any allowed value		

Table 13.4.3.7.3.3-2: *RRCConnectionReconfiguration* (step 16, Table 13.4.3.7.3.2-2)

Derivation Path: 36.508, Table 4.6.1-8, condition MEAS
--

Table 13.4.3.7.3.3-3: MeasConfig (Table 13.4.3.7.3.3-2)

Derivation Path: 36.508, Table 4.6.6-1, condition UTRAN			
Information Element	Value/remark	Comment	Condition
MeasConfig ::= SEQUENCE {			
measObjectToAddModList SEQUENCE (SIZE (1..maxObjectId)) OF SEQUENCE {	2 entries		
measObjectId[1]	IdMeasObject-f1		
measObject[1]	MeasObjectEUTRA-GENERIC(f1)		
measObjectId[2]	IdMeasObject-f8		
measObject[2]	MeasObjectUTRA-f8		
}			
reportConfigToAddModList SEQUENCE (SIZE (1..maxReportConfigId)) OF SEQUENCE {	1 entry		
reportConfigId[1]	IdReportConfig-B2-UTRA		
reportConfig[1]	ReportConfigInterRAT-B2-UTRA (-72, -76)		
}			
measIdToAddModList SEQUENCE (SIZE (1..maxMeasId)) OF SEQUENCE {	1 entry		
measId[1]	1		
measObjectId[1]	IdMeasObject-f8		
reportConfigId[1]	IdReportConfig-B2-UTRA		
}			
}			

Table 13.4.3.7.3.3-4: MeasObjectUTRA-f8 (Table 13.4.3.7.3.3-3)

Derivation Path: 36.508, Table 4.6.6-3			
Information Element	Value/remark	Comment	Condition
MeasObjectUTRA ::= SEQUENCE {			
carrierFreq	Same downlink ARFCN as used for Cell 5		
cellsToAddModList CHOICE {			
cellsToAddModListUTRA-FDD SEQUENCE (SIZE (1..maxCellMeas)) OF SEQUENCE {	1 entry		UTRA-FDD
cellIndex[1]	1		
physCellId[1]	PhysicalCellIdentity of Cell 5		
}			
cellsToAddModListUTRA-TDD SEQUENCE (SIZE (1..maxCellMeas)) OF SEQUENCE {			UTRA-TDD
cellIndex[1]	1		
physCellId[1]	PhysicalCellIdentity of Cell 5		
}			
}			
csg-allowedReportingCells-v930	Not present		
}			

Condition	Explanation
UTRA-FDD	UTRA FDD cell environment
UTRA-TDD	UTRA TDD cell environment

Table 13.4.3.7.3.3-7: MobilityFromEUTRACommand (step 22, Table 13.4.3.7.3.2-2)

Derivation Path: 36.508, Table 4.6.1-6			
Information Element	Value/remark	Comment	Condition
MobilityFromEUTRACommand ::= SEQUENCE {			
criticalExtensions CHOICE {			
c1 CHOICE {			
mobilityFromEUTRACommand-r8 SEQUENCE {			
cs-FallbackIndicator	True		
purpose CHOICE {			
handover SEQUENCE {			
targetRAT-Type	utra		
targetRAT-MessageContainer	HANDOVER TO UTRAN COMMAND(UTRA RRC message)		
nas-SecurityParamFromEUTRA	The 4 least significant bits of the NAS downlink COUNT value		
systemInformation	Not present		
}			
}			
}			
}			
}			
}			
}			

Table 13.4.3.7.3.3-8: HANDOVER TO UTRAN COMMAND (Table 13.4.3.7.3.3-7)

Derivation Path: 36.508, Table 4.7B.1-1, condition UTRA Speech			

Table 13.4.3.7.3.3-9: SECURITY MODE COMMAND (step 24, Table 13.4.3.7.3.2-2)

Derivation Path: 36.508, Table 4.7B.1-n			
Information Element	Value/remark	Comment	Condition
Ciphering mode info	Not present		

Table 13.4.3.7.3.3-10: CONNECT (step 30, Table 13.4.3.7.3.2-2)

Derivation Path: TS 24.008 Table 9.59			
Information Element	Value/remark	Comment	Condition
Transaction identifier			
TI flag	'0'B	The message is sent from the side that originates the TI	
TIO	'000'B	TI value 0	

Table 13.4.3.7.3.3-11: CONNECT ACKNOWLEDGE (step 31, Table 13.4.3.7.3.2-2)

Derivation Path: TS 24.008 Table 9.60			
Information Element	Value/remark	Comment	Condition
Transaction identifier			
TI flag	'1'B	The message is sent to the side that originates the TI	
TIO	'000'B	TI value 0	

13.4.3.8 Inter-system mobility / E-UTRA voice to UTRA CS voice / aSRVCC / MO call / Forked responses

13.4.3.8.1 Test Purpose (TP)

(1)

```
with { UE is in E-UTRA RRC_CONNECTED state, an IMS MO speech call is in alerting phase and UE has
received several SIP forked responses }
ensure that {
  when { UE receives a MobilityFromEUTRACommand message }
  then { UE transmits a HANDOVER TO UTRAN COMPLETE message on the UTRA cell }
}
```

(2)

```
with { UE is in UTRA CELL_DCH state and an SRVCC procedure for MO call in alerting phase is
completed }
ensure that {
  when { UE receives a CONNECT message }
  then { UE transmits a CONNECT ACKNOWLEDGE message }
}
```

13.4.3.8.2 Conformance requirements

References: The conformance requirements covered in the present TC are specified in: TS 36.331, clause 5.4.3.3, TS 23.237, clause 6.3.2.1.4d, TS 23.216, clause 6.2.2.2, TS 24.237, clauses 12.1, 12.2.3B.1, 12.2.3B.2, 12.2.3B.3.2, A.17.6 and TS 24.008, clause 5.2.4.2.

[TS 36.331, clause 5.4.3.3]

The UE shall:

- 1> stop timer T310, if running;
- 1> if the *MobilityFromEUTRACommand* message includes the *purpose* set to *handover*:
 - 2> if the *targetRAT-Type* is set to *utra* or *geran*:
 - 3> consider inter-RAT mobility as initiated towards the RAT indicated by the *targetRAT-Type* included in the *MobilityFromEUTRACommand* message;
 - 3> forward the *nas-SecurityParamFromEUTRA* to the upper layers;
 - 3> access the target cell indicated in the inter-RAT message in accordance with the specifications of the target RAT;

[TS 23.237, clause 6.3.2.1.4d]

Figure 6.3.2.1.4d-1 PS-CS: PS to CS - Single Radio, outgoing call in alerting phase, provides an information flow for Access Transfer of media of an IMS session in PS to CS direction for Access Transfers as specified in TS 23.216 [10].

The flow requires that the user is active in an outgoing IMS session and that the SIP session is in alerting state and there is no other ongoing session; procedures and capabilities specified in TS 23.216 [10], clause 6.2.1 are used for the switching of access networks at the transport layer. It further requires that the MSC Server supports I2 reference point.

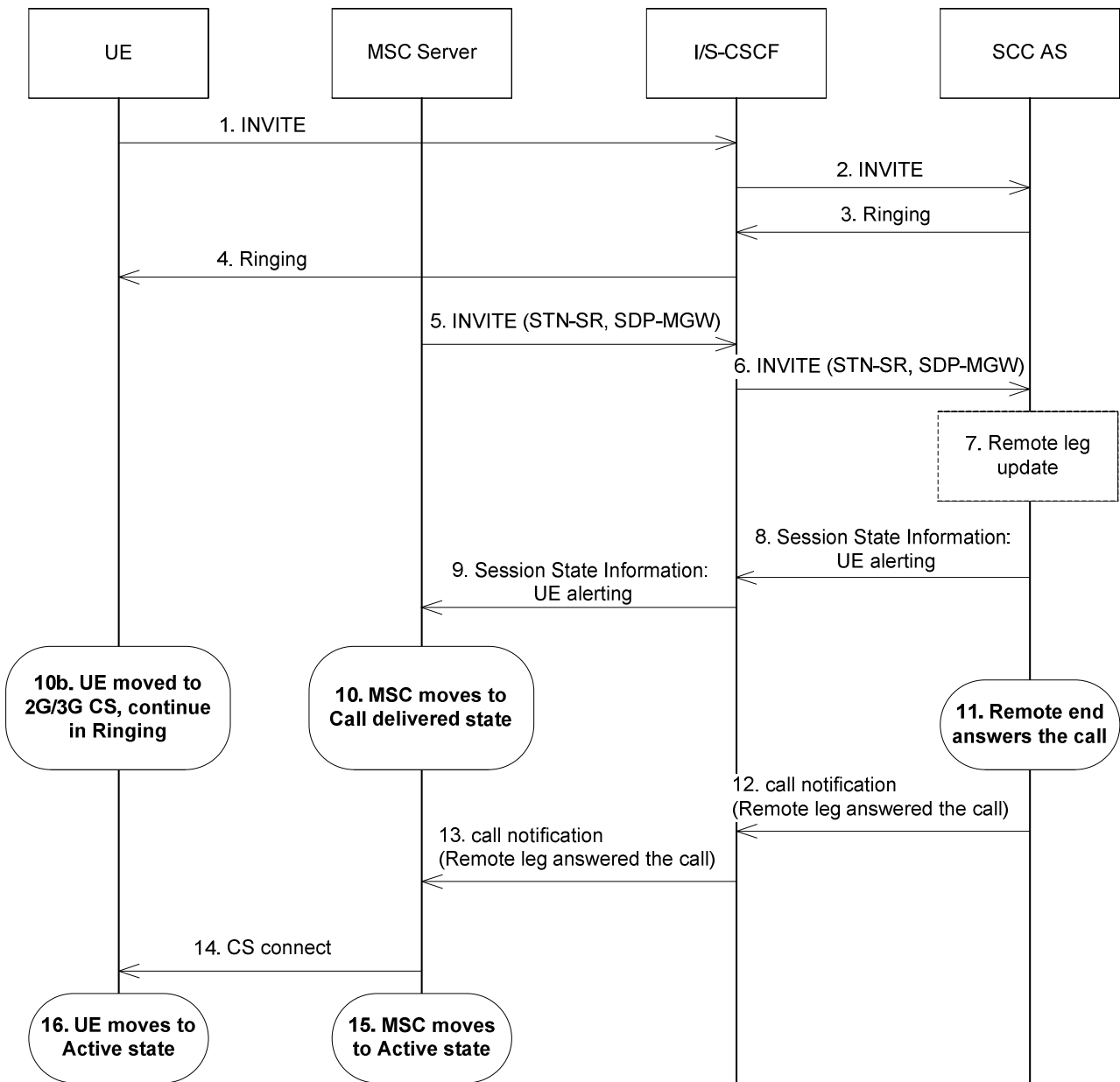

Figure 6.3.2.1.4d-1: PS-CS: PS to CS – Single Radio, outgoing call in alerting phase

1-4. Standard procedures are used to initiate a SIP session from the UE towards the remote end. The remote end is alerting the user for the incoming voice session.

...

10. The MSC moves to the corresponding CS call state, e.g. Call Delivered in TS 24.008 [24].

10b. In parallel to step 10, the UE has received the HO command as described in TS 23.216 [10]. The UE determines the local call state in the SIP session, and creates the corresponding CS call state, e.g. Call Delivered in TS 24.008 [24]. The UE ensures that the same ring back tone is played to the end user.

...

14. The MSC uses the standard procedure to send the CS connect message to UE as e.g. described in TS 24.008 [24].

15. The MSC moves to Active state.

16. The UE moves to Active state.

[TS 23.216, clause 6.2.2.2]

Depicted in figure 6.2.2.2-1 is a call flow for SRVCC from E-UTRAN to UTRAN or GERAN with DTM HO support, including the handling of the non-voice component. The flow requires that eNB can determine that either the target is UTRAN with PS HO or the target is GERAN with DTM support and the UE is supporting DTM.

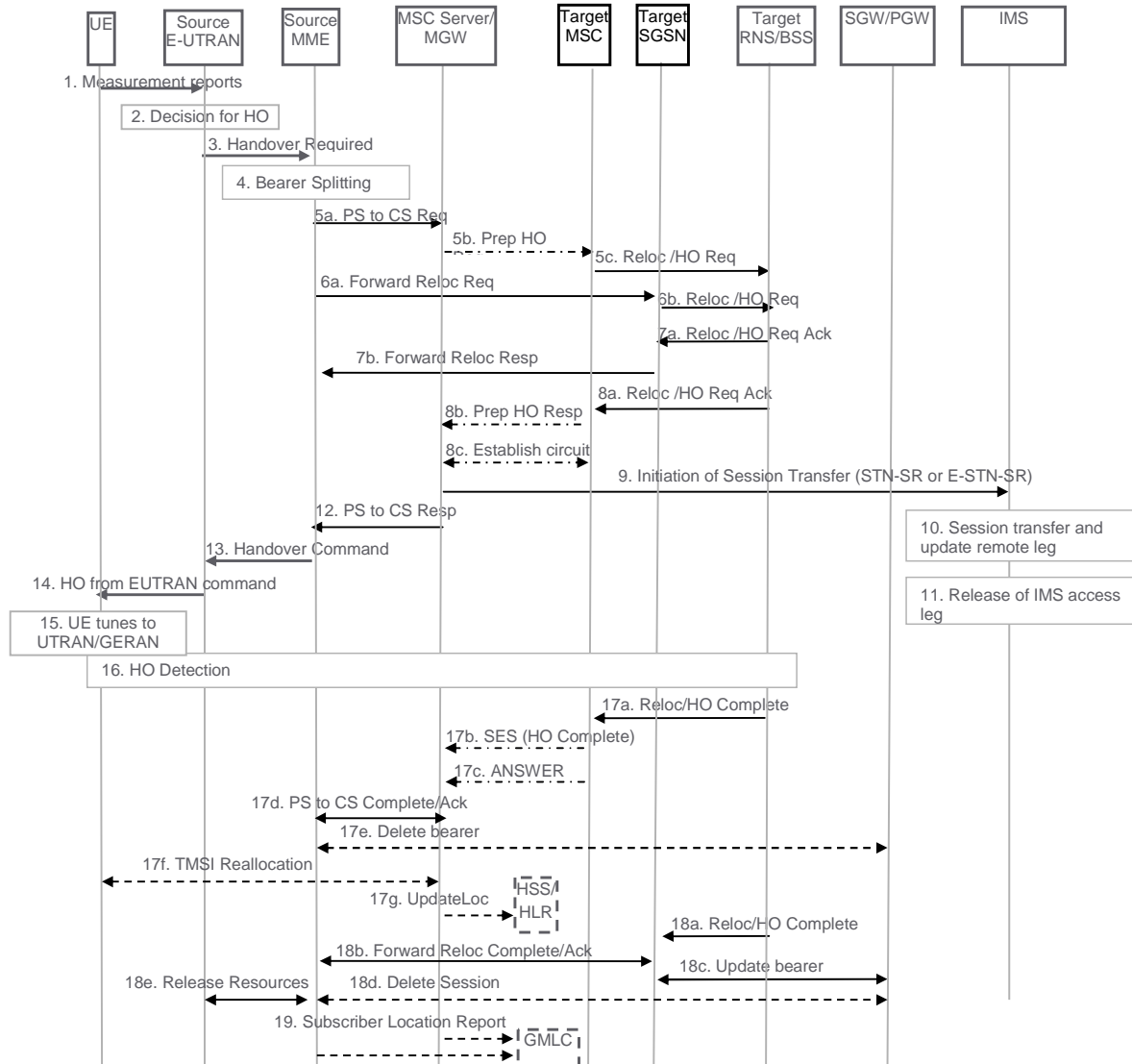

Figure 6.2.2.2-1: SRVCC from E-UTRAN to UTRAN with PS HO or GERAN with DTM HO support

1. UE sends measurement reports to E-UTRAN.

...

14. E-UTRAN sends a Handover from E-UTRAN Command message to the UE.

15. UE tunes to the target UTRAN/GERAN cell.

16. Handover Detection at the target RNS/BSS occurs. The UE sends a Handover Complete message via the target RNS/BSS to the target MSC. If the target MSC is not the MSC Server, then the Target MSC sends an SES (Handover Complete) message to the MSC Server. At this stage, the UE re-establishes the connection with the network and can send/receive voice data.

17. The CS relocation/handover is complete. The following steps are performed:

- a) Target RNS/BSS sends Relocation Complete/Handover Complete message to the target MSC.
- b) Target MSC sends an SES (Handover Complete) message to the MSC Server. The speech circuit is through connected in the MSC Server/MGW according to TS 23.009 [18].
- c) Completion of the establishment procedure with ISUP Answer message to the MSC Server according to TS 23.009 [18].
- d) MSC Server sends a SRVCC PS to CS Complete Notification message to the source MME. Source MME acknowledges the information by sending a SRVCC PS to CS Complete Acknowledge message to the MSC Server.
- e) The source MME deactivates the voice bearer towards S-GW/P-GW and sets the PS-to-CS handover indicator to Delete Bearer Command message. This triggers MME-initiated Dedicated Bearer Deactivation procedure as specified in TS 23.401 [2]. The MME does not send deactivation request toward the eNodeB on receiving PS-to-CS Complete Notification in step 17d. If dynamic PCC is deployed, the PGW may interact with PCRF as defined in TS 23.203 [31].
- f) If the HLR is to be updated, i.e. if the IMSI is authenticated but unknown in the VLR, the MSC Server performs a TMSI reallocation towards the UE using its own non-broadcast LAI and, if the MSC Server and other MSC/VLRs serve the same (target) LAI, with its own Network Resource Identifier (NRI).

NOTE 9: The TMSI reallocation is performed by the MSC Server towards the UE via target MSC.

- g) If the MSC Server performed a TMSI reallocation in step 17f, and if this TMSI reallocation was completed successfully, the MSC Server performs a MAP Update Location to the HSS/HLR.

NOTE 10: This Update Location is not initiated by the UE.

[TS 24.237, clause 12.1]

In order to fulfil the requirements for PS-CS access transfer in SR-VCC for calls in alerting state, the SC UE needs to be engaged in a session with speech media component in early dialog state according to the following conditions before SR-VCC access transfer is performed:

- a SIP 180 (Ringing) response for the initial SIP INVITE request to establish this session has been sent or received; and
- a SIP final response for the initial SIP INVITE request to establish this session has not been sent or received.

[TS 24.237, clause 12.2.3B.1]

The SC UE shall apply the procedures in subclauses 12.2.3B.3 for access transfer for calls in alerting state if:

- 1) the SC UE supports single radio PS to CS access transfer for calls in alerting state; and
- 2) there are one or more early dialogs created by the same SIP INVITE request with at least one dialog that is an early dialog supporting a session with active speech media component where the SC UE:
 - has sent a Contact header field in a SIP INVITE request or 180 (Ringing) response containing the g.3gpp.srvcc-alerting media feature tag (as described in annex C); and
 - has received a Feature-Caps header field in a SIP INVITE request or 180 (Ringing) response containing the g.3gpp.srvcc-alerting feature capability indicator (as described in annex C).

[TS 24.237, clause 12.2.3B.2]

If the SC UE applies the procedures in subclause 12.2.3B.3 and the SC UE only has a single call in alerting state following access transfer, then the SC UE shall associate this session with transaction identifier value and TI flag as described in 3GPP TS 24.008 [8].

[TS 24.237, clause 12.2.3B.3.2]

If the SC UE has initiated an outgoing call which is in the early dialog state according to the conditions in subclauses 12.1 and 12.2.3B.1 and the SC UE successfully performs access transfer to the CS domain, then the UE continues in Ringing state in CS, i.e. UE moves to Call Delivered (U4) state as described in 3GPP TS 24.008 [8].

[TS 24.237, clause A.17.6]

In the example flow at the figure A.17.6-1, SC UE A initiates an originating session with speech media component which has received several forked responses. The call is anchored at SCC AS and in alerting phase. Based upon measurement reports sent from the UE to E-UTRAN, the source E-UTRAN decides to trigger a SRVCC handover to CS access.

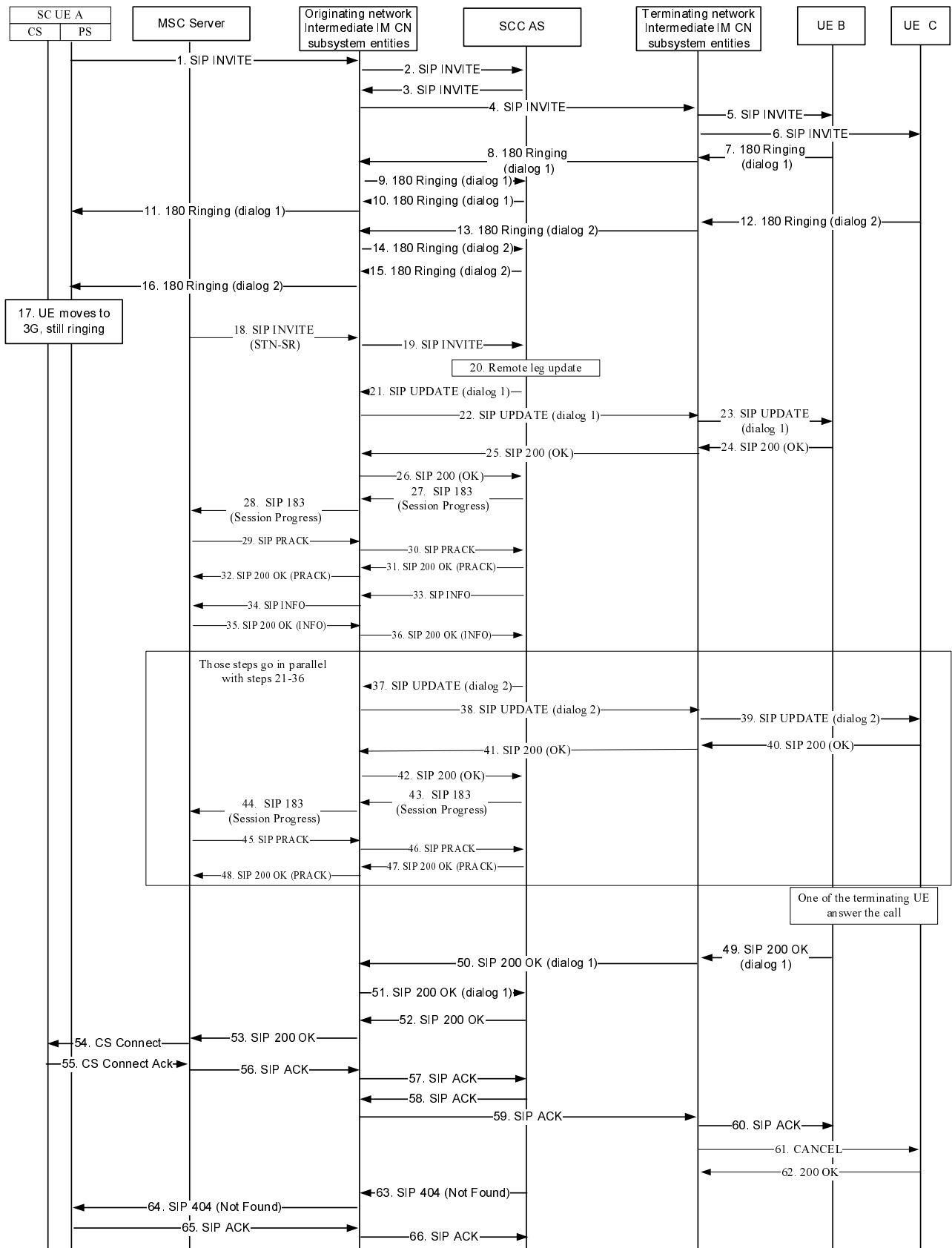

Figure A.17.6-1: PS-CS SRVCC, incoming call in alerting phase with forked responses

[TS 24.008, clause 5.2.4.2]

If the MS supports single radio PS to CS access transfer for calls in alerting state as specified in 3GPP TS 24.237 [136] subclause 12.2.3B, and the MS has a single voice media stream over the PS domain that is handed over to the CS domain via SRVCC, and the call control entity in "null" state receives an indication "MM connection establishment due to SRVCC handover", then:

- if the voice media stream is associated with a mobile originated session in the "early" state (defined in IETF RFC 3261 [137]) according to the conditions specified in 3GPP TS 24.237 [136] subclause 12.2.3B.3.2, the call control entity of the MS shall enter the "call delivered" state for this transaction. The MS and the network shall locally set the TI value of the call to "000" and the TI flag value as in mobile terminated call; and

...

If the MS has additional voice media streams carried over the PS domain that are handed over to the CS domain via SRVCC, the state for the transactions and the setting of the TI value and TI flag for these additional media streams is described in 3GPP TS 24.237 [136].

13.4.3.8.3 Test description

13.4.3.8.3.1 Pre-test conditions

System Simulator:

- Cell 1 and Cell 5.
- System information combination 4 as defined in TS 36.508 [18] clause 4.4.3.1 is used in E-UTRA cell.

UE:

None.

Preamble:

- The UE is in state Registered, Idle mode (state 2) on Cell 1 according to [18].

13.4.3.8.3.2 Test procedure sequence

Table 13.4.3.1.3.2-1 illustrates the downlink power levels and other changing parameters to be applied for the cells at various time instants of the test execution. Row marked "T0" denotes the initial conditions after preamble, while columns marked "T1" is to be applied subsequently. The exact instants on which these values shall be applied are described in the texts in this clause.

Table 13.4.3.8.3.2-1: Time instances of cell power level and parameter changes

	Parameter	Unit	Cell 1	Cell 5	Remark
T0	Cell-specific RS EPRE	dBm/15k Hz	-60	-	The power level values are such that entering conditions for event B2 are not satisfied.
	CPICH_Ec (UTRA FDD)	dBm/3.8 4 MHz	-	-88	
	PCCPCH_Ec (UTRA LCR TDD)	dBm/1.2 8 MHz	-	-88	
T1	Cell-specific RS EPRE	dBm/15k Hz	-84	-	The power level values are such that entering conditions for event B2 are satisfied.
	CPICH_Ec (UTRA FDD)	dBm/3.8 4 MHz	-	-64	
	PCCPCH_Ec (UTRA LCR TDD)	dBm/1.2 8 MHz	-	-64	

Table 13.4.3.8.3.2-2: Main behaviour

St	Procedure	Message Sequence		TP	Verdict
		U - S	Message		
1	The SS configures UTRA Cell 5 to reference configuration according 36.508 Table 4.8.3-1, condition UTRA Speech.	-	-	-	-
2-13	Steps 1 to 12 of the generic test procedure for IMS MO speech call (TS 36.508 4.5A.6.3-1).	-	-	-	-
-	EXCEPTION: In parallel to the events described in steps 14 to 15 the steps specified in Table 13.4.3.8.3.2-3 should take place.	-	-	-	-
14	The UE transmits an <i>RRCCONNECTIONRECONFIGURATIONCOMPLETE</i> message on Cell 1 to confirm the establishment of the new data radio bearer, associated with the dedicated EPS bearer.	-->	<i>RRCCONNECTIONRECONFIGURATIONCOMPLETE</i>	-	-
15	The UE transmits an ACTIVATE DEDICATED EPS BEARER CONTEXT ACCEPT message on Cell 1.	-->	ACTIVATE DEDICATED EPS BEARER CONTEXT ACCEPT	-	-
16	Expected sequence defined in annex C.27 of TS 34.229-1 [35]. NOTE: The UE receives forked response.	-	-	-	-
17	The SS transmits an <i>RRCCONNECTIONRECONFIGURATION</i> message on Cell 1 to setup inter-RAT measurement and reporting for event B2.	<--	<i>RRCCONNECTIONRECONFIGURATION</i>	-	-
18	The UE transmits an <i>RRCCONNECTIONRECONFIGURATIONCOMPLETE</i> message on Cell 1.	-->	<i>RRCCONNECTIONRECONFIGURATIONCOMPLETE</i>	-	-
19	The SS changes the power level for Cell 1 and Cell 5 according to the row "T1" in Table 13.4.3.8.3.2-1.	-	-	-	-
20	The UE transmits a <i>MEASUREMENTREPORT</i> message on Cell 1 to report event B2 for Cell 5.	-->	<i>MEASUREMENTREPORT</i>	-	-
21	The SS transmits a <i>UECAPABILITYENQUIRY</i> message on Cell 1 to request UE radio access capability information for E-UTRA and UTRA.	<--	<i>UECAPABILITYENQUIRY</i>	-	-
22	The UE transmit a <i>UECAPABILITYINFORMATION</i> message on Cell 1. NOTE: The start-CS values received, should be used to configure ciphering on Cell 5.	-->	<i>UECAPABILITYINFORMATION</i>	-	-
23	The SS transmits a <i>MOBILITYFROMEUTRACOMMAND</i> message on Cell 1.	<--	<i>MOBILITYFROMEUTRACOMMAND</i>	-	-
24	Check: Does the UE transmit a HANDOVER TO UTRAN COMPLETE message on Cell 5?	-->	HANDOVER TO UTRAN COMPLETE	1	P
-	EXCEPTION: In parallel to the events described in step 25 to 30 the steps specified in Table 13.4.3.8.3.2-4 takes place.	-	-	-	-
25	The SS transmits a SECURITY MODE COMMAND message for the CS domain on Cell 5.	<--	SECURITY MODE COMMAND	-	-
26	The UE transmits a SECURITY MODE COMPLETE message on Cell 5.	-->	SECURITY MODE COMPLETE	-	-
27	The SS transmits an UTRAN MOBILITY INFORMATION message on Cell 5 to notify CN information.	<--	UTRAN MOBILITY INFORMATION	-	-
28	The UE transmits an UTRAN MOBILITY INFORMATION CONFIRM message on Cell 5.	-->	UTRAN MOBILITY INFORMATION CONFIRM	-	-
29	The SS transmits a TMSI REALLOCATION COMMAND message on Cell 5.	<--	TMSI REALLOCATION COMMAND	-	-
30	The UE transmits a TMSI REALLOCATION COMPLETE message on Cell 5.	-->	TMSI REALLOCATION COMPLETE	-	-
31	The SS transmits a CONNECT message on Cell 5.	<--	CONNECT	-	-

32	Check: Does the UE transmit a CONNECT ACKNOWLEDGE message on Cell 5?	-->	CONNECT ACKNOWLEDGE	2	P
----	--	-----	---------------------	---	---

Table 13.4.3.8.3.2-3: Parallel behaviour

St	Procedure	Message Sequence		TP	Verdict
		U - S	Message		
1-7	Steps 5-11 expected sequence defined in annex C.21 of TS 34.229-1 [35]. NOTE: IMS MO speech call is in alerting phase.	-	-	-	-

Table 13.4.3.8.3.2-4: Parallel behaviour

St	Procedure	Message Sequence		TP	Verdict
		U - S	Message		
1	The UE transmits a ROUTING AREA UPDATE REQUEST message on Cell 5.	-->	ROUTING AREA UPDATE REQUEST	-	-
2	The SS transmits a SECURITY MODE COMMAND message for the PS domain on Cell 5.	<--	SECURITY MODE COMMAND	-	-
3	The UE transmits a SECURITY MODE COMPLETE message on Cell 5.	-->	SECURITY MODE COMPLETE	-	-
4	The SS transmits a ROUTING AREA UPDATE ACCEPT message on Cell 5.	<--	ROUTING AREA UPDATE ACCEPT	-	-
5	The UE transmits a ROUTING AREA UPDATE COMPLETE message on Cell 5.	-->	ROUTING AREA UPDATE COMPLETE	-	-

13.4.3.8.3.3 Specific message contents

Table 13.4.3.8.3.3-1: ATTACH REQUEST (preamble)

Derivation path: 36.508 Table 4.7.2-4			
Information Element	Value/remark	Comment	Condition
MS network capability	SRVCC from UTRAN HSPA or E-UTRAN to GERAN/UTRAN supported		
Mobile station classmark 2	Any allowed value		
Supported Codecs	Any allowed value		
Old GUTI type	Any allowed value		

Table 13.4.3.8.3.3-2: RRCConnectionReconfiguration (step 17, Table 13.4.3.8.3.2-2)

Derivation Path: 36.508, Table 4.6.1-8, condition MEAS
--

Table 13.4.3.8.3.3-3: MeasConfig (Table 13.4.3.8.3.3-2)

Derivation Path: 36.508, Table 4.6.6-1, condition UTRAN			
Information Element	Value/remark	Comment	Condition
MeasConfig ::= SEQUENCE {			
measObjectToAddModList SEQUENCE (SIZE (1..maxObjectId)) OF SEQUENCE {	2 entries		
measObjectId[1]	IdMeasObject-f1		
measObject[1]	MeasObjectEUTRA-GENERIC(f1)		
measObjectId[2]	IdMeasObject-f8		
measObject[2]	MeasObjectUTRA-f8		
}			
reportConfigToAddModList SEQUENCE (SIZE (1..maxReportConfigId)) OF SEQUENCE {	1 entry		
reportConfigId[1]	IdReportConfig-B2-UTRA		
reportConfig[1]	ReportConfigInterRAT-B2-UTRA (-72, -76)		
}			
measIdToAddModList SEQUENCE (SIZE (1..maxMeasId)) OF SEQUENCE {	1 entry		
measId[1]	1		
measObjectId[1]	IdMeasObject-f8		
reportConfigId[1]	IdReportConfig-B2-UTRA		
}			
}			

Table 13.4.3.8.3.3-4: MeasObjectUTRA-f8 (Table 13.4.3.8.3.3-3)

Derivation Path: 36.508, Table 4.6.6-3			
Information Element	Value/remark	Comment	Condition
MeasObjectUTRA ::= SEQUENCE {			
carrierFreq	Same downlink ARFCN as used for Cell 5		
cellsToAddModList CHOICE {			
cellsToAddModListUTRA-FDD SEQUENCE (SIZE (1..maxCellMeas)) OF SEQUENCE {	1 entry		UTRA-FDD
cellIndex[1]	1		
physCellId[1]	PhysicalCellIdentity of Cell 5		
}			
cellsToAddModListUTRA-TDD SEQUENCE (SIZE (1..maxCellMeas)) OF SEQUENCE {			UTRA-TDD
cellIndex[1]	1		
physCellId[1]	PhysicalCellIdentity of Cell 5		
}			
}			
csg-allowedReportingCells-v930	Not present		
}			

Condition	Explanation
UTRA-FDD	UTRA FDD cell environment
UTRA-TDD	UTRA TDD cell environment

Table 13.4.3.8.3.3-5: *MeasurementReport* (step 20, Table 13.4.3.8.3.2-2)

Derivation Path: 36.508, Table 4.6.1-5			
Information Element	Value/remark	Comment	Condition
MeasurementReport ::= SEQUENCE {			
criticalExtensions CHOICE {			
c1 CHOICE {			
measurementReport-r8 SEQUENCE {			
measResults SEQUENCE {			
measId	1		
measResultPCell SEQUENCE {			
rsrpResult	(0..97)		
rsrqResult	(0..34)		
}			
measResultNeighCells CHOICE {			
measResultListUTRA SEQUENCE (SIZE (1..maxCellReport)) OF SEQUENCE {	1 entry		
physCellId[1] CHOICE {			
fdd	PhysicalCellIdentity of Cell 5		UTRA-FDD
tdd	PhysicalCellIdentity of Cell 5		UTRA-TDD
}			
}			
cgi-Info[1]	Not present		
measResult[1] SEQUENCE {			
utra-RSCP	(-5..91)		
utra-EcN0	Not present		
additionalSI-Info-r9	Not present		
}			
}			
}			
measResultForECID-r9	Not present		
locationInfo-r10	Not present		
measResultServFreqList-r10	Not present		
}			
}			
}			
}			
}			
}			
}			

Condition	Explanation
UTRA-FDD	UTRA FDD cell environment
UTRA-TDD	UTRA TDD cell environment

Table 13.4.3.8.3.3-6: *UECapabilityEnquiry* (step 21, Table 13.4.3.8.3.2-2)

Derivation Path: 36.508, Table 4.6.1-22			
Information Element	Value/remark	Comment	Condition
UECapabilityEnquiry ::= SEQUENCE {			
criticalExtensions CHOICE {			
c1 CHOICE {			
ueCapabilityEnquiry-r8 SEQUENCE {			
ue-CapabilityRequest (SIZE (1..maxRAT-Capabilities)) OF SEQUENCE {	2 entries		
RAT-Type[1]	eutra		
RAT-Type[2]	utra		
}			
}			
}			
}			
}			
}			
}			

Table 13.4.3.8.3.3-7: MobilityFromEUTRACommand (step 23, Table 13.4.3.8.3.2-2)

Derivation Path: 36.508, Table 4.6.1-6			
Information Element	Value/remark	Comment	Condition
MobilityFromEUTRACommand ::= SEQUENCE {			
criticalExtensions CHOICE {			
c1 CHOICE {			
mobilityFromEUTRACommand-r8 SEQUENCE {			
cs-FallbackIndicator	True		
purpose CHOICE {			
handover SEQUENCE {			
targetRAT-Type	utra		
targetRAT-MessageContainer	HANDOVER TO UTRAN COMMAND(UTRA RRC message)		
nas-SecurityParamFromEUTRA	The 4 least significant bits of the NAS downlink COUNT value		
systemInformation	Not present		
}			
}			
}			
}			
}			
}			
}			

Table 13.4.3.8.3.3-8: HANDOVER TO UTRAN COMMAND (Table 13.4.3.8.3.3-7)

Derivation Path: 36.508, Table 4.7B.1-1, condition UTRA Speech			

Table 13.4.3.8.3.3-9: SECURITY MODE COMMAND (step 25 Table 13.4.3.8.3.2-2)

Derivation Path: 36.508, Table 4.7B.1-n			
Information Element	Value/remark	Comment	Condition
Ciphering mode info	Not present		

Table 13.4.3.8.3.3-10: CONNECT (step 31, Table 13.4.3.8.3.2-2)

Derivation Path: TS 24.008 Table 9.59			
Information Element	Value/remark	Comment	Condition
Transaction identifier			
TI flag	'0'B	The message is sent from the side that originates the TI	
TIO	'000'B	TI value 0	

Table 13.4.3.8.3.3-11: CONNECT ACKNOWLEDGE (step 32, Table 13.4.3.8.3.2-2)

Derivation Path: TS 24.008 Table 9.60			
Information Element	Value/remark	Comment	Condition
Transaction identifier			
TI flag	'1'B	The message is sent to the side that originates the TI	
TIO	'000'B	TI value 0	

13.4.3.9 Inter-system mobility / E-UTRA voice to UTRA CS voice / aSRVCC / MO call / SRVCC HO failure

13.4.3.9.1 Test Purpose (TP)

(1)

```
with { UE is in E-UTRA RRC_CONNECTED state, an IMS MO speech call is in alerting phase and UE
receives a MobilityFromEUTRACommand message }
ensure that {
  when { UE detects radio link failure }
  then { UE transmits SIP UPDATE message after RRC connection re-establishment procedure }
}
```

13.4.3.9.2 Conformance requirements

References: The conformance requirements covered in the present TC are specified in: TS 36.331, clauses 5.4.3.3, 5.4.3.5, 5.3.7.2, 5.3.7.3, 5.3.7.4, 5.3.7.5 and TS 24.237, clause 12.2.4.2.

[TS 36.331, clause 5.4.3.3]

The UE shall:

- 1> stop timer T310, if running;
- 1> if the *MobilityFromEUTRACommand* message includes the *purpose* set to *handover*:
 - 2> if the *targetRAT-Type* is set to *utra* or *geran*:
 - 3> consider inter-RAT mobility as initiated towards the RAT indicated by the *targetRAT-Type* included in the *MobilityFromEUTRACommand* message;
 - 3> forward the *nas-SecurityParamFromEUTRA* to the upper layers;
 - 3> access the target cell indicated in the inter-RAT message in accordance with the specifications of the target RAT;

[TS 36.331, clause 5.4.3.5]

The UE shall:

- 1> if T304 expires (mobility from E-UTRA failure); or
- 1> if the UE does not succeed in establishing the connection to the target radio access technology; or
- 1> if the UE is unable to comply with (part of) the configuration included in the *MobilityFromEUTRACommand* message; or
- 1> if there is a protocol error in the inter RAT information included in the *MobilityFromEUTRACommand* message, causing the UE to fail the procedure according to the specifications applicable for the target RAT:
 - 2> stop T304, if running;
 - 2> if the *cs-FallbackIndicator* in the *MobilityFromEUTRACommand* message was set to *TRUE*:
 - 3> indicate to upper layers that the CS Fallback procedure has failed;
 - 2> revert back to the configuration used in the source PCell, excluding the configuration configured by the *physicalConfigDedicated*, *mac-MainConfig* and *sps-Config*;
 - 2> initiate the connection re-establishment procedure as specified in 5.3.7;

[TS 36.331, clause 5.3.7.2]

The UE shall only initiate the procedure when AS security has been activated. The UE initiates the procedure when one of the following conditions is met:

...

1> upon mobility from E-UTRA failure, in accordance with 5.4.3.5; or

...

Upon initiation of the procedure, the UE shall:

- 1> stop timer T310, if running;
- 1> start timer T311;
- 1> suspend all RBs except SRB0;
- 1> reset MAC;
- 1> release the SCell(s), if configured, in accordance with 5.3.10.3a;
- 1> apply the default physical channel configuration as specified in 9.2.4;
- 1> apply the default semi-persistent scheduling configuration as specified in 9.2.3;
- 1> apply the default MAC main configuration as specified in 9.2.2;
- 1> release *reportProximityConfig* and clear any associated proximity status reporting timer;
- 1> release *measSubframePatternPCell*, if configured;

...

1> perform cell selection in accordance with the cell selection process as specified in TS 36.304 [4];

[TS 36.331, clause 5.3.7.3]

Upon selecting a suitable E-UTRA cell, the UE shall:

- 1> stop timer T311;
- 1> start timer T301;
- 1> apply the *timeAlignmentTimerCommon* included in *SystemInformationBlockType2*;
- 1> initiate transmission of the *RRCCConnectionReestablishmentRequest* message in accordance with 5.3.7.4;

[TS 36.331, clause 5.3.7.4]

If the procedure was initiated due to radio link failure or handover failure, the UE shall:

- 1> set the *reestablishmentCellId* in the *VarRLF-Report* to the global cell identity of the selected cell;

The UE shall set the contents of *RRCCConnectionReestablishmentRequest* message as follows:

- 1> set the *ue-Identity* as follows:
 - 2> set the *c-RNTI* to the C-RNTI used in the source PCell (handover and mobility from E-UTRA failure) or used in the PCell in which the trigger for the re-establishment occurred (other cases);
 - 2> set the *physCellId* to the physical cell identity of the source PCell (handover and mobility from E-UTRA failure) or of the PCell in which the trigger for the re-establishment occurred (other cases);
 - 2> set the *shortMAC-I* to the 16 least significant bits of the MAC-I calculated:
 - 3> over the ASN.1 encoded as per section 8 (i.e., a multiple of 8 bits) *VarShortMAC-Input*;
 - 3> with the K_{RRCint} key and integrity protection algorithm that was used in the source PCell (handover and mobility from E-UTRA failure) or of the PCell in which the trigger for the re-establishment occurred (other cases); and
 - 3> with all input bits for COUNT, BEARER and DIRECTION set to binary ones;

- 1> set the *reestablishmentCause* as follows:

...

2> else if the re-establishment procedure was initiated due to handover failure as specified in 5.3.5.6 (intra-LTE handover failure) or 5.4.3.5 (inter-RAT mobility from EUTRA failure):

3> set the *reestablishmentCause* to the value *handoverFailure*;

The UE shall submit the *RRCCConnectionReestablishmentRequest* message to lower layers for transmission.

[TS 36.331, clause 5.3.7.5]

The UE shall:

1> stop timer T301;

1> consider the current cell to be the PCell;

1> re-establish PDCP for SRB1;

1> re-establish RLC for SRB1;

1> perform the radio resource configuration procedure in accordance with the received *radioResourceConfigDedicated* and as specified in 5.3.10;

1> resume SRB1;

NOTE: E-UTRAN should not transmit any message on SRB1 prior to receiving the *RRCCConnectionReestablishmentComplete* message.

1> update the K_{eNB} key based on the K_{ASME} key to which the current K_{eNB} is associated, using the *nextHopChainingCount* value indicated in the *RRCCConnectionReestablishment* message, as specified in TS 33.401 [32];

1> store the *nextHopChainingCount* value;

1> derive the K_{RRCint} key associated with the previously configured integrity algorithm, as specified in TS 33.401 [32];

1> derive the K_{RRCenc} key and the K_{UPenc} key associated with the previously configured ciphering algorithm, as specified in TS 33.401 [32];

...

1> configure lower layers to activate integrity protection using the previously configured algorithm and the K_{RRCint} key immediately, i.e., integrity protection shall be applied to all subsequent messages received and sent by the UE, including the message used to indicate the successful completion of the procedure;

...

1> configure lower layers to apply ciphering using the previously configured algorithm, the K_{RRCenc} key and the K_{UPenc} key immediately, i.e., ciphering shall be applied to all subsequent messages received and sent by the UE, including the message used to indicate the successful completion of the procedure;

1> set the content of *RRCCConnectionReestablishmentComplete* message as follows:

2> if the UE has radio link failure or handover failure information available in *VarRLF-Report* and *plmn-Identity* stored in *VarRLF-Report* is equal to the RPLMN:

3> include the *rlf-InfoAvailable*;

...

1> perform the measurement related actions as specified in 5.5.6.1;

1> perform the measurement identity autonomous removal as specified in 5.5.2.2a;

1> submit the *RRCCConnectionReestablishmentComplete* message to lower layers for transmission, upon which the procedure ends;

[TS 24.237, clause 12.2.4.2]

If the SC UE is engaged in a session in early dialog state and:

...

- does not successfully retune to the 3GPP UTRAN or 3GPP GERAN after it receives the handover command from the eNodeB (as described in 3GPP TS 36.331 [62]) or from the NodeB (as described in 3GPP TS 25.331 [61]);

then if the SC UE the SC UE shall send a SIP UPDATE request containing:

- 1) an SDP offer, including the media characteristics as used in the existing dialog; and
- 2) a Reason header field containing protocol "SIP" and reason parameter "cause" with value "487" as specified in IETF RFC 3326 [57], and with reason-text set to either "handover cancelled" or "failure to transition to CS domain";

by following the rules of 3GPP TS 24.229 [2] in each transferred session.

13.4.3.9.3 Test description

13.4.3.9.3.1 Pre-test conditions

System Simulator:

- Cell 1 and Cell 5.
- System information combination 4 as defined in TS 36.508 [18] clause 4.4.3.1 is used in E-UTRA cell.

UE:

None.

Preamble:

- The UE is in state Registered, Idle mode (state 2) on Cell 1 according to [18].

13.4.3.9.3.2 Test procedure sequence

Table 13.4.3.9.3.2-1 illustrates the downlink power levels and other changing parameters to be applied for the cells at various time instants of the test execution. Row marked "T0" denotes the initial conditions after preamble, while columns marked "T1" and "T2" are to be applied subsequently. The exact instants on which these values shall be applied are described in the texts in this clause.

Table 13.4.3.9.3.2-1: Time instances of cell power level and parameter changes

	Parameter	Unit	Cell 1	Cell 5	Remark
T0	Cell-specific RS EPRE	dBm/15k Hz	-60	-	The power level values are such that entering conditions for event B2 are not satisfied.
	CPICH_Ec (UTRA FDD)	dBm/3.8 4 MHz	-	-88	
	PCCPCH_Ec (UTRA LCR TDD)	dBm/1.2 8 MHz	-	-88	
T1	Cell-specific RS EPRE	dBm/15k Hz	-84	-	The power level values are such that entering conditions for event B2 are satisfied.
	CPICH_Ec (UTRA FDD)	dBm/3.8 4 MHz	-	-64	
	PCCPCH_Ec (UTRA LCR TDD)	dBm/1.2 8 MHz	-	-64	
T2	Cell-specific RS EPRE	dBm/15k Hz	-85	-	Only Cell 1 is available. (NOTE 1)
	CPICH_Ec (UTRA FDD)	dBm/3.8 4 MHz	-	"Off"	
	PCCPCH_Ec (UTRA LCR TDD)	dBm/1.2 8 MHz	-	"Off"	

	TDD)				
NOTE 1: Power level "Off" for UTRA cell is defined in TS 34.108 Table 6.1.4 and Table 6.1.9.					

Table 13.4.3.9.3.2-2: Main behaviour

St	Procedure	Message Sequence		TP	Verdict
		U - S	Message		
1	The SS configures UTRA Cell 5 to reference configuration according 36.508 Table 4.8.3-1, condition UTRA Speech.	-	-	-	-
2-13	Steps 1 to 12 of the generic test procedure for IMS MO speech call (TS 36.508 4.5A.6.3-1).	-	-	-	-
-	EXCEPTION: In parallel to the events described in steps 14 to 15 the steps specified in Table 13.4.3.9.3.2-3 should take place.	-	-	-	-
14	The UE transmits an <i>RRCCONNECTIONRECONFIGURATIONCOMPLETE</i> message on Cell 1 to confirm the establishment of the new data radio bearer, associated with the dedicated EPS bearer.	-->	<i>RRCCONNECTIONRECONFIGURATIONCOMPLETE</i>	-	-
15	The UE transmits an ACTIVATE DEDICATED EPS BEARER CONTEXT ACCEPT message on Cell 1.	-->	ACTIVATE DEDICATED EPS BEARER CONTEXT ACCEPT	-	-
16	The SS transmits an <i>RRCCONNECTIONRECONFIGURATION</i> message on Cell 1 to setup inter-RAT measurement and reporting for event B2.	<--	<i>RRCCONNECTIONRECONFIGURATION</i>	-	-
17	The UE transmits an <i>RRCCONNECTIONRECONFIGURATIONCOMPLETE</i> message on Cell 1.	-->	<i>RRCCONNECTIONRECONFIGURATIONCOMPLETE</i>	-	-
18	The SS changes the power level for Cell 1 and Cell 5 according to the row "T1" in Table 13.4.3.9.3.2-1.	-	-	-	-
19	The UE transmits a <i>MEASUREMENTREPORT</i> message on Cell 1 to report event B2 for Cell 5.	-->	<i>MEASUREMENTREPORT</i>	-	-
20	The SS changes the power level for Cell 1 and Cell 5 according to the row "T2" in Table 13.4.3.9.3.2-1.	-	-	-	-
21	The SS transmits a <i>UECAPABILITYENQUIRY</i> message on Cell 1 to request UE radio access capability information for E-UTRA and UTRA.	<--	<i>UECAPABILITYENQUIRY</i>	-	-
22	The UE transmit a <i>UECAPABILITYINFORMATION</i> message on Cell 1. NOTE: The start-CS values received, should be used to configure ciphering on Cell 5.	-->	<i>UECAPABILITYINFORMATION</i>	-	-
23	The SS transmits a <i>MOBILITYFROMEUTRACOMMAND</i> message on Cell 1.	<--	<i>MOBILITYFROMEUTRACOMMAND</i>	-	-
24	The UE transmits an <i>RRCCONNECTIONREESTABLISHMENTREQUEST</i> message on Cell 1.	-->	<i>RRCCONNECTIONREESTABLISHMENTREQUEST</i>	-	-
25	The SS transmits an <i>RRCCONNECTIONREESTABLISHMENT</i> message on Cell 1.	<--	<i>RRCCONNECTIONREESTABLISHMENT</i>	-	-
26	The UE transmits an <i>RRCCONNECTIONREESTABLISHMENTCOMPLETE</i> message on Cell 1.	-->	<i>RRCCONNECTIONREESTABLISHMENTCOMPLETE</i>	-	-
27	The SS transmits an <i>RRCCONNECTIONRECONFIGURATION</i> message on Cell 1.	<--	<i>RRCCONNECTIONRECONFIGURATION</i>	-	-
-	EXCEPTION: In parallel to the events described in step 28 the steps specified in Table 13.4.3.9.3.2-4 should take place.	-	-	-	-
28	The UE transmits an <i>RRCCONNECTIONRECONFIGURATIONCOMPLETE</i> message on Cell 1.	-->	<i>RRCCONNECTIONRECONFIGURATIONCOMPLETE</i>	-	-
29-30	Steps 12-13 expected sequence defined in annex C.21 of TS 34.229-1 [35].	-	-	-	-

Table 13.4.3.9.3.2-3: Parallel behaviour

St	Procedure	Message Sequence		TP	Verdict
		U - S	Message		
1-7	Steps 5-11 expected sequence defined in annex C.21 of TS 34.229-1 [35]. NOTE: IMS MO speech call is in alerting phase.	-	-	-	-

Table 13.4.3.9.3.2-4: Parallel behaviour

St	Procedure	Message Sequence		TP	Verdict
		U - S	Message		
1	Check: Does the UE transmit SIP UPDATE request on Cell 1? NOTE: Step 1 defined in annex C.28 of TS 34.229-1 [35] is performed.	-	-	1	P
2	Step 2 expected sequence defined in annex C.28 of TS 34.229-1 [35].	-	-	-	-

13.4.3.9.3.3 Specific message contents

Table 13.4.3.9.3.3-1: ATTACH REQUEST (preamble)

Derivation path: 36.508 Table 4.7.2-4			
Information Element	Value/remark	Comment	Condition
MS network capability	SRVCC from UTRAN HSPA or E-UTRAN to GERAN/UTRAN supported		
Mobile station classmark 2	Any allowed value		
Supported Codecs	Any allowed value		
Old GUTI type	Any allowed value		

Table 13.4.3.9.3.3-2: RRCConnectionReconfiguration (step 16, Table 13.4.3.9.3.2-2)

Derivation Path: 36.508, Table 4.6.1-8, condition MEAS
--

Table 13.4.3.9.3.3-3: MeasConfig (Table 13.4.3.9.3.3-2)

Derivation Path: 36.508, Table 4.6.6-1, condition UTRAN			
Information Element	Value/remark	Comment	Condition
MeasConfig ::= SEQUENCE {			
measObjectToAddModList SEQUENCE (SIZE (1..maxObjectId)) OF SEQUENCE {	2 entries		
measObjectId[1]	IdMeasObject-f1		
measObject[1]	MeasObjectEUTRA-GENERIC(f1)		
measObjectId[2]	IdMeasObject-f8		
measObject[2]	MeasObjectUTRA-f8		
}			
reportConfigToAddModList SEQUENCE (SIZE (1..maxReportConfigId)) OF SEQUENCE {	1 entry		
reportConfigId[1]	IdReportConfig-B2-UTRA		
reportConfig[1]	ReportConfigInterRAT-B2-UTRA (-72, -76)		
}			
measIdToAddModList SEQUENCE (SIZE (1..maxMeasId)) OF SEQUENCE {	1 entry		
measId[1]	1		
measObjectId[1]	IdMeasObject-f8		
reportConfigId[1]	IdReportConfig-B2-UTRA		
}			
}			

Table 13.4.3.9.3.3-4: MeasObjectUTRA-f8 (Table 13.4.3.9.3.3-3)

Derivation Path: 36.508, Table 4.6.6-3			
Information Element	Value/remark	Comment	Condition
MeasObjectUTRA ::= SEQUENCE {			
carrierFreq	Same downlink ARFCN as used for Cell 5		
cellsToAddModList CHOICE {			
cellsToAddModListUTRA-FDD SEQUENCE (SIZE (1..maxCellMeas)) OF SEQUENCE {	1 entry		UTRA-FDD
cellIndex[1]	1		
physCellId[1]	PhysicalCellIdentity of Cell 5		
}			
cellsToAddModListUTRA-TDD SEQUENCE (SIZE (1..maxCellMeas)) OF SEQUENCE {			UTRA-TDD
cellIndex[1]	1		
physCellId[1]	PhysicalCellIdentity of Cell 5		
}			
}			
csg-allowedReportingCells-v930	Not present		
}			

Condition	Explanation
UTRA-FDD	UTRA FDD cell environment
UTRA-TDD	UTRA TDD cell environment

Table 13.4.3.9.3.3-5: MeasurementReport (step 19, Table 13.4.3.9.3.2-2)

Derivation Path: 36.508, Table 4.6.1-5			
Information Element	Value/remark	Comment	Condition
MeasurementReport ::= SEQUENCE {			
criticalExtensions CHOICE {			
c1 CHOICE {			
measurementReport-r8 SEQUENCE {			
measResults SEQUENCE {			
measId	1		
measResultPCell SEQUENCE {			
rsrpResult	(0..97)		
rsrqResult	(0..34)		
}			
measResultNeighCells CHOICE {			
measResultListUTRA SEQUENCE (SIZE (1..maxCellReport)) OF SEQUENCE {	1 entry		
physCellId[1] CHOICE {			
fdd	PhysicalCellIdentity of Cell 5		UTRA-FDD
tdd	PhysicalCellIdentity of Cell 5		UTRA-TDD
}			
cgi-Info[1]	Not present		
measResult[1] SEQUENCE {			
utra-RSCP	(-5..91)		
utra-EcN0	Not present		
additionalSI-Info-r9	Not present		
}			
}			
measResultForECID-r9	Not present		
locationInfo-r10	Not present		
measResultServFreqList-r10	Not present		
}			
}			
}			
}			
}			

Condition	Explanation
UTRA-FDD	UTRA FDD cell environment
UTRA-TDD	UTRA TDD cell environment

Table 13.4.3.9.3.3-6: UECapabilityEnquiry (step 21, Table 13.4.3.9.3.2-2)

Derivation Path: 36.508, Table 4.6.1-22			
Information Element	Value/remark	Comment	Condition
UECapabilityEnquiry ::= SEQUENCE {			
criticalExtensions CHOICE {			
c1 CHOICE {			
ueCapabilityEnquiry-r8 SEQUENCE {			
ue-CapabilityRequest (SIZE (1..maxRAT-Capabilities)) OF SEQUENCE {	2 entries		
RAT-Type[1]	eutra		
RAT-Type[2]	utra		
}			
}			
}			
}			
}			

Table 13.4.3.9.3.3-7: *MobilityFromEUTRACommand* (step 23, Table 13.4.3.9.3.2-2)

Derivation Path: 36.508, Table 4.6.1-6			
Information Element	Value/remark	Comment	Condition
MobilityFromEUTRACommand ::= SEQUENCE {			
criticalExtensions CHOICE {			
c1 CHOICE {			
mobilityFromEUTRACommand-r8 SEQUENCE {			
cs-FallbackIndicator	True		
purpose CHOICE {			
handover SEQUENCE {			
targetRAT-Type	utra		
targetRAT-MessageContainer	HANDOVER TO UTRAN COMMAND(UTRA RRC message)		
nas-SecurityParamFromEUTRA	The 4 least significant bits of the NAS downlink COUNT value		
systemInformation	Not present		
}			
}			
}			
}			
}			
}			

Table 13.4.3.9.3.3-8: HANDOVER TO UTRAN COMMAND (Table 13.4.3.9.3.3-7)

Derivation Path: 36.508, Table 4.7B.1-1, condition UTRA Speech
--

Table 13.4.3.9.3.3-9: *RRCConnectionReestablishmentRequest* (step 24, Table 13.4.3.9.3.2-2)

Derivation Path: 36.508, Table 4.6.1-13			
Information Element	Value/remark	Comment	Condition
RRCConnectionReestablishmentRequest ::= SEQUENCE {			
criticalExtensions CHOICE {			
rrcConnectionReestablishmentRequest-r8 SEQUENCE {			
ue-Identity SEQUENCE {			
c-RNTI	the value of the C-RNTI of the UE		
physCellId	PhysicalCellIdentity of Cell 1		
shortMAC-I	The same value as the 16 least significant bits of the XMAC-I value calculated by SS		
}			
reestablishmentCause	otherFailure		
}			
}			
}			

Table 13.4.3.9.3.3-10: RRCConnectionReestablishmentComplete (step 26, Table 13.4.3.9.3.2-2)

Derivation Path: 36.508, Table 4.6.1-11			
Information Element	Value/remark	Comment	Condition
RRCConnectionReestablishmentComplete ::= SEQUENCE {			
criticalExtensions CHOICE {			
rrcConnectionReestablishmentComplete-r8 = SEQUENCE {			
nonCriticalExtension SEQUENCE {			
rf-InfoAvailable-r9	true		
nonCriticalExtension	Not present or any allowed value		
}			
}			
}			
}			

Table 13.4.3.9.3.3-11: RRCConnectionReconfiguration (step 27, Table 13.4.3.9.3.2-2)

Derivation Path: 36.508, Table 4.6.1-8			
Information Element	Value/remark	Comment	Condition
RRCConnectionReconfiguration ::= SEQUENCE {			
criticalExtensions CHOICE {			
c1 CHOICE{			
rrcConnectionReconfiguration-r8 SEQUENCE {			
radioResourceConfigDedicated	RadioResourceConfigDedicated-HO		
}			
}			
}			
}			

13.4.3.10 Inter-system mobility / E-UTRA voice to UTRA CS voice / aSRVCC / MT call

13.4.3.10.1 Test Purpose (TP)

(1)

```
with { UE is in E-UTRA RRC_CONNECTED state and an IMS MT speech call is in alerting phase }
ensure that {
  when { UE receives a MobilityFromEUTRACommand message }
  then { UE transmits a HANDOVER TO UTRAN COMPLETE message on the UTRA cell }
}
```

(2)

```
with { UE is in UTRA CELL_DCH state and an SRVCC procedure for MT call in alerting phase is completed }
ensure that {
  when { User answers the MT call }
  then { UE transmits a CONNECT message }
}
```

13.4.3.10.2 Conformance requirements

References: The conformance requirements covered in the present TC are specified in: TS 36.331, clause 5.4.3.3, TS 23.237, clause 6.3.2.1.4c, TS 23.216, clause 6.2.2.2, TS 24.237, clauses 12.1, 12.2.3B.1, 12.2.3B.2, 12.2.3B.3.1, and TS 24.008 clause 5.2.4.2.

[TS 36.331, clause 5.4.3.3]

The UE shall:

- 1> stop timer T310, if running;
- 1> if the *MobilityFromEUTRACommand* message includes the *purpose* set to *handover*:

2> if the *targetRAT-Type* is set to *utra* or *geran*:

3> consider inter-RAT mobility as initiated towards the RAT indicated by the *targetRAT-Type* included in the *MobilityFromEUTRACommand* message;

3> forward the *nas-SecurityParamFromEUTRA* to the upper layers;

3> access the target cell indicated in the inter-RAT message in accordance with the specifications of the target RAT;

[TS 23.237, clause 6.3.2.1.4c]

Figure 6.3.2.1.4c-1 PS-CS: PS to CS - Single Radio, incoming call in alerting phase, provides an information flow for Access Transfer of media of an IMS session in PS to CS direction for Access Transfers as specified in TS 23.216 [10].

The flow requires that the user is active in a terminating IMS session and that the SIP session is in alerting state there is no other ongoing session and the UE has not responded over the access leg; procedures and capabilities specified in TS 23.216 [10], clause 6.2.1 are used for the switching of access networks at the transport layer. It further requires that the MSC Server supports I2 reference point.

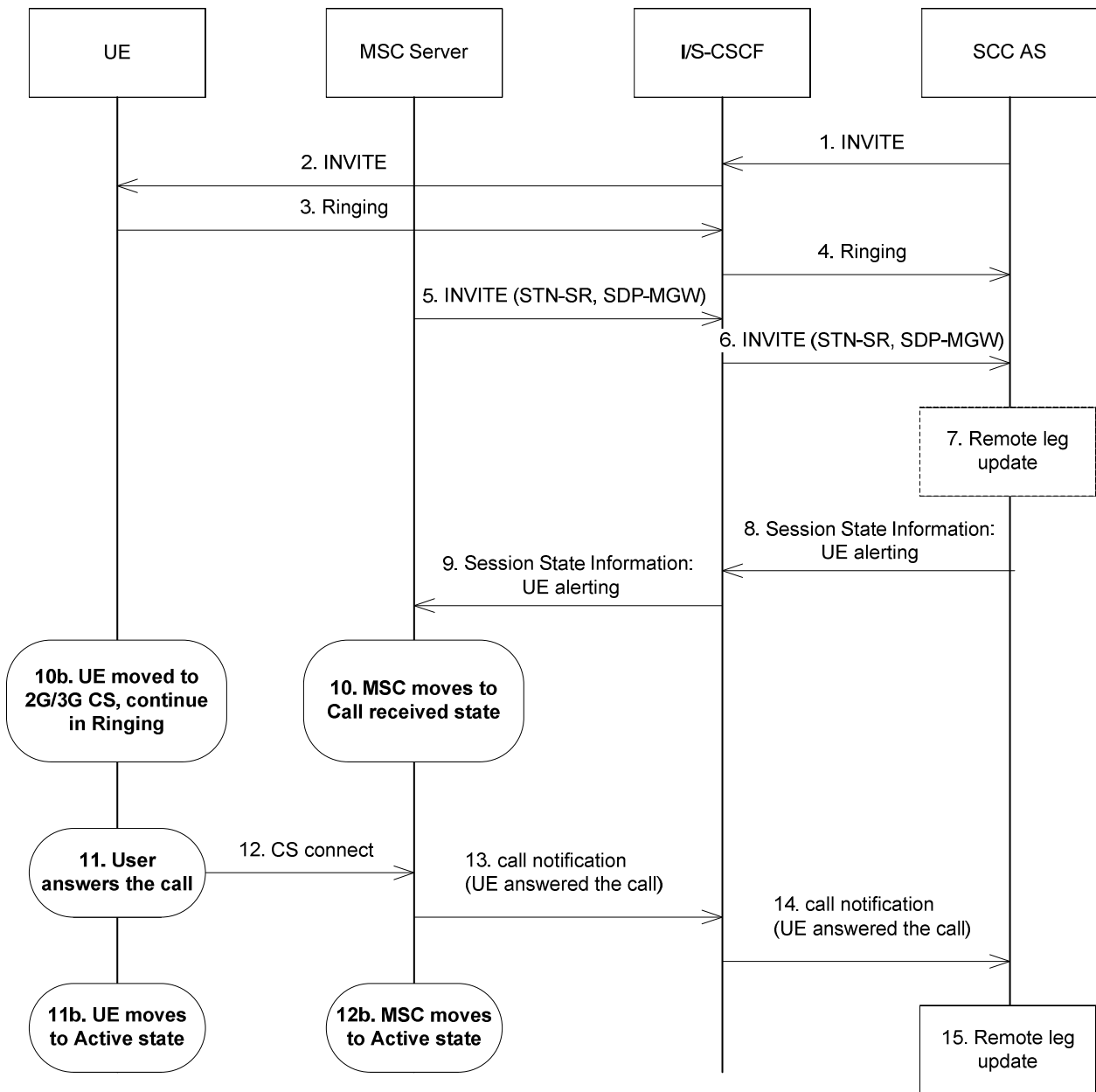

Figure 6.3.2.1.4c-1: PS-CS: PS to CS - Single Radio, incoming call in alerting phase

1-4. Standard procedures are used to initiate a SIP session towards the UE. The UE is alerting the user for the incoming voice session.

...

10. The MSC moves to the corresponding CS call state, e.g. Call Received in TS 24.008 [24].

NOTE 2: In call received state the MSC does not generate an in-band ring tone to the calling party.

10b. In parallel to step 10, the UE has received the HO command as described in TS 23.216 [10]. The UE determines the local call state in the SIP session, and creates the corresponding CS call state, e.g. Call Received in TS 24.008 [24]. The UE continues to alert the user for incoming call.

11. The user answers to the call.

11a. UE moves to Active state.

12. The UE uses the standard procedure to send the CS connect message to MSC as e.g. described in TS 24.008 [24].

[TS 23.216, clause 6.2.2.2]

Depicted in figure 6.2.2.2-1 is a call flow for SRVCC from E-UTRAN to UTRAN or GERAN with DTM HO support, including the handling of the non-voice component. The flow requires that eNB can determine that either the target is UTRAN with PS HO or the target is GERAN with DTM support and the UE is supporting DTM.

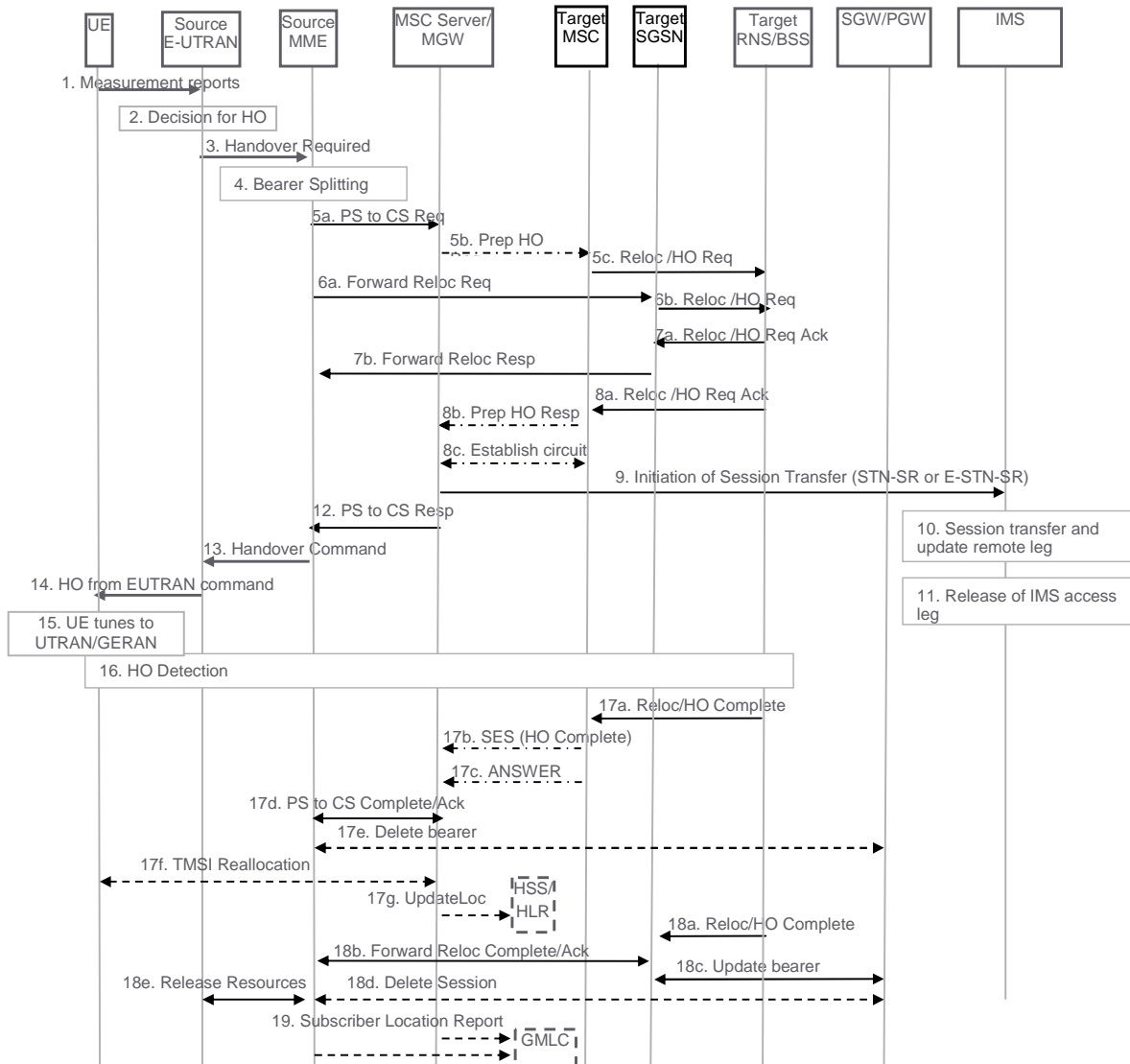

Figure 6.2.2.2-1: SRVCC from E-UTRAN to UTRAN with PS HO or GERAN with DTM HO support

1. UE sends measurement reports to E-UTRAN.

...

14. E-UTRAN sends a Handover from E-UTRAN Command message to the UE.

15. UE tunes to the target UTRAN/GERAN cell.

16. Handover Detection at the target RNS/BSS occurs. The UE sends a Handover Complete message via the target RNS/BSS to the target MSC. If the target MSC is not the MSC Server, then the Target MSC sends an SES (Handover Complete) message to the MSC Server. At this stage, the UE re-establishes the connection with the network and can send/receive voice data.

17. The CS relocation/handover is complete. The following steps are performed:

- a) Target RNS/BSS sends Relocation Complete/Handover Complete message to the target MSC.
- b) Target MSC sends an SES (Handover Complete) message to the MSC Server. The speech circuit is through connected in the MSC Server/MGW according to TS 23.009 [18].
- c) Completion of the establishment procedure with ISUP Answer message to the MSC Server according to TS 23.009 [18].

- d) MSC Server sends a SRVCC PS to CS Complete Notification message to the source MME. Source MME acknowledges the information by sending a SRVCC PS to CS Complete Acknowledge message to the MSC Server.
- e) The source MME deactivates the voice bearer towards S-GW/P-GW and sets the PS-to-CS handover indicator to Delete Bearer Command message. This triggers MME-initiated Dedicated Bearer Deactivation procedure as specified in TS 23.401 [2]. The MME does not send deactivation request toward the eNodeB on receiving PS-to-CS Complete Notification in step 17d. If dynamic PCC is deployed, the PGW may interact with PCRF as defined in TS 23.203 [31].
- f) If the HLR is to be updated, i.e. if the IMSI is authenticated but unknown in the VLR, the MSC Server performs a TMSI reallocation towards the UE using its own non-broadcast LAI and, if the MSC Server and other MSC/VLRs serve the same (target) LAI, with its own Network Resource Identifier (NRI).

NOTE 9: The TMSI reallocation is performed by the MSC Server towards the UE via target MSC.

- g) If the MSC Server performed a TMSI reallocation in step 17f, and if this TMSI reallocation was completed successfully, the MSC Server performs a MAP Update Location to the HSS/HLR.

NOTE 10: This Update Location is not initiated by the UE.

[TS 24.237, clause 12.1]

In order to fulfil the requirements for PS-CS access transfer in SR-VCC for calls in alerting state, the SC UE needs to be engaged in a session with speech media component in early dialog state according to the following conditions before SR-VCC access transfer is performed:

- a SIP 180 (Ringing) response for the initial SIP INVITE request to establish this session has been sent or received; and
- a SIP final response for the initial SIP INVITE request to establish this session has not been sent or received.

[TS 24.237, clause 12.2.3B.1]

The SC UE shall apply the procedures in subclauses 12.2.3B.3 for access transfer for calls in alerting state if:

- 1) the SC UE supports single radio PS to CS access transfer for calls in alerting state; and
- 2) there are one or more early dialogs created by the same SIP INVITE request with at least one dialog that is an early dialog supporting a session with active speech media component where the SC UE:
 - has sent a Contact header field in a SIP INVITE request or 180 (Ringing) response containing the g.3gpp.srvcc-alerting media feature tag (as described in annex C); and
 - has received a Feature-Caps header field in a SIP INVITE request or 180 (Ringing) response containing the g.3gpp.srvcc-alerting feature capability indicator (as described in annex C).

[TS 24.237, clause 12.2.3B.2]

If the SC UE applies the procedures in subclause 12.2.3B.3 and the SC UE only has a single call in alerting state following access transfer, then the SC UE shall associate this session with transaction identifier value and TI flag as described in 3GPP TS 24.008 [8].

[TS 24.237, clause 12.2.3B.3.1]

If the SC UE:

- has received a terminating call which is in the early dialog state according to the conditions in subclauses 12.1 and 12.2.3B.1; and
- successfully performs access transfer to the CS domain;

then the UE continues in Ringing state in CS, i.e. UE moves to Call Received (U7) state as described in 3GPP TS 24.008 [8].

[TS 24.008, clause 5.2.4.2]

If the MS supports single radio PS to CS access transfer for calls in alerting state as specified in 3GPP TS 24.237 [136] subclause 12.2.3B, and the MS has a single voice media stream over the PS domain that is handed over to the CS domain via SRVCC, and the call control entity in "null" state receives an indication "MM connection establishment due to SRVCC handover", then:

...

- if the voice media stream is associated with a mobile terminating session in the "early" state (defined in IETF RFC 3261 [137]) according to the conditions specified in 3GPP TS 24.237 [136] subclause 12.2.3B.3.1, the call control entity of the MS shall enter the "call received" state for this transaction. The MS and the network shall locally set the TI value of the call to "000" and the TI flag value as in mobile terminated call.

If the MS has additional voice media streams carried over the PS domain that are handed over to the CS domain via SRVCC, the state for the transactions and the setting of the TI value and TI flag for these additional media streams is described in 3GPP TS 24.237 [136].

13.4.3.10.3 Test description

13.4.3.10.3.1 Pre-test conditions

System Simulator:

- Cell 1 and Cell 5
- System information combination 4 as defined in TS 36.508 [18] clause 4.4.3.1 is used in E-UTRA cell.

UE:

None.

Preamble:

- The UE is in state Registered, Idle mode (state 2) on Cell 1 according to [18].

13.4.3.10.3.2 Test procedure sequence

Table 13.4.3.10.3.2-1 illustrates the downlink power levels and other changing parameters to be applied for the cells at various time instants of the test execution. Row marked "T0" denotes the initial conditions after preamble, while columns marked "T1" is to be applied subsequently. The exact instants on which these values shall be applied are described in the texts in this clause.

Table 13.4.3.10.3.2-1: Time instances of cell power level and parameter changes

	Parameter	Unit	Cell 1	Cell 5	Remark
T0	Cell-specific RS EPRE	dBm/15k Hz	-60	-	The power level values are such that entering conditions for event B2 are not satisfied.
	CPICH_Ec (UTRA FDD)	dBm/3.8 4 MHz	-	-88	
	PCCPCH_Ec (UTRA LCR TDD)	dBm/1.2 8 MHz	-	-88	
T1	Cell-specific RS EPRE	dBm/15k Hz	-84	-	The power level values are such that entering conditions for event B2 are satisfied.
	CPICH_Ec (UTRA FDD)	dBm/3.8 4 MHz	-	-64	
	PCCPCH_Ec (UTRA LCR TDD)	dBm/1.2 8 MHz	-	-64	

Table 13.4.3.10.3.2-2: Main behaviour

St	Procedure	Message Sequence		TP	Verdict
		U - S	Message		
1	The SS configures UTRA Cell 5 to reference configuration according 36.508 Table 4.8.3-1, condition UTRA Speech.	-	-	-	-
2-23	Steps 1 to 22 of the generic test procedure for IMS MT speech call (TS 36.508 4.5A.7.3-1).	-	-	-	-
24	The SS transmits an <i>RRCCONNECTIONRECONFIGURATION</i> message on Cell 1 to setup inter-RAT measurement and reporting for event B2.	<--	<i>RRCCONNECTIONRECONFIGURATION</i>	-	-
25	The UE transmits an <i>RRCCONNECTIONRECONFIGURATIONCOMPLETE</i> message on Cell 1.	-->	<i>RRCCONNECTIONRECONFIGURATIONCOMPLETE</i>	-	-
26	The SS changes the power level for Cell 1 and Cell 5 according to the row "T1" in Table 13.4.3.10.3.2-1	-	-	-	-
27	The UE transmits a <i>MEASUREMENTREPORT</i> message on Cell 1 to report event B2 for Cell 5.	-->	<i>MEASUREMENTREPORT</i>	-	-
28	The SS transmits a <i>UECAPABILITYENQUIRY</i> message on Cell 1 to request UE radio access capability information for E-UTRA and UTRA.	<--	<i>UECAPABILITYENQUIRY</i>	-	-
29	The UE transmit a <i>UECAPABILITYINFORMATION</i> message on Cell 1. NOTE: The start-CS values received, should be used to configure ciphering on Cell 5.	-->	<i>UECAPABILITYINFORMATION</i>	-	-
30	The SS transmits a <i>MOBILITYFROMEUTRACOMMAND</i> message on Cell 1.	<--	<i>MOBILITYFROMEUTRACOMMAND</i>	-	-
31	Check: Does the UE transmit a HANDOVER TO UTRAN COMPLETE message on Cell 5?	-->	HANDOVER TO UTRAN COMPLETE	1	P
-	EXCEPTION: In parallel to the events described in step 32 to 37 the steps specified in Table 13.4.3.10.3.2-3 takes place.	-	-	-	-
32	The SS transmits a SECURITY MODE COMMAND message for the CS domain on Cell 5.	<--	SECURITY MODE COMMAND	-	-
33	The UE transmits a SECURITY MODE COMPLETE message on Cell 5.	-->	SECURITY MODE COMPLETE	-	-
34	The SS transmits an UTRAN MOBILITY INFORMATION message on Cell 5 to notify CN information.	<--	UTRAN MOBILITY INFORMATION	-	-
35	The UE transmits an UTRAN MOBILITY INFORMATION CONFIRM message on Cell 5.	-->	UTRAN MOBILITY INFORMATION CONFIRM	-	-
36	The SS transmits a TMSI REALLOCATION COMMAND message on Cell 5.	<--	TMSI REALLOCATION COMMAND	-	-
37	The UE transmits a TMSI REALLOCATION COMPLETE message on Cell 5.	-->	TMSI REALLOCATION COMPLETE	-	-
38	Cause the UE to answer an MT call. (NOTE 1)	-	-	-	-
39	Check: Does the UE transmit a CONNECT message on Cell 5?	-->	CONNECT	2	P
40	The SS transmits a CONNECT ACKNOWLEDGE message on Cell 5.	<--	CONNECT ACKNOWLEDGE	-	-
NOTE 1: The request may be triggered by MMI or by AT command A.					

Table 13.4.3.10.3.2-3: Parallel behaviour

St	Procedure	Message Sequence		TP	Verdict
		U - S	Message		
1	The UE transmit a ROUTING AREA UPDATE REQUEST message on Cell 5.	-->	ROUTING AREA UPDATE REQUEST	-	-
2	The SS transmits a SECURITY MODE COMMAND message for the PS domain on Cell 5.	<--	SECURITY MODE COMMAND	-	-
3	The UE transmits a SECURITY MODE COMPLETE message on Cell 5.	-->	SECURITY MODE COMPLETE	-	-
4	The SS transmits a ROUTING AREA UPDATE ACCEPT message on Cell 5.	<--	ROUTING AREA UPDATE ACCEPT	-	-
5	The UE transmits a ROUTING AREA UPDATE COMPLETE message on Cell 5.	-->	ROUTING AREA UPDATE COMPLETE	-	-

13.4.3.10.3.3 Specific message contents

Table 13.4.3.10.3.3-1: ATTACH REQUEST (preamble)

Derivation path: 36.508 Table 4.7.2-4			
Information Element	Value/remark	Comment	Condition
MS network capability	SRVCC from UTRAN HSPA or E-UTRAN to GERAN/UTRAN supported		
Mobile station classmark 2	Any allowed value		
Supported Codecs	Any allowed value		
Old GUTI type	Any allowed value		

Table 13.4.3.10.3.3-2: RRCConnectionReconfiguration (step 24, Table 13.4.3.10.3.2-2)

Derivation Path: 36.508, Table 4.6.1-8, condition MEAS
--

Table 13.4.3.10.3.3-3: MeasConfig (Table 13.4.3.10.3.3-2)

Derivation Path: 36.508, Table 4.6.6-1, condition UTRAN			
Information Element	Value/remark	Comment	Condition
MeasConfig ::= SEQUENCE {			
measObjectToAddModList SEQUENCE (SIZE (1..maxObjectId)) OF SEQUENCE {	2 entries		
measObjectId[1]	IdMeasObject-f1		
measObject[1]	MeasObjectEUTRA-GENERIC(f1)		
measObjectId[2]	IdMeasObject-f8		
measObject[2]	MeasObjectUTRA-f8		
}			
reportConfigToAddModList SEQUENCE (SIZE (1..maxReportConfigId)) OF SEQUENCE {	1 entry		
reportConfigId[1]	IdReportConfig-B2-UTRA		
reportConfig[1]	ReportConfigInterRAT-B2-UTRA (-72, -76)		
}			
measIdToAddModList SEQUENCE (SIZE (1..maxMeasId)) OF SEQUENCE {	1 entry		
measId[1]	1		
measObjectId[1]	IdMeasObject-f8		
reportConfigId[1]	IdReportConfig-B2-UTRA		
}			
}			

Table 13.4.3.10.3.3-4: MeasObjectUTRA-f8 (Table 13.4.3.10.3.3-3)

Derivation Path: 36.508, Table 4.6.6-3			
Information Element	Value/remark	Comment	Condition
MeasObjectUTRA ::= SEQUENCE {			
carrierFreq	Same downlink ARFCN as used for Cell 5		
cellsToAddModList CHOICE {			
cellsToAddModListUTRA-FDD SEQUENCE (SIZE (1..maxCellMeas)) OF SEQUENCE {	1 entry		UTRA-FDD
cellIndex[1]	1		
physCellId[1]	PhysicalCellIdentity of Cell 5		
}			
cellsToAddModListUTRA-TDD SEQUENCE (SIZE (1..maxCellMeas)) OF SEQUENCE {			UTRA-TDD
cellIndex[1]	1		
physCellId[1]	PhysicalCellIdentity of Cell 5		
}			
}			
csg-allowedReportingCells-v930	Not present		
}			

Condition	Explanation
UTRA-FDD	UTRA FDD cell environment
UTRA-TDD	UTRA TDD cell environment

Table 13.4.3.10.3.3-5: MeasurementReport (step 27, Table 13.4.3.10.3.2-2)

Derivation Path: 36.508, Table 4.6.1-5			
Information Element	Value/remark	Comment	Condition
MeasurementReport ::= SEQUENCE {			
criticalExtensions CHOICE {			
c1 CHOICE {			
measurementReport-r8 SEQUENCE {			
measResults SEQUENCE {			
measId	1		
measResultPCell SEQUENCE {			
rsrpResult	(0..97)		
rsrqResult	(0..34)		
}			
measResultNeighCells CHOICE {			
measResultListUTRA SEQUENCE (SIZE (1..maxCellReport)) OF SEQUENCE {	1 entry		
physCellId[1] CHOICE {			
fdd	PhysicalCellIdentity of Cell 5		UTRA-FDD
tdd	PhysicalCellIdentity of Cell 5		UTRA-TDD
}			
cgi-Info[1]	Not present		
measResult[1] SEQUENCE {			
utra-RSCP	(-5..91)		
utra-EcN0	Not present		
additionalSI-Info-r9	Not present		
}			
}			
measResultForECID-r9	Not present		
locationInfo-r10	Not present		
measResultServFreqList-r10	Not present		
}			
}			
}			
}			
}			

Condition	Explanation
UTRA-FDD	UTRA FDD cell environment
UTRA-TDD	UTRA TDD cell environment

Table 13.4.3.10.3.3-6: UECapabilityEnquiry (step 28, Table 13.4.3.10.3.2-2)

Derivation Path: 36.508, Table 4.6.1-22			
Information Element	Value/remark	Comment	Condition
UECapabilityEnquiry ::= SEQUENCE {			
criticalExtensions CHOICE {			
c1 CHOICE {			
ueCapabilityEnquiry-r8 SEQUENCE {			
ue-CapabilityRequest (SIZE (1..maxRAT-Capabilities)) OF SEQUENCE {	2 entries		
RAT-Type[1]	eutra		
RAT-Type[2]	utra		
}			
}			
}			
}			
}			

Table 13.4.3.10.3.3-7: MobilityFromEUTRACommand (step 30, Table 13.4.3.10.3.2-2)

Derivation Path: 36.508, Table 4.6.1-6			
Information Element	Value/remark	Comment	Condition
MobilityFromEUTRACommand ::= SEQUENCE {			
criticalExtensions CHOICE {			
c1 CHOICE {			
mobilityFromEUTRACommand-r8 SEQUENCE {			
cs-FallbackIndicator	True		
purpose CHOICE {			
handover SEQUENCE {			
targetRAT-Type	utra		
targetRAT-MessageContainer	HANDOVER TO UTRAN COMMAND(UTRA RRC message)		
nas-SecurityParamFromEUTRA	The 4 least significant bits of the NAS downlink COUNT value		
systemInformation	Not present		
}			
}			
}			
}			
}			

Table 13.4.3.10.3.3-8: HANDOVER TO UTRAN COMMAND (Table 13.4.3.10.3.3-7)

Derivation Path: 36.508, Table 4.7B.1-1, condition UTRA Speech			

Table 13.4.3.10.3.3-9: SECURITY MODE COMMAND (step 32 Table 13.4.3.10.3.2-2)

Derivation Path: 36.508, Table 4.7B.1-n			
Information Element	Value/remark	Comment	Condition
Ciphering mode info	Not present		

Table 13.4.3.10.3.3-10: CONNECT (step 39, Table 13.4.3.10.3.2-2)

Derivation Path: TS 24.008 Table 9.59a			
Information Element	Value/remark	Comment	Condition
Transaction identifier			
TI flag	'1'B	The message is sent to the side that originates the TI	
TIO	'000'B	TI value 0	

Table 13.4.3.10.3.3-11: CONNECT ACKNOWLEDGE (step 40, Table 13.4.3.10.3.2-2)

Derivation Path: TS 24.008 Table 9.60			
Information Element	Value/remark	Comment	Condition
Transaction identifier			
TI flag	'0'B	The message is sent from the side that originates the TI	
TIO	'000'B	TI value 0	

13.4.3.11 Inter-system mobility / E-UTRA voice to UTRA CS voice / aSRVCC / MT call / SRVCC HO failure

13.4.3.11.1 Test Purpose (TP)

(1)

```
with { UE is in E-UTRA RRC_CONNECTED state, an IMS MT speech call is in alerting phase and UE
receives a MobilityFromEUTRACommand message }
ensure that {
  when { UE detects radio link failure }
  then { UE transmits SIP UPDATE message after RRC connection re-establishment procedure }
}
```

13.4.3.11.2 Conformance requirements

References: The conformance requirements covered in the present TC are specified in: TS 36.331, clauses 5.4.3.3, 5.4.3.5, 5.3.7.2, 5.3.7.3, 5.3.7.4, 5.3.7.5 and TS 24.237, clause 12.2.4.2.

[TS 36.331, clause 5.4.3.3]

The UE shall:

- 1> stop timer T310, if running;
- 1> if the *MobilityFromEUTRACommand* message includes the *purpose* set to *handover*:
 - 2> if the *targetRAT-Type* is set to *utra* or *geran*:
 - 3> consider inter-RAT mobility as initiated towards the RAT indicated by the *targetRAT-Type* included in the *MobilityFromEUTRACommand* message;
 - 3> forward the *nas-SecurityParamFromEUTRA* to the upper layers;
 - 3> access the target cell indicated in the inter-RAT message in accordance with the specifications of the target RAT;

[TS 36.331, clause 5.4.3.5]

The UE shall:

- 1> if T304 expires (mobility from E-UTRA failure); or
- 1> if the UE does not succeed in establishing the connection to the target radio access technology; or
- 1> if the UE is unable to comply with (part of) the configuration included in the *MobilityFromEUTRACommand* message; or
- 1> if there is a protocol error in the inter RAT information included in the *MobilityFromEUTRACommand* message, causing the UE to fail the procedure according to the specifications applicable for the target RAT:
 - 2> stop T304, if running;
 - 2> if the *cs-FallbackIndicator* in the *MobilityFromEUTRACommand* message was set to *TRUE*:
 - 3> indicate to upper layers that the CS Fallback procedure has failed;
 - 2> revert back to the configuration used in the source PCell, excluding the configuration configured by the *physicalConfigDedicated*, *mac-MainConfig* and *sps-Config*;
 - 2> initiate the connection re-establishment procedure as specified in 5.3.7;

[TS 36.331, clause 5.3.7.2]

The UE shall only initiate the procedure when AS security has been activated. The UE initiates the procedure when one of the following conditions is met:

...

1> upon mobility from E-UTRA failure, in accordance with 5.4.3.5; or

...

Upon initiation of the procedure, the UE shall:

- 1> stop timer T310, if running;
- 1> start timer T311;
- 1> suspend all RBs except SRB0;
- 1> reset MAC;
- 1> release the SCell(s), if configured, in accordance with 5.3.10.3a;
- 1> apply the default physical channel configuration as specified in 9.2.4;
- 1> apply the default semi-persistent scheduling configuration as specified in 9.2.3;
- 1> apply the default MAC main configuration as specified in 9.2.2;
- 1> release *reportProximityConfig* and clear any associated proximity status reporting timer;
- 1> release *measSubframePatternPCell*, if configured;

...

1> perform cell selection in accordance with the cell selection process as specified in TS 36.304 [4];

[TS 36.331, clause 5.3.7.3]

Upon selecting a suitable E-UTRA cell, the UE shall:

- 1> stop timer T311;
- 1> start timer T301;
- 1> apply the *timeAlignmentTimerCommon* included in *SystemInformationBlockType2*;
- 1> initiate transmission of the *RRCCConnectionReestablishmentRequest* message in accordance with 5.3.7.4;

[TS 36.331, clause 5.3.7.4]

If the procedure was initiated due to radio link failure or handover failure, the UE shall:

- 1> set the *reestablishmentCellId* in the *VarRLF-Report* to the global cell identity of the selected cell;

The UE shall set the contents of *RRCCConnectionReestablishmentRequest* message as follows:

- 1> set the *ue-Identity* as follows:
 - 2> set the *c-RNTI* to the C-RNTI used in the source PCell (handover and mobility from E-UTRA failure) or used in the PCell in which the trigger for the re-establishment occurred (other cases);
 - 2> set the *physCellId* to the physical cell identity of the source PCell (handover and mobility from E-UTRA failure) or of the PCell in which the trigger for the re-establishment occurred (other cases);
 - 2> set the *shortMAC-I* to the 16 least significant bits of the MAC-I calculated:
 - 3> over the ASN.1 encoded as per section 8 (i.e., a multiple of 8 bits) *VarShortMAC-Input*;
 - 3> with the K_{RRCint} key and integrity protection algorithm that was used in the source PCell (handover and mobility from E-UTRA failure) or of the PCell in which the trigger for the re-establishment occurred (other cases); and
 - 3> with all input bits for COUNT, BEARER and DIRECTION set to binary ones;

- 1> set the *reestablishmentCause* as follows:

...

2> else if the re-establishment procedure was initiated due to handover failure as specified in 5.3.5.6 (intra-LTE handover failure) or 5.4.3.5 (inter-RAT mobility from EUTRA failure):

3> set the *reestablishmentCause* to the value *handoverFailure*;

The UE shall submit the *RRCConnectionReestablishmentRequest* message to lower layers for transmission.

[TS 36.331, clause 5.3.7.5]

The UE shall:

1> stop timer T301;

1> consider the current cell to be the PCell;

1> re-establish PDCP for SRB1;

1> re-establish RLC for SRB1;

1> perform the radio resource configuration procedure in accordance with the received *radioResourceConfigDedicated* and as specified in 5.3.10;

1> resume SRB1;

NOTE: E-UTRAN should not transmit any message on SRB1 prior to receiving the *RRCConnectionReestablishmentComplete* message.

1> update the K_{eNB} key based on the K_{ASME} key to which the current K_{eNB} is associated, using the *nextHopChainingCount* value indicated in the *RRCConnectionReestablishment* message, as specified in TS 33.401 [32];

1> store the *nextHopChainingCount* value;

1> derive the K_{RRCint} key associated with the previously configured integrity algorithm, as specified in TS 33.401 [32];

1> derive the K_{RRCenc} key and the K_{UPenc} key associated with the previously configured ciphering algorithm, as specified in TS 33.401 [32];

...

1> configure lower layers to activate integrity protection using the previously configured algorithm and the K_{RRCint} key immediately, i.e., integrity protection shall be applied to all subsequent messages received and sent by the UE, including the message used to indicate the successful completion of the procedure;

...

1> configure lower layers to apply ciphering using the previously configured algorithm, the K_{RRCenc} key and the K_{UPenc} key immediately, i.e., ciphering shall be applied to all subsequent messages received and sent by the UE, including the message used to indicate the successful completion of the procedure;

1> set the content of *RRCConnectionReestablishmentComplete* message as follows:

2> if the UE has radio link failure or handover failure information available in *VarRLF-Report* and *plmn-Identity* stored in *VarRLF-Report* is equal to the RPLMN:

3> include the *rlf-InfoAvailable*;

...

1> perform the measurement related actions as specified in 5.5.6.1;

1> perform the measurement identity autonomous removal as specified in 5.5.2.2a;

1> submit the *RRCConnectionReestablishmentComplete* message to lower layers for transmission, upon which the procedure ends;

[TS 24.237, clause 12.2.4.2]

If the SC UE is engaged in a session in early dialog state and:

...

- does not successfully retune to the 3GPP UTRAN or 3GPP GERAN after it receives the handover command from the eNodeB (as described in 3GPP TS 36.331 [62]) or from the NodeB (as described in 3GPP TS 25.331 [61]);

then if the SC UE the SC UE shall send a SIP UPDATE request containing:

- 1) an SDP offer, including the media characteristics as used in the existing dialog; and
- 2) a Reason header field containing protocol "SIP" and reason parameter "cause" with value "487" as specified in IETF RFC 3326 [57], and with reason-text set to either "handover cancelled" or "failure to transition to CS domain";

by following the rules of 3GPP TS 24.229 [2] in each transferred session.

13.4.3.11.3 Test description

13.4.3.11.3.1 Pre-test conditions

System Simulator:

- Cell 1 and Cell 5.
- System information combination 4 as defined in TS 36.508 [18] clause 4.4.3.1 is used in E-UTRA cell.

UE:

None.

Preamble:

- The UE is in state Registered, Idle mode (state 2) on Cell 1 according to [18].

13.4.3.11.3.2 Test procedure sequence

Table 13.4.3.11.3.2-1 illustrates the downlink power levels and other changing parameters to be applied for the cells at various time instants of the test execution. Row marked "T0" denotes the initial conditions after preamble, while columns marked "T1" and "T2" are to be applied subsequently. The exact instants on which these values shall be applied are described in the texts in this clause.

Table 13.4.3.11.3.2-1: Time instances of cell power level and parameter changes

	Parameter	Unit	Cell 1	Cell 5	Remark
T0	Cell-specific RS EPRE	dBm/15k Hz	-60	-	The power level values are such that entering conditions for event B2 are not satisfied.
	CPICH_Ec (UTRA FDD)	dBm/3.8 4 MHz	-	-88	
	PCCPCH_Ec (UTRA LCR TDD)	dBm/1.2 8 MHz	-	-88	
T1	Cell-specific RS EPRE	dBm/15k Hz	-84	-	The power level values are such that entering conditions for event B2 are satisfied.
	CPICH_Ec (UTRA FDD)	dBm/3.8 4 MHz	-	-64	
	PCCPCH_Ec (UTRA LCR TDD)	dBm/1.2 8 MHz	-	-64	
T2	Cell-specific RS EPRE	dBm/15k Hz	-85	-	Only Cell 1 is available. (NOTE 1)
	CPICH_Ec (UTRA FDD)	dBm/3.8 4 MHz	-	"Off"	
	PCCPCH_Ec (UTRA LCR TDD)	dBm/1.2 8 MHz	-	"Off"	

TDD)				
NOTE 1: Power level "Off" for UTRA cell is defined in TS 34.108 Table 6.1.4 and Table 6.1.9.				

Table 13.4.3.11.3.2-2: Main behaviour

St	Procedure	Message Sequence		TP	Verdict
		U - S	Message		
1	The SS configures UTRA Cell 5 to reference configuration according 36.508 Table 4.8.3-1, condition UTRA Speech.	-	-	-	-
2-23	Steps 1 to 22 of the generic test procedure for IMS MT speech call (TS 36.508 4.5A.7.3-1).	-	-	-	-
24	The SS transmits an <i>RRCCONNECTIONRECONFIGURATION</i> message on Cell 1 to setup inter-RAT measurement and reporting for event B2.	<--	<i>RRCCONNECTIONRECONFIGURATION</i>	-	-
25	The UE transmits an <i>RRCCONNECTIONRECONFIGURATIONCOMPLETE</i> message on Cell 1.	-->	<i>RRCCONNECTIONRECONFIGURATIONCOMPLETE</i>	-	-
26	The SS changes the power level for Cell 1 and Cell 5 according to the row "T1" in Table 13.4.3.11.3.2-1	-	-	-	-
27	The UE transmits a <i>MEASUREMENTREPORT</i> message on Cell 1 to report event B2 for Cell 5.	-->	<i>MEASUREMENTREPORT</i>	-	-
28	The SS changes the power level for Cell 1 and Cell 5 according to the row "T2" in Table 13.4.3.11.3.2-1.	-	-	-	-
29	The SS transmits a <i>UECAPABILITYENQUIRY</i> message on Cell 1 to request UE radio access capability information for E-UTRA and UTRA.	<--	<i>UECAPABILITYENQUIRY</i>	-	-
30	The UE transmit a <i>UECAPABILITYINFORMATION</i> message on Cell 1. NOTE: The start-CS values received, should be used to configure ciphering on Cell 5.	-->	<i>UECAPABILITYINFORMATION</i>	-	-
31	The SS transmits a <i>MOBILITYFROMEUTRACOMMAND</i> message on Cell 1.	<--	<i>MOBILITYFROMEUTRACOMMAND</i>	-	-
32	The UE transmits an <i>RRCCONNECTIONREESTABLISHMENTREQUEST</i> message on Cell 1.	-->	<i>RRCCONNECTIONREESTABLISHMENTREQUEST</i>	-	-
33	The SS transmits an <i>RRCCONNECTIONREESTABLISHMENT</i> message on Cell 1.	<--	<i>RRCCONNECTIONREESTABLISHMENT</i>	-	-
34	The UE transmits an <i>RRCCONNECTIONREESTABLISHMENTCOMPLETE</i> message on Cell 1.	-->	<i>RRCCONNECTIONREESTABLISHMENTCOMPLETE</i>	-	-
35	The SS transmits an <i>RRCCONNECTIONRECONFIGURATION</i> message on Cell 1.	<--	<i>RRCCONNECTIONRECONFIGURATION</i>	-	-
-	EXCEPTION: In parallel to the events described in step 36 the steps specified in Table 13.4.3.11.3.2-3 should take place.	-	-	-	-
36	The UE transmits an <i>RRCCONNECTIONRECONFIGURATIONCOMPLETE</i> message on Cell 1.	-->	<i>RRCCONNECTIONRECONFIGURATIONCOMPLETE</i>	-	-
37-38	Steps 12-13 expected sequence defined in annex C.21 of TS 34.229-1 [35].	-	-	-	-

Table 13.4.3.11.3.2-3: Parallel behaviour

St	Procedure	Message Sequence		TP	Verdict
		U - S	Message		
1	Check: Does the UE transmit SIP UPDATE request on Cell 1? NOTE: Step 1 defined in annex C.28 of TS 34.229-1 [35] is performed.	-	-	1	P
2	Step 2 expected sequence defined in annex C.28 of TS 34.229-1 [35].	-	-	-	-

13.4.3.11.3.3 Specific message contents

Table 13.4.3.11.3.3-1: ATTACH REQUEST (preamble)

Derivation path: 36.508 Table 4.7.2-4			
Information Element	Value/remark	Comment	Condition
MS network capability	SRVCC from UTRAN HSPA or E-UTRAN to GERAN/UTRAN supported		
Mobile station classmark 2	Any allowed value		
Supported Codecs	Any allowed value		
Old GUTI type	Any allowed value		

Table 13.4.3.11.3.3-2: *RRCConnectionReconfiguration* (step 24, Table 13.4.3.11.3.2-2)

Derivation Path: 36.508, Table 4.6.1-8, condition MEAS
--

Table 13.4.3.11.3.3-3: *MeasConfig* (Table 13.4.3.11.3.3-2)

Derivation Path: 36.508, Table 4.6.6-1, condition UTRAN			
Information Element	Value/remark	Comment	Condition
MeasConfig ::= SEQUENCE {			
measObjectToAddModList SEQUENCE (SIZE (1..maxObjectId)) OF SEQUENCE {	2 entries		
measObjectId[1]	IdMeasObject-f1		
measObject[1]	MeasObjectEUTRA-GENERIC(f1)		
measObjectId[2]	IdMeasObject-f8		
measObject[2]	MeasObjectUTRA-f8		
}			
reportConfigToAddModList SEQUENCE (SIZE (1..maxReportConfigId)) OF SEQUENCE {	1 entry		
reportConfigId[1]	IdReportConfig-B2-UTRA		
reportConfig[1]	ReportConfigInterRAT-B2-UTRA (-72, -76)		
}			
measIdToAddModList SEQUENCE (SIZE (1..maxMeasId)) OF SEQUENCE {	1 entry		
measId[1]	1		
measObjectId[1]	IdMeasObject-f8		
reportConfigId[1]	IdReportConfig-B2-UTRA		
}			
}			

Table 13.4.3.11.3.3-4: MeasObjectUTRA-f8 (Table 13.4.3.11.3.3-3)

Derivation Path: 36.508, Table 4.6.6-3			
Information Element	Value/remark	Comment	Condition
MeasObjectUTRA ::= SEQUENCE {			
carrierFreq	Same downlink ARFCN as used for Cell 5		
cellsToAddModList CHOICE {			
cellsToAddModListUTRA-FDD SEQUENCE (SIZE (1..maxCellMeas)) OF SEQUENCE {	1 entry		UTRA-FDD
cellIndex[1]	1		
physCellId[1]	PhysicalCellIdentity of Cell 5		
}			
cellsToAddModListUTRA-TDD SEQUENCE (SIZE (1..maxCellMeas)) OF SEQUENCE {			UTRA-TDD
cellIndex[1]	1		
physCellId[1]	PhysicalCellIdentity of Cell 5		
}			
}			
csg-allowedReportingCells-v930	Not present		
}			

Condition	Explanation
UTRA-FDD	UTRA FDD cell environment
UTRA-TDD	UTRA TDD cell environment

Table 13.4.3.11.3.3-5: *MeasurementReport* (step 27, Table 13.4.3.11.3.2-2)

Derivation Path: 36.508, Table 4.6.1-5			
Information Element	Value/remark	Comment	Condition
MeasurementReport ::= SEQUENCE {			
criticalExtensions CHOICE {			
c1 CHOICE {			
measurementReport-r8 SEQUENCE {			
measResults SEQUENCE {			
measId	1		
measResultPCell SEQUENCE {			
rsrpResult	(0..97)		
rsrqResult	(0..34)		
}			
measResultNeighCells CHOICE {			
measResultListUTRA SEQUENCE (SIZE (1..maxCellReport)) OF SEQUENCE {	1 entry		
physCellId[1] CHOICE {			
fdd	PhysicalCellIdentity of Cell 5		UTRA-FDD
tdd	PhysicalCellIdentity of Cell 5		UTRA-TDD
}			
cgi-Info[1]	Not present		
measResult[1] SEQUENCE {			
utra-RSCP	(-5..91)		
utra-EcN0	Not present		
additionalSI-Info-r9	Not present		
}			
}			
measResultForECID-r9	Not present		
locationInfo-r10	Not present		
measResultServFreqList-r10	Not present		
}			
}			
}			
}			
}			

Condition	Explanation
UTRA-FDD	UTRA FDD cell environment
UTRA-TDD	UTRA TDD cell environment

Table 13.4.3.11.3.3-6: *UECapabilityEnquiry* (step 29, Table 13.4.3.11.3.2-2)

Derivation Path: 36.508, Table 4.6.1-22			
Information Element	Value/remark	Comment	Condition
UECapabilityEnquiry ::= SEQUENCE {			
criticalExtensions CHOICE {			
c1 CHOICE {			
ueCapabilityEnquiry-r8 SEQUENCE {			
ue-CapabilityRequest (SIZE (1..maxRAT-Capabilities)) OF SEQUENCE {	2 entries		
RAT-Type[1]	eutra		
RAT-Type[2]	utra		
}			
}			
}			
}			
}			

Table 13.4.3.11.3.3-7: *MobilityFromEUTRACommand* (step 31, Table 13.4.3.11.3.2-2)

Derivation Path: 36.508, Table 4.6.1-6			
Information Element	Value/remark	Comment	Condition
MobilityFromEUTRACommand ::= SEQUENCE {			
criticalExtensions CHOICE {			
c1 CHOICE {			
mobilityFromEUTRACommand-r8 SEQUENCE {			
cs-FallbackIndicator	True		
purpose CHOICE {			
handover SEQUENCE {			
targetRAT-Type	utra		
targetRAT-MessageContainer	HANDOVER TO UTRAN COMMAND(UTRA RRC message)		
nas-SecurityParamFromEUTRA	The 4 least significant bits of the NAS downlink COUNT value		
systemInformation	Not present		
}			
}			
}			
}			
}			
}			

Table 13.4.3.11.3.3-8: HANDOVER TO UTRAN COMMAND (Table 13.4.3.11.3.3-7)

Derivation Path: 36.508, Table 4.7B.1-1, condition UTRA Speech
--

Table 13.4.3.11.3.3-9: *RRCConnectionReestablishmentRequest* (step 32, Table 13.4.3.11.3.2-2)

Derivation Path: 36.508, Table 4.6.1-13			
Information Element	Value/remark	Comment	Condition
RRCConnectionReestablishmentRequest ::= SEQUENCE {			
criticalExtensions CHOICE {			
rrcConnectionReestablishmentRequest-r8 SEQUENCE {			
ue-Identity SEQUENCE {			
c-RNTI	the value of the C-RNTI of the UE		
physCellId	PhysicalCellIdentity of Cell 1		
shortMAC-I	The same value as the 16 least significant bits of the XMAC-I value calculated by SS		
}			
reestablishmentCause	otherFailure		
}			
}			

Table 13.4.3.11.3.3-10: RRCConnectionReestablishmentComplete (step 34, Table 13.4.3.11.3.2-2)

Derivation Path: 36.508, Table 4.6.1-11			
Information Element	Value/remark	Comment	Condition
RRCConnectionReestablishmentComplete ::= SEQUENCE {			
criticalExtensions CHOICE {			
rrcConnectionReestablishmentComplete-r8 = SEQUENCE {			
nonCriticalExtension SEQUENCE {			
rf-InfoAvailable-r9	true		
nonCriticalExtension	Not present or any allowed value		
}			
}			
}			
}			

Table 13.4.3.11.3.3-11: RRCConnectionReconfiguration (step 35, Table 13.4.3.11.3.2-2)

Derivation Path: 36.508, Table 4.6.1-8			
Information Element	Value/remark	Comment	Condition
RRCConnectionReconfiguration ::= SEQUENCE {			
criticalExtensions CHOICE {			
c1 CHOICE{			
rrcConnectionReconfiguration-r8 SEQUENCE {			
radioResourceConfigDedicated	RadioResourceConfigDedicated-HO		
}			
}			
}			
}			

13.4.3.12 Inter-system mobility / E-UTRA voice to UTRA CS voice / aSRVCC / MT call / User answers in PS domain

13.4.3.12.1 Test Purpose (TP)

(1)

```
with { UE is in E-UTRA RRC_CONNECTED state and an IMS MT speech call is in alerting phase and UE has answered the call }
ensure that {
  when { UE receives a MobilityFromEUTRACommand message }
  then { UE transmits a HANDOVER TO UTRAN COMPLETE message on the UTRA cell }
}
```

(2)

```
with { UE has answered the MT call on the EUTRA cell }
ensure that {
  when { an SRVCC procedure for MT call in alerting phase is completed }
  then { UE transmits a CONNECT message }
}
```

13.4.3.12.2 Conformance requirements

References: The conformance requirements covered in the present TC are specified in: TS 36.331, clause 5.4.3.3, TS 23.237, clause 6.3.2.1.4c, TS 23.216, clause 6.2.2.2, TS 24.237, clauses 12.1, 12.2.3B.1, 12.2.3B.2, 12.2.3B.3.1, and TS 24.008, clause 5.2.4.2.

[TS 36.331, clause 5.4.3.3]

The UE shall:

- 1> stop timer T310, if running;

- 1> if the *MobilityFromEUTRACommand* message includes the *purpose* set to *handover*:
 - 2> if the *targetRAT-Type* is set to *utra* or *geran*:
 - 3> consider inter-RAT mobility as initiated towards the RAT indicated by the *targetRAT-Type* included in the *MobilityFromEUTRACommand* message;
 - 3> forward the *nas-SecurityParamFromEUTRA* to the upper layers;
 - 3> access the target cell indicated in the inter-RAT message in accordance with the specifications of the target RAT;

[TS 23.237, clause 6.3.2.1.4c]

Figure 6.3.2.1.4c-1 PS-CS: PS to CS - Single Radio, incoming call in alerting phase, provides an information flow for Access Transfer of media of an IMS session in PS to CS direction for Access Transfers as specified in TS 23.216 [10].

The flow requires that the user is active in a terminating IMS session and that the SIP session is in alerting state there is no other ongoing session and the UE has not responded over the access leg; procedures and capabilities specified in TS 23.216 [10], clause 6.2.1 are used for the switching of access networks at the transport layer. It further requires that the MSC Server supports I2 reference point.

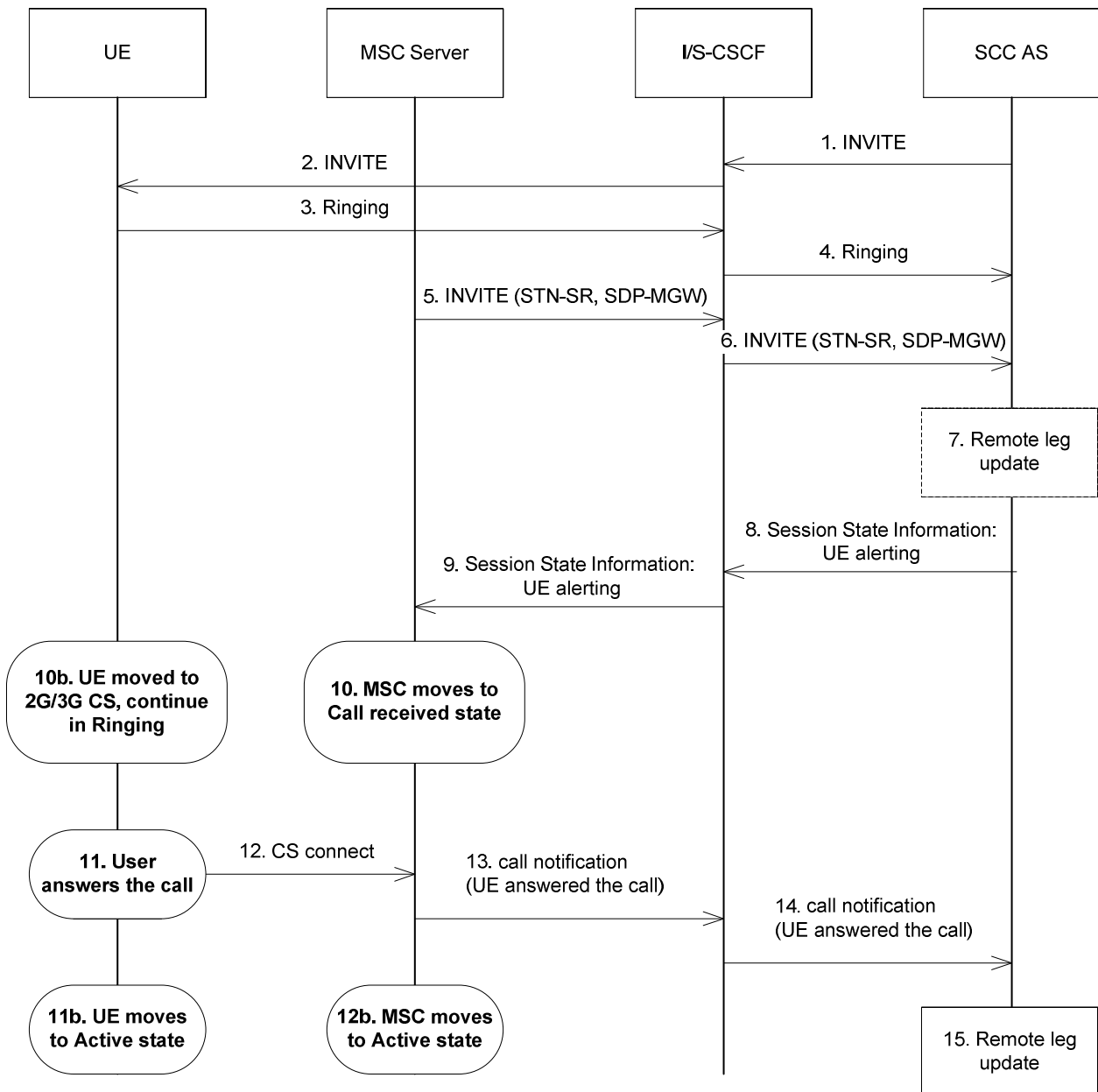

Figure 6.3.2.1.4c-1: PS-CS: PS to CS - Single Radio, incoming call in alerting phase

1-4. Standard procedures are used to initiate a SIP session towards the UE. The UE is alerting the user for the incoming voice session.

...

10. The MSC moves to the corresponding CS call state, e.g. Call Received in TS 24.008 [24].

NOTE 2: In call received state the MSC does not generate an in-band ring tone to the calling party.

10b. In parallel to step 10, the UE has received the HO command as described in TS 23.216 [10]. The UE determines the local call state in the SIP session, and creates the corresponding CS call state, e.g. Call Received in TS 24.008 [24]. The UE continues to alert the user for incoming call.

11. The user answers to the call.

11a. UE moves to Active state.

12. The UE uses the standard procedure to send the CS connect message to MSC as e.g. described in TS 24.008 [24].

[TS 23.216, clause 6.2.2.2]

Depicted in figure 6.2.2.2-1 is a call flow for SRVCC from E-UTRAN to UTRAN or GERAN with DTM HO support, including the handling of the non-voice component. The flow requires that eNB can determine that either the target is UTRAN with PS HO or the target is GERAN with DTM support and the UE is supporting DTM.

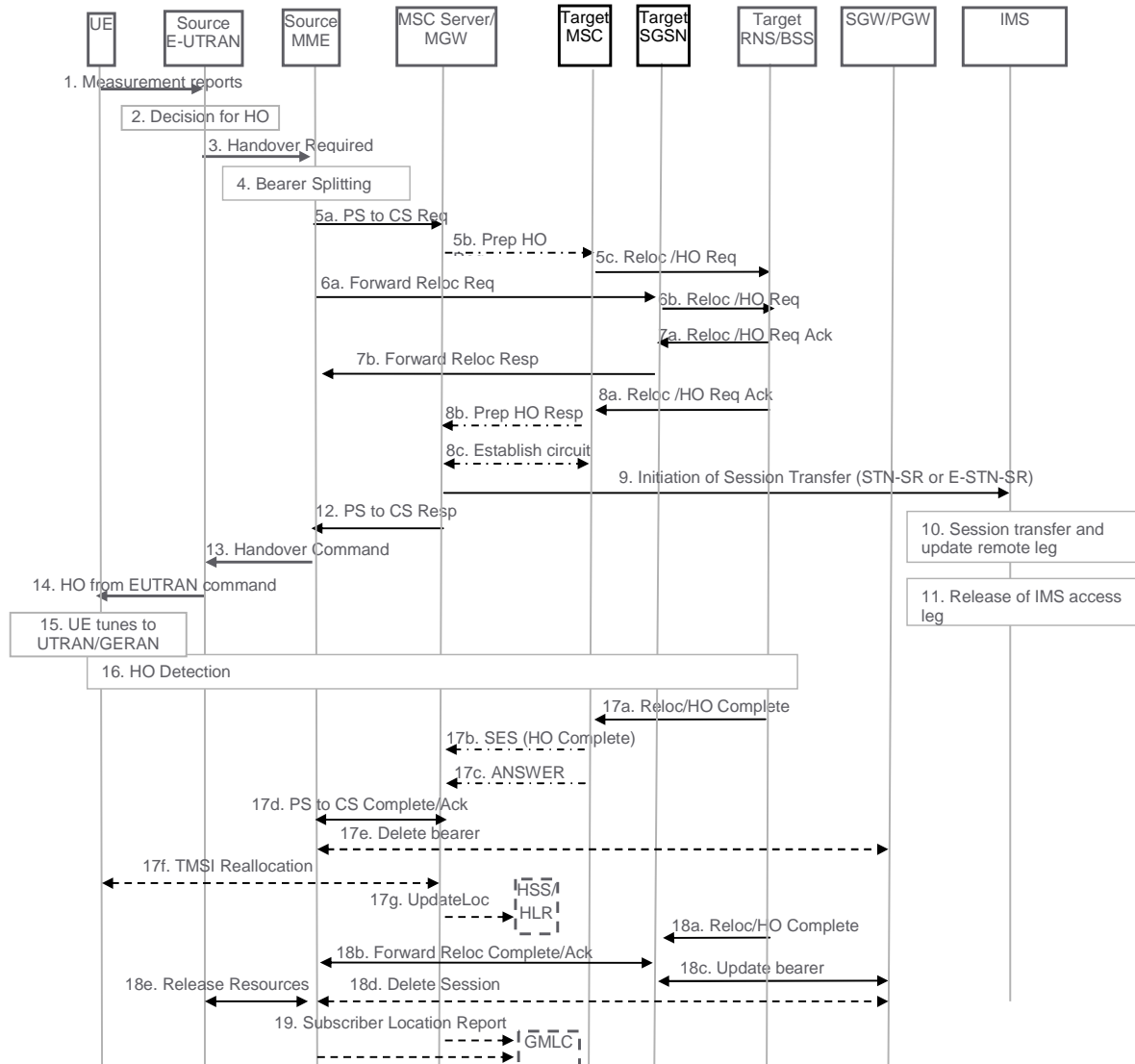

Figure 6.2.2.2-1: SRVCC from E-UTRAN to UTRAN with PS HO or GERAN with DTM HO support

1. UE sends measurement reports to E-UTRAN.

...

14. E-UTRAN sends a Handover from E-UTRAN Command message to the UE.

15. UE tunes to the target UTRAN/GERAN cell.

16. Handover Detection at the target RNS/BSS occurs. The UE sends a Handover Complete message via the target RNS/BSS to the target MSC. If the target MSC is not the MSC Server, then the Target MSC sends an SES (Handover Complete) message to the MSC Server. At this stage, the UE re-establishes the connection with the network and can send/receive voice data.

17. The CS relocation/handover is complete. The following steps are performed:

- a) Target RNS/BSS sends Relocation Complete/Handover Complete message to the target MSC.
- b) Target MSC sends an SES (Handover Complete) message to the MSC Server. The speech circuit is through connected in the MSC Server/MGW according to TS 23.009 [18].
- c) Completion of the establishment procedure with ISUP Answer message to the MSC Server according to TS 23.009 [18].
- d) MSC Server sends a SRVCC PS to CS Complete Notification message to the source MME. Source MME acknowledges the information by sending a SRVCC PS to CS Complete Acknowledge message to the MSC Server.
- e) The source MME deactivates the voice bearer towards S-GW/P-GW and sets the PS-to-CS handover indicator to Delete Bearer Command message. This triggers MME-initiated Dedicated Bearer Deactivation procedure as specified in TS 23.401 [2]. The MME does not send deactivation request toward the eNodeB on receiving PS-to-CS Complete Notification in step 17d. If dynamic PCC is deployed, the PGW may interact with PCRF as defined in TS 23.203 [31].
- f) If the HLR is to be updated, i.e. if the IMSI is authenticated but unknown in the VLR, the MSC Server performs a TMSI reallocation towards the UE using its own non-broadcast LAI and, if the MSC Server and other MSC/VLRs serve the same (target) LAI, with its own Network Resource Identifier (NRI).

NOTE 9: The TMSI reallocation is performed by the MSC Server towards the UE via target MSC.

- g) If the MSC Server performed a TMSI reallocation in step 17f, and if this TMSI reallocation was completed successfully, the MSC Server performs a MAP Update Location to the HSS/HLR.

NOTE 10: This Update Location is not initiated by the UE.

[TS 24.237, clause 12.1]

In order to fulfil the requirements for PS-CS access transfer in SR-VCC for calls in alerting state, the SC UE needs to be engaged in a session with speech media component in early dialog state according to the following conditions before SR-VCC access transfer is performed:

- a SIP 180 (Ringing) response for the initial SIP INVITE request to establish this session has been sent or received; and
- a SIP final response for the initial SIP INVITE request to establish this session has not been sent or received.

[TS 24.237, clause 12.2.3B.1]

The SC UE shall apply the procedures in subclauses 12.2.3B.3 for access transfer for calls in alerting state if:

- 1) the SC UE supports single radio PS to CS access transfer for calls in alerting state; and
- 2) there are one or more early dialogs created by the same SIP INVITE request with at least one dialog that is an early dialog supporting a session with active speech media component where the SC UE:
 - has sent a Contact header field in a SIP INVITE request or 180 (Ringing) response containing the g.3gpp.srvcc-alerting media feature tag (as described in annex C); and
 - has received a Feature-Caps header field in a SIP INVITE request or 180 (Ringing) response containing the g.3gpp.srvcc-alerting feature capability indicator (as described in annex C).

[TS 24.237, clause 12.2.3B.2]

If the SC UE applies the procedures in subclause 12.2.3B.3 and the SC UE only has a single call in alerting state following access transfer, then the SC UE shall associate this session with transaction identifier value and TI flag as described in 3GPP TS 24.008 [8].

[TS 24.237, clause 12.2.3B.3.1]

If the SC UE:

- has received a terminating call which is in the early dialog state according to the conditions in subclauses 12.1 and 12.2.3B.1; and

- successfully performs access transfer to the CS domain;

then the UE continues in Ringing state in CS, i.e. UE moves to Call Received (U7) state as described in 3GPP TS 24.008 [8].

[TS 24.008, clause 5.2.4.2]

If the MS supports single radio PS to CS access transfer for calls in alerting state as specified in 3GPP TS 24.237 [136] subclause 12.2.3B, and the MS has a single voice media stream over the PS domain that is handed over to the CS domain via SRVCC, and the call control entity in "null" state receives an indication "MM connection establishment due to SRVCC handover", then:

...

- if the voice media stream is associated with a mobile terminating session in the "early" state (defined in IETF RFC 3261 [137]) according to the conditions specified in 3GPP TS 24.237 [136] subclause 12.2.3B.3.1, the call control entity of the MS shall enter the "call received" state for this transaction. The MS and the network shall locally set the TI value of the call to "000" and the TI flag value as in mobile terminated call.

If the MS has additional voice media streams carried over the PS domain that are handed over to the CS domain via SRVCC, the state for the transactions and the setting of the TI value and TI flag for these additional media streams is described in 3GPP TS 24.237 [136].

13.4.3.12.3 Test description

13.4.3.12.3.1 Pre-test conditions

System Simulator:

- Cell 1 and Cell 5
- System information combination 4 as defined in TS 36.508 [18] clause 4.4.3.1 is used in E-UTRA cell.

UE:

None.

Preamble:

- The UE is in state Registered, Idle mode (state 2) on Cell 1 according to [18].

13.4.3.12.3.2 Test procedure sequence

Table 13.4.3.12.3.2-1 illustrates the downlink power levels and other changing parameters to be applied for the cells at various time instants of the test execution. Row marked "T0" denotes the initial conditions after preamble, while columns marked "T1" is to be applied subsequently. The exact instants on which these values shall be applied are described in the texts in this clause.

Table 13.4.3.12.3.2-1: Time instances of cell power level and parameter changes

	Parameter	Unit	Cell 1	Cell 5	Remark
T0	Cell-specific RS EPRE	dBm/15k Hz	-60	-	The power level values are such that entering conditions for event B2 are not satisfied.
	CPICH_Ec (UTRA FDD)	dBm/3.8 4 MHz	-	-88	
	PCCPCH_Ec (UTRA LCR TDD)	dBm/1.2 8 MHz	-	-88	
T1	Cell-specific RS EPRE	dBm/15k Hz	-84	-	The power level values are such that entering conditions for event B2 are satisfied.
	CPICH_Ec (UTRA FDD)	dBm/3.8 4 MHz	-	-64	
	PCCPCH_Ec (UTRA LCR TDD)	dBm/1.2 8 MHz	-	-64	

Table 13.4.3.12.3.2-2: Main behaviour

St	Procedure	Message Sequence		TP	Verdict
		U - S	Message		
1	The SS configures UTRA Cell 5 to reference configuration according 36.508 Table 4.8.3-1, condition UTRA Speech.	-	-	-	-
2-23	Steps 1 to 22 of the generic test procedure for IMS MT speech call (TS 36.508 4.5A.7.3-1).	-	-	-	-
24	The SS transmits an <i>RRCCONNECTIONRECONFIGURATION</i> message on Cell 1 to setup inter-RAT measurement and reporting for event B2.	<--	<i>RRCCONNECTIONRECONFIGURATION</i>	-	-
25	The UE transmits an <i>RRCCONNECTIONRECONFIGURATIONCOMPLETE</i> message on Cell 1.	-->	<i>RRCCONNECTIONRECONFIGURATIONCOMPLETE</i>	-	-
26	The SS changes the power level for Cell 1 and Cell 5 according to the row "T1" in Table 13.4.3.12.3.2-1	-	-	-	-
27	The UE transmits a <i>MEASUREMENTREPORT</i> message on Cell 1 to report event B2 for Cell 5.	-->	<i>MEASUREMENTREPORT</i>	-	-
28	Cause the UE to answer an MT call. (NOTE 1)	-	-	-	-
29	Step 23 of the generic test procedure for IMS MT speech call (TS 36.508 4.5A.7.3-1).	-	-	-	-
30	The SS transmits a <i>UECAPABILITYENQUIRY</i> message on Cell 1 to request UE radio access capability information for E-UTRA and UTRA.	<--	<i>UECAPABILITYENQUIRY</i>	-	-
31	The UE transmit a <i>UECAPABILITYINFORMATION</i> message on Cell 1. NOTE: The start-CS values received, should be used to configure ciphering on Cell 5.	-->	<i>UECAPABILITYINFORMATION</i>	-	-
32	The SS transmits a <i>MOBILITYFROMEUTRACOMMAND</i> message on Cell 1.	<--	<i>MOBILITYFROMEUTRACOMMAND</i>	-	-
33	Check: Does the UE transmit a HANDOVER TO UTRAN COMPLETE message on Cell 5?	-->	HANDOVER TO UTRAN COMPLETE	1	P
-	EXCEPTION: In parallel to the events described in step 34 to 39 the steps specified in Table 13.4.3.12.3.2-3 and 13.4.3.12.3.2-4 takes place.	-	-	-	-
34	The SS transmits a SECURITY MODE COMMAND message for the CS domain on Cell 5.	<--	SECURITY MODE COMMAND	-	-
35	The UE transmits a SECURITY MODE COMPLETE message on Cell 5.	-->	SECURITY MODE COMPLETE	-	-
36	The SS transmits an UTRAN MOBILITY INFORMATION message on Cell 5 to notify CN information.	<--	UTRAN MOBILITY INFORMATION	-	-
37	The UE transmits an UTRAN MOBILITY INFORMATION CONFIRM message on Cell 5.	-->	UTRAN MOBILITY INFORMATION CONFIRM	-	-
38	The SS transmits a TMSI REALLOCATION COMMAND message on Cell 5.	<--	TMSI REALLOCATION COMMAND	-	-
39	The UE transmits a TMSI REALLOCATION COMPLETE message on Cell 5.	-->	TMSI REALLOCATION COMPLETE	-	-
NOTE 1: The request may be triggered by MMI or by AT command A.					

Table 13.4.3.12.3.2-3: Parallel behaviour

St	Procedure	Message Sequence		TP	Verdict
		U - S	Message		
1	Check: Does the UE transmit a CONNECT message on Cell 5?	-->	CONNECT	2	P
2	The SS transmits a CONNECT ACKNOWLEDGE message on Cell 5.	<--	CONNECT ACKNOWLEDGE	-	-

Table 13.4.3.12.3.2-4: Parallel behaviour

St	Procedure	Message Sequence		TP	Verdict
		U - S	Message		
1	The UE transmit a ROUTING AREA UPDATE REQUEST message on Cell 5.	-->	ROUTING AREA UPDATE REQUEST	-	-
2	The SS transmits a SECURITY MODE COMMAND message for the PS domain on Cell 5.	<--	SECURITY MODE COMMAND	-	-
3	The UE transmits a SECURITY MODE COMPLETE message on Cell 5.	-->	SECURITY MODE COMPLETE	-	-
4	The SS transmits a ROUTING AREA UPDATE ACCEPT message on Cell 5.	<--	ROUTING AREA UPDATE ACCEPT	-	-
5	The UE transmits a ROUTING AREA UPDATE COMPLETE message on Cell 5.	-->	ROUTING AREA UPDATE COMPLETE	-	-

13.4.3.12.3.3 Specific message contents

Table 13.4.3.12.3.3-1: ATTACH REQUEST (preamble)

Derivation path: 36.508 Table 4.7.2-4			
Information Element	Value/remark	Comment	Condition
MS network capability	SRVCC from UTRAN HSPA or E-UTRAN to GERAN/UTRAN supported		
Mobile station classmark 2	Any allowed value		
Supported Codecs	Any allowed value		
Old GUTI type	Any allowed value		

Table 13.4.3.12.3.3-2: RRCConnectionReconfiguration (step 24, Table 13.4.3.12.3.2-2)

Derivation Path: 36.508, Table 4.6.1-8, condition MEAS
--

Table 13.4.3.12.3.3-3: MeasConfig (Table 13.4.3.12.3.3-2)

Derivation Path: 36.508, Table 4.6.6-1, condition UTRAN			
Information Element	Value/remark	Comment	Condition
MeasConfig ::= SEQUENCE {			
measObjectToAddModList SEQUENCE (SIZE (1..maxObjectId)) OF SEQUENCE {	2 entries		
measObjectId[1]	IdMeasObject-f1		
measObject[1]	MeasObjectEUTRA-GENERIC(f1)		
measObjectId[2]	IdMeasObject-f8		
measObject[2]	MeasObjectUTRA-f8		
}			
reportConfigToAddModList SEQUENCE (SIZE (1..maxReportConfigId)) OF SEQUENCE {	1 entry		
reportConfigId[1]	IdReportConfig-B2-UTRA		
reportConfig[1]	ReportConfigInterRAT-B2-UTRA (-72, -76)		
}			
measIdToAddModList SEQUENCE (SIZE (1..maxMeasId)) OF SEQUENCE {	1 entry		
measId[1]	1		
measObjectId[1]	IdMeasObject-f8		
reportConfigId[1]	IdReportConfig-B2-UTRA		
}			
}			

Table 13.4.3.12.3.3-4: MeasObjectUTRA-f8 (Table 13.4.3.12.3.3-3)

Derivation Path: 36.508, Table 4.6.6-3			
Information Element	Value/remark	Comment	Condition
MeasObjectUTRA ::= SEQUENCE {			
carrierFreq	Same downlink ARFCN as used for Cell 5		
cellsToAddModList CHOICE {			
cellsToAddModListUTRA-FDD SEQUENCE (SIZE (1..maxCellMeas)) OF SEQUENCE {	1 entry		UTRA-FDD
cellIndex[1]	1		
physCellId[1]	PhysicalCellIdentity of Cell 5		
}			
cellsToAddModListUTRA-TDD SEQUENCE (SIZE (1..maxCellMeas)) OF SEQUENCE {			UTRA-TDD
cellIndex[1]	1		
physCellId[1]	PhysicalCellIdentity of Cell 5		
}			
}			
csg-allowedReportingCells-v930	Not present		
}			

Condition	Explanation
UTRA-FDD	UTRA FDD cell environment
UTRA-TDD	UTRA TDD cell environment

Table 13.4.3.12.3.3-7: *MobilityFromEUTRACommand* (step 32, Table 13.4.3.12.3.2-2)

Derivation Path: 36.508, Table 4.6.1-6			
Information Element	Value/remark	Comment	Condition
MobilityFromEUTRACommand ::= SEQUENCE {			
criticalExtensions CHOICE {			
c1 CHOICE {			
mobilityFromEUTRACommand-r8 SEQUENCE {			
cs-FallbackIndicator	True		
purpose CHOICE {			
handover SEQUENCE {			
targetRAT-Type	utra		
targetRAT-MessageContainer	HANDOVER TO UTRAN COMMAND(UTRA RRC message)		
nas-SecurityParamFromEUTRA	The 4 least significant bits of the NAS downlink COUNT value		
systemInformation	Not present		
}			
}			
}			
}			
}			

Table 13.4.3.12.3.3-8: HANDOVER TO UTRAN COMMAND (Table 13.4.3.12.3.3-7)

Derivation Path: 36.508, Table 4.7B.1-1, condition UTRA Speech			

Table 13.4.3.12.3.3-9: SECURITY MODE COMMAND (step 34 Table 13.4.3.12.3.2-2)

Derivation Path: 36.508, Table 4.7B.1-n			
Information Element	Value/remark	Comment	Condition
Ciphering mode info	Not present		

Table 13.4.3.12.3.3-10: CONNECT (step 1, Table 13.4.3.12.3.2-3)

Derivation Path: TS 24.008 Table 9.59			
Information Element	Value/remark	Comment	Condition
Transaction identifier			
TI flag	'1'B	The message is sent to the side that originates the TI	
TIO	'000'B	TI value 0	

Table 13.4.3.12.3.3-11: CONNECT ACKNOWLEDGE (step 2, Table 13.4.3.12.3.2-3)

Derivation Path: TS 24.008 Table 9.60			
Information Element	Value/remark	Comment	Condition
Transaction identifier			
TI flag	'0'B	The message is sent from the side that originates the TI	
TIO	'000'B	TI value 0	

13.4.3.13 Inter-system mobility / E-UTRA voice to UTRA CS voice / aSRVCC / MT call / User answers in PS domain / SRVCC HO cancelled

13.4.3.13.1 Test Purpose (TP)

(1)

```

with { UE is in E-UTRA RRC_CONNECTED state and an IMS MT speech call is in alerting phase and UE has answered the call }
ensure that {
  when { UE receives a NOTIFICATION message }
  then { UE transmits a UPDATE message on the UTRA cell }
}
    
```

13.4.3.13.2 Conformance requirements

References: The conformance requirements covered in the present TC are specified in: TS 23.216, clause 6.2.2.2, clause 8.1.3, TS 24.237, clauses 12.1, 12.2.3B.1, clause 12.2.4.2 and TS 24.301, clause 6.6.2.2, clause 6.6.2.3.

[TS 23.216, clause 6.2.2.2]

Depicted in figure 6.2.2.2-1 is a call flow for SRVCC from E-UTRAN to UTRAN or GERAN with DTM HO support, including the handling of the non-voice component. The flow requires that eNB can determine that either the target is UTRAN with PS HO or the target is GERAN with DTM support and the UE is supporting DTM.

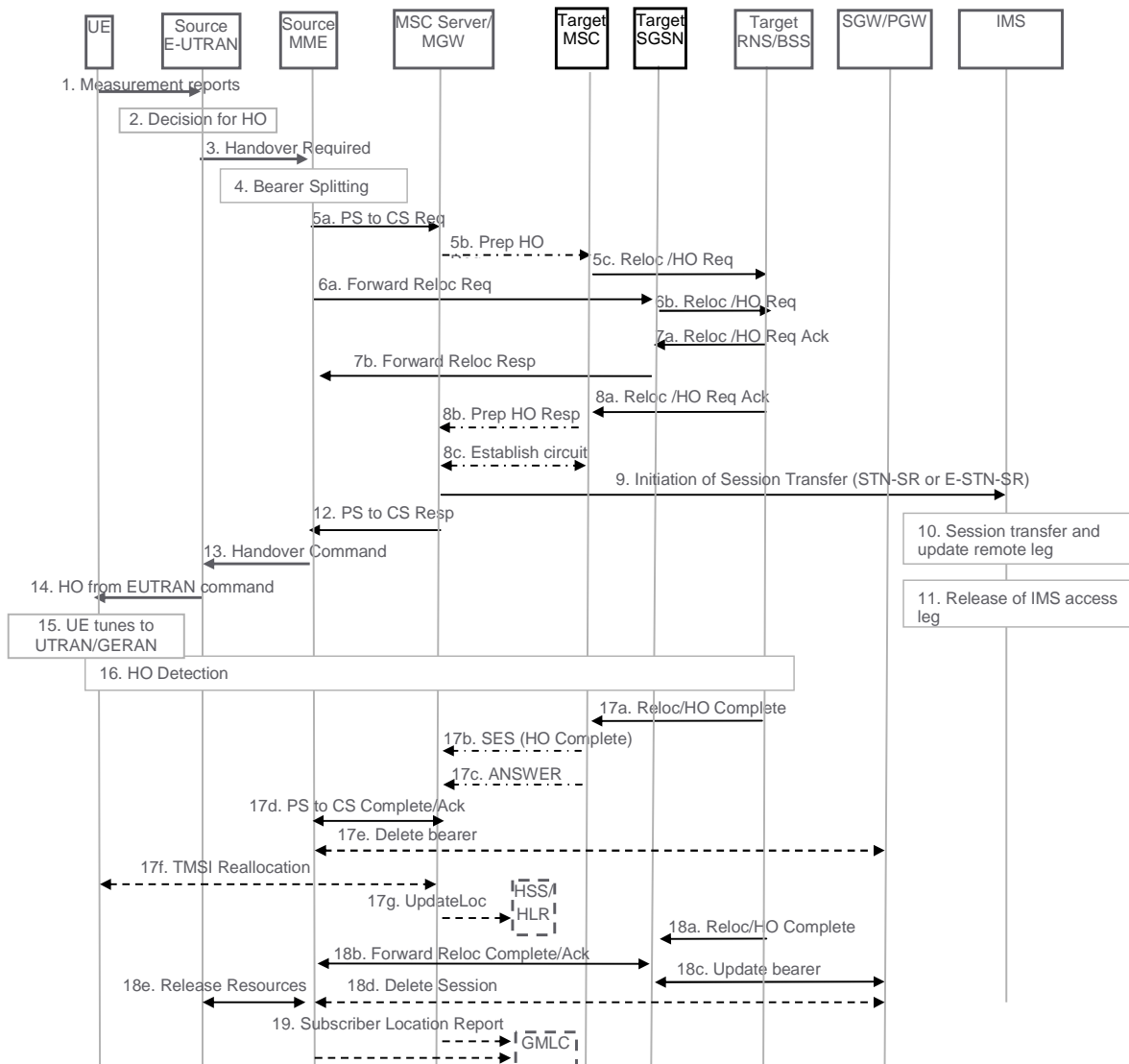

Figure 6.2.2.2-1: SRVCC from E-UTRAN to UTRAN with PS HO or GERAN with DTM HO support

1. UE sends measurement reports to E-UTRAN.

...

14. E-UTRAN sends a Handover from E-UTRAN Command message to the UE.

15. UE tunes to the target UTRAN/GERAN cell.

16. Handover Detection at the target RNS/BSS occurs. The UE sends a Handover Complete message via the target RNS/BSS to the target MSC. If the target MSC is not the MSC Server, then the Target MSC sends an SES (Handover Complete) message to the MSC Server. At this stage, the UE re-establishes the connection with the network and can send/receive voice data.

17. The CS relocation/handover is complete. The following steps are performed:

- a) Target RNS/BSS sends Relocation Complete/Handover Complete message to the target MSC.
- b) Target MSC sends an SES (Handover Complete) message to the MSC Server. The speech circuit is through connected in the MSC Server/MGW according to TS 23.009 [18].
- c) Completion of the establishment procedure with ISUP Answer message to the MSC Server according to TS 23.009 [18].
- d) MSC Server sends a SRVCC PS to CS Complete Notification message to the source MME. Source MME acknowledges the information by sending a SRVCC PS to CS Complete Acknowledge message to the MSC Server.
- e) The source MME deactivates the voice bearer towards S-GW/P-GW and sets the PS-to-CS handover indicator to Delete Bearer Command message. This triggers MME-initiated Dedicated Bearer Deactivation procedure as specified in TS 23.401 [2]. The MME does not send deactivation request toward the eNodeB on receiving PS-to-CS Complete Notification in step 17d. If dynamic PCC is deployed, the PGW may interact with PCRF as defined in TS 23.203 [31].
- f) If the HLR is to be updated, i.e. if the IMSI is authenticated but unknown in the VLR, the MSC Server performs a TMSI reallocation towards the UE using its own non-broadcast LAI and, if the MSC Server and other MSC/VLRs serve the same (target) LAI, with its own Network Resource Identifier (NRI).

NOTE 9: The TMSI reallocation is performed by the MSC Server towards the UE via target MSC.

- g) If the MSC Server performed a TMSI reallocation in step 17f, and if this TMSI reallocation was completed successfully, the MSC Server performs a MAP Update Location to the HSS/HLR.

NOTE 10: This Update Location is not initiated by the UE.

[TS 23.216, clause 8.1.3]

If the source E-UTRAN/UTRAN decides to terminate the handover procedure before its completion, the MME/SGSN shall return to its state before the handover procedure was triggered. The MME/SGSN attempts to trigger, at the MSC Server enhanced for SRVCC, handover cancellation procedures according to TS 23.009 [18]. The MSC Server enhanced for SRVCC shall take no SRVCC-specific action towards IMS.

The MME/SGSN shall also send a session reestablishment trigger notification to UE to start the recovery procedure if it receives notification from the MSC Server that the Session Transfer procedure is in progress. Figure 8.1.3-1 shows the overall procedure for SRVCC handover cancellation.

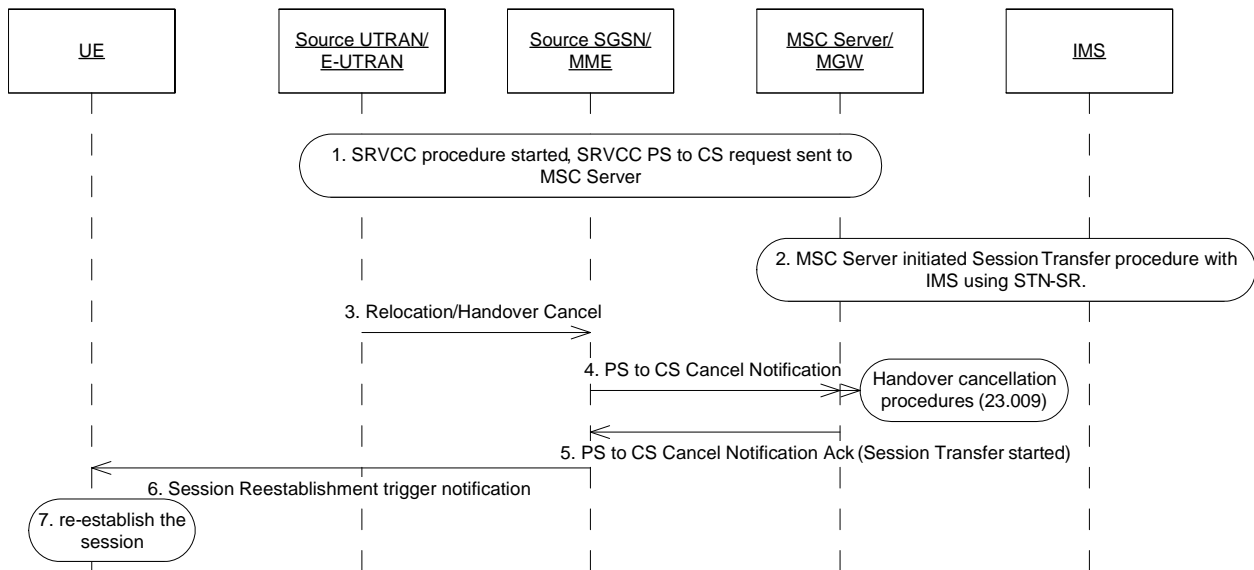

Figure 8.1.3-1: SRVCC Handover Cancellation Procedure

1. Network has started the SRVCC procedure. SGSN/MME has sent the SRVCC PS to CS request to MSC Server.
2. MSC Server is performing the CS HO procedure with target network, and has also started the Session Transfer procedure with IMS with STN-SR, see TS 23.237 [14].
3. Source UTRAN/E-UTRAN decides to cancel the SRVCC HO Procedure by sending a Cancel message to SGSN/MME.
4. Source SGSN/MME indicates SRVCC PS to CS Cancel Notification to MSC Server to start the HO cancellation procedure as according to TS 23.009 [18].
5. MSC Server acks the PS to CS Cancel Notification with an indication that Session Transfer procedure is in progress.
6. Due to the Session Transfer procedure in progress indication, the source SGSN/MME sends a Session Reestablishment trigger notification to UE to start the session re-establishment procedure
7. UE starts the re-establishment procedure, by attempting to return to E-UTRAN/UTRAN by sending a re-INVITE towards IMS for the related session. If the session is no longer active, then this session transfer request shall be rejected by the IMS.

[TS 24.237, clause 12.1]

In order to fulfil the requirements for PS-CS access transfer in SR-VCC for calls in alerting state, the SC UE needs to be engaged in a session with speech media component in early dialog state according to the following conditions before SR-VCC access transfer is performed:

- a SIP 180 (Ringing) response for the initial SIP INVITE request to establish this session has been sent or received; and
- a SIP final response for the initial SIP INVITE request to establish this session has not been sent or received.

[TS 24.237, clause 12.2.3B.1]

The SC UE shall apply the procedures in subclauses 12.2.3B.3 for access transfer for calls in alerting state if:

- 1) the SC UE supports single radio PS to CS access transfer for calls in alerting state; and
- 2) there are one or more early dialogs created by the same SIP INVITE request with at least one dialog that is an early dialog supporting a session with active speech media component where the SC UE:

- has sent a Contact header field in a SIP INVITE request or 180 (Ringing) response containing the g.3gpp.srvcc-alerting media feature tag (as described in annex C); and
- has received a Feature-Caps header field in a SIP INVITE request or 180 (Ringing) response containing the g.3gpp.srvcc-alerting feature capability indicator (as described in annex C).

[TS 24.237, clause 12.2.4.2]

If the SC UE is engaged in a session in early dialog state and:

- receives a SM NOTIFICATION message containing an "SRVCC handover cancelled, IMS session re-establishment required" as described in 3GPP TS 24.008 [8] or 3GPP TS 24.301 [52] depending on the access in use; or
- does not successfully retune to the 3GPP UTRAN or 3GPP GERAN after it receives the handover command from the eNodeB (as described in 3GPP TS 36.331 [62]) or from the NodeB (as described in 3GPP TS 25.331 [61]);

then if the SC UE the SC UE shall send a SIP UPDATE request containing:

- 1) an SDP offer, including the media characteristics as used in the existing dialog; and
- 2) a Reason header field containing protocol "SIP" and reason parameter "cause" with value "487" as specified in IETF RFC 3326 [57], and with reason-text set to either "handover cancelled" or "failure to transition to CS domain";

by following the rules of 3GPP TS 24.229 [2] in each transferred session.

[TS 24.301, clause 6.6.2.2]

The network initiates the notification procedure by sending a NOTIFICATION message to the UE (see example in figure 6.6.2.2.1).



Figure 6.6.2.2.1: Notification procedure

[TS 24.301, clause 6.6.2.3]

When the UE receives a NOTIFICATION message, the ESM protocol entity in the UE shall provide the notification indicator to the upper layer.

The notification indicator can have the following value:

- #1: SRVCC handover cancelled, IMS session re-establishment required.

13.4.3.13.3 Test description

13.4.3.13.3.1 Pre-test conditions

System Simulator:

- Cell 1 and Cell 5
- System information combination 4 as defined in TS 36.508 [18] clause 4.4.3.1 is used in E-UTRA cell.

UE:

None.

Preamble:

- The UE is in state Registered, Idle mode (state 2) on Cell 1 according to [18].

13.4.3.13.3.2 Test procedure sequence

Table 13.4.3.13.3.2-1 illustrates the downlink power levels and other changing parameters to be applied for the cells at various time instants of the test execution. Row marked "T0" denotes the initial conditions after preamble, while columns marked "T1" is to be applied subsequently. The exact instants on which these values shall be applied are described in the texts in this clause.

Table 13.4.3.13.3.2-1: Time instances of cell power level and parameter changes

	Parameter	Unit	Cell 1	Cell 5	Remark
T0	Cell-specific RS EPRE	dBm/15k Hz	-60	-	The power level values are such that entering conditions for event B2 are not satisfied.
	CPICH_Ec (UTRA FDD)	dBm/3.8 4 MHz	-	-88	
	PCCPCH_Ec (UTRA LCR TDD)	dBm/1.2 8 MHz	-	-88	
T1	Cell-specific RS EPRE	dBm/15k Hz	-84	-	The power level values are such that entering conditions for event B2 are satisfied.
	CPICH_Ec (UTRA FDD)	dBm/3.8 4 MHz	-	-64	
	PCCPCH_Ec (UTRA LCR TDD)	dBm/1.2 8 MHz	-	-64	

Table 13.4.3.13.3.2-2: Main behaviour

St	Procedure	Message Sequence		TP	Verdict
		U - S	Message		
1	The SS configures UTRA Cell 5 to reference configuration according 36.508 Table 4.8.3-1, condition UTRA Speech.	-	-	-	-
2-23	Steps 1 to 22 of the generic test procedure for IMS MT speech call (TS 36.508 4.5A.7.3-1).	-	-	-	-
24	The SS transmits an <i>RRCCONNECTIONRECONFIGURATION</i> message on Cell 1 to setup inter-RAT measurement and reporting for event B2.	<--	<i>RRCCONNECTIONRECONFIGURATION</i>	-	-
25	The UE transmits an <i>RRCCONNECTIONRECONFIGURATIONCOMPLETE</i> message on Cell 1.	-->	<i>RRCCONNECTIONRECONFIGURATIONCOMPLETE</i>	-	-
26	The SS changes the power level for Cell 1 and Cell 5 according to the row "T1" in Table 13.4.3.13.3.2-1	-	-	-	-
27	The UE transmits a <i>MEASUREMENTREPORT</i> message on Cell 1 to report event B2 for Cell 5.	-->	<i>MEASUREMENTREPORT</i>	-	-
28	Cause the UE to answer an MT call. (NOTE 1)	-	-	-	-
29	Step 23 of the generic test procedure for IMS MT speech call (TS 36.508 4.5A.7.3-1).	-	-	-	-
30	The SS transmits a NOTIFICATION message on Cell 1.	<--	NOTIFICATION	-	-
31	Check: Does the UE transmit SIP UPDATE request on Cell 1? NOTE: Step 1 defined in annex C.28 of TS 34.229-1 [35] is performed.	-	-	1	P
32	Step 2 expected sequence defined in annex C.28 of TS 34.229-1 [35].	-	-	-	-
33	Step 24 of the generic test procedure for IMS MT speech call (TS 36.508 4.5A.7.3-1).	-	-	-	-
NOTE 1: The request may be triggered by MMI or by AT command A.					

13.4.3.13.3.3 Specific message contents

Table 13.4.3.13.3.3-1: ATTACH REQUEST (preamble)

Derivation path: 36.508 Table 4.7.2-4			
Information Element	Value/remark	Comment	Condition
MS network capability	SRVCC from UTRAN HSPA or E-UTRAN to GERAN/UTRAN supported		
Mobile station classmark 2	Any allowed value		
Supported Codecs	Any allowed value		
Old GUTI type	Any allowed value		

Table 13.4.3.13.3.3-2: RRCConnectionReconfiguration (step 24, Table 13.4.3.13.3.2-2)

Derivation Path: 36.508, Table 4.6.1-8, condition MEAS
--

Table 13.4.3.13.3.3-3: MeasConfig (Table 13.4.3.13.3.3-2)

Derivation Path: 36.508, Table 4.6.6-1, condition UTRAN			
Information Element	Value/remark	Comment	Condition
MeasConfig ::= SEQUENCE {			
measObjectToAddModList SEQUENCE (SIZE (1..maxObjectId)) OF SEQUENCE {	2 entries		
measObjectId[1]	IdMeasObject-f1		
measObject[1]	MeasObjectUTRA-GENERIC(f1)		
measObjectId[2]	IdMeasObject-f8		
measObject[2]	MeasObjectUTRA-f8		
}			
reportConfigToAddModList SEQUENCE (SIZE (1..maxReportConfigId)) OF SEQUENCE {	1 entry		
reportConfigId[1]	IdReportConfig-B2-UTRA		
reportConfig[1]	ReportConfigInterRAT-B2-UTRA (-72, -76)		
}			
measIdToAddModList SEQUENCE (SIZE (1..maxMeasId)) OF SEQUENCE {	1 entry		
measId[1]	1		
measObjectId[1]	IdMeasObject-f8		
reportConfigId[1]	IdReportConfig-B2-UTRA		
}			
quantityConfig	QuantityConfig-DEFAULT-RSCP		
}			

Table 13.4.3.13.3.3-4: MeasObjectUTRA-f8 (Table 13.4.3.13.3.3-3)

Derivation Path: 36.508, Table 4.6.6-3			
Information Element	Value/remark	Comment	Condition
MeasObjectUTRA ::= SEQUENCE {			
carrierFreq	Same downlink ARFCN as used for Cell 5		
cellsToAddModList CHOICE {			
cellsToAddModListUTRA-FDD SEQUENCE (SIZE (1..maxCellMeas)) OF SEQUENCE {	1 entry		UTRA-FDD
cellIndex[1]	1		
physCellId[1]	PhysicalCellIdentity of Cell 5		
}			
cellsToAddModListUTRA-TDD SEQUENCE (SIZE (1..maxCellMeas)) OF SEQUENCE {			UTRA-TDD
cellIndex[1]	1		
physCellId[1]	PhysicalCellIdentity of Cell 5		
}			
}			
csg-allowedReportingCells-v930	Not present		
}			

Condition	Explanation
UTRA-FDD	UTRA FDD cell environment
UTRA-TDD	UTRA TDD cell environment

Table 13.4.3.13.3.3-5: MeasurementReport (step 27, Table 13.4.3.13.3.2-2)

Derivation Path: 36.508, Table 4.6.1-5			
Information Element	Value/remark	Comment	Condition
MeasurementReport ::= SEQUENCE {			
criticalExtensions CHOICE {			
c1 CHOICE {			
measurementReport-r8 SEQUENCE {			
measResults SEQUENCE {			
measId	1		
measResultPCell SEQUENCE {			
rsrpResult	(0..97)		
rsrqResult	(0..34)		
}			
measResultNeighCells CHOICE {			
measResultListUTRA SEQUENCE (SIZE (1..maxCellReport)) OF SEQUENCE {	1 entry		
physCellId[1] CHOICE {			
fdd	PhysicalCellIdentity of Cell 5		UTRA-FDD
tdd	PhysicalCellIdentity of Cell 5		UTRA-TDD
}			
cgi-Info[1]	Not present		
measResult[1] SEQUENCE {			
utra-RSCP	(-5..91)		
utra-EcN0	Not present		
additionalSI-Info-r9	Not present		
}			
}			
measResultForECID-r9	Not present		
locationInfo-r10	Not present		
measResultServFreqList-r10	Not present		
}			
}			
}			
}			
}			

Condition	Explanation
UTRA-FDD	UTRA FDD cell environment
UTRA-TDD	UTRA TDD cell environment

Table 13.4.3.13.3.3-6: NOTIFICATION (step 30, Table 13.4.3.13.3.2-2)

Derivation Path: 36.508, Table 4.7.3-19A, condition SRVCC-HO-CANCELLED

13.4.3.14 Inter-system mobility / E-UTRA PS voice + PS data to UTRA CS voice + PS data / aSRVCC / MO call

13.4.3.14.1 Test Purpose (TP)

(1)

```

with { UE in E-UTRA RRC_CONNECTED state }
ensure that {
  when { UE receives a MobilityFromEUTRACommand message and an MO IMS voice call is in alerting state and an UTRA PS RB + Speech combination is configured for an UTRA cell }
  then { UE transmits a HANDOVER TO UTRAN COMPLETE message on the utra cell }

```

```

    }

```

(2)

```

with { UE having transmitted a HANDOVER TO UTRAN COMPLETE message }
ensure that {
  when { the voice call is accepted }
  then { UE transmits a CONNECT ACKNOWLEDGE message on the utra cell }
}

```

13.4.3.14.2 Conformance requirements

References: The conformance requirements covered in the present TC are specified in: TS 36.331, clause 5.4.3.3, TS 24.237 clause 12.2.3B.1 and clause 12.2.3B.3.2.

[TS 36.331, clause 5.4.3.3]

The UE shall be able to receive a *MobilityFromEUTRACCommand* message and perform a cell change order to GERAN, even if no prior UE measurements have been performed on the target cell.

The UE shall:

- 1> stop timer T310, if running;
- 1> if the *MobilityFromEUTRACCommand* message includes the *purpose* set to 'handover':
 - 2> if the *targetRAT-Type* is set to 'utra' or 'geran':
 - 3> consider inter-RAT mobility as initiated towards the RAT indicated by the *targetRAT-Type* included in the *MobilityFromEUTRACCommand* message;
 - 3> forward the *nas-SecurityParamFromEUTRA* to the upper layers;
 - 3> access the target cell indicated in the inter-RAT message in accordance with the specifications of the target RAT;

[TS 24.237 clause 12.2.3B.1]

The SC UE shall apply the procedures in subclauses 12.2.3B.3 for access transfer for calls in alerting state if:

- 1) the SC UE supports single radio PS to CS access transfer for calls in alerting state; and
- 2) there are one or more early dialogs created by the same SIP INVITE request with at least one dialog that is an early dialog supporting a session with active speech media component where the SC UE:
 - has sent a Contact header field in a SIP INVITE request or 180 (Ringing) response containing the g.3gpp.srvcc-alerting media feature tag (as described in annex C); and
 - has received a Feature-Caps header field in a SIP INVITE request or 180 (Ringing) response containing the g.3gpp.srvcc-alerting feature capability indicator (as described in annex C).

[TS 24.237 clause 12.2.3B.3.2]

If the SC UE has initiated an outgoing call which is in the early dialog state according to the conditions in subclauses 12.1 and 12.2.3B.1 and the SC UE successfully performs access transfer to the CS domain, then the UE continues in Ringing state in CS, i.e. UE moves to Call Delivered (U4) state as described in 3GPP TS 24.008 [8].

13.4.3.14.3 Test description

13.4.3.14.3.1 Pre-test conditions

System Simulator:

- Cell 1 and Cell 5.
- System information combination 4 as defined in TS 36.508 [18] clause 4.4.3.1 is used in E-UTRA cells.

UE:

None.

Preamble:

- The UE is in state Registered, Idle mode (state 2) on Cell 1 according to [18].

13.4.3.14.3.2 Test procedure sequence

Table 13.4.3.14.3.2-1 illustrates the downlink power levels and other changing parameters to be applied for the cells at various time instants of the test execution. Row marked "T0" denotes the initial conditions after preamble, while columns marked "T1" is to be applied subsequently. The exact instants on which these values shall be applied are described in the texts in this clause.

Table 13.4.3.14.3.2-1: Time instances of cell power level and parameter changes

	Parameter	Unit	Cell 1	Cell 5	Remark
T0	Cell-specific RS EPRE	dBm/15k Hz	-60	-	The power level values are such that entering conditions for event B2 are not satisfied.
	CPICH_Ec (UTRA FDD)	dBm/3.8 4 MHz	-	-88	
	PCCPCH_Ec (UTRA LCR TDD)	dBm/1.2 8 MHz	-	-88	
T1	Cell-specific RS EPRE	dBm/15k Hz	-84	-	The power level values are such that entering conditions for event B2 are satisfied.
	CPICH_Ec (UTRA FDD)	dBm/3.8 4 MHz	-	-64	
	PCCPCH_Ec (UTRA LCR TDD)	dBm/1.2 8 MHz	-	-64	

Table 13.4.3.14.3.2-2: Main behaviour

St	Procedure	Message Sequence		TP	Verdict
		U - S	Message		
1	The SS configures UTRA cell 5 to reference configuration according 36.508 table 4.8.3-1, condition UTRA PS RB + Speech.	-	-	-	-
2-15	Steps 1 to 14 of the generic test procedure for IMS MO speech call and aSRVCC (TS 36.508 4.5A.10.3-1).	-	-	-	-
16	The SS transmits an <i>RRCCONNECTIONRECONFIGURATION</i> message on Cell 1 to setup inter RAT measurement and reporting for event B2.	<--	<i>RRCCONNECTIONRECONFIGURATION</i>	-	-
17	The UE transmits an <i>RRCCONNECTIONRECONFIGURATIONCOMPLETE</i> message on Cell 1.	-->	<i>RRCCONNECTIONRECONFIGURATIONCOMPLETE</i>	-	-
18	The SS changes the power level for Cell 1 and Cell 5 according to the row "T1" in table 13.4.3.14.3.2-1	-	-	-	-
19	The UE transmits a <i>MEASUREMENTREPORT</i> message on Cell 1 to report event B2 for Cell 5.	-->	<i>MEASUREMENTREPORT</i>	-	-
20	The SS transmits a <i>UECAPABILITYENQUIRY</i> message to request UE radio access capability information for E-UTRA and UTRA.	<--	<i>UECAPABILITYENQUIRY</i>	-	-
21	The UE transmit a <i>UECAPABILITYINFORMATION</i> message on Cell 1. NOTE: The start-PS and start-CS values received, should be used to configure ciphering on cell 5.	-->	<i>UECAPABILITYINFORMATION</i>	-	-
22	The SS transmits a <i>MOBILITYFROMEUTRACOMMAND</i> message on Cell 1.	<--	<i>MOBILITYFROMEUTRACOMMAND</i>	-	-
23	Check: Does the UE transmit a HANDOVER TO UTRAN COMPLETE message on cell 5?	-->	HANDOVER TO UTRAN COMPLETE	1	P
-	EXCEPTION: In parallel to the events described in step 24 to 31 the step specified in table 13.4.3.14.3.2-3 takes place.	-	-	-	-
24	The SS transmits a SECURITY MODE COMMAND message for the CS domain.	<--	SECURITY MODE COMMAND	-	-
25	The UE transmits a SECURITY MODE COMPLETE message.	-->	SECURITY MODE COMPLETE	-	-
26	The SS transmits an UTRAN MOBILITY INFORMATION message to notify CN information.	<--	UTRAN MOBILITY INFORMATION	-	-
27	The UE transmits an UTRAN MOBILITY INFORMATION CONFIRM message.	-->	UTRAN MOBILITY INFORMATION CONFIRM	-	-
28	The SS transmits a TMSI REALLOCATION COMMAND message.	<--	TMSI REALLOCATION COMMAND	-	-
29	The UE transmits a TMSI REALLOCATION COMPLETE message.	-->	TMSI REALLOCATION COMPLETE	-	-
30	The SS transmits a CONNECT message on Cell 5.	<--	CONNECT	-	-
31	Check: Does the UE transmit a CONNECT ACKNOWLEDGE message on Cell 5?	-->	CONNECT ACKNOWLEDGE	2	P
32	The SS transmits a SECURITY MODE COMMAND message for the PS domain.	<--	SECURITY MODE COMMAND	-	-
33	The UE transmits a SECURITY MODE COMPLETE message.	-->	SECURITY MODE COMPLETE	-	-
34	The SS transmits a ROUTING AREA UPDATE ACCEPT message.	<--	ROUTING AREA UPDATE ACCEPT	-	-
35	The UE transmits a ROUTING AREA UPDATE COMPLETE message.	-->	ROUTING AREA UPDATE COMPLETE	-	-
36-37	Void	-	-	-	-

Table 13.4.3.14.3.2-3: Parallel behaviour

St	Procedure	Message Sequence		TP	Verdict
		U - S	Message		
1	Check: Does the UE transmit a ROUTING AREA UPDATE REQUEST message?	-->	ROUTING AREA UPDATE REQUEST	-	-

13.4.3.14.3.3 Specific message contents

Table 13.4.3.14.3.3-1: ATTACH REQUEST (preamble)

Derivation path: 36.508 table 4.7.2-4			
Information Element	Value/remark	Comment	Condition
MS network capability	SRVCC from UTRAN HSPA or E-UTRAN to GERAN/UTRAN supported		
Mobile station classmark 2	Any allowed value		
Supported Codecs	Any allowed value		

Table 13.4.3.14.3.3-2: RRCConnectionReconfiguration (step 16, Table 13.4.3.14.3.2-2)

Derivation Path: 36.508 clause 4.6.1 table 4.6.1-8 with condition MEAS
--

Table 13.4.3.14.3.3-3: MeasConfig (step 16, Table 13.4.3.14.3.2-2)

Derivation path: 36.508 clause 4.6.6 table 4.6.6-1 with condition UTRAN			
Information Element	Value/Remark	Comment	Condition
measurementConfiguration ::= SEQUENCE {			
measObjectToAddModifyList SEQUENCE (SIZE (1..maxObjectId)) OF SEQUENCE {	2 entries		
measObjectId[1]	IdMeasObject-f8		
measObject[1]	MeasObjectUTRA-GENERIC(f8)		
measObjectId[2]	IdMeasObject-f1		
measObject[2]	MeasObjectEUTRA-GENERIC(f1)		
}			
reportConfigToAddModifyList SEQUENCE (SIZE (1..maxReportConfigId)) OF SEQUENCE {	1 entry		
reportConfigId[1]	IdReportConfigInterRAT-B2-UTRA		
reportConfig[1]	ReportConfigInterRAT-B2-UTRA (-72, -76)		
}			
measIdToAddModifyList SEQUENCE (SIZE (1..maxMeasId)) OF SEQUENCE {	1 entry		
measId[1]	1		
measObjectId[1]	IdMeasObject-f8		
reportConfigId[1]	IdReportConfigInterRAT-B2-UTRA		
}			
}			

Table 13.4.3.14.3.3-4: MeasurementReport (step 19, Table 13.4.3.14.3.2-2)

Derivation Path: 36.508, table 4.6.1-5			
Information Element	Value/remark	Comment	Condition
MeasurementReport ::= SEQUENCE {			
criticalExtensions CHOICE {			
c1 CHOICE{			
measurementReport-r8 SEQUENCE {			
measResults SEQUENCE {			
measId	1		
measResultServCell SEQUENCE {			
rsrpResult	(0..97)		
rsrqResult	(0..34)		
}			
measResultNeighCells CHOICE {			
measResultListUTRA SEQUENCE (SIZE (1..maxCellReport)) OF SEQUENCE {	1 entry		
physCellId[1]	PhysicalCellIdentity of Cell 5		
cgi-Info[1]	Not present		
measResult[1] SEQUENCE {			
utra-RSCP	(-5..91)		
}			
}			
}			
}			
}			
}			
}			
}			
}			

Table 13.4.3.14.3.3-5: MobilityFromEUTRACommand (step 20, Table 13.4.3.14.3.2-2)

Derivation Path: 36.508, Table 4.6.1-6			
Information Element	Value/remark	Comment	Condition
MobilityFromEUTRACommand ::= SEQUENCE {			
criticalExtensions CHOICE {			
c1 CHOICE{			
mobilityFromEUTRACommand-r8 SEQUENCE {			
cs-FallbackIndicator	True		
purpose CHOICE{			
handover SEQUENCE {			
targetRAT-Type	Utra		
targetRAT-MessageContainer	HANDOVER TO UTRAN COMMAND(UTRA RRC message)		
nas-SecurityParamFromEUTRA	The 4 least significant bits of the NAS downlink COUNT value		
systemInformation	Not present		
}			
}			
}			
}			
}			
}			

Table 13.4.3.14.3.3-6: HANDOVER TO UTRAN COMMAND (step 20, Table 13.4.3.14.3.3-5)

Derivation Path: 36.508, Table 4.7B.1-1, condition UTRA PS RB + Speech
--

Table 13.4.3.14.3.3-7: UECapabilityEnquiry (step 21, Table 13.4.3.14.3.2-2)

Derivation path: 36.508 clause 4.6.1 table 4.6.1-22			
Information Element	Value/Remark	Comment	Condition
UECapabilityEnquiry ::= SEQUENCE {			
criticalExtensions CHOICE {			
c1 CHOICE {			
ueCapabilityEnquiry-r8 SEQUENCE {			
ue-CapabilityRequest SEQUENCE (SIZE	2 entry		
(1..maxRAT-Capabilities)) OF SEQUENCE {			
RAT-Type[1]	eutra		
RAT-Type[2]	utra		
}			
}			
}			
}			
}			

Table 13.4.3.14.3.3-8: SECURITY MODE COMMAND (step 26, Table 13.4.3.14.3.2-2)

Derivation Path: 36.508, Table 4.7B.1-n		
Information Element	Condition	Value/remark
Ciphering mode info		Not Present

13.4.3.15 Inter-system mobility / E-UTRA PS voice + PS data to UTRA CS voice + PS data / aSRVCC / MO call / SRVCC HO cancelled

13.4.3.15.1 Test Purpose (TP)

(1)

```

with { UE in E-UTRA RRC_CONNECTED state and an MO IMS PS voice + PS data call is in alerting state
with a SRVCC procedure started over an UTRA cell for which UTRA PS RB + Speech combination is
configured }
ensure that {
  when { the source E-UTRAN decides to terminate the handover procedure before its completion
indicating this to the UE with a NOTIFICATION message }
  then { UE starts a recovery procedure, transmits a SIP UPDATE message and successfully completes
the MO call on the E-UTRA }
}

```

13.4.3.15.2 Conformance requirements

References: The conformance requirements covered in the present TC are specified in: TS 23.216, clause 6.2.2.2 and clause 8.1.3, TS 24.301, clause 6.6.2.2, TS 24.237 clauses 12.1, 12.2.3B.1, clause 12.2.4.2.

[TS 23.216, clause 6.2.2.2]

Depicted in figure 6.2.2.2-1 is a call flow for SRVCC from E-UTRAN to UTRAN or GERAN with DTM HO support, including the handling of the non-voice component. The flow requires that eNB can determine that either the target is UTRAN with PS HO or the target is GERAN with DTM support and the UE is supporting DTM.

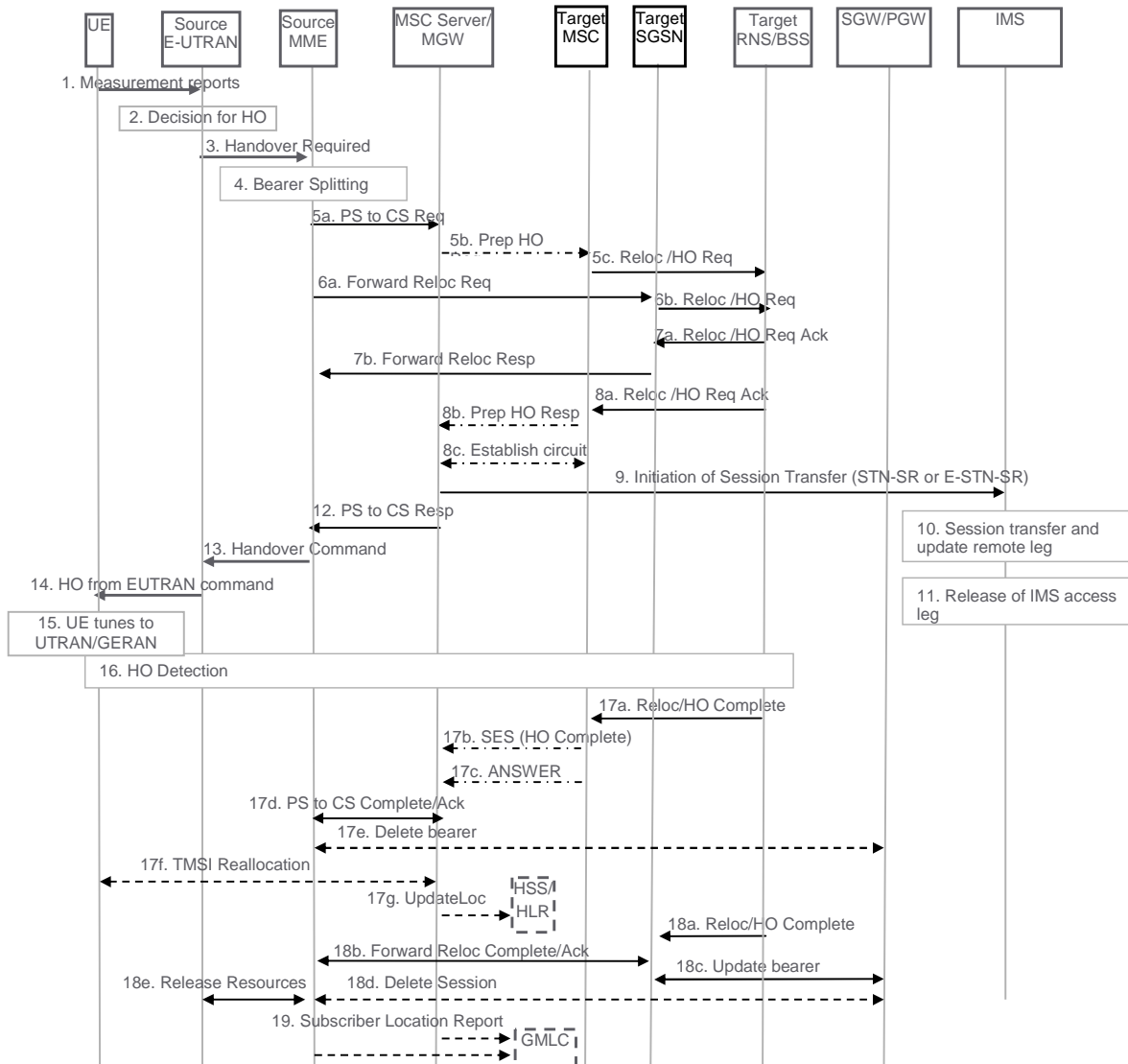

Figure 6.2.2.2-1: SRVCC from E-UTRAN to UTRAN with PS HO or GERAN with DTM HO support

1. UE sends measurement reports to E-UTRAN.
2. Based on UE measurement reports the source E-UTRAN decides to trigger an SRVCC handover to UTRAN/GERAN.

[TS 23.216, clause 8.1.3]

If the source E-UTRAN/UTRAN decides to terminate the handover procedure before its completion, the MME/SGSN shall return to its state before the handover procedure was triggered. The MME/SGSN attempts to trigger, at the MSC Server enhanced for SRVCC, handover cancellation procedures according to TS 23.009 [18]. The MSC Server enhanced for SRVCC shall take no SRVCC-specific action towards IMS.

The MME/SGSN shall also send a session reestablishment trigger notification to UE to start the recovery procedure if it receives notification from the MSC Server that the Session Transfer procedure is in progress. Figure 8.1.3-1 shows the overall procedure for SRVCC handover cancellation.

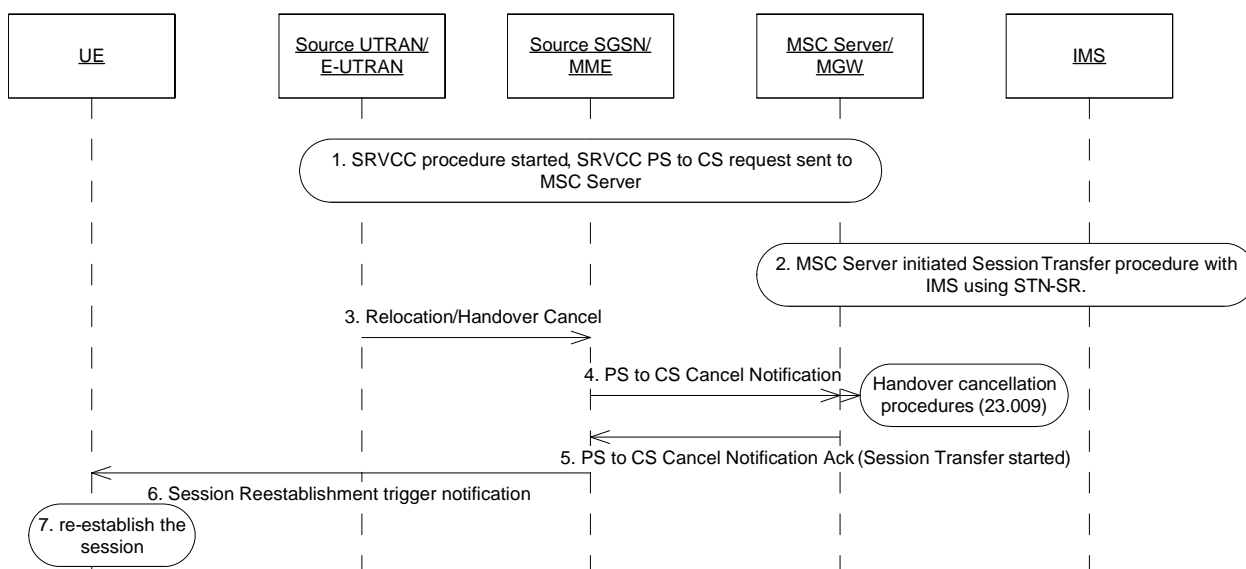

Figure 8.1.3-1: SRVCC Handover Cancellation Procedure

- 6. Due to the Session Transfer procedure in progress indication, the source SGSN/MME sends a Session Reestablishment trigger notification to UE to start the session re-establishment procedure
- 7. UE starts the re-establishment procedure, by attempting to return to E-UTRAN/UTRAN by sending a re-INVITE towards IMS for the related session. If the session is no longer active, then this session transfer request shall be rejected by the IMS.

[TS 24.301, clause 6.6.2.2]

The network initiates the notification procedure by sending a NOTIFICATION message to the UE (see example in figure 6.6.2.2.1).



Figure 6.6.2.2.1: Notification procedure

[TS 24.237, clause 12.1]

In order to fulfil the requirements for PS-CS access transfer in SR-VCC for calls in alerting state, the SC UE needs to be engaged in a session with speech media component in early dialog state according to the following conditions before SR-VCC access transfer is performed:

- a SIP 180 (Ringing) response for the initial SIP INVITE request to establish this session has been sent or received; and
- a SIP final response for the initial SIP INVITE request to establish this session has not been sent or received.

[TS 24.237, clause 12.2.3B.1]

The SC UE shall apply the procedures in subclauses 12.2.3B.3 for access transfer for calls in alerting state if:

- 1) the SC UE supports single radio PS to CS access transfer for calls in alerting state; and

- 2) there are one or more early dialogs created by the same SIP INVITE request with at least one dialog that is an early dialog supporting a session with active speech media component where the SC UE:
- has sent a Contact header field in a SIP INVITE request or 180 (Ringing) response containing the g.3gpp.srvcc-alerting media feature tag (as described in annex C); and
 - has received a Feature-Caps header field in a SIP INVITE request or 180 (Ringing) response containing the g.3gpp.srvcc-alerting feature capability indicator (as described in annex C).

[TS 24.237, clause 12.2.4.2]

If the SC UE is engaged in a session in early dialog state and:

- receives a SM NOTIFICATION message containing an "SRVCC handover cancelled, IMS session re-establishment required" as described in 3GPP TS 24.008 [8] or 3GPP TS 24.301 [52] depending on the access in use; or

...

then if the SC UE the SC UE shall send a SIP UPDATE request containing:

- 1) an SDP offer, including the media characteristics as used in the existing dialog; and
- 2) a Reason header field containing protocol "SIP" and reason parameter "cause" with value "487" as specified in IETF RFC 3326 [57], and with reason-text set to either "handover cancelled" or "failure to transition to CS domain";

by following the rules of 3GPP TS 24.229 [2] in each transferred session.

13.4.3.15.3 Test description

13.4.3.15.3.1 Pre-test conditions

System Simulator:

- Cell 1 and Cell 5.
- System information combination 4 as defined in TS 36.508 [18] clause 4.4.3.1 is used in E-UTRA cells.

UE:

None.

.

Preamble:

- The UE is in state Registered, Idle mode (state 2) on Cell 1 according to [18].

13.4.3.15.3.2 Test procedure sequence

Table 13.4.3.15.3.2-1 illustrates the downlink power levels and other changing parameters to be applied for the cells at various time instants of the test execution. Row marked "T0" denotes the initial conditions after preamble, while columns marked "T1" is to be applied subsequently. The exact instants on which these values shall be applied are described in the texts in this clause.

Table 13.4.3.15.3.2-1: Time instances of cell power level and parameter changes

	Parameter	Unit	Cell 1	Cell 5	Remark
T0	Cell-specific RS EPRE	dBm/15k Hz	-60	-	The power level values are such that entering conditions for event B2 are not satisfied.
	CPICH_Ec (UTRA FDD)	dBm/3.8 4 MHz	-	-88	
	PCCPCH_Ec (UTRA LCR TDD)	dBm/1.2 8 MHz	-	-88	
T1	Cell-specific RS EPRE	dBm/15k Hz	-84	-	The power level values are such that entering conditions for event B2 are satisfied.
	CPICH_Ec (UTRA FDD)	dBm/3.8 4 MHz	-	-64	
	PCCPCH_Ec (UTRA LCR TDD)	dBm/1.2 8 MHz	-	-64	

Table 13.4.3.15.3.2-2: Main behaviour

St	Procedure	Message Sequence		TP	Verdict
		U - S	Message		
1	The SS configures UTRA cell 5 to reference configuration according 36.508 [18] table 4.8.3-1, condition UTRA PS RB + Speech.	-	-	-	-
-	The following messages are to be observed on Cell 1 unless explicitly stated otherwise.	-	-	-	-
2-13	Steps 1 to 12 of the generic test procedure for IMS MO speech call and aSRVCC (TS 36.508 [18] 4.5A.6.3-1).	-	-	-	-
-	EXCEPTION: In parallel to the events described in steps 14 to 15 the steps specified in Table 13.4.3.15.3.2-3 should take place.	-	-	-	-
14	The SS transmits an <i>RRConnectionReconfiguration</i> message to setup inter RAT measurement and reporting for event B2.	<--	<i>RRConnectionReconfiguration</i>	-	-
15	The UE transmits an <i>RRConnectionReconfigurationComplete</i> message.	-->	<i>RRConnectionReconfigurationComplete</i>	-	-
16	The SS changes the power level for Cell 1 and Cell 5 according to the row "T1" in table 13.4.3.15.3.2-1	-	-	-	-
17	The UE transmits a <i>MeasurementReport</i> message to report event B2 for Cell 5.	-->	<i>MeasurementReport</i>	-	-
18	The SS transmits a NOTIFICATION message.	<--	NOTIFICATION	-	-
19	Check: Does the UE start the procedure for SIP UPDATE after aSRVCC handover is cancelled? Note: Step 1 of the Generic test procedure for SIP UPDATE after aSRVCC handover failure/cancelled defined in annex C.28 of TS 34.229-1 [35] is performed (UE sends UPDATE).	-	-	1	P
20	SS Sends 200 OK message. Note: Step 2 of the Generic test procedure for SIP UPDATE after aSRVCC handover failure/cancelled defined in annex C.28 of TS 34.229-1 [35].	-	-	-	-
21	SS sends 200 OK message. Note: Step 12 of the expected sequence defined in annex C.21 of TS 34.229-1 [35].	-	-	-	-
22	Check: Does the UE send ACK message? Note: Steps 13 of the expected sequence defined in annex C.21 of TS 34.229-1 [35].	-	-	1	P

Table 13.4.3.15.3.2-3: Parallel behaviour

St	Procedure	Message Sequence		TP	Verdict
		U - S	Message		
1-7	Steps 5-11 expected sequence defined in annex C.21 of TS 34.229-1 [35]. NOTE: IMS MO speech call establishment gets to alerting phase.	-	-	-	-

13.4.3.15.3.3 Specific message contents

Table 13.4.3.15.3.3-1: ATTACH REQUEST (preamble)

Derivation path: 36.508 [18], table 4.7.2-4			
Information Element	Value/remark	Comment	Condition
MS network capability	SRVCC from UTRAN HSPA or E-UTRAN to GERAN/UTRAN supported		
Mobile station classmark 2	Any allowed value		
Supported Codecs	Any allowed value		

Table 13.4.3.15.3.3-2: RRCConnectionReconfiguration (step 14, Table 13.4.3.15.3.2-2)

Derivation Path: 36.508 [18], table 4.6.1-8 with condition MEAS

Table 13.4.3.15.3.3-3: MeasConfig (Table 13.4.3.15.3.3-2)

Derivation Path: 36.508 [18], table 4.6.6-1, condition UTRAN			
Information Element	Value/remark	Comment	Condition
MeasConfig ::= SEQUENCE {			
measObjectToAddModList SEQUENCE (SIZE (1..maxObjectld)) OF SEQUENCE {	2 entries		
measObjectld[1]	IdMeasObject-f1		
measObject[1]	MeasObjectEUTRA-GENERIC(f1)		
measObjectld[2]	IdMeasObject-f8		
measObject[2]	MeasObjectUTRA-f8		
}			
reportConfigToAddModList SEQUENCE (SIZE (1..maxReportConfigld)) OF SEQUENCE {	1 entry		
reportConfigld[1]	IdReportConfig-B2-UTRA		
reportConfig[1]	ReportConfigInterRAT-B2-UTRA (-72, -76)		
}			
measIdToAddModList SEQUENCE (SIZE (1..maxMeasld)) OF SEQUENCE {	1 entry		
measld[1]	1		
measObjectld[1]	IdMeasObject-f8		
reportConfigld[1]	IdReportConfig-B2-UTRA		
}			
}			

Table 13.4.3.15.3.3-4: MeasObjectUTRA-f8 (Table 13.4.3.15.3.3-3)

Derivation Path: 36.508 [18], table 4.6.6-3			
Information Element	Value/remark	Comment	Condition
MeasObjectUTRA ::= SEQUENCE {			
carrierFreq	Same downlink ARFCN as used for Cell 5		
cellsToAddModList CHOICE {			
cellsToAddModListUTRA-FDD SEQUENCE (SIZE (1..maxCellMeas)) OF SEQUENCE {	1 entry		UTRA-FDD
cellIndex[1]	1		
physCellId[1]	PhysicalCellIdentity of Cell 5		
}			
cellsToAddModListUTRA-TDD SEQUENCE (SIZE (1..maxCellMeas)) OF SEQUENCE {			UTRA-TDD
cellIndex[1]	1		
physCellId[1]	PhysicalCellIdentity of Cell 5		
}			
}			
csg-allowedReportingCells-v930	Not present		
}			

Condition	Explanation
UTRA-FDD	UTRA FDD cell environment
UTRA-TDD	UTRA TDD cell environment

Table 13.4.3.15.3.3-5: MeasurementReport (step 17, Table 13.4.3.15.3.2-2)

Derivation Path: 36.508 [18], table 4.6.1-5			
Information Element	Value/remark	Comment	Condition
MeasurementReport ::= SEQUENCE {			
criticalExtensions CHOICE {			
c1 CHOICE {			
measurementReport-r8 SEQUENCE {			
measResults SEQUENCE {			
measId	1		
measResultPCell SEQUENCE {			
rsrpResult	(0..97)		
rsrqResult	(0..34)		
}			
measResultNeighCells CHOICE {			
measResultListUTRA SEQUENCE (SIZE (1..maxCellReport)) OF SEQUENCE {	1 entry		
physCellId[1] CHOICE {			
fdd	PhysicalCellIdentity of Cell 5		UTRA-FDD
tdd	PhysicalCellIdentity of Cell 5		UTRA-TDD
}			
}			
cgi-Info[1]	Not present		
measResult[1] SEQUENCE {			
utra-RSCP	(-5..91)		
utra-EcN0	Not present		
additionalSI-Info-r9	Not present		
}			
}			
measResultForECID-r9	Not present		
locationInfo-r10	Not present		
measResultServFreqList-r10	Not present		
}			
}			
}			
}			

Condition	Explanation
UTRA-FDD	UTRA FDD cell environment
UTRA-TDD	UTRA TDD cell environment

Table 13.4.3.15.3.3-6: NOTIFICATION (step18, Table 13.4.3.15.3.2-2)

Derivation Path: 36.508 [18], table 4.7.3-18A, condition SRVCC-HO-CANCELLED

13.4.3.16 Inter-system mobility / E-UTRA PS voice + PS data to UTRA CS voice + PS data / aSRVCC / MT call

13.4.3.16.1 Test Purpose (TP)

(1)

```

with { UE in E-UTRA RRC_CONNECTED state }
ensure that {
  when { UE receives a MobilityFromEUTRACommand message and an MT IMS voice call is in alerting
state and an UTRA PS RB + Speech combination is configured for an UTRA cell}
  then { UE transmits a HANDOVER TO UTRAN COMPLETE message on the utra cell}
}
    
```

(2)

```

with { UE having transmitted a HANDOVER TO UTRAN COMPLETE message }
ensure that {
  when { the voice call is accepted }
  then { UE transmits a CONNECT message on the utra cell }
}

```

13.4.3.16.2 Conformance requirements

References: The conformance requirements covered in the present TC are specified in: TS 36.331, clause 5.4.3.3, TS 24.237 clause 12.2.3B.1 and clause 12.2.3B.3.1.

[TS 36.331, clause 5.4.3.3]

The UE shall be able to receive a *MobilityFromEUTRACommand* message and perform a cell change order to GERAN, even if no prior UE measurements have been performed on the target cell.

The UE shall:

- 1> stop timer T310, if running;
- 1> if the *MobilityFromEUTRACommand* message includes the *purpose* set to 'handover':
 - 2> if the *targetRAT-Type* is set to 'utra' or 'geran':
 - 3> consider inter-RAT mobility as initiated towards the RAT indicated by the *targetRAT-Type* included in the *MobilityFromEUTRACommand* message;
 - 3> forward the *nas-SecurityParamFromEUTRA* to the upper layers;
- 3> access the target cell indicated in the inter-RAT message in accordance with the specifications of the target RAT;

[TS 24.237 clause 12.2.3B.1]

The SC UE shall apply the procedures in subclauses 12.2.3B.3 for access transfer for calls in alerting state if:

- 1) the SC UE supports single radio PS to CS access transfer for calls in alerting state; and
- 2) there are one or more early dialogs created by the same SIP INVITE request with at least one dialog that is an early dialog supporting a session with active speech media component where the SC UE:
 - has sent a Contact header field in a SIP INVITE request or 180 (Ringing) response containing the g.3gpp.srvcc-alerting media feature tag (as described in annex C); and
 - has received a Feature-Caps header field in a SIP INVITE request or 180 (Ringing) response containing the g.3gpp.srvcc-alerting feature capability indicator (as described in annex C).

[TS 24.237 clause 12.2.3B.3.1]

If the SC UE:

- has received a terminating call which is in the early dialog state according to the conditions in subclauses 12.1 and 12.2.3B.1; and
- successfully performs access transfer to the CS domain;

then the UE continues in Ringing state in CS, i.e. UE moves to Call Received (U7) state as described in 3GPP TS 24.008.

13.4.3.16.3 Test description

13.4.3.16.3.1 Pre-test conditions

System Simulator:

- Cell 1 and Cell 5.

- System information combination 4 as defined in TS 36.508 [18] clause 4.4.3.1 is used in E-UTRA cells.

UE:

None.

Preamble:

- The UE is in state Registered, Idle mode (state 2) on Cell 1 according to [18].

13.4.3.16.3.2 Test procedure sequence

Table 13.4.3.16.3.2-1 illustrates the downlink power levels and other changing parameters to be applied for the cells at various time instants of the test execution. Row marked "T0" denotes the initial conditions after preamble, while columns marked "T1" is to be applied subsequently. The exact instants on which these values shall be applied are described in the texts in this clause.

Table 13.4.3.16.3.2-1: Time instances of cell power level and parameter changes

	Parameter	Unit	Cell 1	Cell 5	Remark
T0	Cell-specific RS EPRE	dBm/15k Hz	-60	-	The power level values are such that entering conditions for event B2 are not satisfied.
	CPICH_Ec (UTRA FDD)	dBm/3.8 4 MHz	-	-88	
	PCCPCH_Ec (UTRA LCR TDD)	dBm/1.2 8 MHz	-	-88	
T1	Cell-specific RS EPRE	dBm/15k Hz	-84	-	The power level values are such that entering conditions for event B2 are satisfied.
	CPICH_Ec (UTRA FDD)	dBm/3.8 4 MHz	-	-64	
	PCCPCH_Ec (UTRA LCR TDD)	dBm/1.2 8 MHz	-	-64	

Table 13.4.3.16.3.2-2: Main behaviour

St	Procedure	Message Sequence		TP	Verdict
		U - S	Message		
1	The SS configures UTRA cell 5 to reference configuration according 36.508 table 4.8.3-1, condition UTRA PS RB + Speech .	-	-	-	-
2-23	Steps 1 to 22 of the generic test procedure for IMS MT speech call (TS 36.508 4.5A.7.3-1).	-	-	-	-
24	The SS transmits an <i>RRCCONNECTIONRECONFIGURATION</i> message on Cell 1 to setup inter RAT measurement and reporting for event B2.	<--	<i>RRCCONNECTIONRECONFIGURATION</i>	-	-
25	The UE transmits an <i>RRCCONNECTIONRECONFIGURATIONCOMPLETE</i> message on Cell 1.	-->	<i>RRCCONNECTIONRECONFIGURATIONCOMPLETE</i>	-	-
26	The SS changes the power level for Cell 1 and Cell 5 according to the row "T1" in table 13.4.3.16.3.2-1	-	-	-	-
27	The UE transmits a <i>MEASUREMENTREPORT</i> message on Cell 1 to report event B2 for Cell 5.	-->	<i>MEASUREMENTREPORT</i>	-	-
28	The SS transmits a <i>UECAPABILITYENQUIRY</i> message to request UE radio access capability information for E-UTRA and UTRA.	<--	<i>UECAPABILITYENQUIRY</i>	-	-
29	The UE transmit a <i>UECAPABILITYINFORMATION</i> message on Cell 1. NOTE: The start-PS and start-CS values received, should be used to configure ciphering on cell 5.	-->	<i>UECAPABILITYINFORMATION</i>	-	-
30	The SS transmits a <i>MOBILITYFROMEUTRACOMMAND</i> message on Cell 1.	<--	<i>MOBILITYFROMEUTRACOMMAND</i>	-	-
31	Check: Does the UE transmit a HANOVER TO UTRAN COMPLETE message on cell 5?	-->	HANOVER TO UTRAN COMPLETE	1	P
-	EXCEPTION: In parallel to the events described in step 32 to 39 the step specified in table 13.4.3.16.3.2-3 takes place.	-	-	-	-
32	The SS transmits a SECURITY MODE COMMAND message for the CS domain.	<--	SECURITY MODE COMMAND	-	-
33	The UE transmits a SECURITY MODE COMPLETE message.	-->	SECURITY MODE COMPLETE	-	-
34	The SS transmits an UTRAN MOBILITY INFORMATION message to notify CN information.	<--	UTRAN MOBILITY INFORMATION	-	-
35	The UE transmits an UTRAN MOBILITY INFORMATION CONFIRM message.	-->	UTRAN MOBILITY INFORMATION CONFIRM	-	-
36	The SS transmits a TMSI REALLOCATION COMMAND message.	<--	TMSI REALLOCATION COMMAND	-	-
37	The UE transmits a TMSI REALLOCATION COMPLETE message.	-->	TMSI REALLOCATION COMPLETE	-	-
38	Step 23A of the generic test procedure for IMS MT speech call (TS 36.508 4.5A.7.3-1). Accept the call.	-->	CONNECT	2	P
39		<--	CONNECT ACKNOWLEDGE	-	-
40	The SS transmits a SECURITY MODE COMMAND message for the PS domain.	<--	SECURITY MODE COMMAND	-	-
41	The UE transmits a SECURITY MODE COMPLETE message.	-->	SECURITY MODE COMPLETE	-	-
42	The SS transmits a ROUTING AREA UPDATE ACCEPT message.	<--	ROUTING AREA UPDATE ACCEPT	-	-
43	The UE transmits a ROUTING AREA UPDATE COMPLETE message.	-->	ROUTING AREA UPDATE COMPLETE	-	-
44-47	Void				

Table 13.4.3.16.3.2-3: Parallel behaviour

St	Procedure	Message Sequence		TP	Verdict
		U - S	Message		
1	Check: Does the UE transmit a ROUTING AREA UPDATE REQUEST message?	-->	ROUTING AREA UPDATE REQUEST	-	-

13.4.3.16.3.3 Specific message contents

Table 13.4.3.16.3.3-1: ATTACH REQUEST (preamble)

Derivation path: 36.508 table 4.7.2-4			
Information Element	Value/remark	Comment	Condition
MS network capability	SRVCC from UTRAN HSPA or E-UTRAN to GERAN/UTRAN supported		
Mobile station classmark 2	Any allowed value		
Supported Codecs	Any allowed value		

Table 13.4.3.16.3.3-2: RRCConnectionReconfiguration (step 24, Table 13.4.3.16.3.2-2)

Derivation Path: 36.508 clause 4.6.1 table 4.6.1-8 with condition MEAS
--

Table 13.4.3.16.3.3-3: MeasConfig (step 24, Table 13.4.3.16.3.2-2)

Derivation path: 36.508 clause 4.6.6 table 4.6.6-1 with condition UTRAN			
Information Element	Value/Remark	Comment	Condition
measurementConfiguration ::= SEQUENCE {			
measObjectToAddModifyList SEQUENCE (SIZE (1..maxObjectId)) OF SEQUENCE {	2 entries		
measObjectId[1]	IdMeasObject-f8		
measObject[1]	MeasObjectUTRA-GENERIC(f8)		
measObjectId[2]	IdMeasObject-f1		
measObject[2]	MeasObjectEUTRA-GENERIC(f1)		
}			
reportConfigToAddModifyList SEQUENCE (SIZE (1..maxReportConfigId)) OF SEQUENCE {	1 entry		
reportConfigId[1]	IdReportConfigInterRAT-B2-UTRA		
reportConfig[1]	ReportConfigInterRAT-B2-UTRA (-72, -76)		
}			
measIdToAddModifyList SEQUENCE (SIZE (1..maxMeasId)) OF SEQUENCE {	1 entry		
measId[1]	1		
measObjectId[1]	IdMeasObject-f8		
reportConfigId[1]	IdReportConfigInterRAT-B2-UTRA		
}			
}			

Table 13.4.3.16.3.3-4: MeasurementReport (step 27, Table 13.4.3.16.3.2-2)

Derivation Path: 36.508, table 4.6.1-5			
Information Element	Value/remark	Comment	Condition
MeasurementReport ::= SEQUENCE {			
criticalExtensions CHOICE {			
c1 CHOICE{			
measurementReport-r8 SEQUENCE {			
measResults SEQUENCE {			
measId	1		
measResultServCell SEQUENCE {			
rsrpResult	(0..97)		
rsrqResult	(0..34)		
}			
measResultNeighCells CHOICE {			
measResultListUTRA SEQUENCE (SIZE (1..maxCellReport)) OF SEQUENCE {	1 entry		
physCellId[1]	PhysicalCellIdentity of Cell 5		
cgi-Info[1]	Not present		
measResult[1] SEQUENCE {			
utra-RSCP	(-5..91)		
}			
}			
}			
}			
}			
}			
}			
}			
}			

Table 13.4.3.16.3.3-5: MobilityFromEUTRACommand (step 28, Table 13.4.3.16.3.2-2)

Derivation Path: 36.508, Table 4.6.1-6			
Information Element	Value/remark	Comment	Condition
MobilityFromEUTRACommand ::= SEQUENCE {			
criticalExtensions CHOICE {			
c1 CHOICE{			
mobilityFromEUTRACommand-r8 SEQUENCE {			
cs-FallbackIndicator	True		
purpose CHOICE{			
handover SEQUENCE {			
targetRAT-Type	Utra		
targetRAT-MessageContainer	HANDOVER TO UTRAN COMMAND(UTRA RRC message)		
nas-SecurityParamFromEUTRA	The 4 least significant bits of the NAS downlink COUNT value		
systemInformation	Not present		
}			
}			
}			
}			
}			
}			

Table 13.4.3.16.3.3-6: HANDOVER TO UTRAN COMMAND (step 28, Table 13.4.3.16.3.3-5)

Derivation Path: 36.508, Table 4.7B.1-1, condition UTRA PS RB + Speech
--

Table 13.4.3.16.3.3-7: UECapabilityEnquiry (step 29, Table 13.4.3.16.3.2-2)

Derivation path: 36.508 clause 4.6.1 table 4.6.1-22			
Information Element	Value/Remark	Comment	Condition
UECapabilityEnquiry ::= SEQUENCE {			
criticalExtensions CHOICE {			
c1 CHOICE {			
ueCapabilityEnquiry-r8 SEQUENCE {			
ue-CapabilityRequest SEQUENCE (SIZE	2 entry		
(1..maxRAT-Capabilities)) OF SEQUENCE {			
RAT-Type[1]	eutra		
RAT-Type[2]	utra		
}			
}			
}			
}			
}			

Table 13.4.3.16.3.3-8: SECURITY MODE COMMAND (step 34, Table 13.4.3.16.3.2-2)

Derivation Path: 36.508, Table 4.7B.1-n		
Information Element	Condition	Value/remark
Ciphering mode info		Not Present

13.4.3.17 Inter-system mobility / E-UTRA PS voice + PS data to UTRA CS voice + PS data / aSRVCC / MT call / SRVCC HO cancelled

13.4.3.17.1 Test Purpose (TP)

(1)

with { UE in E-UTRA RRC_CONNECTED state and an MT IMS PS voice + PS data call is in alerting state with a SRVCC procedure started over an UTRA cell for which UTRA PS RB + Speech combination is configured }
ensure that {
 when { the source E-UTRAN decides to terminate the handover procedure before its completion indicating this to the UE with a NOTIFICATION message }
 then { UE starts a recovery procedure, transmits a SIP UPDATE message and successfully completes the MT call on the E-UTRA }
}

13.4.3.17.2 Conformance requirements

References: The conformance requirements covered in the present TC are specified in: TS 23.216, clause 6.2.2.2 and clause 8.1.3, TS 24.301, clause 6.6.2.2, TS 24.237 clauses 12.1, 12.2.3B.1, clause 12.2.4.2.

[TS 23.216, clause 6.2.2.2]

Depicted in figure 6.2.2.2-1 is a call flow for SRVCC from E-UTRAN to UTRAN or GERAN with DTM HO support, including the handling of the non-voice component. The flow requires that eNB can determine that either the target is UTRAN with PS HO or the target is GERAN with DTM support and the UE is supporting DTM.

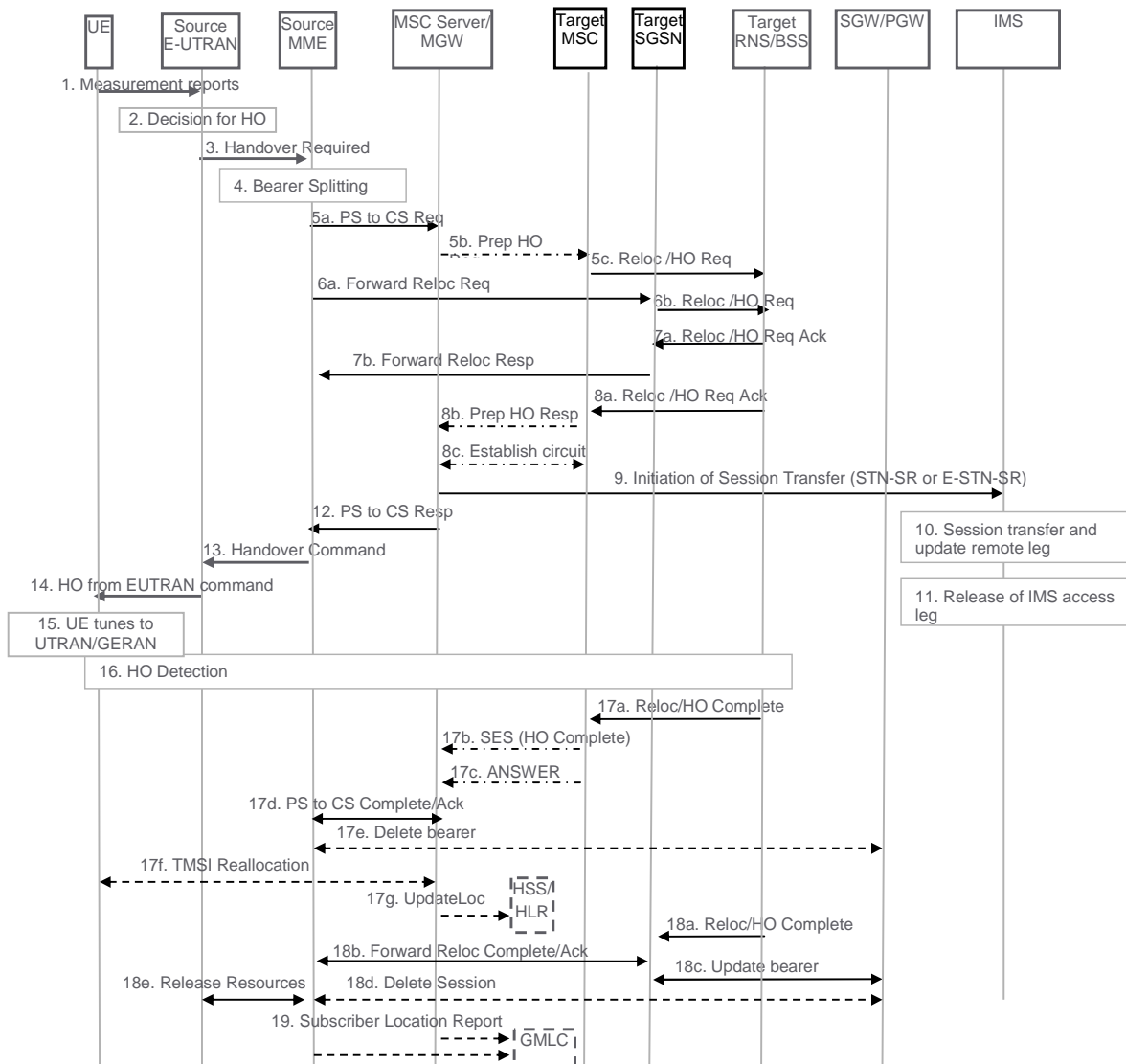

Figure 6.2.2.2-1: SRVCC from E-UTRAN to UTRAN with PS HO or GERAN with DTM HO support

1. UE sends measurement reports to E-UTRAN.
2. Based on UE measurement reports the source E-UTRAN decides to trigger an SRVCC handover to UTRAN/GERAN.

[TS 23.216, clause 8.1.3]

If the source E-UTRAN/UTRAN decides to terminate the handover procedure before its completion, the MME/SGSN shall return to its state before the handover procedure was triggered. The MME/SGSN attempts to trigger, at the MSC Server enhanced for SRVCC, handover cancellation procedures according to TS 23.009 [18]. The MSC Server enhanced for SRVCC shall take no SRVCC-specific action towards IMS.

The MME/SGSN shall also send a session reestablishment trigger notification to UE to start the recovery procedure if it receives notification from the MSC Server that the Session Transfer procedure is in progress. Figure 8.1.3-1 shows the overall procedure for SRVCC handover cancellation.

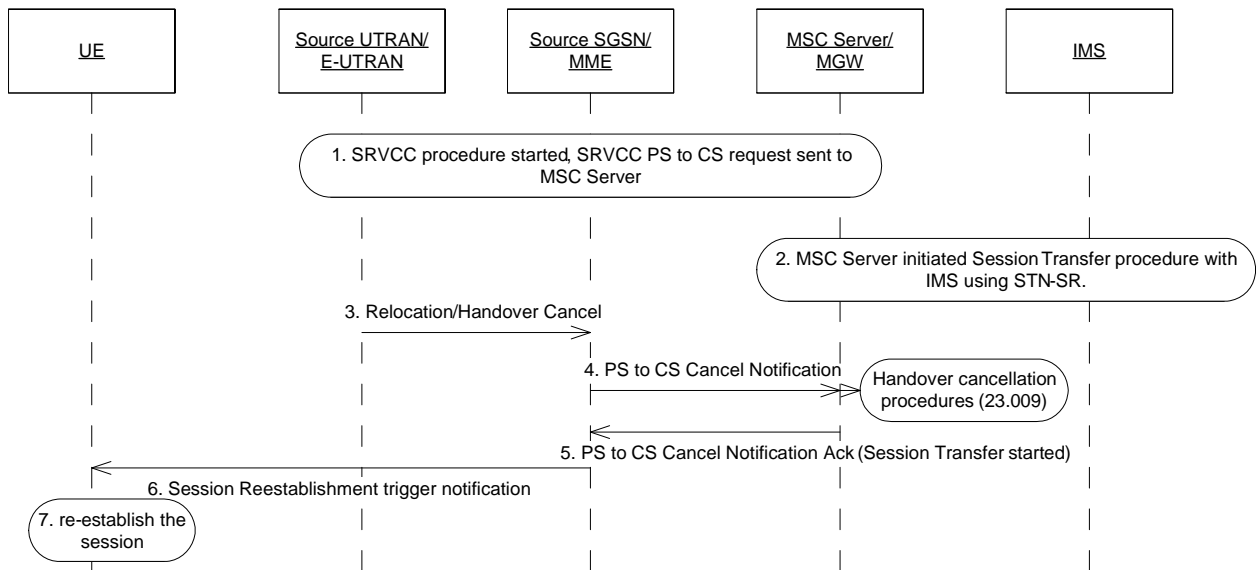

Figure 8.1.3-1: SRVCC Handover Cancellation Procedure

- 6. Due to the Session Transfer procedure in progress indication, the source SGSN/MME sends a Session Reestablishment trigger notification to UE to start the session re-establishment procedure
- 7. UE starts the re-establishment procedure, by attempting to return to E-UTRAN/UTRAN by sending a re-INVITE towards IMS for the related session. If the session is no longer active, then this session transfer request shall be rejected by the IMS.

[TS 24.301, clause 6.6.2.2]

The network initiates the notification procedure by sending a NOTIFICATION message to the UE (see example in figure 6.6.2.2.1).



Figure 6.6.2.2.1: Notification procedure

[TS 24.237, clause 12.1]

In order to fulfil the requirements for PS-CS access transfer in SR-VCC for calls in alerting state, the SC UE needs to be engaged in a session with speech media component in early dialog state according to the following conditions before SR-VCC access transfer is performed:

- a SIP 180 (Ringing) response for the initial SIP INVITE request to establish this session has been sent or received; and
- a SIP final response for the initial SIP INVITE request to establish this session has not been sent or received.

[TS 24.237, clause 12.2.3B.1]

The SC UE shall apply the procedures in subclauses 12.2.3B.3 for access transfer for calls in alerting state if:

- 1) the SC UE supports single radio PS to CS access transfer for calls in alerting state; and

- 2) there are one or more early dialogs created by the same SIP INVITE request with at least one dialog that is an early dialog supporting a session with active speech media component where the SC UE:
- has sent a Contact header field in a SIP INVITE request or 180 (Ringing) response containing the g.3gpp.srvcc-alerting media feature tag (as described in annex C); and
 - has received a Feature-Caps header field in a SIP INVITE request or 180 (Ringing) response containing the g.3gpp.srvcc-alerting feature capability indicator (as described in annex C).

[TS 24.237, clause 12.2.4.2]

If the SC UE is engaged in a session in early dialog state and:

- receives a SM NOTIFICATION message containing an "SRVCC handover cancelled, IMS session re-establishment required" as described in 3GPP TS 24.008 [8] or 3GPP TS 24.301 [52] depending on the access in use; or

...

then if the SC UE the SC UE shall send a SIP UPDATE request containing:

- 1) an SDP offer, including the media characteristics as used in the existing dialog; and
- 2) a Reason header field containing protocol "SIP" and reason parameter "cause" with value "487" as specified in IETF RFC 3326 [57], and with reason-text set to either "handover cancelled" or "failure to transition to CS domain";

by following the rules of 3GPP TS 24.229 [2] in each transferred session.

13.4.3.17.3 Test description

13.4.3.17.3.1 Pre-test conditions

System Simulator:

- Cell 1 and Cell 5.
- System information combination 4 as defined in TS 36.508 [18] clause 4.4.3.1 is used in E-UTRA cells.

UE:

None.

Preamble:

- The UE is in state Registered, Idle mode (state 2) on Cell 1 according to [18].

13.4.3.17.3.2 Test procedure sequence

Table 13.4.3.17.3.2-1 illustrates the downlink power levels and other changing parameters to be applied for the cells at various time instants of the test execution. Row marked "T0" denotes the initial conditions after preamble, while columns marked "T1" is to be applied subsequently. The exact instants on which these values shall be applied are described in the texts in this clause.

Table 13.4.3.17.3.2-1: Time instances of cell power level and parameter changes

	Parameter	Unit	Cell 1	Cell 5	Remark
T0	Cell-specific RS EPRE	dBm/15k Hz	-60	-	The power level values are such that entering conditions for event B2 are not satisfied.
	CPICH_Ec (UTRA FDD)	dBm/3.8 4 MHz	-	-88	
	PCCPCH_Ec (UTRA LCR TDD)	dBm/1.2 8 MHz	-	-88	
T1	Cell-specific RS EPRE	dBm/15k Hz	-84	-	The power level values are such that entering conditions for event B2 are satisfied.
	CPICH_Ec (UTRA FDD)	dBm/3.8 4 MHz	-	-64	
	PCCPCH_Ec (UTRA LCR TDD)	dBm/1.2 8 MHz	-	-64	

Table 13.4.3.17.3.2-2: Main behaviour

St	Procedure	Message Sequence		TP	Verdict
		U - S	Message		
1	The SS configures UTRA cell 5 to reference configuration according 36.508 [18] table 4.8.3-1, condition UTRA PS RB + Speech .	-	-	-	-
-	The following messages are sent and shall be observed on Cell 1 unless explicitly stated otherwise.	-	-	-	-
2-16	Steps 1 to 15 of the generic test procedure for IMS MT speech call (TS 36.508 [18] 4.5A.7.3-1).	-	-	-	-
-	EXCEPTION: In parallel to the events described in steps 17 to 18 the steps specified in Table 13.4.3.17.3.2-3 should take place.	-	-	-	-
17	The SS transmits an <i>RRCCConnectionReconfiguration</i> message on Cell 1 to setup inter RAT measurement and reporting for event B2.	<--	<i>RRCCConnectionReconfiguration</i>	-	-
18	The UE transmits an <i>RRCCConnectionReconfigurationComplete</i> message on Cell 1.	-->	<i>RRCCConnectionReconfigurationComplete</i>	-	-
19	The SS changes the power level for Cell 1 and Cell 5 according to the row "T1" in table 13.4.3.17.3.2-1	-	-	-	-
20	The UE transmits a <i>MeasurementReport</i> message to report event B2 for Cell 5.	-->	<i>MeasurementReport</i>	-	-
21	The SS transmits a NOTIFICATION message.	<--	NOTIFICATION	-	-
22	Check: Does the UE start the procedure for SIP UPDATE after aSRVCC handover is cancelled? Note: Step 1 of the Generic test procedure for SIP UPDATE after aSRVCC handover failure/cancelled defined in annex C.28 of TS 34.229-1 [35] is performed (UE sends UPDATE).	-	-	1	P
23	SS sends 200 OK message Note: Step 2 of the Generic test procedure for SIP UPDATE after aSRVCC handover failure/cancelled defined in annex C.28 of TS 34.229-1 [35].	-	-	-	-
24	Make UE accept the speech AMR offer Step 12A of the expected sequence defined in annex C.11 of TS 34.229-1 [35].				
25	Check: Does the UE send 200 OK message? Note: Steps 12 of the expected sequence defined in annex C.11 of TS 34.229-1 [35].	-	-	1	P
26	SS Sends ACK message. Note: Step 13 of the expected sequence defined in annex C.11 of TS 34.229-1 [35].	-	-	-	-

Table 13.4.3.17.3.2-3: Parallel behaviour

St	Procedure	Message Sequence		TP	Verdict
		U - S	Message		
1-7	Steps 5-11 expected sequence defined in annex C.11 of TS 34.229-1 [35]. MTSI MT speech. NOTE: IMS MT speech call establishment gets to alerting phase.	-	-	-	-

13.4.3.17.3.3 Specific message contents

Table 13.4.3.17.3.3-1: ATTACH REQUEST (preamble)

Derivation path: 36.508 [18], Table 4.7.2-4			
Information Element	Value/remark	Comment	Condition
MS network capability	SRVCC from UTRAN HSPA or E-UTRAN to GERAN/UTRAN supported		
Mobile station classmark 2	Any allowed value		
Supported Codecs	Any allowed value		
Old GUTI type	Any allowed value		

Table 13.4.3.17.3.3-2: RRCConnectionReconfiguration (step 17, Table 13.4.3.17.3.2-2)

Derivation Path: 36.508 [18], Table 4.6.1-8, condition MEAS

Table 13.4.3.17.3.3-3: MeasConfig (Table 13.4.3.17.3.3-2)

Derivation Path: 36.508 [18], Table 4.6.6-1, condition UTRAN			
Information Element	Value/remark	Comment	Condition
MeasConfig ::= SEQUENCE {			
measObjectToAddModList SEQUENCE (SIZE (1..maxObjectld)) OF SEQUENCE {	2 entries		
measObjectld[1]	IdMeasObject-f1		
measObject[1]	MeasObjectEUTRA-GENERIC(f1)		
measObjectld[2]	IdMeasObject-f8		
measObject[2]	MeasObjectUTRA-f8		
}			
reportConfigToAddModList SEQUENCE (SIZE (1..maxReportConfigld)) OF SEQUENCE {	1 entry		
reportConfigld[1]	IdReportConfig-B2-UTRA		
reportConfig[1]	ReportConfigInterRAT-B2-UTRA (-72, -76)		
}			
measldToAddModList SEQUENCE (SIZE (1..maxMeasld)) OF SEQUENCE {	1 entry		
measld[1]	1		
measObjectld[1]	IdMeasObject-f8		
reportConfigld[1]	IdReportConfig-B2-UTRA		
}			
}			

Table 13.4.3.17.3.3-4: MeasObjectUTRA-f8 (Table 13.4.3.17.3.3-3)

Derivation Path: 36.508 [18], Table 4.6.6-3			
Information Element	Value/remark	Comment	Condition
MeasObjectUTRA ::= SEQUENCE {			
carrierFreq	Same downlink ARFCN as used for Cell 5		
cellsToAddModList CHOICE {			
cellsToAddModListUTRA-FDD SEQUENCE (SIZE (1..maxCellMeas)) OF SEQUENCE {	1 entry		UTRA-FDD
cellIndex[1]	1		
physCellId[1]	PhysicalCellIdentity of Cell 5		
}			
cellsToAddModListUTRA-TDD SEQUENCE (SIZE (1..maxCellMeas)) OF SEQUENCE {			UTRA-TDD
cellIndex[1]	1		
physCellId[1]	PhysicalCellIdentity of Cell 5		
}			
}			
csg-allowedReportingCells-v930	Not present		
}			

Condition	Explanation
UTRA-FDD	UTRA FDD cell environment
UTRA-TDD	UTRA TDD cell environment

Table 13.4.3.17.3.3-5: *MeasurementReport* (step 20, Table 13.4.3.17.3.2-2)

Derivation Path: 36.508 [18], Table 4.6.1-5			
Information Element	Value/remark	Comment	Condition
MeasurementReport ::= SEQUENCE {			
criticalExtensions CHOICE {			
c1 CHOICE {			
measurementReport-r8 SEQUENCE {			
measResults SEQUENCE {			
measId	1		
measResultPCell SEQUENCE {			
rsrpResult	(0..97)		
rsrqResult	(0..34)		
}			
measResultNeighCells CHOICE {			
measResultListUTRA SEQUENCE (SIZE (1..maxCellReport)) OF SEQUENCE {	1 entry		
physCellId[1] CHOICE {			
fdd	PhysicalCellIdentity of Cell 5		UTRA-FDD
tdd	PhysicalCellIdentity of Cell 5		UTRA-TDD
}			
}			
cgi-Info[1]	Not present		
measResult[1] SEQUENCE {			
utra-RSCP	(-5..91)		
utra-EcN0	Not present		
additionalSI-Info-r9	Not present		
}			
}			
measResultForECID-r9	Not present		
locationInfo-r10	Not present		
measResultServFreqList-r10	Not present		
}			
}			
}			
}			

Condition	Explanation
UTRA-FDD	UTRA FDD cell environment
UTRA-TDD	UTRA TDD cell environment

Table 13.4.3.17.3.3-6: NOTIFICATION (step 21, Table 13.4.3.17.3.2-2)

Derivation Path: 36.508 [18], table 4.7.3-18A, condition SRVCC-HO-CANCELLED

13.4.4 Inter-system session management

13.4.4.1 Pre-registration at 1xRTT and Cell reselection / 1x Zone Registration

13.4.4.1.1 Test Purpose (TP)

(1)

```

with { UE in E-UTRA RRC_IDLE state having completed the 1xRTT CS pre-registration procedure and
having detecting the cell ranked as the best cell}
  then {selecting the new cell }
ensure that {
  when { SIB 8 includes a 1x registration zone ID that is different from the source cell }
    then { UE transmits an ULInformationTransfer message containing a tunnelled 1xRTT GCSNA Encapsulated Registration message}
}

```

13.4.4.1.2 Conformance requirements

References: The conformance requirements covered in the present TC are specified in: TS 23.272, clause B.2.1.1 [TS 23.272, clause B.2.1.1]

This clause describes how the UE in an E-UTRAN system establishes and maintains pre-registration in the 1xCS system.

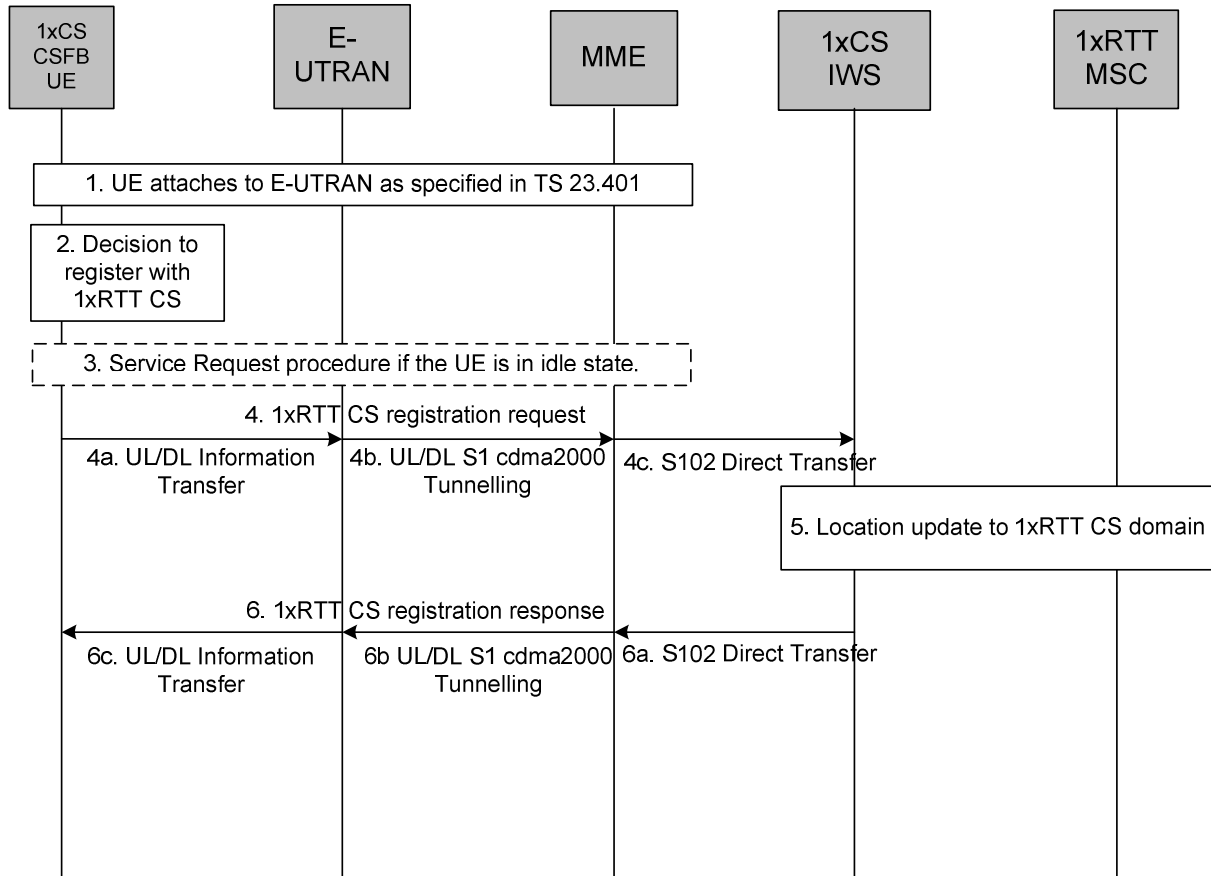

Figure B.2.1.1-1: 1xRTT CS registration procedure

1. The UE attaches to E-UTRAN as specified in TS 23.401 [2]. The UE includes an indication of enhanced CS fallback to 1xRTT and may also include concurrent 1xRTT and HRPD PS session handling capabilities as part of the UE radio capabilities.
2. Based on a radio layer trigger (e.g. an indication from the E-UTRAN when the UE is in connected state or an indication over the broadcast channel), the UE decides to register with the 1xRTT CS domain.
3. If the UE is in idle state, in order to create a signalling connection with the MME, it performs the Service Request procedure.
4. The UE generates a 1xRTT CS registration request.
- 4a. The 1xRTT CS message is transferred from the UE to E-UTRAN.
- 4b. E-UTRAN forwards the 1xRTT CS message to the MME including the CDMA2000 Reference Cell ID.
- 4c. The MME selects a 1xCS IWS node based on the CDMA2000 Reference Cell ID. The IMSI is used to distinguish S102 signalling transactions belonging to different UEs. The MME sends a S102 Direct Transfer message (IMSI, 1xCS message) to the 1xCS IWS node.

- 5. 1xRTT CS registration is then performed by the 1xCS IWS node based on 3GPP2 A.S0008-C v4.0 [16].
- 6a. 1xRTT CS registration response is tunnelled back to the MME in a S102 Direct Transfer message (IMSI, 1xCS message).
- 6b. The MME forwards the 1xRTT CS message to the E-UTRAN.
- 6c. The E-UTRAN forwards the 1xRTT CS message to the UE.

If the triggers for 1xCS registration change over time, the UE (both in idle or connected state), uses this information to update the 1xCS registration via the tunnel.

13.4.4.1.3 Test description
 13.4.4.1.3.1 Pre-test conditions

System Simulator:

- Cell 1 and Cell 2.
- System information combination 6 as defined in TS 36.508 [18] clause 4.4.3.1 is used in E-UTRA cells.
- Cell 1 and Cell2 have the different Registration Zone ID in SIB8.

UE:

None.

Preamble:

- The UE is in state Registered, Idle mode pre-registered on 1xRTT (state 2C) on Cell 1 according to [18].

13.4.4.1.3.2 Test procedure sequence

Table 13.4.4.1.3.2-1 illustrates the downlink power levels and other changing parameters to be applied for the cells at various time instants of the test execution.

Table 13.4.4.1.3.2-1: Time instances of cell power level and parameter changes

	Parameter	Unit	Cell 1	Cell 2	Remark
T1	Cell-specific RS EPRE	dBm/15kHz	-85	-79	The power level values are assigned to satisfy $R_{Cell\ 1} < R_{Cell\ 2}$.

Table 13.4.4.1.3.2-2: Main behaviour

St	Procedure	Message Sequence		TP	Verdict
		U - S	Message		
1	The SS changes Cell 2 level according to the row "T1" in table 13.4.4.1.3.2-1.	-	-	-	-
2	The UE is camped on E-UTRAN Cell 2.	-	-	-	-
3-9	Steps 3 to 9 of the generic radio bearer establishment procedure (TS 36.508 4.5.3.3-1) are executed to successfully complete the service request procedure.				
9A-9B	Steps 16A and 16B of generic procedure (TS 36.508 4.5.2C.3-2) are executed	-	-	-	-
10	Check: Does the UE transmit an <i>ULInformationTransfer</i> containing a tunnelled <i>1xRTT GCSNA encapsulated Registration</i> message on Cell 2.	-->	<i>ULInformationTransfer</i>	1	P
11-12	Steps 17A to 18 of the UE Registration, pre-registration on 1xRTT (TS 36.508 4.5.2C.3-2) on Cell 2.				

Table 13.4.4.1.3.2-3: Void

13.4.4.1.3.3 Specific message contents

Table 13.4.4.1.3.3-1: *SystemInformationBlockType8* for cell 2 (Step 2, Table 13.4.4.1.3.2-2)

Derivation Path: 36.508 Table 4.4.3.3-7, condition 1XRTT			
Information Element	Value/remark	Comment	Condition
SystemInformationBlockType8 ::= SEQUENCE {			
parameters1XRTT SEQUENCE {			
csfb-RegistrationParam1XRTT SEQUENCE {			
Sid	Same as cell 1	BIT STRING (SIZE (15))	
Nid	Same as cell 1	BIT STRING (SIZE (16))	
multipleSID	TRUE	BOOLEAN	
multipleNID	TRUE	BOOLEAN	
homeReg	TRUE	BOOLEAN	
foreignSIDReg	TRUE	BOOLEAN	
foreignNIDReg	TRUE	BOOLEAN	
parameterReg	TRUE	BOOLEAN	
powerUpReg	TRUE	BOOLEAN	
registrationPeriod	TRUE	BIT STRING (SIZE (7))	
registrationZone	A valid value different from cell 1	BIT STRING (SIZE (12))	
totalZone	'001'B	BIT STRING (SIZE (3))	
zoneTimer	'000'B or '001'B	BIT STRING (SIZE (3))	
}			
longCodeState1XRTT	A valid value, calculated and updated by the SS	BIT STRING (SIZE (42)) OPTIONAL	
cellReselectionParameters1XRTT SEQUENCE {			
bandClassList SEQUENCE (SIZE (1..maxCDMA -BandClass)) OF SEQUENCE {	1 entry		
bandClass	Band class of Cell 19	ENUMERATED {bc0, bc1, bc2, bc3, bc4, bc5, bc6, bc7, bc8, bc9, bc10, bc11, bc12, bc13, bc14, bc15, bc16, bc17, spare14, spare13, spare12, spare11, spare10, spare9, spare8, spare7, spare6, spare5, spare4, spare3, spare2, spare1, ...}	
cellReselectionPriority	3		
threshX-High	30(-30)	INTEGER (0..63)	
threshX-Low	32(-32)	INTEGER (0..63)	
}			
}			
csfb-RegistrationParam1XRTT-v920{			
powerDownReg-r9	TRUE		
}			
}			

Table 13.4.4.1.3.3-2: *mobilityParameters* (Step 2, Table 13.4.4.1.3.2-3)

Information Element	Value/remark	Comment	Condition
RecordType	'00000000'B		
SIDIncluded	'1'B		
SID	The same as SIB8 on cell 2		
NIDIncluded	'1'B		
NID	The same as SIB8 on cell 2		
REG_ZONEIncluded	'1'B		
REG_ZONE	The same as SIB8 on cell 2		
TOTAL_ZONESIncluded	'1'B		
TOTAL_ZONES	The same as SIB8 on cell 2		
ZONE_TIMERIncluded	'1'B		
ZONE_TIMER	The same as SIB8 on cell 2		
PACKET_ZONE_IDIncluded	'0'B		
PACKET_ZONE_ID	Not present		
PZIDHystParametersIncluded	'0'B		
PZ_HYST_ENABLED	Not present		
PZ_HYST_INFO_INCL	Not present		
PZ_HYST_LIST_LEN	Not present		
PZ_HYST_ACT_TIMER	Not present		
PZ_HYST_TIMER_MUL	Not present		
PZ_HYST_TIMER_EXP	Not present		
P_REVIncluded	'1'B		
P_REV	'00000110'B		
MIN_P_REVIncluded	'1'B		
MIN_P_REV	'00000110'B		
'0'B NEG_SLOT_CYCLE_INDEX_SUPIncluded			
NEG_SLOT_CYCLE_INDEX_SUP	Not present		
ENCRYPT_MODEIncluded	'0'B		
ENCRYPT_MODE	Not present		
ENC_SUPPORTEDIncluded	'0'B		
ENC_SUPPORTED	Not present		
SIG_ENCRYPT_SUPIncluded	'0'B		
SIG_ENCRYPT_SUP	Not present		
MSG_INTEGRITY_SUPIncluded	'0'B		
MSG_INTEGRITY_SUP	Not present		
SIG_INTEGRITY_SUP_INCLIncluded	'0'B		
SIG_INTEGRITY_SUP_INCL	Not present		
SIG_INTEGRITY_SUPIncluded	'0'B		
SIG_INTEGRITY_SUP	Not present		
AUTHIncluded	'1'B		
AUTH	'00'B		
MAX_NUM_ALT_SOIncluded	'1'B		
MAX_NUM_ALT_SO	'000'B		
USE_SYNC_IDIncluded	'0'B		
USE_SYNC_ID	Not present		
MS_INIT_POS_LOC_SUP_INDIncluded	'0'B		
MS_INIT_POS_LOC_SUP_IND	Not present		
MOB_QOSIncluded	'0'B		
MOB_QOS	Not present		
BAND_CLASS_INFO_REQIncluded	'0'B		
BAND_CLASS_INFO_REQ	Not present		
BAND_CLASSIncluded	'1'B		
BAND_CLASS	'00000'B		
BYPASS_REG_INDIncluded	'0'B		
BYPASS_REG_IND	Not present		
'0'B ALT_BAND_CLASSIncluded			
ALT_BAND_CLASS	Not present		
MAX_ADD_SERV_INSTANCEIncluded	'0'B		
MAX_ADD_SERV_INSTANCE	Not present		

HOME_REGIncluded	'1'B		
HOME_REG	The same as SIB8 on cell 2		
FOR_SID_REGIncluded	'1'B		
FOR_SID_REG	The same as SIB8 on cell 2		
FOR_NID_REGIncluded	'1'B		
FOR_NID_REG	The same as SIB8 on cell 2		
POWER_UP_REGIncluded	'1'B		
POWER_UP_REG	The same as SIB8 on cell 2		
POWER_DOWN_REGIncluded	'1'B		
POWER_DOWN_REG	The same as SIB8 on cell 2		
PARAMETER_REGIncluded	'1'B		
PARAMETER_REG	The same as SIB8 on cell 2		
REG_PRDIncluded	'1'B		
REG_PRD	The same as SIB8 on cell 2		
REG_DISTIncluded	'0'B		
REG_DIST	Not present		
PREF_MSID_TYPEIncluded	'1'B		
PREF_MSID_TYPE	'11'B		
EXT_PREF_MSID_TYPEIncluded	'0'B		
EXT_PREF_MSID_TYPE	Not present		
MEID_REQDIncluded	'0'B		
MEID_REQD	Not present		
MCCIncluded	'1'B		
MCC	See the Table 4.4.2-4 Note 1, Note 2 in [18]		
IMSI_11_12Included	'1'B		
IMSI_11_12	See the Table 4.4.2-4 Note 1, Note 2 in [18]		
IMSI_T_SUPPORTEDIncluded	'1'B		
IMSI_T_SUPPORTED	'0'B		
RECONNECT_MSG_INDIncluded	'0'B		
RECONNECT_MSG_IND	Not present		
RER_MODE_SUPPORTEDIncluded	'0'B		
RER_MODE_SUPPORTED	Not present		
TKZ_MODE_SUPPORTEDIncluded	'0'B		
TKZ_MODE_SUPPORTED	Not present		
TKZ_IDIncluded	'0'B		
TKZ_ID	Not present		
PILOT_REPORTIncluded PILOT_REPORT	'0'B		
PILOT_REPORT	Not present		
SDB_SUPPORTEDIncluded	'0'B		
SDB_SUPPORTED	Not present		
AUTO_FCSO_ALLOWEDIncluded	'0'B		
AUTO_FCSO_ALLOWED	Not present		
SDB_IN_RCNM_INDIncluded	'0'B		
SDB_IN_RCNM_IND	Not present		
FPC_FCH_Included	'1'B		
FPC_FCH_INIT_SETPT_RC3	'00011000'B		
FPC_FCH_INIT_SETPT_RC4	'00011000'B		
FPC_FCH_INIT_SETPT_RC5	'00011000'B		
FPC_FCH_INIT_SETPT_RC11	'00000000'B		
FPC_FCH_INIT_SETPT_RC12	'00000000'B		
T_ADD_Included	'0'B		
T_ADD	Not present		
PILOT_INC_Included	'1'B		
PILOT_INC	'0010'B		
RAND_Included	'0'B		
RAND	Not present		
LP_SEC_Included	'1'B		

LP_SEC	'00000000'B		
LTM_OFF_Included	'1'B		
LTM_OFF	'000000'B		
DAYLT_Included	'1'B		
DAYLT	'0'B		
GCSNAL2AckTimer_Included	'1'B		
GCSNAL2AckTimer	'00000001'B		
GCSNASequenceContextTimer_Included	'1'B		
GCSNASequenceContextTimer	'00000101'B		

Table 13.4.4.1.3.3-3: *ULInformationTransfer* (Step 3, Table 13.4.4.1.3.2-2)

Derivation Path: 36.508 Table 4.6.1-25			
Information Element	Value/remark	Comment	Condition
ULInformationTransfer ::= SEQUENCE {			
criticalExtensions CHOICE {			
c1 CHOICE {			
ulInformationTransfer-r8 SEQUENCE {			
dedicatedInformationType CHOICE {			
dedicatedInfoCDMA2000-1XRTT	Set according to Table 13.4.4.1.3.3-4		
}			
}			
}			
}			
}			

Table 13.4.4.1.3.3-4: 1xRTT GCSNA Encapsulated Registration message (Step 10, Table 13.4.4.1.3.2-2)

Information Element	MessageID	'00000001'B	GCSNA1xCircuit Service message	
GCSNAOption		'00000001'B		
AlternativeGCSNAOption_INCL		'0'B		
IWSIDIncl		'0'B		
AckRequired		'1'B		
StopDupDetect		'0'B		
MessageSequence		Set by UE		
NumTLACEncapsulated1xL3PDU		'00'B		
Reserved		'0000'B		
1xLogicalChannel		'0'B		
1xProtocolRevision		'00000110'B		
MsgType		'00000001'B	Registration message	this value shall be verified by TTCN
NumTLACHeaderRecords		'0001'B		
TLACHeaderRecordType		'0000'B		
TLACHeaderRecordLength		8 bits, Set by UE		
MSID_TYPE		'011'B		
MSID_LEN		4 bits, Set by UE		
MSID		Variable, Set by UE		
Reserved		'0000000'B		
1xL3PDUlength		16 bits, Set by UE		
REG_TYPE		'0010'B	Zone-based Registration	this value shall be verified by TTCN
SLOT_CYCLE_INDEX		'010'B		
MOB_P_REV		8 bits, Set by UE		
SCM		8 bits, Set by UE		
MOB_TERM		'1'B		
RETURN_CAUSE		'1'B		
QPCH_SUPPORTED		'1'B		
ENHANCED_RC		'1'B		
UZID_INCL		'0'B		

13.4.4.2 Pre-registration at 1xRTT and Cell reselection / 1x Ordered Registration

13.4.4.2.1 Test Purpose (TP)

(1)

```

with { UE in E-UTRA RRC_IDLE state having completed the 1xRTT CS pre-registration and having
detecting the cell ranked as the best cell}
  then {selecting the new cell }
ensure that {
  when { UE receives an DLInformationTransfer message containing a tunnelled 1xRTT GCSNA Encapsulated
Registration Request Order }
    then { UE transmits an ULInformationTransfer message containing a tunnelled 1xRTT GCSNA
Encapsulated Registration message}
}

```

13.4.4.2.2 Conformance requirements

References: The conformance requirements covered in the present TC are specified in: TS 23.272, clause B.2.1.1.

[TS 23.272, clause B.2.1.1]

This clause describes how the UE in an E-UTRAN system establishes and maintains pre-registration in the 1xCS system.

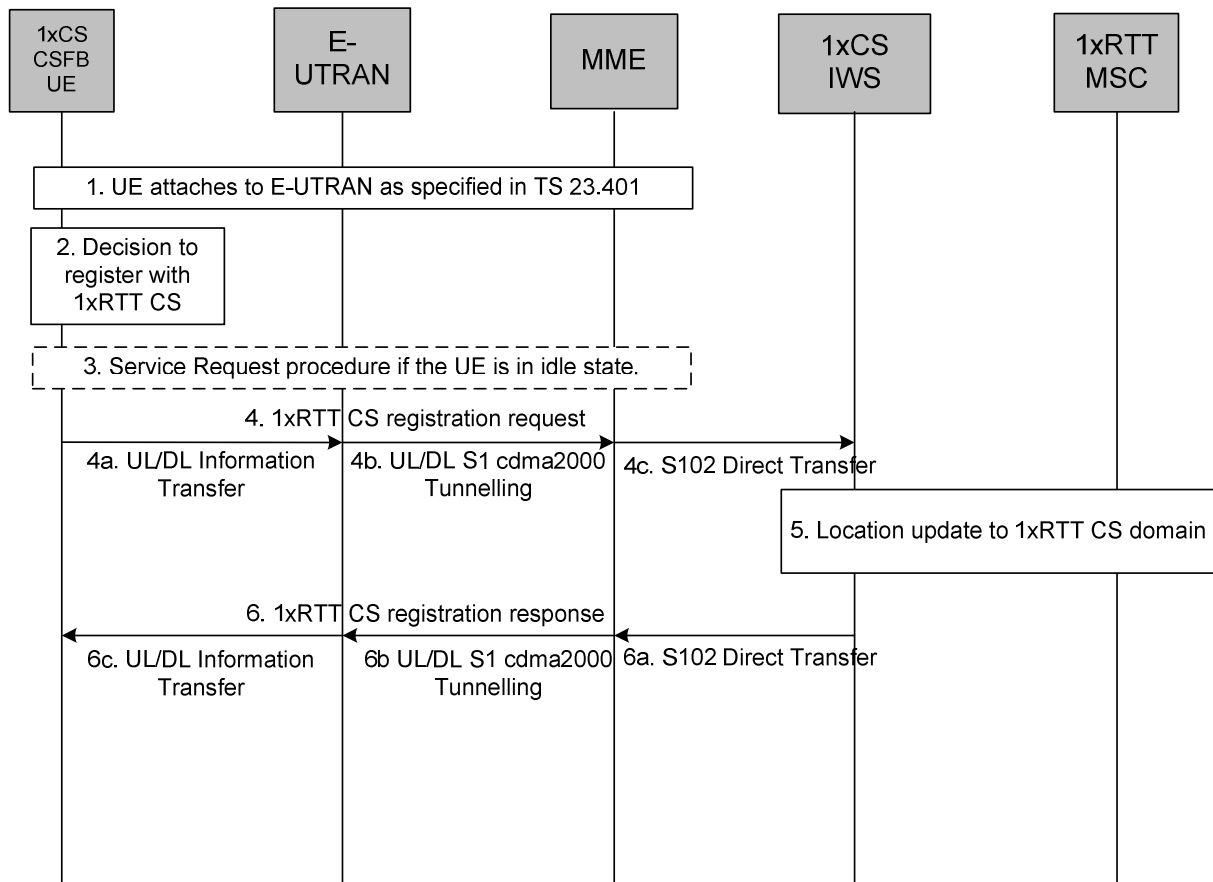

Figure B.2.1.1-1: 1xRTT CS registration procedure

1. The UE attaches to E-UTRAN as specified in TS 23.401 [2]. The UE includes an indication of enhanced CS fallback to 1xRTT and may also include concurrent 1xRTT and HRPD PS session handling capabilities as part of the UE radio capabilities.
2. Based on a radio layer trigger (e.g. an indication from the E-UTRAN when the UE is in connected state or an indication over the broadcast channel), the UE decides to register with the 1xRTT CS domain.
3. If the UE is in idle state, in order to create a signalling connection with the MME, it performs the Service Request procedure.
4. The UE generates a 1xRTT CS registration request.
 - 4a. The 1xRTT CS message is transferred from the UE to E-UTRAN.
 - 4b. E-UTRAN forwards the 1xRTT CS message to the MME including the CDMA2000 Reference Cell ID.
 - 4c. The MME selects a 1xCS IWS node based on the CDMA2000 Reference Cell ID. The IMSI is used to distinguish S102 signalling transactions belonging to different UEs. The MME sends a S102 Direct Transfer message (IMSI, 1xCS message) to the 1xCS IWS node.
5. 1xRTT CS registration is then performed by the 1xCS IWS node based on 3GPP2 A.S0008-C v4.0 [16].
 - 6a. 1xRTT CS registration response is tunnelled back to the MME in a S102 Direct Transfer message (IMSI, 1xCS message).
 - 6b. The MME forwards the 1xRTT CS message to the E-UTRAN.
 - 6c. The E-UTRAN forwards the 1xRTT CS message to the UE.

If the triggers for 1xCS registration change over time, the UE (both in idle or connected state), uses this information to update the 1xCS registration via the tunnel.

13.4.4.2.3 Test description

13.4.4.2.3.1 Pre-test conditions

System Simulator:

- Cell 1 and Cell 2.
- System information combination 6 as defined in TS 36.508 [18] clause 4.4.3.1 is used in E-UTRA cells.
- Cell 1 and Cell2 have the same SIB8 configuration.

UE:

None.

Preamble:

- The UE is in state Registered, Idle mode pre-registered on 1xRTT (state 2C) on Cell 1 according to [18].

13.4.4.2.3.2 Test procedure sequence

Table 13.4.4.2.3.2-1 illustrates the downlink power levels and other changing parameters to be applied for the cells at various time instants of the test execution.

Table 13.4.4.2.3.2-1: Time instances of cell power level and parameter changes

	Parameter	Unit	Cell 1	Cell 2	Remark
T1	Cell-specific RS EPRE	dBm/15kHz	-85	-79	The power level values are assigned to satisfy $R_{\text{Cell 1}} < R_{\text{Cell 2}}$.

Table 13.4.4.2.3.2-2: Main behaviour

St	Procedure	Message Sequence		TP	Verdict
		U – S	Message		
1	The SS changes Cell 2 level according to the row "T1" in table 13.4.4.2.3.2-1.	-	-	-	-
2	The UE is camped on E-UTRAN Cell 2.	-	-	-	-
3-10	Steps 2 to 9 of the generic radio bearer establishment procedure (TS 36.508 4.5.3.3-1) are executed to successfully complete the service request procedure.				
10A-10B	Steps 16A and 16B of generic procedure (TS 36.508 4.5.2C.3-2) are executed	-	-	-	-
11	The SS transmits an <i>DLInformationTransfer</i> containing a tunnelled <i>1xRTT GCSNA encapsulated Registration Request order</i> on Cell 2.	<--	<i>DLInformationTransfer</i>		
12	Check: Does the UE transmit an <i>ULInformationTransfer</i> containing a tunnelled <i>1xRTT GCSNA encapsulated Registration message</i> on Cell 2.	-->	<i>ULInformationTransfer</i>	1	P
13-15	Steps 17A to 19 of the UE Registration, pre-registration on 1xRTT (TS 36.508 4.5.2C.3-2) on Cell 2.				

Table 13.4.4.2.3.2-3: Void

13.4.4.2.3.3 Specific message contents

Table 13.4.4.2.3.3-1: *DLInformationTransfer* (step 11, Table 13.4.4.2.3.2-2)

Derivation Path: 36.508 Table 4.6.1-3			
Information Element	Value/remark	Comment	Condition
DLInformationTransfer ::= SEQUENCE {			
criticalExtensions CHOICE {			
c1 CHOICE {			
dlInformationTransfer-r8 SEQUENCE {			
dedicatedInfoType CHOICE {			
dedicatedInfoCDMA2000-1XRTT	Set according to Table 13.4.4.2.3.3-2		
}			
}			
}			
}			

Table 13.4.4.2.3.3-2: *1xRTT GCSNA Encapsulated Registration Request Order* (Step 11, Table 13.4.4.2.3.2-2)

Information Element	Value/remark	Comment	Condition
MessageID	'00000001'B		
GCSNAOption	'00000001'B		
AlternativeGCSNAOption_INCL	'0'B		
IWSIDIncl	'0'B		
AckRequired	'0'B		
StopDupDetect	'0'B		
MessageSequence	6 bits, Set by SS		
NumTLACEncapsulated1xL3PDU	'00'B		
Reserved	'0000'B		
1xLogicalChannel	'0'B		
1xProtocolRevision	'00000110'B		
MsgType	'00000111'B	Order message	
NumTLACHHeaderRecords	'0000'B		
Reserved	'000'B		
1xL3PDULength	16 bits, Set by SS		
ORDER	'011011'B		
ADD_RECORD_LEN	'001'B		
ORDQ	'00000001'B	Registration Request Order	

Table 13.4.4.2.3.3-3: *ULInformationTransfer* (Step 12, Table 13.4.4.2.3.2-2)

Derivation Path: 36.508 Table 4.6.1-25			
Information Element	Value/remark	Comment	Condition
ULInformationTransfer ::= SEQUENCE {			
criticalExtensions CHOICE {			
c1 CHOICE {			
ulInformationTransfer-r8 SEQUENCE {			
dedicatedInformationType CHOICE {			
dedicatedInfoCDMA2000-1XRTT	Set according to Table 13.4.4.2.3.3-4		
}			
}			
}			
}			

Table 13.4.4.2.3.3-4: 1xRTT GCSNA Encapsulated Registration message (Step 12, Table 13.4.4.2.3.2-2)

Information Element			
MessageID	'0000001'B	GCSNA1xCircuit Service message	
GCSNAOption	'0000001'B		
AlternativeGCSNAOption_INCL	'0'B		
IWSIDIncl	'0'B		
AckRequired	'1'B		
StopDupDetect	'0'B		
MessageSequence	Set by UE		
NumTLACEncapsulated1xL3PDU	'00'B		
Reserved	'0000'B		
1xLogicalChannel	'0'B		
1xProtocolRevision	'00000110'B		
MsgType	'0000001'B	Registration message	this value shall be verified by TTCN
NumTLACHeaderRecords	'0001'B		
TLACHeaderRecordType	'0000'B		
TLACHeaderRecordLength	8 bits, Set by UE		
MSID_TYPE	'011'B		
MSID_LEN	4 bits, Set by UE		
MSID	Variable, Set by UE		
Reserved	'0000000'B		
1xL3PDUlength	16 bits, Set by UE		
REG_TYPE	'0101'B	Ordered Registration	this value shall be verified by TTCN
SLOT_CYCLE_INDEX	'010'B		
MOB_P_REV	8 bits, Set by UE		
SCM	8 bits, Set by UE		
MOB_TERM	'1'B		
RETURN_CAUSE	'1'B		
QPCH_SUPPORTED	'1'B		
ENHANCED_RC	'1'B		
UZID_INCL	'0'B		

13.4.4.3 Inter-system session management / Multiple PDN connection establishment in eHRPD pre-registration state

13.4.4.3.1 Test Purpose (TP)

(1)

```
with { UE in E-UTRA RRC_CONNECTED state and UE has performed multiple PDN connection setups in E-UTRA with PDN type = IPv4 }
ensure that {
  when { UE transmits VSNCP Configure Request }
  then { APN name is identical with additional PDN name in EUTRA and Attach Type at the HRPD side is 'Handover Attach' }
}
```

(2)

```
with { UE in E-UTRA RRC_CONNECTED state and UE has performed multiple PDN connection setups in E-UTRA with PDN type = IPv4 and the UE originated VSNCP Configure Request procedure is finished }
ensure that {
  when { SS transmits VSNCP Configure Request with APN-AMBR }
  then { UE acknowledges the received APN-AMBR values }
}
```

13.4.4.3.2 Conformance requirements

References: The conformance requirements covered in the present TC are specified in: TS 36.331, clauses 5.2.2.15, 5.6.1.3 and 5.6.2.3; TS 23.401, clause 4.4.3.3; TS 23.402, clause 9.1.2.2; TS 24.302, clause 6.4.4; TS 33.402, clause 10.2.1 and 3GPP2 X.S0057-0-B v1.0, clause 13.1.2.

[TS 36.331, clause 5.2.2.15]

Upon receiving *SystemInformationBlockType8*, the UE shall:

- 1> if the *systemTimeInfo* is included:
 - 2> forward the *systemTimeInfo* to CDMA2000 upper layers;
- 1> if the UE is in RRC_IDLE and if *searchWindowSize* is included:
 - 2> forward the *searchWindowSize* to CDMA2000 upper layers;
- 1> if *parametersHRPD* is included;
 - 2> forward the *preRegistrationInfoHRPD* to CDMA2000 upper layers only if the UE has not received the *preRegistrationInfoHRPD* within an *RRCCONNECTIONRECONFIGURATION* message after entering this cell;
 - 2> if the *cellReselectionParametersHRPD* is included:
 - 3> forward the *neighCellList* to the CDMA2000 upper layers;

...

[TS 36.331, clause 5.6.1.3]

Upon receiving *DLInformationTransfer* message, the UE shall:

- 1> if the *dedicatedInfoType* is set to '*dedicatedInfoNAS*':
 - 2> forward the *dedicatedInfoNAS* to the NAS upper layers.
- 1> if the *dedicatedInfoType* is set to '*dedicatedInfoCDMA2000-1XRTT*' or to '*dedicatedInfoCDMA2000-HRPD*':
 - 2> forward the *dedicatedInfoCDMA2000* to the CDMA2000 upper layers;

[TS 36.331, clause 5.6.2.3]

The UE shall set the contents of the *ULInformationTransfer* message as follows:

- 1> if there is a need to transfer NAS information:
 - 2> set the *dedicatedInfoType* to include the '*dedicatedInfoNAS*';
- 1> if there is a need to transfer CDMA2000 1XRTT information:
 - 2> set the *dedicatedInfoType* to include the '*dedicatedInfoCDMA2000-1XRTT*';
- 1> if there is a need to transfer CDMA2000 HRPD information:
 - 2> set the *dedicatedInfoType* to include the '*dedicatedInfoCDMA2000-HRPD*';
- 1> submit the *ULInformationTransfer* message to lower layers for transmission, upon which the procedure ends;

[TS 23.401, clause 4.4.3.3]

The PDN GW is the gateway which terminates the SGi interface towards the PDN.

If a UE is accessing multiple PDNs, there may be more than one PDN GW for that UE, however a mix of S5/S8 connectivity and Gn/Gp connectivity is not supported for that UE simultaneously.

PDN GW functions include for both the GTP-based and the PMIP-based S5/S8:

- Per-user based packet filtering (by e.g. deep packet inspection);

- Lawful Interception;
- UE IP address allocation;
- Transport level packet marking in the uplink and downlink, e.g. setting the DiffServ Code Point, based on the QCI of the associated EPS bearer;
- Accounting for inter-operator charging;
- UL and DL service level charging as defined in TS 23.203 [6]
(e.g. based on SDFs defined by the PCRF, or based on deep packet inspection defined by local policy);
- Interfacing OFCS through according to charging principles and through reference points specified in TS 32.240 [51].
- UL and DL service level gating control as defined in TS 23.203 [6];
- UL and DL service level rate enforcement as defined in TS 23.203 [6]
(e.g. by rate policing/shaping per SDF);
- UL and DL rate enforcement based on APN-AMBR
(e.g. by rate policing/shaping per aggregate of traffic of all SDFs of the same APN that are associated with Non-GBR QCIs);
- DL rate enforcement based on the accumulated MBRs of the aggregate of SDFs with the same GBR QCI
(e.g. by rate policing/shaping);
- DHCPv4 (server and client) and DHCPv6 (client and server) functions;
- The network does not support PPP bearer type in this version of the specification. Pre-Release 8 PPP functionality of a GGSN may be implemented in the PDN GW;
- packet screening.

Additionally the PDN GW includes the following functions for the GTP-based S5/S8:

- UL and DL bearer binding as defined in TS 23.203 [6];
- UL bearer binding verification as defined in TS 23.203 [6];
- Functionality as defined in RFC 4861 [32];
- Accounting per UE and bearer.

The P-GW provides PDN connectivity to both GERAN/UTRAN only UEs and E-UTRAN capable UEs using any of E-UTRAN, GERAN or UTRAN. The P-GW provides PDN connectivity to E-UTRAN capable UEs using E-UTRAN only over the S5/S8 interface.

[TS 23.402, clause 9.1.2.2]

The S101 interface supports procedures for Pre-Registration, Session Maintenance and Active handovers between E-UTRAN and HRPD networks. This is based on tunnelling over S101 signalling of one technology while the UE is in the other technology. The HRPD air interface messages tunnelled over S101 in E-UTRAN to HRPD mobility are defined in 3GPP2 C.S0087-0-A v2.0 [49].

The S101 reference point shall support the following requirements:

- HRPD and E-UTRAN/EPS messages shall be transported as opaque containers without modifications by the MME or HRPD AN.
- Messages may carry separate information IEs to indicate status, message types (e.g. handover command) forwarding addresses etc. as required by signalling procedures.
- Provide identifiers (i.e. S101 Session ID) to distinguish messages belonging to different UEs in order to allow responses originating from the target system to an UE to be appropriately forwarded to the UE by the source system.

- Reliable transport for S101 messages should be provided at the application layer and will not require transport layer reliability mechanism.

[TS 24.302, clause 6.4.4]

Connectivity to multiple PDNs via trusted non-3GPP access is supported in the EPS when the network policies, the non-3GPP access and user subscription allow it. If the UE supports dynamic mobility management selection the UE shall use the same mobility protocol when multiple connections are established, see 3GPP TS 23.402 [6].

When using the S2a interface to establish connections to additional PDNs the UE shall send a trigger for additional PDN connectivity specific to the non-3GPP access. The UE shall include an APN in this trigger to connect to the desired PDN. The UE shall also indicate the Attach Type to the trusted non-3GPP access during additional PDN connectivity. The Attach Type shall distinguish between Initial Attach and Handover Attach.

NOTE 1: The indication about Attach Type is non-3GPP access network specific and its coding is out of scope of this specification.

NOTE 2: The trigger for additional PDN connectivity is non-3GPP access network specific and its coding is out of scope of this specification.

When using the S2c interface, the UE shall follow the procedures described in 3GPP TS 24.303 [11] to connect to multiple PDNs.

If the UE is handing over from a source access network to a target non-3GPP access using PMIP-based S2a and the UE has more than one PDN connection to a given APN in the source access network, and if multiple PDN connections to a single APN are not supported over the target trusted non-3GPP access network, only one PDN connection to the given APN shall be established in the target non-3GPP access as specified in 3GPP TS 23.402 [6]. If multiple PDN connection requests to the same APN are received but the target trusted non-3GPP access network does not support multiple PDN connections to the same APN, the network shall reject the additional PDN connection requests to the same APN received from the UE when one PDN connection to the same APN has already been established. The UE shall determine which PDN connection is re-established in the non-3GPP access based on the home address information (i.e. IPv4 address or IPv6 prefix or both) provided by the network.

NOTE 3: The protocol details of the PDN connection reject procedure is non-3GPP access network specific and its coding is outside the scope of this specification.

NOTE 4: When UE supporting IP address preservation for NBM with multiple PDN connections to the same APN hands over to the non-3GPP access network, the UE can, as an implementation option, prioritise the re-establishment for a particular PDN connection before re-establishing the remaining PDN connections. The way a UE prioritizes a particular PDN connection is non-3GPP access network specific and its coding is out of scope of this specification. Another implementation option can be to send multiple re-establishment requests concurrently.

NOTE 5: Any unsuccessful re-establishment of any of the multiple PDN connections to the same APN can be managed in an implementation specific manner avoiding UE making repeated re-establishment attempts to the network.

[TS 33.402, clause 10.2.1]

For pre-registration, the UE interacts directly with HRPD system to perform authentication through the HS-GW and establish security association with this system directly. The procedures are the same as in the case when the UE connects directly to the HRPD access network except that it is tunnelled over the E-UTRAN/EPS. In these procedures, the UE follows the authentication and key agreement procedure described in subclause 6.2. Tunnelled signalling is exchanged over S101 interface which shall be secured as described in clause 11.

NOTE 6: Network domain security as specified in TS 33.210 [6] and TS 33.310 [12] applies to secure signalling between eAN/PCF in the HRPD access network and MME in the serving network.

In the case when the UE is not aware of its movement from E-UTRAN to HRPD, the UE may access the HRPD system directly without performing a pre-registration through E-UTRAN/EPS system.

For UEs with an established emergency call the authentication is subject to the requirements in clause 13.

13.4.4.3.3 Test description

13.4.4.3.3.1 Pre-test conditions

System Simulator:

- Cell 1.
- System information combination 6 as defined in TS 36.508 [18] clause 4.4.3.1 is used in E-UTRA cells.

UE:

None.

Preamble:

- The UE is in state Generic RB Established (state 3B) on Cell 1 according to [18].
- The UE has performed HRPD pre-registration.

13.4.4.3.3.2 Test procedure sequence

Table 13.4.4.3.3.2-1: Main behaviour

St	Procedure	Message Sequence		TP	Verdict
		U – S	Message		
1	Cause the UE to request connectivity to an additional PDN (see Note 1)	-	-	-	-
2	The UE transmits a PDN CONNECTIVITY REQUEST message as specified to request an additional PDN (= PDN-2)	-->	<i>ULInformationTransfer</i> (PDN CONNECTIVITY REQUEST)	-	-
3	The SS transmits an <i>RRCCONNECTIONRECONFIGURATION</i> message on Cell 1 to activate a second Default EPS Bearer Context.	<--	<i>RRCCONNECTIONRECONFIGURATION</i> (ACTIVATE DEFAULT EPS BEARER CONTEXT REQUEST)	-	-
4	The UE transmits an <i>RRCCONNECTIONRECONFIGURATIONCOMPLETE</i> message on Cell 1.	-->	<i>RRCCONNECTIONRECONFIGURATIONCOMPLETE</i>	-	-
5	The UE transmits an ACTIVATE DEFAULT EPS BEARER CONTEXT ACCEPT message.	-->	<i>ULInformationTransfer</i> (ACTIVATE DEFAULT EPS BEARER CONTEXT ACCEPT)	-	-
6	Check: Does the UE transmit a VSNCPCONFIGURE REQUEST message including PDN identifier = '0', Access Point Name with the same value as PDN-2 via EUTRA, PDN type = '1' ("IPv4"), PDN address with PDN address information set to the IP address(es) assigned over EUTRA, and Attach Type = '3' ("handover attach"), and the Address Allocation Cause = '00'? See Note 2	-->	<i>ULInformationTransfer</i> (VSNCPCONFIGURE REQUEST)	1	P
7	The SS transmits a VSNCPCONFIGURE ACK message on Cell 1 to confirm APN parameters PDN identifier, Access Point Name, PDN type, PDN address with PDN address information from "UE IPv4 address", Attach Type and the Address Allocation Cause = '255' ("Success"). See Note 2.	<--	<i>DLInformationTransfer</i> (VSNCPCONFIGURE ACK)	-	-
8	The SS transmits a VSNCPCONFIGURE REQUEST message on Cell 1 including the PDN-ID to configure APN-AMBR for DL and UL. See Note 2	<--	<i>DLInformationTransfer</i> (VSNCPCONFIGURE REQUEST)	-	-
9	Check: Does the UE transmit a VSNCPCONFIGURE ACK message as specified to confirm the previously APN-AMBR values received. See Note 2	-->	<i>ULInformationTransfer</i> (VSNCPCONFIGURE ACK)	2	P
<p>Note 1: The request of connectivity to an additional PDN may be performed by MMI or AT command.</p> <p>Note 2: It is assumed that the dedicatedInfoCDMA2000-HRPD which is embedded in the RRC UL/DL Information Transfer messages is an ASN.1 charstring and therefore cannot be provided in table format. This is why the dedicatedInfoCDMA2000-HRPD IEs have been defined in the procedure column of the Test Procedure Sequence above.</p>					

13.4.4.3.3.3 Specific message contents

Table 13.4.4.3.3-1: PDN CONNECTIVITY REQUEST (Step 2, Table 13.4.4.3.3.2-1)

Derivation Path: TS 36.508 Table 4.7.3-20			
Information Element	Value/remark	Comment	Condition
EPS bearer identity	0000	No EPS bearer identity assigned	
Procedure transaction identity	PTI-1	UE assigns a particular PTI not yet used between 1 and 254	
PDN type	'001'B	IPv4	
ESM information transfer flag	Not present	This IE is only used during an attach procedure.	
Access point name	APN-1(New PDN name)	The requested PDN is different from default PDN	
Protocol configuration options			
Configuration protocol 1	'8021'H	IPCP	
Length of configuration protocol 1 contents		As per RFC 1661	
Configuration protocol 1 contents		As per RFC 1661	
Configuration protocol 2	'C223'H	IPCP	
Length of configuration protocol 2 contents		As per RFC 1661	
Configuration protocol 2 contents		As per RFC 1661 (CHAP-Response)	
Container ID 1	'000A'H	IP Address allocation via NAS signalling	
Length of container ID 1 contents	0		
Container ID 1 contents	Not present		

Table 13.4.4.3.3-2: ACTIVATE DEFAULT EPS BEARER CONTEXT REQUEST (Step 3, Table 13.4.4.3.3.2-1)

Derivation Path: TS 36.508 Table 4.7.3-6			
Information Element	Value/remark	Comment	Condition
EPS bearer identity	6		
Procedure transaction identity	PTI-1	SS re-uses the particular PTI defined by UE for this present additional PDN connectivity request procedure.	
EPS QoS	See Reference default EPS bearer context #1 in table 6.6.1-1		
Access point name	APN-1	SS re-uses the particular APN defined by UE for this present additional PDN connectivity request procedure	
PDN address			
Length of PDN address contents	5 octets		
PDN type value	'001'B	IPv4	
PDN address information	0.0.0.0	DHCPv4 is to be used to allocate the IPv4 address	

Table 13.4.4.3.3-3: ACTIVATE DEFAULT EPS BEARER CONTEXT ACCEPT (Step 5, Table 13.4.4.3.3.2-1)

Derivation Path: TS 36.508 Table 4.7.3-4			
Information Element	Value/remark	Comment	Condition
EPS bearer identity	6		
Procedure transaction identity	0	No procedure transaction identity assigned	
Protocol configuration options	Not present or any allowed value	Assumption: As in PDNConnectivity Request.	

Table 13.4.4.3.3-4: VSNCP CONFIGURE REQUEST (Step 6, Table 13.4.4.3.3.2-1)

Derivation Path: 3GPP2 X.S0057-0 Table 2			
Information Element	Value/remark	Comment	Condition
Code	1	VSNCP Configure Request this value shall be verified by TTCN	
...			

Table 13.4.4.3.3-5: VSNCP CONFIGURE ACK (Step 9, Table 13.4.4.3.3.2-1)

Derivation Path: 3GPP2 X.S0057-0 Table 2			
Information Element	Value/remark	Comment	Condition
Code	2	VSNCP Configure Ack this value shall be verified by TTCN	
...			

13.4.4.4 Inter-system session management / Pre-registration at HRPD and Cell reselection / HRPD Zone Registration

13.4.4.4.1 Test Purpose (TP)

(1)

```
with { UE in E-UTRA RRC_IDLE state and UE has performed pre-registration on HRPD neighbour cell }
ensure that {
  when { UE detects preRegistrationZoneId on SystemInformationBlock8 has been changed. }
  then { UE establishes the RRC connection and performs UATI re-assignment and alternate link establishment procedure }
}
```

(2)

```
with { UE has been complete alternate link establishment procedure }
ensure that {
  when { UE receives DLInformation Transfer followed by dedicatedInfoCDMA2000-HRPD containing a LCP Configure Request for PDN re-establishment }
  then { UE transmit ULInformation Transfer containing a tunnelled LCP Configure Ack message, and continues to LCP negotiation }
}
```

(3)

```
with { UE in EAP-Authentication phase }
ensure that {
  when { UE receives EAP-Success message }
  then { UE transmit ULInformation Transfer containing a tunnelled VSNCP Configure Request message including a PDN-ID, PDN Type, APN, PDN Address with the same value as last PDN setup when UE performed pre-registration }
}
```

}

13.4.4.4.2 Conformance requirements

References: The conformance requirements covered in the present TC are specified in: TS 23.401, clause 9.3.1.

[TS 23.401, clause 9.3.1]

Figure 9.3.1-1 illustrates a high-level call flow for the optimised E-UTRAN to HRPD handover procedure, Pre-registration phase.

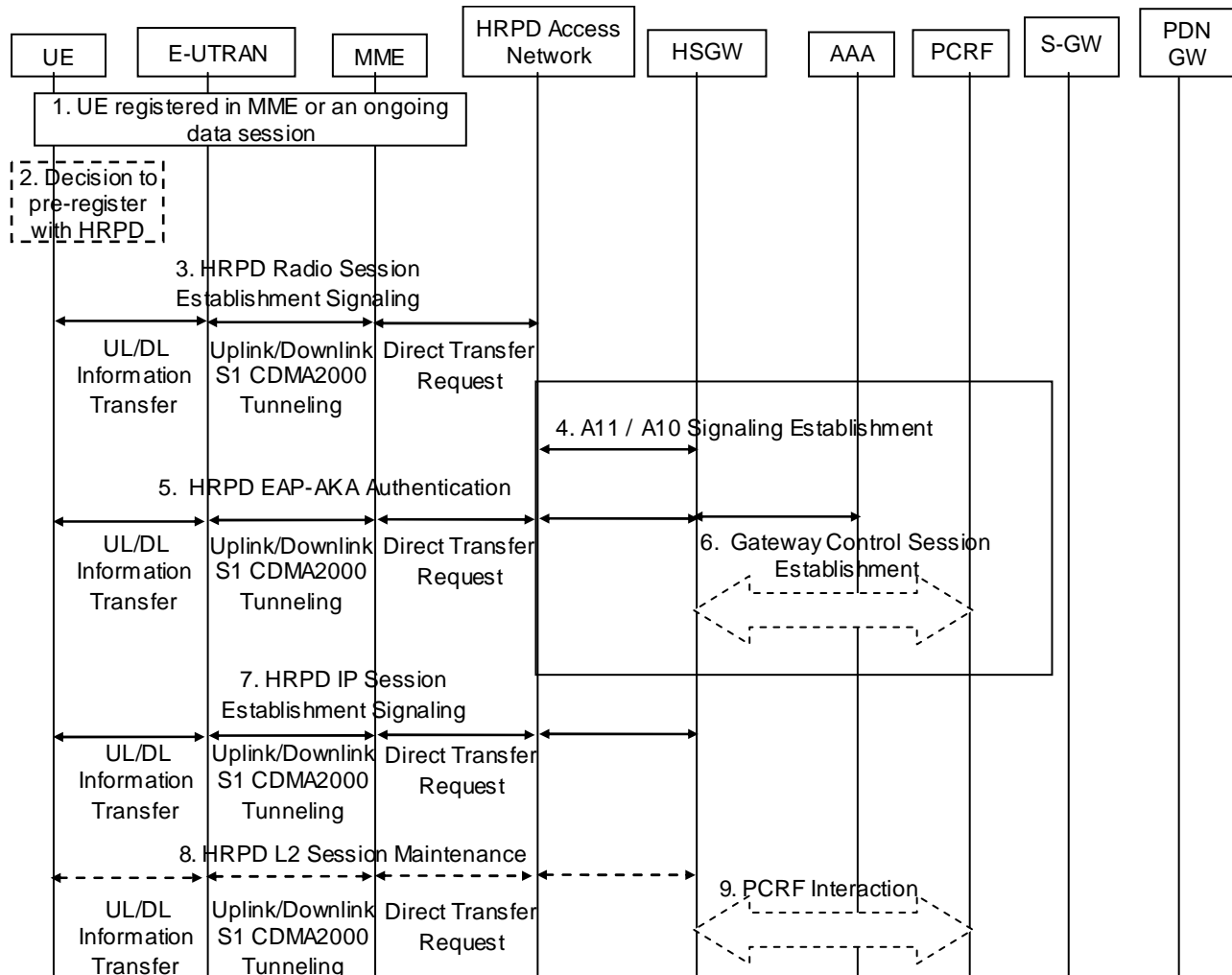

Figure 9.3.1-1: HRPD registration via LTE/SAE tunnel

1. The UE is registered with E-UTRAN/MME. It may have an ongoing data session established over EPS/E-UTRAN access.
2. Based on a Radio Layer trigger (e.g., an indication from the E-UTRAN when the UE is in connected state or an indication over the broadcast channel), the UE decides to initiate a pre-registration procedure with potential target HRPD access. The pre-registration procedure allows the UE to establish and maintain a dormant session in the target HRPD access, while attached to the E-UTRAN/MME.
3. Registration to the HRPD is achieved by exchanging a series of HRPD messages between the UE and the HRPD Access Network. The HRPD signalling that is tunnelled transparently over the E-UTRAN and EPC creates an HRPD session context between the UE and the HRPD Access Network. The procedures described below are used in steps 3, 5, 8 and 9.

The UE generates an UL Information Transfer message (UL HRPD message). The UL HRPD message is transferred from the UE to the eNodeB as a parameter in the UL Information Transfer.

The eNodeB sends Uplink S1 CDMA2000 Tunnelling message (UL HRPD message, Sector ID) to the MME. The SectorID is statically configured in the eNodeB.

The MME selects an HRPD access node address. In order to be able to distinguish S101 signalling transactions belonging to different UEs, an S101 Session ID is used to identify signalling related to that UE on S101. The MME sends a Direct Transfer Request message (S101 Session ID, SectorID, UL HRPD message) to the HRPD access node. The MME determines the correct HRPD access node entity and address from the SectorID.

NOTE 1: There is an unambiguous mapping from the SectorID to the HRPD access node address.

The HRPD Access Network sends signalling in the DL direction to the MME using Direct Transfer Request message (S101 Session ID, DL HRPD message). The S101 Session ID is used to associate the signalling to a particular UE.

The MME sends the information on to the eNodeB using the Downlink S1 CDMA2000 Tunnelling message (DL HRPD message).

The eNodeB uses the DL information transfer message (DL HRPD message) to transport the signalling the UE.

If UE is handing over emergency sessions to HRPD access, the UE informs the HRPD access that it is an emergency handover. In case the UE is in limited service state and does not have an IMSI or its IMSI is unauthenticated, IMEI is used as a Session ID. If the IMSI is unauthenticated, the IMSI is also provided on the S101 tunnel to the HRPD access with an indication that it is unauthenticated.

4. The HRPD Access Network creates a signalling relationship with the HS-GW for the UE with interactions in HRPD network A10 / A11 interfaces.

If the HRPD Access Node is not configured to support emergency handovers, then it shall reject any handover request that indicates Emergency Handover.

5. The UE, HS-GW, and 3GPP AAA exchange EAP-AKA' signalling to authenticate the UE on the HRPD system. The HS-GW receives the APN(s) and PDN GW identity(es) information from AAA during authentication.

If the UE is performing an Emergency handover to HRPD access for emergency service and the HRPD access supports Emergency handover, the HRPD access skips the authentication procedure or the HRPD access accepts that the authentication may fail and continues the handover procedure. A statically configured PDN GW is selected by the HRPD access for the UE for unauthenticated UEs.

6. The HS-GW initiates a Gateway Control Session Establishment Procedure with the PCRF as specified in TS 23.203 [19]. If the HS-GW supports UE/NW bearer control mode, the PCRF provides the rules required for the HS-GW to perform the bearer binding for all the active sessions the UE may establish as a result of the handover procedure.
7. The UE and HS-GW exchange signalling to establish context to support the bearer traffic environment in use over the E-UTRAN.
8. At any time prior to the Handover Phase, if session maintenance activity is required, the UE or HRPD access network shall perform session maintenance signalling by tunnelling the HRPD session maintenance messages over the S101. If QoS parameters require updating, then this step includes the PCRF interaction. The MME uses the S101 Session ID to identify the UE context over the S101 interface.

NOTE 2: Between Step 7 and Step 8 the UE may enter ECM-IDLE state. To execute the session maintenance procedures at Step 8 it is necessary for the UE to enter ECM-CONNECTED state.

9. PCRF interactions due to session maintenance can be initiated by the PCRF or the HS-GW. The PCRF initiates the Gateway Control and QoS Rules Provision Procedure specified in TS 23.203 [19]. The HS-GW initiates the Gateway Control and QoS Policy Rules Request Procedure as specified in TS 23.203 [19].

[3GPP2 C.S0057-0-E v1.0, clause 13.1.1]

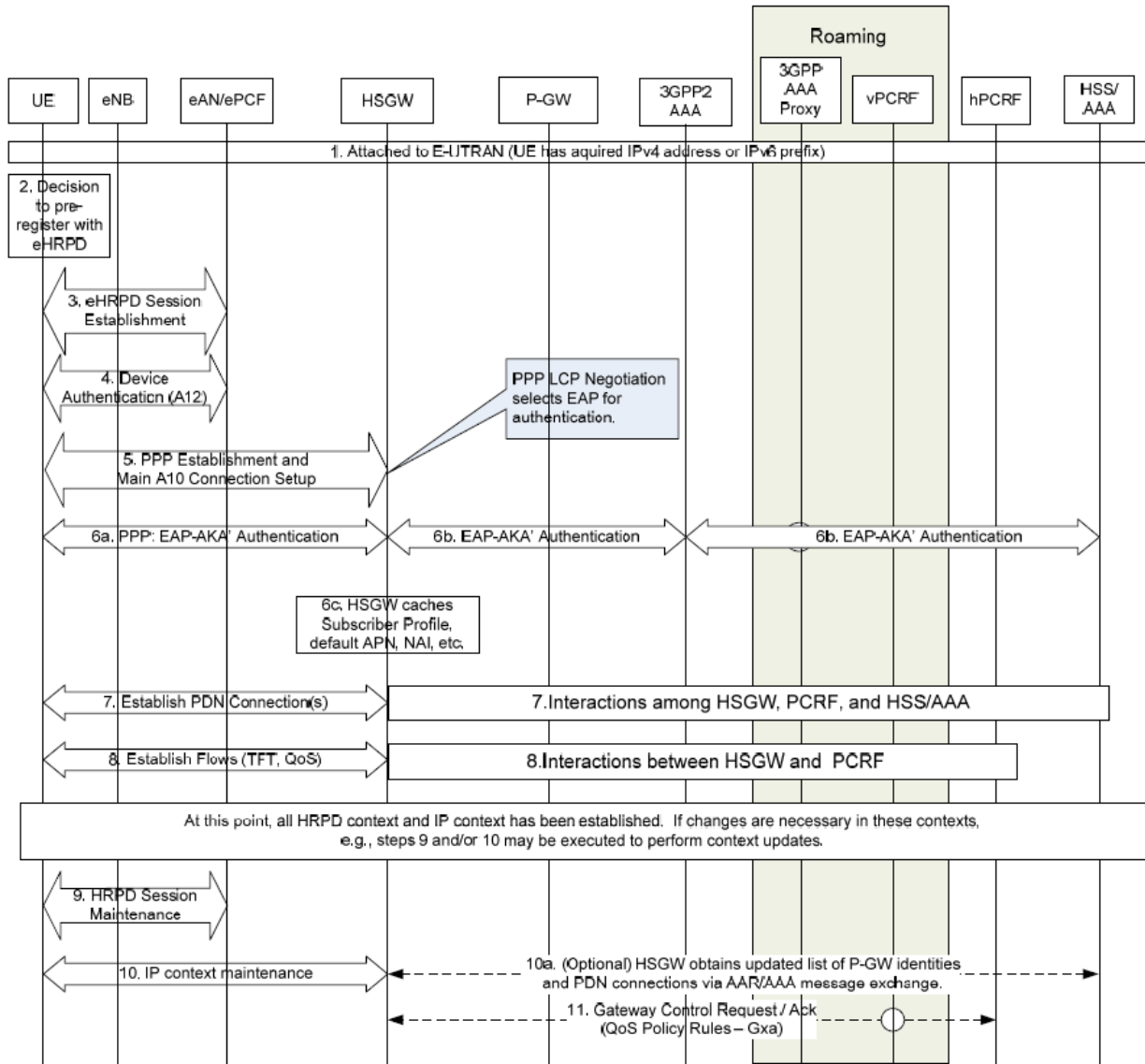

Figure 42 eHRPD Pre-registration via E-UTRAN

13.4.4.4.3 Test description

13.4.4.4.3.1 Pre-test conditions

System Simulator:

- cell 1, and cell 2.
- cell 1 is "Serving cell" and cell 2 is "Suitable cell".
- System information combination 6 as defined in TS 36.508[18] clause 4.4.3.1 is used in E-UTRA cells.
- Cell 1 and Cell 2 have the different Registration Zone ID in SIB8.

UE:

None.

Preamble:

- The UE is in state Registered, Idle mode pre-registered on HRPD (state 2B) on Cell 1 according to [18].

13.4.4.4.3.2 Test procedure sequence

Table 13.4.4.4.3.2-1 illustrates the downlink power levels and other changing parameters to be applied for the cells at various time instants of the test execution.

Table 13.4.4.4.3.2-1: Time instances of cell power level and parameter changes

	Parameter	Unit	Cell 1	Cell 2	Remark
T1	Cell-specific RS EPRE	dBm/15kHz	-85	-79	The power level values are assigned to satisfy $R_{\text{Cell 1}} < R_{\text{Cell 2}}$.

Table 13.4.4.4.3.2-2: Main behaviour

Step	Procedure	Message Sequence		TP	Verdict
		U - S	Message		
1	The SS changes Cell 2 level according to the row "T1" in table 13.4.4.4.3.2-1.	-	-	-	-
2	The UE is camped on E-UTRAN Cell 2.	-	-	-	-
3-9	Steps 3 to 9 of the generic radio bearer establishment procedure (TS 36.508 4.5.3.3-1) are executed to successfully complete the service request procedure.	-	-	-	-
10	Check: Does the UE transmit an <i>ULInformationTransfer</i> containing a tunnelled <i>UATIRequest</i> message Cell 2?	-->	<i>ULInformationTransfer</i>	1	P
11	The SS transmits a <i>DLInformationTransfer</i> containing a tunnelled <i>UATIAssignment</i> message	<--	<i>DLInformationTransfer</i>	-	-
12	Check: Does the UE transmit an <i>ULInformationTransfer</i> containing a tunnelled <i>UATISuccess</i> message on Cell 2?	-->	<i>ULInformationTransfer</i>	-	-
13	The UE transmits an <i>ULInformationTransfer</i> containing a tunnelled <i>AlternateLinkOpenReq</i> message on Cell 2.	-->	<i>ULInformationTransfer</i>	1	P
14	The SS transmits a <i>DLInformationTransfer</i> containing a tunnelled <i>AlternateLinkOpenConf</i> message	<--	<i>DLInformationTransfer</i>	-	-
15	Check: Does the UE transmit an <i>ULInformationTransfer</i> containing a tunnelled <i>AlternateLinkOpenComplete</i> on Cell 2?	-->	<i>ULInformationTransfer</i>	-	-
16	Check: Does the UE perform Tunnelled PPP LCP negotiation to the SS on Cell 2? And is the EAP-AKA selected as the authentication protocol?	<-->	-	2	P
17	After entering PPP LCP Open State, optionally tunnelled PPP Version Capability Indication and/or Max PPP Inactivity Timer negotiation may take place.	<-->	-	-	-
18	Tunnelled EAP-AKA is performed between the UE and the SS.	<-->	-	-	-
19	Check: Does the UE transmits an <i>ULInformationTransfer</i> containing a tunnelled <i>VSNCP Configure-Request</i> message, including a PDN-ID, PDN Type, APN, PDN Address with the same as initial PDN setup, Protocol Configuration Options, and Attach Type = "handover"? The Address Allocation Preference option contained in the Protocol Configuration Options indicates whether the UE wants to perform the IP address allocation during the attach procedure or deferred IPv4 address allocation. PDN Type indicates the UE's IP capability (IPv4, IPv6 or IPv4/v6)	-->	<i>ULInformationTransfer</i>	3	P
20	The SS transmits a <i>DLInformationTransfer</i> containing a tunnelled <i>VSNCP Configure-Ack</i> message.	<--	<i>DLInformationTransfer</i>	-	-
21	The SS transmits a <i>DLInformationTransfer</i> containing a tunnelled <i>VSNCP Configure-Request</i> message including the PDN-ID configuration option.	<--	<i>DLInformationTransfer</i>	-	-
22	The UE transmits an <i>ULInformationTransfer</i> containing a tunnelled <i>VSNCP Configure-Ack</i> message on Cell 2.	-->	<i>ULInformationTransfer</i>	-	-
23	Optionally UE may transmit an <i>ULInformationTransfer</i> containing a tunnelled <i>DHCPv4 DISCOVER</i> (depending on the Address Allocation Preference indicated by the UE at Step 19).	-->	<i>ULInformationTransfer</i>	-	-

24	The UE transmits an <i>ULInformationTransfer</i> containing a tunnelled <i>AlternateLinkCloseReq</i> message on Cell 2.	-->	<i>ULInformationTransfer</i>	-	-
25	The SS transmits a <i>DLInformationTransfer</i> containing a tunnelled <i>AlternateLinkCloseConf</i> message.	<--	<i>DLInformationTransfer</i>	-	-
26	Optionally the UE may transmit an <i>ULInformationTransfer</i> containing a tunnelled <i>Router solicitation</i> message on Cell 2.	-->	<i>ULInformationTransfer</i>	-	-
27	The SS transmits an <i>RRCCConnectionRelease</i> message	<--	<i>RRCCConnectionRelease</i>	-	-
28	The UE transmits an <i>RRCCConnectionReleaseComplete</i> message on Cell 2.	-->	<i>RRCCConnectionReleaseComplete</i>	-	-

Table 13.4.4.4.3.2-3: *SystemInformationBlockType1* for cell 1

Derivation Path: 36.508 Table 4.4.3.2-3			
Information Element	Value/remark	Comment	Condition
<i>SystemInformationBlockType1</i> ::= SEQUENCE {			
<i>schedulingInformation</i> ::= SEQUENCE (SIZE (1..maxSI-Message)) OF SEQUENCE {	Combination 6 in TS 36.508 section 4.4.3.1	SIB2, SIB3 and SIB 8 are transmitted	
}			
}			

Table 13.4.4.4.3.2-4: *SystemInformationBlockType8* for cell 1

Derivation Path: 36.508 Table 4.4.3.3-7, condition HRPD			
Information Element	Value/remark	Comment	Condition
<i>SystemInformationBlockType8</i> ::= SEQUENCE {			
<i>parametersHRPD</i> SEQUENCE {			
<i>preRegistrationInfoHRPD</i> SEQUENCE {			
<i>preRegistrationAllowed</i>	TRUE		
<i>preRegistrationZoneld</i>	A valid value	INTEGER (0..255)	
<i>secondaryPreRegistrationZoneldList</i>	Not present		
SEQUENCE (SIZE (1..2)) OF SEQUENCE {			
<i>PreRegistrationZoneldHRPD</i>	Not present		
}			
}			
}			
<i>cellReselectionParametersHRPD</i> SEQUENCE {			
<i>bandClassList</i> SEQUENCE (SIZE (1..maxCDMA-BandClass)) OF SEQUENCE {	1 entry		
<i>bandClass</i>	Band class of frequency under test	ENUMERATED {bc0, bc1, bc2, bc3, bc4, bc5, bc6, bc7, bc8, bc9, bc10, bc11, bc12, bc13, bc14, bc15, bc16, bc17, spare14, spare13, spare12, spare11, spare10, spare9, spare8, spare7, spare6, spare5, spare4, spare3, spare2, spare1, ...}	
}			
}			
<i>cellReselectionPriority</i>	3		
<i>threshX-High</i>	30(-30)	INTEGER (0..63)	
<i>threshX-Low</i>	32(-32)	INTEGER (0..63)	
}			

Table 13.4.4.4.3.2-5: SystemInformationBlockType8 for cell 2

Derivation Path: 36.508 Table 4.4.3.3-7, condition HRPD			
Information Element	Value/remark	Comment	Condition
SystemInformationBlockType8 ::= SEQUENCE {			
parametersHRPD SEQUENCE {			
preRegistrationInfoHRPD SEQUENCE {			
preRegistrationAllowed	TRUE		
preRegistrationZoned	A valid value different from cell 1	INTEGER (0..255)	
secondaryPreRegistrationZonedList	Not present		
SEQUENCE (SIZE (1..2)) OF SEQUENCE {			
PreRegistrationZonedHRPD	Not present		
}			
}			
cellReselectionParametersHRPD SEQUENCE {			
bandClassList SEQUENCE (SIZE (1..maxCDMA-BandClass)) OF SEQUENCE {	1 entry		
bandClass	Band class of frequency under test	ENUMERATED {bc0, bc1, bc2, bc3, bc4, bc5, bc6, bc7, bc8, bc9, bc10, bc11, bc12, bc13, bc14, bc15, bc16, bc17, spare14, spare13, spare12, spare11, spare10, spare9, spare8, spare7, spare6, spare5, spare4, spare3, spare2, spare1, ...}	
}			
}			
cellReselectionPriority	3		
threshX-High	30(-30)	INTEGER (0..63)	
threshX-Low	32(-32)	INTEGER (0..63)	
}			

13.4.4.4.3.3 Specific message contents

Table 13.4.4.4.3.3-1: UATI Request message (Step 10, Table 13.4.4.4.3.2-2)

Field	Value/remark	Comment	Condition
SAPState	'0'B	SAP Header	
SessionConfigurationToken	16 bits, Set by UE		
ConnectionLayerFormat	1 bit, Set by UE		
ATI Record	34 bits, RATI set by UE		
Reserved	'0000'B		
MessageID	'00000000'B	UATI Request	this value shall be verified by TTCN
TransactionID	8 bits, Set by UE		

Table 13.4.4.4.3.3-2: UATI Assignment message (Step 11, Table 13.4.4.4.3.2-2)

Field	Value/remark	Comment	Condition
SAPState	'1'B	SAP Header	
SessionConfigurationToken	'0'		
ConnectionLayerFormat	1 bit, Set by SS		
ATI Record	34 bits, RATI set in UATI Request		
Reserved	'0000'B		
MessageID	'0000001'B	UATI Assignment	
MessageSequence	8 bits, Set by SS		
Reserved1	'0000000'B		
SubnetIncluded	'1'B		
UATISubnetMask	'1101000'B		
UATI104	104 bits, Set by SS		
UATIColorCode	8 bits, Set to ColorCode of Cell 15		
UATI024	24 bits, Set by SS		
UpperOldUATILength	'0000'B		
Reserved2	'0000'B		

13.4.4.5 Pre-Registration at 1xRTT / Power Down Registration

13.4.4.5.1 Test Purpose (TP)

(1)

```
with { UE in E-UTRA RRC_IDLE having completed the 1xRTT CS pre-registration procedure and having
detecting the cell ranked as the best cell and having received SIB 8 including powerDownReg-r9 on
the source cell }
ensure that {
  when { UE is switched off }
  then { UE transmits an ULInformationTransfer message containing a tunnelled 1xRTT GCSNA
Encapsulated Power-Down Registration message}
```

13.4.4.5.2 Conformance requirements

References: The conformance requirements covered in the present TC are specified in: TS 23.272, clause B.2.1.1 and B.2.1.3 and C.S0005-F v1.0, clause 2.6.5.1.2.

[TS 23.272, clause B.2.1.1 and B.2.1.3]

This clause describes how the UE in an E-UTRAN system establishes and maintains pre-registration in the 1xCS system.

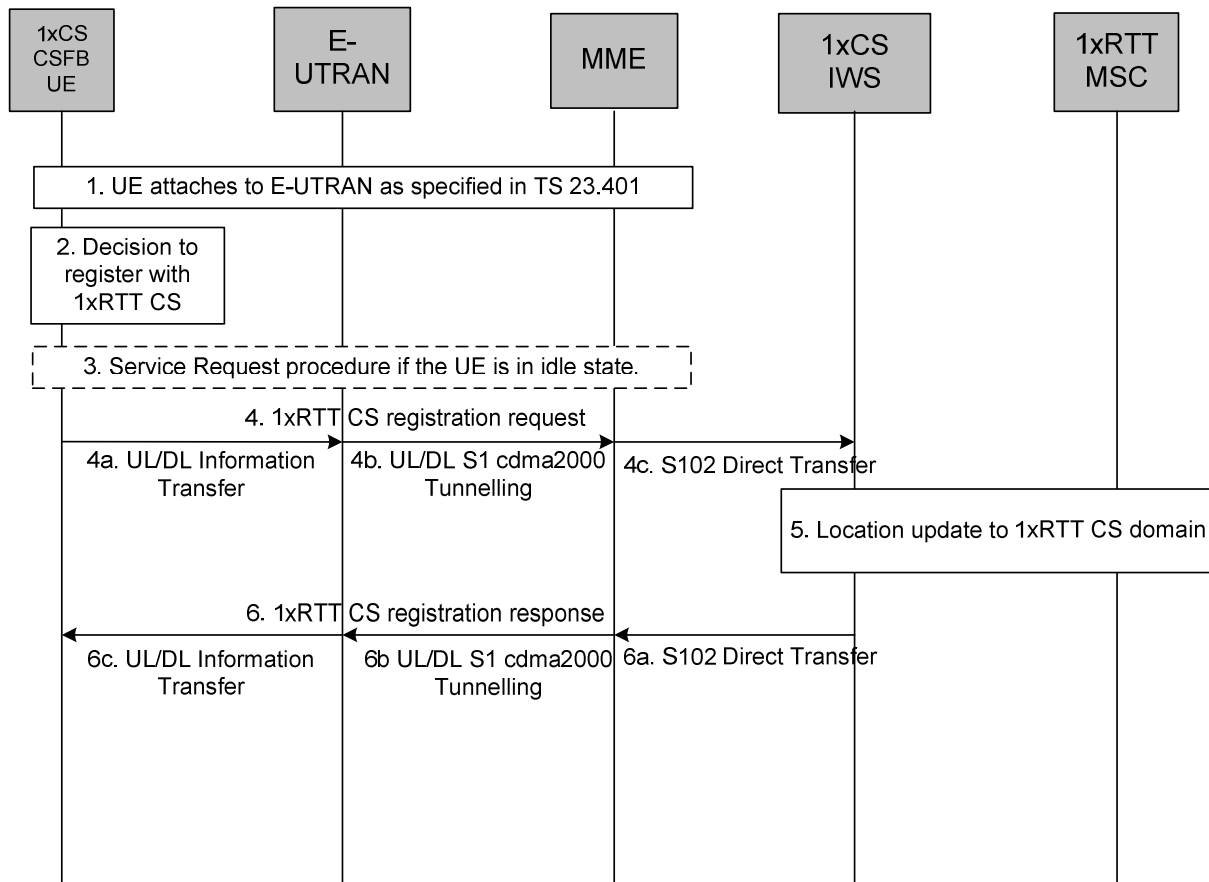

Figure B.2.1.1-1: 1xRTT CS registration procedure

1. The UE attaches to E-UTRAN as specified in TS 23.401 [2]. The UE includes an indication of enhanced CS fallback to 1xRTT and may also include concurrent 1xRTT and HRPD PS session handling capabilities as part of the UE radio capabilities.
2. Based on a radio layer trigger (e.g. an indication from the E-UTRAN when the UE is in connected state or an indication over the broadcast channel), the UE decides to register with the 1xRTT CS domain.
3. If the UE is in idle state, in order to create a signalling connection with the MME, it performs the Service Request procedure.
4. The UE generates a 1xRTT CS registration request.
 - 4a. The 1xRTT CS message is transferred from the UE to E-UTRAN.
 - 4b. E-UTRAN forwards the 1xRTT CS message to the MME including the CDMA2000 Reference Cell ID.
 - 4c. The MME selects a 1xCS IWS node based on the CDMA2000 Reference Cell ID. The IMSI is used to distinguish S102 signalling transactions belonging to different UEs. The MME sends a S102 Direct Transfer message (IMSI, 1xCS message) to the 1xCS IWS node.
5. 1xRTT CS registration is then performed by the 1xCS IWS node based on 3GPP2 A.S0008-C v4.0 [16].
 - 6a. 1xRTT CS registration response is tunnelled back to the MME in a S102 Direct Transfer message (IMSI, 1xCS message).
 - 6b. The MME forwards the 1xRTT CS message to the E-UTRAN.
 - 6c. The E-UTRAN forwards the 1xRTT CS message to the UE.

If the triggers for 1xCS registration change over time, the UE (both in idle or connected state), uses this information to update the 1xCS registration via the tunnel.

If a 1xRTT CS Fallback UE, pre-registered to the 1xRTT CS system, initiates the detach procedure in E-UTRAN access due to switch off and the UE is required to perform a "power-down registration" in the 1xRTT CS system (see C.S0005-F 1.0 [32]), the UE shall first perform the "power-down registration" procedure with the 1xRTT CS system via the S102 tunnel, before initiating the detach procedure in E-UTRAN access as specified in TS 23.401 [2]. A 1xCSF UE, pre-registered to the 1xCS system, performing detach due to reasons other than switch off is not required to perform "power-down registration" with the 1xCS system prior to performing the detach procedure in E-UTRAN.

[C.S0005-F v1.0, clause 2.6.5.1.2]

Power-down registration is performed when the user directs the mobile station to power off.

Power-down registration is performed, the mobile station does not power off until after completing the registration attempt.

13.4.4.5.3 Test description

13.4.4.5.3.1 Pre-test conditions

System Simulator:

- Cell 1.
- System information combination 6 as defined in TS 36.508 [18] clause 4.4.3.1 is used in E-UTRA cells.

UE:

None.

Preamble:

- the UE is in state Switched OFF (state 1) according to TS 36.508 [18].

13.4.4.5.3.2 Test procedure sequence

Table 13.4.4.5.3.2-1 illustrates the downlink power levels and other changing parameters to be applied for the cells at various time instants of the test execution. Row marked "T0" denotes the initial conditions. The exact instants on which these values shall be applied are described in the texts in this clause.

Table 13.4.4.5.3.2-1: Cell configuration changes over time

	Parameter	Unit	Cell 1	Remark
T0	Cell-specific RS EPRE	dBm/15kHz	-75	Srxlev _{Cell 1} > 0 such that camping on Cell 1 is guaranteed.
	I _{or} /I _{oc}	dB	-	
	Pilot Ec/I _{or}	dB	-	
	I _{oc}	dBm/1.23 MHz	-	
	Pilot Ec/I _o (Note 1)	dB	-	

Table 13.4.4.5.3.2-2: Main behaviour

St	Procedure	Message Sequence		TP	Verdict
		U - S	Message		
1-20	Steps 0 to 19 of the generic UE Registration, pre-registration on 1xRTT radio bearer establishment procedure (TS 36.508 4.5.2C.3-2) are executed to successfully complete the attach and pre-registration on 1xRTT procedure.				
21	If possible (see ICS) switch off is performed.	-	-	-	-
22-28	Steps 3 to 9 of the generic radio bearer establishment procedure (TS 36.508 4.5.3.3-1) are executed to successfully complete the service request procedure.	-	-	-	-
29	Check: Does the UE transmit an <i>ULInformationTransfer</i> containing a tunnelled <i>1xRTT GCSNA encapsulated Power-Down Registration</i> message on Cell 1.	-->	<i>ULInformationTransfer</i>	1	P
30	UE sends DETACH REQUEST message.	-->	DETACH REQUEST	-	-

13.4.4.5.3.3 Specific message contents

Table 13.4.4.5.3.3-1: SystemInformationBlockType8 for cell 1 (Step 2, Table 13.4.4.5.3.2-2)

Derivation Path: 36.508 Table 4.4.3.3-7, condition 1XRTT			
Information Element	Value/remark	Comment	Condition
SystemInformationBlockType8 ::= SEQUENCE {			
parameters1XRTT SEQUENCE {			
csfb-RegistrationParam1XRTT SEQUENCE {			
Sid	Same as cell 1	BIT STRING (SIZE (15))	
Nid	Same as cell 1	BIT STRING (SIZE (16))	
multipleSID	TRUE	BOOLEAN	
multipleNID	TRUE	BOOLEAN	
homeReg	TRUE	BOOLEAN	
foreignSIDReg	TRUE	BOOLEAN	
foreignNIDReg	TRUE	BOOLEAN	
parameterReg	TRUE	BOOLEAN	
powerUpReg	TRUE	BOOLEAN	
registrationPeriod	TRUE	BIT STRING (SIZE (7))	
registrationZone	A valid value different from cell 1	BIT STRING (SIZE (12))	
totalZone	'001'B	BIT STRING (SIZE (3))	
zoneTimer	'000'B or '001'B	BIT STRING (SIZE (3))	
}			
longCodeState1XRTT	A valid value, calculated and updated by the SS	BIT STRING (SIZE (42)) OPTIONAL	
}			
cellReselectionParameters1XRTT SEQUENCE {			
bandClassList SEQUENCE (SIZE (1..maxCDMA -BandClass)) OF SEQUENCE {	1 entry		
bandClass	Band class of Cell 19	ENUMERATED {bc0, bc1, bc2, bc3, bc4, bc5, bc6, bc7, bc8, bc9, bc10, bc11, bc12, bc13, bc14, bc15, bc16, bc17, spare14, spare13, spare12, spare11, spare10, spare9, spare8, spare7, spare6, spare5, spare4, spare3, spare2, spare1, ...}	
}			
cellReselectionPriority	3		
threshX-High	30(-30)	INTEGER (0..63)	
threshX-Low	32(-32)	INTEGER (0..63)	
}			
}			
csfb-RegistrationParam1XRTT-v920{			
powerDownReg-r9	TRUE		
}			
}			
}			

Table 13.4.4.5.3.3-2: *ULInformationTransfer* (Step 3, Table 13.4.4.5.3.2-2)

Derivation Path: 36.508 Table 4.6.1-25			
Information Element	Value/remark	Comment	Condition
ULInformationTransfer ::= SEQUENCE {			
criticalExtensions CHOICE {			
c1 CHOICE {			
ulInformationTransfer-r8 SEQUENCE {			
dedicatedInformationType CHOICE {			
dedicatedInfoCDMA2000-1XRTT	Set according to Table 8.4.7.7.3.3-4		
}			
}			
}			
}			
}			

Table 13.4.4.5.3.3-3: 1xRTT GCSNA Encapsulated Registration message (Step 11, Table 13.4.4.5.3.2-2)

Information Element			
MessageID	'00000001'B	GCSNA1xCircuit Service message	
GCSNAOption	'00000001'B		
AlternativeGCSNAOption_INCL	'0'B		
IWSIDIncl	'0'B		
AckRequired	'1'B		
StopDupDetect	'0'B		
MessageSequence	Set by UE		
NumTLACEncapsulated1xL3PDU	'00'B		
Reserved	'0000'B		
1xLogicalChannel	'0'B		
1xProtocolRevision	'00000110'B		
MsgType	'00000001'B	Registration message	this value shall be verified by TTCN
NumTLACHeaderRecords	'0001'B		
TLACHeaderRecordType	'0000'B		
TLACHeaderRecordLength	8 bits, Set by UE		
MSID_TYPE	'011'B		
MSID_LEN	4 bits, Set by UE		
MSID	Variable, Set by UE		
Reserved	'0000000'B		
1xL3PDULength	16 bits, Set by UE		
REG_TYPE	'0011'B	Power-Down Registration	this value shall be verified by TTCN
SLOT_CYCLE_INDEX	'010'B		
MOB_P_REV	8 bits, Set by UE		
SCM	8 bits, Set by UE		
MOB_TERM	'1'B		
RETURN_CAUSE	'1'B		
QPCH_SUPPORTED	'1'B		
ENHANCED_RC	'1'B		
UZID_INCL	'0'B		

14 ETWS

14.1 ETWS reception in RRC_IDLE state / Duplicate detection

14.1.1 Test Purpose (TP)

(1)

```
with { UE in RRC_IDLE state and follow the reception of Paging message with etws-Indication }
ensure that {
  when { UE start to acquire ETWS message from SIB10 and SIB11 }
  then { UE successfully received the ETWS message and activated the "User Alerting" popup display }
}
```

14.1.2 Conformance requirements

References: The conformance requirements covered in the present TC are specified in: TS 36.331, clauses 5.2.2.4, 5.2.2.17, 5.2.2.18, 5.3.2.3; TS 23.041 clause 9.1.2.

[TS 36.331, clause 5.2.2.4]

The UE shall:

...

1> if the UE is ETWS capable:

2> upon entering a cell during RRC_IDLE, following successful handover or upon connection re-establishment:

3> discard any previously buffered *warningMessageSegment*;

3> clear, if any, the current values of *messageIdentifier* and *serialNumber* for *SystemInformationBlockType11*;

2> when the UE acquires *SystemInformationBlockType1* following ETWS indication, upon entering a cell during RRC_IDLE, following successful handover or upon connection re-establishment:

3> if *schedulingInfoList* indicates that *SystemInformationBlockType10* is present:

4> start acquiring *SystemInformationBlockType10* immediately;

3> if *schedulingInfoList* indicates that *SystemInformationBlockType11* is present:

4> start acquiring *SystemInformationBlockType11* immediately;

NOTE 2: UEs shall start acquiring *SystemInformationBlockType10* and *SystemInformationBlockType11* as described above even when *systemInfoValueTag* in *SystemInformationBlockType1* has not changed.

[TS 36.331, clause 5.2.2.17]

Upon receiving *SystemInformationBlockType10*, the UE shall:

1> forward the received *warningType*, *warningSecurityInfo* (if present), *messageIdentifier* and *serialNumber* to upper layers;

[TS 36.331, clause 5.2.2.18]

Upon receiving *SystemInformationBlockType11*, the UE shall:

1> if there is no current value for *messageIdentifier* and *serialNumber* for *SystemInformationBlockType11*; or

1> if either the received value of *messageIdentifier* or of *serialNumber* or of both are different from the current values of *messageIdentifier* and *serialNumber* for *SystemInformationBlockType11*:

2> use the received values of *messageIdentifier* and *serialNumber* for *SystemInformationBlockType11* as the current values of *messageIdentifier* and *serialNumber* for *SystemInformationBlockType11*;

- 2> discard any previously buffered *warningMessageSegment*;
- 2> if all segments of a warning message have been received:
 - 3> assemble the *warningMessage* from the received *warningMessageSegment*;
 - 3> forward the received *warningMessage*, *messageIdentifier*, *serialNumber* and *dataCodingScheme* to upper layers;
 - 3> stop reception of *SystemInformationBlockType11*;
 - 3> discard the current values of *messageIdentifier* and *serialNumber* for *SystemInformationBlockType11*;
- 2> else:
 - 3> store the received *warningMessageSegment*;
 - 3> continue reception of *SystemInformationBlockType11*;
- 1> else if all segments of a warning message have been received:
 - 2> assemble the *warningMessage* from the received *warningMessageSegment*;
 - 2> forward the received complete *warningMessage*, *messageIdentifier*, *serialNumber* and *dataCodingScheme* to upper layers;
 - 2> stop reception of *SystemInformationBlockType11*;
 - 2> discard the current values of *messageIdentifier* and *serialNumber* for *SystemInformationBlockType11*;
- 1> else:
 - 2> store the received *warningMessageSegment*;
 - 2> continue reception of *SystemInformationBlockType11*;

[TS 36.331, clause 5.3.2.3]

Upon receiving the *Paging* message, the UE shall:

...

- 1> if the *etws-Indication* is included and the UE is ETWS capable:
 - 2> re-acquire *SystemInformationBlockType1* immediately, i.e., without waiting until the next system information modification period boundary;
 - 2> if the *schedulingInfoList* indicates that *SystemInformationBlockType10* is present:
 - 3> acquire *SystemInformationBlockType10*;
 - 2> if the *schedulingInfoList* indicates that *SystemInformationBlockType11* is present:
 - 3> acquire *SystemInformationBlockType11*;

[TS 23.041, clause 9.1.2]

...

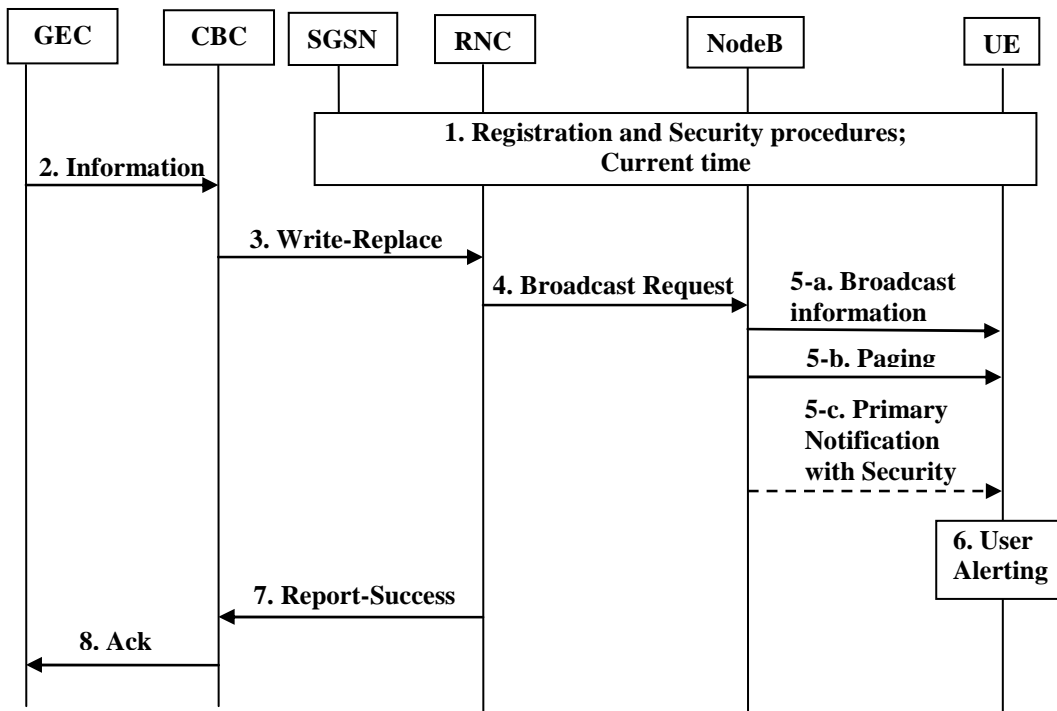

Figure 4b

...

6. The UE alert the user immediately, using "warning type" value,

- upon the reception of the paging message, if the UE has been configured to receive ETWS warnings over the paging message, and the UE has authenticated the core network of the NodeB it is camped on, or
- if the UE has not been configured to receive ETWS warnings over the paging message, and it received the optional primary notification and security checks based on "timestamp" and "digital signature" for this notification passed.

NOTE: If the UE received the ETWS warnings over the paging and also received the optional primary notification, it will silently discard the optional primary notification.

NOTE: When the "warning type" is 'test', the UE silently discards the paging message, and the optional primary notification, and do not perform the reception of the broadcast message described below. However, the UE specially designed for testing purposes may perform user alerting described above and proceed to the reception of the broadcast message described below

NOTE: If the UE has been configured to receive ETWS warnings over paging message but it has not authenticated the core network of the NodeB it is camped on, the UE does not receive the paging message and the optional primary notification, and do not perform the reception of the broadcast message described below.

Upon the reception of the paging message, whether the UE is configured to receive ETWS warnings over paging message or not, the UE activates the reception of the broadcast messages containing the "warning message" as the secondary notification, as follows:

- If both the "digital signature" and "timestamp" are present in the "warning message" and security checks fail, then the UE notifies the user of this fact and stops the user alerting.
- If both the "digital signature" and "timestamp" are present and security checks pass, then the UE indicates the contents of the "warning message" to the user along with an indication that the message has been authenticated.

- In other cases, the UE indicates the contents of the "warning message" to the user along with an indication that the message has not been authenticated.

Unless both the "digital signature" and "timestamp" are present and the security checks pass, the UE shall ignore the message, return to normal idle mode, and ignore paging messages with the "ETWS indication" for the next [X] seconds.

NOTE: Repetition period [X] is subject to regulatory requirements.

The UE shall consider a message duplicated if the combination of "message identifier" and "serial number" matches that of the previous message received from the same PLMN. The UE shall ignore messages detected as duplicated. If both the "digital signature" and "timestamp" are present, the UE shall perform security check before duplicate message detection. Duplicate message detection shall be performed independently for primary and secondary notifications.

- The RNC node sends a BMC REPORT-SUCCESS to the CBC in response to Write-Replace.
- CBC sends acknowledgement message to CBE.

14.1.3 Test description

14.1.3.1 Pre-test conditions

System Simulator:

- Cell 1

UE:

None.

Preamble:

- The UE is in state Registered, Idle mode (state 2) according to [18].

14.1.3.2 Test procedure sequence

Table 14.1.3.2-1: Main behaviour

St	Procedure	Message Sequence		TP	Verdict
		U - S	Message		
1	The SS include an ETWS message with new <i>messageIdentifier</i> and <i>serialNumber</i> in <i>SystemInformationBlockType10</i> and <i>SystemInformationBlockType11</i> and transmit a <i>Paging</i> message including <i>etws-Indication</i> on Cell 1 (NOTE1).	<--	<i>Paging</i>	-	-
2	Check: Does the UE indicate the contents of the "warning message" to the user, and alert or activate alerting the user (NOTE2)?	-	-	1	P
3	The SS wait for 10s.	-	-	-	-
4	The SS include an ETWS message with same <i>messageIdentifier</i> and <i>serialNumber</i> in <i>SystemInformationBlockType10</i> and <i>SystemInformationBlockType11</i> and transmit a <i>Paging</i> message including <i>etws-Indication</i> on Cell 1 (NOTE1).	<--	<i>Paging</i>	-	-
5	Check: Does the UE indicate the contents of the "warning message" to the user, or alert or activate alerting the user. (NOTE2)?	-	-	1	F
NOTE1: <i>SystemInformationBlockType11</i> contain 3 segments.					
NOTE2: The data indication and user alerting are the UE implementation issues.					

14.1.3.3 Specific message contents

Table 14.1.3.3-1: SystemInformationBlockType1 for Cell 1 (all steps, Table 14.1.3.2-1)

Derivation Path: 36.508 table 4.4.3.2-3			
Information Element	Value/remark	Comment	Condition
SystemInformationBlockType1 ::= SEQUENCE {			
schedulingInformation ::= SEQUENCE (SIZE (1..maxSI-Message)) OF SEQUENCE {}	Combination 8 in TS 36.508 section 4.4.3.1	SIB2, SIB3, SIB10 and SIB11 are transmitted	
}			

Table 14.1.3.3-2: Void

Table 14.1.3.3-3: Void

Table 14.1.3.3-4: Void

Table 14.1.3.3-5: Void

Table 14.1.3.3-6: Paging (step 1 and step 4, Table 14.1.3.2-1)

Derivation Path: 36.508 Table 4.6.1-7			
Information Element	Value/remark	Comment	Condition
Paging ::= SEQUENCE {			
pagingRecordList	Not present		
systemInfoModification	Not present		
etws-Indication	true		
nonCriticalExtension SEQUENCE {}	Not present		
}			

14.2 ETWS reception in RRC_CONNECTED state / Duplicate detection

14.2.1 Test Purpose (TP)

(1)

```

with { UE in RRC_CONNECTED state and follow the reception of Paging message with etws-Indication }
ensure that {
  when { UE start to acquire ETWS message from SIB10 and SIB11 }
  then { UE successfully received the ETWS message and activated the "User Alerting" popup display }
}

```

14.2.2 Conformance requirements

References: The conformance requirements covered in the present TC are specified in: TS 36.331, clauses 5.2.2.4, 5.2.2.17, 5.2.2.18, 5.3.2.3; TS 23.041 clause 9.1.2.

[TS 36.331, clause 5.2.2.4]

The UE shall:

...

1> if the UE is ETWS capable:

- 2> upon entering a cell during RRC_IDLE, following successful handover or upon connection re-establishment:
 - 3> discard any previously buffered *warningMessageSegment*;
 - 3> clear, if any, the current values of *messageIdentifier* and *serialNumber* for *SystemInformationBlockType11*;
- 2> when the UE acquires *SystemInformationBlockType1* following ETWS indication, upon entering a cell during RRC_IDLE, following successful handover or upon connection re-establishment:
 - 3> if *schedulingInfoList* indicates that *SystemInformationBlockType10* is present:
 - 4> start acquiring *SystemInformationBlockType10* immediately;
 - 3> if *schedulingInfoList* indicates that *SystemInformationBlockType11* is present:
 - 4> start acquiring *SystemInformationBlockType11* immediately;

NOTE 2: UEs shall start acquiring *SystemInformationBlockType10* and *SystemInformationBlockType11* as described above even when *systemInfoValueTag* in *SystemInformationBlockType1* has not changed.

[TS 36.331, clause 5.2.2.17]

Upon receiving *SystemInformationBlockType10*, the UE shall:

- 1> forward the received *warningType*, *warningSecurityInfo* (if present), *messageIdentifier* and *serialNumber* to upper layers;

[TS 36.331, clause 5.2.2.18]

Upon receiving *SystemInformationBlockType11*, the UE shall:

- 1> if there is no current value for *messageIdentifier* and *serialNumber* for *SystemInformationBlockType11*; or
- 1> if either the received value of *messageIdentifier* or of *serialNumber* or of both is different from the current values of *messageIdentifier* and *serialNumber* for *SystemInformationBlockType11*:
 - 2> use the received values of *messageIdentifier* and *serialNumber* for *SystemInformationBlockType11* as the current values of *messageIdentifier* and *serialNumber* for *SystemInformationBlockType11*;
 - 2> discard any previously buffered *warningMessageSegment*;
 - 2> if all segments of a warning message have been received:
 - 3> assemble the *warningMessage* from the received *warningMessageSegment*;
 - 3> forward the received *warningMessage*, *messageIdentifier*, *serialNumber* and *dataCodingScheme* to upper layers;
 - 3> stop reception of *SystemInformationBlockType11*;
 - 3> discard the current values of *messageIdentifier* and *serialNumber* for *SystemInformationBlockType11*;
 - 2> else:
 - 3> store the received *warningMessageSegment*;
 - 3> continue reception of *SystemInformationBlockType11*;
- 1> else if all segments of a warning message have been received:
 - 2> assemble the *warningMessage* from the received *warningMessageSegment*;
 - 2> forward the received complete *warningMessage*, *messageIdentifier*, *serialNumber* and *dataCodingScheme* to upper layers;
 - 2> stop reception of *SystemInformationBlockType11*;
 - 2> discard the current values of *messageIdentifier* and *serialNumber* for *SystemInformationBlockType11*;

1> else:

- 2> store the received *warningMessageSegment*;
- 2> continue reception of *SystemInformationBlockType11*;

[TS 36.331, clause 5.3.2.3]

Upon receiving the *Paging* message, the UE shall:

...

1> if the *etws-Indication* is included and the UE is ETWS capable:

- 2> re-acquire *SystemInformationBlockType1* immediately, i.e., without waiting until the next system information modification period boundary;
- 2> if the *schedulingInfoList* indicates that *SystemInformationBlockType10* is present:
 - 3> acquire *SystemInformationBlockType10*;
- 2> if the *schedulingInfoList* indicates that *SystemInformationBlockType11* is present:
 - 3> acquire *SystemInformationBlockType11*;

[TS 23.041, clause 9.1.2]

...

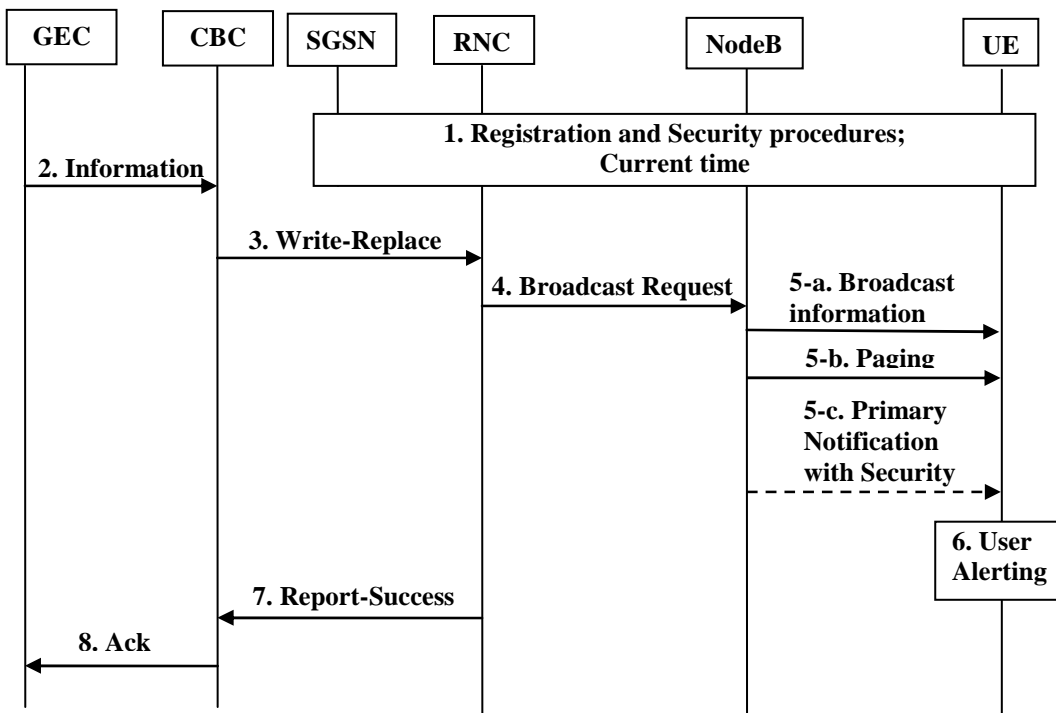

Figure 4b

...

6. The UE alert the user immediately, using "warning type" value,

- upon the reception of the paging message, if the UE has been configured to receive ETWS warnings over the paging message, and the UE has authenticated the core network of the NodeB it is camped on, or

- if the UE has not been configured to receive ETWS warnings over the paging message, and it received the optional primary notification and security checks based on "timestamp" and "digital signature" for this notification passed.

NOTE: If the UE received the ETWS warnings over the paging and also received the optional primary notification, it will silently discard the optional primary notification.

NOTE: When the "warning type" is 'test', the UE silently discards the paging message, and the optional primary notification, and do not perform the reception of the broadcast message described below. However, the UE specially designed for testing purposes may perform user alerting described above and proceed to the reception of the broadcast message described below

NOTE: If the UE has been configured to receive ETWS warnings over paging message but it has not authenticated the core network of the NodeB it is camped on, the UE does not receive the paging message and the optional primary notification, and do not perform the reception of the broadcast message described below.

Upon the reception of the paging message, whether the UE is configured to receive ETWS warnings over paging message or not, the UE activates the reception of the broadcast messages containing the "warning message" as the secondary notification, as follows:

- If both the "digital signature" and "timestamp" are present in the "warning message" and security checks fail, then the UE notifies the user of this fact and stops the user alerting.
- If both the "digital signature" and "timestamp" are present and security checks pass, then the UE indicates the contents of the "warning message" to the user along with an indication that the message has been authenticated.
- In other cases, the UE indicates the contents of the "warning message" to the user along with an indication that the message has not been authenticated.

Unless both the "digital signature" and "timestamp" are present and the security checks pass, the UE shall ignore the message, return to normal idle mode, and ignore paging messages with the "ETWS indication" for the next [X] seconds.

NOTE: Repetition period [X] is subject to regulatory requirements.

The UE shall consider a message duplicated if the combination of "message identifier" and "serial number" matches that of the previous message received from the same PLMN. The UE shall ignore messages detected as duplicated. If both the "digital signature" and "timestamp" are present, the UE shall perform security check before duplicate message detection. Duplicate message detection shall be performed independently for primary and secondary notifications.

7. The RNC node sends a BMC REPORT-SUCCESS to the CBC in response to Write-Replace.

8. CBC sends acknowledgement message to CBE.

14.2.3 Test description

14.2.3.1 Pre-test conditions

System Simulator:

- Cell 1

UE:

None.

Preamble:

- The UE is in state Generic RB Established (state 3) according to [18].

14.2.3.2 Test procedure sequence

Table 14.2.3.2-1: Main behaviour

St	Procedure	Message Sequence		TP	Verdict
		U - S	Message		
1	The SS include an ETWS message with new <i>messageIdentifier</i> and <i>serialNumber</i> in <i>SystemInformationBlockType10</i> and <i>SystemInformationBlockType11</i> and transmit a <i>Paging</i> message including <i>etws-Indication</i> on Cell 1 (NOTE1).	<--	<i>Paging</i>	-	-
2	Check: Does the UE indicate the contents of the "warning message" to the user, and alert or activate alerting the user (NOTE2)?	-	-	1	P
3	The SS wait for 10s.	-	-	-	-
4	The SS include an ETWS message with same <i>messageIdentifier</i> and <i>serialNumber</i> in <i>SystemInformationBlockType10</i> and <i>SystemInformationBlockType11</i> and transmit a <i>Paging</i> message including <i>etws-Indication</i> on Cell 1 (NOTE1).	<--	<i>Paging</i>	-	-
5	Check: Does the UE indicate the contents of the "warning message" to the user, or alert or activate alerting the user (NOTE2)?	-	-	1	F

NOTE1: *SystemInformationBlockType11* contain 3 segments.
 NOTE2: The data indication and user alerting are the UE implementation issues.

14.2.3.3 Specific message contents

Table 14.2.3.3-1: SystemInformationBlockType1 for Cell 1 (all steps, Table 14.2.3.2-1)

Derivation Path: 36.508 table 4.4.3.2-3			
Information Element	Value/remark	Comment	Condition
SystemInformationBlockType1 ::= SEQUENCE {			
schedulingInformation ::= SEQUENCE (SIZE (1..maxSI-Message)) OF SEQUENCE {	Combination 8 in TS 36.508 section 4.4.3.1	SIB2, SIB3, SIB10 and SIB11 are transmitted	
}			

Table 14.2.3.3-2: Void

Table 14.2.3.3-3: Void

Table 14.2.3.3-4: Void

Table 14.2.3.3-5: Void

Table 14.2.3.3-6: *Paging* (step 1 and step 4, Table 14.2.3.2-1)

Derivation Path: 36.508 Table 4.6.1-7			
Information Element	Value/remark	Comment	Condition
Paging ::= SEQUENCE {			
pagingRecordList	Not present		
systemInfoModification	Not present		
etws-Indication	true		
nonCriticalExtension SEQUENCE {}	Not present		
}			

14.3 Void

15 Mobility management based on DSMIPv6 (Dual-Stack Mobile IPv6)

15.1 Discovery of the home agent via DNS

15.1.1 Test Purpose (TP)

(1)

```
with { UE has acquired an IP address and UE is configured with a DNS server address and UE is
configured with the HA-APN Network Identifier }
ensure that {
  when { UE is configured to discover IP address of Home Agent via DNS }
  then { UE transmits a DNS Query with QNAME set to FQDN of the Home Agent }
}
```

15.1.2 Conformance requirements

References: The conformance requirements covered in the present TC are specified in: TS 24.303, clauses 5.1.2.1.1 and 5.1.2.1.2.

[TS 24.303, clause 5.1.2.1.1]

The first procedure the UE needs to perform for DSMIPv6 initial attach is the discovery of the node acting as the HA.

The UE can discover the IP addresses of the HA in one of the four following ways:

- via DNS;
- via attach procedure for 3GPP access or trusted non-3GPP access (if supported) based on protocol configuration options;
- via IKEv2 during tunnel setup to ePDG for untrusted non-3GPP accesses;
- via DHCPv6.

If the UE does not obtain the IP addresses of the HA via PCO during the 3GPP or trusted non-3GPP (if supported) attach or via IKEv2 signalling, it shall follow either the procedures described in subclause 5.1.2.1.5 or the procedures described in subclause 5.1.2.1.2. The UE may be configured to perform both procedures in parallel or one of the two procedures only in case the other failed.

[TS 24.303, clause 5.1.2.1.2]

A UE performing Home Agent discovery based on DNS shall support the implementation of standard DNS mechanisms.

The UE shall perform DNS Lookup by Home Agent Name as specified in IETF RFC 5026 [10]. The QNAME shall be set to the requested HA-APN. The HA-APN shall be constructed as specified in 3GPP TS 23.003 [17]. If a HA has both an IPv4 and an IPv6 address, the corresponding DNS record should be configured with both 'AAAA' and 'A' records.

Accordingly the UE should perform one DNS lookup procedure to retrieve both 'AAAA' and 'A' records. The DNS server replies with one 'AAAA' and one 'A' record.

15.1.3 Test description

15.1.3.1 Pre-test conditions

System Simulator:

- Cell 1.

UE:

- The UE is configured to discover the Home Agent address via DNS.
- The UE is configured with a DNS server address.
- The UE is configured with the HA-APN Network Identifier.

Preamble:

- The UE is in state Registered, Idle Mode (state 2) on Cell 1 according to [18].
- The UE has acquired an IP address.

15.1.3.2 Test procedure sequence

Table 15.1.3.2-1: Main behaviour

St	Procedure	Message Sequence		TP	Verdict
		U - S	Message		
1	The UE transmits a DNS Query message with QNAME set to FQDN of the Home Agent (derived from HA-APN Network Identifier and PLMN information).	-->	DNS Query	1	P
2	The SS transmits a DNS Response message with the IPv6 and IPv4 addresses of the Home Agent.	<--	DNS Response	-	-

15.1.3.3 Specific message contents

Table 15.1.3.3-1: Message DNS Query (step 1, Table 15.1.3.2-1)

Field	Value/remark	Comment	Condition
QR=	'0'	query	
OPCODE=	'0000'	QUERY	
QNAME=	Fully Qualified Domain Name of the Home Agent	Derived from HA-APN Network Identifier and PLMN information as per TS 23.003 clause 21.2	
QTYPE=	A	This is the query for the IPv4 address	
QCLASS=	IN		
QNAME=	Fully Qualified Domain Name of the Home Agent	Derived from HA-APN Network Identifier and PLMN information as per TS 23.003 clause 21.2	
QTYPE=	AAAA	This is the query for the IPv6 address	
QCLASS=	IN		

Table 15.1.3.3-2: Message DNS Response (step 2, Table 15.1.3.2-1)

Information Element	Value/remark	Comment	Condition
QR=	'1'	response	
OPCODE=	'0000'	QUERY	
QNAME=	Same as received in DNS Query		
QTYPE=	A		
QCLASS=	IN		
QNAME=	Same as received in DNS Query		
QTYPE=	AAAA		
QCLASS=	IN		
RR {			
NAME	Same as received in DNS Query		
TYPE	A		
CLASS	IN		
RDATA	IPv4 address of HA		
}			
RR {			
NAME	Same as received in DNS Query		
TYPE	AAAA		
CLASS	IN		
RDATA	IPv6 address of HA		
}			

15.2 Discovery of the Home Agent via DHCP

15.2.1 Test Purpose (TP)

(1)

```

with { UE has acquired an IP address and UE is configured with the HA-APN Network Identifier }
ensure that {
  when { UE is configured to discover IP address of Home Agent via DHCP }
  then { UE transmits a DHCP Information-Request with Home Network Identifier Option containing
the FQDN of the Home Agent }
}

```

15.2.2 Conformance requirements

References: The conformance requirements covered in the present TC are specified in: TS 24.303, clauses 5.1.2.1.1 and 5.1.2.1.5.

[TS 24.303, clause 5.1.2.1.1]

The first procedure the UE needs to perform for DSMIPv6 initial attach is the discovery of the node acting as the HA.

The UE can discover the IP addresses of the HA in one of the four following ways:

- via DNS;
- via attach procedure for 3GPP access or trusted non-3GPP access (if supported) based on protocol configuration options;
- via IKEv2 during tunnel setup to ePDG for untrusted non-3GPP accesses;
- via DHCPv6.

If the UE does not obtain the IP addresses of the HA via PCO during the 3GPP or trusted non-3GPP (if supported) attach or via IKEv2 signalling, it shall follow either the procedures described in subclause 5.1.2.1.5 or the procedures described in subclause 5.1.2.1.2. The UE may be configured to perform both procedures in parallel or one of the two procedures only in case the other failed.

[TS 24.303, clause 5.1.2.1.5]

The HA address discovery via DHCPv6 is possible in the following cases:

- in 3GPP access, or
- in trusted non-3GPP access, when a DHCPv6 relay exists in the trusted non-3GPP access and the PDN GW is the DHCPv6 server, or
- in trusted non-3GPP access, when the DHCPv6 server is in the trusted non-3GPP access and it has the HA addressee information from static configuration, or received via STa reference point as specified in 3GPP TS 29.273 [20].

A UE performing HA discovery based on DHCPv6 shall support the implementation of stateless DHCPv6 as specified in IETF RFC 3736 [13] and the DHCPv6 options as specified in draft-ietf-mip6-hiopt [12].

In order to discover the address of the HA the UE shall send an Information-Request message including the Home Network Identifier Option.

In order to connect to a HA for a specific target PDN, the UE shall set the id-type to 1 and include the desired HA-APN in the Home Network Identifier field.

The HA information is provided to the UE within a Home Network Information Option as described in draft-ietf-mip6-hiopt [12]. This option shall include either the available HA addresses (both the IPv6 address and the IPv4 address of the HA, if available) or the HA FQDN. In the latter case the UE shall perform a DNS Lookup by Home Agent Name as specified in IETF RFC 5026 [10]. The QNAME shall be set to the received HA FQDN.

If a HA has both an IPv4 and an IPv6 address, the corresponding DNS record should be configured with both 'AAAA' and 'A' records. Accordingly the UE should perform one DNS lookup procedure to retrieve both 'AAAA' and 'A' records. The DNS server replies with one 'AAAA' and one 'A' record.

15.2.3 Test description

15.2.3.1 Pre-test conditions

System Simulator:

- Cell 1.

UE:

- The UE is configured to discover the address of the Home Agent via DHCPv6.
- The UE is configured with the HA-APN Network Identifier.

Preamble:

- The UE is in state Registered, Idle Mode (state 2) on Cell 1 according to [18].
- The UE has acquired an IPv6 address.

15.2.3.2 Test procedure sequence

Table 15.2.3.2-1: Main behaviour

St	Procedure	Message Sequence		TP	Verdict
		U - S	Message		
1	Check: Does the UE transmit a DHCP Information-Request including a Home Network Information Option?	-->	DHCP Information-Request	1	P
2	The SS transmits a DHCP Reply message including a Home Network Information Option.	<--	DHCP Reply message	-	-

15.2.3.3 Specific message contents

Table 15.2.3.3-1: DHCP Information-Request (step 1, Table 15.2.3.2-1)

Field	Value/remark	Comment	Condition
msg-type	'00001011'B	Information-Request	
Transaction- id	Set by UE		
option-code	'0000000000000001'B	Option Client ID	
DUID	Set by UE		
option-code	'0000000000000110'B	Option ORO	
Requested-option-code-1	FFS	Home Network Identifier Option	
Id-type	'00000001'B	Target network identity present	
Sub-opt-code	'00000001'B	Home network identifier	
Home Network Parameter	Fully Qualified Domain Name	Derived from HA-APN Network Identifier and PLMN information as per TS 23.003 clause 21.2	

Table 15.2.3.3-2: DHCP Reply message (step 2, Table 15.2.3.2-2)

Field	Value/remark	Comment	Condition
msg-type	'00000111'B	Reply	
Transaction- id	Set as the same value of Transaction-id in step 1		
option-code	'0000000000000001'B	Option Client ID	
DUID	Set as the DUID of the client received in step 1		
option-code	'0000000000000010'B	Option Server ID	
DUID	Set by SS		
Home Network Identifier Option	FFS	Home Network Identifier Option	
Id-type	'00000001'B	Target network identity present	
Sub-opt-code	'00000001'B	Home network identifier	
Home Network Parameter	Fully Qualified Domain Name	Derived from HA-APN Network Identifier and PLMN information as per TS 23.003 clause 21.2	
Sub-opt-code	'00000011'B	IPv6 address	
Home Network Parameter	IPv6 address of the Home Agent		
Sub-opt-code	'00000100'B	IPv4 address (optional value)	
Home Network Parameter	IPv4 address of the Home Agent		

15.3 Void

15.4 Security association establishment with Home Agent reallocation procedure

15.4.1 Test Purpose (TP)

(1)

```
with { UE has acquired an IP address }
ensure that {
  when { UE has acquired the IP address of the Home Agent }
  then { UE transmits an IKE_SA_INIT message addressed to the Home Agent to initiate security
association establishment }
}
```

(2)

```
with { UE has transmitted an IKE_SA_INIT message addressed to the Home Agent to initiate security
association establishment }
ensure that {
  when { UE receives an IKE_SA_INIT response message }
  then { UE transmits an IKE_AUTH Request message containing the configuration payload
MIP6_HOME_PREFIX to receive the prefix to use for Home Address configuration }
}
```

(3)

```
with { UE has transmitted an IKE_AUTH Request message containing the configuration payload
MIP6_HOME_PREFIX to receive the prefix to use for Home Address configuration }
ensure that {
  when { UE receives an IKE_AUTH Response message including an EAP-Request/AKA Challenge }
  then { UE transmits an IKE_AUTH Request message containing the correct EAP-Response/AKA-
Challenge }
}
```

(4)

```
with { UE has transmitted an IKE_AUTH Request message containing an EAP-Response/AKA-Challenge }
ensure that {
  when { UE receives an IKE_AUTH Response message including EAP-Success }
  then { UE transmits an IKE_AUTH Request message with Authentication payload }
}
```

(5)

```
with { UE has transmitted an IKE_AUTH Request message with Authentication payload }
ensure that {
  when { UE receives an IKE_AUTH Response message with Notify payload with a REDIRECT attribute
containing the HOME AGENT address to connect to }
  then { UE transmits an IKE_SA_INIT message addressed to the Home Agent whose address was
received in the Notify Payload to initiate security association establishment }
}
```

15.4.2 Conformance requirements

References: The conformance requirements covered in the present TC are specified in: TS 24.303, clauses 5.1.2.2 and 5.1.3.1.

[TS 24.303, clause 5.1.2.2]

The UE shall support the IKEv2 protocol (see IETF RFC 4306 [14]) for negotiating the IPsec security association to secure DSMIPv6 signalling and shall support EAP over IKEv2 as described in IETF RFC 4306 [14] to perform authentication with an AAA server. In a case an additional authentication and authorization of the IPsec security association is needed with an external AAA server, then the additional authentication steps during the IKEv2 exchange shall be supported as specified in IETF RFC 4739 [23] and described in 3GPP TS 33.234 [24].

The UE shall support IPsec ESP (see IETF RFC 4303 [11]) in order to provide authentication of Binding Update and Binding Acknowledgement messages as specified in IETF RFC 4877 [4]. The UE shall support multiple authentication exchanges in the IKEv2 protocol as specified in IETF RFC 4739 [23] in order to support authentication with an external AAA server. The UE shall support the redirect mechanism as defined in draft-ietf-ipsecme-ikev2-redirect [30].

The UE shall initiate the security association establishment procedure by sending the IKE_SA_INIT request message defined in IETF RFC 4306 [14] to the HA. The UE shall indicate support for the HA reallocation by including a REDIRECT_SUPPORTED payload in the IKE_SA_INIT request as specified in draft-ietf-ipsecme-ikev2-redirect [30]. On receipt of an IKE_SA_INIT response, the UE shall send an IKE_AUTH request message including the MN-NAI in the IDi payload and the Access Point Name (APN) of the target PDN the UE wants to connect to in the IDr payload. The APN shall be formatted as defined in 3GPP TS 23.003 [17]. The username part of the MN-NAI included in "IDi" payload may be an IMSI, pseudonym or re-authentication ID. The UE shall include in the IDi payload the same MN-NAI it includes in the EAP-Response/Identity within the EAP-AKA exchange.

In the very first EAP-Response/Identity within the IKEv2 exchange the UE shall include a NAI whose username is derived from IMSI. In subsequent exchanges the UE should use pseudonyms and re-authentication identities provided by the 3GPP AAA server as specified in IETF RFC 4187 [26].

NOTE: Fast re-authentication mechanism is optional, and therefore is an implementation option in the UE and operator configuration issue (i.e. it also depends on whether the AAA server sent a re-authentication ID during previous EAP authentication) whether to use it during security association establishment.

EAP-AKA over IKEv2 shall be used to authenticate UE in the IKE_AUTH exchange, while public key signature based authentication with certificates shall be used to authenticate the HA.

...

During the IKEv2 exchange, the UE shall request the allocation of an IPv6 home prefix through the Configuration Payload in the IKE_AUTH. Since in EPS a unique IPv6 prefix is assigned to the UE, the UE shall include a MIP6_HOME_PREFIX attribute in the CFG_REQUEST message as described in IETF RFC 5026 [10]. In addition the UE may include the INTERNAL_IP6_DNS attribute in the CFG_REQUEST as described in IETF RFC 4306 [14] to request the DNS server IPv6 address of the PLMN it is connecting to via DSMIPv6. In the same way the UE may include the INTERNAL_IP4_DNS attribute in the CFG_REQUEST to request the IPv4 address of the DNS server.

The UE shall then auto-configure a Home Address from the IPv6 prefix received from the HA and shall run a CREATE_CHILD_SA exchange to create the security association for the new Home Address. In the CREATE_CHILD_SA exchange the UE shall include the Home Address and the appropriate selectors in the TSi (Traffic Selector-initiator) payload to negotiate the IPsec security association for protecting the Binding Update and Binding Acknowledgement messages as specified in IETF RFC 4877 [4].

[TS 24.303, clause 5.1.3.1]

The HA shall support the IKEv2 protocol (see IETF RFC 4306 [14]) for negotiating the IPsec security association to secure DSMIPv6 signalling and shall support EAP over IKEv2 as described in IETF RFC 4306 [14] to perform UE authentication with an AAA server. If an additional authentication and authorization of the IPsec security association were needed with an external AAA server, then the additional authentication steps during the IKEv2 exchange shall be supported as specified in IETF RFC 4739 [23] and defined in 3GPP TS 33.234 [24]. The HA shall support IPsec ESP (see IETF RFC 4303 [11]) in order to provide authentication of Binding Update and Binding Acknowledgement messages as specified in IETF RFC 4877 [4]. The HA shall support multiple authentication exchanges in the IKEv2 protocol as specified in IETF RFC 4739 [23] in order to support authentication with an external AAA server.

The HA shall complete the IKE_SA_INIT exchange as specified in IETF RFC 4306 [14]. The HA shall include in the IDr the same value included by the UE in the IDr payload of the request.

Upon successful authorization and authentication, the HA shall accept the security association establishment request by sending the IKE_AUTH response message with the CFG_REPLY payload including the IPv6 Home Network Prefix allocated to the UE in the MIP6_HOME_PREFIX attribute. This prefix information shall include the prefix length as specified in IETF RFC 5026 [10]. If the UE included the INTERNAL_IP6_DNS or the INTERNAL_IP4_DNS in the CFG_REQUEST, the HA shall include the same attribute in the CFG_REPLY including zero or more DNS server addresses as specified in IETF RFC 4306 [14].

If the 3GPP AAA server triggers the HA to perform a HA reallocation procedure as specified in 3GPP TS 33.402 [18], the HA learns the IP address of the target HA as specified in 3GPP TS 29.273 [20]. The HA shall provide to the UE the target HA IP address in the REDIRECT payload during IKE_AUTH exchange as specified in 3GPP TS 33.402 [18]. The encoding of the REDIRECT payload in the IKE_AUTH response message is specified in draft-ietf-ipsecme-ikev2-redirect [30]. The HA shall not assign an IPv6 prefix to the UE in the IKE_AUTH exchange. The HA shall remove the states of the IKEv2 security association with the UE after receiving an IKEv2 Informational message with a DELETE payload from the UE.

15.4.3 Test description

15.4.3.1 Pre-test conditions

System Simulator:

- Cell 1.

UE:

None.

Preamble:

- The UE is in state Registered, Idle Mode (state 2) on Cell 1 according to [18].
- The UE has acquired an IP address.
- The UE has discovered the IP address of the Home Agent (either via DNS, DHCPv6, IKEv2 signalling or during Attach Procedure via PCO).

15.4.3.2 Test procedure sequence

Table 15.4.3.2-1: Main behaviour

St	Procedure	Message Sequence		TP	Verdict
		U - S	Message		
1	Check: Does the UE transmit an IKE_SA_INIT message addressed to the Home Agent?	-->	IKE_SA_INIT	1	P
2	The SS transmits an IKE_SA_INIT message.	<--	IKE_SA_INIT	-	-
3	Check: Does the UE transmit an IKE_AUTH Request message containing the configuration payload MIP6_HOME_PREFIX, a MN-NAI derived from UE IMSI in the IDi field and an APN in the IDr field?	-->	IKE_AUTH Request	2	P
4	The SS transmits an IKE_AUTH Response message including an EAP-Request/AKA-Challenge.	<--	IKE_AUTH Response	-	-
5	Check: Does the UE transmit an IKE_AUTH Request message including the EAP-Response/AKA-Challenge?	-->	IKE_AUTH Request	3	P
6	The SS transmits an IKE_AUTH Response message including EAP-Success.	<--	IKE_AUTH Response	-	-
7	Check: Does the UE transmit an IKE_AUTH Request message with Authentication payload?	-->	IKE_AUTH Request	4	P
8	The SS transmits an IKE_AUTH Response message with Notify payload containing REDIRECT attribute with the Home Agent to be used	<--	IKE_AUTH Response	-	-
9	Check: Does the UE transmit an IKE_SA_INIT message addressed to the Home Agent whose address was provided in the REDIRECT Notify payload?	-->	IKE_SA_INIT	5	P

15.4.3.3 Specific message contents

Table 15.4.3.3-1: Message IKE_SA_INIT (step 1, Table 15.4.3.2-1)

Field	Value/remark	Comment	Condition
IKE Header			
Initiator's IKE_SA SPI	Set by the UE		
Responder's IKE_SA SPI	0	First message in IKE_SA_INIT exchange	
Next Payload	'00100001'B	SA	
Exchange Type	'00100010'B	IKE_SA_INIT	
Security Association Payload			
Next Payload	'00100010'B	KE	
More proposal	'00000010'B		
Proposal #	'00000001'B	First cryptographic suite (section 6.5 of TS 33.234)	
Protocol ID	'00000001'B	IKE	
SPI size	'00000000'B		
Number of transforms	'00000010'B		
More transform	'00000011'B	This is the transform for confidentiality	
Transform type	'00000001'B	Encryption	
Transform ID	'00000011'B	3DES in CBC mode (ENCR_3DES)	
More transform	'00000011'B	This is the transform for prf	
Transform type	'00000010'B	PRF	
Transform ID	'00000010'B	PRF_HMAC_SHA1 (HMAC-SHA1)	
More transform	'00000011'B	This is the transform for integrity	
Transform type	'00000011'B	Integrity	
Transform ID	'00000010'B	HMAC-SHA1-96 (AUTH_HMAC_SHA1_96)	
Last transform	'00000000'B	This is the transform for DH	
Transform type	'00000100'B	DH	
Transform ID	'00000010'B	Diffie-Hellman group 2 (1024-bit MODP)	
Last proposal	'00000000'B		
Proposal #	'00000010'B	Second cryptographic suite (section 6.5 of TS 33.234)	
Protocol ID	'00000001'B	IKE	
SPI size	'00000000'B		
Number of transforms	'00000010'B		
More transform	'00000011'B	This is the transform for confidentiality	
Transform type	'00000001'B	Encryption	
Transform ID	'00001011'B	AES with 128-bit keys in CBC mode (ENCR_AES_CB C)	
More transform	'00000011'B	This is the transform for prf	
Transform type	'00000010'B	PRF	
Transform ID	'00000100'B	PRF_AES128_XC	

		BC_AES-XCBC-PRF-128	
More transform	'00000011'B	This is the transform for integrity	
Transform type	'00000011'B	Integrity	
Transform ID	'00000101'B	AES-XCBC-MAC-96 (AUTH_AES-XCBC-96)	
Last transform	'00000000'B	This is the transform for DH	
Transform type	'00000100'B	DH	
Transform ID	'00000010'B	Diffie-Hellman group 2 (1024-bit MODP)	
Key Exchange Payload			
Next Payload	'00101000'B	Nonce	
DH Group #	'00000000000000010'B	DH group 2	
Key Exchange data	Set by the UE		
Nonce Payload			
Next Payload	'00101001'B	Notify (REDIRECT_SUPPORTED)	
Nonce data	Random number set by the UE		
REDIRECT_SUPPORTED Notify Payload			
Next Payload	'00000000'B	No Next Payload	
Protocol ID	'00000000'B	Notification is not specific to a particular security association	
SPI size	'00000000'B	SPI field not present	
Notify Message Type	'010000000010110'B	REDIRECT_SUPPORTED	

Table 15.4.3.3-2: Message IKE_SA_INIT (step 2, Table 15.4.3.2-1)

Information Element	Value/remark	Comment	Condition
IKE Header			
Initiator's IKE_SA SPI	Same as that set by the UE in IKE_SA_INIT as Step 1		
Responder's IKE_SA SPI	Set by the SS		
Next Payload	'00100001'B	SA	
Exchange Type	'00100010'B	IKE_SA_INIT	
Security Association Payload			
Next Payload	'00100010'B	KE	
Proposal	One of the 2 proposals included in IKE_SA_INIT at Step 1		
Key Exchange Payload			
Next payload	'00 101000'B	Nonce	
DH Group #	'00000000000000010'B	DH group 2	
Key Exchange data	Set by the SS		
Nonce Payload			
Next t payload	'00000000'B	No Next Payload	
Nonce data	Set by the SS		

Table 15.4.3.3-3: Message IKE_AUTH Request (step 3, Table 15.4.3.2-1)

Field	Value/remark	Comment	Condition
IKE Header			
Initiator's IKE_SA SPI	Same as that set by the UE at Step 1		
Responder's IKE_SA SPI	Same as that set by the SS at Step 2		
Next Payload	'00101110'B	E	
Exchange Type	'00100011'B	IKE_AUTH	
Encrypted Payload			
Next Payload	'00100011'B	IDi	
Initialization Vector	Random value set by the UE		
Encrypted IKE Payloads			
Identification – Initiator Payload			
Next Payload	'00101111'B	CP	
ID Type	00000010B		
ID	Set to MN-NAI		
Configuration Payload			
Next Payload	'00100001'B	SA	
CFG Type	'00000001'B	Request	
Configuration Attribute	'00010000'B	MIP6_HOME_PR EFIX attribute	
Length	'0000000000000000'B		
Security Association Payload			
Next Payload	'00101100'B	TSi	
Proposals	Any set of allowed values		
Traffic Selector – Initiator Payload			
Next Payload	'00101100'B	TSr	
Traffic selector data	Any allowed set of values		
Traffic Selector – Responder Payload			
Next Payload	'00100100'B	IDr	
Traffic selector data	Any allowed set of values		
Identification – Responder Payload			
Next Payload	'00000000'B	No Next Payload	
ID Type	'00000010'B		
ID	APN		
Padding	Set by the UE	Fields from Encrypted payload	
Pad Length	Set by the UE	Fields from Encrypted payload	
Integrity checksum data	Set by the UE	Fields from Encrypted payload	

Table 15.4.3.3-4: Message IKE_AUTH Response (step 4, Table 15.4.3.2-1)

Field	Value/remark	Comment	Condition
IKE Header			
Initiator's IKE_SA SPI	Same as that set by the UE at Step 1		
Responder's IKE_SA SPI	Same as that set by the SS at Step 2		
Next Payload	'00101110'B	E	
Exchange Type	'00100011'B	IKE_AUTH	
Encrypted Payload			
Next Payload	'00100100'B	IDr	
Initialization Vector	Set by the SS		
Encrypted IKE Payloads			
Identification – Responder Payload			
Next Payload	'00100101'B	CERT	
ID Type	'00000010'B		
ID	APN		
Certificate Payload			
Next Payload	'00110000'B	EAP	
Cert encoding	'00000100'B	X.509 certificate - signature	
Certificate data	Set by the SS	DER encoded X.509 certificate	
Extensible Authentication Payload			
Next Payload	'00000000'B	No Next Payload	
Code	'00000001'B	Request	
Type	'00010111'B	AKA	
Subtype		AKA-Challenge	
Attribute type	'00000001'B	AT_RANDOM	
AT_RANDOM	An arbitrarily selected 128 bits value		
Attribute Type	'00000010'B	AT_AUTN	
AT_AUTN	See TS 24.301 [28] subclause 9.9.3.2		
Padding	Set by the SS	Fields from Encryption payload	
Pad Length	Set by the SS	Fields from Encryption payload	
Integrity checksum data	Set by the SS	Fields from Encryption payload	

Table 15.4.3.3-5: Message IKE_AUTH Request (step 5, Table 15.4.3.2-1)

Field	Value/remark	Comment	Condition
IKE Header			
Initiator's IKE_SA SPI	Same as that set by UE at Step 1		
Responder's IKE_SA SPI	Same as that set by the SS at Step 2		
Next Payload	'00101110'B	E	
Exchange Type	'00100011'B	IKE_AUTH	
Encrypted Payload			
Next Payload	'00110000'B	EAP	
Initialization Vector	Random value set by the UE		
Encrypted IKE Payloads			
Extensible Authentication Payload			
Next Payload	'00000000'B	No Next Payload	
Code	'00000010'B	Response	
Type	'00010111'B	AKA	
Subtype		AKA-Challenge	
Attribute type	'00000011'B	AT_RES	
AT_RES	See TS 24.301 [28] subclause 9.9.3.4		
Padding	Set by the UE	Fields from Encryption payload	
Pad Length	Set by the UE	Fields from Encryption payload	
Integrity checksum data	Set by the UE	Fields from Encryption payload	

Table 15.4.3.3-6: Message IKE_AUTH Response (step 6, Table 15.4.3.2-1)

Field	Value/remark	Comment	Condition
IKE Header			
Initiator's IKE_SA SPI	Same as that set by the UE at Step 1		
Responder's IKE_SA SPI	Same as that set by the SS at Step 2		
Next Payload	'00101110'B	E	
Exchange Type	'00100011'B	IKE_AUTH	
Encrypted Payload			
Next Payload	'00110000'B	EAP	
Initialization Vector	Set by the SS		
Encrypted IKE Payloads			
Extensible Authentication Payload			
Next Payload	'00000000'B	No Next Payload	
Code	'00000011'B	Success	
Padding	Set by the SS	Fields from Encryption payload	
Pad Length	Set by the SS	Fields from Encryption payload	
Integrity checksum data	Set by the SS	Fields from Encryption payload	

Table 15.4.3.3-7: Message IKE_AUTH Request (step 7, Table 15.4.3.2-1)

Field	Value/remark	Comment	Condition
IKE Header			
Initiator's IKE_SA SPI	Same as that set by the UE at Step 1		
Responder's IKE_SA SPI	Same as that set by the SS at Step 2		
Next Payload	'00101110'B	E	
Exchange Type	'00100011'	IKE_AUTH	
Encrypted Payload			
Next Payload	'00100111'B	AUTH	
Initialization Vector	Random value set by the UE		
Encrypted IKE Payloads			
Authentication Payload			
Next Payload	'00000000'B	No Next Payload	
Auth Method	'00000010'B	Shared Key Integrity code	
Auth Data	derived from the MSK obtained from AKA exchange	RFC 4306 defines the function to derive this key (section 2.15)	
Padding	Set by the UE	Fields from Encryption payload	
Pad Length	Set by the UE	Fields from Encryption payload	
Integrity checksum data	Set by the UE	Fields from Encryption payload	

Table 15.4.3.3-8: Message IKE_AUTH Response (step 8, Table 15.4.3.2-1)

Field	Value/remark	Comment	Condition
IKE Header			
Initiator's IKE_SA SPI	Same as that set by the UE at Step 1		
Responder's IKE_SA SPI	Same as that set by the SS at Step 2		
Next Payload	'00101110'B	E	
Exchange Type	'00100011'B	IKE_AUTH	
Encrypted Payload			
Next Payload	'00100111'B	AUTH	
Initialization Vector	Set by the SS		
Encrypted IKE Payloads			
Authentication Payload			
Next Payload	'00101001'B	Notify	
Auth Method	'00000010'B	Shared Key Integrity code	
Auth Data	derived from the MSK obtained from AKA exchange	RFC 4306 defines the function to derive this key (section 2.15)	
Notify Payload			
Next Payload	'00100001'B	SA	
Protocol ID	'00000000'B	Notification is not specific to a particular security association	
SPI Size	'00000000'B	SPI field not present	
Notify Message Type Length	'0100000000010111'B	REDIRECT	
GW Ident Type	'00000101'B		
New Responder GW Identity	IPv6 address of the HA to relocate		
GW Ident Type	'00000001'B		
New Responder GW Identity	IPv4 address of the HA to relocate	Optional	
Security Association Payload			
Next Payload	'00101101'	TSi	
Proposal	One of the 2 proposals included in IKE_AUTH Request at Step 3		
Traffic Selector – Initiator Payload			
Next Payload	'00101100'B	TSr	
Traffic Selector data	Any allowed set of values		
Traffic Selector – Responder Payload			
Next Payload	'00000000'B	No Next Payload	
Traffic Selector data	Any allowed set of values		
Padding	Set by the SS	Fields from Encryption payload	
Pad Length	Set by the SS	Fields from Encryption payload	
Integrity checksum data	Set by the SS	Fields from Encryption payload	

Table 15.4.3.3-910: Message IKE_SA_INIT (step 109, Table 15.4.3.2-1)

Field	Value/remark	Comment	Condition
IKE Header			
Initiator's IKE_SA SPI	Set by the UE		
Responder's IKE_SA SPI	0	First message in IKE_SA_INIT exchange	
Next Payload	'00100001'B	SA	
Exchange Type	'00100010'B	IKE_SA_INIT	
Security Association Payload			
Next Payload	'00100010'B	KE	
More proposal	'00000010'B		
Proposal #	'00000001'B	First cryptographic suite (section 6.5 of TS 33.234)	
Protocol ID	'00000001'B	IKE	
SPI size	'00000000'B		
Number of transforms	'00000010'B		
More transform	'00000011'B	This is the transform for confidentiality	
Transform type	'00000001'B	Encryption	
Transform ID	'00000011'B	3DES in CBC mode (ENCR_3DES)	
More transform	'00000011'B	This is the transform for prf	
Transform type	'00000010'B	PRF	
Transform ID	'00000010'B	PRF_HMAC_SHA1 (HMAC-SHA1)	
More transform	'00000011'B	This is the transform for integrity	
Transform type	'00000011'B	Integrity	
Transform ID	'00000010'B	HMAC-SHA1-96 (AUTH_HMAC_SHA1_96)	
Last transform	'00000000'B	This is the transform for DH	
Transform type	'00000100'B	DH	
Transform ID	'00000010'B	Diffie-Hellman group 2 (1024-bit MODP)	
Last proposal	'00000000'B		
Proposal #	'00000010'B	Second cryptographic suite (section 6.5 of TS 33.234)	
Protocol ID	'00000001'B	IKE	
SPI size	'00000000'B		
Number of transforms	'00000010'B		
More transform	'00000011'B	This is the transform for confidentiality	
Transform type	'00000001'B	Encryption	
Transform ID	'00001011'B	AES with 128-bit keys in CBC mode (ENCR_AES_CBC)	
More transform	'00000011'B	This is the transform for prf	
Transform type	'00000010'B	PRF	
Transform ID	'00000100'B	PRF_AES128_XCBC_AES-XCBC-PRF-128	

More transform	'0000011'B	This is the transform for integrity	
Transform type	'0000011'B	Integrity	
Transform ID	'00000101'B	AES-XCBC-MAC-96 (AUTH_AES-XCBC -96)	
Last transform	'0000000'B	This is the transform for DH	
Transform type	'00000100'B	DH	
Transform ID	'00000010'B	Diffie-Hellman group 2 (1024-bit MODP)	
Key Exchange Payload			
Next Payload	'00101000'B	Nonce	
DH Group #	'0000000000000010'B	DH group 2	
Key Exchange data	Set by the UE		
Nonce Payload			
Next Payload	'00101001'B	Notify (REDIRECT_SUPPORTED)	
Nonce data	Random number set by the UE		
REDIRECT_SUPPORTED Notify Payload			
Next Payload	'00101001'B	Notify (REDIRECT_FROM)	
Protocol ID	'00000000'B	Notification is not specific to a particular security association	
SPI size	'00000000'B	SPI field not present	
Notify Message Type	'0100000000010110'B	REDIRECT_SUPPORTED	
Notify Payload			
Next Payload	'00000000'B	No next payload	
Protocol ID	'00000000'B	Notification is not specific to a particular security association	
SPI Size	'00000000'B	SPI field not present	
Notify Message Type	'0100000000011000'B	REDIRECT_From	
GW Ident Type	Any allowed value (IPv6 or IPv4 or HA FQDN)	Set depending on how the UE has discovered the HA in the preamble	
New Responder GW Identity	Depends on GW Ident type		

15.5 Security association establishment without home agent reallocation procedure

15.5.1 Test Purpose (TP)

(1)

```

with { UE has acquired an IP address }
ensure that {
  when { UE has acquired the IP address of the Home Agent }
  then { UE transmits an IKE_SA_INIT message addressed to the Home Agent to initiate security association establishment }
}

```

(2)

```

with { UE has transmitted an IKE_SA_INIT message addressed to the Home Agent to initiate security
association establishment }
ensure that {
  when { UE receives an IKE_SA_INIT response message }
  then { UE transmits an IKE_AUTH Request message containing the configuration payload
MIP6_HOME_PREFIX to receive the prefix to use for Home Address configuration }
}

```

(3)

```

with { UE has transmitted an IKE_AUTH Request message containing the configuration payload
MIP6_HOME_PREFIX to receive the prefix to use for Home Address configuration }
ensure that {
  when { UE receives an IKE_AUTH Response message including an EAP-Request/AKA Challenge }
  then { UE transmits an IKE_AUTH Request message containing the correct EAP-Response/AKA-
Challenge }
}

```

(4)

```

with { UE has transmitted an IKE_AUTH Request message containing an EAP-Response/AKA-Challenge }
ensure that {
  when { UE receives an IKE_AUTH Response message including EAP-Success }
  then { UE transmits an IKE_AUTH Request message with Authentication payload }
}

```

(5)

```

with { UE has transmitted an IKE_AUTH Request message with Authentication payload }
ensure that {
  when { UE receives an IKE_AUTH Response message with configuration payload MIP6_HOME_PREFIX
containing the Home Network Prefix HNP associated to the UE }
  then { UE transmits a CREATE_CHILD_SA Request message including traffic selectors fields (TSi
and TSr) that contain the parameters identifying the Binding Update (BU)/Binding Acknowledgments
(BA) messages }
}

```

15.5.2 Conformance requirements

References: The conformance requirements covered in the present TC are specified in: TS 24.303, clause 5.1.2.2.

[TS 24.303, clause 5.1.2.2]

The UE shall support the IKEv2 protocol (see IETF RFC 4306 [14]) for negotiating the IPsec security association to secure DSMIPv6 signalling and shall support EAP over IKEv2 as described in IETF RFC 4306 [14] to perform authentication with an AAA server. In a case an additional authentication and authorization of the IPsec security association is needed with an external AAA server, then the additional authentication steps during the IKEv2 exchange shall be supported as specified in IETF RFC 4739 [23] and described in 3GPP TS 33.234 [24].

The UE shall support IPsec ESP (see IETF RFC 4303 [11]) in order to provide authentication of Binding Update and Binding Acknowledgement messages as specified in IETF RFC 4877 [4]. The UE shall support multiple authentication exchanges in the IKEv2 protocol as specified in IETF RFC 4739 [23] in order to support authentication with an external AAA server. The UE shall support the redirect mechanism as defined in draft-ietf-ipsecme-ikev2-redirect [30].

The UE shall initiate the security association establishment procedure by sending the IKE_SA_INIT request message defined in IETF RFC 4306 [14] to the HA. The UE shall indicate support for the HA reallocation by including a REDIRECT_SUPPORTED payload in the IKE_SA_INIT request as specified in draft-ietf-ipsecme-ikev2-redirect [30]. On receipt of an IKE_SA_INIT response, the UE shall send an IKE_AUTH request message including the MN-NAI in the IDi payload and the Access Point Name (APN) of the target PDN the UE wants to connect to in the IDr payload. The APN shall be formatted as defined in 3GPP TS 23.003 [17]. The username part of the MN-NAI included in "IDi" payload may be an IMSI, pseudonym or re-authentication ID. The UE shall include in the IDi payload the same MN-NAI it includes in the EAP-Response/Identity within the EAP-AKA exchange.

In the very first EAP-Response/Identity within the IKEv2 exchange the UE shall include a NAI whose username is derived from IMSI. In subsequent exchanges the UE should use pseudonyms and re-authentication identities provided by the 3GPP AAA server as specified in IETF RFC 4187 [26].

NOTE: Fast re-authentication mechanism is optional, and therefore is an implementation option in the UE and operator configuration issue (i.e. it also depends on whether the AAA server sent a re-authentication ID during previous EAP authentication) whether to use it during security association establishment.

EAP-AKA over IKEv2 shall be used to authenticate UE in the IKE_AUTH exchange, while public key signature based authentication with certificates shall be used to authenticate the HA.

...

During the IKEv2 exchange, the UE shall request the allocation of an IPv6 home prefix through the Configuration Payload in the IKE_AUTH. Since in EPS a unique IPv6 prefix is assigned to the UE, the UE shall include a MIP6_HOME_PREFIX attribute in the CFG_REQUEST message as described in IETF RFC 5026 [10]. In addition the UE may include the INTERNAL_IP6_DNS attribute in the CFG_REQUEST as described in IETF RFC 4306 [14] to request the DNS server IPv6 address of the PLMN it is connecting to via DSMIPv6. In the same way the UE may include the INTERNAL_IP4_DNS attribute in the CFG_REQUEST to request the IPv4 address of the DNS server.

The UE shall then auto-configure a Home Address from the IPv6 prefix received from the HA and shall run a CREATE_CHILD_SA exchange to create the security association for the new Home Address. In the CREATE_CHILD_SA exchange the UE shall include the Home Address and the appropriate selectors in the TSi (Traffic Selector-initiator) payload to negotiate the IPsec security association for protecting the Binding Update and Binding Acknowledgement messages as specified in IETF RFC 4877 [4].

15.5.3 Test description

15.5.3.1 Pre-test conditions

System Simulator:

- Cell 1.

UE:

None.

Preamble:

- The UE is in state Registered, Idle Mode (state 2) on Cell 1 according to [18].
- The UE has acquired an IP address.
- The UE has discovered the IP address of the Home Agent (either via DNS, DHCPv6, IKEv2 signalling or during Attach Procedure via PCO).

15.5.3.2 Test procedure sequence

Table 15.5.3.2-1: Main behaviour

St	Procedure	Message Sequence		TP	Verdict
		U - S	Message		
1	Check: Does the UE transmit an IKE_SA_INIT message addressed to the Home Agent?	-->	IKE_SA_INIT	1	P
2	The SS transmits an IKE_SA_INIT message.	<--	IKE_SA_INIT	-	-
3	Check: Does the UE transmit an IKE_AUTH Request message containing the configuration payload MIP6_HOME_PREFIX, a MN-NAI derived from UE IMSI in the IDi field and an APN in the IDr field?	-->	IKE_AUTH Request	2	P
4	The SS transmits an IKE_AUTH Response message including an EAP-Request/AKA-Challenge.	<--	IKE_AUTH Response	-	-
5	Check: Does the UE transmit an IKE_AUTH Request message including the EAP-Response/AKA-Challenge?	-->	IKE_AUTH Request	3	P
6	The SS transmits an IKE_AUTH Response message including EAP-Success.	<--	IKE_AUTH Response	-	-
7	Check: Does the UE transmit an IKE_AUTH Request message with Authentication payload?	-->	IKE_AUTH Request	4	P
8	The SS transmits an IKE_AUTH Response message with configuration payload MIP6_HOME_PREFIX containing the Home Network Prefix HNP associated to the UE.	<--	IKE_AUTH Response	-	-
9	Check: Does the UE transmit a CREATE_CHILD_SA Request message including traffic selectors' fields (TSi and TSr) that contain the parameters identifying the Binding Update (BU) / Binding Acknowledgments (BA) messages?	-->	CREATE_CHILD_SA Request	5	P
10	The SS transmits a CREATE_CHILD_SA Response message.	<--	CREATE_CHILD_SA Response	-	-

15.5.3.3 Specific message contents

Table 15.5.3.3-1: Message IKE_SA_INIT (step 1, Table 15.5.3.2-1)

Field	Value/remark	Comment	Condition
IKE Header			
Initiator's IKE_SA SPI	Set by the UE		
Responder's IKE_SA SPI	0	First message in IKE_SA_INIT exchange	
Next Payload	'00100001'B	SA	
Exchange Type	'00100010'B	IKE_SA_INIT	
Security Association Payload			
Next Payload	'00100010'B	KE	
More proposal	'00000010'B		
Proposal #	'00000001'B	First cryptographic suite (section 6.5 of TS 33.234)	
Protocol ID	'00000001'B	IKE	
SPI size	'00000000'B		
Number of transforms	'00000010'B		
More transform	'00000011'B	This is the transform for confidentiality	
Transform type	'00000001'B	Encryption	
Transform ID	'00000011'B	3DES in CBC mode (ENCR_3DES)	
More transform	'00000011'B	This is the transform for prf	
Transform type	'00000010'B	PRF	
Transform ID	'00000010'B	PRF_HMAC_SHA1 (HMAC-SHA1)	
More transform	'00000011'B	This is the transform for integrity	
Transform type	'00000011'B	Integrity	
Transform ID	'00000010'B	HMAC-SHA1-96 (AUTH_HMAC_SHA1_96)	
Last transform	'00000000'B	This is the transform for DH	
Transform type	'00000100'B	DH	
Transform ID	'00000010'B	Diffie-Hellman group 2 (1024-bit MODP)	
Last proposal	'00000000'B		
Proposal #	'00000010'B	Second cryptographic suite (section 6.5 of TS 33.234)	
Protocol ID	'00000001'B	IKE	
SPI size	'00000000'B		
Number of transforms	'00000010'B		
More transform	'00000011'B	This is the transform for confidentiality	
Transform type	'00000001'B	Encryption	
Transform ID	'00001011'B	AES with 128-bit keys in CBC mode (ENCR_AES_CB C)	
More transform	'00000011'B	This is the transform for prf	
Transform type	'00000010'B	PRF	
Transform ID	'00000100'B	PRF_AES128_XC	

		BC_AES-XCBC-PRF-128	
More transform	'00000011'B	This is the transform for integrity	
Transform type	'00000011'B	Integrity	
Transform ID	'00000101'B	AES-XCBC-MAC-96 (AUTH_AES-XCBC-96)	
Last transform	'00000000'B	This is the transform for DH	
Transform type	'00000100'B	DH	
Transform ID	'00000010'B	Diffie-Hellman group 2 (1024-bit MODP)	
Key Exchange Payload			
Next Payload	'00101000'B	Nonce	
DH Group #	'00000000000000010'B	DH group 2	
Key Exchange data	Set by the UE		
Nonce Payload			
Next Payload	'00101001'B	Notify (REDIRECT_SUPPORTED)	
Nonce data	Random number set by the UE		
REDIRECT_SUPPORTED Notify Payload			
Next Payload	'00000000'B	No Next Payload	
Protocol ID	'00000000'B	Notification is not specific to a particular security association	
SPI size	'00000000'B	SPI field not present	
Notify Message Type	'010000000010110'B	REDIRECT_SUPPORTED	

Table 15.5.3.3-2: Message IKE_SA_INIT (step 2, Table 15.5.3.2-1)

Information Element	Value/remark	Comment	Condition
IKE Header			
Initiator's IKE_SA SPI	Same as that set by the UE in IKE_SA_INIT as Step 1		
Responder's IKE_SA SPI	Set by the SS		
Next Payload	'00100001'B	SA	
Exchange Type	'00100010'B	IKE_SA_INIT	
Security Association Payload			
Next Payload	'00100010'B	KE	
Proposal	One of the 2 proposals included in IKE_SA_INIT at Step 1		
Key Exchange Payload			
Next payload	'00 101000'B	Nonce	
DH Group #	'00000000000000010'B	DH group 2	
Key Exchange data	Set by the SS		
Nonce Payload			
Next t payload	'00000000'B	No Next Payload	
Nonce data	Set by the SS		

Table 15.5.3.3-3: Message IKE_AUTH Request (step 3, Table 15.5.3.2-1)

Field	Value/remark	Comment	Condition
IKE Header			
Initiator's IKE_SA SPI	Same as that set by the UE at Step 1		
Responder's IKE_SA SPI	Same as that set by the SS at Step 2		
Next Payload	'00101110'B	E	
Exchange Type	'00100011'B	IKE_AUTH	
Encrypted Payload			
Next Payload	'00100011'B	IDi	
Initialization Vector	Random value set by the UE		
Encrypted IKE Payloads			
Identification – Initiator Payload			
Next Payload	'00101111'B	CP	
ID Type	00000010B		
ID	Set to MN-NAI		
Configuration Payload			
Next Payload	'00100001'B	SA	
CFG Type	'00000001'B	Request	
Configuration Attribute	'00010000'B	MIP6_HOME_PR EFIX attribute	
Length	'0000000000000000'B		
Security Association Payload			
Next Payload	'00101100'B	TSi	
Proposals	Any set of allowed values		
Traffic Selector – Initiator Payload			
Next Payload	'00101100'B	TSr	
Traffic selector data	Any allowed set of values		
Traffic Selector – Responder Payload			
Next Payload	'00100100'B	IDr	
Traffic selector data	Any allowed set of values		
Identification – Responder Payload			
Next Payload	'00000000'B	No Next Payload	
ID Type	'00000010'B		
ID	APN		
Padding	Set by the UE	Fields from Encrypted payload	
Pad Length	Set by the UE	Fields from Encrypted payload	
Integrity checksum data	Set by the UE	Fields from Encrypted payload	

Table 15.5.3.3-4: Message IKE_AUTH Response (step 4, Table 15.5.3.2-1)

Field	Value/remark	Comment	Condition
IKE Header			
Initiator's IKE_SA SPI	Same as that set by the UE at Step 1		
Responder's IKE_SA SPI	Same as that set by the SS at Step 2		
Next Payload	'00101110'B	E	
Exchange Type	'00100011'B	IKE_AUTH	
Encrypted Payload			
Next Payload	'00100100'B	IDr	
Initialization Vector	Set by the SS		
Encrypted IKE Payloads			
Identification – Responder Payload			
Next Payload	'00100101'B	CERT	
ID Type	'00000010'B		
ID	APN		
Certificate Payload			
Next Payload	'00110000'B	EAP	
Cert encoding	'00000100'B	X.509 certificate - signature	
Certificate data	Set by the SS	DER encoded X.509 certificate	
Extensible Authentication Payload			
Next Payload	'00000000'B	No Next Payload	
Code	'00000001'B	Request	
Type	'00010111'B	AKA	
Subtype		AKA-Challenge	
Attribute type	'00000001'B	AT_RAND	
AT_RAND	An arbitrarily selected 128 bits value		
Attribute Type	'00000010'B	AT_AUTN	
AT_AUTN	See TS 24.301 [28] subclause 9.9.3.2		
Padding	Set by the SS	Fields from Encryption payload	
Pad Length	Set by the SS	Fields from Encryption payload	
Integrity checksum data	Set by the SS	Fields from Encryption payload	

Table 15.5.3.3-5: Message IKE_AUTH Request (step 5, Table 15.5.3.2-1)

Field	Value/remark	Comment	Condition
IKE Header			
Initiator's IKE_SA SPI	Same as that set by UE at Step 1		
Responder's IKE_SA SPI	Same as that set by the SS at Step 2		
Next Payload	'00101110'B	E	
Exchange Type	'00100011'B	IKE_AUTH	
Encrypted Payload			
Next Payload	'00110000'B	EAP	
Initialization Vector	Random value set by the UE		
Encrypted IKE Payloads			
Extensible Authentication Payload			
Next Payload	'00000000'B	No Next Payload	
Code	'00000010'B	Response	
Type	'00010111'B	AKA	
Subtype		AKA-Challenge	
Attribute type	'00000011'B	AT_RES	
AT_RES	See TS 24.301 [28] subclause 9.9.3.4		
Padding	Set by the UE	Fields from Encryption payload	
Pad Length	Set by the UE	Fields from Encryption payload	
Integrity checksum data	Set by the UE	Fields from Encryption payload	

Table 15.5.3.3-6: Message IKE_AUTH Response (step 6, Table 15.5.3.2-1)

Field	Value/remark	Comment	Condition
IKE Header			
Initiator's IKE_SA SPI	Same as that set by the UE at Step 1		
Responder's IKE_SA SPI	Same as that set by the SS at Step 2		
Next Payload	'00101110'B	E	
Exchange Type	'00100011'B	IKE_AUTH	
Encrypted Payload			
Next Payload	'00110000'B	EAP	
Initialization Vector	Set by the SS		
Encrypted IKE Payloads			
Extensible Authentication Payload			
Next Payload	'00000000'B	No Next Payload	
Code	'00000011'B	Success	
Padding	Set by the SS	Fields from Encryption payload	
Pad Length	Set by the SS	Fields from Encryption payload	
Integrity checksum data	Set by the SS	Fields from Encryption payload	

Table 15.5.3.3-7: Message IKE_AUTH Request (step 7, Table 15.5.3.2-1)

Field	Value/remark	Comment	Condition
IKE Header			
Initiator's IKE_SA SPI	Same as that set by the UE at Step 1		
Responder's IKE_SA SPI	Same as that set by the SS at Step 2		
Next Payload	'00101110'B	E	
Exchange Type	'00100011'	IKE_AUTH	
Encrypted Payload			
Next Payload	'00100111'B	AUTH	
Initialization Vector	Random value set by the UE		
Encrypted IKE Payloads			
Authentication Payload			
Next Payload	'00000000'B	No Next Payload	
Auth Method	'00000010'B	Shared Key Integrity code	
Auth Data	derived from the MSK obtained from AKA exchange	RFC 4306 defines the function to derive this key (section 2.15)	
Padding	Set by the UE	Fields from Encryption payload	
Pad Length	Set by the UE	Fields from Encryption payload	
Integrity checksum data	Set by the UE	Fields from Encryption payload	

Table 15.5.3.3-8: Message IKE_AUTH Response (step 8, Table 15.5.3.2-1)

Field	Value/remark	Comment	Condition
IKE Header			
Initiator's IKE_SA SPI	Same as that set by the UE at Step 1		
Responder's IKE_SA SPI	Same as that set by the SS at Step 2		
Next Payload	'00101110'B	E	
Exchange Type	'00100011'B	IKE_AUTH	
Encrypted Payload			
Next Payload	'00100111'B	AUTH	
Initialization Vector	Set by the SS		
Encrypted IKE Payloads			
Authentication Payload			
Next Payload	'00101111'B	CP	
Auth Method	'00000010'B	Shared Key Integrity code	
Auth Data	derived from the MSK obtained from AKA exchange	RFC 4306 defines the function to derive this key (section 2.15)	
Configuration Payload			
Next Payload	'00100001'B	SA	
CFG Type	'00000010'B	Reply	
Configuration Attribute	'00010000'B	MIP6_HOME_PR EFIX attribute	
Length	'0000000000010101'B		
Prefix lifetime	Any allowed value		
Home Prefix	IPv6 prefix – 16 bytes		
Prefix length	'10000000'B	Prefix length must be 64	
Security Association Payload			
Next Payload	'00101101'	TSi	
Proposal	One of the 2 proposals included in IKE_AUTH Request at Step 3		
Traffic Selector – Initiator Payload			
Next Payload	'00101100'B	TSr	
Traffic Selector data	Any allowed set of values		
Traffic Selector – Responder Payload			
Next Payload	'00000000'B	No Next Payload	
Traffic Selector data	Any allowed set of values		
Padding	Set by the SS	Fields from Encryption payload	
Pad Length	Set by the SS	Fields from Encryption payload	
Integrity checksum data	Set by the SS	Fields from Encryption payload	

Table 15.5.3.3-9: Message CREATE_CHILD_SA Request (step 9, Table 15.5.3.2-1)

Field	Value/remark	Comment	Condition
IKE Header			
Initiator's IKE_SA SPI	Same as that set by the UE at Step 1		
Responder's IKE_SA SPI	Same as that set by the SS at Step 2		
Next Payload	'00101110'B	E	
Exchange Type	'00 100100'B	CREATE_CHILD_SA	
Encrypted Payload			
Next Payload	'00100001'B	SA	
Initialization Vector	Random value set by the UE		
Encrypted IKE Payloads			
Security Association Payload			
Next Payload	'00101000'B	Ni	
More proposal	'00000010'B		
Proposal #	'00000001'B	First cryptographic suite (section 6.6 of TS 33.234)	
Protocol ID	'00000011'B	ESP	
SPI size	'00000100'B		
# of transforms	'00000010'B		
SPI	Set by the UE		
More transform	'00000011'B	This is the transform for confidentiality	
Transform type	'00000001'B	Encryption	
Transform ID	'00000011'B	3DES in CBC mode (ENCR_3DES)	
Last transform	'00000000'B	This is the transform for integrity	
Transform type	'00000011'B	Integrity	
Transform attribute ID	'00000010'B	HMAC-SHA1-96 (AUTH_HMAC_SHA1_96)	
Last proposal	'00000000'B		
Proposal #	'00000010'B	Second cryptographic suite (section 6.6 of TS 33.234)	
Protocol ID	'00000011'B	ESP	
SPI size	'00000100'B		
# of transforms	'00000010'B		
SPI	Set by the UE		
More transform	'00000011'B	This is the transform for confidentiality	
Transform type	'00000001'B	Encryption	
Transform ID	'00001011'B	AES with 128-bit keys in CBC mode (ENCR_AES_CBC)	
Last transform	'00000000'B	This is the transform for integrity	
Transform type	'00000011'B	Integrity	
Transform ID	'00000101'B	AES-XCBC-MAC-96 (AUTH_AES_XCBC_96)	
Nonce Payload			

Next Payload	'00101100'B	TSi	
Nonce data	Random number set by the UE		
Traffic Selector – Initiator Payload			
Next Payload	'00101101'B	TSr	
Traffic Selector data	Any set of values containing the traffic selector of the CREATE_CHILD_SA Response at Step 10		
Traffic Selector – Responder Payload			
Next Payload	'00101001'B	Notify (Use transport mode)	
Traffic Selector data	Any set of values containing the traffic selector of the CREATE_CHILD_SA Response at Step 10		
Use transport mode Notify Payload			
Next payload	'00101001'B	Notify (Use transport mode)	
Protocol ID	'00000011'B	ESP	
SPI size	'00000100'B		
Notify Message Type	'1000000000000111'B	Use transport mode	
SPI	Same as that set by the UE in SA proposal #1		
Use transport mode Notify Payload			
Next payload	'00000000'B	No Next Payload	
Protocol ID	'00000011'B	ESP	
SPI size	'00000100'B		
Notify Message Type	'1000000000000111'B	Use transport mode	
SPI	Same as that set by the UE in SA proposal #1		
Padding	Set by the UE	Fields from Encryption payload	
Pad Length	Set by the UE	Fields from Encryption payload	
Integrity checksum data	Set by the UE	Fields from Encryption payload	

Table 15.5.3.3-10: Message CREATE_CHILD_SA Response (step 10, Table 15.5.3.2-1)

Field	Value/remark	Comment	Condition
IKE Header			
Initiator's IKE_SA SPI	Same as that set by the UE at Step 1		
Responder's IKE_SA SPI	Same as that set by the SS at Step 2		
Next Payload	'00101110'B	E	
Exchange Type	'00 100100'B	CREATE_CHILD_SA	
Encrypted Payload			
Next Payload	'00100001'	SA	
Initialization Vector	Set by the SS		
Encrypted IKE Payloads			
Security Association Payload			
Next Payload	'00101000'B	Nr	
Last proposal	'00000000'B		
Proposal #	One of the 2 proposals included in the CREATE_CHILD_SA Request at Step 9		
Protocol ID	'00000011'B	ESP	
SPI size	'00000100'B		
SPI	Set by the SS		
First transform	'00000011'B	This is the transform for confidentiality	
Transform type	'00000001'B	Encryption	
Transform attribute type	The corresponding value of the chosen proposal		
Last transform	'00000000'B	This is the transform for integrity	
Transform type	'00000011'B	Integrity	
Transform attribute type	The corresponding value of the chosen proposal		
Nonce Payload			
Next Payload	'00101100'B	TSi	
Nonce data	Set by the SS		
Traffic Selector – Initiator Payload			
Next Payload	'00101101'B	TSr	
Number of traffic selectors	'00000010'B		
TS type	'00001000'B	IPv6 range	
IP protocol	'10000111B	Mobility header	
Start port	'0000010100000000'B	BU	
End port	'0000010100000000'B	BU	
Starting-address	HoA address derived from HNP		
Ending address	HoA address derived from HNP		
TS type	'00001000'B	IPv6 range	
IP protocol	'10000111B	Mobility header	
Start port	'0000011000000000'B	BA	
End port	'0000011000000000'B	BA	
Starting-address	HoA address derived from HNP		
Ending address	HoA address derived from HNP		
Traffic Selector – Responder Payload			
Next Payload	'00101001'B	Notify (Use transport mode)	
Number of traffic selectors	'00000010'B		
Ts type	'00001000'B	IPv6 range	
IP protocol	'10000111B	Mobility header	
Start port	'0000010100000000'B	BU	

End port	'0000010100000000'B	BU	
Starting-address	HA address		
Ending address	HA address		
TS type	'00001000'B	IPv6 range	
IP protocol	'10000111'B	Mobility header	
Start port	'0000011000000000'B	BA	
End port	'0000011000000000'B	BA	
Starting-address	HA address		
Ending address	HA address		
Use transport mode Notify Payload			
Next Payload	'00000000'B		
Protocol ID	'00000011'B	ESP	
SPI size	Set by the SS		
Notify Message Type	'1000000000000111'B	Use transport mode	
SPI	Same as that set by the SS in the accepted SA proposal		
Padding	Set by the SS	Fields from Encryption payload	
Pad Length	Set by the SS	Fields from Encryption payload	
Integrity checksum data	Set by the SS	Fields from Encryption payload	

15.6 Registration of a new IPv6 CoA (Binding Update/Acknowledgment procedure in IPv6 network)

15.6.1 Test Purpose (TP)

(1)

```

with { UE has established a security association with the Home Agent and received the IPv6 Home Address }
ensure that {
  when { UE receives a Router Advertisement containing an IPv6 prefix different from the Home Network Prefix assigned to the UE during the preamble and different from the prefixes contained in the UE's Prefix list }
  then { UE transmits a Binding Update message in order to register its Home Address and Care-of-Address at the Home Agent }
}

```

15.6.2 Conformance requirements

References: The conformance requirements covered in the present TC are specified in: TS 24.303, clauses 5.1.2.3, 5.1.2.4, and 5.2.2.3.

[TS 24.303, clause 5.1.2.3]

The DSMIPv6 Home Link Detection Function is used by the UE to detect if an access interface is on the home link for a PDN from a DSMIPv6 perspective. The Home Link Detection function shall be performed before sending DSMIPv6 Binding Update via the same access interface.

To perform the Home Link Detection procedure, the UE shall compare the assigned Home Network Prefix for a PDN with the IPv6 prefix or prefixes included in the Prefix Information Option in the Router Advertisements received on the local link. The Home Network Prefix can be assigned in a 3GPP access via PCO, as specified in 3GPP TS 24.301 [15], or via IKEv2 as specified in subclause 5.1.2.2. If there is a match between the Home Network Prefix and one of the local prefixes, the UE is attached on the home link over the respective access interface and shall not send a Binding Update to the HA unless the UE currently has a valid DSMIPv6 Binding Update list entry. If the UE has a valid DSMIPv6 Binding Update list entry, the UE shall proceed to perform the action specified in subclause 5.2.2.4. If there is not any match, the UE shall proceed as specified in subclause 5.1.2.4.

NOTE: The UE does not need to run IKEv2 for home link detection if the Home Network prefix is dynamically received in a PCO Information Element.

[TS 24.303, clause 5.1.2.4]

After establishing the security association and obtaining the IPv6 Home Address, the UE shall send a Binding Update message as specified in IETF RFC 3775 [6] and IETF RFC 5555 [2] in order to register its Home Address and Care-of Address at the HA, if it detects it is in the foreign network.

If both IPv4 and IPv6 Care-of Address are received at the foreign network, the UE shall first attempt to use the IPv6 Care-of Address for its binding registration. The UE shall not register both IPv4 and IPv6 Care-of Address to its HA.

If IPv6 Care-of Address is used for initial binding registration, the UE shall send the Binding Update message to the IPv6 address of the HA. In this Binding Update message the H (home registration) and A (acknowledge) bits shall be set. If the UE needs an IPv4 Home Address, the UE shall include the 0.0.0.0 address in the IPv4 Home Address option to request a dynamic IPv4 Home Address.

When IPv6 Care-of Address is used for initial binding registration, the Alternate Care-of Address option shall be used by the UE to carry the Care-of Address inside a Mobility Header which is protected by ESP. If this option is present, the address included in this option is the same address present in the source address of the IPv6 packet.

If IPv4 Care-of Address is used for initial binding registration, the UE shall send the Binding Update as follows (see IETF RFC 5555 [2]):

- The IPv6 packet, with the IPv6 Home Address as the Source Address field of the IPv6 header, shall be encapsulated in UDP.
- The UE shall include the IPv4 Care-of Address as the Source Address field of the IPv4 header and the HA IPv4 address as the Destination Address field of the IPv4 header.
- The UE shall include the IPv4 Care-of Address option containing the IPv4 Care-of Address.
- The UE shall set the H (home registration) and A (acknowledge) flags.
- The UE shall set the F (UDP encapsulation required) flag to 0.
- The UE shall set the R (Mobile Router Flag) flag to 1.
- If the UE needs an IPv4 Home Address, the UE shall include an IPv4 Home Address option with the 0.0.0.0 address in the Binding Update message, as defined in IETF RFC 5555 [2].

When the UE receives the Binding Acknowledgement from the HA, it shall validate it based on the rules described in IETF RFC 3775 [6] and IETF RFC 5555 [2]. If the Binding Acknowledgement contains the successful status code 0 ("Binding Update Accepted"), the UE shall create an entry for the registered Home Address in its Binding Update List and may start sending packets containing its IPv6 Home Address or other IPv6 addresses auto-configured from the assigned home network prefix.

If the Binding Acknowledgement contains a value of 128, the UE may re-send the BU as specified in IETF RFC 3775 [6]. If the Binding Acknowledgement contains a value from 129 to 133 as specified in IETF RFC 3775 [6] or a value from 140 to 143 as specified in IETF RFC 3963 [29], the UE shall not send the BU to the HA and should discover another HA.

If the Binding Acknowledgment contains an IPv4 Address Acknowledgement option with status code value from 0 to 127 (indicating success), the UE shall create two entries in its Binding Update List, one for the IPv6 Home Address and another for the IPv4 Home Address. If the Binding Acknowledgement contains an IPv4 Address Acknowledgment option with status code indicating error (i.e. 128 or higher), the UE shall create an entry only for the IPv6 HoA in its binding update list. Moreover, if the status code is 129 ("Administratively prohibited") or 132 ("Dynamic IPv4 home address assignment not available"), the UE shall not re-send the Binding Update and it shall use only the IPv6 HoA. If the Binding Acknowledgement contains an IPv4 Address Acknowledgement option with status 128 ("Failure, reason unspecified"), 130 ("Incorrect IPv4 home address"), 131 ("Invalid IPv4 address") or 133 ("Prefix allocation unauthorized") it shall re-send the Binding Update including the 0.0.0.0 address in the IPv4 Home Address option. If the Binding Acknowledgement does not contain an IPv4 Address Acknowledgment option, the UE shall create an entry only for the IPv6 HoA in its binding update list.

NOTE: The value to be used to identify the IPv4 address acknowledgement option in the mobility header is 30;

The UE may then send data traffic either with the IPv6 Home Address or with the IPv4 Home Address. If the UE is located on an IP6-enabled link, it shall send IPv6 packets as described in IETF RFC 3775 [6]; IPv4 traffic shall be encapsulated in IPv6 packets as described in IETF RFC 5555 [2]. If the UE is located on an IPv4-only link and the Binding Acknowledgement contains the NAT detection option with the F flag set, the UE shall send IPv6 and IPv4 packets following the vanilla UDP encapsulation rules specified in IETF RFC 5555 [2]. Otherwise the UE shall send IPv6 and IPv4 packets encapsulated in IPv4 as specified in IETF RFC 5555 [2].

Once the DSMIPv6 tunnel is established, the UE may build a DHCPv4 or DHCPv6 message as described in IETF RFC 4039 [26] or IETF RFC 3736 [13] respectively and send it via the DSMIPv6 tunnel as described in IETF RFC 3775 [6] in order to retrieve additional parameters, e.g. Vendor-specific options.

[TS 24.303, clause 5.2.2.3]

If the access network supports IPv6, as soon as the UE has received via a Router Advertisement at least an IPv6 prefix which is not present in its Prefix List, the UE shall perform the Home Link detection as specified in subclause 5.1.2.3.

If the UE detects it is not attached to the home link, the UE shall send a Binding Update to the HA including the newly configured IP address as the Care-of Address in the Source IP address of the packet and optionally in the Alternate Care-of Address Option [6]. The UE build the Binding Update message as specified in IETF RFC 3775 [6].

If the UE has been assigned also an IPv4 Home Address and wants to update also the binding for it, the UE shall include the IPv4 Home Address option including the assigned IPv4 Home Address in the same Binding Update message.

If the UE has been assigned also an IPv4 Home Address and wants to release it, the UE shall not include any IPv4 Home Address option in the same Binding Update.

If the UE does not have an IPv4 Home Address but wants to configure one, the UE shall include the IPv4 Home Address option with the 0.0.0.0 address as specified in subclause 5.1.2.4.

If the access network supports only IPv4, as soon as the UE has configured an IPv4 Care-of Address which is different from the previous Care-of Address, the UE shall send a Binding Update tunnelled in UDP as specified in draft-ietf-mext-nemo-v4traversal [2]. The UE shall set the F flag to "0". The UE shall set the R flag to "1".

Independent of an IPv6 or IPv4 access network the UE shall set the Key Management Capability (K) bit in the Binding Update message.

15.6.3 Test description

15.6.3.1 Pre-test conditions

System Simulator:

- Cell 1.

UE:

- The UE's Prefix List has been cleared.

Preamble:

- The UE is in state Registered, Idle Mode (state 2) on Cell 1 according to [18].
- The UE has acquired an IPv6 address.
- The UE has established a security association with the Home Agent and obtained an IPv6 Home Address, by executing the steps in test case 15.5 with the following exception: the IPv6 home prefix assigned to the UE by the SS shall be the same as the prefix used during IP address acquisition by the UE.

15.6.3.2 Test procedure sequence

Table 15.6.3.2-1: Main behaviour

St	Procedure	Message Sequence		TP	Verdict
		U - S	Message		
1	The SS broadcasts a Router Advertisement with a Prefix Information Option containing an IPv6 prefix different from the Home Network Prefix assigned to the UE during the preamble.	-	-	-	-
2	Check: Does the UE transmit a Binding Update with its IPv6 CoA in the IP Source Address field of the IP Header and the IPv6 Home Agent address in the IP destination Address field of the IP header?	-->	Binding Update	1	P
3	The SS transmits a Binding Acknowledgement accepting the Binding Update.	<--	Binding Acknowledgement	-	-

15.6.3.3 Specific message contents

Table 15.6.3.3-1: Router Advertisement (step 1, Table 15.6.3.2-1)

Derivation path: 36.508, Table 4.7C.2-1			
Field	Value/remark	Comment	Condition
Prefix	IPv6 prefix different from the Home Network Prefix assigned to the UE during the preamble		

15.7 Registration of a new IPv4 CoA (Binding Update/Acknowledgment procedure in IPv4 network)

15.7.1 Test Purpose (TP)

(1)

```

with { UE has established a security association with the Home Agent and received the IPv6 Home Address }
ensure that {
  when { UE is connected to a network supporting IPv4 only }
  then { UE transmits a Binding Update message in order to register its Home Address and Care-of-Address at the Home Agent }
}

```

15.7.2 Conformance requirements

References: The conformance requirements covered in the present TC are specified in: TS 24.303, clauses 5.1.2.3, 5.1.2.4, and 5.2.2.3.

[TS 24.303, clause 5.1.2.3]

The DSMIPv6 Home Link Detection Function is used by the UE to detect if an access interface is on the home link for a PDN from a DSMIPv6 perspective. The Home Link Detection function shall be performed before sending DSMIPv6 Binding Update via the same access interface.

To perform the Home Link Detection procedure, the UE shall compare the assigned Home Network Prefix for a PDN with the IPv6 prefix or prefixes included in the Prefix Information Option in the Router Advertisements received on the local link. The Home Network Prefix can be assigned in a 3GPP access via PCO, as specified in 3GPP TS 24.301 [15], or via IKEv2 as specified in subclause 5.1.2.2. If there is a match between the Home Network Prefix and one of the local prefixes, the UE is attached on the home link over the respective access interface and shall not send a Binding Update to the HA unless the UE currently has a valid DSMIPv6 Binding Update list entry. If the UE has a valid DSMIPv6 Binding Update list entry, the UE shall proceed to perform the action specified in subclause 5.2.2.4. If there is not any match, the UE shall proceed as specified in subclause 5.1.2.4.

NOTE: The UE does not need to run IKEv2 for home link detection if the Home Network prefix is dynamically received in a PCO Information Element.

[TS 24.303, clause 5.1.2.4]

After establishing the security association and obtaining the IPv6 Home Address, the UE shall send a Binding Update message as specified in IETF RFC 3775 [6] and IETF RFC 5555 [2] in order to register its Home Address and Care-of Address at the HA, if it detects it is in the foreign network.

If both IPv4 and IPv6 Care-of Address are received at the foreign network, the UE shall first attempt to use the IPv6 Care-of Address for its binding registration. The UE shall not register both IPv4 and IPv6 Care-of Address to its HA.

If IPv6 Care-of Address is used for initial binding registration, the UE shall send the Binding Update message to the IPv6 address of the HA. In this Binding Update message the H (home registration) and A (acknowledge) bits shall be set. If the UE needs an IPv4 Home Address, the UE shall include the 0.0.0.0 address in the IPv4 Home Address option to request a dynamic IPv4 Home Address.

When IPv6 Care-of Address is used for initial binding registration, the Alternate Care-of Address option shall be used by the UE to carry the Care-of Address inside a Mobility Header which is protected by ESP. If this option is present, the address included in this option is the same address present in the source address of the IPv6 packet.

If IPv4 Care-of Address is used for initial binding registration, the UE shall send the Binding Update as follows (see IETF RFC 5555 [2]):

- The IPv6 packet, with the IPv6 Home Address as the Source Address field of the IPv6 header, shall be encapsulated in UDP.
- The UE shall include the IPv4 Care-of Address as the Source Address field of the IPv4 header and the HA IPv4 address as the Destination Address field of the IPv4 header.
- The UE shall include the IPv4 Care-of Address option containing the IPv4 Care-of Address.
- The UE shall set the H (home registration) and A (acknowledge) flags.
- The UE shall set the F (UDP encapsulation required) flag to 0.
- The UE shall set the R (Mobile Router Flag) flag to 1.
- If the UE needs an IPv4 Home Address, the UE shall include an IPv4 Home Address option with the 0.0.0.0 address in the Binding Update message, as defined in IETF RFC 5555 [2].

When the UE receives the Binding Acknowledgement from the HA, it shall validate it based on the rules described in IETF RFC 3775 [6] and IETF RFC 5555 [2]. If the Binding Acknowledgement contains the successful status code 0 ("Binding Update Accepted"), the UE shall create an entry for the registered Home Address in its Binding Update List and may start sending packets containing its IPv6 Home Address or other IPv6 addresses auto-configured from the assigned home network prefix.

If the Binding Acknowledgement contains a value of 128, the UE may re-send the BU as specified in IETF RFC 3775 [6]. If the Binding Acknowledgement contains a value from 129 to 133 as specified in IETF RFC 3775 [6] or a value from 140 to 143 as specified in IETF RFC 3963 [29], the UE shall not send the BU to the HA and should discover another HA.

If the Binding Acknowledgment contains an IPv4 Address Acknowledgement option with status code value from 0 to 127 (indicating success), the UE shall create two entries in its Binding Update List, one for the IPv6 Home Address and another for the IPv4 Home Address. If the Binding Acknowledgement contains an IPv4 Address Acknowledgment option with status code indicating error (i.e. 128 or higher), the UE shall create an entry only for the IPv6 HoA in its binding update list. Moreover, if the status code is 129 ("Administratively prohibited") or 132 ("Dynamic IPv4 home address assignment not available"), the UE shall not re-send the Binding Update and it shall use only the IPv6 HoA. If the Binding Acknowledgement contains an IPv4 Address Acknowledgement option with status 128 ("Failure, reason unspecified"), 130 ("Incorrect IPv4 home address"), 131 ("Invalid IPv4 address") or 133 ("Prefix allocation unauthorized") it shall re-send the Binding Update including the 0.0.0.0 address in the IPv4 Home Address option. If the Binding Acknowledgement does not contain an IPv4 Address Acknowledgment option, the UE shall create an entry only for the IPv6 HoA in its binding update list.

NOTE: The value to be used to identify the IPv4 address acknowledgement option in the mobility header is 30;

The UE may then send data traffic either with the IPv6 Home Address or with the IPv4 Home Address. If the UE is located on an IP6-enabled link, it shall send IPv6 packets as described in IETF RFC 3775 [6]; IPv4 traffic shall be encapsulated in IPv6 packets as described in IETF RFC 5555 [2]. If the UE is located on an IPv4-only link and the Binding Acknowledgement contains the NAT detection option with the F flag set, the UE shall send IPv6 and IPv4 packets following the vanilla UDP encapsulation rules specified in IETF RFC 5555 [2]. Otherwise the UE shall send IPv6 and IPv4 packets encapsulated in IPv4 as specified in IETF RFC 5555 [2].

Once the DSMIPv6 tunnel is established, the UE may build a DHCPv4 or DHCPv6 message as described in IETF RFC 4039 [26] or IETF RFC 3736 [13] respectively and send it via the DSMIPv6 tunnel as described in IETF RFC 3775 [6] in order to retrieve additional parameters, e.g. Vendor-specific options.

[TS 24.303, clause 5.2.2.3]

If the access network supports IPv6, as soon as the UE has received via a Router Advertisement at least an IPv6 prefix which is not present in its Prefix List, the UE shall perform the Home Link detection as specified in subclause 5.1.2.3.

If the UE detects it is not attached to the home link, the UE shall send a Binding Update to the HA including the newly configured IP address as the Care-of Address in the Source IP address of the packet and optionally in the Alternate Care-of Address Option [6]. The UE build the Binding Update message as specified in IETF RFC 3775 [6].

If the UE has been assigned also an IPv4 Home Address and wants to update also the binding for it, the UE shall include the IPv4 Home Address option including the assigned IPv4 Home Address in the same Binding Update message.

If the UE has been assigned also an IPv4 Home Address and wants to release it, the UE shall not include any IPv4 Home Address option in the same Binding Update.

If the UE does not have an IPv4 Home Address but wants to configure one, the UE shall include the IPv4 Home Address option with the 0.0.0.0 address as specified in subclause 5.1.2.4.

If the access network supports only IPv4, as soon as the UE has configured an IPv4 Care-of Address which is different from the previous Care-of Address, the UE shall send a Binding Update tunnelled in UDP as specified in draft-ietf-mext-nemo-v4traversal [2]. The UE shall set the F flag to "0". The UE shall set the R flag to "1".

Independent of an IPv6 or IPv4 access network the UE shall set the Key Management Capability (K) bit in the Binding Update message.

15.7.3 Test description

15.7.3.1 Pre-test conditions

System Simulator:

- Cell 1.

Preamble:

- The UE is in state Registered, Idle Mode (state 2) on Cell 1 according to [18].
- The UE has acquired an IPv4 address.
- The UE has established a security association with the Home Agent and obtained an IPv6 Home Address, by executing the steps in test case 15.5.

15.7.3.2 Test procedure sequence

Table 15.7.3.2-1: Main behaviour

St	Procedure	Message Sequence		TP	Verdict
		U - S	Message		
1	Check: Does the UE transmit a Binding Update with its IPv4 CoA in the IP Source Address field of the IP Header and the Binding Update encapsulated in an UDP header?	-->	Binding Update	1	P
2	The SS transmits a Binding Acknowledgement accepting the Binding Update.	<--	Binding Acknowledgement	-	-

15.7.3.3 Specific message contents

None.

15.8 Re-registration of IPv6 CoA

15.8.1 Test Purpose (TP)

(1)

```
with { UE has established a security association with the Home Agent and received the IPv6 Home
Address and registered its IPv6 Home Address and IPv6 Care-of-Address at the Home Agent }
ensure that {
  when { registration of its Care-of-Address is about the expire }
  then { UE initiates the re-registration procedure to extend lifetime of the registration of its
Care-of-Address }
}
```

15.8.2 Conformance requirements

References: The conformance requirements covered in the present TC are specified in: TS 24.303, clause 5.3.2.

[TS 24.303, clause 5.3.2]

As specified in IETF RFC 3775 [6], if the UE wants to extend the validity of an existing binding at the HA, the UE shall send a new Binding Update to the HA before the expiration of the lifetime indicated in the received Binding Acknowledgement, even if it is not changing its primary Care-of Address. This Binding Update is usually referred as periodic Binding Update.

The UE shall follow the rules described in IETF RC 3775 [6], IETF RFC 5555 [2] and in subclause 5.1.2.4 to send a periodic Binding Update and handle the associated Binding Acknowledgement. As the UE has not performed any handover, the UE shall confirm the already registered Care of Address and shall indicate the desired lifetime value. In a periodic Binding Update the UE may request an IPv4 Home Address.

15.8.3 Test description

15.8.3.1 Pre-test conditions

System Simulator:

- Cell 1.

UE:

- The UE's Prefix List has been cleared.

Preamble:

- The UE is in state Registered, Idle Mode (state 2) on Cell 1 according to [18].
- The UE has acquired an IPv6 address.

- The UE has established a security association with the Home Agent and obtained an IPv6 Home Address, by executing the steps in test case 15.5 with the following exception: the IPv6 home prefix assigned to the UE by the SS shall be the same as the prefix used during IP address acquisition by the UE.

15.8.3.2 Test procedure sequence

Table 15.8.3.2-1: Main behaviour

St	Procedure	Message Sequence		TP	Verdict
		U - S	Message		
1-3	Steps 1 to 3 of test case 15.6 are performed on Cell 1. NOTE: The UE transmits an initial Binding Update to register its IPv6 Home Address and IPv6 Care-of-Address at the Home Agent. The SS accepts the Binding Update by transmitting a Binding Acknowledgement with a Lifetime set to 10 min.	-	-	-	-
4	Check: Does the UE transmit a Binding Update with its IPv6 CoA in the IP Source Address field of the IP Header and the IPv6 Home Agent address in the IP Destination Address field of the IP header within 10 min of Step 3?	-->	Binding Update	1	P
5	The SS transmits a Binding Acknowledgement accepting the Binding Update.	<--	Binding Acknowledgement	-	-

15.8.3.3 Specific message contents

None.

15.9 Re-registration of IPv4 CoA

15.9.1 Test Purpose (TP)

(1)

```
with { UE has established a security association with the Home Agent and received the IPv6 Home
Address and registered its IPv6 Home Address and IPv4 Care-of-Address at the Home Agent }
ensure that {
  when { registration of its Care-of-Address is about the expire }
  then { UE initiates the re-registration procedure to extend lifetime of the registration of its
Care-of-Address }
}
```

15.2 Conformance requirements

References: The conformance requirements covered in the present TC are specified in: TS 24.303, clause 5.3.2.

[TS 24.303, clause 5.3.2]

As specified in IETF RFC 3775 [6], if the UE wants to extend the validity of an existing binding at the HA, the UE shall send a new Binding Update to the HA before the expiration of the lifetime indicated in the received Binding Acknowledgement, even if it is not changing its primary Care-of Address. This Binding Update is usually referred as periodic Binding Update.

The UE shall follow the rules described in IETF RC 3775 [6], IETF RFC 5555 [2] and in subclause 5.1.2.4 to send a periodic Binding Update and handle the associated Binding Acknowledgement. As the UE has not performed any handover, the UE shall confirm the already registered Care of Address and shall indicate the desired lifetime value. In a periodic Binding Update the UE may request an IPv4 Home Address.

15.9.3 Test description

15.9.3.1 Pre-test conditions

System Simulator:

- Cell 1.

Preamble:

- The UE is in state Registered, Idle Mode (state 2) on Cell 1 according to [18].
- The UE has acquired an IPv4 address.
- The UE has established a security association with the Home Agent and obtained an IPv6 Home Address, by executing the steps in test case 15.5.

15.9.3.2 Test procedure sequence

Table 15.9.3.2-1: Main behaviour

St	Procedure	Message Sequence		TP	Verdict
		U - S	Message		
1-2	Steps 1 to 2 of test case 15.7 are performed on Cell 1. NOTE: The UE transmits an initial Binding Update to register its IPv6 Home Address and IPv4 Care-of-Address at the Home Agent. The SS accepts the Binding Update by transmitting a Binding Acknowledgement with a Lifetime set to 10 min.	-	-	-	-
3	Check: Does the UE transmit a Binding Update with its IPv4 CoA in the IP Source Address field of the IP Header and the IPv4 Home Agent address in the IP destination Address field of the IP header within 10 min of Step 2?	-->	Binding Update	1	P
4	The SS transmits a Binding Acknowledgement accepting the Binding Update.	<--	Binding Acknowledgement	-	-

15.9.3.3 Specific message contents

None.

15.10 Return to home link

15.10.1 Test Purpose (TP)

(1)

```
with { UE has established a security association with the Home Agent and received the IPv6 Home
Address and registered its IPv6 Home Address and IPv6 Care-of-Address at the Home Agent }
ensure that {
  when { UE detects it is attached to the home link }
  then { UE transmits a Binding Update message with the lifetime field set to "0" }
}
```

15.10.2 Conformance requirements

References: The conformance requirements covered in the present TC are specified in: TS 24.303, clause 5.2.2.4.

[TS 24.303, clause 5.2.2.4]

If the access network supports IPv6, as soon as the UE has received via a Router Advertisement message at least an IPv6 prefix which is not present in its Prefix List, the UE shall perform the Home Link detection as specified in subclause 5.1.2.3 to detect if the UE is attaching to the home link. If the UE detects it is attached to the home link and there is a valid DSMIPv6 Binding Update list entry at the UE, the UE shall send a Binding Update with the Lifetime

field set to "0" in order to remove the binding at the HA, as specified in IETF RFC 3775 [6]. If an IPv4 home address was assigned to the UE, as an optimization the UE may not include the IPv4 home address option as the binding for the IPv4 home address will be removed by the HA. Independent of an IPv6 or IPv4 access network the UE shall set the Key Management Capability (K) bit in the de-registration Binding Update message. The UE may preserve the IKEv2 session in order to avoid re-establishing the session when the next handover occurs. If there is not a safe assumption that the UE will remain in the home link (e.g. switching off the non-3GPP radio interface in case of a dual radio terminal), the UE should preserve the IKEv2 session.

15.10.3 Test description

15.10.3.1 Pre-test conditions

System Simulator:

- Cell 1.

UE:

None.

Preamble:

- The UE is in state Registered, Idle Mode (state 2) on Cell 1 according to [18].
- The UE has acquired an IPv6 address.
- The UE has established a security association with the Home Agent and obtained an IPv6 Home Address, by executing the steps in test case 15.5 with the following exception: the IPv6 home prefix assigned to the UE by the SS shall be the same as the prefix used during IP address acquisition by the UE.
- The UE has registered its IPv6 Home Address and its Care-of-Address (acquired IPv6 address) at the Home Agent, by executing the steps in test case 15.6.

15.10.3.2 Test procedure sequence

Table 15.10.3.2-1: Main behaviour

St	Procedure	Message Sequence		TP	Verdict
		U - S	Message		
1	The SS broadcasts a Router Advertisement with a Prefix Information Option containing an IPv6 prefix matching the Home Network Prefix assigned to the UE during the preamble.	-	-	-	-
2	Check: Does the UE transmit a Binding Update message with the lifetime field set to "0"?	-->	Binding Update	1	P
3	The SS transmits a Binding Acknowledgement accepting the Binding Update with the lifetime field set to "0".	<--	Binding Acknowledgement	-	-

15.10.3.3 Specific message contents

Table 15.10.3.3-1: Router Advertisement (step 1, Table 15.10.3.2-1)

Derivation path: 36.508 table 4.7C.2-1			
Field	Value/remark	Comment	Condition
Prefix	IPv6 prefix equal to Home Network Prefix assigned to the UE during preamble		

Table 15.10.3.3-2: Binding Update (step 2, Table 15.10.3.2-1)

Derivation path: 36.508 table 4.7C.2-2			
Information Element	Value/remark	Comment	Condition
Lifetime	'0000000000000000'B		

Table 15.10.3.3-3: Binding Acknowledgement (step 3, Table 15.10.3.2-1)

Derivation path: 36.508 table 4.7C.2-3			
Information Element	Value/remark	Comment	Condition
Lifetime	'0000000000000000'B		

15.11 Dual-Stack Mobile IPv6 detach in IPv6 network

15.11.1 Test Purpose (TP)

(1)

```
with { UE has established a security association with the Home Agent and received the IPv6 Home
Address and registered its IPv6 Home Address and IPv6 Care-of-Address at the Home Agent }
ensure that {
  when { UE receives a Binding Revocation Indication message from the HA }
  then { UE transmits a Binding Revocation Acknowledgement message with the status field set to
'Success' }
}
```

(2)

```
with { UE has received a Binding Revocation Indication message from the HA }
ensure that {
  when { UE has transmitted a Binding Revocation Acknowledgement message with the status field set
to 'Success' }
  then { UE transmits an IKEv2 INFORMATIONAL message containing a DELETE payload to remove the
Ipsec security association associated with the DSMIPv6 registration }
}
```

15.11.2 Conformance requirements

References: The conformance requirements covered in the present TC are specified in: TS 24.303, clauses 5.4.2.1 and 5.4.2.2.

[TS 24.303, clauses 5.4.2.1]

Upon receiving a Binding Revocation Indication (BRI) message according to draft-ietf-mext-binding-revocation [19] from the HA, the UE first shall perform the required validity checks on the BRI according to draft-ietf-mext-binding-revocation [19].

The UE shall send a Binding Revocation Acknowledgement (BRA) as specified in draft-ietf-mext-binding-revocation [19]. In this message the UE shall set the status field to 'Success' to reflect that it has received the BRI message. The BRA message may be tunnelled in UDP or IPv4 as specified in subclause 5.1.2.4 for Binding Update messages.

The UE then shall remove the entry identified in the BRI as deregistered from its binding update list and shall use the procedures defined in IETF RFC 4306 [14] to remove the IPsec security associations associated with the DSMIPv6 registration as described in subclause 5.4.2.2.

[TS 24.303, clause 5.4.2.2]

To detach from a specific PDN to which it is connected through a DSMIPv6 session, the UE shall send a Binding Update with the Lifetime field set to 0 as specified in IETF RFC 3775 [6].

The UE shall use the procedures defined in the IKEv2 protocol in IETF RFC 4306 [14] to remove the IPsec security associations associated with the DSMIPv6 registration. The UE shall close the security associations associated with the DSMIPv6 registration and instruct the HA to do the same by sending the INFORMATIONAL request message

including a DELETE payload. The Protocol ID in the DELETE payload shall be set to "1" (IKE) to indicate that all IPsec ESP security associations that were negotiated within the IKEv2 exchange shall be deleted.

15.11.3 Test description

15.11.3.1 Pre-test conditions

System Simulator:

- Cell 1.

UE:

None.

Preamble:

- The UE is in state Registered, Idle Mode (state 2) on Cell 1 according to [18].
- The UE has acquired an IPv6 address.
- The UE has established a security association with the Home Agent and obtained an IPv6 Home Address, by executing the steps in test case 15.5 with the following exception: the IPv6 home prefix assigned to the UE by the SS shall be the same as the prefix used during IP address acquisition by the UE.
- The UE has registered its IPv6 Home Address and its Care-of-Address (acquired IPv6 address) at the Home Agent, by executing the steps in test case 15.6.

15.11.3.2 Test procedure sequence

Table 15.11.3.2-1: Main behaviour

St	Procedure	Message Sequence		TP	Verdict
		U - S	Message		
1	The SS transmits a Binding Revocation Indication message to the UE.	<--	Binding Revocation Indication	-	-
2	Check: Does the UE transmit a Binding Revocation Acknowledgement message with the status field set to 'Success'?	-->	Binding Revocation Acknowledgement	1	P
3	Check: Does the UE transmit an IKEv2 INFORMATIONAL message containing a DELETE payload?	-->	IKEv2 INFORMATIONAL	2	P
4	The SS transmits an IKEv2 INFORMATIONAL message containing a DELETE payload back to the UE.	<--	IKEv2 INFORMATIONAL	-	-

15.11.3.3 Specific message contents

Table 15.11.3.3-1: IKEv2 INFORMATIONAL (step 3, Table 15.11.3.2-1)

Field	Value/remark	Comment	Condition
IKE Header			
Initiator's IKE_SA SPI	The one identifying the UE in the SA set up during the preamble		
Responder's IKE_SA SPI	The one identifying the HA in the SA set up during the preamble		
Next Payload	'00101110'B	E	
Exchange Type	'00100101'B	INFORMATIONAL	
Encrypted Payload			
Next Payload	'00101010'B	DELETE	
Delete Payload			
Next Payload	'00000000'B	No Next Payload	
Protocol ID	'00000001'B	IKE SA	
Padding	Set by the UE	Fields from Encryption payload	
Pad Length	Set by the UE	Fields from Encryption payload	
Integrity checksum data	Set by the UE	Fields from Encryption payload	

Table 15.11.3.3-2: IKEv2 INFORMATIONAL (step 4, Table 15.11.3.2-1)

Field	Value/remark	Comment	Condition
IKE Header			
Initiator's IKE_SA SPI	Same as that set by the UE at Step 3		
Responder's IKE_SA SPI	Same as that set by the SS at Step 3		
Next Payload	'00101110'B	E	
Exchange Type	'00100101'B	INFORMATIONAL	
Encrypted Payload			
Next Payload	'00101010'B	DELETE	
Delete Payload			
Next Payload	'00000000'B	No Next Payload	
Protocol ID	'00000001'B	IKE SA	
Padding	Set by the SS	Fields from Encryption payload	
Pad Length	Set by the SS	Fields from Encryption payload	
Integrity checksum data	Set by the SS	Fields from Encryption payload	

15.12 Dual-Stack Mobile IPv6 detach in IPv4 network

15.12.1 Test Purpose (TP)

(1)

```

with { UE has established a security association with the Home Agent and received the IPv6 Home Address and registered its IPv6 Home Address and IPv4 Care-of-Address at the Home Agent }
ensure that {
  when { UE receives a Binding Revocation Indication message from the HA with the A flag set }

```

```

    then { UE transmits a Binding Revocation Acknowledgement message with the status field set to
    'Success' }
  }

```

(2)

```

with { UE has received a Binding Revocation Indication message from the HA with the A flag set }
ensure that {
  when { UE has transmitted a Binding Revocation Acknowledgement message with the status field set
  to 'Success' }
  then { UE transmits an IKEv2 INFORMATIONAL message containing a DELETE payload to remove the
  Ipsec security association associated with the DSMIPv6 registration }
}

```

15.12.2 Conformance requirements

References: The conformance requirements covered in the present TC are specified in: TS 24.303, clauses 5.4.2.1 and 5.4.2.2.

[TS 24.303, clauses 5.4.2.1]

Upon receiving a Binding Revocation Indication (BRI) message according to draft-ietf-mext-binding-revocation [19] from the HA, the UE first shall perform the required validity checks on the BRI according to draft-ietf-mext-binding-revocation [19].

If the A (Acknowledge) flag is set in the BRI message, the UE shall send a Binding Revocation Acknowledgement (BRA) as specified in draft-ietf-mext-binding-revocation [19]. In this message the UE shall set the status field to 'Success' to reflect that it has received the BRI message. The BRA message may be tunnelled in UDP or IPv4 as specified in subclause 5.1.2.4 for Binding Update messages.

The UE then shall remove the entry identified in the BRI as deregistered from its binding update list and shall use the procedures defined in IETF RFC 4306 [14] to remove the IPsec security associations associated with the DSMIPv6 registration as described in subclause 5.4.2.2.

[TS 24.303, clause 5.4.2.2]

The UE shall use the procedures defined in the IKEv2 protocol in IETF RFC 4306 [14] to remove the IPsec security associations associated with the DSMIPv6 registration. The UE shall close the security associations associated with the DSMIPv6 registration and instruct the HA to do the same by sending the INFORMATIONAL request message including a DELETE payload. The Protocol ID in the DELETE payload shall be set to "1" (IKE) to indicate that all IPsec ESP security associations that were negotiated within the IKEv2 exchange shall be deleted.

15.12.3 Test description

15.12.3.1 Pre-test conditions

System Simulator:

- Cell 1.

UE:

None.

Preamble:

- The UE is in state Registered, Idle Mode (state 2) on Cell 1 according to [18].
- The UE has acquired an IPv4 address.
- The UE has established a security association with the Home Agent and obtained an IPv6 Home Address, by executing the steps in test case 15.5.
- The UE has registered its IPv6 Home Address and its Care-of-Address (acquired IPv4 address) at the Home Agent, by executing the steps in test case 15.7.

15.12.3.2 Test procedure sequence

Table 15.12.3.2-1: Main behaviour

St	Procedure	Message Sequence		TP	Verdict
		U - S	Message		
1	The SS transmits a Binding Revocation Indication message with the A flag set to the UE.	<--	Binding Revocation Indication	-	-
2	Check: Does the UE transmit a Binding Revocation Acknowledgement message with the status field set to 'Success'?	-->	Binding Revocation Acknowledgement	1	P
3	Check: Does the UE transmit an IKEv2 INFORMATIONAL message containing a DELETE payload?	-->	IKEv2 INFORMATIONAL	2	P
4	The SS transmits an IKEv2 INFORMATIONAL message containing a DELETE payload back to the UE.	<--	IKEv2 INFORMATIONAL	-	-

15.12.3.3 Specific message contents

Table 15.12.3.3-1: IKE_INFORMATIONAL (step 3, Table 15.12.3.2-1)

Field	Value/remark	Comment	Condition
IKE Header			
Initiator's IKE_SA SPI	The one identifying UE in the SA set up during the preamble		
Responder's IKE_SA SPI	The one identifying the HA in the SA set up during the preamble		
Next Payload	'00101110'B	E	
Exchange Type	'00100101'B	INFORMATIONAL	
Encrypted Payload			
Next Payload	'00101010'B	DELETE	
Delete Payload			
Next Payload	'00000000'B	No next payload	
Protocol ID	'00000001'B	IKE SA	
Padding	Set by UE	Fields from Encryption payload	
Pad Length	Set by UE	Fields from Encryption payload	
Integrity checksum data	Set by UE	Fields from Encryption payload	

Table 15.12.3.3-2: IKE_INFORMATIONAL (step 4, Table 15.12.3.2-1)

Field	Value/remark	Comment	Condition
IKE Header			
Initiator's IKE_SA SPI	Same as that set by the UE at Step 3		
Responder's IKE_SA SPI	Same as that set by the SS at Step 3		
Next Payload	'00101110'B	E	
Exchange Type	'00100101'B	INFORMATIONAL	
Encrypted Payload			
Next Payload	'00101010'B	DELETE	
Delete Payload			
Next Payload	'00000000'B	No next payload	
Protocol ID	'00000001'B	IKE SA	
Padding	Set by the SS	Fields from Encryption payload	
Pad Length	Set by the SS	Fields from Encryption payload	
Integrity checksum data	Set by the SS	Fields from Encryption payload	

16 Home (e)NB related

16.1 UE Idle Mode Operations

16.1.1 Cell Selection and Reselection

16.1.1.1 Void

16.1.1.2 Void

17 MBMS in LTE

17.1 MCCH Information Acquisition

17.1.1 MCCH information acquisition/ UE is switched on

17.1.1.1 Test Purpose (TP)

(1)

```
with { UE in switched off state }
ensure that {
  when { UE is switched on }
  then { acquire the MBSFNAreaConfiguration message at the next repetition period }
}
```

17.1.1.2 Conformance requirements

References: The conformance requirements covered in the present TC are specified in: TS 36.331, clause 5.8.2.2 and 5.8.2.3.

[TS 36.331, clause 5.8.2.2]

A UE interested to receive MBMS services shall apply the MCCH information acquisition procedure upon entering the corresponding MBSFN area (e.g. upon power on, following UE mobility) and upon receiving a notification that the MCCH information has changed. A UE that is receiving an MBMS service shall apply the MCCH information

acquisition procedure to acquire the MCCH, that corresponds with the service that is being received, at the start of each modification period.

Unless explicitly stated otherwise in the procedural specification, the MCCH information acquisition procedure overwrites any stored MCCH information, i.e. delta configuration is not applicable for MCCH information and the UE discontinues using a field if it is absent in MCCH information unless explicitly specified otherwise.

[TS 36.331, clause 5.5.2.3]

An MBMS capable UE shall:

1> if the procedure is triggered by a MCCH information change notification:

2> start acquiring the *MBSFNAreaConfiguration* message from the beginning of the modification period following the one in which the change notification was received;

NOTE 1: The UE continues using the previously received MCCH information until the new MCCH information has been acquired.

1> if the UE enters an MBSFN area:

2> acquire the *MBSFNAreaConfiguration* message at the next repetition period;

1> if the UE is receiving an MBMS service:

2> start acquiring the *MBSFNAreaConfiguration* message, that corresponds with the service that is being received, from the beginning of each modification period;

17.1.1.3 Test description

17.1.1.3.1 Pre-test conditions

System Simulator:

- Cell 1
- System information combination 15 as defined in TS 36.508[18] clause 4.4.3.1 is used in E-UTRA cells

UE:

- E-UTRAN UE supporting MBMS services.

Preamble:

- UE is in state Switched OFF (state 1).

17.1.1.3.2 Test procedure sequence

Table 17.1.1.3.2-1: Main behaviour

St	Procedure	Message Sequence		TP	Verdict
		U - S	Message		
1	The UE is switched on.	-	-	-	-
2	The generic procedure described in TS 36.508 subclause 4.5.2A.3 is performed on Cell 1 to activate the UE test mode.	-	-	-	-
3	SS transmits <i>MBSFNAreaConfiguration</i> message	<--	<i>MBSFNAreaConfiguration</i>	-	-
4	Wait for a period equal to the MCCH modification period for the UE to receive <i>MBSFNAreaConfiguration</i> message	-	-	-	-
5	The generic procedures described in TS 36.508 subclause 4.5.3A.3 and 4.5.4.3 are performed on Cell 1 activating UE test loop Mode C	-	-	-	-
6	The SS transmits a valid MAC PDU including 'MCH Scheduling Information MAC Control Element with LCID='00001', Stop MTCH='1000000000'	<--	MAC PDU (MCH Scheduling Information MAC Control Element: LCID='00001', Stop MTCH='1000000000')	-	-
7	The SS transmits 10 MBMS Packets on the MTCH.	<--	MBMS Packets.	-	-
8	The SS transmits an UE TEST LOOP MODE C MBMS PACKET COUNTER REQUEST message.	<--	UE TEST LOOP MODE C MBMS PACKET COUNTER REQUEST	-	-
9	UE responds with UE TEST LOOP MODE C MBMS PACKET COUNTER RESPONSE.	-->	UE TEST LOOP MODE C MBMS PACKET COUNTER RESPONSE	-	-
10	Check: Does the number of reported MBMS Packets received on the MTCH is greater than zero?	-	-	1	P

17.1.1.3.3 Specific message contents

Table 17.1.1.3.3-1: *SystemInformationBlockType2* for Cell 1 (preamble and all steps, Table 17.1.1.3.2-1)

Derivation Path: 36.508 table 4.4.3.3-1, condition MBMS.
--

Table 17.1.1.3.3-2: ACTIVATE TEST MODE (step 2, Table 17.1.1.3.2-1)

Derivation Path: 36.508, Table 4.7A-1, condition UE TEST LOOP MODE C
--

Table 17.1.1.3.3-3: CLOSE UE TEST LOOP (step 5, Table 17.1.1.3.2-1)

Derivation Path: 36.508, Table 4.7A-3, condition UE TEST LOOP MODE C
--

17.1.2 MCCH information acquisition/ cell reselection to a cell in a new MBSFN area

17.1.2.1 Test Purpose (TP)

(1)

```

with { UE in E-UTRAN RRC IDLE state }
ensure that {
  when { UE cell reselection to a cell in a new MBSFN area }
  then { UE shall acquire the MBSFNAreaConfiguration message at the next repetition period }
}

```

17.1.2.2 Conformance requirements

References: The conformance requirements covered in the present TC are specified in: TS 36.331, clause 5.8.2.2 and 5.8.2.3.

[TS 36.331, clause 5.8.2.2]

A UE interested to receive MBMS services shall apply the MCCH information acquisition procedure upon entering the corresponding MBSFN area (e.g. upon power on, following UE mobility) and upon receiving a notification that the MCCH information has changed. A UE that is receiving an MBMS service shall apply the MCCH information acquisition procedure to acquire the MCCH, that corresponds with the service that is being received, at the start of each modification period.

Unless explicitly stated otherwise in the procedural specification, the MCCH information acquisition procedure overwrites any stored MCCH information, i.e. delta configuration is not applicable for MCCH information and the UE discontinues using a field if it is absent in MCCH information unless explicitly specified otherwise.

[TS 36.331, clause 5.5.2.3]

An MBMS capable UE shall:

- 1> if the procedure is triggered by a MCCH information change notification:
 - 2> start acquiring the *MBSFNAreaConfiguration* message from the beginning of the modification period following the one in which the change notification was received;

NOTE 1: The UE continues using the previously received MCCH information until the new MCCH information has been acquired.

- 1> if the UE enters an MBSFN area:
 - 2> acquire the *MBSFNAreaConfiguration* message at the next repetition period;
- 1> if the UE is receiving an MBMS service:
 - 2> start acquiring the *MBSFNAreaConfiguration* message, that corresponds with the service that is being received, from the beginning of each modification period;

17.1.2.3 Test description

17.1.2.3.1 Pre-test conditions

System Simulator:

- Cell 1 and cell2 which belong to different MBSFN areas.
- System information combination 16 as defined in TS 36.508[18] clause 4.4.3.1 is used in E-UTRA cells

UE:

- E-UTRAN UE supporting MBMS services

Preamble:

- UE is in Registered, Idle mode, Test Mode Activated (State 2A) according to [18] in Cell 1(serving cell) with the UE TEST LOOP MODE C.

17.1.2.3.2 Test procedure sequence

Table 17.1.2.3.2-1 illustrates the downlink power levels and other changing parameters to be applied for the cells at various time instants of the test execution. Row marked "T0" denotes the initial conditions after preamble, while columns marked "T1", and "T2" are to be applied subsequently. The exact instants on which these values shall be applied are described in the texts in this clause.

Table 17.1.2.3.2-1: Time instances of cell power level and parameter changes

	Parameter	Unit	Cell 1	Cell 2	Remark
T0	Cell-specific RS EPRE	dBm/15k Hz	-85	-91	
T1	Cell-specific RS EPRE	dBm/15k Hz	-85	-79	The power level values are assigned to satisfy $R_{Cell\ 1} < R_{Cell\ 2}$.

Table 17.1.2.3.2-2: Main behaviour

St	Procedure	Message Sequence		TP	Verdict
		U - S	Message		
1	The SS changes Cell 2 level according to the row "T1" in table 17.1.2.3.2-1.	-	-	-	-
2	The UE executes the generic test procedure described in TS 36.508 subclause 6.4.2.7 and UE should camp on E-UTRA Cell 2. NOTE: The UE performs a TAU procedure and the RRC connection is released.	-	-	-	-
3	SS transmits <i>MBSFNAreaConfiguration</i> message	<--	<i>MBSFNAreaConfiguration</i>	-	-
4	Wait for a period equal to the MCCH modification period for the UE to receive <i>MBSFNAreaConfiguration</i> message		-	-	-
5	The generic procedures described in TS 36.508 subclause 4.5.3A.3 and 4.5.4.3 are performed on Cell 1 activating UE test loop Mode C.	-	-	-	-
6	The SS transmits a valid MAC PDU including 'MCH Scheduling Information MAC Control Element with LCID='00001', Stop MTCH='1000000000'	<--	MAC PDU (MCH Scheduling Information MAC Control Element: LCID='00001', Stop MTCH='1000000000')	-	-
7	The SS transmits 10 MBMS Packets on the MTCH.	<--	MBMS Packets.	-	-
8	The SS transmits an UE TEST LOOP MODE C MBMS PACKET COUNTER REQUEST message to set UE to Mode C.	<--	UE TEST LOOP MODE C MBMS PACKET COUNTER REQUEST	-	-
9	UE responds with UE TEST LOOP MODE C MBMS PACKET COUNTER RESPONSE.	-->	UE TEST LOOP MODE C MBMS PACKET COUNTER RESPONSE	-	-
10	Check: Does the number of reported MBMS Packets received on the MTCH is greater than zero?	-	-	1	P

17.1.2.3.3 Specific message contents

Table 17.1.2.3.3-1: SystemInformationBlockType2 for Cells 1 and 2 (preamble and all steps, Table 17.1.2.3.2-2)

Derivation Path: 36.508 table 4.4.3.3-1, condition MBMS.
--

Table 17.1.2.3.3-1a: ACTIVATE TEST MODE (preamble)

Derivation Path: 36.508, Table 4.7A-1, condition UE TEST LOOP MODE C.

Table 17.1.2.3.3-2: CLOSE UE TEST LOOP (step 5, Table 17.1.2.3.2-2)

Derivation Path: 36.508, Table 4.7A-3, condition UE TEST LOOP MODE C
--

17.1.3 MCCH information acquisition/ UE handover to a cell in a new MBSFN area

17.1.3.1 Test Purpose (TP)

(1)

```
with { UE in E-UTRAN RRC CONNECTED state }
ensure that {
  when { UE handovers to a cell in a new MBSFN area }
  then { UE should acquire the MBSFNAreaConfiguration message at the next repetition period }
}
```

17.1.3.2 Conformance requirements

References: The conformance requirements covered in the present TC are specified in: TS 36.331, clause 5.8.2.2 and 5.8.2.3.

[TS 36.331, clause 5.8.2.2]

A UE interested to receive MBMS services shall apply the MCCH information acquisition procedure upon entering the corresponding MBSFN area (e.g. upon power on, following UE mobility) and upon receiving a notification that the MCCH information has changed. A UE that is receiving an MBMS service shall apply the MCCH information acquisition procedure to acquire the MCCH that corresponds with the service that is being received, at the start of each modification period.

Unless explicitly stated otherwise in the procedural specification, the MCCH information acquisition procedure overwrites any stored MCCH information, i.e. delta configuration is not applicable for MCCH information and the UE discontinues using a field if it is absent in MCCH information unless explicitly specified otherwise.

[TS 36.331, clause 5.5.2.3]

An MBMS capable UE shall:

- 1> if the procedure is triggered by a MCCH information change notification:
 - 2> start acquiring the *MBSFNAreaConfiguration* message from the beginning of the modification period following the one in which the change notification was received;

NOTE 1: The UE continues using the previously received MCCH information until the new MCCH information has been acquired.

- 1> if the UE enters an MBSFN area:
 - 2> acquire the *MBSFNAreaConfiguration* message at the next repetition period;
- 1> if the UE is receiving an MBMS service:
 - 2> start acquiring the *MBSFNAreaConfiguration* message, that corresponds with the service that is being received, from the beginning of each modification period;

17.1.3.3 Test description

17.1.3.3.1 Pre-test conditions

System Simulator:

- Cell 1 and cell 2 which belong to different MBSFN areas.
- System information combination 16 as defined in TS 36.508[18] clause 4.4.3.1 is used in E-UTRA cells.

UE:

- E-UTRAN UE supporting MBMS services

Preamble:

- UE is in state Loopback Activated (state 4) according to [18] in Cell 1(serving cell) with the UE TEST LOOP MODE C.

17.1.3.3.2 Test procedure sequence

Table 17.1.3.3.2-1 illustrates the downlink power levels and other changing parameters to be applied for the cells at various time instants of the test execution. Row marked "T0" denotes the initial conditions after preamble, while columns marked "T1", and "T2" are to be applied subsequently. The exact instants on which these values shall be applied are described in the texts in this clause.

Table 17.1.3.3.2-1: Time instances of cell power level and parameter changes

	Parameter	Unit	Cell 1	Cell 2	Remark
T0	Cell-specific RS EPRE	dBm/15k Hz	-85	-91	The power level values are such that measurement results for Cell 1 (M1) and Cell 4 (M4) satisfy exit condition for event A3 ($M4 < M1$) (NOTE 1).
T1	Cell-specific RS EPRE	dBm/15k Hz	-85	-79	The power level values are such that measurement results for Cell 1 (M1) and Cell 4 (M4) satisfy entry condition for event A3 ($M4 > M1$) (NOTE 1).

Table 17.1.3.3.2-2: Main behaviour

St	Procedure	Message Sequence		TP	Verdict
		U - S	Message		
1	The SS transmits an <i>RRCCONNECTIONRECONFIGURATION</i> message to setup intra frequency measurement on Cell 1.	<--	<i>RRCCONNECTIONRECONFIGURATION</i>	-	-
2	The UE transmits an <i>RRCCONNECTIONRECONFIGURATIONCOMPLETE</i> message on Cell 1 to confirm the setup of intra frequency measurement.	-->	<i>RRCCONNECTIONRECONFIGURATIONCOMPLETE</i>	-	-
3	The SS changes Cell 1, Cell 2 parameters according to the row "T1" in table 17.1.3.3.2-1.	-	-	-	-
4	The UE transmits a <i>MEASUREMENTREPORT</i> message to report event A3 on Cell 1 with the measured RSRP, RSRQ value for Cell 2.	-->	<i>MEASUREMENTREPORT</i>	-	-
5	The SS transmits an <i>RRCCONNECTIONRECONFIGURATION</i> message to order the UE to perform intra frequency handover to Cell 2.	<--	<i>RRCCONNECTIONRECONFIGURATION</i>	-	-
6	UE transmits an <i>RRCCONNECTIONRECONFIGURATIONCOMPLETE</i> message on Cell 2	-->	<i>RRCCONNECTIONRECONFIGURATIONCOMPLETE</i>	-	-
7	SS transmits <i>MBSFNAREACONFIGURATION</i> message	<--	<i>MBSFNAREACONFIGURATION</i>		
8	Wait for a period equal to the MCCH modification period for the UE to receive <i>MBSFNAREACONFIGURATION</i> message		-		
9	The SS transmits a valid MAC PDU including 'MCH Scheduling Information MAC Control Element with LCID='00001', Stop MTCH='10000000000'	<--	MAC PDU (MCH Scheduling Information MAC Control Element: LCID='00001', Stop MTCH='10000000000')	-	-
10	The SS transmits 10 MBMS Packets on the MTCH.	<--	MBMS Packets.	-	-
11	The SS transmits an UE TEST LOOP MODE C MBMS PACKET COUNTER REQUEST message to set UE to Mode C.	<--	UE TEST LOOP MODE C MBMS PACKET COUNTER REQUEST	-	-
12	UE responds with UE TEST LOOP MODE 3 MBMS PACKET COUNTER RESPONSE.	-->	UE TEST LOOP MODE C MBMS PACKET COUNTER RESPONSE	-	-
13	Check: Does the number of reported MBMS Packets received on the MTCH is greater than zero?	-	-	1	P

17.1.3.3.3 Specific message contents

Table 17.1.3.3.3-1: *SystemInformationBlockType2* for Cells 1 and 2 (preamble and all steps, Table 17.1.3.3.2-2)

Derivation Path: 36.508 table 4.4.3.3-1, condition MBMS.
--

Table 17.1.3.3.3-1a: ACTIVATE TEST MODE (preamble)

Derivation Path: 36.508, Table 4.7A-1, condition UE TEST LOOP MODE C.

Table 17.1.3.3.3-1b: CLOSE UE TEST LOOP (step 8a, Table 17.1.3.3.2-2)

Derivation Path: 36.508, Table 4.7A-3, condition UE TEST LOOP MODE C.

Table 17.1.3.3.3-2: *RRCCONNECTIONRECONFIGURATION* (step 1, Table 17.1.3.3.2-2)

Derivation Path: 36.508, Table 4.6.1-8, condition MEAS
--

Table 17.1.3.3.3-3: MeasConfig (Table 17.1.3.3.3-2)

Derivation Path: 36.508, Table 4.6.6-1			
Information Element	Value/remark	Comment	Condition
MeasConfig SEQUENCE {			
measObjectToAddModList SEQUENCE (SIZE (1..maxObjectId)) OF SEQUENCE {	1 entry		
measObjectId[1]	IdMeasObject-f1		
measObject[1]	MeasObjectEUTRA-GENERIC(f1)		
}			
reportConfigToAddModList SEQUENCE (SIZE (1..maxReportConfigId)) OF SEQUENCE {	1 entry		
reportConfigId[1]	IdReportConfig-A3		
reportConfig[1]	ReportConfigEUTRA-A3		
}			
measIdToAddModList SEQUENCE (SIZE (1..maxMeasId)) OF SEQUENCE {	1 entry		
measId[1]	1		
measObjectId[1]	IdMeasObject-f1		
reportConfigId[1]	IdReportConfig-A3		
}			
}			

Table 17.1.3.3.3-4: MeasurementReport (step 4, Table 17.1.3.3.2-2)

Derivation Path: 36.508, Table 4.6.1-5			
Information Element	Value/remark	Comment	Condition
MeasurementReport ::= SEQUENCE {			
criticalExtensions CHOICE {			
c1 CHOICE{			
measurementReport-r8 SEQUENCE {			
measResults SEQUENCE {			
measId	1		
measResultServCell SEQUENCE {			
rsrpResult	(0..97)		
rsrqResult	(0..34)		
}			
measResultNeighCells CHOICE {			
measResultListEUTRA SEQUENCE (SIZE (1..maxCellReport)) OF SEQUENCE {	1 entry		
physCellId[1]	PhysicalCellIdentity of Cell 2		
cgi-Info[1]	Not present		
measResult[1] SEQUENCE {			
rsrpResult	(0..97)		
rsrqResult	(0..34)		
}			
}			
}			
}			
}			
}			
}			

Table 17.1.3.3.3-5: RRCConnectionReconfiguration (step 5, Table 17.1.3.3.2-2)

Derivation Path: 36.508, Table 4.6.1-8, condition HO
--

Table 17.1.3.3.3-6: *MobilityControlInfo* (Table 17.1.3.3.2-2)

Derivation Path: 36.508, Table 4.6.5-1			
Information Element	Value/remark	Comment	Condition
MobilityControlInfo ::= SEQUENCE {			
targetPhysCellId	PhysicalCellId of Cell 2		
carrierFreq	Not present		
}			

17.1.4 MCCH information acquisition/ UE is receiving an MBMS service

17.1.4.1 Test Purpose (TP)

(1)

```
with { UE in E-UTRAN RRC IDLE state }
ensure that {
  when { UE is receiving an MBMS service }
  then { UE shall start acquiring the MBSFNAreaConfiguration message that corresponds with the
service that is being received, from the beginning of each modification period }
}
```

17.1.4.2 Conformance requirements

References: The conformance requirements covered in the present TC are specified in: TS 36.331, clause 5.8.2.2 and 5.8.2.3.

[TS 36.331, clause 5.8.2.2]

A UE interested to receive MBMS services shall apply the MCCH information acquisition procedure upon entering the corresponding MBSFN area (e.g. upon power on, following UE mobility) and upon receiving a notification that the MCCH information has changed. A UE that is receiving an MBMS service shall apply the MCCH information acquisition procedure to acquire the MCCH that corresponds with the service that is being received, at the start of each modification period.

Unless explicitly stated otherwise in the procedural specification, the MCCH information acquisition procedure overwrites any stored MCCH information, i.e. delta configuration is not applicable for MCCH information and the UE discontinues using a field if it is absent in MCCH information unless explicitly specified otherwise.

[TS 36.331, clause 5.5.2.3]

An MBMS capable UE shall:

- 1> if the procedure is triggered by a MCCH information change notification:
 - 2> start acquiring the *MBSFNAreaConfiguration* message from the beginning of the modification period following the one in which the change notification was received;

NOTE 1: The UE continues using the previously received MCCH information until the new MCCH information has been acquired.

- 1> if the UE enters an MBSFN area:
 - 2> acquire the *MBSFNAreaConfiguration* message at the next repetition period;
- 1> if the UE is receiving an MBMS service:
 - 2> start acquiring the *MBSFNAreaConfiguration* message, that corresponds with the service that is being received, from the beginning of each modification period;

17.1.4.3 Test description

17.1.4.3.1 Pre-test conditions

System Simulator:

- Cell 1
- System information combination 15 as defined in TS 36.508[18] clause 4.4.3.1 is used in E-UTRA cells

UE:

- E-UTRAN UE supporting MBMS services.

Preamble:

- UE is in Registered, Idle mode, Test Mode Activated (State 2A) according to [18] in Cell 1(serving cell) with the UE TEST LOOP MODE C.

17.1.4.3.2 Test procedure sequence

Table 17.1.4.3.2-1: Main behaviour

St	Procedure	Message Sequence		TP	Verdict
		U - S	Message		
1	SS transmits <i>MBSFNAreaConfiguration</i> message	<--	<i>MBSFNAreaConfiguration</i>	-	-
2	Wait for a period equal to the MCCH modification period for the UE to receive <i>MBSFNAreaConfiguration</i> message	-	-	-	-
3	The SS transmits a valid MAC PDU including 'MCH Scheduling Information MAC Control Element with LCID='00001', Stop MTCH='00000001010'	<--	MAC PDU (MCH Scheduling Information MAC Control Element: LCID='00001', Stop MTCH='00000001010')	-	-
4	The SS transmits 10 MBMS Packets on the MTCH.	<--	MBMS Packets.	-	-
5	SS transmits an updated system information [contents different from in preamble]	-	-	-	-
6	SS transmits <i>MBSFNAreaConfiguration</i> message at the beginning of next modification period.	<--	<i>MBSFNAreaConfiguration</i>	-	-
7	Wait for a period equal to the MCCH modification period for the UE to receive <i>MBSFNAreaConfiguration</i> message	-	-	-	-
8	The generic procedures described in TS 36.508 subclause 4.5.3A.3 and 4.5.4.3 are performed on Cell 1 to close UE test loop	-	-	-	-
9	The SS transmits a valid MAC PDU including 'MCH Scheduling Information MAC Control Element with LCID='00001', Stop MTCH='00000001010'	<--	MAC PDU (MCH Scheduling Information MAC Control Element: LCID='00001', Stop MTCH='00000001010')	-	-
10	The SS transmits 10 MBMS Packets on the MTCH.	<--	MBMS Packets.	-	-
11	The SS transmits an UE TEST LOOP MODE C MBMS PACKET COUNTER REQUEST message.	<--	UE TEST LOOP MODE C MBMS PACKET COUNTER REQUEST	-	-
12	UE responds with UE TEST LOOP MODE C MBMS PACKET COUNTER RESPONSE.	-->	UE TEST LOOP MODE C MBMS PACKET COUNTER RESPONSE	-	-
13	Check: Does the number of reported MBMS Packets received on the MTCH is greater than zero?	-	-	1	P
Note: In steps 4 and 10 to guarantee that SS should transmit MBMS Packets in the subframes indicated in steps 3 and 9 separately.					

17.1.4.3.3 Specific message contents

Table 17.1.4.3.3-1: SystemInformationBlockType2 for Cell 1 (preamble)

Derivation Path: 36.508 table 4.4.3.3-1			
Information Element	Value/remark	Comment	Condition
SystemInformationBlockType2 ::= SEQUENCE {			
mbsfn-SubframeConfiguration SEQUENCE {			
radioframeAllocationPeriod	n4		
radioframeAllocationOffset	0		
subframeAllocation CHOICE{			
oneFrame	'110000'		
}			
}			
}			

Table 17.1.4.3.3-1a: ACTIVATE TEST MODE (preamble)

Derivation Path: 36.508, Table 4.7A-1, condition UE TEST LOOP MODE C.

Table 17.1.4.3.3-2: SystemInformationBlockType2 for Cell 1 (step 5, Table 17.1.4.3.2-1)

Derivation Path: 36.508 table 4.4.3.3-1, condition MBMS.			
Information Element	Value/remark	Comment	Condition

Table 17.1.4.3.3-3: MBSFNAreaConfiguration (steps 5, 6 and 9, Table 17.1.4.3.2-1)

Derivation Path: 36.508 table 4.6.1-4A			
Information Element	Value/remark	Comment	Condition
MBSFNAreaConfiguration-r9 ::= SEQUENCE {			
commonSF-Alloc-r9 SEQUENCE (SIZE (1..maxMBSFN-Allocations)) OF SEQUENCE {			
commonSF-AllocPeriod-r9	rf32		
pmch-InfoList-r9 SEQUENCE (SIZE (0..maxPMCH-PerMBSFN)) OF SEQUENCE {			
pmch-Config-r9 SEQUENCE {			
sf-AllocEnd-r9	7		
dataMCS-r9	0		
mch-SchedulingPeriod-r9	rf256		
}			
}			
}			

Table 17.1.4.3.3-4: CLOSE UE TEST LOOP (step 8, Table 17.1.4.3.2-1)

Derivation Path: 36.508, Table 4.7A-3, condition UE TEST LOOP MODE C
--

17.1.5 MCCH information acquisition/ UE is not receiving MBMS data

17.1.5.1 Test Purpose (TP)

(1)

```

with { UE in E-UTRAN RRC IDLE state }
ensure that {
  when { UE is not receiving an MBMS service and receives MCCH information change notification }
    then { UE shall start acquiring the MBSFNAreaConfiguration message from the beginning of the
modification period following the one in which the change notification was received }
}

```

(2)

```

with { UE in E-UTRAN RRC IDLE state }
ensure that {
  when { UE is not in MBSFN area service and enters another cell in MBSFN area }
  then { UE shall start acquiring the MBSFNAreaConfiguration message from the beginning of the
repetition period }
}

```

17.1.5.2 Conformance requirements

References: The conformance requirements covered in the present TC are specified in: TS 36.331, clause 5.8.2.2 and 5.8.2.3.

[TS 36.331, clause 5.8.2.2]

A UE interested to receive MBMS services shall apply the MCCH information acquisition procedure upon entering the corresponding MBSFN area (e.g. upon power on, following UE mobility) and upon receiving a notification that the MCCH information has changed. A UE that is receiving an MBMS service shall apply the MCCH information acquisition procedure to acquire the MCCH that corresponds with the service that is being received, at the start of each modification period.

Unless explicitly stated otherwise in the procedural specification, the MCCH information acquisition procedure overwrites any stored MCCH information, i.e. delta configuration is not applicable for MCCH information and the UE discontinues using a field if it is absent in MCCH information unless explicitly specified otherwise.

[TS 36.331, clause 5.5.2.3]

An MBMS capable UE shall:

- 1> if the procedure is triggered by a MCCH information change notification:
 - 2> start acquiring the *MBSFNAreaConfiguration* message from the beginning of the modification period following the one in which the change notification was received;

NOTE 1: The UE continues using the previously received MCCH information until the new MCCH information has been acquired.

- 1> if the UE enters an MBSFN area:
 - 2> acquire the *MBSFNAreaConfiguration* message at the next repetition period;
- 1> if the UE is receiving an MBMS service:
 - 2> start acquiring the *MBSFNAreaConfiguration* message, that corresponds with the service that is being received, from the beginning of each modification period;

17.1.5.3 Test description

17.1.5.3.1 Pre-test conditions

System Simulator:

- Cell 1 belongs to MBSFN area
- Cell 2 does not belong to any MBSFN areas
- System information combination 15 as defined in TS 36.508[18] clause 4.4.3.1 is used in E-UTRA Cell 1
- System information combination 1 as defined in TS 36.508[18] clause 4.4.3.1 is used in E-UTRA Cell 2

UE:

- E-UTRAN UE supporting MBMS services.
- the UE is configured to receive MBMS services

Preamble:

- UE is in Registered, Idle mode, Test Mode Activated (State 2A) according to [18] in Cell 1(serving cell) with the UE TEST LOOP MODE C.

17.1.5.3.2 Test procedure sequence

Table 17.1.2.3.2-1 illustrates the downlink power levels and other changing parameters to be applied for the cells at various time instants of the test execution. Row marked "T0" denotes the initial conditions after preamble, while columns marked "T1", and "T2" are to be applied subsequently. The exact instants on which these values shall be applied are described in the texts in this clause.

Table 17.1.5.3.2-1: Time instances of cell power level and parameter changes

	Parameter	Unit	Cell 1	Cell 2	Remark
T0	Cell-specific RS EPRE	dBm/15k Hz	-85	-91	
T1	Cell-specific RS EPRE	dBm/15k Hz	-91	-85	The power level values are assigned to satisfy $R_{\text{Cell 1}} < R_{\text{Cell 2}}$.
T2	Cell-specific RS EPRE	dBm/15k Hz	-85	-91	The power level values are assigned to satisfy $R_{\text{Cell 1}} > R_{\text{Cell 2}}$.

Table 17.1.5.3.2-2: Main behaviour

St	Procedure	Message Sequence		TP	Verdict
		U - S	Message		
1	SS transmits MCCH information change notification	-	(MCCH information change notification)	-	-
2	Wait for a period equal to the MCCH modification period for the UE to receive <i>MBSFNAreaConfiguration</i> message from the beginning of the modification period following the one in which the change notification was received	-	-	-	-
3	The generic procedures described in TS 36.508 subclause 4.5.3A.3 and 4.5.4.3 are performed on Cell 1 to close UE test loop	-	-	-	-
4	The SS transmits a valid MAC PDU including 'MCH Scheduling Information MAC Control Element with LCID='00001', Stop MTCH='00000001010'	<--	MAC PDU (MCH Scheduling Information MAC Control Element: LCID='00001', Stop MTCH='00000001010')	-	-
5	The SS transmits 10 MBMS Packets on the MTCH.	<--	MBMS Packets	-	-
6	The SS waits for [1] sec to allow UE to receive MBMS Packets	-	-	-	-
7	The SS transmits an UE TEST LOOP MODE C MBMS PACKET COUNTER REQUEST message.	<--	UE TEST LOOP MODE C MBMS PACKET COUNTER REQUEST	-	-
8	UE responds with UE TEST LOOP MODE C MBMS PACKET COUNTER RESPONSE.	-->	UE TEST LOOP MODE C MBMS PACKET COUNTER RESPONSE	-	-
9	Check: Does the number of reported MBMS Packets received on the MTCH is greater than zero?	-	-	1	P
10	The SS changes Cell 1 and Cell 2 level according to the row "T1" in table 17.1.5.3.2-1.	-	-	-	-
11	The UE executes the generic test procedure described in TS 36.508 subclause 6.4.2.7 and UE should camp on E-UTRA Cell 2. NOTE: The UE performs a TAU procedure and the RRC connection is released.	-	-	-	-
12	The SS changes Cell 1 and Cell2 level according to the row "T2" in table 17.1.5.3.2-1.	-	-	-	-
13	The UE performs Cell Reselection from Cell2 to Cell1.	-	-	-	-
14	The UE executes the generic test procedure described in TS 36.508 subclause 6.4.2.7 and UE should camp on E-UTRA Cell 1. NOTE: The UE performs a TAU procedure and the RRC connection is released.	-	-	-	-
15	Wait for a period equal to the MCCH repetition period for the UE to receive <i>MBSFNAreaConfiguration</i> message	-	-	-	-
16	The SS transmits a valid MAC PDU including 'MCH Scheduling Information MAC Control Element with LCID='00001', Stop MTCH='00000001010'	<--	MAC PDU (MCH Scheduling Information MAC Control Element: LCID='00001', Stop MTCH='00000001010')	-	-
17	The SS transmits 10 MBMS Packets on the MTCH.	<--	MBMS Packets	-	-
18	The SS waits for [1] sec to allow UE to receive MBMS Packets	-	-	-	-
19	The SS transmits an UE TEST LOOP MODE C MBMS PACKET COUNTER REQUEST message.	<--	UE TEST LOOP MODE C MBMS PACKET COUNTER REQUEST	-	-
20	UE responds with UE TEST LOOP MODE C MBMS PACKET COUNTER RESPONSE.	-->	UE TEST LOOP MODE C MBMS PACKET COUNTER RESPONSE	-	-
21	Check: Does the number of reported MBMS Packets received on the MTCH is greater than the number of MBMS Packets reported in step9?	-	-	2	P

Note: In steps 5 and 17, to guarantee that SS should transmit MBMS Packets in the subframes indicated in steps 4 and 16 separately.

17.1.5.3.3 Specific message contents

Table 17.1.5.3.3-1: SystemInformationBlockType2 for Cell 1 (preamble and all steps, Table 17.1.5.3.2-2)

Derivation Path: 36.508 table 4.4.3.3-1, condition MBMS.

Table 17.1.5.3.3-1a: ACTIVATE TEST MODE (preamble)

Derivation Path: 36.508, Table 4.7A-1, condition UE TEST LOOP MODE C.

Table 17.1.5.3.3-2: MBSFNAreaConfiguration (steps 2, 4 15 and 16, Table 17.1.5.3.2-2)

Derivation Path: 36.508 table 4.6.1-4A			
Information Element	Value/remark	Comment	Condition
MBSFNAreaConfiguration-r9 ::= SEQUENCE {			
commonSF-Alloc-r9 SEQUENCE (SIZE			
(1..maxMBSFN-Allocations)) OF SEQUENCE {			
commonSF-AllocPeriod-r9	rf32		
pmch-InfoList-r9 SEQUENCE (SIZE			
(0..maxPMCH-PerMBSFN)) OF SEQUENCE {			
pmch-Config-r9 SEQUENCE {			
sf-AllocEnd-r9	7		
dataMCS-r9	0		
mch-SchedulingPeriod-r9	rf256		
}			
}			
}			

Table 17.1.5.3.3-3: CLOSE UE TEST LOOP (step 3, Table 17.1.5.3.2-2)

Derivation Path: 36.508, Table 4.7A-3, condition UE TEST LOOP MODE C

17.2 MBMS Data Reception

17.2.1 UE Acquire the MBMS data based on the SIB13 and MCCH message /MCCH and MTCH are on the same MCH

17.2.1.1 Test Purpose (TP)

(1)

```
with { UE receiving an MBMS service }
ensure that {
  when { UE receives a MAC PDU on MCH, multiplexing both MCCH and MTCH RLC PDU's }
  then { UE successfully de-multiplexes the MCCH and MTCH data }
}
```

17.2.1.2 Conformance requirements

References:

The conformance requirements covered in the present TC are specified in: TS 36.321, clause 5, 12, 6.1.2, 6.1.3.7 and 6.2.1.

[TS 36.321, clause 5.12]

MCH transmission may occur in subframes configured by upper layer for MCCH or MTCH transmission. For each such subframe, upper layer indicates if *signallingMCS* or *dataMCS* applies. The transmission of an MCH occurs in a set of subframes known as the MCH subframe allocation (MSA), defined by *PMCH-Config*. An MCH Scheduling Information MAC control element is included at the beginning of the MCH scheduling period in the first subframe of each MSA to indicate the position of each MTCH and unused subframes on the MCH. The UE shall assume that the first scheduled MTCH starts immediately after the MCCH or the MCH Scheduling Information MAC control element if the MCCH is not present, and the other scheduled MTCH(s) start at the earliest in the subframe where the previous MTCH stops. When the UE needs to receive MCH, the UE shall:

- attempt to decode the TB on the MCH;
- if a TB on the MCH has been successfully decoded:
 - demultiplex the MAC PDU and deliver the MAC SDU(s) to upper layers.

[TS 36.321, clause 6.1.2]

A MAC PDU consists of a MAC header, zero or more MAC Service Data Units (MAC SDU), zero, or more MAC control elements, and optionally padding; as described in Figure 6.1.2-3.

Both the MAC header and the MAC SDUs are of variable sizes.

A MAC PDU header consists of one or more MAC PDU subheaders; each subheader corresponds to either a MAC SDU, a MAC control element or padding.

A MAC PDU subheader consists of the six header fields R/R/E/LCID/F/L but for the last subheader in the MAC PDU and for fixed sized MAC control elements. The last subheader in the MAC PDU and subheaders for fixed sized MAC control elements consist solely of the four header fields R/R/E/LCID. A MAC PDU subheader corresponding to padding consists of the four header fields R/R/E/LCID.

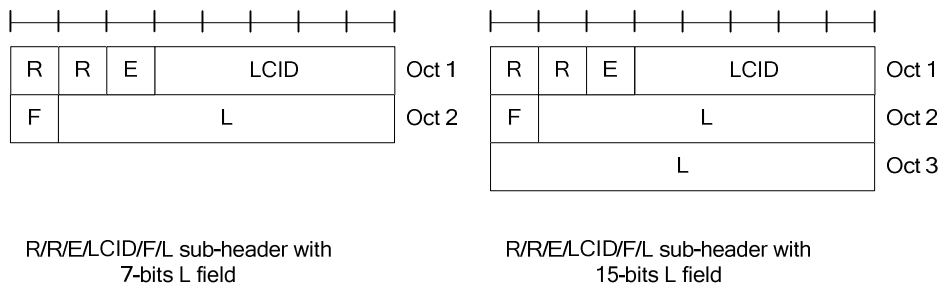

Figure 6.1.2-1: R/R/E/LCID/F/L MAC subheader

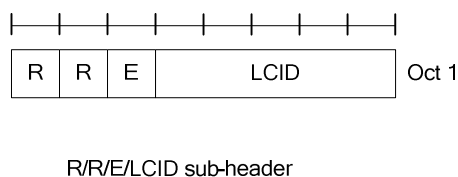

Figure 6.1.2-2: R/R/E/LCID MAC subheader

MAC PDU subheaders have the same order as the corresponding MAC SDUs, MAC control elements and padding.

MAC control elements are always placed before any MAC SDU.

Padding occurs at the end of the MAC PDU, except when single-byte or two-byte padding is required. Padding may have any value and the UE shall ignore it. When padding is performed at the end of the MAC PDU, zero or more padding bytes are allowed.

When single-byte or two-byte padding is required, one or two MAC PDU subheaders corresponding to padding are placed at the beginning of the MAC PDU before any other MAC PDU subheader.

A maximum of one MAC PDU can be transmitted per TB per UE. A maximum of one MCH MAC PDU can be transmitted per TTI.

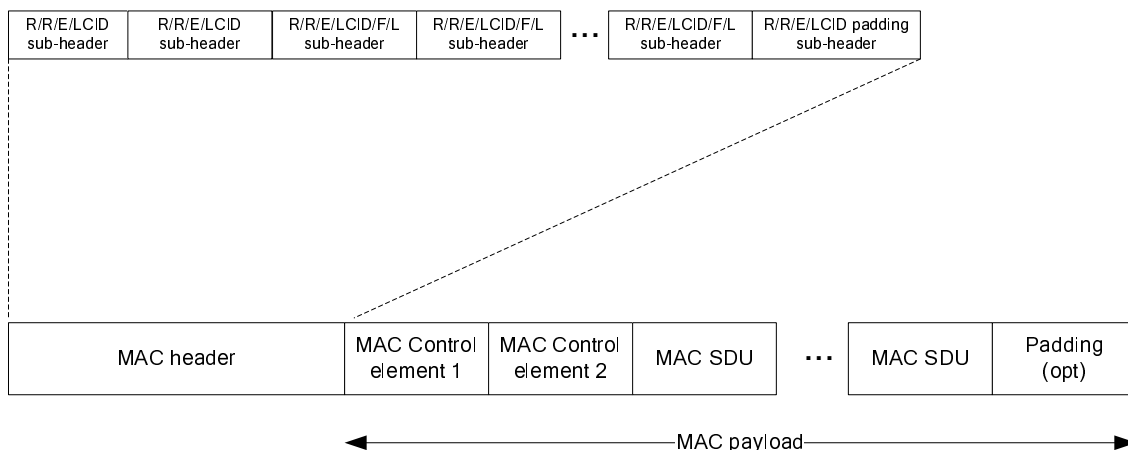

Figure 6.1.2-3: Example of MAC PDU consisting of MAC header, MAC control elements, MAC SDUs and padding

[TS 36.321, clause 6.1.3.7]

The MCH Scheduling Information MAC Control Element illustrated in Figure 6.1.3.7-1 is identified by a MAC PDU subheader with LCID as specified in Table 6.2.1-4. This control element has a variable size. For each MTCH the fields below are included:

- LCID: this field indicates the Logical Channel ID of the MTCH. The length of the field is 5 bits;
- Stop MTCH: this field indicates the ordinal number of the subframe within the MCH scheduling period where the corresponding MTCH stops. The length of the field is 11 bits. The special Stop MTCH value 2047 indicates that the corresponding MTCH is not scheduled. The value range 2043 to 2046 is reserved.

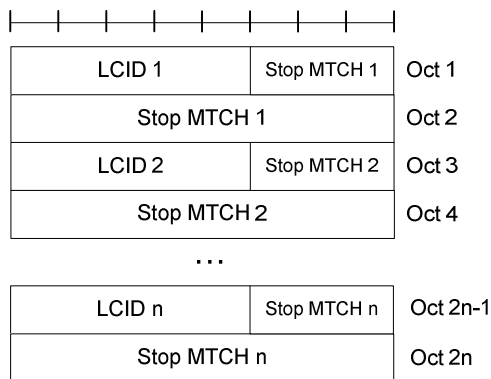

Figure 6.1.3.7-1: MCH Scheduling Information MAC control element

[TS 36.321, clause 6.2.1]

The MAC header is of variable size and consists of the following fields:

- LCID: The Logical Channel ID field identifies the logical channel instance of the corresponding MAC SDU or the type of the corresponding MAC control element or padding as described in tables 6.2.1-1, 6.2.1-2 and 6.2.1-4 for the DL-SCH, UL-SCH and MCH respectively. There is one LCID field for each MAC SDU, MAC control element or padding included in the MAC PDU. In addition to that, one or two additional LCID fields are included in the MAC PDU, when single-byte or two-byte padding is required but cannot be achieved by padding at the end of the MAC PDU. The LCID field size is 5 bits;

- L: The Length field indicates the length of the corresponding MAC SDU or variable-sized MAC control element in bytes. There is one L field per MAC PDU subheader except for the last subheader and subheaders corresponding to fixed-sized MAC control elements. The size of the L field is indicated by the F field;
- F: The Format field indicates the size of the Length field as indicated in table 6.2.1-3. There is one F field per MAC PDU subheader except for the last subheader and subheaders corresponding to fixed-sized MAC control elements. The size of the F field is 1 bit. If the size of the MAC SDU or variable-sized MAC control element is less than 128 bytes, the value of the F field is set to 0, otherwise it is set to 1;
- E: The Extension field is a flag indicating if more fields are present in the MAC header or not. The E field is set to "1" to indicate another set of at least R/R/E/LCID fields. The E field is set to "0" to indicate that either a MAC SDU, a MAC control element or padding starts at the next byte;
- R: Reserved bit, set to "0".

The MAC header and subheaders are octet aligned.

...

Table 6.2.1-4 Values of LCID for MCH

Index	LCID values
00000	MCCH (see note)
00001-11100	MTCH
11101	Reserved
11110	MCH Scheduling Information
11111	Padding
NOTE: If there is no MCCH on MCH, an MTCH could use this value.	

17.2.1.3 Test description

17.2.1.3.1 Pre-test conditions

System Simulator:

- Cell 1
- System information combination 15 as defined in TS 36.508[18] clause 4.4.3.1 is used

UE:

- none

Preamble:

- The UE is in state Loopback Activated (state 4) according to [18], with the UE TEST LOOP MODE C.

17.2.1.3.2 Test procedure sequence

Table 17.2.1.3.2-1: Main behaviour

St	Procedure	Message Sequence		TP	Verdict
		U - S	Message		
1	In the current MCCH modification period SS transmits MCCH Modification notification for notification indicator 0	-	MCCH Modification notification	-	-
2	In frame number SFN Mod 512 =0 ; i.e. start of next MCCH modification period, the SS transmits a valid MAC PDU including 'MCH Scheduling Information MAC Control Element with LCID='00001', Stop MTCH='00000001111' and MCCH RLC PDU(carrying <i>MBSFNAreaConfiguration</i>)	<--	MAC PDU (MCH Scheduling Information MAC Control Element: LCID='00001', Stop MTCH='00000001111', MCCH RLC PDU)	-	-
-	Exception; Step 3 is repeated 15 times	-	-	-	-
3	In frame with SFN Mod 32 =0, the SS transmits MCH MAC PDU containing MCCH RLC PDU (carrying <i>MBSFNAreaConfiguration</i>) and MTCH RLC PDU carrying 1 MBMS packet.	<--	MAC PDU (MCCH RLC PDU and MTCH RLC PDU)	-	-
4	The SS transmits an UE TEST LOOP MODE C MBMS PACKET COUNTER REQUEST message.	<--	UE TEST LOOP MODE C MBMS PACKET COUNTER REQUEST	-	-
5	Check: Does the UE responds with UE TEST LOOP MODE C MBMS PACKET COUNTER RESPONSE with number of reported MBMS Packets received on the MTCH is greater than zero?	-->	UE TEST LOOP MODE C MBMS PACKET COUNTER RESPONSE	1	P

Note 1: The Imcs used in steps 2 and 3 is signallingMCS-r9.

Note 2: The subframe number for steps 2 and 3 is determined by subframeAllocation which is 1 (FDD)/ 3(TDD).

17.2.1.3.3 Specific message contents

Table 17.2.1.3.3-1: SystemInformationBlockType2 for Cell 1 (preamble)

Derivation Path: 36.508 table 4.4.3.3-1, condition MBMS.

Table 17.2.1.3.3-1a: ACTIVATE TEST MODE (preamble)

Derivation Path: 36.508, Table 4.7A-1, condition UE TEST LOOP MODE C

Table 17.2.1.3.3-1b: CLOSE UE TEST LOOP (preamble)

Derivation Path: 36.508, Table 4.7A-3, condition UE TEST LOOP MODE C

Table 17.2.1.3.3-3: *MBSFNAreaConfiguration* (steps 2 and 3, Table 17.2.1.3.2-1)

Derivation Path: 36.508 table 4.6.1-4A			
Information Element	Value/remark	Comment	Condition
MBSFNAreaConfiguration-r9 ::= SEQUENCE {			
commonSF-Alloc-r9 SEQUENCE (SIZE			
(1..maxMBSFN-Allocations)) OF SEQUENCE {			
commonSF-AllocPeriod-r9	rf32		
pmch-InfoList-r9 SEQUENCE (SIZE			
(0..maxPMCH-PerMBSFN)) OF SEQUENCE {			
pmch-Config-r9 SEQUENCE {			
sf-AllocEnd-r9	7		
dataMCS-r9	0		
mch-SchedulingPeriod-r9	rf256		
}			
}			
}			

17.2.2 UE Acquire the MBMS data based on the SIB13 and MCCH message /MCCH and MTCH are on different MCHs

17.2.2.1 Test Purpose (TP)

(1)

```

with { UE receiving an MBMS service }
ensure that {
  when { UE receives a MAC PDU on MCH, containing MCCH PDU's }
  then { UE successfully de-multiplexes the MCCH data}
  when { UE receives a MAC PDU on MCH, containing MTCH PDU's }
  then { UE successfully de-multiplexes the MTCH data}
}

```

17.2.2.2 Conformance requirements

References: The conformance requirements covered in the present TC are specified in: TS 36.321, clause 5.12, 6.1.2, 6.1.3.7 and 6.2.1.

[TS 36.321, clause 5.12]

MCH transmission may occur in subframes configured by upper layer for MCCH or MTCH transmission. For each such subframe, upper layer indicates if *signallingMCS* or *dataMCS* applies. The transmission of an MCH occurs in a set of subframes known as the MCH subframe allocation (MSA), defined by *PMCH-Config*. An MCH Scheduling Information MAC control element is included at the beginning of the MCH scheduling period in the first subframe of each MSA to indicate the position of each MTCH and unused subframes on the MCH. The UE shall assume that the first scheduled MTCH starts immediately after the MCCH or the MCH Scheduling Information MAC control element if the MCCH is not present, and the other scheduled MTCH(s) start at the earliest in the subframe where the previous MTCH stops. When the UE needs to receive MCH, the UE shall:

- attempt to decode the TB on the MCH;
- if a TB on the MCH has been successfully decoded:
 - demultiplex the MAC PDU and deliver the MAC SDU(s) to upper layers.

[TS 36.321, clause 6.1.2]

A MAC PDU consists of a MAC header, zero or more MAC Service Data Units (MAC SDU), zero, or more MAC control elements, and optionally padding; as described in Figure 6.1.2-3.

Both the MAC header and the MAC SDUs are of variable sizes.

A MAC PDU header consists of one or more MAC PDU subheaders; each subheader corresponds to either a MAC SDU, a MAC control element or padding.

A MAC PDU subheader consists of the six header fields R/R/E/LCID/F/L but for the last subheader in the MAC PDU and for fixed sized MAC control elements. The last subheader in the MAC PDU and subheaders for fixed sized MAC control elements consist solely of the four header fields R/R/E/LCID. A MAC PDU subheader corresponding to padding consists of the four header fields R/R/E/LCID.

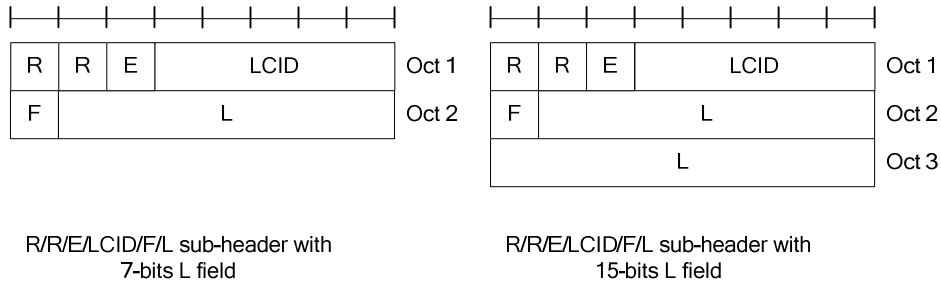

Figure 6.1.2-1: R/R/E/LCID/F/L MAC subheader

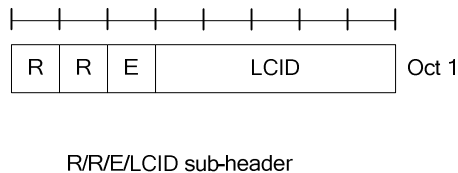

Figure 6.1.2-2: R/R/E/LCID MAC subheader

MAC PDU subheaders have the same order as the corresponding MAC SDUs, MAC control elements and padding.

MAC control elements are always placed before any MAC SDU.

Padding occurs at the end of the MAC PDU, except when single-byte or two-byte padding is required. Padding may have any value and the UE shall ignore it. When padding is performed at the end of the MAC PDU, zero or more padding bytes are allowed.

When single-byte or two-byte padding is required, one or two MAC PDU subheaders corresponding to padding are placed at the beginning of the MAC PDU before any other MAC PDU subheader.

A maximum of one MAC PDU can be transmitted per TB per UE. A maximum of one MCH MAC PDU can be transmitted per TTI.

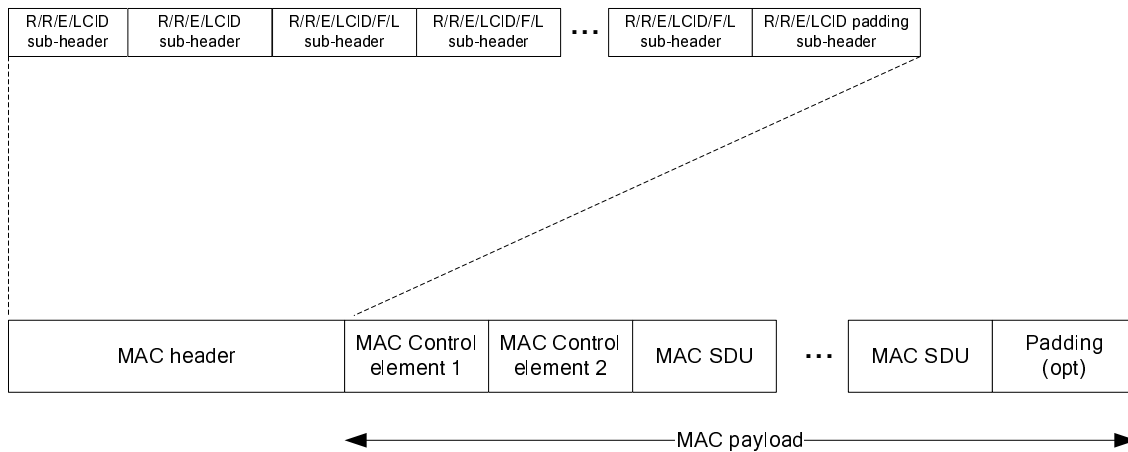

Figure 6.1.2-3: Example of MAC PDU consisting of MAC header, MAC control elements, MAC SDUs and padding

[TS 36.321, clause 6.1.3.7]

The MCH Scheduling Information MAC Control Element illustrated in Figure 6.1.3.7-1 is identified by a MAC PDU subheader with LCID as specified in Table 6.2.1-4. This control element has a variable size. For each MTCH the fields below are included:

- LCID: this field indicates the Logical Channel ID of the MTCH. The length of the field is 5 bits;
- Stop MTCH: this field indicates the ordinal number of the subframe within the MCH scheduling period where the corresponding MTCH stops. The length of the field is 11 bits. The special Stop MTCH value 2047 indicates that the corresponding MTCH is not scheduled. The value range 2043 to 2046 is reserved.

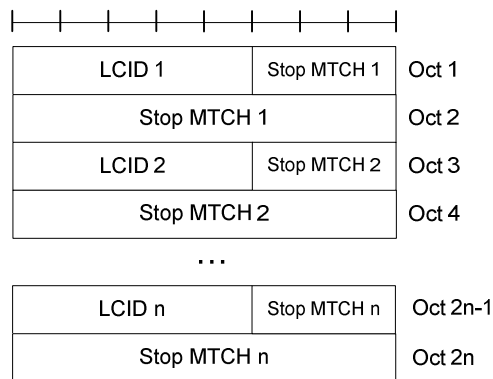

Figure 6.1.3.7-1: MCH Scheduling Information MAC control element

[TS 36.321, clause 6.2.1]

The MAC header is of variable size and consists of the following fields:

- LCID: The Logical Channel ID field identifies the logical channel instance of the corresponding MAC SDU or the type of the corresponding MAC control element or padding as described in tables 6.2.1-1, 6.2.1-2 and 6.2.1-4 for the DL-SCH, UL-SCH and MCH respectively. There is one LCID field for each MAC SDU, MAC control element or padding included in the MAC PDU. In addition to that, one or two additional LCID fields are included in the MAC PDU, when single-byte or two-byte padding is required but cannot be achieved by padding at the end of the MAC PDU. The LCID field size is 5 bits;

- L: The Length field indicates the length of the corresponding MAC SDU or variable-sized MAC control element in bytes. There is one L field per MAC PDU subheader except for the last subheader and subheaders corresponding to fixed-sized MAC control elements. The size of the L field is indicated by the F field;
- F: The Format field indicates the size of the Length field as indicated in table 6.2.1-3. There is one F field per MAC PDU subheader except for the last subheader and subheaders corresponding to fixed-sized MAC control elements. The size of the F field is 1 bit. If the size of the MAC SDU or variable-sized MAC control element is less than 128 bytes, the value of the F field is set to 0, otherwise it is set to 1;
- E: The Extension field is a flag indicating if more fields are present in the MAC header or not. The E field is set to "1" to indicate another set of at least R/R/E/LCID fields. The E field is set to "0" to indicate that either a MAC SDU, a MAC control element or padding starts at the next byte;
- R: Reserved bit, set to "0".

The MAC header and subheaders are octet aligned.

...

Table 6.2.1-4 Values of LCID for MCH

Index	LCID values
00000	MCCH (see note)
00001-11100	MTCH
11101	Reserved
11110	MCH Scheduling Information
11111	Padding
NOTE: If there is no MCCH on MCH, an MTCH could use this value.	

17.2.2.3 Test description

17.2.2.3.1 Pre-test conditions

System Simulator:

- Cell 1
- System information combination 15 as defined in TS 36.508[18] clause 4.4.3.1 is used

UE:

- none

Preamble:

- The UE is in state Loopback Activated (state 4) according to [18], with the UE TEST LOOP MODE C.

17.2.2.3.2 Test procedure sequence

Table 17.2.2.3.2-1: Main behaviour

St	Procedure	Message Sequence		TP	Verdict
		U - S	Message		
1	In the current MCCH modification period SS transmits MCCH Modification notification for notification indicator 0	-	MCCH Modification notification	-	-
2	In frame number SFN Mod 512 =0 ; i.e. start of next MCCH modification period, the SS transmits a valid MAC PDU including 'MCH Scheduling Information MAC Control Element with LCID='00001', Stop MTCH='00000001111' and MCCH RLC PDU(carrying <i>MBSFNAreaConfiguration</i>)	<--	MAC PDU (MCH Scheduling Information MAC Control Element: LCID='00001', Stop MTCH='00000001111', MCCH RLC PDU)	-	-
-	Exception; Steps 3 and 4 are repeated 15 times	-	-	-	-
3	In frame with SFN MOD 32 is not =0 and SFN MOD 16 =0, the SS transmits MCH MAC PDU containing MTCH RLC PDU carrying 1 MBMS packet	<--	MAC PDU (MTCH RLC PDU)	-	-
4	In frame with SFN MOD 32 =0 the SS transmits MCH MCCH PDU containing MCCH RLC PDU(carrying <i>MBSFNAreaConfiguration</i>)	<--	MAC PDU (MCCH RLC PDU)	-	-
5	The SS transmits an UE TEST LOOP MODE C MBMS PACKET COUNTER REQUEST message.	<--	UE TEST LOOP MODE C MBMS PACKET COUNTER REQUEST	-	-
6	Check: Does the UE responds with UE TEST LOOP MODE C MBMS PACKET COUNTER RESPONSE with number of reported MBMS Packets received on the MTCH is greater than zero?	-->	UE TEST LOOP MODE C MBMS PACKET COUNTER RESPONSE	1	P

Note 1: The Imcs used in steps 2 and 4 is signallingMCS-r9 and that in step 3 is dataMCS-r9.
 Note 2: The subframe number for steps 2,3 and 4 is determined by subframeAllocation which is 1 (FDD)/ 3(TDD).

17.2.2.3.3 Specific message contents

Table 17.2.2.3.3-1: SystemInformationBlockType2 for Cell 1 (preamble)

Derivation Path: 36.508 table 4.4.3.3-1, condition MBMS

Table 17.2.2.3.3-1a: ACTIVATE TEST MODE (preamble)

Derivation Path: 36.508, Table 4.7A-1, condition UE TEST LOOP MODE C.

Table 17.2.2.3.3-1b: CLOSE UE TEST LOOP (preamble)

Derivation Path: 36.508, Table 4.7A-3, condition UE TEST LOOP MODE C

Table 17.2.2.3.3-3: MBSFNAreaConfiguration (steps 2 and 4, Table 17.2.2.3.2-1)

Derivation Path: 36.508 table 4.6.1-4A			
Information Element	Value/remark	Comment	Condition
MBSFNAreaConfiguration-r9 ::= SEQUENCE {			
commonSF-Alloc-r9 SEQUENCE (SIZE			
(1..maxMBSFN-Allocations)) OF SEQUENCE {			
commonSF-AllocPeriod-r9	rf16		
pmch-InfoList-r9 SEQUENCE (SIZE			
(0..maxPMCH-PerMBSFN)) OF SEQUENCE {			
pmch-Config-r9 SEQUENCE {			
sf-AllocEnd-r9	3		
dataMCS-r9	0		
mch-SchedulingPeriod-r9	rf256		
}			
}			
}			

17.2.3 UE receives the MBMS data when this data is in the beginning of the MSP

17.2.3.1 Test Purpose (TP)

(1)

```
with { UE receiving an MBMS service }
ensure that {
  when { UE receives a MAC PDU on MCH, containing MTCH PDU's at the start of MCH scheduling period}
  then { UE successfully de-multiplexes the MTCH data}
}
```

17.2.3.2 Conformance requirements

References: The conformance requirements covered in the present TC are specified in: TS 36.321, clause 5.12, 6.1.2, 6.1.3.7 and 6.2.1.

[TS 36.321, clause 5.12]

MCH transmission may occur in subframes configured by upper layer for MCCH or MTCH transmission. For each such subframe, upper layer indicates if *signallingMCS* or *dataMCS* applies. The transmission of an MCH occurs in a set of subframes known as the MCH subframe allocation (MSA), defined by *PMCH-Config*. An MCH Scheduling Information MAC control element is included at the beginning of the MCH scheduling period in the first subframe of each MSA to indicate the position of each MTCH and unused subframes on the MCH. The UE shall assume that the first scheduled MTCH starts immediately after the MCCH or the MCH Scheduling Information MAC control element if the MCCH is not present, and the other scheduled MTCH(s) start at the earliest in the subframe where the previous MTCH stops. When the UE needs to receive MCH, the UE shall:

- attempt to decode the TB on the MCH;
- if a TB on the MCH has been successfully decoded:
 - demultiplex the MAC PDU and deliver the MAC SDU(s) to upper layers.

[TS 36.321, clause 6.1.2]

A MAC PDU consists of a MAC header, zero or more MAC Service Data Units (MAC SDU), zero, or more MAC control elements, and optionally padding; as described in Figure 6.1.2-3.

Both the MAC header and the MAC SDUs are of variable sizes.

A MAC PDU header consists of one or more MAC PDU subheaders; each subheader corresponds to either a MAC SDU, a MAC control element or padding.

A MAC PDU subheader consists of the six header fields R/R/E/LCID/F/L but for the last subheader in the MAC PDU and for fixed sized MAC control elements. The last subheader in the MAC PDU and subheaders for fixed sized MAC control elements consist solely of the four header fields R/R/E/LCID. A MAC PDU subheader corresponding to padding consists of the four header fields R/R/E/LCID.

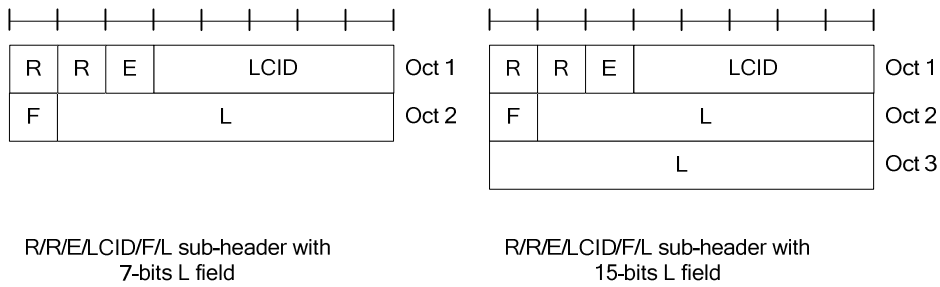

Figure 6.1.2-1: R/R/E/LCID/F/L MAC subheader

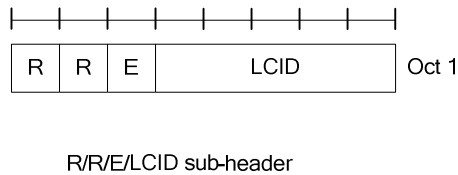

Figure 6.1.2-2: R/R/E/LCID MAC subheader

MAC PDU subheaders have the same order as the corresponding MAC SDUs, MAC control elements and padding.

MAC control elements are always placed before any MAC SDU.

Padding occurs at the end of the MAC PDU, except when single-byte or two-byte padding is required. Padding may have any value and the UE shall ignore it. When padding is performed at the end of the MAC PDU, zero or more padding bytes are allowed.

When single-byte or two-byte padding is required, one or two MAC PDU subheaders corresponding to padding are placed at the beginning of the MAC PDU before any other MAC PDU subheader.

A maximum of one MAC PDU can be transmitted per TB per UE. A maximum of one MCH MAC PDU can be transmitted per TTI.

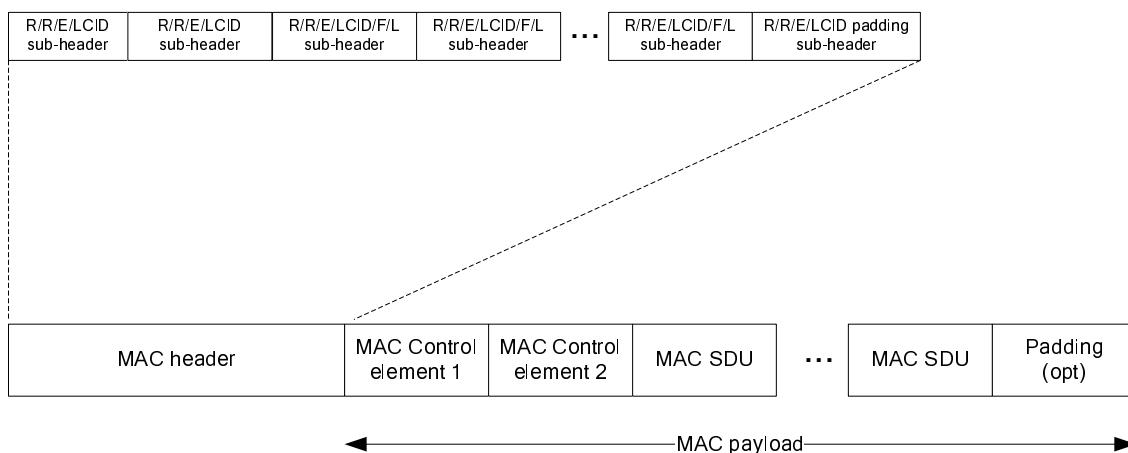

Figure 6.1.2-3: Example of MAC PDU consisting of MAC header, MAC control elements, MAC SDUs and padding

[TS 36.321, clause 6.1.3.7]

The MCH Scheduling Information MAC Control Element illustrated in Figure 6.1.3.7-1 is identified by a MAC PDU subheader with LCID as specified in Table 6.2.1-4. This control element has a variable size. For each MTCH the fields below are included:

- LCID: this field indicates the Logical Channel ID of the MTCH. The length of the field is 5 bits;
- Stop MTCH: this field indicates the ordinal number of the subframe within the MCH scheduling period where the corresponding MTCH stops. The length of the field is 11 bits. The special Stop MTCH value 2047 indicates that the corresponding MTCH is not scheduled. The value range 2043 to 2046 is reserved.



Figure 6.1.3.7-1: MCH Scheduling Information MAC control element

[TS 36.321, clause 6.2.1]

The MAC header is of variable size and consists of the following fields:

- LCID: The Logical Channel ID field identifies the logical channel instance of the corresponding MAC SDU or the type of the corresponding MAC control element or padding as described in tables 6.2.1-1, 6.2.1-2 and 6.2.1-4 for the DL-SCH, UL-SCH and MCH respectively. There is one LCID field for each MAC SDU, MAC control element or padding included in the MAC PDU. In addition to that, one or two additional LCID fields are included in the MAC PDU, when single-byte or two-byte padding is required but cannot be achieved by padding at the end of the MAC PDU. The LCID field size is 5 bits;
- L: The Length field indicates the length of the corresponding MAC SDU or variable-sized MAC control element in bytes. There is one L field per MAC PDU subheader except for the last subheader and subheaders corresponding to fixed-sized MAC control elements. The size of the L field is indicated by the F field;
- F: The Format field indicates the size of the Length field as indicated in table 6.2.1-3. There is one F field per MAC PDU subheader except for the last subheader and subheaders corresponding to fixed-sized MAC control elements. The size of the F field is 1 bit. If the size of the MAC SDU or variable-sized MAC control element is less than 128 bytes, the value of the F field is set to 0, otherwise it is set to 1;
- E: The Extension field is a flag indicating if more fields are present in the MAC header or not. The E field is set to "1" to indicate another set of at least R/R/E/LCID fields. The E field is set to "0" to indicate that either a MAC SDU, a MAC control element or padding starts at the next byte;
- R: Reserved bit, set to "0".

The MAC header and subheaders are octet aligned.

...

Table 6.2.1-4: Values of LCID for MCH

Index	LCID values
00000	MCCH (see note)
00001-11100	MTCH
11101	Reserved
11110	MCH Scheduling Information
11111	Padding
NOTE: If there is no MCCH on MCH, an MTCH could use this value.	

17.2.3.3 Test description

17.2.3.3.1 Pre-test conditions

System Simulator:

- Cell 1
- System information combination 15 as defined in TS 36.508[18] clause 4.4.3.1 is used.

UE:

- none

Preamble:

- The UE is in state Loopback Activated (state 4) according to [18], with the UE TEST LOOP MODE C.

17.2.3.3.2 Test procedure sequence

Table 17.2.3.3.2-1: Main behaviour

St	Procedure	Message Sequence		TP	Verdict
		U - S	Message		
1	In the current MCCH modification period SS transmits MCCH Modification notification for notification indicator 0	-	MCCH Modification notification	-	-
2	In frame number SFN Mod 512 =0 ; i.e. start of next MCCH modification period, the SS transmits a valid MAC PDU including 'MCH Scheduling Information MAC Control Element with LCID='00001', Stop MTCH='00000001111' , MCCH RLC PDU(carrying <i>MBSFNAreaConfiguration</i>) and MTCH RLC PDU carrying 1 MBMS packet	<--	MAC PDU (MCH Scheduling Information MAC Control Element: LCID='00001', Stop MTCH='00000001111', MCCH RLC PDU, MTCH RLC PDU)	-	-
-	Exception; Steps 3 and 4 are repeated 8 times	-	-	-	-
3	In frame with SFN MOD 32 is not =0 and SFN MOD 16 =0, the SS transmits MCH MAC PDU containing 'MCH Scheduling Information MAC Control Element with LCID='00001', Stop MTCH='00000001111' and MTCH RLC PDU carrying 1 MBMS packet	<--	MAC PDU (MCH Scheduling Information MAC Control Element: LCID='00001', Stop MTCH='00000001111', MTCH RLC PDU)	-	-
4	In frame with SFN MOD 32 =0 the SS transmits MCH MCCH PDU containing 'MCH Scheduling Information MAC Control Element with LCID='00001', Stop MTCH='00000001111' , MCCH RLC PDU(carrying <i>MBSFNAreaConfiguration</i>) and MTCH RLC PDU carrying 1 MBMS packet	<--	MAC PDU (MCH Scheduling Information MAC Control Element: LCID='00001', Stop MTCH='00000001111', MCCH RLC PDU, MTCH RLC PDU)	-	-
5	The SS transmits an UE TEST LOOP MODE C MBMS PACKET COUNTER REQUEST message.	<--	UE TEST LOOP MODE C MBMS PACKET COUNTER REQUEST	-	-
6	Check: Does the UE responds with UE TEST LOOP MODE C MBMS PACKET COUNTER RESPONSE with number of reported MBMS Packets received on the MTCH is greater than zero?	-->	UE TEST LOOP MODE C MBMS PACKET COUNTER RESPONSE	1	P

Note 1: The Imcs used in steps 2 ,3 and 4 is signallingMCS-r9.

Note 2: The subframe number for steps 2,3 and 4 is determined by subframeAllocation which is 1 (FDD)/ 3(TDD).

17.2.3.3.3 Specific message contents

Table 17.2.3.3.3-1: SystemInformationBlockType2 for Cell 1 (preamble)

Derivation Path: 36.508 table 4.4.3.3-1, condition MBMS

Table 17.2.3.3.3-1a: ACTIVATE TEST MODE (preamble)

Derivation Path: 36.508, Table 4.7A-1, condition UE TEST LOOP MODE C

Table 17.2.3.3.3-1b: CLOSE UE TEST LOOP (preamble)

Derivation Path: 36.508, Table 4.7A-3, condition UE TEST LOOP MODE C

Table 17.2.3.3.3-3: MBSFNAreaConfiguration (steps 2 and 4, Table 17.2.3.3.2-1)

Derivation Path: 36.508 table 4.6.1-4A			
Information Element	Value/remark	Comment	Condition
MBSFNAreaConfiguration-r9 ::= SEQUENCE {			
commonSF-Alloc-r9 SEQUENCE (SIZE			
(1..maxMBSFN-Allocations)) OF SEQUENCE {			
commonSF-AllocPeriod-r9	rf16		
pmch-InfoList-r9 SEQUENCE (SIZE			
(0..maxPMCH-PerMBSFN)) OF SEQUENCE {			
pmch-Config-r9 SEQUENCE {			
sf-AllocEnd-r9	3		
dataMCS-r9	0		
mch-SchedulingPeriod-r9	rf16		
}			
}			
}			

17.2.4 Reception of PDCCH DCI format 0 and PHICH in MBSFN subframes

17.2.4.1 Test Purpose (TP)

(1)

```
with { UE in E-UTRAN RRC_CONNECTED state and in a subframe configured as MBSFN subframe}
ensure that {
  when { UE receives a PDCCH DCI format 0 }
  then { UE performs uplink data transmission as per DCI format 0 received }
}
```

(2)

```
with { UE in E-UTRAN RRC_CONNECTED state and in a subframe configured as MBSFN subframe}
ensure that {
  when { UE receives a PHICH for an uplink data transmission made}
  then { UE acts upon the PHICH information }
}
```

17.2.4.2 Conformance requirements

References: The conformance requirements covered in the present TC are specified in: TS 36.211 clause 6.1.1, 6.7, TS 36.331 clause 5.2.2.9 and TS 36.213 clause 8.3.

[TS 36.211, clause 6.1.1]

A subset of the downlink subframes in a radio frame on a carrier supporting PDSCH transmission can be configured as MBSFN subframes by higher layers. Each MBSFN subframe is divided into a non-MBSFN region and an MBSFN region.

- The non-MBSFN region spans the first one or two OFDM symbols in an MBSFN subframe where the length of the non-MBSFN region is given by Table 6.7-1. Transmission in the non-MBSFN region shall use the same cyclic prefix length as used for subframe 0.
- The MBSFN region in an MBSFN subframe is defined as the OFDM symbols not used for the non-MBSFN region.

[TS 36.211, clause 6.7]

The physical control format indicator channel carries information about the number of OFDM symbols used for transmission of PDCCHs in a subframe. The set of OFDM symbols possible to use for PDCCH in a subframe is given by Table 6.7-1.

Table 6.7-1: Number of OFDM symbols used for PDCCH

Subframe	Number of OFDM symbols for PDCCH when $N_{RB}^{DL} > 10$	Number of OFDM symbols for PDCCH when $N_{RB}^{DL} \leq 10$
Subframe 1 and 6 for frame structure type 2	1, 2	2
MBSFN subframes on a carrier supporting PDSCH, configured with 1 or 2 cell-specific antenna ports	1, 2	2
MBSFN subframes on a carrier supporting PDSCH, configured with 4 cell-specific antenna ports	2	2
Subframes on a carrier not supporting PDSCH	0	0
Non-MBSFN subframes (except subframe 6 for frame structure type 2) configured with positioning reference signals	1, 2, 3	2, 3
All other cases	1, 2, 3	2, 3, 4

The PCFICH shall be transmitted when the number of OFDM symbols for PDCCH is greater than zero.

[TS 36.331, clause 5.2.2.9]

Upon receiving *SystemInformationBlockType2*, the UE shall:

...

1> if the *mbsfn-SubframeConfigList* is included:

2> consider that no other DL assignments occur in the MBSFN subframes indicated in the *mbsfn-SubframeConfigList*.

[TS 36.213, clause 8.3]

For Frame Structure type 1, an ACK/NACK received on the PHICH assigned to a UE in subframe i is associated with the PUSCH transmission in subframe $i-4$.

For Frame Structure type 2 UL/DL configuration 1-6, an ACK/NACK received on the PHICH assigned to a UE in subframe i is associated with the PUSCH transmission in the subframe $i-k$ as indicated by the following table 8.3-1.

For Frame Structure type 2 UL/DL configuration 0, an ACK/NACK received on the PHICH in the resource corresponding to $I_{PHICH} = 0$, as defined in Section 9.1.2, assigned to a UE in subframe i is associated with the PUSCH transmission in the subframe $i-k$ as indicated by the following table 8.3-1. If, for Frame Structure type 2 UL/DL configuration 0, an ACK/NACK received on the PHICH in the resource corresponding to $I_{PHICH} = 1$, as defined in Section 9.1.2, assigned to a UE in subframe i is associated with the PUSCH transmission in the subframe $i-6$.

Table 8.3-1: k for TDD configurations 0-6

TDD UL/DL Configuration	DL subframe number i									
	0	1	2	3	4	5	6	7	8	9
0	7	4				7	4			
1		4			6		4			6
2				6						6
3	6								6	6
4									6	6
5									6	
6	6	4				7	4			6

The physical layer in the UE shall deliver indications to the higher layers as follows:

For downlink subframe i , if a transport block was transmitted in the associated PUSCH subframe then:

- if ACK is decoded on the PHICH in subframe i , ACK shall be delivered to the higher layers;
- else NACK shall be delivered to the higher layers.

17.2.4.3 Test description

17.2.4.3.1 Pre-test conditions

System Simulator:

- Cell 1
- System information combination 15 as defined in TS 36.508[18] clause 4.4.3.1 is used.

UE:

None.

Preamble:

- The UE is in state Loopback Activated (state 4) according to [18].
- The loop back size is set in such a way that one RLC SDU in DL shall result in 1 RLC SDU's in UL.
- No UL Grant is allocated; PUCCH is in synchronised state for sending Scheduling Requests.

17.2.4.3.2 Test procedure sequence

Table 17.2.4.3.2-1: Main behaviour

St	Procedure	Message Sequence		TP	Verdict
		U - S	Message		
1	The SS transmits a Paging message in a paging occasion including a <i>systemInfoModification</i> .	<--	Paging	-	-
2	From the beginning of the next modification period the SS transmits a modified <i>SystemInformationBlockType2</i> as specified.	-	-	-	-
3	The SS Transmits a valid MAC PDU containing RLC PDU	<--	MAC PDU	-	-
4	The SS is configured for Uplink Grant Allocation Type 3. The SS allocates an UL Grant (DCI format 0) in SFN x, sub frame 3(FDD)/4(TDD).	<--	Uplink Grant	-	-
5	Check: Does the UE transmit a MAC PDU including one RLC SDU, as per grant in step 2 ?	-->	MAC PDU	1	P
6	The SS transmits a NACK corresponding to MAC PDU in step 5 in SFN x+1, sub frame 1(FDD)/4(TDD).	<--	HARQ NACK	-	-
7	Check: Does the UE retransmit the MAC PDU?	-->	MAC PDU	2	P
8	The SS transmits a NACK corresponding to MAC PDU in step 7 in SFN x+1, sub frame 9(FDD)/ SFN x+2, sub frame 4(TDD).	<--	HARQ NACK	-	-
9	The UE retransmit the MAC PDU.	-->	MAC PDU	-	-
10	The SS transmits an ACK corresponding to MAC PDU in step 9 in SFN x+2, sub frame 7(FDD)/ SFN x+3, sub frame 4(TDD).	<--	HARQ ACK	-	-
11	Check: Does the UE retransmit the MAC PDU ?	-->	MAC PDU	2	F
12	The SS transmits a Paging message in a paging occasion including a <i>systemInfoModification</i> .	<--	Paging	-	-
13	From the beginning of the next modification period the SS transmits a default <i>SystemInformationBlockType2</i> as in TS 36.508, table 4.4.3.3-1.	-	-	-	-

17.2.4.3.3 Specific message contents

Table 17.2.4.3.3-1: SystemInformationBlockType2 for Cell 1 (preamble)

Derivation Path: 36.508 table 4.4.3.3-1, condition MBMS

Table 17.2.4.3.3-2: ACTIVATE TEST MODE (preamble)

Derivation Path: 36.508, Table 4.7A-1, condition UE TEST LOOP MODE C.

Table 17.2.4.3.3-3: CLOSE UE TEST LOOP (preamble)

Derivation Path: 36.508, Table 4.7A-3, condition UE TEST LOOP MODE C

Table 17.2.4.3.3-4: SystemInformationBlockType2 for Cell 1 (step 2, Table 17.2.4.3.2-3)

Derivation Path: 36.508 table 4.4.3.3-1			
Information Element	Value/remark	Comment	Condition
SystemInformationBlockType2 ::= SEQUENCE {			
mbsfn-SubframeConfiguration SEQUENCE {			
radioframeAllocationPeriod	n1		
radioframeAllocationOffset	0		
subframeAllocation CHOICE{			
oneFrame	'101010'	corresponds to subframes 1, 3 and 7	FDD
oneFrame	'010000'	corresponds to subframe 4	TDD
}			
}			
}			

17.3 MBMS Counting Procedure

17.3.1 MBMS Counting / UE not receiving MBMS service

17.3.1.1 Test Purpose (TP)

(1)

```

with { UE in E-UTRA RRC_Connected state }
ensure that {
  when { UE is not in MBSFN area, enters another cell in MBSFN area, SS sends MBMSCountingRequest
message and UE is interested to receive at least one of the services received in
MBMSCountingResponse message }
  then { UE shall start acquiring the MBMSCountingRequest message from the beginning of the
repetition period and send MBMSCountingResponse message }
}

```

(2)

```

with { UE in E-UTRA RRC_Connected state }
ensure that {
  when { UE is not receiving an MBMS service, receives MCCH information change notification, SS sends
MBMSCountingRequest message and UE is interested to receive at least one of the services received in
the MBMSCountingRequest message }
  then { UE shall start acquiring the MBMSCountingRequest message from the beginning of the
modification period following the one in which the change notification was received and send
MBMSCountingResponse message }
}

```

17.3.1.2 Conformance requirements

References: The conformance requirements covered in the present TC are specified in: TS 36.331 clause 5.8.2.3, 5.8.4.1, 5.8.4.2 and 5.8.4.3.

[TS 36.331 clause 5.8.2.3]

An MBMS capable UE shall:

- 1> if the procedure is triggered by an MCCH information change notification:
 - 2> start acquiring the *MBSFNAreaConfiguration* message and the *MBMSCountingRequest* message if present, from the beginning of the modification period following the one in which the change notification was received;

NOTE 1: The UE continues using the previously received MCCH information until the new MCCH information has been acquired.

- 1> if the UE enters an MBSFN area:

- 2> acquire the *MBSFNAreaConfiguration* message and the *MBMSCountingRequest* message if present, at the next repetition period;

- 1> if the UE is receiving an MBMS service:

- 2> start acquiring the *MBSFNAreaConfiguration* message and the *MBMSCountingRequest* message if present, that both concern the MBSFN area of the service that is being received, from the beginning of each modification period;

[TS 36.331 clause 5.8.4.1]

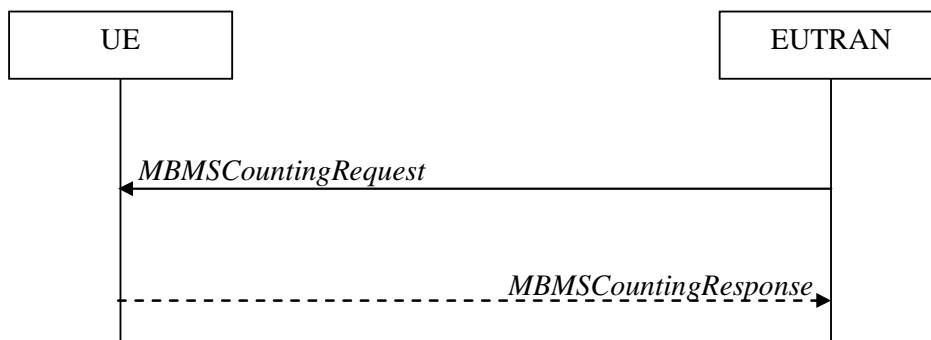

Figure 5.8.4.1-1: MBMS Counting procedure

The MBMS Counting procedure is used by the E-UTRAN to count the number of RRC_CONNECTED mode UEs which are receiving via an MRB or interested to receive via an MRB the specified MBMS services.

The UE determines interest in an MBMS service, that is identified by the TMGI, by interaction with upper layers.

[TS 36.331 clause 5.8.4.2]

E-UTRAN initiates the procedure by sending an *MBMSCountingRequest* message.

[TS 36.331 clause 5.8.4.3]

Upon receiving the *MBMSCountingRequest* message, the UE in RRC_CONNECTED mode shall:

- 1> if the UE is receiving via an MRB or interested to receive via an MRB at least one of the services in the received *countingRequestList*:
- 2> if more than one entry is included in the *mbsfn-AreaInfoList* received in *SystemInformationBlockType13*:

- 3> include the *mbsfn-AreaIndex* in the *MBMScountingResponse* message and set it to the index of the entry in the *mbsfn-AreaInfoList* within the received *SystemInformationBlockType13* that corresponds with the MBSFN area used to transfer the received *MBMScountingRequest* message;
- 2> for each MBMS service included in the received *countingRequestList*:
- 3> if the UE is receiving via an MRB or interested to receive via an MRB this MBMS service:
- 4> include an entry in the *countingResponseList* within the *MBMScountingResponse* message with *countingResponseService* set it to the index of the entry in the *countingRequestList* within the received *MBMScountingRequest* that corresponds with the MBMS service the UE is receiving or interested to receive;
- 2> submit the *MBMScountingResponse* message to lower layers for transmission upon which the procedure ends;

NOTE 1: UEs that are receiving an MBMS User Service [56] by means of a Unicast Bearer Service [57] (i.e. via a DRB), but are interested to receive the concerned MBMS User Service [56] via an MBMS Bearer Service (i.e. via an MRB), respond to the counting request.

NOTE 2: The UE treats the *MBMScountingRequest* messages received in each modification period independently. In the unlikely case E-UTRAN would repeat an *MBMScountingRequest* (i.e. including the same services) in a subsequent modification period, the UE responds again.

17.3.1.3 Test description

17.3.1.3.1 Pre-test conditions

System Simulator:

- Cell 1 does not belong to any MBSFN areas
- Cell 2 belongs to an MBSFN area
- System information combination 1 as defined in TS 36.508[18] clause 4.4.3.1 is used in E-UTRA Cell 1
- System information combination 16 as defined in TS 36.508[18] clause 4.4.3.1 is used in E-UTRA Cell 2

UE:

- None.

Preamble:

- The UE is in state Generic RB Established (state 3) according to [18] on Cell 1.
- The UE is made interested in receiving MBMS service in the PLMN of Cell 2 with MBMS Service ID '000'H.

NOTE: This test case use the default message for *MBMScountingRequest* in [18] which includes MBMS service with MBMS Service ID '000'H in the *CountingRequestList*.

17.3.1.3.2 Test procedure sequence

Table 17.3.1.3.2-1 illustrates the downlink power levels and other changing parameters to be applied for the cells at various time instants of the test execution. Row marked "T0" denotes the initial conditions after preamble, while column marked "T1" is to be applied subsequently. The exact instants on which these values shall be applied are described in the texts in this clause.

Table 17.3.1.3.2-1: Time instances of cell power level and parameter changes

	Parameter	Unit	Cell 1	Cell 2	Remark
T0	Cell-specific RS EPRE	dBm/15k Hz	-85	-91	
T1	Cell-specific RS EPRE	dBm/15k Hz	-91	-85	The power level values are assigned to satisfy $R_{Cell\ 1} < R_{Cell\ 2}$.

Table 17.3.1.3.2-2: Main behaviour

St	Procedure	Message Sequence		TP	Verdict
		U - S	Message		
1	The SS changes Cell 1 and Cell 2 level according to the row "T1" in table 17.3.1.3.2-1.	-	-	-	-
2	The SS transmits an <i>RRCCONNECTIONRECONFIGURATION</i> message on Cell 1 to order the UE to perform handover to Cell 2.	<--	<i>RRCCONNECTIONRECONFIGURATION</i>	-	-
3	The UE transmits an <i>RRCCONNECTIONRECONFIGURATIONCOMPLETE</i> message on Cell 2	-->	<i>RRCCONNECTIONRECONFIGURATIONCOMPLETE</i>	-	-
4	The SS sends <i>MBSFNAREACONFIGURATION</i> message and <i>MBMSCOUNTINGREQUEST</i> message	<--	<i>MBSFNAREACONFIGURATION</i> <i>MBMSCOUNTINGREQUEST</i>	-	-
5	Wait for a period equal to the MCCH repetition period for the UE to receive <i>MBSFNAREACONFIGURATION</i> message and <i>MBMSCOUNTINGREQUEST</i> message	-	-	-	-
6	The UE is interested to receive at least one of the services received in <i>MBMSCOUNTINGRESPONSE</i> message.	-	-	-	-
7	Check: Does the UE send <i>MBMSCOUNTINGRESPONSE</i> message?	-->	<i>MBMSCOUNTINGRESPONSE</i>	1	P
8	The SS transmits MCCH information change notification	-	-	-	-
9	The SS transmits <i>MBSFNAREACONFIGURATION</i> message and <i>MBMSCOUNTINGREQUEST</i> message	<--	<i>MBSFNAREACONFIGURATION</i> <i>MBMSCOUNTINGREQUEST</i>	-	-
10	Wait for a period equal to the MCCH modification period for the UE to receive <i>MBSFNAREACONFIGURATION</i> message and <i>MBMSCOUNTINGREQUEST</i> message from the beginning of the modification period following the one in which the change notification was received	-	-	-	-
11	The UE is interested to receive at least one of the services received in <i>MBMSCOUNTINGRESPONSE</i> message.	-	-	-	-
12	Check: Does the UE send <i>MBMSCOUNTINGRESPONSE</i> message?	-->	<i>MBMSCOUNTINGRESPONSE</i>	2	P

17.3.1.3.3 Specific message contents

Table 17.3.1.3.3-1: *SystemInformationBlockType2* for Cell 1 (preamble and all steps, Table 17.3.1.3.2-2)

Derivation Path: 36.508 table 4.4.3.3-1, condition MBMS.
--

Table 17.3.1.3.3-2: *RRCCONNECTIONRECONFIGURATION* (step 2, Table 17.3.1.3.2-2)

Derivation Path: 36.508, Table 4.6.1-8, condition HO
--

Table 17.3.1.3.3-3: *MobilityControlInfo* (Table 17.3.1.3.3-2)

Derivation Path: 36.508, Table 4.6.5-1			
Information Element	Value/remark	Comment	Condition
MobilityControlInfo ::= SEQUENCE {			
targetPhysCellId	PhysicalCellIdentity of Cell 2		
carrierFreq SEQUENCE {			
dl-CarrierFreq	Same downlink EARFCN as used for Cell 2		
ul-CarrierFreq	Not present		
}			
}			

Table 17.3.1.3.3-4: *MBSFNAreaConfiguration* (steps 4 and 9, Table 17.3.1.3.2-2)

Derivation Path: 36.508 table 4.6.1-4A			
Information Element	Value/remark	Comment	Condition
MBSFNAreaConfiguration-r9 ::= SEQUENCE {			
commonSF-Alloc-r9 SEQUENCE (SIZE (1..maxMBSFN-Allocations)) OF SEQUENCE {			
commonSF-AllocPeriod-r9	rf32		
pmch-InfoList-r9 SEQUENCE (SIZE (0..maxPMCH-PerMBSFN)) OF SEQUENCE {			
pmch-Config-r9 SEQUENCE {			
sf-AllocEnd-r9	7		
dataMCS-r9	0		
mch-SchedulingPeriod-r9	rf256		
}			
}			
}			
}			

17.3.2 MBMS Counting / UE receiving MBMS service

17.3.2.1 Test Purpose (TP)

(1)

```
with { UE in E-UTRA RRC_Connected state }
ensure that {
  when { UE is in MBSFN area, enters another cell in MBSFN area, SS sends MBMSCountingRequest
message and UE is interested to receive at least one of the services received in
MBMSCountingResponse message }
  then { UE shall start acquiring the MBMSCountingRequest message from the beginning of the
repetition period and send MBMSCountingResponse message }
}
```

(2)

```
with { UE in E-UTRA RRC_Connected state }
ensure that {
  when { UE is receiving an MBMS service, receives MCCH information change notification, SS sends
MBMSCountingRequest message and UE is interested to receive at least one of the services received in
the MBMSCountingRequest message }
  then { UE shall start acquiring the MBMSCountingRequest message from the beginning of the
modification period following the one in which the change notification was received and send
MBMSCountingResponse message }
}
```

17.3.2.2 Conformance requirements

References: The conformance requirements covered in the present TC are specified in: TS 36.331 clause 5.8.2.3, 5.8.4.1, 5.8.4.2 and 5.8.4.3.

[TS 36.331 clause 5.8.2.3]

An MBMS capable UE shall:

- 1> if the procedure is triggered by an MCCH information change notification:
 - 2> start acquiring the *MBSFNAreaConfiguration* message and the *MBMSCountingRequest* message if present, from the beginning of the modification period following the one in which the change notification was received;

NOTE 1: The UE continues using the previously received MCCH information until the new MCCH information has been acquired.

- 1> if the UE enters an MBSFN area:
 - 2> acquire the *MBSFNAreaConfiguration* message and the *MBMSCountingRequest* message if present, at the next repetition period;
- 1> if the UE is receiving an MBMS service:
 - 2> start acquiring the *MBSFNAreaConfiguration* message and the *MBMSCountingRequest* message if present, that both concern the MBSFN area of the service that is being received, from the beginning of each modification period;

[TS 36.331 clause 5.8.4.1]

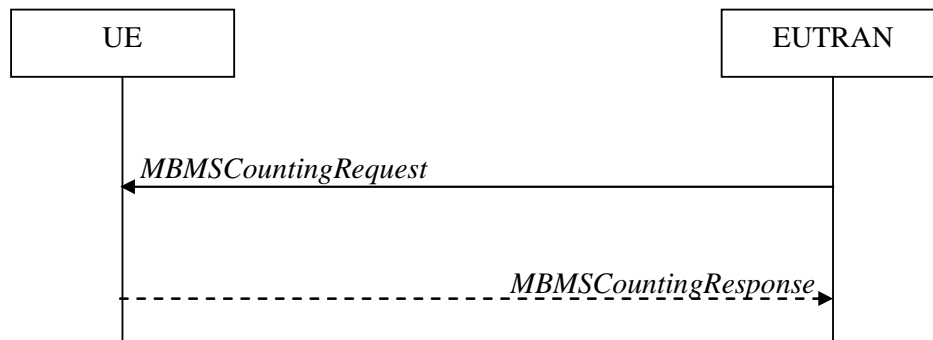

Figure 5.8.4.1-1: MBMS Counting procedure

The MBMS Counting procedure is used by the E-UTRAN to count the number of RRC_CONNECTED mode UEs which are receiving via an MRB or interested to receive via an MRB the specified MBMS services.

The UE determines interest in an MBMS service, that is identified by the TMGI, by interaction with upper layers.

[TS 36.331 clause 5.8.4.2]

E-UTRAN initiates the procedure by sending an *MBMSCountingRequest* message.

[TS 36.331 clause 5.8.4.3]

Upon receiving the *MBMSCountingRequest* message, the UE in RRC_CONNECTED mode shall:

- 1> if the UE is receiving via an MRB or interested to receive via an MRB at least one of the services in the received *countingRequestList*:
 - 2> if more than one entry is included in the *mbsfn-AreaInfoList* received in *SystemInformationBlockType13*:
 - 3> include the *mbsfn-AreaIndex* in the *MBMSCountingResponse* message and set it to the index of the entry in the *mbsfn-AreaInfoList* within the received *SystemInformationBlockType13* that corresponds with the MBSFN area used to transfer the received *MBMSCountingRequest* message;
 - 2> for each MBMS service included in the received *countingRequestList*:
 - 3> if the UE is receiving via an MRB or interested to receive via an MRB this MBMS service:

4> include an entry in the *countingResponseList* within the *MBMSCountingResponse* message with *countingResponseService* set it to the index of the entry in the *countingRequestList* within the received *MBMSCountingRequest* that corresponds with the MBMS service the UE is receiving or interested to receive;

2> submit the *MBMSCountingResponse* message to lower layers for transmission upon which the procedure ends;

NOTE 1: UEs that are receiving an MBMS User Service [56] by means of a Unicast Bearer Service [57] (i.e. via a DRB), but are interested to receive the concerned MBMS User Service [56] via an MBMS Bearer Service (i.e. via an MRB), respond to the counting request.

NOTE 2: The UE treats the *MBMSCountingRequest* messages received in each modification period independently. In the unlikely case E-UTRAN would repeat an *MBMSCountingRequest* (i.e. including the same services) in a subsequent modification period, the UE responds again.

17.3.2.3 Test description

17.3.2.3.1 Pre-test conditions

System Simulator:

- Cell 1 belongs to an MBSFN area
- Cell 2 belongs to another MBSFN area
- System information combination 1 as defined in TS 36.508[18] clause 4.4.3.1 is used in E-UTRA Cell 1
- System information combination 16 as defined in TS 36.508[18] clause 4.4.3.1 is used in E-UTRA Cell 2

UE:

- None.

Preamble:

- The UE is in state Generic RB Established (state 3) on Cell 1 according to [18].
- The UE is made interested in receiving MBMS service in the PLMN of Cell 2 with MBMS Service ID '000'H.

NOTE: This test case use the default message for *MBMSCountingRequest* in [18] which includes MBMS service with MBMS Service ID '000'H in the *CountingRequestList*. 17.3.2.3.2 Test procedure sequence

Table 17.3.2.3.2-1 illustrates the downlink power levels and other changing parameters to be applied for the cells at various time instants of the test execution. Row marked "T0" denotes the initial conditions after preamble, while columns marked "T1", and "T2" are to be applied subsequently. The exact instants on which these values shall be applied are described in the texts in this clause.

Table 17.3.2.3.2-1: Time instances of cell power level and parameter changes

	Parameter	Unit	Cell 1	Cell 2	Remark
T0	Cell-specific RS EPRE	dBm/15k Hz	-85	-91	
T1	Cell-specific RS EPRE	dBm/15k Hz	-91	-85	The power level values are assigned to satisfy $R_{Cell\ 1} < R_{Cell\ 2}$.

Table 17.3.2.3.2-2: Main behaviour

St	Procedure	Message Sequence		TP	Verdict
		U - S	Message		
1	The SS changes Cell 1 and Cell 2 level according to the row "T1" in table 17.3.1.3.2-1.	-	-	-	-
2	The SS transmits an <i>RRCCONNECTIONRECONFIGURATION</i> message on Cell 1 to order the UE to perform handover to Cell 2.	<--	<i>RRCCONNECTIONRECONFIGURATION</i>	-	-
3	The UE transmit an <i>RRCCONNECTIONRECONFIGURATIONCOMPLETE</i> message on Cell 2?	-->	<i>RRCCONNECTIONRECONFIGURATIONCOMPLETE</i>	-	-
4	SS sends <i>MBSFNAREACONFIGURATION</i> message and <i>MBMSCOUNTINGREQUEST</i> message	<--	<i>MBSFNAREACONFIGURATION</i> <i>MBMSCOUNTINGREQUEST</i>	-	-
5	Wait for a period equal to the MCCH repetition period for the UE to receive <i>MBSFNAREACONFIGURATION</i> message and <i>MBMSCOUNTINGREQUEST</i> message	-	-	-	-
6	UE is interested to receive at least one of the services received in <i>MBMSCOUNTINGRESPONSE</i> message.	-	-	-	-
7	Check: Does UE send <i>MBMSCOUNTINGRESPONSE</i> message?	-->	<i>MBMSCOUNTINGRESPONSE</i>	1	P
7a	The generic procedures described in TS 36.508 subclause 4.5.3A.3 and 4.5.4.3 are performed on Cell 1 activating UE test loop Mode C	-	-	-	-
7b	The SS transmits a valid MAC PDU including 'MCH Scheduling Information MAC Control Element with LCID='00001', Stop MTCH='10000000000'	<--	MAC PDU (MCH Scheduling Information MAC Control Element: LCID='00001', Stop MTCH='10000000000')	-	-
7c	The SS transmits 10 MBMS Packets on the MTCH.	<--	MBMS Packets.	-	-
7d	The SS transmits an UE TEST LOOP MODE C MBMS PACKET COUNTER REQUEST message.	<--	UE TEST LOOP MODE C MBMS PACKET COUNTER REQUEST	-	-
7e	UE responds with UE TEST LOOP MODE C MBMS PACKET COUNTER RESPONSE.	-->	UE TEST LOOP MODE C MBMS PACKET COUNTER RESPONSE	-	-
7f	Check: Is the number of reported MBMS Packets received on the MTCH greater than zero? Note: This verifies that UE is receiving the MBMS data	-	-	2	P
8	SS transmits MCCH information change notification	-	-	-	-
9	SS transmits <i>MBSFNAREACONFIGURATION</i> message and <i>MBMSCOUNTINGREQUEST</i> message	<--	<i>MBSFNAREACONFIGURATION</i> <i>MBMSCOUNTINGREQUEST</i>	-	-
10	Wait for a period equal to the MCCH modification period for the UE to receive <i>MBSFNAREACONFIGURATION</i> message and <i>MBMSCOUNTINGREQUEST</i> message from the beginning of the modification period following the one in which the change notification was received	-	-	-	-
11	UE is interested to receive at least one of the services received in <i>MBMSCOUNTINGRESPONSE</i> message.	-	-	-	-
12	Check: Does UE send <i>MBMSCOUNTINGRESPONSE</i> message?	-->	<i>MBMSCOUNTINGRESPONSE</i>	2	P

17.3.2.3.3 Specific message contents

Table 17.3.2.3.3-1: SystemInformationBlockType2 for Cell 1 (preamble and all steps, Table 17.3.2.3.2-2)

Derivation Path: 36.508 table 4.4.3.3-1, condition MBMS.
--

Table 17.3.2.3.3-2: MBSFNAreaConfiguration (steps 4 and 9, Table 17.3.2.3.2-2)

Derivation Path: 36.508 table 4.6.1-4A			
Information Element	Value/remark	Comment	Condition
MBSFNAreaConfiguration-r9 ::= SEQUENCE {			
commonSF-Alloc-r9 SEQUENCE (SIZE			
(1..maxMBSFN-Allocations)) OF SEQUENCE {			
commonSF-AllocPeriod-r9	rf32		
pmch-InfoList-r9 SEQUENCE (SIZE			
(0..maxPMCH-PerMBSFN)) OF SEQUENCE {			
pmch-Config-r9 SEQUENCE {			
sf-AllocEnd-r9	7		
dataMCS-r9	0		
mch-SchedulingPeriod-r9	rf256		
}			
}			
}			

17.4 MBMS Service Continuity

17.4.1 Cell reselection to intra-frequency cell to continue MBMS service reception

17.4.1.1 Test Purpose (TP)

(1)

```

with { UE in E-UTRAN RRC IDLE state with ongoing MBMS reception on a cell broadcasting SIB15
indicating the MBMS SAI associated with the ongoing MBMS service for the frequency of the cell}
ensure that {
  when { an intra-frequency neighbour cell providing the MBMS service and an inter-frequency
neighbour cell not providing the MBMS service becomes better than the serving cell }
  then { UE performs cell reselection to the intra-frequency cell even if the inter-frequency cell
is better and continues MBMS reception }
}

```

17.4.1.2 Conformance requirements

References: The conformance requirements covered in the present TC are specified in: TS 36.304, clause 5.2.4.1 and TS 36.331, clause 5.2.2.4. Unless otherwise stated these are Rel-11 requirements.

[TS 36.304 clause 5.2.4.1]

Absolute priorities of different E-UTRAN frequencies or inter-RAT frequencies may be provided to the UE in the system information, in the *RRCCONNECTIONRELEASE* message, or by inheriting from another RAT at inter-RAT cell (re)selection. In the case of system information, an E-UTRAN frequency or inter-RAT frequency may be listed without providing a priority (i.e. the field *cellReselectionPriority* is absent for that frequency). If priorities are provided in dedicated signalling, the UE shall ignore all the priorities provided in system information. If UE is in *camped on any cell* state, UE shall only apply the priorities provided by system information from current cell, and the UE preserves priorities provided by dedicated signalling and *deprioritisationReq* received in *RRCCONNECTIONREJECT* unless specified otherwise. When the UE in *camped normally* state, has only dedicated priorities other than for the current frequency, the UE shall consider the current frequency to be the lowest priority frequency (i.e. lower than the eight network configured values). While the UE is camped on a suitable CSG cell, the UE shall always consider the current frequency to be the highest priority frequency (i.e. higher than the eight network configured values), irrespective of any other priority value allocated to this frequency. If the UE is capable of MBMS Service Continuity and receiving or interested to receive an

MBMS service and can only receive this MBMS service while camping on a frequency on which it is provided, the UE may consider that frequency to be the highest priority during the MBMS session [2] as long as the reselected cell is broadcasting SIB13 and as long as:

- SIB15 of the serving cell indicates for that frequency one or more MBMS SAIs included in the MBMS User Service Description (USD) [22] of this service; or
- SIB15 is not broadcast in the serving cell and that frequency is included in the USD of this service.

If the UE is not capable of MBMS Service Continuity but has knowledge on which frequency an MBMS service of interest is provided, it may consider that frequency to be the highest priority during the MBMS session [2] as long as the reselected cell is broadcasting SIB13.

NOTE: The UE considers that the MBMS session is ongoing using the session start and end times as provided by upper layers in the USD i.e. the UE does not verify if the session is indicated on MCCH.

....

[TS 36.331 clause 5.2.2.4]

The UE shall:

....

1> if the UE is interested to receive MBMS services:

2> if *schedulingInfoList* indicates that *SystemInformationBlockType13* is present and the UE does not have stored a valid version of this system information block:

3> acquire *SystemInformationBlockType13*;

2> if the UE is capable of MBMS Service Continuity:

3> if *schedulingInfoList* indicates that *SystemInformationBlockType15* is present and the UE does not have stored a valid version of this system information block:

4> acquire *SystemInformationBlockType15*;

....

17.4.1.3 Test description

17.4.1.3.1 Pre-test conditions

System Simulator:

- 3 E-UTRA cells with the same PLMN. Cell 1 and Cell 2 are intra-frequency cells. Cell 3 is inter-frequency cell to Cell 1 and Cell 2. Cell 1 "Serving cell", Cell 2 and Cell 3 are "Non-suitable cell" as defined in TS36.508 Table 6.2.2.1-1.
- Cell 1 and Cell 2 are part of the same MBSFN area
- *MBSFNAreaConfiguration* message as defined in TS 36.508 [18] Table 4.6.1-4A is transmitted on Cell 1 and Cell 2.
- System information combination 19 as defined in TS 36.508[18] clause 4.4.3.1 is used in Cell 1 and Cell 2 with addition to transmitting SIB5 with Cell 3 as inter-frequency cell.
- System information combination 3 as defined in TS 36.508[18] clause 4.4.3.1 is used in Cell 3.

UE:

- The UE is configured to receive MBMS services.

Preamble:

- The UE is in state Loopback Activated (state 4) according to [18] in Cell 1(serving cell), with the UE TEST LOOP MODE C.

- The UE is made interested in receiving a MBMS service associated with the MBMS SAI broadcasted in SIB15 mbms-SAI-IntraFreq list on Cell 1 and Cell 2.

17.4.1.3.2 Test procedure sequence

Table 17.4.1.3.2-1 illustrates the downlink power levels and other changing parameters to be applied for the cells at various time instants of the test execution. Row marked "T0" denotes the initial conditions after preamble, while row marked "T1" is to be applied subsequently. The exact instants on which these values shall be applied are described in the texts in this clause.

Table 17.4.1.3.2-1: Time instances of cell power level and parameter changes

	Parameter	Unit	Cell 1	Cell 2	Cell 3	Remark
T0	Cell-specific RS EPRE	dBm/15k Hz	-85	-91	-91	
T1	Cell-specific RS EPRE	dBm/15k Hz	-91	-85	-79	The power level values are assigned to satisfy $R_{\text{Cell 1}} < R_{\text{Cell 2}} < R_{\text{Cell 3}}$.

Table 17.4.1.3.2-2: Main behaviour

St	Procedure	Message Sequence		TP	Verdict
		U - S	Message		
1	The SS transmits an <i>RRCConnectionRelease</i> message to release RRC connection and move to RRC_IDLE.	<--	RRC: <i>RRCConnectionRelease</i>		
2	The SS transmits a valid MAC PDU including 'MCH Scheduling Information MAC Control Element with LCID='00001', Stop MTCH='1000000000'	<--	MAC PDU (MCH Scheduling Information MAC Control Element: LCID='00001', Stop MTCH='1000000000')	-	-
3	The SS transmits 10 MBMS Packets on the MTCH.	<--	MBMS Packets.	-	-
4	The SS transmits an UE TEST LOOP MODE C MBMS PACKET COUNTER REQUEST message to set UE to Mode C.	<--	UE TEST LOOP MODE C MBMS PACKET COUNTER REQUEST	-	-
5	UE responds with UE TEST LOOP MODE C MBMS PACKET COUNTER RESPONSE.	-->	UE TEST LOOP MODE C MBMS PACKET COUNTER RESPONSE	-	-
6	Check: Is the number of reported MBMS Packets received on the MTCH in step 5 greater than zero? (Note: This verifies that MBMS reception is active in the UE in RRC_IDLE mode on Cell 1 before the cell re-selection to Cell 2)	-	-	1	P
7	The SS changes Cell 2 level according to the row "T1" in table 17.4.1.3.2-1.	-	-	-	-
8	The UE executes the generic test procedure described in TS 36.508 subclause 6.4.2.7 and UE should camp on E-UTRA Cell 2. NOTE: The UE performs a TAU procedure and the RRC connection is released.	-	-	-	-
9	SS transmits <i>MBSFNAreaConfiguration</i> message	<--	<i>MBSFNAreaConfiguration</i>	-	-
10	Wait for a period equal to the MCCH modification period for the UE to receive <i>MBSFNAreaConfiguration</i> message		-	-	-
11	The SS transmits a valid MAC PDU including 'MCH Scheduling Information MAC Control Element with LCID='00001', Stop MTCH='1000000000'	<--	MAC PDU (MCH Scheduling Information MAC Control Element: LCID='00001', Stop MTCH='1000000000')	-	-
12	The SS transmits 10 MBMS Packets on the MTCH.	<--	MBMS Packets.	-	-
13	The SS transmits an UE TEST LOOP MODE C MBMS PACKET COUNTER REQUEST message to set UE to Mode C.	<--	UE TEST LOOP MODE C MBMS PACKET COUNTER REQUEST	-	-
14	UE responds with UE TEST LOOP MODE C MBMS PACKET COUNTER RESPONSE.	-->	UE TEST LOOP MODE C MBMS PACKET COUNTER RESPONSE	-	-
15	Check: Is the number of reported MBMS Packets received on the MTCH in step 14 greater than the number of reported in step 5? (Note: This verifies that UE has selected Cell 2 providing the MBMS service and continue MBMS reception)	-	-	1	P

17.4.1.3.3 Specific message contents

Table 17.4.1.3.3-1: *SystemInformationBlockType2* for Cells 1 and 2 (preamble and all steps, Table 17.4.1.3.2-2)

Derivation Path: 36.508 table 4.4.3.3-1, condition MBMS.
--

Table 17.4.2.3.3-2: SystemInformationBlockType15 for Cells 1 and 2 (preamble and all steps, Table 17.4.2.3.2-2)

Derivation Path: 36.508 table 4.4.3.3-14, condition MBMS_intraFreq.

Table 17.4.1.3.3-3: ACTIVATE TEST MODE (preamble)

Derivation Path: 36.508, Table 4.7A-1, condition UE TEST LOOP MODE C.

Table 17.4.1.3.3-2: CLOSE UE TEST LOOP (preamble)

Derivation Path: 36.508, Table 4.7A-3, condition UE TEST LOOP MODE C
--

17.4.2 Cell reselection to inter- frequency cell to start MBMS service reception

17.4.2.1 Test Purpose (TP)

(1)

```

with { UE in E-UTRAN RRC IDLE state on a cell broadcasting SIB15 and interested to receive a MBMS
service}
ensure that {
  when { SIB15 indicates that the MBMS service is available on a frequency of an inter-frequency
neighbour cell }
  then { UE performs cell reselection to the inter-frequency neighbour cell even if the serving
cell is better and starts MBMS reception }
}

```

17.4.2.2 Conformance requirements

References: The conformance requirements covered in the present TC are specified in: TS 36.304, clause 5.2.4.1 and TS 36.331, clause 5.2.2.4. Unless otherwise stated these are Rel-11 requirements.

[TS 36.304 clause 5.2.4.1]

Absolute priorities of different E-UTRAN frequencies or inter-RAT frequencies may be provided to the UE in the system information, in the *RRCCConnectionRelease* message, or by inheriting from another RAT at inter-RAT cell (re)selection. In the case of system information, an E-UTRAN frequency or inter-RAT frequency may be listed without providing a priority (i.e. the field *cellReselectionPriority* is absent for that frequency). If priorities are provided in dedicated signalling, the UE shall ignore all the priorities provided in system information. If UE is in *camped on any cell* state, UE shall only apply the priorities provided by system information from current cell, and the UE preserves priorities provided by dedicated signalling and *deprioritisationReq* received in *RRCCConnectionReject* unless specified otherwise. When the UE in *camped normally* state, has only dedicated priorities other than for the current frequency, the UE shall consider the current frequency to be the lowest priority frequency (i.e. lower than the eight network configured values). While the UE is camped on a suitable CSG cell, the UE shall always consider the current frequency to be the highest priority frequency (i.e. higher than the eight network configured values), irrespective of any other priority value allocated to this frequency. If the UE is capable of MBMS Service Continuity and receiving or interested to receive an MBMS service and can only receive this MBMS service while camping on a frequency on which it is provided, the UE may consider that frequency to be the highest priority during the MBMS session [2] as long as the reselected cell is broadcasting SIB13 and as long as:

- SIB15 of the serving cell indicates for that frequency one or more MBMS SAIs included in the MBMS User Service Description (USD) [22] of this service; or
- SIB15 is not broadcast in the serving cell and that frequency is included in the USD of this service.

If the UE is not capable of MBMS Service Continuity but has knowledge on which frequency an MBMS service of interest is provided, it may consider that frequency to be the highest priority during the MBMS session [2] as long as the reselected cell is broadcasting SIB13.

NOTE: The UE considers that the MBMS session is ongoing using the session start and end times as provided by upper layers in the USD i.e. the UE does not verify if the session is indicated on MCCH.

....

[TS 36.331 clause 5.2.2.4]

The UE shall:

....

1> if the UE is interested to receive MBMS services:

2> if *schedulingInfoList* indicates that *SystemInformationBlockType13* is present and the UE does not have stored a valid version of this system information block:

3> acquire *SystemInformationBlockType13*;

2> if the UE is capable of MBMS Service Continuity:

3> if *schedulingInfoList* indicates that *SystemInformationBlockType15* is present and the UE does not have stored a valid version of this system information block:

4> acquire *SystemInformationBlockType15*;

....

17.4.2.3 Test description

17.4.2.3.1 Pre-test conditions

System Simulator:

- 2 E-UTRA cells with the same PLMN. Cell 1 and Cell 3 are inter-frequency cells. Cell 1 is "Serving cell" and Cell 3 is "Non-suitable cell" as defined in TS36.508 Table 6.2.2.1-1.
- System information combination 18 as defined in TS 36.508[18] clause 4.4.3.1 is used in Cell 1.
- System information combination 20 as defined in TS 36.508[18] clause 4.4.3.1 is used in Cell 3.

UE:

- The UE is configured to receive MBMS services.

Preamble:

- UE is in Registered, Idle mode, Test Mode Activated (State 2A) according to [18] in Cell 1(serving cell) with the UE TEST LOOP MODE C.
- The UE is made interested in receiving a MBMS service associated with the MBMS SAI broadcasted in SIB15 mbms-SAI-InterFreq list on Cell 1 and Cell 3.

17.4.2.3.2 Test procedure sequence

Table 17.4.2.3.2-1 illustrates the downlink power levels and other changing parameters to be applied for the cells at various time instants of the test execution. Row marked "T0" denotes the initial conditions after preamble.

Table 17.4.2.3.2-1: Time instances of cell power level and parameter changes

	Parameter	Unit	Cell 1	Cell 3	Remark
T0	Cell-specific RS EPRE	dBm/15k Hz	-85	-91	The power level values are assigned to satisfy $R_{Cell\ 3} < R_{Cell\ 1}$.

Table 17.4.2.3.2-2: Main behaviour

St	Procedure	Message Sequence		TP	Verdict
		U - S	Message		
1	The UE executes the generic test procedure described in TS 36.508 subclause 6.4.2.7 and UE should camp on E-UTRA Cell 3. NOTE: The UE performs a TAU procedure and the RRC connection is released.	-	-	-	-
2	SS transmits <i>MBSFNAreaConfiguration</i> message on Cell 3	<--	<i>MBSFNAreaConfiguration</i>	-	-
3	Wait for a period equal to the MCCH modification period for the UE to receive <i>MBSFNAreaConfiguration</i> message	-	-	-	-
4	The generic procedures described in TS 36.508 subclause 4.5.3A.3 and 4.5.4.3 are performed on Cell 1 activating UE test loop Mode C.	-	-	-	-
5	The SS transmits a valid MAC PDU including 'MCH Scheduling Information MAC Control Element with LCID='00001', Stop MTCH='10000000000'	<--	MAC PDU (MCH Scheduling Information MAC Control Element: LCID='00001', Stop MTCH='10000000000')	-	-
6	The SS transmits 10 MBMS Packets on the MTCH.	<--	MBMS Packets.	-	-
7	The SS transmits an UE TEST LOOP MODE C MBMS PACKET COUNTER REQUEST message to set UE to Mode C.	<--	UE TEST LOOP MODE C MBMS PACKET COUNTER REQUEST	-	-
8	UE responds with UE TEST LOOP MODE C MBMS PACKET COUNTER RESPONSE.	-->	UE TEST LOOP MODE C MBMS PACKET COUNTER RESPONSE	-	-
9	Check: Is the number of reported MBMS Packets received on the MTCH in step 8 greater than zero? (Note: This verifies that UE has selected Cell 3 providing the MBMS service and starts MBMS reception)	-	-	1	P

17.4.2.3.3 Specific message contents

Table 17.4.2.3.3-1: *SystemInformationBlockType2* for Cell 3 (preamble and all steps, Table 17.4.2.3.2-2)

Derivation Path: 36.508 table 4.4.3.3-1, condition MBMS.

Table 17.4.2.3.3-2: *SystemInformationBlockType15* for Cell 1 (preamble and all steps, Table 17.4.2.3.2-2)

Derivation Path: 36.508 table 4.4.3.3-14, condition MBMS_interFreq.			
<i>SystemInformationBlockType15</i> ::= SEQUENCE {			
mbms-SAI-IntraFreq-r11 SEQUENCE (SIZE (1..maxSAI-MBMS-r11)) OF { INTEGER (0..65535) }	Not present		
mbms-SAI-InterFreqList-r11[1] SEQUENCE (SIZE (1..maxFreq)) OF SEQUENCE {		1 entry	
dl-CarrierFreq-r11	Downlink EARFCN for Cell 3, see table 6.3.1.2-1.		
mbms-SAI-List-r11[1] SEQUENCE (SIZE (1..maxSAI-MBMS-r11)) OF { INTEGER (0..65535) }	1	1 entry INTEGER (0..65535)	

Table 17.4.2.3.3-3: *SystemInformationBlockType15* for Cell 3 (preamble and all steps, Table 17.4.2.3.2-2)

Derivation Path: 36.508 table 4.4.3.3-14, condition MBMS_intraFreq.

Table 17.4.2.3.3-4: ACTIVATE TEST MODE (preamble)

Derivation Path: 36.508, Table 4.7A-1, condition UE TEST LOOP MODE C.

Table 17.4.2.3.3-4: CLOSE UE TEST LOOP (step 4, Table 17.4.2.3.2-2)

Derivation Path: 36.508, Table 4.7A-3, condition UE TEST LOOP MODE C
--

17.4.3 17.4.4 Handover to intra-frequency cell to continue MBMS service reception

17.4.4.1 Test Purpose (TP)

(1)

```

with { UE in E-UTRA RRC_Connected state AND is receiving MBMS service }
ensure that {
  when { UE receives RRCConnectionReconfiguration message including a mobilityControlInfo for intra
frequency neighbour cell providing MBMS service }
  then { UE performs intra frequency handover and continues to receive MBMS service }
}

```

17.4.4.2 Conformance requirements

References: The conformance requirements covered in the present TC are specified in: TS 36.306 clause 4.3.5.2. Unless otherwise stated these are Rel-11 requirements.

[TS 36.306 clause 4.3.5.2]

This field defines the carrier aggregation, MIMO and MBMS reception capabilities supported by the UE for configurations with inter-band, intra-band non-contiguous, intra-band contiguous carrier aggregation and without carrier aggregation. For each band in a band combination the UE provides the supported CA bandwidth classes and the corresponding MIMO capabilities for downlink. The UE also has to provide the supported uplink CA bandwidth class and the corresponding MIMO capability for at least one band in the band combination. A MIMO capability applies to all carriers of a bandwidth class of a band in a band combination.

In all non-CA band combinations the UE shall indicate a bandwidth class supporting the maximum channel bandwidth defined for the band.

In all non-CA band combinations the UE shall indicate at least the number of layers for spatial multiplexing according to the UE's Rel-8/9 category (Cat. 1-5). If the UE provides a Rel-10 category (Cat. 6-8) it shall indicate at least the number of layers according to that category for at least one band combination. In all other band combinations a UE indicating a category between 2 and 8 shall indicate support for at least 2 layers for downlink spatial multiplexing for all bands. The indicated number of layers for spatial multiplexing may exceed the number of layers required according to the category indicated by the UE. The carrier aggregation and MIMO capabilities indicated for at least one band combination shall meet the processing requirements defined by the physical layer parameter values in the UE category (i.e., maximum number of DL-SCH/UL-SCH transport block bits received/transmitted within a TTI, maximum number of bits of a DL-SCH/UL-SCH transport block received/transmitted within a TTI, and total number of soft channel bits for downlink).

The UE supporting MBMS procedures shall support MBMS reception on any serving cell and on any cell that may be additionally configured as serving cell according to this field.

17.4.4.3 Test description

17.4.4.3.1 Pre-test conditions

System Simulator:

- Cell 1 & Cell 2 are on the same E-UTRA frequency and belongs to same MBSFN area.
- System information combination 19 as defined in TS 36.508[18] clause 4.4.3.1 is used in E-UTRA Cell 1.
- System information combination 19 as defined in TS 36.508[18] clause 4.4.3.1 is used in E-UTRA Cell 2.

UE:

- The UE is configured to receive MBMS services.

Preamble:

- UE is in Registered, Idle mode, Test Mode Activated (State 2A) with UE TEST LOOP MODE C on Cell 1 according to [18].
- The UE is made interested in receiving a MBMS service associated with the MBMS SAI broadcasted in SIB15 mbms-SAI-IntraFreq list on Cell 1 and Cell 2.

17.4.4.3.2 Test procedure sequence

Table 17.4.4.3.2-1 illustrates the downlink power levels and other changing parameters to be applied for the cells at various time instants of the test execution. Row marked "T0" denotes the initial conditions after preamble, while columns marked "T0", and "T1" are to be applied subsequently. The exact instants on which these values shall be applied are described in the texts in this clause.

Table 17.4.4.3.2-1: Time instances of cell power level and parameter changes

	Parameter	Unit	Cell 1	Cell 2	Remark
T0	Cell-specific RS EPRE	dBm/15k Hz	-85	-91	The power level values are such that measurement results for Cell 1 (M1) and Cell 2 (M2) satisfy exit condition for event A3 ($M2 < M1$).
T1	Cell-specific RS EPRE	dBm/15k Hz	-85	-79	The power level values are such that measurement results for Cell 1 (M1) and Cell 2 (M2) satisfy entry condition for event A3 ($M2 > M1$).

Table 17.4.4.3.2-2: Main behaviour

St	Procedure	Message Sequence		TP	Verdict
		U - S	Message		
1	The generic procedures described in TS 36.508 sub clause 4.5.3A.3 and 4.5.4.3 are performed on Cell 1 activating UE test loop Mode C.	-	-	-	-
2	The SS transmits a valid MAC PDU including 'MCH Scheduling Information MAC Control Element with LCID='00001', Stop MTCH='1000000000'	<--	MAC PDU (MCH Scheduling Information MAC Control Element: LCID='00001', Stop MTCH='1000000000')	-	-
3	The SS transmits 10 MBMS Packets on the MTCH.	<--	MBMS Packets.	-	-
4	The SS transmits an UE TEST LOOP MODE C MBMS PACKET COUNTER REQUEST message.	<--	UE TEST LOOP MODE C MBMS PACKET COUNTER REQUEST	-	-
5	UE responds with UE TEST LOOP MODE C MBMS PACKET COUNTER RESPONSE.	-->	UE TEST LOOP MODE C MBMS PACKET COUNTER RESPONSE	-	-
6	Check: Is the number of reported MBMS Packets received on the MTCH in step5 greater than zero? (Note1)	-	-	1	P
7	The SS transmits an <i>RRConnectionReconfiguration</i> message to setup intra frequency measurement on Cell 1.	<--	<i>RRConnectionReconfiguration</i>	-	-
8	The UE transmits an <i>RRConnectionReconfigurationComplete</i> message on Cell 1 to confirm the setup of intra frequency measurement.	-->	<i>RRConnectionReconfigurationComplete</i>	-	-
9	The SS changes Cell 1 and Cell 2 level according to the row "T1" in table 17.4.3.3.2-1.	-	-	-	-
10	The UE transmits a <i>MeasurementReport</i> message to report event A3 on Cell 1 with the measured RSRP, RSRQ value for Cell 2.	-->	<i>MeasurementReport</i>		
11	The SS transmits an <i>RRConnectionReconfiguration</i> message on Cell 1 to order the UE to perform intra-frequency handover to Cell 2.	<--	<i>RRConnectionReconfiguration</i>	-	-
12	The UE transmits an <i>RRConnectionReconfigurationComplete</i> message on Cell 2?	-->	<i>RRConnectionReconfigurationComplete</i>	-	-
13	The SS transmits a valid MAC PDU including 'MCH Scheduling Information MAC Control Element with LCID='00001', Stop MTCH='1000000000'	<--	MAC PDU (MCH Scheduling Information MAC Control Element: LCID='00001', Stop MTCH='1000000000')	-	-
14	The SS transmits 10 MBMS Packets on the MTCH.	<--	MBMS Packets.	-	-
15	The SS transmits an UE TEST LOOP MODE C MBMS PACKET COUNTER REQUEST message.	<--	UE TEST LOOP MODE C MBMS PACKET COUNTER REQUEST	-	-
16	UE responds with UE TEST LOOP MODE C MBMS PACKET COUNTER RESPONSE.	-->	UE TEST LOOP MODE C MBMS PACKET COUNTER RESPONSE	-	-
17	Check: Is the number of reported MBMS Packets received on the MTCH in step16 greater than the number of MBMS Packets reported in step5? (Note2)	-	-	1	P
Note1: This verifies that UE is receiving active MBMS reception on Cell 1 before Intra-frequency handover to Cell 2.					
Note2: This verifies that UE has performed intra-frequency handover to Cell 2 providing the MBMS service and continue MBMS reception.					

17.4.4.3.3 Specific message contents

Table 17.4.4.3.3-1: SystemInformationBlockType2 for Cells 1 and 2 (Preamble and all steps, Table 17.4.4.3.2-2)

Derivation Path: 36.508 table 4.4.3.3-1, condition MBMS.

Table 17.4.4.3.3-2: SystemInformationBlockType15 for Cells 1 and 2 (preamble and all steps, Table 17.4.4.3.2-2)

Derivation Path: 36.508 table 4.4.3.3-14, condition MBMS_intraFreq.

Table 17.4.4.3.3-3: RRCConnectionReconfiguration (step 7, Table 17.4.4.3.2-2)

Derivation Path: 36.508, Table 4.6.1-8, condition MEAS

Table 17.4.4.3.3-4: MeasConfig (Table 17.4.4.3.3-3)

Derivation Path: 36.508, Table 4.6.6-1			
Information Element	Value/remark	Comment	Condition
MeasConfig SEQUENCE {			
measObjectToAddModList SEQUENCE (SIZE (1..maxObjectId)) OF SEQUENCE {	1 entry		
measObjectId[1]	IdMeasObject-f1		
measObject[1]	MeasObjectEUTRA-GENERIC(f1)		
}			
reportConfigToAddModList SEQUENCE (SIZE (1..maxReportConfigId)) OF SEQUENCE {	1 entry		
reportConfigId[1]	IdReportConfig-A3		
reportConfig[1]	ReportConfigEUTRA-A3		
}			
measIdToAddModList SEQUENCE (SIZE (1..maxMeasId)) OF SEQUENCE {	1 entry		
measId[1]	1		
measObjectId[1]	IdMeasObject-f1		
reportConfigId[1]	IdReportConfig-A3		
}			
}			

Table 17.4.4.3.3-5: *MeasurementReport* (step 10, Table 17.4.4.3.2-2)

Derivation Path: 36.508, Table 4.6.1-5			
Information Element	Value/remark	Comment	Condition
MeasurementReport ::= SEQUENCE {			
criticalExtensions CHOICE {			
c1 CHOICE{			
measurementReport-r8 SEQUENCE {			
measResults SEQUENCE {			
measId	1		
measResultServCell SEQUENCE {			
rsrpResult	(0..97)		
rsrqResult	(0..34)		
}			
measResultNeighCells CHOICE {			
measResultListEUTRA SEQUENCE (SIZE (1..maxCellReport)) OF SEQUENCE {	1 entry		
physCellId[1]	PhysicalCellIdentity of Cell 2		
cgi-Info[1]	Not present		
measResult[1] SEQUENCE {			
rsrpResult	(0..97)		
rsrqResult	(0..34)		
}			
}			
}			
}			
}			

Table 17.4.4.3.3-6: *RRCConnectionReconfiguration* (step 12, Table 17.4.4.3.2-2)

Derivation Path: 36.508, Table 4.6.1-8, condition HO
--

Table 17.4.4.3.3-7: *MobilityControlInfo* (Table 17.4.4.3.3-6)

Derivation Path: 36.508, Table 4.6.5-1			
Information Element	Value/remark	Comment	Condition
MobilityControlInfo ::= SEQUENCE {			
targetPhysCellId	PhysicalCellIdentity of Cell 2		
carrierFreq	Not present		
}			

17.4.5

17.4.6 MBMS Interest Indication retransmission after returning from cell not broadcasting SIB15

17.4.6.1 Test Purpose (TP)

(1)

```

with { UE in E-UTRA RRC_Connected state AND is receiving MBMS service and having transmitted a MBMSInterestIndication message }
ensure that {
  when { UE performs handover to a Pcell not broadcasting SystemInformationBlockType15 followed by a handover to a Pcell broadcasting SystemInformationBlockType15 }
  then { UE transmits a MBMSInterestIndication message }
}

```

17.4.6.2 Conformance requirements

References: The conformance requirements covered in the present TC are specified in: TS 36.331 clauses 5.8.5.2, 5.8.5.3 and 5.8.5.4. Unless otherwise stated these are Rel-11 requirements.

[TS 36.331 clause 5.8.5.3]

The UE shall:

- 1> consider a frequency to be part of the MBMS frequencies of interest if the following conditions are met:
 - 2> at least one MBMS session the UE is receiving or interested to receive via an MRB is ongoing or about to start; and

NOTE 1: The UE may determine whether the session is ongoing from the start and stop time indicated in the User Service Description (USD), see 3GPP TS 36.300 [9] or 3GPP TS 26.346 [57].

- 2> for at least one of these MBMS sessions *SystemInformationBlockType15* acquired from the PCell includes for the concerned frequency one or more MBMS SAIs as indicated in the USD for this session; and

NOTE 2: The UE considers a frequency to be part of the MBMS frequencies of interest even though E-UTRAN may (temporarily) not employ an MRB for the concerned session. I.e. the UE does not verify if the session is indicated on MCCH.

- 2> the UE is capable of simultaneously receiving the set of MBMS frequencies of interest, regardless of whether a serving cell is configured on each of these frequencies or not; and
- 2> the *supportedBandCombination* the UE included in *UE-EUTRA-Capability* contains at least one band combination including the set of MBMS frequencies of interest;

NOTE 3: Indicating a frequency implies that the UE supports *SystemInformationBlockType13* acquisition for the concerned frequency i.e. the indication should be independent of whether a serving cell is configured on that frequency.

NOTE 4: When evaluating which frequencies it can receive simultaneously, the UE does not take into account the serving frequencies that are currently configured i.e. it only considers MBMS frequencies it is interested to receive.

[TS 36.331 clause 5.8.5.4]

The UE shall set the contents of the *MBMSInterestIndication* message as follows:

- 1> if the set of MBMS frequencies of interest, determined in accordance with 5.8.5.3, is not empty:
 - 2> include *mbms-FreqList* and set it to include the MBMS frequencies of interest;
 - 2> include *mbms-Priority* if the UE prioritises reception of all indicated MBMS frequencies above reception of any of the unicast bearers;

NOTE: If the UE prioritises MBMS reception and unicast data cannot be supported because of congestion on the MBMS carrier(s), E-UTRAN may initiate release of unicast bearers. It is up to E-UTRAN implementation whether all bearers or only GBR bearers are released. E-UTRAN does not initiate re-establishment of the released unicast bearers upon alleviation of the congestion.

The UE shall submit the *MBMSInterestIndication* message to lower layers for transmission.

17.4.6.3 Test description

17.4.6.3.1 Pre-test conditions

System Simulator:

- 2 E-UTRA cells with the same PLMN, Cell 1 and Cell 2 are intra-frequency cells. Cell 1 is a MBMS cell and Cell 2 is a non-MBMS cell.
- System information combination 19 as defined in TS 36.508[18] clause 4.4.3.1 is used in E-UTRA Cell 1.

- System information combination 2 as defined in TS 36.508[18] clause 4.4.3.1 is used in E-UTRA Cell 2.

UE:

- The UE is configured to receive MBMS services.
- The UE is configured to be interested in receiving MBMS service associated with the MBMS SAI broadcasted in SIB15 on Cell 1.

Preamble:

- UE is in state Generic RB Established (state 3) on Cell 1 according to [18]. SS does not send any SIB15 on Cell 1.

17.4.6.3.2 Test procedure sequence

Table 17.4.6.3.2-1 illustrates the downlink power levels and other changing parameters to be applied for the cells at various time instants of the test execution. Row marked "T0" denotes the initial conditions after preamble, while columns marked "T0", "T1" and "T2" are to be applied subsequently. The exact instants on which these values shall be applied are described in the texts in this clause.

Table 17.4.6.3.2-1: Time instances of cell power level and parameter changes

	Parameter	Unit	Cell 1	Cell 2	Remark
T0	Cell-specific RS EPRE	dBm/15k Hz	-85	-91	The power level values are such that measurement results for Cell 1 (M1) and Cell 2 (M2) satisfy exit condition for event A3 ($M1 > M2$).
T1	Cell-specific RS EPRE	dBm/15k Hz	-91	-85	The power level values are such that measurement results for Cell 1 (M1) and Cell 2 (M2) satisfy entry condition for event A3 ($M2 > M1$).
T2	Cell-specific RS EPRE	dBm/15k Hz	-85	-91	The power level values are such that measurement results for Cell 1 (M1) and Cell 2 (M2) satisfy entry condition for event A3 ($M1 > M2$).

Table 17.4.6.3.2-2: Main behaviour

St	Procedure	Message Sequence		TP	Verdict
		U - S	Message		
1	SS starts broadcast of <i>SystemInformationBlockType15</i> on Cell 1	<--	<i>SystemInformationBlockType15</i>	-	-
2	Check: Does the UE transmit <i>MBMSInterestIndication</i> message.	-->	<i>MBMSInterestIndication</i>	1	P
3	The SS transmits an <i>RRCCONNECTIONRECONFIGURATION</i> message to setup inter frequency measurement on Cell 2.	<--	<i>RRCCONNECTIONRECONFIGURATION</i>	-	-
4	The UE transmits an <i>RRCCONNECTIONRECONFIGURATIONCOMPLETE</i> message on Cell 2 to confirm the setup of inter frequency measurement.	-->	<i>RRCCONNECTIONRECONFIGURATIONCOMPLETE</i>	-	-
5	The SS changes Cell 1 and Cell 2 level according to the row "T1" in table 17.4.6.3.2-1.	-	-	-	-
6	The UE transmits a <i>MEASUREMENTREPORT</i> message to report event A3 on Cell 1 with the measured RSRP, RSRQ value for Cell 2.	-->	<i>MEASUREMENTREPORT</i>		
7	The SS transmits an <i>RRCCONNECTIONRECONFIGURATION</i> message on Cell 1 to order the UE to perform inter-frequency handover to Cell 2.	<--	<i>RRCCONNECTIONRECONFIGURATION</i>	-	-
8	The UE transmit an <i>RRCCONNECTIONRECONFIGURATIONCOMPLETE</i> message on Cell 2	-->	<i>RRCCONNECTIONRECONFIGURATIONCOMPLETE</i>	-	-
9	The SS transmits an <i>RRCCONNECTIONRECONFIGURATION</i> message to setup intra frequency measurement on Cell 2.	<--	<i>RRCCONNECTIONRECONFIGURATION</i>	-	-
10	The UE transmits an <i>RRCCONNECTIONRECONFIGURATIONCOMPLETE</i> message on Cell 2 to confirm the setup of intra frequency measurement.	-->	<i>RRCCONNECTIONRECONFIGURATIONCOMPLETE</i>	-	-
11	The SS changes Cell 1 and Cell 2 levels according to the row "T2" in table 17.4.6.3.2-1.	-	-	-	-
12	The UE transmits a <i>MEASUREMENTREPORT</i> message to report event A3 on Cell 2 with the measured RSRP, RSRQ value for Cell 1.	-->	<i>MEASUREMENTREPORT</i>	-	-
13	The SS transmits an <i>RRCCONNECTIONRECONFIGURATION</i> message on Cell 2 to order the UE to perform intra-frequency handover to Cell 1.	<--	<i>RRCCONNECTIONRECONFIGURATION</i>	-	-
14	The UE transmit an <i>RRCCONNECTIONRECONFIGURATIONCOMPLETE</i> message on Cell 1?	-->	<i>RRCCONNECTIONRECONFIGURATIONCOMPLETE</i>	-	-
15	Check: Does the UE transmit <i>MBMSInterestIndication</i> message.	-->	<i>MBMSInterestIndication</i>	2	P

17.4.6.3.3 Specific message contents

Table 17.4.6.3.3-1: *SystemInformationBlockType2* for Cells 1 and 2 (Preamble and all steps, Table 17.4.6.3.2-2)

Derivation Path: 36.508 table 4.4.3.3-1, condition MBMS.
--

Table 17.4.6.3.3-2: *RRCCONNECTIONRECONFIGURATION* (step 3 and 9, Table 17.4.6.3.2-2)

Derivation Path: 36.508, Table 4.6.1-8, condition MEAS
--

Table 17.4.6.3.3-3: MeasConfig (step 3 and 9, Table 17.4.4.3.3-3)

Derivation Path: 36.508, Table 4.6.6-1			
Information Element	Value/remark	Comment	Condition
MeasConfig SEQUENCE {			
measObjectToAddModList SEQUENCE (SIZE (1..maxObjectId)) OF SEQUENCE {	1 entry		
measObjectId[1]	IdMeasObject-f1		
measObject[1]	MeasObjectEUTRA-GENERIC(f1)		
}			
reportConfigToAddModList SEQUENCE (SIZE (1..maxReportConfigId)) OF SEQUENCE {	1 entry		
reportConfigId[1]	IdReportConfig-A3		
reportConfig[1]	ReportConfigEUTRA-A3		
}			
measIdToAddModList SEQUENCE (SIZE (1..maxMeasId)) OF SEQUENCE {	1 entry		
measId[1]	1		
measObjectId[1]	IdMeasObject-f1		
reportConfigId[1]	IdReportConfig-A3		
}			
}			

Table 17.4.6.3.3-4: MeasurementReport (step 6, Table 17.4.6.3.2-2)

Derivation Path: 36.508, Table 4.6.1-5			
Information Element	Value/remark	Comment	Condition
MeasurementReport ::= SEQUENCE {			
criticalExtensions CHOICE {			
c1 CHOICE{			
measurementReport-r8 SEQUENCE {			
measResults SEQUENCE {			
measId	1		
measResultServCell SEQUENCE {			
rsrpResult	(0..97)		
rsrqResult	(0..34)		
}			
measResultNeighCells CHOICE {			
measResultListEUTRA SEQUENCE (SIZE (1..maxCellReport)) OF SEQUENCE {	1 entry		
physCellId[1]	PhysicalCellIdentity of Cell 2		
cgi-Info[1]	Not present		
measResult[1] SEQUENCE {			
rsrpResult	(0..97)		
rsrqResult	(0..34)		
}			
}			
}			
}			
}			
}			
}			

Table 17.4.6.3.3-5: *MeasurementReport* (step 12, Table 17.4.6.3.2-2)

Derivation Path: 36.508, Table 4.6.1-5			
Information Element	Value/remark	Comment	Condition
MeasurementReport ::= SEQUENCE {			
criticalExtensions CHOICE {			
c1 CHOICE{			
measurementReport-r8 SEQUENCE {			
measResults SEQUENCE {			
measId	2		
measResultServCell SEQUENCE {			
rsrpResult	(0..97)		
rsrqResult	(0..34)		
}			
measResultNeighCells CHOICE {			
measResultListEUTRA SEQUENCE (SIZE (1..maxCellReport)) OF SEQUENCE {	1 entry		
physCellId[1]	PhysicalCellIdentity of Cell 1		
cgi-Info[1]	Not present		
measResult[1] SEQUENCE {			
rsrpResult	(0..97)		
rsrqResult	(0..34)		
}			
}			
}			
}			
}			
}			

Table 17.4.6.3.3-6: *MBMSInterestIndication* (step 2 and 15, Table 17.4.6.3.2-2)

Derivation Path: 36.508, Table 4.6.1-4AC			
Information Element	Value/remark	Comment	Condition
criticalExtensions CHOICE {			
c1 CHOICE{			
interestIndication-r11 OF SEQUENCE {			
mbms-FreqList-r11[1] SEQUENCE (SIZE (1..maxFreqMBMS-r11)) OF { INTEGER (0..maxEARFCN2) }	EARFCN of Cell 1		
}			
}			
}			

17.4.7 MBMS Interest Indication after Radio Link Failure

17.4.7.1 Test Purpose (TP)

(1)

```
with { UE in RRC_CONNECTED }
ensure that {
  when { the UE detects a radio link failure less than 1 second after the last transmission of an
MBMSInterestIndication message }
  then { the UE transmits a MBMSInterestIndication message }
}
```

17.4.7.2 Conformance requirements

References: The conformance requirements covered in the present TC are specified in: TS 36.331, clauses 5.3.7.5, 5.8.5.3 and 5.8.5.4. Unless otherwise stated these are Rel-11 requirements.

[TS 36.331, clause 5.3.7.5]

- 1> if *SystemInformationBlockType15* is broadcast by the PCell:
 - 2> if the UE has transmitted an *MBMSInterestIndication* message during the last 1 second preceding detection of radio link failure:
 - 3> ensure having a valid version of *SystemInformationBlockType15* for the PCell;
 - 3> determine the set of MBMS frequencies of interest in accordance with 5.8.5.3;
 - 3> initiate transmission of the *MBMSInterestIndication* message in accordance with 5.8.5.4;

[TS 36.331, clause 5.8.5.3]

The UE shall:

- 1> consider a frequency to be part of the MBMS frequencies of interest if the following conditions are met:
 - 2> at least one MBMS session the UE is receiving or interested to receive via an MRB is ongoing or about to start; and

NOTE 1: The UE may determine whether the session is ongoing from the start and stop time indicated in the User Service Description (USD), see 3GPP TS 36.300 [9] or 3GPP TS 26.346 [57].

- 2> for at least one of these MBMS sessions *SystemInformationBlockType15* acquired from the PCell includes for the concerned frequency one or more MBMS SAIs as indicated in the USD for this session; and

NOTE 2: The UE considers a frequency to be part of the MBMS frequencies of interest even though E-UTRAN may (temporarily) not employ an MRB for the concerned session. I.e. the UE does not verify if the session is indicated on MCCH.

- 2> the UE is capable of simultaneously receiving the set of MBMS frequencies of interest, regardless of whether a serving cell is configured on each of these frequencies or not; and
- 2> the *supportedBandCombination* the UE included in *UE-EUTRA-Capability* contains at least one band combination including the set of MBMS frequencies of interest;

NOTE 3: Indicating a frequency implies that the UE supports *SystemInformationBlockType13* acquisition for the concerned frequency i.e. the indication should be independent of whether a serving cell is configured on that frequency.

NOTE 4: When evaluating which frequencies it can receive simultaneously, the UE does not take into account the serving frequencies that are currently configured i.e. it only considers MBMS frequencies it is interested to receive.

NOTE 5: Within this section, the term frequency does not indicate a physical frequency but covers the associated band(s), noting that additional bands may be indicated in *SystemInformationBlockType1* (serving frequency) or *SystemInformationBlockType15* (neighbouring frequencies).

[TS 36.331, clause 5.8.5.4]

The UE shall set the contents of the *MBMSInterestIndication* message as follows:

- 1> if the set of MBMS frequencies of interest, determined in accordance with 5.8.5.3, is not empty:
 - 2> include *mbms-FreqList* and set it to include the MBMS frequencies of interest, using the EARFCN corresponding with *freqBandIndicator* included in *SystemInformationBlockType1*, if applicable, and the EARFCN(s) as included in *SystemInformationBlockType15*;

NOTE 1: The *mbms-FreqList* merely indicates the physical frequencies the UE is interested to receive and does not imply the UE supports the associated band.

- 2> include *mbms-Priority* if the UE prioritises reception of all indicated MBMS frequencies above reception of any of the unicast bearers;

NOTE 2: If the UE prioritises MBMS reception and unicast data cannot be supported because of congestion on the MBMS carrier(s), E-UTRAN may initiate release of unicast bearers. It is up to E-UTRAN implementation whether all bearers or only GBR bearers are released. E-UTRAN does not initiate re-establishment of the released unicast bearers upon alleviation of the congestion.

The UE shall submit the *MBMSInterestIndication* message to lower layers for transmission.

17.4.7.3 Test description

17.4.7.3.1 Pre-test conditions

System Simulator:

- 2 cells on the same E-UTRA frequency and with the same PLMN. Cell 1 "Serving cell", Cell 2 is "Non-suitable cell" as defined in TS36.508 Table 6.2.2.1-1.
- The 2 cells are part of the same MBSFN area.
- System information combination 19 as defined in TS 36.508[18] clause 4.4.3.1 is used in Cell 1 and Cell 2.

UE:

- The UE is configured to receive MBMS services

Preamble:

- The UE is in state Registered, Idle Mode (state 2) on Cell 1 according to [18].
- The UE is made interested in receiving MBMS service in the PLMN associated with the MBMS SAI broadcasted in SIB15 mbms-SAI-IntraFreq list on Cell 1 and Cell 2.

17.4.7.3.2 Test procedure sequence

Table 17.4.7.3.2-1 illustrates the downlink power levels and other changing parameters to be applied for the cells at various time instants of the test execution. Row marked "T0" denotes the initial conditions after preamble, while the row marked "T1" is to be applied subsequently. The exact instants on which these values shall be applied are described in the text of the column "Procedure" in Table 17.4.7.3.2-2.

Table 17.4.7.3.2-1: Time instances of cell power level and parameter changes

	Parameter	Unit	Cell 1	Cell 2
T0	Cell-specific RS EPRE	dBm/15kHz	-85	-115
T1	Cell-specific RS EPRE	dBm/15kHz	-115	-85

Table 17.4.7.3.2-2: Main behaviour

St	Procedure	Message Sequence		TP	Verdict
		U - S	Message		
1	Generic test procedure Generic Radio Bearer Establishment as described in TS 36.508 subclause 4.5.3 is executed.	-	-	-	-
2	UE transmits <i>MBMSInterestIndication</i> message.	-->	<i>MBMSInterestIndication</i>	-	-
3	SS re-adjusts the cell-specific reference signal level according to row "T1" in table 17.4.7.3.2-1.	-	-	-	-
-	The following messages are to be observed on Cell 2 unless explicitly stated otherwise.	-	-	-	-
4	UE transmits <i>RRCCONNECTIONREESTABLISHMENTREQUEST</i> message.	-->	<i>RRCCONNECTIONREESTABLISHMENTREQUEST</i>	-	-
5	SS transmits <i>RRCCONNECTIONREESTABLISHMENT</i> message.	<--	<i>RRCCONNECTIONREESTABLISHMENT</i>	-	-
6	UE transmits <i>RRCCONNECTIONREESTABLISHMENTCOMPLETE</i> message.	-->	<i>RRCCONNECTIONREESTABLISHMENTCOMPLETE</i>	-	-
7	SS transmits an <i>RRCCONNECTIONRECONFIGURATION</i> message to resume existing radio bearer.	<--	<i>RRCCONNECTIONRECONFIGURATION</i>	-	-
8	UE transmits an <i>RRCCONNECTIONRECONFIGURATIONCOMPLETE</i> message.	-->	<i>RRCCONNECTIONRECONFIGURATIONCOMPLETE</i>	-	-
9	Check: Does the UE transmit <i>MBMSInterestIndication</i> message?	-->	<i>MBMSInterestIndication</i>	1	P

17.4.7.3.3 Specific message contents

Table 17.4.1.3.3-1: *SystemInformationBlockType2* for Cells 1 and 2 (preamble and all steps, Table 17.4.1.3.2-2)

Derivation Path: 36.508 table 4.4.3.3-1, condition MBMS.

Table 17.4.2.3.3-2: *SystemInformationBlockType15* for Cells 1 and 2 (preamble and all steps, Table 17.4.2.3.2-2)

Derivation Path: 36.508 table 4.4.3.3-14, condition MBMS_intraFreq.

Table 17.4.7.3.3-3: *MBMSInterestIndication* (steps 2 and 9, Table 17.4.7.3.2-2)

Derivation Path: 36.508 Table 4.6.1-4AC			
Information Element	Value/remark	Comment	Condition
criticalExtensions CHOICE {			
c1 CHOICE{			
interestIndication-r11 OF SEQUENCE {			
mbms-FreqList-r11[1] SEQUENCE (SIZE (1..maxFreqMBMS-r11)) OF { INTEGER (0..maxEARFCN2) }	EARFCN of Cell 1	1 entry	
}			
}			
}			

17.4.8 Continued MBMS service reception after E-UTRAN release of unicast bearer

17.4.8.1 Test Purpose (TP)

(1)

```
with { UE prioritising MBMS service over unicast data }
ensure that {
  when { UE enters RRC Connected state on a MBMS cell broadcasting
SystemInformationBlockType15 }
  then { UE transmits a MBMSInterestIndication message including the mbms-Priority IE indicating
that UE prioritises reception of MBMS frequencies above reception of any of the unicast bearers }
}
```

(2)

```
with { UE in E-UTRA RRC_Connected state with a unicast bearer configured AND is receiving MBMS
service }
ensure that {
  when { UE receives a RRCConnectionReconfiguration message to release the unicast bearer }
  then { UE accepts the release of the unicast bearer and continues to receive MBMS service }
}
```

17.4.8.2 Conformance requirements

References: The conformance requirements covered in the present TC are specified in: TS 36.331 clause 5.8.5.4. Unless otherwise stated these are Rel-11 requirements.

[TS 36.331 clause 5.8.5.4]

The UE shall set the contents of the *MBMSInterestIndication* message as follows:

- 1> if the set of MBMS frequencies of interest, determined in accordance with 5.8.5.3, is not empty:
 - 2> include *mbms-FreqList* and set it to include the MBMS frequencies of interest, using the EARFCN corresponding with *freqBandIndicator* included in *SystemInformationBlockType1*, if applicable, and the EARFCN(s) as included in *SystemInformationBlockType15*;

NOTE 1: The *mbms-FreqList* merely indicates the physical frequencies the UE is interested to receive and does not imply the UE supports the associated band.

- 2> include *mbms-Priority* if the UE prioritises reception of all indicated MBMS frequencies above reception of any of the unicast bearers;

NOTE 2: If the UE prioritises MBMS reception and unicast data cannot be supported because of congestion on the MBMS carrier(s), E-UTRAN may initiate release of unicast bearers. It is up to E-UTRAN implementation whether all bearers or only GBR bearers are released. E-UTRAN does not initiate re-establishment of the released unicast bearers upon alleviation of the congestion.

The UE shall submit the *MBMSInterestIndication* message to lower layers for transmission.

17.4.8.3 Test description

17.4.8.3.1 Pre-test conditions

System Simulator:

- Cell 1 "Serving cell", as defined in TS36.508 Table 6.2.2.1-1.
- System information combination 19 as defined in TS 36.508[18] clause 4.4.3.1 is used in E-UTRA Cell 1.

UE:

- The UE is configured to receive MBMS services with priorities above reception of the unicast bearer.
- The UE is made interested in receiving MBMS service in the PLMN associated with the MBMS SAI broadcasted in SIB15 on Cell 1.

Preamble:

- UE is in Registered, Connected mode with a unicast bearer established, e.g. via a DRB, Test Mode Activated (State 2A) with UE TEST LOOP MODE C on Cell 1 according to [18].

17.4.8.3.2 Test procedure sequence

Table 17.4.8.3.2-1: Main behaviour

St	Procedure	Message Sequence		TP	Verdict
		U - S	Message		
1	The SS transmits a <i>Paging</i> message including a <i>systemInfoModification</i> for cell1.	<--	<i>Paging</i>	-	-
-	EXCEPTION: the behaviour in table 17.4.8.3.2-2 runs in parallel with steps 3 to 7 below.	-	-	-	-
2	From the beginning of the next modification period the SS also transmits <i>SystemInformationBlockType15</i>	<--	<i>SystemInformationBlockType15</i>	-	-
3	SS transmits <i>MBSFNAreaConfiguration</i> message.	<--	<i>MBSFNAreaConfiguration</i>	-	-
4	Wait for a period equal to the MCCH modification period for the UE to receive <i>MBSFNAreaConfiguration</i> message.	-	-	-	-
5	The generic procedures described in TS 36.508 sub clause 4.5.3A.3 and 4.5.4.3 are performed on Cell 1 activating UE test loop Mode C.	-	-	-	-
6	The SS transmits a valid MAC PDU including 'MCH Scheduling Information MAC Control Element with LCID='00001', Stop MTCH='10000000000'	<--	MAC PDU (MCH Scheduling Information MAC Control Element: LCID='00001', Stop MTCH='10000000000')	-	-
7	The SS transmits 10 MBMS Packets on the MTCH.	<--	MBMS Packets.	-	-
8	The SS transmits an UE TEST LOOP MODE C MBMS PACKET COUNTER REQUEST message.	<--	UE TEST LOOP MODE C MBMS PACKET COUNTER REQUEST	-	-
9	UE responds with UE TEST LOOP MODE C MBMS PACKET COUNTER RESPONSE.	-->	UE TEST LOOP MODE C MBMS PACKET COUNTER RESPONSE	-	-
10	Is the number of reported MBMS Packets received on the MTCH in step 9 greater than zero?	-	-	2	P
11	The SS transmits an <i>RRConnectionReconfiguration</i> message to release the unicast bearer due to congestion on the MBMS carrier(s)	<--	<i>RRConnectionReconfiguration</i>	-	-
12	The UE transmits an <i>RRConnectionReconfigurationComplete</i> message to confirm the release.	-->	<i>RRConnectionReconfigurationComplete</i>	-	-
13	The SS transmits a valid MAC PDU including 'MCH Scheduling Information MAC Control Element with LCID='00001', Stop MTCH='10000000000'	<--	MAC PDU (MCH Scheduling Information MAC Control Element: LCID='00001', Stop MTCH='10000000000')	-	-
14	The SS transmits 10 MBMS Packets on the MTCH.	<--	MBMS Packets.	-	-
15	The SS transmits an UE TEST LOOP MODE C MBMS PACKET COUNTER REQUEST message.	<--	UE TEST LOOP MODE C MBMS PACKET COUNTER REQUEST	-	-
16	UE responds with UE TEST LOOP MODE C MBMS PACKET COUNTER RESPONSE.	-->	UE TEST LOOP MODE C MBMS PACKET COUNTER RESPONSE	-	-
17	Check: Does the number of reported MBMS Packets received on the MTCH is greater than the number of MBMS Packets reported in step10?	-	-	2	P

Table 17.4.8.3.2-2: Parallel behaviour

St	Procedure	Message Sequence		TP	Verdict
		U - S	Message		
1	UE transmits <i>MBMSInterestIndication</i> message including the <i>mbms-Priority IE</i> set to True.	-->	<i>MBMSInterestIndication</i>	1	P

17.4.8.3.3 Specific message contents

Table 17.4.8.3.3-1: *SystemInformationBlockType2* for Cells 1 (Preamble and all steps, Table 17.4.8.3.2-1)

Derivation Path: 36.508 table 4.4.3.3-1, condition MBMS.
--

Table 17.4.8.3.3-2: *RRCConnectionReconfiguration* (step 11, Table 17.4.8.3.2-1)

Derivation Path: 36.508, Table 4.6.1-8, condition DRB-REL

Table 17.4.8.3.3-3: *MBMSInterestIndication* (step 1, Table 17.4.8.3.2-2)

Derivation Path: 36.508, Table 4.6.1-4C			
Information Element	Value/remark	Comment	Condition
criticalExtensions CHOICE {			
c1 CHOICE{			
interestIndication-r11 OF SEQUENCE {			
mbms-Priority-r11	true	ENUMERATED {true}	
}			
}			
}			

18 PWS

18.1 CMAS on LTE

18.1.1 PWS reception in RRC_IDLE state / Duplicate detection

18.1.1.1 Test Purpose (TP)

(1)

```
with { UE in RRC_IDLE state }
ensure that {
when { the UE receives a Paging message with cmas-Indication }
then { the UE is able to retrieve all the PWS message segments being broadcast, re assemble the message and alert the user }
}
```

(2)

```
With { UE in RRC_IDLE state and pc_PWS_UpperLayer set to 'TRUE' }
ensure that {
when { the UE receives a PWS message which is a duplicate of an already received message }
then { the UE discards the message and does not alert the user }
}
```

18.1.1.2 Conformance requirements

References: The conformance requirements covered in the present TC are specified in: TS 36.331, clauses 5.2.2.4, 5.2.2.19, 5.2.2.20, 5.3.2.3; TS 23.041 clause 9.1.3.4.2.

[TS 36.331, clause 5.2.2.4]

The UE shall:

...

- 1> if the UE is CMAS capable:
 - 2> upon entering a cell during RRC_IDLE, following successful handover or upon connection re-establishment:
 - 3> discard any previously buffered *warningMessageSegment*;
 - 3> clear, if any, stored values of *messageIdentifier* and *serialNumber* for *SystemInformationBlockType12* associated with the discarded *warningMessageSegment* ;
 - 2> when the UE acquires *SystemInformationBlockType1* following CMAS indication, upon entering a cell during RRC_IDLE, following successful handover and upon connection re-establishment:
 - 3> if *schedulingInfoList* indicates that *SystemInformationBlockType12* is present:
 - 4> acquire *SystemInformationBlockType12*;

NOTE 3: UEs shall start acquiring *SystemInformationBlockType12* as described above even when *systemInfoValueTag* in *SystemInformationBlockType1* has not changed.

- 1> if the UE is interested to receive MBMS services; and
 - 1> if *schedulingInfoList* indicates that *SystemInformationBlockType13* is present and the UE does not have stored a valid version of this system information block:
 - 2> acquire *SystemInformationBlockType13*;

The UE may apply the received SIBs immediately, i.e. the UE does not need to delay using a SIB until all SI messages have been received. The UE may delay applying the received SIBs until completing lower layer procedures associated with a received or a UE originated RRC message, e.g. an ongoing random access procedure.

NOTE 4: While attempting to acquire a particular SIB, if the UE detects from *schedulingInfoList* that it is no longer present, the UE should stop trying to acquire the particular SIB.

[TS 36.331, clause 5.2.2.19]

Upon receiving *SystemInformationBlockType12*, the UE shall:

- 1> if the *SystemInformationBlockType12* contains a complete warning message:
 - 2> forward the received warning message, *messageIdentifier*, *serialNumber* and *dataCodingScheme* to upper layers;
 - 2> continue reception of *SystemInformationBlockType12*;
- 1> else:
 - 2> if the received values of *messageIdentifier* and *serialNumber* are the same (each value is the same) as a pair for which a warning message is currently being assembled:
 - 3> store the received *warningMessageSegment*;
 - 3> if all segments of a warning message have been received:
 - 4> assemble the warning message from the received *warningMessageSegment*;
 - 4> forward the received warning message, *messageIdentifier*, *serialNumber* and *dataCodingScheme* to upper layers;
 - 4> stop assembling a warning message for this *messageIdentifier* and *serialNumber* and delete all stored information held for it;
 - 3> continue reception of *SystemInformationBlockType12*;

- 2> else if the received values of *messageIdentifier* and/or *serialNumber* are not the same as any of the pairs for which a warning message is currently being assembled:
- 3> start assembling a warning message for this *messageIdentifier* and *serialNumber* pair;
- 3> store the received *warningMessageSegment*;
- 3> continue reception of *SystemInformationBlockType12*;

The UE should discard *warningMessageSegment* and the associated values of *messageIdentifier* and *serialNumber* for *SystemInformationBlockType12* if the complete warning message has not been assembled within a period of 3 hours.

NOTE: The number of warning messages that a UE can re-assemble simultaneously is a function of UE implementation.

[TS 36.331, clause 5.2.2.20]

No UE requirements related to the contents of this *SystemInformationBlock* apply other than those specified elsewhere e.g. within procedures using the concerned system information, and/ or within the corresponding field descriptions.

[TS 36.331, clause 5.3.2.3]

Upon receiving the *Paging* message, the UE shall:

...

- 1> if the *cmas-Indication* is included and the UE is CMAS capable:
 - 2> re-acquire *SystemInformationBlockType1* immediately, i.e., without waiting until the next system information modification period boundary as specified in 5.2.1.5;
 - 2> if the *schedulingInfoList* indicates that *SystemInformationBlockType12* is present:
 - 3> acquire *SystemInformationBlockType12*;

[TS 23.041, clause 9.1.3.4.2]

...

The warning message to be broadcast is delivered via MMEs to multiple eNodeBs. The eNodeB(s) are responsible for scheduling the broadcast of the new message and the repetitions in each cell.

The overall warning message delivery procedure is presented in figure 9.1.3.4.2-1:

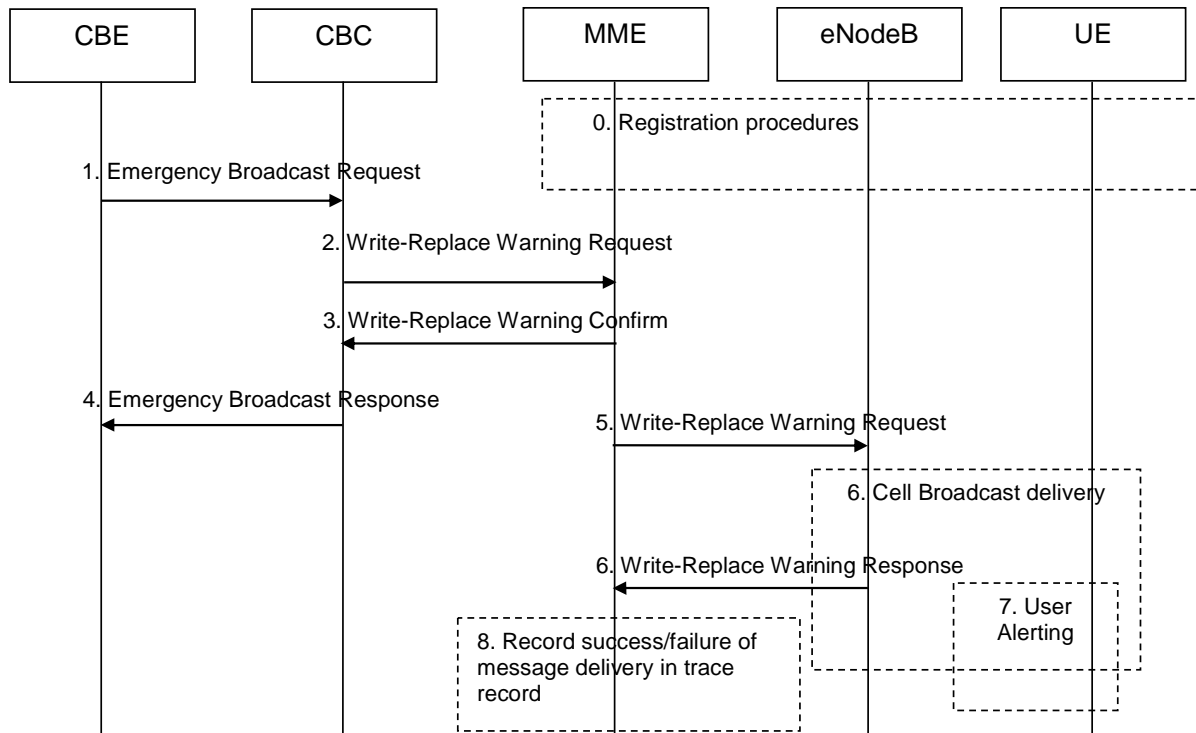

Figure 9.1.3.4.2-1: Warning message delivery procedure in E-UTRAN

0. Network registration and security (e.g. mutual authentication) procedures are performed. The UE stores a flag that indicates whether or not it has authenticated the network.

NOTE 1: This step is performed each time a UE is attached to a network (e.g. after each power on).

1. CBE (e.g. Information Source such as PSAP or Regulator) sends emergency information (e.g. "warning type", "warning message", "impacted area", "time period") to the CBC. The CBC shall authenticate this request.

2. Using the "impacted area" information, the CBC identifies which MMEs need to be contacted and determines the information to be placed into the Warning Area Information Element. The CBC sends a Write-Replace Warning Request message containing the warning message to be broadcast and the delivery attributes (Message identifier, Serial Number, Tracking Area ID list, Warning Area, OMC ID, CWM Indicator) to MMEs.

The warning messages use the coding scheme for CBS data specified in 3GPP TS 23.038 [3].

The Tracking Area ID list is only used by the MME. The MME uses it for selecting which eNodeBs to forward the Write-Replace Warning Request message to.

The Warning Area shall be a list of Cell IDs and/or a list of TAIs and/or one or more Emergency Area IDs. The Warning Area is only used by the eNodeB. The eNodeB is configured with the TAI(s) and Cell ID(s) it serves and the Emergency Area ID(s) that it belongs to. The eNodeB checks for any match of the contents of the Warning Area with these IDs to identify the cells where to distribute the warning message. The Warning Area is an optional information element. If the Warning Area is absent, it shall be interpreted as "all cells on the eNodeB". The number of cell IDs will be limited by the message size on SBC and S1-MME. An Emergency Area ID is unique within the PLMN.

The message may include an OMC ID. If present, it indicates the OMC to which the Trace record generated in step 8 is destined. Co-location of that OMC with the CBC is an operator option.

CBC shall set the Concurrent Warning Message (CWM) indicator in all Write-Replace Warning Request messages, if the PLMN supports concurrent warning message broadcasts.

NOTE 2: Due to requirements in earlier versions of the specification, it is possible that "digital signature" and "timestamp" information are transmitted within the "warning message".

3. The MME sends a Write-Replace Warning Confirm message that indicates to the CBC that the MME has started to distribute the warning message to eNodeBs. If this message is not received by the CBC within an appropriate time period, the CBC can attempt to deliver the warning message via another MME in the same pool area.

4. Upon reception of the Write-Replace Confirm messages from the MMEs, the CBC may confirm to the CBE that it has started to distribute the warning message.
 5. The MME forwards Write-Replace Warning Message Request to eNodeBs. The MME shall use the Tracking Area ID list to determine the eNodeBs in the delivery area. If the Tracking Area ID list is empty the message is forwarded to all eNodeBs that are connected to the MME.
 6. When S1-flex is used the eNodeB may receive same message from multiple MMEs. The eNodeB detects duplicate messages by checking the message identifier and serial number fields within the warning message. If any redundant messages are detected only the first one received will be broadcasted by the cells. The eNodeB shall use the Warning Area information to determine the cell(s) in which the message is to be broadcast. The eNodeBs return a Distribute Warning Message Response to the MME, even if it was a duplicate.
If there is a warning broadcast message already ongoing and the CWM Indicator is included in the Write-Replace Warning Message Request, the eNodeB does not stop existing broadcast message but start broadcasting the new message concurrently. Otherwise the eNodeB shall immediately replace the existing broadcast message with the newer one.
- NOTE 3: If concurrent warning messages are not supported, this requires the CBE/CBC to take care that 'lower' priority warnings are not sent while a higher priority warning is still being sent.
The eNodeB broadcasts the message frequently according to the attributes set by the CBC that originated the warning message distribution.
7. If the UE has been configured to receive warning messages , and the UE has authenticated the core network of the eNodeB it is camped on, then the UE proceeds as follows:
The UE can use "warning type" values, 'earthquake', 'tsunami' or 'earthquake and tsunami', immediately to alert the user. When "warning type" is 'test', the UE silently discards the primary notification, but the UE specially designed for testing purposes may proceed with the following procedures.
The UE activates reception of the broadcast messages containing the "warning message".
The UE indicates the contents of the "warning message" to the user.
 8. From the Write-Replace Warning Response messages returned by eNodeB's the MME determines the success or failure of the delivery and creates a trace record. Any OMC ID received in step 2 is written to the trace record to permit the O&M system to deliver them to the desired destination.

18.1.1.3 Test description

18.1.1.3.1 Pre-test conditions

System Simulator:

- Cell 1

UE:

None.

Preamble:

- The UE is in state Registered, Idle mode (state 2) according to [18].

18.1.1.3.2 Test procedure sequence

Table 18.1.1.3.2-1: Main behaviour

St	Procedure	Message Sequence		TP	Verdict
		U - S	Message		
1	The SS include a CMAS message with new <i>messageIdentifier</i> and <i>serialNumber</i> in <i>SystemInformationBlockType12</i> and transmit a <i>Paging</i> message including <i>cmas-Indication</i> on Cell 1 (NOTE1).	<--	<i>Paging</i>	-	-
2	Check: Does the UE indicate the contents of the "warning message" to the user (NOTE2)?	-	-	1	P
-	EXCEPTION: Steps 3a1 to 3a3 describe behaviour that depends on UE configuration; the "lower case letter" identifies a step sequence that take place if the <i>pc_PWS_UpperLayer</i> is set to TRUE.	-	-	-	-
3 a1	The SS waits for 10s.	-	-	-	-
3a2	The SS include a CMAS message with same <i>messageIdentifier</i> and <i>serialNumber</i> in <i>SystemInformationBlockType12</i> and transmit a <i>Paging</i> message including <i>cmas-Indication</i> on Cell 1 (NOTE1).	<--	<i>Paging</i>	-	-
3a3	Check: Does the UE indicate the contents of the "warning message" to the user (NOTE2)?	-	-	2	F

NOTE1: *SystemInformationBlockType12* contain 3 segments.
 NOTE2: The data indication and user alerting are the UE implementation issues.

18.1.1.3.3 Specific message contents

Table 18.1.1.3.3-1: *SystemInformationBlockType1* for Cell 1 (all steps, Table 18.1.1.3.2-1)

Derivation Path: 36.508 table 4.4.3.2-3			
Information Element	Value/remark	Comment	Condition
<i>SystemInformationBlockType1</i> ::= SEQUENCE {			
<i>schedulingInformation</i> ::= SEQUENCE (SIZE (1.. <i>maxSI-Message</i>)) OF SEQUENCE {	Combination in TS 36.508 section 4.4.3.1		
}			

Table 18.1.1.3.3-2: *Paging* (step 1 and step 3a2, Table 18.1.1.3.2-1)

Derivation Path: 36.508 Table 4.6.1-7			
Information Element	Value/remark	Comment	Condition
<i>Paging</i> ::= SEQUENCE {			
<i>pagingRecordList</i>	Not present		
<i>systemInfoModification</i>	Not present		
<i>etws-Indication</i>	Not Present		
<i>nonCriticalExtension</i> SEQUENCE {			
<i>lateNonCriticalExtension</i>	Not present		
<i>nonCriticalExtension</i> SEQUENCE {			
<i>cmas-Indication-r9</i>	true		
<i>nonCriticalExtension</i>	Not present		
}			
}			
}			

18.1.2 PWS reception in RRC_CONNECTED state / Duplicate detection

18.1.2.1 Test Purpose (TP)

(1)

```
with { UE in RRC_CONNECTED state }
  ensure that {
    when { the UE receives a Paging message with cmas-Indication }
    then { the UE is able to retrieve all the PWS message segments being broadcast, re assemble the
message and alert the user }
```

(2)

```
With { UE in RRC_CONNECTED state and pc_PWS_UpperLayer set to 'TRUE' }
  ensure that {
    when { the UE receives a PWS message which is a duplicate of an already received message }
    then { the UE discards the message and does not alert the user }
```

18.1.2.2 Conformance requirements

References: The conformance requirements covered in the present TC are specified in: TS 36.331, clauses 5.2.2.4, 5.2.2.19, 5.3.2.3; TS 23.041 clause 9.1.3.4.2.

[TS 36.331, clause 5.2.2.4]

The UE shall:

...

1> if the UE is CMAS capable:

2> upon entering a cell during RRC_IDLE, following successful handover or upon connection re-establishment:

3> discard any previously buffered *warningMessageSegment*;

3> clear, if any, stored values of *messageIdentifier* and *serialNumber* for *SystemInformationBlockType12* associated with the discarded *warningMessageSegment* ;

2> when the UE acquires *SystemInformationBlockType1* following CMAS indication, upon entering a cell during RRC_IDLE, following successful handover and upon connection re-establishment:

3> if *schedulingInfoList* indicates that *SystemInformationBlockType12* is present:

4> acquire *SystemInformationBlockType12*;

NOTE 3: UEs shall start acquiring *SystemInformationBlockType12* as described above even when *systemInfoValueTag* in *SystemInformationBlockType1* has not changed.

[TS 36.331, clause 5.2.2.19]

Upon receiving *SystemInformationBlockType12*, the UE shall:

1> if the *SystemInformationBlockType12* contains a complete warning message:

2> forward the received warning message, *messageIdentifier*, *serialNumber* and *dataCodingScheme* to upper layers;

2> continue reception of *SystemInformationBlockType12*;

1> else:

2> if the received values of *messageIdentifier* and *serialNumber* are the same (each value is the same) as a pair for which a warning message is currently being assembled:

3> store the received *warningMessageSegment*;

3> if all segments of a warning message have been received:

- 4> assemble the warning message from the received *warningMessageSegment*;
- 4> forward the received warning message, *messageIdentifier*, *serialNumber* and *dataCodingScheme* to upper layers;
- 4> stop assembling a warning message for this *messageIdentifier* and *serialNumber* and delete all stored information held for it;
- 3> continue reception of *SystemInformationBlockType12*;
- 2> else if the received values of *messageIdentifier* and/or *serialNumber* are not the same as any of the pairs for which a warning message is currently being assembled:
 - 3> start assembling a warning message for this *messageIdentifier* and *serialNumber* pair;
 - 3> store the received *warningMessageSegment*;
 - 3> continue reception of *SystemInformationBlockType12*;

The UE should discard *warningMessageSegment* and the associated values of *messageIdentifier* and *serialNumber* for *SystemInformationBlockType12* if the complete warning message has not been assembled within a period of 3 hours.

NOTE: The number of warning messages that a UE can re-assemble simultaneously is a function of UE implementation.

[TS 36.331, clause 5.3.2.3]

Upon receiving the *Paging* message, the UE shall:

...

- 1> if the *cmas-Indication* is included and the UE is CMAS capable:
 - 2> re-acquire *SystemInformationBlockType1* immediately, i.e., without waiting until the next system information modification period boundary as specified in 5.2.1.5;
 - 2> if the *schedulingInfoList* indicates that *SystemInformationBlockType12* is present:
 - 3> acquire *SystemInformationBlockType12*;

[TS 23.041, clause 9.1.3.4.2]

The warning message to be broadcast is delivered via MMEs to multiple eNodeBs. The eNodeB(s) are responsible for scheduling the broadcast of the new message and the repetitions in each cell.

The overall warning message delivery procedure is presented in figure 9.1.3.4.2-1:

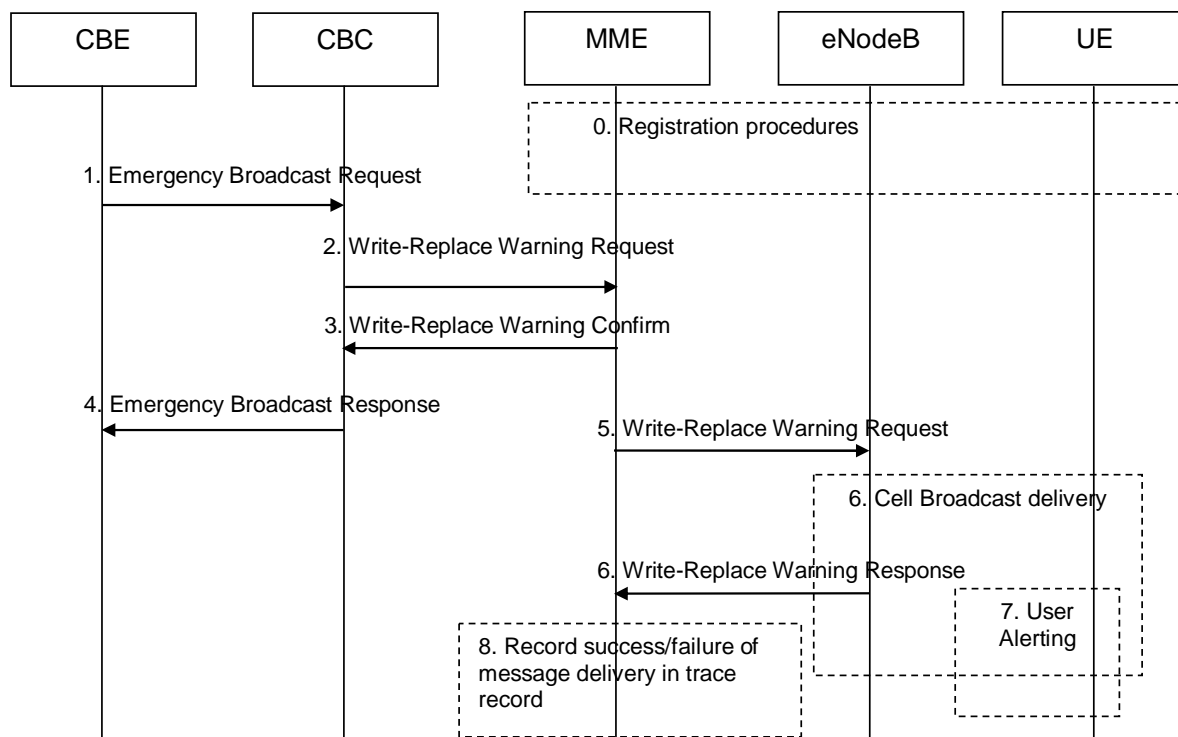

Figure 9.1.3.4.2-1: Warning message delivery procedure in E-UTRAN

0. Network registration and security (e.g. mutual authentication) procedures are performed. The UE stores a flag that indicates whether or not it has authenticated the network.

NOTE 1: This step is performed each time a UE is attached to a network (e.g. after each power on).

1. CBE (e.g. Information Source such as PSAP or Regulator) sends emergency information (e.g. "warning type", "warning message", "impacted area", "time period") to the CBC. The CBC shall authenticate this request.
2. Using the "impacted area" information, the CBC identifies which MMEs need to be contacted and determines the information to be placed into the Warning Area Information Element. The CBC sends a Write-Replace Warning Request message containing the warning message to be broadcast and the delivery attributes (Message identifier, Serial Number, Tracking Area ID list, Warning Area, OMC ID, CWM Indicator) to MMEs.

The warning messages use the coding scheme for CBS data specified in 3GPP TS 23.038 [3].

The Tracking Area ID list is only used by the MME. The MME uses it for selecting which eNodeBs to forward the Write-Replace Warning Request message to.

The Warning Area shall be a list of Cell IDs and/or a list of TAIs and/or one or more Emergency Area IDs. The Warning Area is only used by the eNodeB. The eNodeB is configured with the TAI(s) and Cell ID(s) it serves and the Emergency Area ID(s) that it belongs to. The eNodeB checks for any match of the contents of the Warning Area with these IDs to identify the cells where to distribute the warning message. The Warning Area is an optional information element. If the Warning Area is absent, it shall be interpreted as "all cells on the eNodeB". The number of cell IDs will be limited by the message size on SBC and S1-MME. An Emergency Area ID is unique within the PLMN.

The message may include an OMC ID. If present, it indicates the OMC to which the Trace record generated in step 8 is destined. Co-location of that OMC with the CBC is an operator option.

CBC shall set the Concurrent Warning Message (CWM) indicator in all Write-Replace Warning Request messages, if the PLMN supports concurrent warning message broadcasts.

NOTE 2: Due to requirements in earlier versions of the specification, it is possible that "digital signature" and "timestamp" information are transmitted within the "warning message".

3. The MME sends a Write-Replace Warning Confirm message that indicates to the CBC that the MME has started to distribute the warning message to eNodeBs.

If this message is not received by the CBC within an appropriate time period, the CBC can attempt to deliver the warning message via another MME in the same pool area.

4. Upon reception of the Write-Replace Confirm messages from the MMEs, the CBC may confirm to the CBE that it has started to distribute the warning message.
5. The MME forwards Write-Replace Warning Message Request to eNodeBs. The MME shall use the Tracking Area ID list to determine the eNodeBs in the delivery area. If the Tracking Area ID list is empty the message is forwarded to all eNodeBs that are connected to the MME.
6. When S1-flex is used the eNodeB may receive same message from multiple MMEs. The eNodeB detects duplicate messages by checking the message identifier and serial number fields within the warning message. If any redundant messages are detected only the first one received will be broadcasted by the cells. The eNodeB shall use the Warning Area information to determine the cell(s) in which the message is to be broadcast. The eNodeBs return a Distribute Warning Message Response to the MME, even if it was a duplicate.

If there is a warning broadcast message already ongoing and the CWM Indicator is included in the Write-Replace Warning Message Request, the eNodeB does not stop existing broadcast message but start broadcasting the new message concurrently. Otherwise the eNodeB shall immediately replace the existing broadcast message with the newer one.

NOTE 3: If concurrent warning messages are not supported, this requires the CBE/CBC to take care that 'lower' priority warnings are not sent while a higher priority warning is still being sent.

The eNodeB broadcasts the message frequently according to the attributes set by the CBC that originated the warning message distribution.

7. If the UE has been configured to receive warning messages and the UE has authenticated the core network of the eNodeB it is camped on, then the UE proceeds as follows:

The UE can use "warning type" values, 'earthquake', 'tsunami' or 'earthquake and tsunami', immediately to alert the user. When "warning type" is 'test', the UE silently discards the primary notification, but the UE specially designed for testing purposes may proceed with the following procedures.

The UE activates reception of the broadcast messages containing the "warning message".

The UE indicates the contents of the "warning message" to the user

UE shall consider a message duplicated if the combination of "message identifier" and "serial number" matches with those of the previous message that was received from the same PLMN. The UE shall ignore the message detected as a duplicated.

For ETWS, the UE shall perform duplicate message detection independently for primary and secondary notifications.

8. From the Write-Replace Warning Response messages returned by eNodeBs the MME determines the success or failure of the delivery and creates a trace record. Any OMC ID received in step 2 is written to the trace record to permit the O&M system to deliver them to the desired destination.

18.1.2.3 Test description

18.1.2.3.1 Pre-test conditions

System Simulator:

- Cell 1
- System information combination 17 as defined in TS 36.508[18] clause 4.4.3.1 is used in E-UTRA cell

UE:

None.

Preamble:

- The UE is in state Generic RB Established (state 3) according to [18].

18.1.2.3.2 Test procedure sequence

Table 18.1.2.3.2-1: Main behaviour

St	Procedure	Message Sequence		TP	Verdict
		U - S	Message		
1	The SS include a CMAS message with new <i>messageIdentifier</i> and <i>serialNumber</i> in <i>SystemInformationBlockType12</i> and transmit a <i>Paging</i> message including <i>cmas-Indication</i> on Cell 1 (NOTE1).	<--	<i>Paging</i>	-	-
2	Check: Does the UE indicate the contents of the "warning message" to the user (NOTE2)?	-	-	1	P
-	EXCEPTION: Steps 3a1 to 3a3 describe behaviour that depends on UE configuration; the "lower case letter" identifies a step sequence that take place if the <i>pc_PWS_UpperLayer</i> is set to TRUE.	-	-	-	-
3a1	The SS waits for 10s.	-	-	-	-
3a2	The SS include a CMAS message with same <i>messageIdentifier</i> and <i>serialNumber</i> in <i>SystemInformationBlockType12</i> and transmit a <i>Paging</i> message including <i>cmas-Indication</i> on Cell 1 (NOTE1).	<--	<i>Paging</i>	-	-
3a3	Check: Does the UE indicate the contents of the "warning message" to the user (NOTE2)?	-	-	2	F

NOTE1: *SystemInformationBlockType12* contains 3 segments.
 NOTE2: The data indication and user alerting are the UE implementation issues.

18.1.2.3.3 Specific message contents

Table 18.1.2.3.3-1: SystemInformationBlockType1 for Cell 1 (all steps, Table 18.1.2.3.2-1)

Derivation Path: 36.508 table 4.4.3.2-3			
Information Element	Value/remark	Comment	Condition
<i>SystemInformationBlockType1</i> ::= SEQUENCE {			
<i>schedulingInformation</i> ::= SEQUENCE (SIZE (1.. <i>maxSI-Message</i>)) OF SEQUENCE {}	Combination 17 in TS 36.508 section 4.4.3.1		
}			

Table 18.1.2.3.3-2: Paging (step 1 and step 3a2, Table 18.1.2.3.2-1)

Derivation Path: 36.508 Table 4.6.1-7			
Information Element	Value/remark	Comment	Condition
<i>Paging</i> ::= SEQUENCE {			
<i>pagingRecordList</i>	Not present		
<i>systemInfoModification</i>	Not present		
<i>etws-Indication</i>	Not present		
<i>nonCriticalExtension</i> SEQUENCE {			
<i>lateNonCriticalExtension</i>	Not present		
<i>nonCriticalExtension</i> SEQUENCE {			
<i>cmas-Indication-r9</i>	true		
<i>nonCriticalExtension</i>	Not present		
}			
}			

18.1.3 PWS reception in RRC_CONNECTED State/Power On

18.1.3.1 Test Purpose (TP)

(1)

with { UE being powered down }

```
ensure that {
when { UE is powered up while CMAS notification is present }
  then { UE successfully receives the PWS message and alerts the user accordingly }
}
```

(2)

```
with { UE in RRC_CONNECTED state }
ensure that {
when { the network transmits two consecutive different PWS messages and pages the UE, one paging
message per a defaultPagingCycle, to indicate the presence of each PWS message }
  then { the UE successfully receives each of the messages and alerts the user accordingly }
}
```

18.1.3.2 Conformance requirements

References: The conformance requirements covered in the present TC are specified in: TS 36.331, clauses 5.2.2.2, 5.2.2.4, 5.2.2.19, 5.2.1.3, 5.3.2.3; TS 23.041 clause 9.1.3.4.

[TS 36.331, clause 5.2.2.2]

The UE shall apply the system information acquisition procedure upon selecting (e.g. upon power on) and upon re-selecting a cell, after handover completion, after entering E-UTRA from another RAT, upon return from out of coverage, upon receiving a notification that the system information has changed, upon receiving an indication about the presence of an ETWS notification, upon receiving an indication about the presence of a CMAS notification, upon receiving a request from CDMA2000 upper layers and upon exceeding the maximum validity duration. Unless explicitly stated otherwise in the procedural specification, the system information acquisition procedure overwrites any stored system information, i.e. delta configuration is not applicable for system information and the UE discontinues using a field if it is absent in system information unless explicitly specified otherwise.

...

[TS 36.331, clause 5.2.2.4]

The UE shall:

...

1> if the UE is CMAS capable:

2> upon entering a cell during RRC_IDLE, following successful handover or upon connection re-establishment:

3> discard any previously buffered *warningMessageSegment*;

3> clear, if any, stored values of *messageIdentifier* and *serialNumber* for *SystemInformationBlockType12* associated with the discarded *warningMessageSegment* ;

2> when the UE acquires *SystemInformationBlockType1* following CMAS indication, upon entering a cell during RRC_IDLE, following successful handover and upon connection re-establishment:

3> if *schedulingInfoList* indicates that *SystemInformationBlockType12* is present:

4> acquire *SystemInformationBlockType12*;

NOTE 1: UEs shall start acquiring *SystemInformationBlockType12* as described above even when *systemInfoValueTag* in *SystemInformationBlockType1* has not changed.

The UE may apply the received SIBs immediately, i.e. the UE does not need to delay using a SIB until all SI messages have been received. The UE may delay applying the received SIBs until completing lower layer procedures associated with a received or a UE originated RRC message, e.g. an ongoing random access procedure.

NOTE 2: While attempting to acquire a particular SIB, if the UE detects from *schedulingInfoList* that it is no longer present, the UE should stop trying to acquire the particular SIB.

[TS 36.331, clause 5.2.2.19]

Upon receiving *SystemInformationBlockType12*, the UE shall:

- 1> if the *SystemInformationBlockType12* contains a complete warning message:
 - 2> forward the received warning message, *messageIdentifier*, *serialNumber* and *dataCodingScheme* to upper layers;
 - 2> continue reception of *SystemInformationBlockType12*;
- 1> else:
 - 2> if the received values of *messageIdentifier* and *serialNumber* are the same (each value is the same) as a pair for which a warning message is currently being assembled:
 - 3> store the received *warningMessageSegment*;
 - 3> if all segments of a warning message have been received:
 - 4> assemble the warning message from the received *warningMessageSegment*;
 - 4> forward the received warning message, *messageIdentifier*, *serialNumber* and *dataCodingScheme* to upper layers;
 - 4> stop assembling a warning message for this *messageIdentifier* and *serialNumber* and delete all stored information held for it;
 - 3> continue reception of *SystemInformationBlockType12*;
 - 2> else if the received values of *messageIdentifier* and/or *serialNumber* are not the same as any of the pairs for which a warning message is currently being assembled:
 - 3> start assembling a warning message for this *messageIdentifier* and *serialNumber* pair;
 - 3> store the received *warningMessageSegment*;
 - 3> continue reception of *SystemInformationBlockType12*;

The UE should discard *warningMessageSegment* and the associated values of *messageIdentifier* and *serialNumber* for *SystemInformationBlockType12* if the complete warning message has not been assembled within a period of 3 hours.

NOTE 3: The number of warning messages that a UE can re-assemble simultaneously is a function of UE implementation.

[TS 36.331, clause 5.2.1.3]

E-UTRAN may not update *systemInfoValueTag* upon change of some system information e.g. ETWS information, CMAS information, regularly changing parameters like CDMA2000 system time (see 6.3). Similarly, E-UTRAN may not include the *systemInfoModification* within the *Paging* message upon change of some system information.

The UE verifies that stored system information remains valid by either checking *systemInfoValueTag* in *SystemInformationBlockType1* after the modification period boundary, or attempting to find the *systemInfoModification* indication at least *modificationPeriodCoeff* times during the modification period in case no paging is received, in every modification period. If no paging message is received by the UE during a modification period, the UE may assume that no change of system information will occur at the next modification period boundary. If UE in RRC_CONNECTED, during a modification period, receives one paging message, it may deduce from the presence/ absence of *systemInfoModification* whether a change of system information other than ETWS and CMAS information will occur in the next modification period or not.

ETWS and/or CMAS capable UEs in RRC_CONNECTED shall attempt to read paging at least once every *defaultPagingCycle* to check whether ETWS and/or CMAS notification is present or not.

...

[TS 36.331, clause 5.3.2.3]

Upon receiving the *Paging* message, the UE shall:

...

- 1> if the *emas-Indication* is included and the UE is CMAS capable:
 - 2> re-acquire *SystemInformationBlockType1* immediately, i.e., without waiting until the next system information modification period boundary as specified in 5.2.1.5;
 - 2> if the *schedulingInfoList* indicates that *SystemInformationBlockType12* is present:
 - 3> acquire *SystemInformationBlockType12*;

[TS 23.041, clause 9.1.3.4]

...

The warning message to be broadcast is delivered via MMEs to multiple eNodeBs. The eNodeB(s) are responsible for scheduling the broadcast of the new message and the repetitions in each cell.

The overall warning message delivery procedure is presented in figure 9.1.3.4.2-1:

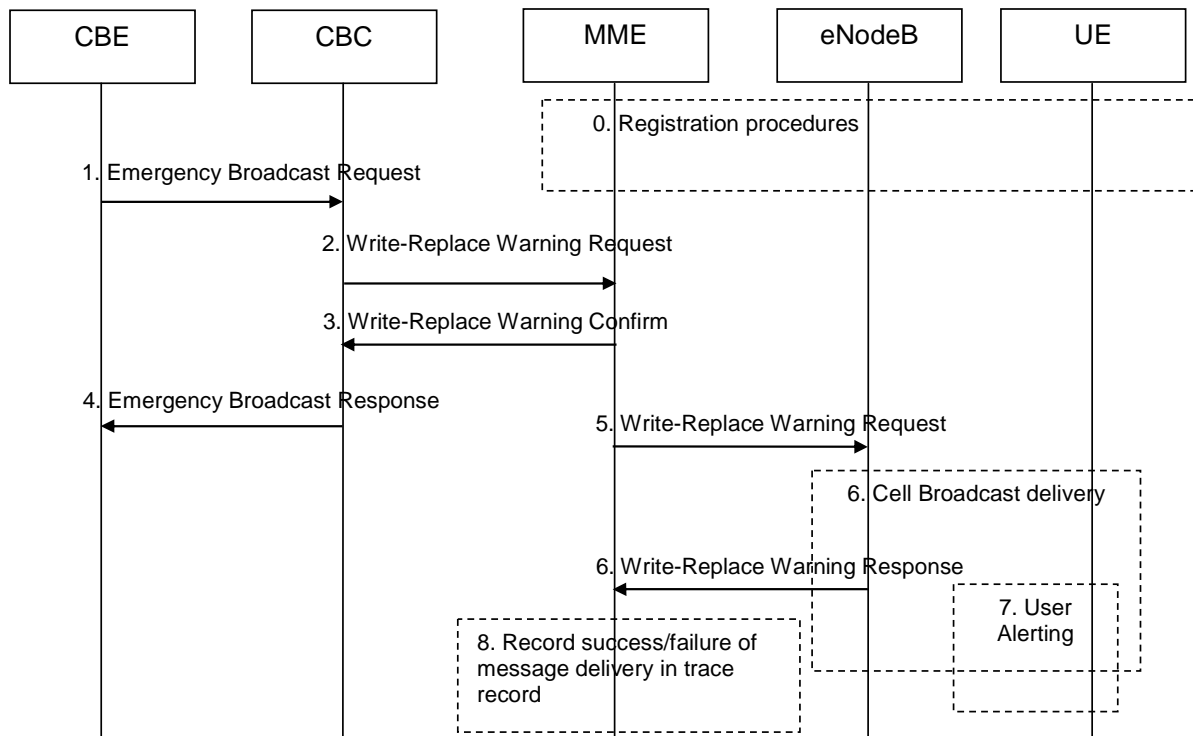

Figure 9.1.3.4.2-1: Warning message delivery procedure in E-UTRAN

- 0. Network registration and security (e.g. mutual authentication) procedures are performed. The UE stores a flag that indicates whether or not it has authenticated the network.

NOTE 1: This step is performed each time a UE is attached to a network (e.g. after each power on).

- 1. CBE (e.g. Information Source such as PSAP or Regulator) sends emergency information (e.g. "warning type", "warning message", "impacted area", "time period") to the CBC. The CBC shall authenticate this request.
- 2. Using the "impacted area" information, the CBC identifies which MMEs need to be contacted and determines the information to be place into the Warning Area Information Element. The CBC sends a Write-Replace Warning Request message containing the warning message to be broadcast and the delivery attributes (Message identifier, Serial Number, Tracking Area ID list, Warning Area, OMC ID, CWM Indicator) to MMEs.

The warning messages use the coding scheme for CBS data specified in 3GPP TS 23.038 [3].

The Tracking Area ID list is only used by the MME. The MME uses it for selecting which eNodeBs to forward the Write-Replace Warning Request message to.

The Warning Area shall be a list of Cell IDs and/or a list of TAIs and/or one or more Emergency Area IDs. The Warning Area is only used by the eNodeB. The eNodeB is configured with the TAI(s) and Cell ID(s) it serves and the Emergency Area ID(s) that it belongs to. The eNodeB checks for any match of the contents of the Warning Area with these IDs to identify the cells where to distribute the warning message. The Warning Area is an optional information element. If the Warning Area is absent, it shall be interpreted as "all cells on the eNodeB". The number of cell IDs will be limited by the message size on SBC and S1-MME. An Emergency Area ID is unique within the PLMN.

The message may include an OMC ID. If present, it indicates the OMC to which the Trace record generated in step 8 is destined. Co-location of that OMC with the CBC is an operator option.

CBC shall set the Concurrent Warning Message (CWM) indicator in all Write-Replace Warning Request messages, if the PLMN supports concurrent warning message broadcasts.

NOTE 2: Due to requirements in earlier versions of the specification, it is possible that "digital signature" and "timestamp" information are transmitted within the "warning message".

3. The MME sends a Write-Replace Warning Confirm message that indicates to the CBC that the MME has started to distribute the warning message to eNodeBs.

If this message is not received by the CBC within an appropriate time period, the CBC can attempt to deliver the warning message via another MME in the same pool area.

4. Upon reception of the Write-Replace Confirm messages from the MMEs, the CBC may confirm to the CBE that it has started to distribute the warning message.
5. The MME forwards Write-Replace Warning Message Request to eNodeBs. The MME shall use the Tracking Area ID list to determine the eNodeBs in the delivery area. If the Tracking Area ID list is empty the message is forwarded to all eNodeBs that are connected to the MME.
6. When S1-flex is used the eNodeB may receive same message from multiple MMEs. The eNodeB detects duplicate messages by checking the message identifier and serial number fields within the warning message. If any redundant messages are detected only the first one received will be broadcasted by the cells. The eNodeB shall use the Warning Area information to determine the cell(s) in which the message is to be broadcast. The eNodeBs return a Distribute Warning Message Response to the MME, even if it was a duplicate.

If there is a warning broadcast message already ongoing and the CWM Indicator is included in the Write-Replace Warning Message Request, the eNodeB does not stop existing broadcast message but start broadcasting the new message concurrently. Otherwise the eNodeB shall immediately replace the existing broadcast message with the newer one.

NOTE 3: If concurrent warning messages are not supported, this requires the CBE/CBC to take care that 'lower' priority warnings are not sent while a higher priority warning is still being sent.

The eNodeB broadcasts the message frequently according to the attributes set by the CBC that originated the warning message distribution.

7. If the UE has been configured to receive warning messages, and the UE has authenticated the core network of the eNodeB it is camped on, then the UE proceeds as follows:

The UE can use "warning type" values, 'earthquake', 'tsunami' or 'earthquake and tsunami', immediately to alert the user. When "warning type" is 'test', the UE silently discards the primary notification, but the UE specially designed for testing purposes may proceed with the following procedures.

The UE activates reception of the broadcast messages containing the "warning message".

The UE indicates the contents of the "warning message" to the user.

8. From the Write-Replace Warning Response messages returned by eNodeB's the MME determines the success or failure of the delivery and creates a trace record. Any OMC ID received in step 2 is written to the trace record to permit the O&M system to deliver them to the desired destination.

18.1.3.3 Test description

18.1.3.3.1 Pre-test conditions

System Simulator:

- Cell 1

UE:

None.

Preamble:

- The UE is SWITCHED OFF according to [18].

18.1.3.3.2 Test procedure sequence

Table 18.1.3.3.2-1: Main behaviour

St	Procedure	Message Sequence		TP	Verdict
		U – S	Message		
1	The SS include a CMAS message with new <i>messageIdentifier</i> and <i>serialNumber</i> in <i>SystemInformationBlockType12</i> (NOTE1).	-	-	-	-
2	Power/Switch On the UE.				
3-7	The authentication procedure is performed by executing steps 2 to 6 of the UE registration procedure in TS 36.508 sub clause 4.5.2.3				
-	EXCEPTION: the behaviour in table 18.1.3.3.2-2 runs in parallel with steps 8 to 17 below.	-	-	-	-
8-17	The attach procedure is performed by executing steps 7 to 16 of the UE registration procedure in TS 36.508 sub clause 4.5.2.3				
18	The SS include a CMAS message with different <i>serialNumber</i> in <i>SystemInformationBlockType12</i> and transmit a <i>Paging</i> message including <i>cmas-Indication</i> on Cell 1 (NOTE1).	<--	<i>Paging</i>	-	-
19	Check: Does the UE indicate the contents of the "warning message" to the user (NOTE2)?	-	-	2	P
20	The SS waits for 10s.	-	-	-	-
21	The SS include a CMAS message with different <i>serialNumber</i> in <i>SystemInformationBlockType12</i> and transmit a <i>Paging</i> message including <i>cmas-Indication</i> on Cell 1 (NOTE1).	<--	<i>Paging</i>	-	-
22	Check: Does the UE indicate the contents of the "warning message" to the user (NOTE2)?	-	-	2	P
NOTE1: <i>SystemInformationBlockType12</i> contains CMAS notification and the PWS message may be segmented in 3 segments.					
NOTE2: The data indication and user alerting are the UE implementation issues.					

Table 18.1.3.3.2-2: Parallel behaviour

St	Procedure	Message Sequence		TP	Verdict
		U – S	Message		
1	Check: Does the UE indicate the contents of the "warning message" to the user (NOTE2)?	-	-	1	P

18.1.3.3.3 Specific message contents

Table 18.1.3.3.3-1: SystemInformationBlockType1 for Cell 1 (all steps, Table 18.1.3.3.2-1)

Derivation Path: 36.508 table 4.4.3.2-3			
Information Element	Value/remark	Comment	Condition
SystemInformationBlockType1 ::= SEQUENCE {			
schedulingInformation ::= SEQUENCE (SIZE (1..maxSI-Message)) OF SEQUENCE {	Combination in TS 36.508 section 4.4.3.1		
}			

Table 18.1.3.3.3-2: SystemInformationBlockType12 (step 18 and 21, Table 18.1.3.3.2-1)

Derivation Path: 36.331 clause 6.3.1			
Information Element	Value/remark	Comment	Condition
SystemInformationBlockType12 ::= SEQUENCE {			
messageIdentifier-r9	'0001 0001 0001 0010'B	CMAS Message Identifier for CMAS Presidential Level Alerts (see TS 23.041)	
serialNumber-r9	Value different for each step		
warningMessageSegmentType	LastSegment		
warningMessageSegmentNumber	0		
warningMessageSegment	Octetstring different for each step	Provided as PIXITs	
dataCodingScheme	'0000 0001'B	English (See TS 23.038)	
lateNonCriticalExtension	Not present		
}			

Table 18.1.3.3.3-3: Paging (step 14 and step 17, Table 18.1.3.3.2-1)

Derivation Path: 36.508 Table 4.6.1-7			
Information Element	Value/remark	Comment	Condition
Paging ::= SEQUENCE {			
pagingRecordList	Not present		
systemInfoModification	Not present		
etws-Indication	Not present		
nonCriticalExtension ::= SEQUENCE {	Not present		
lateNonCriticalExtension	Not present		
nonCriticalExtension ::= SEQUENCE {			
cmas-Indication-r9	true		
nonCriticalExtension	Not present		
}			
}			
}			

Annex A (informative): Change history

Date	TSG #	TSG Doc.	CR	Rev	Subject/Comment	Version Old	Version New
2007-08		R5-072514			Initial version		0.0.1
2007-11					Template updated	0.0.1	0.0.2
2008-02					Addition 6 new RRC test cases	0.0.2	0.1.0
2008-04					Addition of new RRC and PDCP test cases agreed in RAN5#39. Alignment with latest core specifications.	0.1.0	0.2.0
2008-07					Addition of new MAC, RLC, RRC and EMM test cases and corrections agreed in RAN5#39bis. Alignment with latest core specifications.	0.2.0	0.3.0
2008-09					Addition of new MAC, RLC, PDCP and RRC test cases and corrections agreed in RAN5#40.	0.3.0	1.0.0
2008-10					Addition of new test cases agreed by email after RAN5#40 and at RAN5#40bis.	1.0.0	1.1.0
2008-11					Addition of new test cases and test case corrections agreed at RAN5#41.	1.1.0	2.0.0
2008-12	RAN#42	R5-080969			Approval of version 2.0.0 at RAN#42, then put to version 8.0.0.	2.0.0	8.0.0
2008-01					Editorial corrections	8.0.0	8.0.1
2009-03	RAN#43	R5-090102	0060	-	Correction to E-UTRA RLC test case 7.2.3.1	8.0.1	8.1.0
2009-03	RAN#43	R5-090103	0061	-	Correction to E-UTRA RLC test case 7.2.3.2	8.0.1	8.1.0
2009-03	RAN#43	R5-090124	0062	-	Batch 2 -Update to test case 7.2.2.8	8.0.1	8.1.0
2009-03	RAN#43	R5-090125	0063	-	Batch 1B -Update to test case 7.2.2.9	8.0.1	8.1.0
2009-03	RAN#43	R5-090128	0064	-	Batch 1A -Update to test case 8.1.1.1	8.0.1	8.1.0
2009-03	RAN#43	R5-090132	0065	-	Batch 1A - Update to test case 8.2.4.1	8.0.1	8.1.0
2009-03	RAN#43	R5-090133	0066	-	Batch 2 - Update to test case 8.2.4.2	8.0.1	8.1.0
2009-03	RAN#43	R5-090136	0067	-	Batch 2 - Update to test case 8.2.4.6	8.0.1	8.1.0
2009-03	RAN#43	R5-090137	0068	-	Batch 2 - Update to test case 8.2.4.7	8.0.1	8.1.0
2009-03	RAN#43	R5-090138	0069	-	Batch 2 - Update to test case 8.2.4.9	8.0.1	8.1.0
2009-03	RAN#43	R5-090144	0070	-	Batch 2 - Addition of new test case 8.4.1.8	8.0.1	8.1.0
2009-03	RAN#43	R5-090145	0071	-	Batch 2 - Correction to Idle mode test method	8.0.1	8.1.0
2009-03	RAN#43	R5-090146	0072	-	Batch 1A - Update to test case 8.5.4.1	8.0.1	8.1.0
2009-03	RAN#43	R5-090151	0073	-	Batch 2 - Addition of new test case 9.2.3.2.10	8.0.1	8.1.0
2009-03	RAN#43	R5-090153	0074	-	Batch 2 - Addition of new test case 9.2.3.2.15	8.0.1	8.1.0
2009-03	RAN#43	R5-090199	0075	-	Removal of EMM test cases 9.2.2.2.4, 9.2.2.2.6, 9.2.2.2.7 and 9.2.2.2.8.	8.0.1	8.1.0
2009-03	RAN#43	R5-090201	0076	-	Batch 1:Corrections to MAC test case 7.1.2.1	8.0.1	8.1.0
2009-03	RAN#43	R5-090203	0077	-	Batch 1:Corrections to MAC test case 7.1.2.4	8.0.1	8.1.0
2009-03	RAN#43	R5-090230	0078	-	Batch 1:Corrections to MAC test case 7.1.2.5	8.0.1	8.1.0
2009-03	RAN#43	R5-090235	0079	-	Batch 1:Corrections to MAC test case 7.1.3.6	8.0.1	8.1.0
2009-03	RAN#43	R5-090236	0080	-	Batch 1:Corrections to MAC test case 7.1.4.11	8.0.1	8.1.0
2009-03	RAN#43	R5-090347	0081	-	Batch 2 - Update to MAC test case 7.1.4.3	8.0.1	8.1.0
2009-03	RAN#43	R5-090453	0082	-	Batch 1A - Update of E-UTRA RLC (AM) test case 7.2.3.5	8.0.1	8.1.0
2009-03	RAN#43	R5-090455	0083	-	Batch 2 - Update of E-UTRA RLC (AM) test case 7.2.3.16	8.0.1	8.1.0
2009-03	RAN#43	R5-090498	0084	-	Batch 1B: Correction to E-UTRA RLC test case 7.2.2.7	8.0.1	8.1.0
2009-03	RAN#43	R5-090511	0085	-	Addition of a new LTE test case" 7.3.3.2 Correct functionality of EPS UP encryption algorithms (SNOW 3G)"	8.0.1	8.1.0
2009-03	RAN#43	R5-090512	0086	-	Addition of a new LTE test case "7.3.3.1 Correct functionality of EPS AS encryption algorithms (SNOW 3G)"	8.0.1	8.1.0
2009-03	RAN#43	R5-090513	0087	-	Addition of a new LTE test case "7.3.3.3 Correct functionality of EPS AS encryption algorithms (AES)"	8.0.1	8.1.0
2009-03	RAN#43	R5-090514	0088	-	Addition of a new LTE test case "7.3.3.4 Correct functionality of EPS UP encryption algorithms (AES)"	8.0.1	8.1.0
2009-03	RAN#43	R5-090552	0089	-	Batch 1:Corrections to MAC test case 7.1.2.7	8.0.1	8.1.0
2009-03	RAN#43	R5-090553	0090	-	Batch 1:Corrections to MAC test case 7.1.2.8	8.0.1	8.1.0
2009-03	RAN#43	R5-090554	0091	-	.Batch 1:Corrections to MAC test case 7.1.3.4	8.0.1	8.1.0
2009-03	RAN#43	R5-090555	0092	-	Batch 1:Corrections to MAC test case 7.1.3.5	8.0.1	8.1.0
2009-03	RAN#43	R5-090556	0093	-	Batch 1:Corrections to MAC test case 7.1.4.15	8.0.1	8.1.0
2009-03	RAN#43	R5-090557	0094	-	Batch 1:Corrections to MAC test case 7.1.4.16	8.0.1	8.1.0
2009-03	RAN#43	R5-090570	0095	-	Update of 36.523-1 Reference list	8.0.1	8.1.0

Date	TSG #	TSG Doc.	CR	Rev	Subject/Comment	Version Old	Version New
2009-03	RAN#43	R5-090605	0096	-	Batch 2: Update of LTE TC 8.1.2.3 RRC - RRC Connection Establishment in RRC Idle state: return to idle state after T300 timeout	8.0.1	8.1.0
2009-03	RAN#43	R5-090607	0097	-	Batch 2: Addition of EMM TC 9.2.1.2.4 for Successful combined attach procedure, EPS service only / CS domain not available.	8.0.1	8.1.0
2009-03	RAN#43	R5-090611	0098	-	Batch 1:Corrections to EMM test case 9.1.3.1	8.0.1	8.1.0
2009-03	RAN#43	R5-090631	0099	-	Batch 1B: Correction to E-UTRA RLC test case 7.2.2.3	8.0.1	8.1.0
2009-03	RAN#43	R5-090645	0100	-	Batch 1B: Update of E-UTRAN test case 6.1.1.1	8.0.1	8.1.0
2009-03	RAN#43	R5-090649	0101	-	Batch-1B: Introduction of a new EMM test case, 9.2.3.1.4 Normal tracking area update / list of equivalent PLMNs in the TRACKING AREA UPDATE ACCEPT message	8.0.1	8.1.0
2009-03	RAN#43	R5-090651	0102	-	Batch 1:Corrections to MAC test case 7.1.2.2	8.0.1	8.1.0
2009-03	RAN#43	R5-090653	0103	-	Batch 1: Addition of new MAC test case 7.1.3.9 : MAC reset	8.0.1	8.1.0
2009-03	RAN#43	R5-090654	0104	-	Batch 1: Addition of new MAC test case 7.1.4.12 : MAC reset	8.0.1	8.1.0
2009-03	RAN#43	R5-090655	0105	-	Batch 1A - Update of E-UTRA MAC test case: 7.1.3.3	8.0.1	8.1.0
2009-03	RAN#43	R5-090656	0106	-	Batch 2 - Update of E-UTRA MAC test case: 7.1.2.9	8.0.1	8.1.0
2009-03	RAN#43	R5-090665	0107	-	Batch 1B - New E-UTRA PDCP test case - 7.3.1.2 Maintenance of PDCP sequence numbers (user plane, RLC UM)	8.0.1	8.1.0
2009-03	RAN#43	R5-090666	0108	-	Batch 1B - Correction to E-UTRA PDCP test case 7.3.1.1	8.0.1	8.1.0
2009-03	RAN#43	R5-090667	0109	-	Batch 1B - New E-UTRA PDCP test case - 7.3.1.3 Maintenance of PDCP sequence numbers (user plane, RLC UM, long PDCP SN (12 bits))	8.0.1	8.1.0
2009-03	RAN#43	R5-090669	0110	-	Batch 1B -Update to test case 7.2.2.4	8.0.1	8.1.0
2009-03	RAN#43	R5-090670	0111	-	Batch 1A -Update to test case 7.2.3.3	8.0.1	8.1.0
2009-03	RAN#43	R5-090671	0112	-	Batch 1A -Update to test case 7.2.3.4	8.0.1	8.1.0
2009-03	RAN#43	R5-090672	0113	-	Removal of TC 7.3.5.1	8.0.1	8.1.0
2009-03	RAN#43	R5-090674	0114	-	Batch 1A - Update of E-UTRA RLC (AM) test case 7.2.3.17	8.0.1	8.1.0
2009-03	RAN#43	R5-090675	0115	-	Batch 1A - Update of E-UTRA RLC (AM) test case 7.2.3.15	8.0.1	8.1.0
2009-03	RAN#43	R5-090676	0116	-	Batch 1B - Update of test case 8.2.2.1	8.0.1	8.1.0
2009-03	RAN#43	R5-090677	0117	-	Update of RRC batch 1B test case 8.2.2.2 RRC Connection Reconfiguration / SRB/DRB Reconfiguration: Success	8.0.1	8.1.0
2009-03	RAN#43	R5-090678	0118	-	Batch-1: Update to RRC part 3 test case 8.3.3.1	8.0.1	8.1.0
2009-03	RAN#43	R5-090679	0119	-	Batch 1A - TC 9.1.2.1 Authentication accepted -Update of conformance requirements	8.0.1	8.1.0
2009-03	RAN#43	R5-090680	0120	-	Batch 1A - TC 9.3.2.1 Paging procedure revisited	8.0.1	8.1.0
2009-03	RAN#43	R5-090685	0121	-	Batch 1A -Update to test case 6.1.2.5	8.0.1	8.1.0
2009-03	RAN#43	R5-090688	0122	-	Update of TC 7.3.6.1 PDCP Discard	8.0.1	8.1.0
2009-03	RAN#43	R5-090689	0123	-	Addition of new TC 7.3.5.4	8.0.1	8.1.0
2009-03	RAN#43	R5-090690	0124	-	Batch 2 - Update of LTE TC 8.5.1.3 RRC - RRC Connection Re-establishment: Failure: T311 Expiry	8.0.1	8.1.0
2009-03	RAN#43	R5-090691	0125	-	Batch 2 -Update to test case 8.1.2.5	8.0.1	8.1.0
2009-03	RAN#43	R5-090692	0126	-	Batch 1A -Update to test case 8.1.2.7	8.0.1	8.1.0
2009-03	RAN#43	R5-090693	0127	-	Batch 1A -Update to test case 8.1.3.5	8.0.1	8.1.0
2009-03	RAN#43	R5-090694	0128	-	Batch 2 - Update to test case 8.2.4.3	8.0.1	8.1.0
2009-03	RAN#43	R5-090695	0129	-	Batch 1B - Update to test case 8.2.4.5	8.0.1	8.1.0
2009-03	RAN#43	R5-090707	0130	-	Batch 1A - Update of test case 8.2.4.1	8.0.1	8.1.0
2009-03	RAN#43	R5-090709	0131	-	Batch 2: Update of RRC part1 TC 8.1.3.6 RRC Connection Release: redirection from E-UTRAN to UTRAN	8.0.1	8.1.0
2009-03	RAN#43	R5-090710	0132	-	Batch 2: Update of RRC part3 TC 8.3.1.7 Measurement configuration control and reporting / intra E-UTRAN measurements: blacklisting	8.0.1	8.1.0
2009-03	RAN#43	R5-090711	0133	-	Corrections to LTE idle mode test cases	8.0.1	8.1.0
2009-03	RAN#43	R5-090712	0134	-	Batch 1B: Update of test case 6.1.2.6	8.0.1	8.1.0
2009-03	RAN#43	R5-090713	0135	-	Batch 2: Update of LTE TC 8.1.2.2 RRC, Reject	8.0.1	8.1.0

Date	TSG #	TSG Doc.	CR	Rev	Subject/Comment	Version Old	Version New
					with wait time		
2009-03	RAN#43	R5-090714	0136	-	Update to test case 8.1.3.1	8.0.1	8.1.0
2009-03	RAN#43	R5-090715	0137	-	Batch 1B: update of E-UTRA PDCP test case 7.3.6.1	8.0.1	8.1.0
2009-03	RAN#43	R5-090716	0138	-	Batch 1B: update of E-UTRA PDCP test case 7.3.6.1	8.0.1	8.1.0
2009-03	RAN#43	R5-090717	0139	-	Batch 2 - Update to test case 8.3.1.8	8.0.1	8.1.0
2009-03	RAN#43	R5-090720	0140	-	Batch-2: Update to RRC part 3 test case 8.3.1.3	8.0.1	8.1.0
2009-03	RAN#43	R5-090721	0141	-	Batch-2: Update to RRC part 3 test case 8.3.1.5	8.0.1	8.1.0
2009-03	RAN#43	R5-090722	0142	-	Batch 2: Addition of new EMM TC 9.2.1.2.3: Successful combined attach procedure, EPS service only / MSC temporarily not reachable	8.0.1	8.1.0
2009-03	RAN#43	R5-090730	0143	-	Batch 1:Corrections to MAC test case 7.1.2.3	8.0.1	8.1.0
2009-03	RAN#43	R5-090732	0144	-	Batch 2 - Addition of new test case 9.2.1.2.6	8.0.1	8.1.0
2009-03	RAN#43	R5-090733	0145	-	Batch 2 - Addition of new test case 9.2.3.2.6	8.0.1	8.1.0
2009-03	RAN#43	R5-090734	0146	-	Batch 1:Corrections to MAC test case 7.1.4.2	8.0.1	8.1.0
2009-03	RAN#43	R5-090735	0147	-	Batch 1:Corrections to MAC test case 7.1.3.2	8.0.1	8.1.0
2009-03	RAN#43	R5-090736	0148	-	Batch 2: Update of RRC part1 TC 8.1.3.4 RRC Connection Release: redirection to another E-UTRAN frequency	8.0.1	8.1.0
2009-03	RAN#43	R5-090740	0149	4	Batch 1A - Update of E-UTRA RLC (AM) test case 7.2.3.18	8.0.1	8.1.0
2009-05	RAN#44	R5-092052	0150	-	GCF Priority 1 - Update of 9.1.2.1 test procedure sequence and editorials	8.1.0	8.2.0
2009-05	RAN#44	R5-092053	0151	-	GCF Priority 2 - Update of TC 9.1.2.3 Authentication not accepted by the network, GUTI used, authentication reject and re-authentication	8.1.0	8.2.0
2009-05	RAN#44	R5-092054	0152	-	GCF Priority 2 - Update TC 9.1.2.4 Authentication not accepted by the UE MAC code failure	8.1.0	8.2.0
2009-05	RAN#44	R5-092055	0153	-	GCF Priority 2 - New TC 9.1.2.5 Authentication not accepted by the UE, SQN failure	8.1.0	8.2.0
2009-05	RAN#44	R5-092061	0154	-	GCF Priority 1 - Update of RRC test case 9.3.1.1	8.1.0	8.2.0
2009-05	RAN#44	R5-092076	0155	-	GCF Priority 2: First lu mode to S1 mode intersystem change after attach: go to E-UTRAN RRC idle: RAU to UTRAN (9.2.3.3.1)	8.1.0	8.2.0
2009-05	RAN#44	R5-092077	0156	-	Batch 2: Addition of 8.1.3.9 RRC Redirection from E-UTRAN to HRPD	8.1.0	8.2.0
2009-05	RAN#44	R5-092078	0157	-	Batch 2: Addition of 8.1.3.10 RRC Redirection from E-UTRAN to CDMA2000-1XRTT	8.1.0	8.2.0
2009-05	RAN#44	R5-092107	0158	-	GCF Priority 1 - Update of E-UTRA MAC test case 7.1.3.1	8.1.0	8.2.0
2009-05	RAN#44	R5-092108	0159	-	GCF Priority 1 - Update of E-UTRA MAC test case 7.1.4.1	8.1.0	8.2.0
2009-05	RAN#44	R5-092109	0160	-	GCF Priority 1 - Update of E-UTRA MAC test case 7.1.4.4	8.1.0	8.2.0
2009-05	RAN#44	R5-092110	0161	-	GCF Priority 1 - Update of E-UTRA MAC test case 7.1.4.5	8.1.0	8.2.0
2009-05	RAN#44	R5-092112	0162	-	GCF Priority 1 - Update of E-UTRA MAC test case 7.1.4.8	8.1.0	8.2.0
2009-05	RAN#44	R5-092113	0163	-	GCF Priority 1 - Update of E-UTRA MAC test case 7.1.4.10	8.1.0	8.2.0
2009-05	RAN#44	R5-092114	0164	-	GCF Priority 1 - Update of E-UTRA MAC test case 7.1.4.13	8.1.0	8.2.0
2009-05	RAN#44	R5-092115	0165	-	GCF Priority 1 - Proposal to remove E-UTRA RLC test case 7.2.3.19	8.1.0	8.2.0
2009-05	RAN#44	R5-092181	0166	-	GCF Priority 2 - Update of test case 8.5.1.5	8.1.0	8.2.0
2009-05	RAN#44	R5-092185	0167	-	GCF Priority 1 - Update of test case 8.2.3.1	8.1.0	8.2.0
2009-05	RAN#44	R5-092190	0168	-	GCF Priority 1 - Update of E-UTRA RLC (AM) test case 7.2.3.1	8.1.0	8.2.0
2009-05	RAN#44	R5-092191	0169	-	GCF Priority 1 - Update of E-UTRA RLC (AM) test case 7.2.3.2	8.1.0	8.2.0
2009-05	RAN#44	R5-092192	0170	-	GCF Priority 1 - Update of E-UTRA RLC (AM) test case 7.2.3.18	8.1.0	8.2.0
2009-05	RAN#44	R5-092200	0171	-	GCF Priority 1 - Update of E-UTRA RLC (AM) test case 7.2.3.18	8.1.0	8.2.0
2009-05	RAN#44	R5-092213	0172	-	Addition of new RRC test case 8.3.2.9	8.1.0	8.2.0
2009-05	RAN#44	R5-092228	0173	-	GCF Priority 2 - Update to test case 6.1.2.15	8.1.0	8.2.0
2009-05	RAN#44	R5-092229	0174	-	GCF Priority 1 - Update to test case 6.1.2.4	8.1.0	8.2.0

Date	TSG #	TSG Doc.	CR	Rev	Subject/Comment	Version Old	Version New
2009-05	RAN#44	R5-092230	0175	-	GCF Priority 2 - Update to test case 6.1.2.5	8.1.0	8.2.0
2009-05	RAN#44	R5-092234	0176	-	GCF Priority 1 - Update to test case 8.1.1.1	8.1.0	8.2.0
2009-05	RAN#44	R5-092242	0177	-	GCF Priority 2 - Update to test case 8.1.3.5	8.1.0	8.2.0
2009-05	RAN#44	R5-092245	0178	-	GCF Priority-2: A new EMM test case, 9.2.3.1.8 UE receives an indication that the RRC connection was released with cause 'load balancing TAU required'	8.1.0	8.2.0
2009-05	RAN#44	R5-092247	0179	-	Introduction of new EMM test cases, 9.2.3.1.10 and 9.2.3.1.11 Normal tracking area update / Rejected	8.1.0	8.2.0
2009-05	RAN#44	R5-092248	0180	-	Introduction of 9.2.3.1.12 ' Normal tracking area update / rejected / EPS service not allowed'	8.1.0	8.2.0
2009-05	RAN#44	R5-092249	0181	-	Introduction of 9.2.3.1.13 'Normal tracking area update / rejected / UE identity cannot be derived by the network'	8.1.0	8.2.0
2009-05	RAN#44	R5-092250	0182	-	GCF Priority 2 - Addition of a new test case 6.1.2.11 Inter-frequency cell reselection	8.1.0	8.2.0
2009-05	RAN#44	R5-092251	0183	-	Introduction of 9.2.3.1.14 ' Normal tracking area update / rejected / UE implicitly detached'	8.1.0	8.2.0
2009-05	RAN#44	R5-092252	0184	-	Introduction of 9.2.3.1.15 ' Normal tracking area update / rejected / PLMN not allowed'	8.1.0	8.2.0
2009-05	RAN#44	R5-092253	0185	-	Introduction of 9.2.3.1.16 ' Normal tracking area update / rejected / Tracking area not allowed'	8.1.0	8.2.0
2009-05	RAN#44	R5-092258	0186	-	GCF Priority 2 - Update of RRC part1 TC 8.1.3.4 RRC Connection Release: redirection to another E-UTRAN frequency	8.1.0	8.2.0
2009-05	RAN#44	R5-092260	0187	-	GCF Priority 2 - Update of RRC part1 TC 8.1.3.6 RRC Connection Release: redirection from E-UTRAN to UTRAN	8.1.0	8.2.0
2009-05	RAN#44	R5-092262	0188	-	GCF Priority 2 - Correction to idle mode test cases 6.1.2.3 and 6.1.2.6	8.1.0	8.2.0
2009-05	RAN#44	R5-092272	0189	-	LTE-SIG:TDD related updates in RRC sections	8.1.0	8.2.0
2009-05	RAN#44	R5-092276	0190	-	"GCF priority 1 - Update of the LTE test cases 7.3.3.1 Correct functionality of EPS AS encryption algorithms (SNOW 3G)ö"	8.1.0	8.2.0
2009-05	RAN#44	R5-092278	0191	-	GCF priority 1 - Update of test cases 7.3.3.2 Correct functionality of EPS UP encryption algorithms (SNOW 3G)ö"	8.1.0	8.2.0
2009-05	RAN#44	R5-092280	0192	-	GCF Priority 2 - Update to test case 8.2.4.2	8.1.0	8.2.0
2009-05	RAN#44	R5-092281	0193	-	GCF Priority 2 - Update to test case 8.2.4.3	8.1.0	8.2.0
2009-05	RAN#44	R5-092283	0194	-	GCF Priority 2 - Update to test case 8.2.4.5	8.1.0	8.2.0
2009-05	RAN#44	R5-092284	0195	-	GCF Priority 2 - Update to test case 8.2.4.6	8.1.0	8.2.0
2009-05	RAN#44	R5-092285	0196	-	GCF Priority 2 - Update to test case 8.2.4.7	8.1.0	8.2.0
2009-05	RAN#44	R5-092288	0197	-	GCF Priority 2 - Update to test case 8.3.1.8	8.1.0	8.2.0
2009-05	RAN#44	R5-092295	0198	-	Addition of new test case 9.2.1.2.8	8.1.0	8.2.0
2009-05	RAN#44	R5-092296	0199	-	Addition of new test case 9.2.1.2.9	8.1.0	8.2.0
2009-05	RAN#44	R5-092297	0200	-	Addition of new test case 9.2.1.2.10	8.1.0	8.2.0
2009-05	RAN#44	R5-092299	0201	-	Addition of new test case 9.2.3.2.12	8.1.0	8.2.0
2009-05	RAN#44	R5-092300	0202	-	Addition of new test case 9.3.1.4	8.1.0	8.2.0
2009-05	RAN#44	R5-092301	0203	-	Addition of new test case to test case 10.X.X	8.1.0	8.2.0
2009-05	RAN#44	R5-092327	0204	-	GCF Priority 1: Update E-UTRA PDCP TC 7.3.4.1	8.1.0	8.2.0
2009-05	RAN#44	R5-092328	0205	-	GCF Priority 1: Update E-UTRA PDCP TC 7.3.4.2	8.1.0	8.2.0
2009-05	RAN#44	R5-092329	0206	-	GCF Priority 2: Update E-UTRA PDCP TC 7.3.5.2	8.1.0	8.2.0
2009-05	RAN#44	R5-092330	0207	-	GCF Priority 2: Update E-UTRA PDCP TC 7.3.5.3	8.1.0	8.2.0
2009-05	RAN#44	R5-092331	0208	-	GCF Priority 2: Update E-UTRA PDCP TC 7.3.5.5	8.1.0	8.2.0
2009-05	RAN#44	R5-092367	0209	-	GCF Priority 1 - Update of E-UTRA MAC test case 7.1.4.6	8.1.0	8.2.0
2009-05	RAN#44	R5-092396	0210	-	GCF Priority 2 - Addition of new test case 6.2.2.3	8.1.0	8.2.0
2009-05	RAN#44	R5-092397	0211	-	GCF Priority 2 - Addition of new test case 6.2.3.7	8.1.0	8.2.0
2009-05	RAN#44	R5-092398	0212	-	GCF Priority 2 - Addition of new test case 6.2.3.8	8.1.0	8.2.0
2009-05	RAN#44	R5-092406	0213	-	"GCF Priority 2 - Addition of new LTE test case 7.2.2.11 UM RLC / RLC re-establishment procedure"	8.1.0	8.2.0
2009-05	RAN#44	R5-092417	0214	-	GCF Priority 2:Corrections to EMM test case	8.1.0	8.2.0

Date	TSG #	TSG Doc.	CR	Rev	Subject/Comment	Version Old	Version New
					9.1.3.2		
2009-05	RAN#44	R5-092418	0215	-	GCF Priority 1:Corrections to MAC test case 7.1.3.4	8.1.0	8.2.0
2009-05	RAN#44	R5-092419	0216	-	GCF Priority 1:Corrections to MAC test case 7.1.3.5	8.1.0	8.2.0
2009-05	RAN#44	R5-092420	0217	-	GCF Priority 1:Corrections to MAC test case 7.1.4.1	8.1.0	8.2.0
2009-05	RAN#44	R5-092421	0218	-	GCF Priority 2: Attach / Abnormal case / Access barred because of access class barring or NAS signalling connection establishment rejected by the network	8.1.0	8.2.0
2009-05	RAN#44	R5-092422	0219	-	GCF Priority 2: Corrections to EMM test case 9.4.1	8.1.0	8.2.0
2009-05	RAN#44	R5-092423	0220	-	GCF Priority 2:Corrections to EMM test case 9.4.3	8.1.0	8.2.0
2009-05	RAN#44	R5-092430	0221	-	GCF Priority 1:Corrections to MAC test case 7.1.1.2	8.1.0	8.2.0
2009-05	RAN#44	R5-092451	0222	-	Update of RSRP / RSRQ measurement result checking to the RRC part 3 test cases	8.1.0	8.2.0
2009-05	RAN#44	R5-092471	0223	-	GCF Priority 2-Correction of the EMM test case 9.2.3.1.4	8.1.0	8.2.0
2009-05	RAN#44	R5-092480	0224	-	GCF Priority 1:Corrections to MAC test case 7.1.2.1	8.1.0	8.2.0
2009-05	RAN#44	R5-092481	0225	-	GCF Priority 1:Corrections to MAC test case 7.1.2.2	8.1.0	8.2.0
2009-05	RAN#44	R5-092484	0226	-	GCF Priority 1:Corrections to MAC test case 7.1.2.5	8.1.0	8.2.0
2009-05	RAN#44	R5-092485	0227	-	GCF Priority 1:Corrections to MAC test case 7.1.2.7	8.1.0	8.2.0
2009-05	RAN#44	R5-092486	0228	-	GCF Priority 1:Corrections to MAC test case 7.1.2.8	8.1.0	8.2.0
2009-05	RAN#44	R5-092500	0229	-	GCF priority 2: Update of 10.2.1 for Dedicated EPS bearer context activation / Success	8.1.0	8.2.0
2009-05	RAN#44	R5-092501	0230	-	GCF priority 2: Addition of TC 10.4.1 for EPS bearer context deactivation / Success	8.1.0	8.2.0
2009-05	RAN#44	R5-092502	0231	-	GCF priority 2: Addition of TC 10.5.1 for UE requested PDN connectivity accepted by the network	8.1.0	8.2.0
2009-05	RAN#44	R5-092504	0232	-	GCF priority TBC: Addition of TC 10.5.2 for UE requested PDN connectivity accepted by the network / no PDN address allocated	8.1.0	8.2.0
2009-05	RAN#44	R5-092505	0233	-	GCF priority 3: Addition of TC 10.5.3 for UE requested PDN connectivity not accepted	8.1.0	8.2.0
2009-05	RAN#44	R5-092506	0234	-	GCF priority 2: Addition of ESM TC 10.6.1 for UE requested PDN disconnect procedure accepted by the network	8.1.0	8.2.0
2009-05	RAN#44	R5-092507	0235	-	GCF Priority 3: Addition of ESM TC 10.6.2 for UE requested PDN disconnect procedure not accepted by the network	8.1.0	8.2.0
2009-05	RAN#44	R5-092510	0236	-	GCF priority 2 - Update of 9.2.1.1.17 Attach / rejected / no suitable cells in tracking area	8.1.0	8.2.0
2009-05	RAN#44	R5-092512	0237	-	GCF priority 1: Update of EMM TC 9.3.1.2 Service Request initiated by UE for uplink signalling	8.1.0	8.2.0
2009-05	RAN#44	R5-092513	0238	-	GCF priority 2: Update of 9.2.1.1.17 Attach / rejected / no suitable cells in tracking area	8.1.0	8.2.0
2009-05	RAN#44	R5-092514	0239	-	GCF priority 1: Update of 9.2.1.1.1 Attach Procedure / Success (valid GUTI)	8.1.0	8.2.0
2009-05	RAN#44	R5-092515	0240	-	GCF priority 2: Update of 9.2.1.1.5 Attach Procedure/ Success / ATTACH ACCEPT includes the PDN address assigned to the UE	8.1.0	8.2.0
2009-05	RAN#44	R5-092516	0241	-	GCF priority 2: Update of 9.2.1.1.9 Attach / rejected / IMSI invalid	8.1.0	8.2.0
2009-05	RAN#44	R5-092517	0242	-	GCF priority 2: Update of 9.2.1.1.10 Attach / rejected / illegal ME	8.1.0	8.2.0
2009-05	RAN#44	R5-092518	0243	-	GCF priority TBC: Update of 9.2.1.1.12 Attach / rejected / GPRS services not allowed	8.1.0	8.2.0
2009-05	RAN#44	R5-092539	0244	-	GCF Priority 1 - Update of RLC section	8.1.0	8.2.0
2009-05	RAN#44	R5-092567	0245	-	GCF Priority 2 - Addition of a new test case 6.2.3.5 Inter-RAT Cell Reselection / from E-UTRA RRC_IDLE to UTRA_Idle	8.1.0	8.2.0
2009-05	RAN#44	R5-092569	0246	-	GCF Priority 2: Inter-RAT cell Selection / from E-UTRA RRC_IDLE to UTRA_Idle, serving cell	8.1.0	8.2.0

Date	TSG #	TSG Doc.	CR	Rev	Subject/Comment	Version Old	Version New
					becomes non-suitable (SServingCell<0,barred)		
2009-05	RAN#44	R5-092570	0247	-	GCF Priority 2: Inter-RAT cell Selection / from E-UTRA RRC_IDLE to GSM_Idle/GPRS Packet_idle, serving cell becomes non-suitable (SServingCell<0,barred)	8.1.0	8.2.0
2009-05	RAN#44	R5-092571	0248	-	GCF Priority 1 - New E-UTRA MAC test case - 7.1.7.1.1 DL-SCH Transport Block Size support / DCI format 1 / RA type 0	8.1.0	8.2.0
2009-05	RAN#44	R5-092575	0249	-	GCF Priority 1 - New E-UTRA MAC test case 7.1.7.1.2 - DL-SCH Transport Block Size selection / DCI format 1 / RA type 1	8.1.0	8.2.0
2009-05	RAN#44	R5-092577	0250	-	GCF Priority 1 - New E-UTRA MAC test case 7.1.7.2.1 - UL-SCH Transport Block Size selection / DCI format 0	8.1.0	8.2.0
2009-05	RAN#44	R5-092578	0251	-	GCF priority 2: New MAC test case: 7.1.6.1 DRX Operation / (short cycle not configured) / Parameters configured by RRC (radio resource configuration)	8.1.0	8.2.0
2009-05	RAN#44	R5-092579	0252	-	GCF Priority 2 - New RRC part1 TC 8.1.3.8 RRC Connection Release: redirection from E-UTRAN to GERAN	8.1.0	8.2.0
2009-05	RAN#44	R5-092580	0253	-	GCF Priority 2 - Update of test case 8.2.1.3	8.1.0	8.2.0
2009-05	RAN#44	R5-092583	0254	-	GCF Priority 2: Attach Procedure / Success (last visited TAI, TAI list and equivalent PLMN list handling) 9.2.1.1.1a	8.1.0	8.2.0
2009-05	RAN#44	R5-092584	0255	-	GCF Priority 1 - Update of test case 8.2.1.1	8.1.0	8.2.0
2009-05	RAN#44	R5-092589	0256	-	GCF Priority 2 - Addition of new EMM test case 9.3.1.7a	8.1.0	8.2.0
2009-05	RAN#44	R5-092593	0257	-	GCF priority 2 - Update of 9.2.1.1.15 Attach / rejected / roaming not allowed in this tracking area	8.1.0	8.2.0
2009-05	RAN#44	R5-092595	0258	-	GCF Priority 1:Corrections to MAC test case 7.1.1.1	8.1.0	8.2.0
2009-05	RAN#44	R5-092596	0259	-	GCF Priority 1:Corrections to MAC test case 7.1.4.12	8.1.0	8.2.0
2009-05	RAN#44	R5-092597	0260	-	GCF Priority 1 - Update to test case 8.2.4.1	8.1.0	8.2.0
2009-05	RAN#44	R5-092700	0261	-	GCF Priority 2 - Addition of new test case 8.3.2.1	8.1.0	8.2.0
2009-05	RAN#44	R5-092701	0262	-	GCF Priority-1: Correction to 9.2.3.1.1 'Normal tracking area update / accepted'	8.1.0	8.2.0
2009-05	RAN#44	R5-092702	0263	-	GCF Priority-1: Correction to 9.2.3.1.5'Periodic tracking area update / accepted'	8.1.0	8.2.0
2009-05	RAN#44	R5-092703	0264	-	GCF Priority 2 - Addition of E-UTRAN test case 6.1.2.7 for Cell reselection: Equivalent PLMN	8.1.0	8.2.0
2009-05	RAN#44	R5-092706	0265	-	GCF Priority 1 - Update to RRC test cases	8.1.0	8.2.0
2009-05	RAN#44	R5-092712	0266	-	GCF Priority 2: New MAC test case 7.1.4.14	8.1.0	8.2.0
2009-05	RAN#44	R5-092713	0267	-	GCF Priority 2 - Update to test case 8.1.2.5	8.1.0	8.2.0
2009-05	RAN#44	R5-092714	0268	-	GCF Priority 2 - Update to test case 8.1.2.7	8.1.0	8.2.0
2009-05	RAN#44	R5-092715	0269	-	GCF Priority 2 - Addition of RRC test case 8.3.2.6	8.1.0	8.2.0
2009-05	RAN#44	R5-092716	0270	-	GCF Priority 1 - Update of E-UTRA MAC test case 7.1.4.7	8.1.0	8.2.0
2009-05	RAN#44	R5-092717	0271	-	GCF Priority 1 - New E-UTRA MAC test case 7.1.7.1.4 - DL-SCH Transport Block Size selection / DCI format 1A / RA type 2 / Distributed VRB	8.1.0	8.2.0
2009-05	RAN#44	R5-092718	0272	-	GCF Priority 1 - New E-UTRA MAC test case 7.1.7.1.3 - DL-SCH Transport Block Size selection / DCI format 1A / RA type 2 / Localised VRB	8.1.0	8.2.0
2009-05	RAN#44	R5-092730	0273	-	GCF priority 2: New MAC test case: 7.1.6.2 DRX Operation / Parameters (short cycle not configured) / DRX command MAC control element reception	8.1.0	8.2.0
2009-05	RAN#44	R5-092731	0274	-	GCF Priority 2 - Updates to E-UTRAN Idle Mode test case 6.1.2.9	8.1.0	8.2.0
2009-05	RAN#44	R5-092732	0275	-	GCF Priority 2 - Updates to E-UTRAN Idle Mode test case 6.1.2.8	8.1.0	8.2.0
2009-05	RAN#44	R5-092741	0276	-	GCF Priority 1 - Update to idle mode test cases	8.1.0	8.2.0
2009-05	RAN#44	R5-092751	0277	-	Addition of new idle mode test case for ignoring CSG cells in cell selection when Allowed CSG list is empty or not supported	8.1.0	8.2.0
2009-05	RAN#44	R5-092752	0278	-	GCF Priority 2: New idle mode test case 6.2.3.1	8.1.0	8.2.0

Date	TSG #	TSG Doc.	CR	Rev	Subject/Comment	Version Old	Version New
2009-05	RAN#44	R5-092755	0279	-	GCF Priority 2 - Update to test case 8.3.1.10	8.1.0	8.2.0
2009-05	RAN#44	R5-092756	0280	-	GCF Priority 2 - Update to test case 8.3.2.3	8.1.0	8.2.0
2009-05	RAN#44	R5-092758	0281	-	GCF Priority 2 - Updates to E-UTRAN test case 6.1.1.1	8.1.0	8.2.0
2009-05	RAN#44	R5-092760	0282	-	GCF Priority 2: New idle mode test case 6.2.3.2	8.1.0	8.2.0
2009-05	RAN#44	R5-092761	0283	-	Move common test procedure from sections 6.0.1, 6.0.2, 6.0.3 to TS 36.508	8.1.0	8.2.0
2009-05	RAN#44	R5-092762	0284	-	Batch 2 - Addition of new RRC test case 8.3.2.7	8.1.0	8.2.0
2009-05	RAN#44	R5-092763	0285	-	Batch 2 - Addition of new RRC test case 8.3.2.8	8.1.0	8.2.0
2009-05	RAN#44	R5-092764	0286	-	LTE-SIG:TDD related updates in MAC sections	8.1.0	8.2.0
2009-05	RAN#44	R5-092768	0287	-	GCF Priority-1: Correction to 9.2.2.2.1 'NW initiated detach / re-attach required'	8.1.0	8.2.0
2009-05	RAN#44	R5-092784	0288	-	GCF Priority 2 - Update to test case 8.3.1.9	8.1.0	8.2.0
2009-05	RAN#44	R5-092483	0289	-	GCF Priority 1:Corrections to MAC test case 7.1.2.4	8.1.0	8.2.0
2009-05	RAN#44	R5-092528	0290	4	GCF Priority 1 - Update of E-UTRA MAC test case 7.1.2.3	8.1.0	8.2.0
2009-05	RAN#44	R5-092785	0291	-	GCF priority 2: A/Gb mode READY state to S1 mode cell reselection and E-UTRAN - GERAN RAU (9.2.3.4.1, 9.2.3.4.2)	8.1.0	8.2.0
2009-05	RAN#44	R5-092786	0292	-	GCF Priority 2 - Update of TC 9.2.1.1.14 Attach / rejected / tracking area not allowed	8.1.0	8.2.0
-	-	-	-	-	Editorial corrections and split into sections	8.2.0	8.2.1
2009-09	RAN#45	R5-094075	0293	-	GCF Priority 1 - Update of MAC test case 7.1.2.6	8.2.1	8.3.0
2009-09	RAN#45	R5-094076	0294	-	GCF Priority 1 - Update of MAC test case 7.1.3.1	8.2.1	8.3.0
2009-09	RAN#45	R5-094078	0295	-	GCF Priority 1 - Update of MAC test case 7.1.3.3	8.2.1	8.3.0
2009-09	RAN#45	R5-094079	0296	-	GCF Priority 1 - Update of MAC test case 7.1.3.4	8.2.1	8.3.0
2009-09	RAN#45	R5-094080	0297	-	GCF Priority 1 - Update of MAC test case 7.1.3.5	8.2.1	8.3.0
2009-09	RAN#45	R5-094081	0298	-	GCF Priority 1 - Update of MAC test case 7.1.3.6	8.2.1	8.3.0
2009-09	RAN#45	R5-094082	0299	-	GCF Priority 1 - Update of MAC test case 7.1.3.7	8.2.1	8.3.0
2009-09	RAN#45	R5-094083	0300	-	GCF Priority 1 - Update of MAC test case 7.1.4.1	8.2.1	8.3.0
2009-09	RAN#45	R5-094085	0301	-	GCF Priority 1 - Update of MAC test case 7.1.4.6	8.2.1	8.3.0
2009-09	RAN#45	R5-094086	0302	-	GCF Priority 1 - Update of MAC test case 7.1.4.7	8.2.1	8.3.0
2009-09	RAN#45	R5-094087	0303	-	GCF Priority 1 - Update of MAC test case 7.1.4.8	8.2.1	8.3.0
2009-09	RAN#45	R5-094088	0304	-	GCF Priority 1 - Update of MAC test case 7.1.4.11	8.2.1	8.3.0
2009-09	RAN#45	R5-094089	0305	-	GCF Priority 1 - Update of MAC test case 7.1.4.13	8.2.1	8.3.0
2009-09	RAN#45	R5-094090	0306	-	GCF Priority 1 - Update of MAC test case 7.1.4.15	8.2.1	8.3.0
2009-09	RAN#45	R5-094091	0307	-	GCF Priority 1 - Update of PDCP test case 7.3.1.1	8.2.1	8.3.0
2009-09	RAN#45	R5-094092	0308	-	GCF Priority 1 - Update of RRC test case 8.2.1.1	8.2.1	8.3.0
2009-09	RAN#45	R5-094093	0309	-	GCF Priority 2 - Update of MAC test case 7.1.4.16	8.2.1	8.3.0
2009-09	RAN#45	R5-094094	0310	-	GCF Priority 2 - Update of Idle Mode test case 6.1.2.3	8.2.1	8.3.0
2009-09	RAN#45	R5-094095	0311	-	GCF Priority 2 - Update of RRC test case 8.1.3.4	8.2.1	8.3.0
2009-09	RAN#45	R5-094096	0312	-	GCF Priority 2 - Update of RRC test case 8.1.3.6	8.2.1	8.3.0
2009-09	RAN#45	R5-094101	0313	-	GCF Priority 2 - Addition of new test case 10.7.1	8.2.1	8.3.0
2009-09	RAN#45	R5-094102	0314	-	GCF Priority 2 - Addition of new test case 10.7.2	8.2.1	8.3.0
2009-09	RAN#45	R5-094114	0315	-	Addition of new test case 6.2.2.5	8.2.1	8.3.0
2009-09	RAN#45	R5-094121	0316	-	GCF Priority 2 - Update to test case 8.3.1.9	8.2.1	8.3.0
2009-09	RAN#45	R5-094122	0317	-	Remove TC 8.4.1.8 from TS 36.523-1	8.2.1	8.3.0
2009-09	RAN#45	R5-094124	0318	-	GCF Priority 2 - Addition of new test case 8.4.2.4	8.2.1	8.3.0
2009-09	RAN#45	R5-094187	0319	-	GCF Priority 2 - New EMM TC 9.1.4.2	8.2.1	8.3.0

Date	TSG #	TSG Doc.	CR	Rev	Subject/Comment	Version Old	Version New
2009-09	RAN#45	R5-094189	0320	-	GCF Priority 2 - Removal of EMM TC 9.1.2.2	8.2.1	8.3.0
2009-09	RAN#45	R5-094195	0321	-	GCF Priority 1 - Update of MAC test case 7.1.4.10	8.2.1	8.3.0
2009-09	RAN#45	R5-094196	0322	-	GCF Priority 2 - Update of RLC test case 7.2.3.21	8.2.1	8.3.0
2009-09	RAN#45	R5-094201	0323	-	GCF Priority 2 - Update of RRC test case 8.3.2.6	8.2.1	8.3.0
2009-09	RAN#45	R5-094202	0324	-	GCF Priority 2 - Add new RRC test case 8.4.1.2	8.2.1	8.3.0
2009-09	RAN#45	R5-094203	0325	-	GCF Priority 2 - Add new RRC test case 8.4.1.4	8.2.1	8.3.0
2009-09	RAN#45	R5-094205	0326	-	GCF Priority 3 - Remove RRC test case 8.1.3.3	8.2.1	8.3.0
2009-09	RAN#45	R5-094284	0327	-	Removal of the GUTI reallocation procedures test cases	8.2.1	8.3.0
2009-09	RAN#45	R5-094289	0328	-	GCF Priority 2 - TDD formulation update in 7.1.6.1 DRX Operation / (short cycle not configured) /Parameters configured by RRC (radio resource configuration)	8.2.1	8.3.0
2009-09	RAN#45	R5-094290	0329	-	GCF Priority 2 - TDD formulation update in 7.1.6.2 DRX Operation / Parameters (short cycle not configured) / DRX command MAC control element reception	8.2.1	8.3.0
2009-09	RAN#45	R5-094366	0330	-	GCF Priority 2 - Corrections to E-UTRAN test case 6.1.1.1	8.2.1	8.3.0
2009-09	RAN#45	R5-094369	0331	-	GCF Priority 2 - Updates to E-UTRAN test case 6.1.2.7	8.2.1	8.3.0
2009-09	RAN#45	R5-094372	0332	-	GCF Priority 2 - Corrections to E-UTRAN test cases 6.1.2.8 and 6.1.2.9	8.2.1	8.3.0
2009-09	RAN#45	R5-094387	0333	-	GCF Priority 2 - Update to test case 9.2.2.1.6	8.2.1	8.3.0
2009-09	RAN#45	R5-094392	0334	-	GCF Priority 2 - Correction of discard timer value to be consistent with test tolerances	8.2.1	8.3.0
2009-09	RAN#45	R5-094399	0335	-	GCF Priority 2 - Addition new test case 6.2.3.3	8.2.1	8.3.0
2009-09	RAN#45	R5-094426	0336	-	GCF Priority 1 - Corrections to MAC test case 7.1.4.6	8.2.1	8.3.0
2009-09	RAN#45	R5-094428	0337	-	GCF Priority 1 - Corrections to MAC test case 7.1.4.10	8.2.1	8.3.0
2009-09	RAN#45	R5-094432	0338	-	GCF Priority 2 - Corrections to MAC test case 7.1.4.16	8.2.1	8.3.0
2009-09	RAN#45	R5-094520	0339	-	GCF Priority 2 - Update of RRC test case 8.3.1.1	8.2.1	8.3.0
2009-09	RAN#45	R5-094521	0340	-	GCF Priority 2 - Update of RRC test case 8.3.1.3	8.2.1	8.3.0
2009-09	RAN#45	R5-094523	0341	-	GCF Priority 2 - Update of RRC test case 8.3.1.5	8.2.1	8.3.0
2009-09	RAN#45	R5-094525	0342	-	GCF Priority 1 - Update of RRC test case 8.3.3.1	8.2.1	8.3.0
2009-09	RAN#45	R5-094577	0343	-	GCF Priority 1 - Update of EMM part TC 9.1.3.1 NAS security mode command accepted by the UE	8.2.1	8.3.0
2009-09	RAN#45	R5-094627	0344	-	GCF Priority 2 - Update of MAC TC 7.1.3.2 DL SPS	8.2.1	8.3.0
2009-09	RAN#45	R5-094628	0345	-	GCF Priority 2 - Update of MAC TC 7.1.4.2 UL SPS	8.2.1	8.3.0
2009-09	RAN#45	R5-094629	0346	-	GCF Priority 1 - Corrections to MAC test case 7.1.3.9	8.2.1	8.3.0
2009-09	RAN#45	R5-094635	0347	-	GCF Priority 1 - Correction to E-UTRAN RLC test case 7.2.3.1	8.2.1	8.3.0
2009-09	RAN#45	R5-094636	0348	-	GCF Priority 1 - Adding Test Coverage for Verification of UE setting of the RRC Establishment Cause in EMM test case 9.2.1.1.1	8.2.1	8.3.0
2009-09	RAN#45	R5-094660	0349	-	GCF Priority 2 - Update of MAC test case 7.1.4.3	8.2.1	8.3.0
2009-09	RAN#45	R5-094662	0350	-	GCF Priority 1 - Corrections to RLC section	8.2.1	8.3.0
2009-09	RAN#45	R5-094664	0351	-	GCF Priority 1 - Update of RLC test case 7.2.3.9	8.2.1	8.3.0
2009-09	RAN#45	R5-094666	0352	-	GCF Priority 2 - Addition of new EMM test case 9.2.3.3.5	8.2.1	8.3.0
2009-09	RAN#45	R5-094674	0353	-	GCF Priority 2 - Update of RRC test case 8.3.2.8	8.2.1	8.3.0
2009-09	RAN#45	R5-094676	0354	-	GCF Priority 3 - Update of RRC test case 8.3.2.9	8.2.1	8.3.0
2009-09	RAN#45	R5-094707	0355	-	GCF Priority 1 - Correction to E-UTRAN MAC test case 7.1.2.3	8.2.1	8.3.0
2009-09	RAN#45	R5-094762	0356	-	GCF Priority 2 - Update of RRC test case	8.2.1	8.3.0

Date	TSG #	TSG Doc.	CR	Rev	Subject/Comment	Version Old	Version New
					6.2.2.3		
2009-09	RAN#45	R5-094776	0357	-	GCF Priority 2 - Update of RRC test case 6.2.3.7	8.2.1	8.3.0
2009-09	RAN#45	R5-094788	0358	-	GCF Priority 2 - Update of RRC test case 6.2.3.8	8.2.1	8.3.0
2009-09	RAN#45	R5-094798	0359	-	GCF Priority 2 - Update of RRC test case 8.1.3.9	8.2.1	8.3.0
2009-09	RAN#45	R5-094814	0360	-	GCF Priority 2 - Update of RRC test case 8.1.3.10	8.2.1	8.3.0
2009-09	RAN#45	R5-094817	0361	-	GCF Priority 2 - Update of RRC test case 8.3.2.7	8.2.1	8.3.0
2009-09	RAN#45	R5-094823	0362	-	GCF Priority 2 - Update of RRC test case 8.3.2.8	8.2.1	8.3.0
2009-09	RAN#45	R5-094833	0363	-	GCF Priority 2 - Correction of EMM TC 9.2.1.1.9 Attach / rejected / IMSI invalid	8.2.1	8.3.0
2009-09	RAN#45	R5-094866	0364	2	GCF Priority 1: Corrections to E-UTRA MAC test case 7.1.7.1.1	8.2.1	8.3.0
2009-09	RAN#45	R5-094867	0365	2	GCF Priority 1: Corrections to E-UTRA MAC test case 7.1.7.1.2	8.2.1	8.3.0
2009-09	RAN#45	R5-094868	0366	2	GCF Priority 1: Corrections to E-UTRA MAC test case 7.1.7.1.3	8.2.1	8.3.0
2009-09	RAN#45	R5-094869	0367	2	GCF Priority 1: Corrections to E-UTRA MAC test case 7.1.7.1.4	8.2.1	8.3.0
2009-09	RAN#45	R5-094876	0368	-	GCF Priority 1 - Correction to E-UTRAN RLC test case 7.2.3.2	8.2.1	8.3.0
2009-09	RAN#45	R5-095004	0369	-	GCF Priority 2 - Update of 9.1.2.4	8.2.1	8.3.0
2009-09	RAN#45	R5-095005	0370	-	GCF Priority 2 - Update of 9.1.2.5	8.2.1	8.3.0
2009-09	RAN#45	R5-095008	0371	-	GCF Priority 2 - Update of MAC TC 7.1.4.14 TTI Bundling	8.2.1	8.3.0
2009-09	RAN#45	R5-095028	0372	-	GCF Priority 1 - Various corrections to RLC section of 36.523-1	8.2.1	8.3.0
2009-09	RAN#45	R5-095032	0373	-	GCF Priority 2 - Addition of new SMS over SGs test case 11.1.1	8.2.1	8.3.0
2009-09	RAN#45	R5-095036	0374	-	GCF Priority 2 - Correction to 9.2.2.2.2 NW initiated detach / IMSI detach	8.2.1	8.3.0
2009-09	RAN#45	R5-095037	0375	-	GCF Priority 2 - Correction of PDCP status report	8.2.1	8.3.0
2009-09	RAN#45	R5-095038	0376	-	GCF Priority 2 - Correction of PDCP handover test procedure	8.2.1	8.3.0
2009-09	RAN#45	R5-095041	0377	-	GCF Priority 2 - Update of 9.1.2.3	8.2.1	8.3.0
2009-09	RAN#45	R5-095065	0378	-	GCF Priority 2 - Adding Test Coverage for Verification of UE setting of the RRC Establishment Cause in EMM test case 9.2.2.1.1	8.2.1	8.3.0
2009-09	RAN#45	R5-095066	0379	-	GCF Priority 1 - Adding Test Coverage for Verification of UE setting of the RRC Establishment Cause in EMM test case 9.3.1.1	8.2.1	8.3.0
2009-09	RAN#45	R5-095067	0380	-	GCF Priority 1 - Adding Test Coverage for Verification of UE setting of the RRC Establishment Cause in EMM test case 9.3.1.2	8.2.1	8.3.0
2009-09	RAN#45	R5-095069	0381	-	GCF Priority 2 - Adding Test Coverage for Verification of UE setting of the RRC Establishment Cause in EMM test case 9.3.1.3	8.2.1	8.3.0
2009-09	RAN#45	R5-095070	0382	-	GCF Priority 2 - Adding Test Coverage for Verification of UE setting of the RRC Establishment Cause in EMM test case 9.3.2.2	8.2.1	8.3.0
2009-09	RAN#45	R5-095073	0383	-	GCF Priority 2 - Update of EMM test case 9.3.1.7a	8.2.1	8.3.0
2009-09	RAN#45	R5-095075	0384	-	GCF Priority 1 - Corrections to MAC test case 7.1.4.1	8.2.1	8.3.0
2009-09	RAN#45	R5-095076	0385	-	GCF Priority 1 - Corrections to MAC test case 7.1.4.8	8.2.1	8.3.0
2009-09	RAN#45	R5-095077	0386	-	GCF Priority 1 - Corrections to MAC test case 7.1.4.13	8.2.1	8.3.0
2009-09	RAN#45	R5-095078	0387	-	GCF Priority 1 - Corrections to MAC test case 7.1.4.5	8.2.1	8.3.0
2009-09	RAN#45	R5-095086	0388	-	GCF Priority 1 - Various corrections to RLC section of 36.523-1	8.2.1	8.3.0
2009-09	RAN#45	R5-095087	0389	-	GCF Priority 2 - New EMM TC 9.3.1.7	8.2.1	8.3.0
2009-09	RAN#45	R5-095088	0390	-	GCF Priority 1 - Update to test case 9.2.1.1.2	8.2.1	8.3.0
2009-09	RAN#45	R5-095089	0391	-	Update to GCF Priority 2 test case 9.2.1.1.7	8.2.1	8.3.0
2009-09	RAN#45	R5-095090	0392	-	GCF Priority 2 - Update to test case 9.2.2.1.1	8.2.1	8.3.0
2009-09	RAN#45	R5-095094	0393	-	Update to preamble in L2 UM test cases	8.2.1	8.3.0

Date	TSG #	TSG Doc.	CR	Rev	Subject/Comment	Version Old	Version New
2009-09	RAN#45	R5-095097	0394	-	Add reference to test procedure for Idle Mode section	8.2.1	8.3.0
2009-09	RAN#45	R5-095103	0395	-	GCF Priority 1 - Update of MAC part TC 7.1.2.1	8.2.1	8.3.0
2009-09	RAN#45	R5-095104	0396	-	GCF Priority 1 - Corrections to MAC test case 7.1.4.11	8.2.1	8.3.0
2009-09	RAN#45	R5-095105	0397	-	Addition new test case 6.2.3.13	8.2.1	8.3.0
2009-09	RAN#45	R5-095109	0398	-	GCF Priority 1 - Update of 9.1.2.1	8.2.1	8.3.0
2009-09	RAN#45	R5-095110	0399	-	GCF Priority 1 - Correction to E-UTRAN MAC test case 7.1.3.1	8.2.1	8.3.0
2009-09	RAN#45	R5-095112	0400	-	GCF Priority 2 - Correction of EMM TC 9.2.1.1.12 Attach / rejected / EPS services not allowed	8.2.1	8.3.0
2009-09	RAN#45	R5-095113	0401	-	GCF Priority 2 - Corrections to test case 9.2.1.1.13 Attach / rejected / PLMN not allowed	8.2.1	8.3.0
2009-09	RAN#45	R5-095116	0402	-	GCF Priority 2 - Correction of EMM 9.2.1.1.17 TC Attach / rejected / no suitable cells in tracking area	8.2.1	8.3.0
2009-09	RAN#45	R5-095118	0403	-	GCF Priority 3 - Correction to EMM TC 9.2.1.2.3 Combined attach procedure / Success / EPS services only / MSC temporarily not reachable	8.2.1	8.3.0
2009-09	RAN#45	R5-095120	0404	-	GCF Priority 1 - Various corrections to other section of 36.523-1	8.2.1	8.3.0
2009-09	RAN#45	R5-095121	0405	-	GCF Priority 1 - Various corrections to RRC Part1 section of 36.523-1	8.2.1	8.3.0
2009-09	RAN#45	R5-095125	0406	-	GCF Priority 1 - Update of MAC TC 7.1.4.4 SR	8.2.1	8.3.0
2009-09	RAN#45	R5-095126	0407	-	GCF Priority 1 - Update of 9.3.2.1	8.2.1	8.3.0
2009-09	RAN#45	R5-095127	0408	-	Priority 2 - Update of test case 6.2.2.1	8.2.1	8.3.0
2009-09	RAN#45	R5-095131	0409	2	GCF Priority 1 - Addition of new Multi-layer Procedures test case 13.1.1	8.2.1	8.3.0
2009-09	RAN#45	R5-095132	0410	2	GCF Priority 1 - Addition of new Multi-layer Procedures test case 13.2.1	8.2.1	8.3.0
2009-09	RAN#45	R5-095133	0411	-	GCF Priority 1 - Correction to E-UTRAN RLC test case 7.2.3.5	8.2.1	8.3.0
2009-09	RAN#45	R5-095135	0412	-	GCF Priority 2 - Update of cell reselection test case 6.1.2.15	8.2.1	8.3.0
2009-09	RAN#45	R5-095136	0413	-	GCF Priority 2 - Update of PDCP test case handover / In-order delivery and duplicate elimination in the downlink	8.2.1	8.3.0
2009-09	RAN#45	R5-095139	0414	-	GCF Priority 2 - Addition of test case 11.1.3 MO-SMS over SGs in idle mode	8.2.1	8.3.0
2009-09	RAN#45	R5-095140	0415	-	GCF Priority 2 - Correction to 9.2.3.1.2 Normal tracking area update / accepted / 'Active' flag set	8.2.1	8.3.0
2009-09	RAN#45	R5-095141	0416	-	GCF Priority 2 - Correction of TC 9.2.1.1.14 Attach / rejected / tracking area not allowed	8.2.1	8.3.0
2009-09	RAN#45	R5-095148	0417	-	GCF Priority 2 - Correction of EMM TC 9.2.1.1.15 Attach / rejected / roaming not allowed in this tracking area	8.2.1	8.3.0
2009-09	RAN#45	R5-095149	0418	-	GCF Priority 2 - Addition of new test case 9.2.3.3.6 for E-UTRAN RRC connection failure / reselection of UTRAN cell / NAS signalling to release old S1 interface connection	8.2.1	8.3.0
2009-09	RAN#45	R5-095150	0419	-	GCF Priority 2 - Update to test case 10.8.1	8.2.1	8.3.0
2009-09	RAN#45	R5-095151	0420	-	GCF Priority 2 - Addition of new SMS over SGs test case 11.1.2	8.2.1	8.3.0
2009-09	RAN#45	R5-095161	0421	-	GCF Priority 1 - Various corrections to Idle Mode section of 36.523-1	8.2.1	8.3.0
2009-09	RAN#45	R5-095164	0422	-	GCF Priority 1 - Update of E-UTRA MAC test case 7.1.2.4	8.2.1	8.3.0
2009-09	RAN#45	R5-095172	0423	-	GCF Priority 4 - New TC 8.1.3.7 RRC Connection Release: redirection from UTRAN to E-UTRAN	8.2.1	8.3.0
2009-09	RAN#45	R5-095173	0424	1	GCF Priority 3 - Update to test case 9.2.2.1.2	8.2.1	8.3.0
2009-09	RAN#45	R5-095175	0425	1	GCF Priority 3 - Correction to 9.2.1.2.1 'Combined attach procedure / Success / EPS and non-EPS services'	8.2.1	8.3.0
2009-09	RAN#45	R5-095177	0426	-	GCF Priority 3 - CR to EMM TC 9.2.1.1.19 Attach / Abnormal case / Failure due to non integrity protection	8.2.1	8.3.0
2009-09	RAN#45	R5-095178	0427	-	GCF Priority 3 - New EMM TC 9.2.3.2.1a Combined tracking area update / successful / check of last visited TAI and handling of TAI	8.2.1	8.3.0

Date	TSG #	TSG Doc.	CR	Rev	Subject/Comment	Version Old	Version New
					list, LAI and TMSI		
2009-09	RAN#45	R5-095179	0428	-	GCF Priority 3 - Addition of new test case 6.2.2.4	8.2.1	8.3.0
2009-09	RAN#45	R5-095188	0429	3	GCF Priority 1: Corrections to E-UTRA MAC test case 7.1.7.2.1	8.2.1	8.3.0
2009-09	RAN#45	R5-095207	0430	-	GCF Priority 2 - Addition of new test case 8.4.2.2	8.2.1	8.3.0
2009-09	RAN#45	R5-095208	0431	-	GCF Priority 1 - Corrections to RLC test case 7.2.3.7	8.2.1	8.3.0
2009-09	RAN#45	R5-095217	0432	-	GCF Priority 1 - Corrections to PDCP test cases 7.5.3.2 and 7.5.3.3	8.2.1	8.3.0
2009-09	RAN#45	R5-095219	0433	-	GCF Priority 1 - Various corrections to RRC Part2 section of 36.523-1	8.2.1	8.3.0
2009-09	RAN#45	R5-095220	0434	-	GCF Priority 1 - Various corrections to RRC Part 3 section of 36.523-1	8.2.1	8.3.0
2009-10	-	-	-	-	Minor CR 414 implementation corrections	8.3.0	8.3.1
2009-10	-	-	-	-	Minor CR 354 implementation corrections	8.3.1	8.3.2
2009-11	GERAN#44	GP-092405	0435	-	Addition of new Test Case 6.2.3.21	8.3.2	8.4.0
2009-12	RAN#46	R5-095444	0436	-	Removal of TC 8.1.2.10 from TS 36.523-1	8.3.2	8.4.0
2009-12	RAN#46	R5-095446	0437	-	GCF Priority 1 - Various corrections to RRC Part 2 section of 36.523-1	8.3.2	8.4.0
2009-12	RAN#46	R5-095447	0438	-	Removal of TC 8.2.1.2 from TS 36.523-1	8.3.2	8.4.0
2009-12	RAN#46	R5-095448	0439	-	Removal of TC 8.2.1.4 from TS 36.523-1	8.3.2	8.4.0
2009-12	RAN#46	R5-095450	0440	-	GCF Priority 2 - Update to test case 8.2.4.5	8.3.2	8.4.0
2009-12	RAN#46	R5-095451	0441	-	GCF Priority 3 - Update to test case 8.2.4.9	8.3.2	8.4.0
2009-12	RAN#46	R5-095462	0442	-	GCF Priority 3 - Addition of test case 9.2.3.1.9a	8.3.2	8.4.0
2009-12	RAN#46	R5-095467	0443	-	GCF Priority 3 - Addition of test case 9.3.1.16	8.3.2	8.4.0
2009-12	RAN#46	R5-095505	0444	-	GCF Priority 2 - Update test case 6.1.2.11	8.3.2	8.4.0
2009-12	RAN#46	R5-095507	0445	-	GCF Priority 2 - Correction for Measurement test cases	8.3.2	8.4.0
2009-12	RAN#46	R5-095521	0446	-	GCF Priority 1 - Update of RLC test case 7.2.3.14	8.3.2	8.4.0
2009-12	RAN#46	R5-095524	0447	-	GCF Priority 2 - Update of EMM test case 9.2.3.3.5	8.3.2	8.4.0
2009-12	RAN#46	R5-095525	0448	-	GCF Priority 2 - Update of EMM test case 9.3.1.7a	8.3.2	8.4.0
2009-12	RAN#46	R5-095597	0449	-	GCF Priority 3 - Addition of E-UTRAN test case 8.3.1.11	8.3.2	8.4.0
2009-12	RAN#46	R5-095609	0450	-	GCF Priority 1 - Update of EMM test case 9.2.3.1.5	8.3.2	8.4.0
2009-12	RAN#46	R5-095621	0451	-	GCF Priority 2 - Removal of TC 8.4.2.6	8.3.2	8.4.0
2009-12	RAN#46	R5-095774	0452	-	GCF Priority 2 - Correction to test case 6.1.1.1	8.3.2	8.4.0
2009-12	RAN#46	R5-095783	0453	-	GCF Priority 3 - Update to test case 9.2.1.1.25	8.3.2	8.4.0
2009-12	RAN#46	R5-095784	0454	-	GCF Priority 2 - Update to test case 9.2.2.1.1	8.3.2	8.4.0
2009-12	RAN#46	R5-095785	0455	-	GCF Priority 3 - Update to test case 9.2.2.1.2	8.3.2	8.4.0
2009-12	RAN#46	R5-095786	0456	-	GCF Priority 2 - Update to test case 9.2.2.1.6	8.3.2	8.4.0
2009-12	RAN#46	R5-095795	0457	-	Addition of new DSMIPv6 test case for Discovery of the Home Agent via DNS	8.3.2	8.4.0
2009-12	RAN#46	R5-095796	0458	-	Addition of new DSMIPv6 test case for Security association establishment without Home Agent reallocation procedure	8.3.2	8.4.0
2009-12	RAN#46	R5-095802	0459	-	GCF Priority 3 - Addition of new RRC test case 8.4.5.4	8.3.2	8.4.0
2009-12	RAN#46	R5-095803	0460	-	GCF Priority 3 - Addition of new RRC test case 8.4.7.3	8.3.2	8.4.0
2009-12	RAN#46	R5-095804	0461	-	GCF Priority 3 - Addition of new RRC test case 8.4.7.4	8.3.2	8.4.0
2009-12	RAN#46	R5-095884	0462	-	GCF Priority 1 - Correction of TC 9.2.1.1.1 Attach Procedure / Success (valid GUTI)	8.3.2	8.4.0
2009-12	RAN#46	R5-095885	0463	-	GCF Priority x - Proposed removal of TC 9.3.1.2 Service Request initiated by UE for uplink signalling	8.3.2	8.4.0
2009-12	RAN#46	R5-095886	0464	-	GCF Priority 2 - Proposed removal of TC 9.2.1.1.5 Attach Procedure / Success / ATTACH ACCEPT message includes the PDN address assigned to the UE	8.3.2	8.4.0
2009-12	RAN#46	R5-095901	0465	-	GCF Priority 2 - Correction of TC 9.2.3.3.6 E-UTRAN RRC connection failure / reselection of UTRAN cell / NAS signalling to release old S1 interface connection	8.3.2	8.4.0
2009-12	RAN#46	R5-095937	0466	-	GCF Priority 1 - Correction to E-UTRAN MAC test case 7.1.4.6	8.3.2	8.4.0

Date	TSG #	TSG Doc.	CR	Rev	Subject/Comment	Version Old	Version New
2009-12	RAN#46	R5-095963	0467	-	GCF Priority 2 - Update of TC 9-1-2-5 for IP handling over U-plane	8.3.2	8.4.0
2009-12	RAN#46	R5-095972	0468	-	GCF Priority 1 - Update of TC 9-1-2-1 for IP handling over U-plane	8.3.2	8.4.0
2009-12	RAN#46	R5-095976	0469	-	GCF Priority 2 - Update of TC 9-3-1-7 for IP handling over U-plane	8.3.2	8.4.0
2009-12	RAN#46	R5-095979	0470	-	GCF Priority 2 - Update of TC 9-1-2-4 for IP handling over U-plane	8.3.2	8.4.0
2009-12	RAN#46	R5-095980	0471	-	GCF Priority 2 - Test Case 9.1.4.2 Clause title formatting error	8.3.2	8.4.0
2009-12	RAN#46	R5-095997	0472	-	GCF Priority 2 - Correction to RRC test case 8.5.1.1	8.3.2	8.4.0
2009-12	RAN#46	R5-096009	0473	-	GCF Priority 1 - Correction to E-UTRAN MAC test case 7.2.3.5	8.3.2	8.4.0
2009-12	RAN#46	R5-096024	0474	-	GCF Priority 1: Cell number alignment in Test case 9.1.3.1	8.3.2	8.4.0
2009-12	RAN#46	R5-096027	0475	-	GCF Priority 2 - Cell number alignment in Test case 9.1.3.2	8.3.2	8.4.0
2009-12	RAN#46	R5-096029	0476	-	GCF Priority 2 - Cell number alignment in Test case 9.4.1	8.3.2	8.4.0
2009-12	RAN#46	R5-096031	0477	-	GCF Priority 2: Cell number alignment in Test case 9.4.3	8.3.2	8.4.0
2009-12	RAN#46	R5-096034	0478	-	GCF Priority 2: Correction to Test case 7.1.4.2	8.3.2	8.4.0
2009-12	RAN#46	R5-096036	0479	-	GCF Priority 2: Correction to Test case 7.1.4.14	8.3.2	8.4.0
2009-12	RAN#46	R5-096149	0480	-	GCF Priority 2 - update test case 8.5.1.3	8.3.2	8.4.0
2009-12	RAN#46	R5-096156	0481	-	GCF Priority 2 - Update of RLC test case 7.2.3.13	8.3.2	8.4.0
2009-12	RAN#46	R5-096160	0482	-	GCF Priority 2 - Update of TC 9-1-2-3 for IP handling over U-plane	8.3.2	8.4.0
2009-12	RAN#46	R5-096161	0483	-	GCF Priority 1 and Priority 2- EMM Successful Attach consistent description	8.3.2	8.4.0
2009-12	RAN#46	R5-096178	0484	-	GCF Priority 2 - Correction test cases 8.3.2.1, 8.3.2.7	8.3.2	8.4.0
2009-12	RAN#46	R5-096192	0485	-	GCF Priority 1 - Various editorial corrections to RLC section	8.3.2	8.4.0
2009-12	RAN#46	R5-096193	0486	-	GCF Priority 1 - Update to Idle Mode test case 6.1.2.2	8.3.2	8.4.0
2009-12	RAN#46	R5-096194	0487	-	GCF Priority 2 - Updated to test case 6.1.2.6	8.3.2	8.4.0
2009-12	RAN#46	R5-096196	0488	-	GCF Priority 2 - Correction to test case 6.3.6	8.3.2	8.4.0
2009-12	RAN#46	R5-096197	0489	-	GCF Priority 2 - Correction to test case 6.1.2.7	8.3.2	8.4.0
2009-12	RAN#46	R5-096401	0490	-	GCF Priority 1 - Correction to E-UTRAN MAC test case 7.1.2.9	8.3.2	8.4.0
2009-12	RAN#46	R5-096414	0491	-	GCF Priority 2 & 3 - Correction to test cases 9.2.1.1.9 and 9.2.1.1.12	8.3.2	8.4.0
2009-12	RAN#46	R5-096421	0492	-	GCF Priority 1: Update of MAC TC 7.1.7.1.1 DL-SCH TBS selection/DCI format 1/RA type0	8.3.2	8.4.0
2009-12	RAN#46	R5-096422	0493	-	GCF Priority 1: Update of MAC TC 7.1.7.1.2 DL-SCH TBS selection/DCI format 1/RA type1	8.3.2	8.4.0
2009-12	RAN#46	R5-096423	0494	-	GCF Priority 1: Update of MAC TC 7.1.7.1.3 DL-SCH TBS selection/DCI format 1A/RA type2/Localized VRB	8.3.2	8.4.0
2009-12	RAN#46	R5-096424	0495	-	GCF Priority 1: Update of MAC TC 7.1.7.1.4 DL-SCH TBS selection/DCI format 1A/RA type2/Distributed VRB	8.3.2	8.4.0
2009-12	RAN#46	R5-096425	0496	-	GCF Priority 1: Update of MAC TC 7.1.7.2.1 UL-SCH TBS selection/DCI format 0	8.3.2	8.4.0
2009-12	RAN#46	R5-096426	0497	1	GCF Priority 1: Update of E-UTRA MAC test case 7.1.4.7	8.3.2	8.4.0
2009-12	RAN#46	R5-096428	0498	-	GCF Priority 1: Update of E-UTRA MAC test case 7.1.3.7	8.3.2	8.4.0
2009-12	RAN#46	R5-096429	0499	-	GCF Priority 2 - Update to test case 9.2.1.1.7	8.3.2	8.4.0
2009-12	RAN#46	R5-096435	0500	-	GCF Priority 3: Introduction of a new EMM test case 9.2.3.1.6' Normal tracking area update / UE with ISR active moves to E-UTRAN '	8.3.2	8.4.0
2009-12	RAN#46	R5-096436	0501	-	GCF Priority 3: Introduction of 9.2.3.1.17 Normal tracking area update / rejected / Roaming not allowed in this tracking area	8.3.2	8.4.0
2009-12	RAN#46	R5-096437	0502	-	GCF Priority 3: Introduction of 9.2.3.1.18 Normal tracking area update / rejected / EPS services not allowed in this PLMN	8.3.2	8.4.0
2009-12	RAN#46	R5-096443	0503	-	GCF Priority 3: Addition of new test case 9.2.1.1.24: Attach / Abnormal case / Change of cell into a new tracking area	8.3.2	8.4.0

Date	TSG #	TSG Doc.	CR	Rev	Subject/Comment	Version Old	Version New
2009-12	RAN#46	R5-096444	0504	-	GCF Priority 3: Addition of new test case 9.2.1.1.26: Attach / Abnormal case / Detach procedure collision	8.3.2	8.4.0
2009-12	RAN#46	R5-096445	0505	-	GCF Priority 2: Correction to Test case 7.1.3.2	8.3.2	8.4.0
2009-12	RAN#46	R5-096446	0506	-	GCF Priority 1: Correction to EMM test case 9.3.1.1	8.3.2	8.4.0
2009-12	RAN#46	R5-096451	0507	-	GCF Priority 2 - Correction of test cases 9.2.1.1.9, 9.2.1.1.10, 9.2.1.1.11 Attach / rejected / IMSI invalid / Illegal UE / EPS and non-EPS services not allowed	8.3.2	8.4.0
2009-12	RAN#46	R5-096452	0508	-	GCF Priority 2 - Correction of TC 9.2.3.2.1 Combined tracking area update / successful	8.3.2	8.4.0
2009-12	RAN#46	R5-096454	0509	-	GCF Priority 2 - Correction of TC 9.2.3.3.1 First lu mode to S1 mode intersystem change after attach: go to E-UTRAN RRC idle: RAU to UTRAN	8.3.2	8.4.0
2009-12	RAN#46	R5-096459	0510	-	Disabling PHR and periodic BSR for L2 test cases in 36.523-1	8.3.2	8.4.0
2009-12	RAN#46	R5-096466	0511	-	Correction of test case 6.1.2.13	8.3.2	8.4.0
2009-12	RAN#46	R5-096467	0512	-	GCF Priority 1 - Correction to E-UTRAN MAC test case 7.1.4.13	8.3.2	8.4.0
2009-12	RAN#46	R5-096468	0513	-	GCF Priority 1 - Correction to E-UTRAN MAC test case 7.1.4.10	8.3.2	8.4.0
2009-12	RAN#46	R5-096470	0514	-	GCF Priority 3 - Addition of E-UTRAN test case 8.3.3.3 for Measurement configuration control and reporting / SON / ANR: CGI reporting of GERAN cell	8.3.2	8.4.0
2009-12	RAN#46	R5-096471	0515	-	GCF Priority 3 - Addition of E-UTRAN test case 8.3.3.2 :Measurement configuration control and reporting / SON / ANR: CGI reporting of UTRAN cell	8.3.2	8.4.0
2009-12	RAN#46	R5-096472	0516	-	GCF Priority 1 - Update of Multi-layer Procedures part TC 13.1.1 Activation and deactivation of additional data radio bearer in E-UTRA	8.3.2	8.4.0
2009-12	RAN#46	R5-096476	0517	-	GCF Priority 3 - Update of RRC part TC 8.5.1.2 RRC Connection Re-establishment: Success (after Radio Link Failure)	8.3.2	8.4.0
2009-12	RAN#46	R5-096479	0518	-	GCF Priority 3 - Update of RRC test case 8.2.1.7	8.3.2	8.4.0
2009-12	RAN#46	R5-096481	0519	-	GCF Priority 1 - Update to test case 7.2.3.4	8.3.2	8.4.0
2009-12	RAN#46	R5-096482	0520	-	GCF Priority 1 - Correction of TC 8.5.4.1 UE capability transfer / Success	8.3.2	8.4.0
2009-12	RAN#46	R5-096483	0521	-	GCF Priority 1 - Update of PDCP test case 7.3.3.1 : Ciphering and Deciphering: Correct functionality of EPS AS encryption algorithms (SNOW 3G)	8.3.2	8.4.0
2009-12	RAN#46	R5-096484	0522	-	GCF Priority 1: Correction to RRC test case 8.2.1.1	8.3.2	8.4.0
2009-12	RAN#46	R5-096485	0523	-	GCF Priority 1 - Update of EMM test case 9.2.3.1.1	8.3.2	8.4.0
2009-12	RAN#46	R5-096487	0524	-	GCF Priority 1 - Various corrections to Idle Mode section of 36.523-1	8.3.2	8.4.0
2009-12	RAN#46	R5-096488	0525	-	GCF Priority 2 - Update to test case 8.1.2.5	8.3.2	8.4.0
2009-12	RAN#46	R5-096489	0526	-	GCF Priority 2 - Update to test case 8.1.2.7	8.3.2	8.4.0
2009-12	RAN#46	R5-096491	0527	-	GCF Priority 2 - Various corrections to RRC Part 3 section of 36.523-1	8.3.2	8.4.0
2009-12	RAN#46	R5-096492	0528	-	GCF Priority 1 - Correction to E-UTRA DRB test case 12.2	8.3.2	8.4.0
2009-12	RAN#46	R5-096493	0529	3	GCF Priority 1 - Update of Multi-layer Procedures part TC 13.2.1 RRC Connection Reconfiguration: E-UTRA to E-UTRA	8.3.2	8.4.0
2009-12	RAN#46	R5-096494	0530	-	GCF Priority 1 - Update of applicability entry for DRB test case 12.3	8.3.2	8.4.0
2009-12	RAN#46	R5-096495	0531	-	GCF Priority 2 - Update of the test case 6.2.3.3	8.3.2	8.4.0
2009-12	RAN#46	R5-096496	0532	-	GCF Priority 2 - Update of Idle Mode Operations test case 6.1.2.5 Cell reselection for inter-band operation	8.3.2	8.4.0
2009-12	RAN#46	R5-096497	0533	-	GCF Priority 2 - Update of Idle Mode Operations test case 6.6.2.3.7	8.3.2	8.4.0
2009-12	RAN#46	R5-096502	0534	-	GCF Priority 2: Correction to the MAC DRX test cases preamble	8.3.2	8.4.0
2009-12	RAN#46	R5-096505	0535	-	GCF Priority 2 - Correction of TC 9.2.1.1.13	8.3.2	8.4.0

Date	TSG #	TSG Doc.	CR	Rev	Subject/Comment	Version Old	Version New
					Attach / rejected / PLMN not allowed		
2009-12	RAN#46	R5-096506	0536	-	GCF Priority 2 - Correction of TC 9.2.1.1.14 Attach / rejected / tracking area not allowed	8.3.2	8.4.0
2009-12	RAN#46	R5-096507	0537	-	GCF Priority 2 - Correction of TC 9.2.1.1.15 Attach / rejected / roaming not allowed in this tracking area	8.3.2	8.4.0
2009-12	RAN#46	R5-096508	0538	-	GCF Priority 3 - New TC 9.2.1.1.16 Attach / rejected / EPS services not allowed in this PLMN	8.3.2	8.4.0
2009-12	RAN#46	R5-096509	0539	-	GCF Priority 2 - Correction of TC 9.2.1.1.17 Attach / rejected / no suitable cells in tracking area	8.3.2	8.4.0
2009-12	RAN#46	R5-096510	0540	-	GCF Priority 2 - Correction of TC 9.2.1.2.4 Combined attach procedure / Success / EPS services only / MSC temporarily not reachable	8.3.2	8.4.0
2009-12	RAN#46	R5-096511	0541	-	GCF Priority 2 - Correction of TC 10.2.1 Dedicated EPS bearer context activation / Success	8.3.2	8.4.0
2009-12	RAN#46	R5-096512	0542	-	GCF Priority 2 - Correction of TC 10.3.1 EPS bearer context modification / Success	8.3.2	8.4.0
2009-12	RAN#46	R5-096514	0543	-	GCF Priority 2 - Correction of TC 10.6.1 UE requested PDN disconnect procedure accepted by the network	8.3.2	8.4.0
2009-12	RAN#46	R5-096605	0544	-	GCF Priority 2 - Update of RRC test case 8.3.2.7 : Measurement configuration control and reporting / inter-RAT measurements: event B2 (measurement HRPD cells)	8.3.2	8.4.0
2009-12	RAN#46	R5-096606	0545	-	GCF Priority 2 - Update of RRC test case 8.3.2.6	8.3.2	8.4.0
2009-12	RAN#46	R5-096610	0546	-	GCF Priority 2 - Update of RRC test case 8.4.1.4	8.3.2	8.4.0
2009-12	RAN#46	R5-096611	0547	-	GCF Priority 2 - Update of RRC test case 8.4.1.2	8.3.2	8.4.0
2009-12	RAN#46	R5-096612	0548	-	GCF Priority 2 - Update to test case 8.4.2.2	8.3.2	8.4.0
2009-12	RAN#46	R5-096613	0549	-	GCF Priority 2 - Update to test case 8.4.2.4	8.3.2	8.4.0
2009-12	RAN#46	R5-096615	0550	-	GCF Priority 3 - Addition of test case 6.2.3.6	8.3.2	8.4.0
2009-12	RAN#46	R5-096616	0551	-	GCF Priority 3 - Update to test case 8.1.1.2	8.3.2	8.4.0
2009-12	RAN#46	R5-096617	0552	-	GCF Priority 3 - Addition of test case 8.2.4.4	8.3.2	8.4.0
2009-12	RAN#46	R5-096618	0553	-	GCF Priority 2 - Update to test case 8.1.3.5	8.3.2	8.4.0
2009-12	RAN#46	R5-096619	0554	-	GCF Priority 2: Updates to TAU/RAU procedure for inter-system cell re-selection between A/Gb and S1 modes	8.3.2	8.4.0
2009-12	RAN#46	R5-096620	0555	-	GCF Priority 2: Updates to Attach Procedure / Success (last visited TAI, TAI list and equivalent PLMN list handling)	8.3.2	8.4.0
2009-12	RAN#46	R5-096621	0556	-	GCF Priority 2 - Correction to TC 8.1.3.8	8.3.2	8.4.0
2009-12	RAN#46	R5-096622	0557	-	GCF Priority 3 - Update test case 8.3.1.4	8.3.2	8.4.0
2009-12	RAN#46	R5-096627	0558	-	GCF Priority 1 - Update of RRC test case 8.2.2.1	8.3.2	8.4.0
2009-12	RAN#46	R5-096628	0559	-	GCF Priority 1 - Update of RRC test case 8.2.2.2	8.3.2	8.4.0
2009-12	RAN#46	R5-096629	0560	-	GCF Priority 3 - Various corrections to EMM section of 36.523-1	8.3.2	8.4.0
2009-12	RAN#46	R5-096630	0561	-	GCF Priority 3 - Addition of new test case 9.2.1.2.5	8.3.2	8.4.0
2009-12	RAN#46	R5-096631	0562	-	GCF Priority 3 - Update to test case 9.2.1.2.6	8.3.2	8.4.0
2009-12	RAN#46	R5-096632	0563	-	GCF Priority 3 - Addition of test case 9.2.1.2.7	8.3.2	8.4.0
2009-12	RAN#46	R5-096633	0564	-	GCF Priority 3 - Addition of test case 9.2.1.2.11	8.3.2	8.4.0
2009-12	RAN#46	R5-096634	0565	1	GCF Priority 3 - Addition of test case 9.2.1.2.13	8.3.2	8.4.0
2009-12	RAN#46	R5-096635	0566	-	GCF Priority 3 - Addition of new test case 9.2.1.2.15	8.3.2	8.4.0
2009-12	RAN#46	R5-096636	0567	-	GCF Priority 3 - Addition of test cases 9.2.3.1.23 and 9.2.3.1.24	8.3.2	8.4.0
2009-12	RAN#46	R5-096637	0568	-	GCF Priority 3 - Addition of new test case 9.2.3.1.25	8.3.2	8.4.0
2009-12	RAN#46	R5-096638	0569	-	GCF Priority 3 - Addition of new test case 9.2.3.2.9	8.3.2	8.4.0
2009-12	RAN#46	R5-096639	0570	-	GCF Priority 3 - Update to test case 9.3.1.4	8.3.2	8.4.0
2009-12	RAN#46	R5-096643	0571	-	GCF Priority 1 - Update of RLC test case 7.2.3.9	8.3.2	8.4.0
2009-12	RAN#46	R5-096645	0572	-	GCF Priority 3 - Addition of new test case 8.3.3.4	8.3.2	8.4.0
2009-12	RAN#46	R5-096646	0573	-	GCF Priority 3 - Addition of new test case	8.3.2	8.4.0

Date	TSG #	TSG Doc.	CR	Rev	Subject/Comment	Version Old	Version New
					8.3.3.5		
2009-12	RAN#46	R5-096647	0574	-	GCF Priority 3 - Addition of new test case 10.7.3	8.3.2	8.4.0
2009-12	RAN#46	R5-096648	0575	-	GCF Priority 3 - Addition of new test case 10.7.4	8.3.2	8.4.0
2009-12	RAN#46	R5-096649	0576	-	GCF Priority TBC - Addition of new test case 10.7.5	8.3.2	8.4.0
2009-12	RAN#46	R5-096650	0577	-	GCF Priority 3 - Addition of new test case 10.8.2	8.3.2	8.4.0
2009-12	RAN#46	R5-096651	0578	-	GCF Priority 3 - Addition of new test case 10.8.3	8.3.2	8.4.0
2009-12	RAN#46	R5-096652	0579	-	GCF Priority TBC - Addition of new test case 10.8.4	8.3.2	8.4.0
2009-12	RAN#46	R5-096653	0580	-	GCF Priority 3 - Addition of new test case 10.8.5	8.3.2	8.4.0
2009-12	RAN#46	R5-096654	0581	-	GCF Priority 3 - Addition of new test case 10.8.6	8.3.2	8.4.0
2009-12	RAN#46	R5-096655	0582	-	GCF Priority 3 - Addition of new test case 10.8.7	8.3.2	8.4.0
2009-12	RAN#46	R5-096656	0583	-	GCF Priority 2 - Correction of TC 10.5.1 UE requested PDN connectivity procedure accepted by the network	8.3.2	8.4.0
2009-12	RAN#46	R5-096657	0584	-	GCF Priority 2 - Addition of test case 11.1.4 MO-SMS over SGs in active mode	8.3.2	8.4.0
2009-12	RAN#46	R5-096658	0585	-	GCF Priority 2 - Correction of TC 10.4.1 EPS bearer context deactivation / Success	8.3.2	8.4.0
2009-12	RAN#46	R5-096660	0586	-	GCF Priority 3 - Addition of EMM test case 9.1.2.6	8.3.2	8.4.0
2009-12	RAN#46	R5-096661	0587	-	GCF Priority 3 - Addition of new EMM test case 9.1.5.2	8.3.2	8.4.0
2009-12	RAN#46	R5-096662	0588	-	GCF Priority 3 - Addition of new EMM test case 9.2.1.1.18	8.3.2	8.4.0
2009-12	RAN#46	R5-096663	0589	-	GCF Priority 3 - Addition of EMM test case 9.2.1.2.12	8.3.2	8.4.0
2009-12	RAN#46	R5-096665	0590	-	GCF Priority 3 - Addition of EMM test case 9.2.2.2.14	8.3.2	8.4.0
2009-12	RAN#46	R5-096666	0591	-	GCF Priority 3 - Addition of EMM test case 9.2.3.1.26	8.3.2	8.4.0
2009-12	RAN#46	R5-096667	0592	-	GCF Priority 3 - Addition of EMM test case 9.2.3.1.27	8.3.2	8.4.0
2009-12	RAN#46	R5-096668	0593	-	GCF Priority 3 - Addition of EMM test case 9.2.3.1.28	8.3.2	8.4.0
2009-12	RAN#46	R5-096669	0594	-	GCF Priority 3 - Addition of EMM test case 9.3.1.15	8.3.2	8.4.0
2009-12	RAN#46	R5-096670	0595	-	GCF Priority 3 - Addition of new test case 9.3.1.17	8.3.2	8.4.0
2009-12	RAN#46	R5-096671	0596	-	GCF Priority 3 - Correction of TC 9.2.1.2.2 Combined attach procedure / Success / EPS services only / IMSI unknown in HSS	8.3.2	8.4.0
2009-12	RAN#46	R5-096672	0597	-	GCF Priority 3 - Correction of TC 9.2.1.2.3 Combined attach procedure / Success / EPS services only / MSC temporarily not reachable	8.3.2	8.4.0
2009-12	RAN#46	R5-096673	0598	-	GCF Priority 3: Introduction of 9.2.3.1.19 Normal tracking area update / rejected / No Suitable Cells in tracking Area	8.3.2	8.4.0
2009-12	RAN#46	R5-096692	0599	-	GCF Priority 3 - Update of E-UTRAN test case 9.2.1.1.20	8.3.2	8.4.0
2009-12	RAN#46	R5-096693	0600	-	GCF Priority 3 - Correction of TC 9.2.1.1.19 Attach / Abnormal case / Failure due to non integrity protection	8.3.2	8.4.0
2009-12	RAN#46	R5-096694	0601	-	GCF Priority 3: Addition of new test case 9.2.1.1.21: Attach / Abnormal case / success after several attempts due to no network response	8.3.2	8.4.0
2009-12	RAN#46	R5-096695	0602	-	GCF Priority 3: Addition of new test case 9.2.1.1.22: : Attach / Abnormal case / unsuccessful attach after 5 attempts	8.3.2	8.4.0
2009-12	RAN#46	R5-096697	0603	1	GCF Priority 3 - Addition of test case 13.3.1.1	8.3.2	8.4.0
2010-03	RAN#47	R5-100058	0604	-	Addition of new DSMIPv6 test case for Registration of a new IPv6 CoA (Binding Update/Acknowledgment procedure in IPv6 network)	8.4.0	8.5.0
2010-03	RAN#47	R5-100059	0605	-	Addition of new DSMIPv6 test case for Re-	8.4.0	8.5.0

Date	TSG #	TSG Doc.	CR	Rev	Subject/Comment	Version Old	Version New
					registration of IPv6 CoA		
2010-03	RAN#47	R5-100060	0606	-	Addition of new DSMIPv6 test case for Return to home link	8.4.0	8.5.0
2010-03	RAN#47	R5-100061	0607	-	Addition of new DSMIPv6 test case for Dual-Stack Mobile IPv6 detach in IPv6 network	8.4.0	8.5.0
2010-03	RAN#47	R5-100089	0608	-	GCF priority 2 - Correction of test case 10.5.1 for UE requested PDN connectivity accepted by the network	8.4.0	8.5.0
2010-03	RAN#47	R5-100096	0609	-	GCF priority 3 - Correction of test case 9.2.1.2.2 for Combined attach procedure / Success / EPS services only / IMSI unknown in HSS	8.4.0	8.5.0
2010-03	RAN#47	R5-100100	0610	-	GCF priority 2: correction of test case 9.2.3.3.1 First lu mode to S1 mode intersystem change after attach: go to E-UTRAN RRC idle: RAU to UTRAN	8.4.0	8.5.0
2010-03	RAN#47	R5-100173	0611	-	Update of test case 9.2.3.1.28	8.4.0	8.5.0
2010-03	RAN#47	R5-100175	0612	-	Update of test case 9.1.5.2	8.4.0	8.5.0
2010-03	RAN#47	R5-100176	0613	-	Update of test case 9.1.2.6	8.4.0	8.5.0
2010-03	RAN#47	R5-100182	0614	-	Priority 2-Update of the case 6.2.2.1	8.4.0	8.5.0
2010-03	RAN#47	R5-100242	0615	-	GCF Priority 1: Update of MAC TC 7.1.2.3	8.4.0	8.5.0
2010-03	RAN#47	R5-100263	0616	-	Correction to MAC TBS selection TCs not to use RS power boosting	8.4.0	8.5.0
2010-03	RAN#47	R5-100270	0617	-	GCF Priority 1 - Update to test case 7.2.2.9	8.4.0	8.5.0
2010-03	RAN#47	R5-100271	0618	-	GCF Priority 3 - Update to test case 8.1.1.2	8.4.0	8.5.0
2010-03	RAN#47	R5-100274	0619	-	GCF Priority 2 - Update to test case 8.2.4.2	8.4.0	8.5.0
2010-03	RAN#47	R5-100275	0620	-	GCF Priority 3 - Update to test case 8.2.4.4	8.4.0	8.5.0
2010-03	RAN#47	R5-100276	0621	-	GCF Priority 2 - Update to test case 8.2.4.5	8.4.0	8.5.0
2010-03	RAN#47	R5-100277	0622	-	GCF Priority 2 - Update to test case 8.2.4.6	8.4.0	8.5.0
2010-03	RAN#47	R5-100278	0623	-	GCF Priority 2 - Update to test case 8.2.4.7	8.4.0	8.5.0
2010-03	RAN#47	R5-100279	0624	-	GCF Priority 3 - Update to test case 8.2.4.9	8.4.0	8.5.0
2010-03	RAN#47	R5-100281	0625	-	GCF Priority 2 - Update to test case 8.3.1.9	8.4.0	8.5.0
2010-03	RAN#47	R5-100283	0626	-	GCF Priority 2 - Update to test case 8.3.2.3	8.4.0	8.5.0
2010-03	RAN#47	R5-100284	0627	-	GCF Priority 2 - Update to test case 8.4.2.2	8.4.0	8.5.0
2010-03	RAN#47	R5-100285	0628	-	GCF Priority 2 - Update to test case 8.4.2.4	8.4.0	8.5.0
2010-03	RAN#47	R5-100287	0629	-	GCF Priority 3 - Update to test case 9.2.1.2.5	8.4.0	8.5.0
2010-03	RAN#47	R5-100288	0630	-	GCF Priority 3 - Update to test case 9.2.1.2.6	8.4.0	8.5.0
2010-03	RAN#47	R5-100289	0631	-	GCF Priority 3 - Update to test case 9.2.1.2.7	8.4.0	8.5.0
2010-03	RAN#47	R5-100290	0632	-	GCF Priority 3 - Update to test case 9.2.1.2.8	8.4.0	8.5.0
2010-03	RAN#47	R5-100293	0633	-	GCF Priority 3 - Update to test case 9.2.3.2.9	8.4.0	8.5.0
2010-03	RAN#47	R5-100294	0634	-	GCF Priority 3 - Update to test case 9.3.1.4	8.4.0	8.5.0
2010-03	RAN#47	R5-100383	0635	-	GCF Priority 1- Update of MAC test cases 7.1.4.6, 7.1.4.7, 7.1.4.8	8.4.0	8.5.0
2010-03	RAN#47	R5-100415	0636	-	GCF Priority 2 - Correction to remark in 6.2.2.1, 6.2.2.2 and 6.2.3.2	8.4.0	8.5.0
2010-03	RAN#47	R5-100416	0637	-	GCF Priority 2 - Correction to test case 6.1.2.6	8.4.0	8.5.0
2010-03	RAN#47	R5-100443	0638	-	GCF Priority 2: Update to test case 9.2.3.1.4	8.4.0	8.5.0
2010-03	RAN#47	R5-100462	0639	-	Correction of test case 8.3.1.3	8.4.0	8.5.0
2010-03	RAN#47	R5-100467	0640	-	Addition of new DSMIPv6 test case for Registration of a new IPv4 CoA (Binding Update/Acknowledgment procedure in IPv4 network)	8.4.0	8.5.0
2010-03	RAN#47	R5-100468	0641	-	Addition of new DSMIPv6 test case for Re-registration of IPv4 CoA	8.4.0	8.5.0
2010-03	RAN#47	R5-100469	0642	-	Addition of new DSMIPv6 test case for Dual-Stack Mobile IPv6 detach in IPv4 network	8.4.0	8.5.0
2010-03	RAN#47	R5-100470	0643	-	GCF Priority 2 - Update to P2 EMM test case 9.2.2.1.1	8.4.0	8.5.0
2010-03	RAN#47	R5-100471	0644	-	Update to P3 EMM test case 9.2.2.1.2	8.4.0	8.5.0
2010-03	RAN#47	R5-100472	0645	-	GCF Priority 2 - Update to P2 EMM test case 9.2.2.1.6	8.4.0	8.5.0
2010-03	RAN#47	R5-100475	0646	-	Removal of TC 10.5.2	8.4.0	8.5.0
2010-03	RAN#47	R5-100488	0647	-	GCF priority 1 - Update of RRC test case 8.2.2.1	8.4.0	8.5.0
2010-03	RAN#47	R5-100489	0648	-	GCF priority 1 - Update of RRC test case 8.2.2.2	8.4.0	8.5.0
2010-03	RAN#47	R5-100492	0649	-	GCF priority 1 - Update of RRC test case 8.2.3.1	8.4.0	8.5.0
2010-03	RAN#47	R5-100500	0650	-	GCF Priority 1: Clarification to UE initial state for test case 7.1.2.6	8.4.0	8.5.0
2010-03	RAN#47	R5-100501	0651	-	GCF Priority 2 - Clarification to UE initial state	8.4.0	8.5.0
2010-03	RAN#47	R5-100537	0652	-	GCF Priority 1 - Correction to E-UTRA RLC test	8.4.0	8.5.0

Date	TSG #	TSG Doc.	CR	Rev	Subject/Comment	Version Old	Version New
					case 7.2.3.21		
2010-03	RAN#47	R5-100577	0653	-	GCF Priority 1 - Correction to E-UTRAN MAC test case 7.1.2.3	8.4.0	8.5.0
2010-03	RAN#47	R5-100582	0654	-	GCF Priority 1 - Correction to E-UTRAN MAC test case 7.1.4.7	8.4.0	8.5.0
2010-03	RAN#47	R5-100592	0655	-	GCF Priority 3 - Correction to P3 EMM test case 9.2.1.2.12	8.4.0	8.5.0
2010-03	RAN#47	R5-100625	0656	-	GCF Priority 1: Corrections to E-UTRA MAC test case 7.1.7.1.1	8.4.0	8.5.0
2010-03	RAN#47	R5-100638	0657	-	GCF Priority 1 - Update of RLC test case 7.2.2.5.2	8.4.0	8.5.0
2010-03	RAN#47	R5-100639	0658	-	GCF Priority 1 - Update of RLC test case 7.2.2.6	8.4.0	8.5.0
2010-03	RAN#47	R5-100642	0659	-	GCF Priority 1 - Update of RLC test case 7.2.2.7	8.4.0	8.5.0
2010-03	RAN#47	R5-100651	0660	-	GCF Priority 1 - Update of RLC test case 7.2.3.2	8.4.0	8.5.0
2010-03	RAN#47	R5-100652	0661	-	GCF Priority 1 - Update of RLC test case 7.2.3.3	8.4.0	8.5.0
2010-03	RAN#47	R5-100657	0662	-	GCF Priority 1 - Update of RLC test case 7.2.3.5	8.4.0	8.5.0
2010-03	RAN#47	R5-100659	0663	-	GCF Priority 1 - Update of RLC test case 7.2.3.6	8.4.0	8.5.0
2010-03	RAN#47	R5-100671	0664	-	GCF Priority 1: Corrections to E-UTRA MAC test case 7.1.7.1.2	8.4.0	8.5.0
2010-03	RAN#47	R5-100676	0665	-	GCF Priority 1: Corrections to E-UTRA MAC test case 7.1.7.1.3	8.4.0	8.5.0
2010-03	RAN#47	R5-100738	0666	-	Priority 2 - Incorrect ATTACH procedure to UTRAN and GERAN cells	8.4.0	8.5.0
2010-03	RAN#47	R5-100741	0667	-	GCF Priority x - Clarification to E-UTRA Radio Bearer Tests section	8.4.0	8.5.0
2010-03	RAN#47	R5-100742	0668	-	Priority 3 - TC 9.2.3.1.15 Normal tracking area update / rejected / PLMN not allowed - problems with Test procedure sequence	8.4.0	8.5.0
2010-03	RAN#47	R5-100745	0669	-	GCF Priority 3 - Adding new TC 9.1.5.1 EMM Information Procedure	8.4.0	8.5.0
2010-03	RAN#47	R5-100777	0670	-	GCF Priority 2 - Update of MAC test case 7.1.4.3	8.4.0	8.5.0
2010-03	RAN#47	R5-101011	0671	-	Priority ALL - Update of section 6 Idle Mode Operations to comply with RAN5 PRD13	8.4.0	8.5.0
2010-03	RAN#47	R5-101012	0672	-	Priority ALL - Update of section 9.1.x and 9.2.1.x to indicate on which cell events are to be observed in multi cell environment	8.4.0	8.5.0
2010-03	RAN#47	R5-101013	0673	-	GCF Priority 2 - Removal of test case 9.2.3.2.3	8.4.0	8.5.0
2010-03	RAN#47	R5-101014	0674	-	GCF Priority 2 - Update to test case 9.2.3.2.3	8.4.0	8.5.0
2010-03	RAN#47	R5-101032	0675	2	GCF Priority 2 - Correction of RRC test cases 8.3.1.3 and 8.3.1.5	8.4.0	8.5.0
2010-03	RAN#47	R5-101033	0676	1	GCF Priority 3 - Correction of RRC test cases 8.3.1.7 and 8.3.1.11	8.4.0	8.5.0
2010-03	RAN#47	R5-101038	0677	-	Correction of test case 6.2.3.13	8.4.0	8.5.0
2010-03	RAN#47	R5-101039	0678	-	Correction for Measurement related test cases	8.4.0	8.5.0
2010-03	RAN#47	R5-101053	0679	-	GCF priority 2 - Update of RRC test case 8.2.1.3	8.4.0	8.5.0
2010-03	RAN#47	R5-101056	0680	-	Priority ALL - Update of section 7 Layer 2 to comply with RAN5 PRD13	8.4.0	8.5.0
2010-03	RAN#47	R5-101057	0681	-	GCF Priority 1 - Various corrections to Idle Mode section 6.1 of 36.523-1	8.4.0	8.5.0
2010-03	RAN#47	R5-101062	0682	-	GCF Priority 1 - Correction to E-UTRAN PDPC test case 7.1.4.4	8.4.0	8.5.0
2010-03	RAN#47	R5-101063	0683	-	GCF Priority 1: Update of MAC TC 7.1.2.5	8.4.0	8.5.0
2010-03	RAN#47	R5-101064	0684	-	GCF Priority 1: Update of MAC TC 7.1.2.6	8.4.0	8.5.0
2010-03	RAN#47	R5-101065	0685	-	GCF Priority 1: Update of MAC TC 7.1.2.9	8.4.0	8.5.0
2010-03	RAN#47	R5-101066	0686	-	GCF Priority 1: Update of MAC TC 7.1.3.9	8.4.0	8.5.0
2010-03	RAN#47	R5-101067	0687	-	GCF Priority 1: Update of MAC TC 7.1.4.8	8.4.0	8.5.0
2010-03	RAN#47	R5-101068	0688	-	GCF Priority 1: Update of MAC TC 7.1.4.11	8.4.0	8.5.0
2010-03	RAN#47	R5-101069	0689	-	GCF Priority 3 - Corrections to TC 8.5.1.2 RRC Connection Re-establishment: Success (after Radio Link Failure)	8.4.0	8.5.0
2010-03	RAN#47	R5-101070	0690	-	GCF Priority 1 - Correction to E-UTRAN MAC test case 7.1.4.13	8.4.0	8.5.0
2010-03	RAN#47	R5-101074	0691	-	New priority 3 test case: Periodic Location Updating Procedure (PLU Timer handling, non-cell reselection to GERAN)	8.4.0	8.5.0

Date	TSG #	TSG Doc.	CR	Rev	Subject/Comment	Version Old	Version New
2010-03	RAN#47	R5-101075	0692	-	GCF Priority 3 - Addition of new test case 9.2.3.3.4	8.4.0	8.5.0
2010-03	RAN#47	R5-101076	0693	-	GCF Priority 1 - Correction to E-UTRAN MAC test case 7.1.3.4	8.4.0	8.5.0
2010-03	RAN#47	R5-101077	0694	-	GCF Priority 1: Update of MAC TC 7.1.4.15	8.4.0	8.5.0
2010-03	RAN#47	R5-101078	0695	-	GCF Priority 1 - Update of MAC Procedures part TC 7.1.2.2	8.4.0	8.5.0
2010-03	RAN#47	R5-101079	0696	-	GCF Priority 1 - Correction to MAC test case 7.1.4.10	8.4.0	8.5.0
2010-03	RAN#47	R5-101081	0697	-	GCF Priority 1 - Update to test case 8.2.4.1	8.4.0	8.5.0
2010-03	RAN#47	R5-101082	0698	-	GCF Priority 2 - Update to test case 8.3.1.8	8.4.0	8.5.0
2010-03	RAN#47	R5-101083	0699	-	GCF Priority 2 - Update to test case 8.3.1.10	8.4.0	8.5.0
2010-03	RAN#47	R5-101084	0700	-	GCF Priority 1: Corrections to E-UTRA MAC test case 7.1.7.1.4	8.4.0	8.5.0
2010-03	RAN#47	R5-101085	0701	-	GCF Priority 1 - Update of Acknowledged Mode Procedures part TC 7.2.3.15 AM RLC / Re-ordering of RLC PDU segments"	8.4.0	8.5.0
2010-03	RAN#47	R5-101086	0702	-	GCF Priority 1 - Update of RLC test case 7.2.3.14	8.4.0	8.5.0
2010-03	RAN#47	R5-101087	0703	-	GCF Priority 1 - Update of RLC test case 7.2.3.4	8.4.0	8.5.0
2010-03	RAN#47	R5-101088	0704	-	GCF Priority 1 - Update of RLC test case 7.2.3.1	8.4.0	8.5.0
2010-03	RAN#47	R5-101089	0705	1	GCF Priority 1 - Update of RLC test case 7.2.3.7	8.4.0	8.5.0
2010-03	RAN#47	R5-101090	0706	2	GCF Priority 1 - Update of RLC test case 7.2.3.18	8.4.0	8.5.0
2010-03	RAN#47	R5-101092	0707	-	GCF priority 2 - EPS bearer context ID values and RRC messages carrying ESM messages for EPS bearer context (de)activation and modification	8.4.0	8.5.0
2010-03	RAN#47	R5-101093	0708	-	GCF priority 3 - Small correction to TC 9.2.1.1.11 Attach / rejected / EPS services and non-EPS services not allowed	8.4.0	8.5.0
2010-03	RAN#47	R5-101094	0709	-	GCF priority 2 - Correction of test case 9.2.1.1.15 for Attach / rejected / roaming not allowed in this tracking area	8.4.0	8.5.0
2010-03	RAN#47	R5-101098	0710	-	GCF Priority 2 - Update test case 8.5.1.3	8.4.0	8.5.0
2010-03	RAN#47	R5-101105	0711	-	GCF priority 1 - Update of RRC test case 8.2.1.1	8.4.0	8.5.0
2010-03	RAN#47	R5-101108	0712	-	GCF Priority 2 - Correction to EUTRAN RLC test case 7.2.2.10	8.4.0	8.5.0
2010-03	RAN#47	R5-101110	0713	-	GCF priority 2 - Correction of test case 9.2.1.2.4 for Successful combined attach procedure, EPS service only / CS domain not available	8.4.0	8.5.0
2010-03	RAN#47	R5-101113	0714	-	GCF Priority 1 - Correction to E-UTRA PDCP test case 7.3.4.1 and 7.3.4.2	8.4.0	8.5.0
2010-03	RAN#47	R5-101114	0715	-	GCF Priority 1 - Enhancement test case 8.1.2.1	8.4.0	8.5.0
2010-03	RAN#47	R5-101117	0716	-	GCF Priority 1 - Correction to EMM test cases to bring the UE to stable state at the end of expected sequence	8.4.0	8.5.0
2010-03	RAN#47	R5-101118	0717	-	GCF Priority 1 - Update of Multi-layer Procedures part TC 13.1.1 Activation and deactivation of additional data radio bearer in E-UTRA	8.4.0	8.5.0
2010-03	RAN#47	R5-101119	0718	-	GCF Priority 1 - Update of Multi-layer Procedures part TC 13.2.1 RRC Connection Reconfiguration: E-UTRA to E-UTRA	8.4.0	8.5.0
2010-03	RAN#47	R5-101120	0719	-	GCF Priority 2: Update of MAC TC 7.1.3.2	8.4.0	8.5.0
2010-03	RAN#47	R5-101121	0720	-	GCF Priority 1 - Correction to EPC test case 9.2.1.1.1	8.4.0	8.5.0
2010-03	RAN#47	R5-101122	0721	-	Priority 2 - section 9 alignment IP handling at wrong place - Missing security activation - Editorial changes	8.4.0	8.5.0
2010-03	RAN#47	R5-101125	0722	-	GCF Priority 1 - Correction to E-UTRAN RLC test case 7.2.3.15	8.4.0	8.5.0
2010-03	RAN#47	R5-101126	0723	-	GCF Priority 1 - Correction to E-UTRAN RLC test case 7.2.3.9	8.4.0	8.5.0
2010-03	RAN#47	R5-101130	0724	-	GCF Priority 1 - Correction of RRC test case 8.3.3.1	8.4.0	8.5.0
2010-03	RAN#47	R5-101131	0725	1	GCF Priority 1 - Correction to MAC test cases to bring the UE to stable state at the end of	8.4.0	8.5.0

Date	TSG #	TSG Doc.	CR	Rev	Subject/Comment	Version Old	Version New
					expected sequence		
2010-03	RAN#47	R5-101132	0726	-	GCF Priority 1 - Correction to RRC test cases to bring the UE to stable state at the end of expected sequence	8.4.0	8.5.0
2010-03	RAN#47	R5-101133	0727	-	GCF Priority 2 - Update to test case 10.7.1	8.4.0	8.5.0
2010-03	RAN#47	R5-101134	0728	-	GCF Priority 2 - Update to test case 10.7.2	8.4.0	8.5.0
2010-03	RAN#47	R5-101135	0729	-	GCF Priority 2 - Update to test case 10.8.1	8.4.0	8.5.0
2010-03	RAN#47	R5-101141	0730	-	GCF Priority 4 - Addition of new RRC test case 8.4.7.1	8.4.0	8.5.0
2010-03	RAN#47	R5-101142	0731	-	GCF Priority 4 - Addition of new RRC test case 8.3.2.10	8.4.0	8.5.0
2010-03	RAN#47	R5-101145	0732	-	General note for test cases with statistical behaviour	8.4.0	8.5.0
2010-03	RAN#47	R5-101148	0733	-	GCF Priority 3 - Update to test case 10.7.3	8.4.0	8.5.0
2010-03	RAN#47	R5-101149	0734	-	GCF Priority 3 - Update to test case 10.7.4	8.4.0	8.5.0
2010-03	RAN#47	R5-101151	0735	-	GCF Priority 3 - Update to test case 10.8.2	8.4.0	8.5.0
2010-03	RAN#47	R5-101152	0736	-	GCF Priority 3 - Update to test case 10.8.3	8.4.0	8.5.0
2010-03	RAN#47	R5-101154	0737	-	GCF Priority 3 - Update to test case 10.8.5	8.4.0	8.5.0
2010-03	RAN#47	R5-101155	0738	-	GCF Priority 3 - Update to test case 10.8.6	8.4.0	8.5.0
2010-03	RAN#47	R5-101156	0739	-	GCF Priority 3 - Update to test case 10.8.7	8.4.0	8.5.0
2010-03	RAN#47	R5-101158	0740	-	GCF Priority 3: New PUSCH-Hopping test case 7.1.5.2: Predefined intra-TTI PUSCH hopping (N _{sb} =1)	8.4.0	8.5.0
2010-03	RAN#47	R5-101160	0741	-	GCF Priority 3: New PUSCH-Hopping test case 7.1.5.4: Predefined inter-TTI PUSCH hopping (N _{sb} =1)	8.4.0	8.5.0
2010-03	RAN#47	R5-101162	0742	1	GCF priority 3 - New test case 8.1.1.6 RRC / BCCH modification in connected mode	8.4.0	8.5.0
2010-03	RAN#47	R5-101163	0743	-	GCF Priority 3 - New TC 8.5.2.1 RRC Connection Reject: redirection from UTRAN to E-UTRAN	8.4.0	8.5.0
2010-03	RAN#47	R5-101164	0744	-	GCF Priority 3 - addition of new EMM test case 9.2.1.2.14	8.4.0	8.5.0
2010-03	RAN#47	R5-101165	0745	-	Update of test case 9.3.1.15	8.4.0	8.5.0
2010-03	RAN#47	R5-101166	0746	-	Update of test case 9.2.1.1.18	8.4.0	8.5.0
2010-03	RAN#47	R5-101167	0747	-	GCF Priority 3: Update to test case 9.2.3.1.6	8.4.0	8.5.0
2010-03	RAN#47	R5-101168	0748	-	GCF priority 3 - Correction of test case 10.5.3 for UE requested PDN connectivity procedure not accepted	8.4.0	8.5.0
2010-03	RAN#47	R5-101169	0749	-	GCF Priority 3 - Addition of new multi-layer test case 13.1.3	8.4.0	8.5.0
2010-03	RAN#47	R5-101170	0750	-	GCF Priority 3 - Addition of new test case 13.4.1.2	8.4.0	8.5.0
2010-03	RAN#47	R5-101171	0751	-	GCF Priority 3 - Update of Multi-layer Procedures part TC 13.3.1.1 Intra System Connection Reestablishment / Radio Link Recovery while T310 is running	8.4.0	8.5.0
2010-03	RAN#47	R5-101172	0752	-	GCF Priority 3 - update of test case 13.3.1.2	8.4.0	8.5.0
2010-03	RAN#47	R5-101173	0753	-	GCF Priority 2 : Correction to MAC test case 7.1.6.1	8.4.0	8.5.0
2010-03	RAN#47	R5-101174	0754	-	GCF Priority 2 : Correction to MAC test cases 7.1.6.2	8.4.0	8.5.0
2010-03	RAN#47	R5-101175	0755	2	GCF Priority 1 - Correction to E-UTRAN RLC test case 7.2.3.10	8.4.0	8.5.0
2010-03	RAN#47	R5-101177	0756	-	Update to GCF Priority 1 layer 2 UM test cases to increase the drx-Inactivity Timer to psf200	8.4.0	8.5.0
2010-03	RAN#47	R5-101179	0757	-	GCF Priority 1 - Enhancement and update to MAC test case 7.1.4.6	8.4.0	8.5.0
2010-03	RAN#47	R5-101183	0758	-	GCF Priority 1: Update of MAC TC 7.1.3.6	8.4.0	8.5.0
2010-03	RAN#47	R5-101186	0759	-	Update of test case and section titles	8.4.0	8.5.0
2010-03	RAN#47	R5-101189	0760	-	GCF Priority 2 - Update to test case 8.1.2.7	8.4.0	8.5.0
2010-03	RAN#47	R5-101190	0761	-	GCF Priority 2 - Update to test case 8.1.2.5	8.4.0	8.5.0
2010-03	RAN#47	R5-101191	0762	-	Corrections related to UE mode of operation and UE capability for CS fallback and SMS over SGs	8.4.0	8.5.0
2010-03	RAN#47	R5-101192	0763	-	GCF priority 3 - Correction of test case 10.6.2 for UE requested PDN disconnect procedure not accepted by the network	8.4.0	8.5.0
2010-03	GERAN#45	GP-100543	0605	-	Addition of new Test Case 6.2.3.22	8.4.0	8.5.0
2010-03	RAN#47	-	-	-	Moved to v9.0.0 with no change	8.5.0	9.0.0
2010-05	GERAN#46	GP-100625	0764	-	New Test case 6.2.3.28- Inter-RAT Cell Reselection from GPRS Packet_transfer to E-	9.0.0	9.1.0

Date	TSG #	TSG Doc.	CR	Rev	Subject/Comment	Version Old	Version New
					UTRA Cell (Network Assisted Cell Change)		
2010-05	GERAN#46	GP-100626	0765	-	New Test Case 6.2.3.30 - Inter-RAT Cell Reselection failure from GPRS Packet transfer to E-UTRA (Network Assisted Cell Change)	9.0.0	9.1.0
2010-05	GERAN#46	GP-100649	0766	-	New Test Case 6.2.2.6 - Inter-RAT Cell selection / From GSM_Idle/GPRS Packet_idle to E-UTRA_RRC_IDLE / Serving cell becomes non-suitable (ServingCell<0)	9.0.0	9.1.0
2010-05	GERAN#46	GP-100650	0767	-	New Test Case 6.2.2.7 - Inter-RAT Cell selection / From GSM_Idle/GPRS Packet_idle to E-UTRA_RRC_IDLE , when the serving cell is barred.	9.0.0	9.1.0
2010-06	RAN#48	R5-103077	0768	-	GCF Priority 2 - Correction of Minimum Cell Configuration	9.0.0	9.1.0
2010-06	RAN#48	R5-103086	0769	-	GCF Priority 3: New TC 9.3.1.5 Service request / Rejected / Illegal ME	9.0.0	9.1.0
2010-06	RAN#48	R5-103087	0770	-	GCF Priority 1 - Correction to E-UTRAN MAC test case 7.1.2.3	9.0.0	9.1.0
2010-06	RAN#48	R5-103088	0771	-	GCF Priority 1 - Correction to MAC test case 7.1.4.10	9.0.0	9.1.0
2010-06	RAN#48	R5-103089	0772	-	GCF Priority 3 - Update of TC 9.1.5.1 EMM Information Procedure	9.0.0	9.1.0
2010-06	RAN#48	R5-103090	0773	-	GCF Priority 2 - Correction to TC 9.1.2.4 Authentication not accepted by the UE / MAC code failure	9.0.0	9.1.0
2010-06	RAN#48	R5-103091	0774	-	GCF Priority 2 - Correction to TC 9.1.2.5 Authentication not accepted by the UE / SQN failure	9.0.0	9.1.0
2010-06	RAN#48	R5-103093	0775	-	GCF Priority 2 - Correction of SIB in RRC TCs 8.4.2.2 and 8.4.2.4	9.0.0	9.1.0
2010-06	RAN#48	R5-103130	0776	-	GCF Priority 2 - Update to test case 6.1.2.6	9.0.0	9.1.0
2010-06	RAN#48	R5-103131	0777	-	GCF Priority 1 - Correction to PDSCH power allocation of MAC TBS selection TCs	9.0.0	9.1.0
2010-06	RAN#48	R5-103132	0778	-	GCF Priority 3 - Correction of test case 6.2.3.13	9.0.0	9.1.0
2010-06	RAN#48	R5-103135	0779	-	GCF Priority 4 - Addition of new test case 8.3.2.2	9.0.0	9.1.0
2010-06	RAN#48	R5-103136	0780	-	GCF Priority 4 - Update test case 8.3.2.4	9.0.0	9.1.0
2010-06	RAN#48	R5-103137	0781	-	GCF Priority 4 - Addition of new test case 8.3.2.5	9.0.0	9.1.0
2010-06	RAN#48	R5-103139	0782	-	GCF Priority 3 - Correction for test case 13.4.1.2	9.0.0	9.1.0
2010-06	RAN#48	R5-103140	0783	-	GCF Priority 3 - Addition of new test case 13.4.2.1	9.0.0	9.1.0
2010-06	RAN#48	R5-103141	0784	-	GCF Priority 2 - Update test case 6.1.2.11 & 6.1.2.15	9.0.0	9.1.0
2010-06	RAN#48	R5-103144	0785	-	GCF Priority 4 Addition of new test case 14.1	9.0.0	9.1.0
2010-06	RAN#48	R5-103145	0786	-	GCF Priority 4 Addition of new test case 14.2	9.0.0	9.1.0
2010-06	RAN#48	R5-103157	0787	-	GCF Priority 4: New MAC TBS test case 7.1.7.1.6:DCI format 2A / RA type 1	9.0.0	9.1.0
2010-06	RAN#48	R5-103158	0788	-	GCF Priority 4: New MAC TBS test case 7.1.7.1.5:DCI format 2A / RA type 0	9.0.0	9.1.0
2010-06	RAN#48	R5-103159	0789	-	GCF Priority 4: Correction to E-UTRA DRB test case 12.3.1	9.0.0	9.1.0
2010-06	RAN#48	R5-103160	0790	-	GCF Priority 4: Correction to E-UTRA DRB test case 12.3.2	9.0.0	9.1.0
2010-06	RAN#48	R5-103161	0791	-	GCF Priority 4: Correction to E-UTRA DRB test case 12.3.3	9.0.0	9.1.0
2010-06	RAN#48	R5-103162	0792	-	GCF Priority 4: Correction to E-UTRA DRB test case 12.3.4	9.0.0	9.1.0
2010-06	RAN#48	R5-103163	0793	-	GCF Priority 4: Correction to generic test procedure 12.1.2 for E-UTRA DRB MIMO test cases	9.0.0	9.1.0
2010-06	RAN#48	R5-103228	0794	-	GCF Priority 4: New PUSCH-Hopping test case 7.1.5.1: Inter-TTI PUSCH hopping by uplink grant	9.0.0	9.1.0
2010-06	RAN#48	R5-103230	0795	-	GCF Priority 4: New PUSCH-Hopping test case 7.1.5.3: Predefined intra-TTI PUSCH hopping (N_sb=2/3/4)	9.0.0	9.1.0
2010-06	RAN#48	R5-103231	0796	-	GCF Priority 4: New PUSCH-Hopping test case 7.1.5.5: Predefined inter-TTI PUSCH hopping (N_sb=2/3/4)	9.0.0	9.1.0
2010-06	RAN#48	R5-103240	0797	-	GCF Priority 2 - Update to test case 8.1.2.7	9.0.0	9.1.0
2010-06	RAN#48	R5-103241	0798	-	GCF Priority 3 - Update to test case 9.2.3.1.23	9.0.0	9.1.0

Date	TSG #	TSG Doc.	CR	Rev	Subject/Comment	Version Old	Version New
2010-06	RAN#48	R5-103242	0799	-	GCF Priority 1 - Clarification of the cells where the messages are observed in EMM test cases	9.0.0	9.1.0
2010-06	RAN#48	R5-103243	0800	-	GCF Priority 4 - Update to test case 10.7.5	9.0.0	9.1.0
2010-06	RAN#48	R5-103244	0801	-	GCF Priority 4 - Update to test case 10.8.4	9.0.0	9.1.0
2010-06	RAN#48	R5-103246	0802	-	Applicability of new TC 13.1.5	9.0.0	9.1.0
2010-06	RAN#48	R5-103271	0803	-	GCF Priority 3 - Update of RRC part TC 8.5.1.2 Radio link failure / T301 expiry	9.0.0	9.1.0
2010-06	RAN#48	R5-103272	0804	-	GCF Priority 4 - Addition of new EPS mobility management procedure test case 9.2.3.2.7 Combined tracking area update / Rejected / EPS services and non-EPS services not allowed	9.0.0	9.1.0
2010-06	RAN#48	R5-103273	0805	-	GCF Priority 3 - Update Multi-layer test cases 13.3.1.1	9.0.0	9.1.0
2010-06	RAN#48	R5-103276	0806	-	GCF Priority 2 - Correct the Test Purpose 2 of PDCP part TC 7.3.1.2 and 7.3.1.3	9.0.0	9.1.0
2010-06	RAN#48	R5-103277	0807	-	GCF Priority 1 - Correct PDCP part TC 7.3.1.1	9.0.0	9.1.0
2010-06	RAN#48	R5-103278	0808	-	GCF Priority 4 - Addition of new EPS mobility management procedure test case 9.2.3.2.7	9.0.0	9.1.0
2010-06	RAN#48	R5-103302	0809	-	GCF Priority 1: Correction to test case 7.1.3.9	9.0.0	9.1.0
2010-06	RAN#48	R5-103303	0810	-	GCF Priority 1: Correction to E-UTRA MAC test case 7.1.2.1	9.0.0	9.1.0
2010-06	RAN#48	R5-103304	0811	-	GCF Priority 1: Correction to EMM test case 9.2.3.1.1	9.0.0	9.1.0
2010-06	RAN#48	R5-103307	0812	-	GCF Priority 1: Correction to EMM test case 9.2.1.1.1	9.0.0	9.1.0
2010-06	RAN#48	R5-103308	0813	-	GCF Priority 1: Correction to EMM test case 9.2.2.2.1	9.0.0	9.1.0
2010-06	RAN#48	R5-103313	0814	-	GCF Priority 1: Correction to EUTRA MAC test cases 7.1.7.1 test cases	9.0.0	9.1.0
2010-06	RAN#48	R5-103321	0815	-	GCF Priority 2: Correction to EUTRA PDCP test case 7.3.6.1	9.0.0	9.1.0
2010-06	RAN#48	R5-103323	0816	-	GCF Priority 2: Correction to EUTRA RRC test case 8.5.1.5	9.0.0	9.1.0
2010-06	RAN#48	R5-103327	0817	-	GCF Priority 2: Correction to EPC test case 9.2.2.1.1	9.0.0	9.1.0
2010-06	RAN#48	R5-103341	0818	-	GCF Priority 2: Adding UE pre-conditions for UE to be configured for combined EPS/IMSI attach in 9.2.3.2.x combined TAU test cases	9.0.0	9.1.0
2010-06	RAN#48	R5-103364	0819	-	GCF Priority 2 - Correction to generic test procedure reference in Idle mode section	9.0.0	9.1.0
2010-06	RAN#48	R5-103365	0820	-	GCF Priority 2 - Correction to TC 8.1.3.7 RRC connection release / Redirection from UTRAN to E-UTRAN	9.0.0	9.1.0
2010-06	RAN#48	R5-103367	0821	-	GCF Priority 3 - Correction to TC 8.5.2.1 RRC Connection Reject / Redirection from UTRAN to E-UTRAN	9.0.0	9.1.0
2010-06	RAN#48	R5-103394	0822	-	GCF Priority 4 - New TC 9.3.1.18 Service Reject CSG not authorized	9.0.0	9.1.0
2010-06	RAN#48	R5-103413	0823	-	GCF Priority 4 - Addition of new test case 8.4.3.2	9.0.0	9.1.0
2010-06	RAN#48	R5-103414	0824	-	GCF Priority 4 - Addition of new test case 8.4.3.3	9.0.0	9.1.0
2010-06	RAN#48	R5-103416	0825	-	Priority 4 - Addition of test case 9.2.3.2.17	9.0.0	9.1.0
2010-06	RAN#48	R5-103418	0826	-	Priority 4 - Addition of new test case 9.2.3.2.4	9.0.0	9.1.0
2010-06	RAN#48	R5-103419	0827	-	Priority 4 - Addition of new test case 9.2.3.2.14	9.0.0	9.1.0
2010-06	RAN#48	R5-103420	0828	-	Priority 4 - Addition of new test case 9.2.3.2.8	9.0.0	9.1.0
2010-06	RAN#48	R5-103421	0829	-	Priority 3 - update of test case 9.2.2.2.14	9.0.0	9.1.0
2010-06	RAN#48	R5-103456	0830	-	GCF Priority 4 - New TC 9.2.3.3.2 Iu mode to S1 mode intersystem change / ISR is active / Expiry of T3312 in E-UTRAN or T3412 in UTRAN and further intersystem change	9.0.0	9.1.0
2010-06	RAN#48	R5-103457	0831	-	GCF Priority 4 - New test case 6.1.2.10 Cell reselection in shared network environment	9.0.0	9.1.0
2010-06	RAN#48	R5-103458	0832	-	GCF Priority 4 - New Test case 6.1.2.12 Cell reselection / Cell-specific reselection parameters provided by the network in a neighbouring cell list	9.0.0	9.1.0
2010-06	RAN#48	R5-103459	0833	-	GCF Priority 4 - addition of new test case	9.0.0	9.1.0

Date	TSG #	TSG Doc.	CR	Rev	Subject/Comment	Version Old	Version New
					6.1.1.4: PLMN selection in shared network environment / Automatic mode		
2010-06	RAN#48	R5-103463	0834	-	GCF Priority 3 - Addition of new EMM test case 9.2.2.1.7	9.0.0	9.1.0
2010-06	RAN#48	R5-103464	0835	-	GCF Priority 3 - Addition of new EMM test case 9.2.2.1.8	9.0.0	9.1.0
2010-06	RAN#48	R5-103465	0836	-	GCF Priority 3 - Addition of new EMM test case 9.2.2.1.9	9.0.0	9.1.0
2010-06	RAN#48	R5-103486	0837	-	GCF Priority 2 Correction to test case 6.1.2.3, 6.2.3.1 & 6.2.3.6	9.0.0	9.1.0
2010-06	RAN#48	R5-103498	0838	-	GCF Priority 2 to 3 - Correction to RRC part 3 test cases	9.0.0	9.1.0
2010-06	RAN#48	R5-103513	0839	-	GCF Priority 2 - Update of RRC test case 8.2.4.5	9.0.0	9.1.0
2010-06	RAN#48	R5-103514	0840	-	GCF Priority 3 - New EMM test case 9.2.2.1.3	9.0.0	9.1.0
2010-06	RAN#48	R5-103573	0841	-	Addition of new DSMIPv6 test case for Discovery of the Home Agent address via DHCPv6	9.0.0	9.1.0
2010-06	RAN#48	R5-103579	0842	-	Addition of new DSMIPv6 test case for Security association establishment with Home Agent reallocation procedure	9.0.0	9.1.0
2010-06	RAN#48	R5-103646	0843	-	GCF Priority 2 - Corrections to C2K TCs 8.3.2.7, 8.3.2.8 and 8.3.2.9	9.0.0	9.1.0
2010-06	RAN#48	R5-103649	0844	-	Addition of new DSMIPv6 test case for Discovery of the Home Agent address via IKEv2 during tunnel setup to ePDG	9.0.0	9.1.0
2010-06	RAN#48	R5-103676	0845	-	GCF Priority 4 - Addition of test case 8.2.4.10 RRC Connection Reconfiguration / Handover (between FDD and TDD)	9.0.0	9.1.0
2010-06	RAN#48	R5-103696	0846	-	GCF Priority 1 - Correction to MAC, RRC and EMM test cases to bring the UE to stable state at the end of test	9.0.0	9.1.0
2010-06	RAN#48	R5-103697	0847	-	GCF Priority 1: Correction to EUTRA MAC test case 7.1.4.8	9.0.0	9.1.0
2010-06	RAN#48	R5-103698	0848	-	GCF Priority 1: Correction to test case 7.1.4.11	9.0.0	9.1.0
2010-06	RAN#48	R5-103800	0880	1	GCF Priority 1: Correction to EUTRA RLC test case 7.2.3.6	9.0.0	9.1.0
2010-06	RAN#48	R5-103801	0881	1	GCF Priority 1: Correction to EUTRA RLC test case 7.2.3.7	9.0.0	9.1.0
2010-06	RAN#48	R5-103802	0849	-	GCF Priority 1 - Update of RRC test cases 8.2.2.1	9.0.0	9.1.0
2010-06	RAN#48	R5-103803	0850	-	GCF Priority 1: Correction to EUTRA RLC test case 7.2.3.10	9.0.0	9.1.0
2010-06	RAN#48	R5-103804	0851	-	GCF priority 2 - Correction to test case 6.1.1.1	9.0.0	9.1.0
2010-06	RAN#48	R5-103805	0852	-	GCF Priority 2: Correction to EUTRA RLC test case 7.2.2.8	9.0.0	9.1.0
2010-06	RAN#48	R5-103806	0853	-	GCF Priority 2: Correction to EUTRA RLC test case 7.2.2.10	9.0.0	9.1.0
2010-06	RAN#48	R5-103807	0854	-	GCF Priority 2: Correction to EUTRA RLC test case 7.2.3.13	9.0.0	9.1.0
2010-06	RAN#48	R5-103808	0855	-	GCF Priority 2 - Update to test case 8.1.2.5	9.0.0	9.1.0
2010-06	RAN#48	R5-103809	0856	-	GCF Priority 2: Correction to EPC test case 9.1.3.2	9.0.0	9.1.0
2010-06	RAN#48	R5-103810	0857	-	GCF Priority 2: Adding UE pre-conditions for UE to be configured for EPS attach in 9.2.1.1.x EPS attach test cases	9.0.0	9.1.0
2010-06	RAN#48	R5-103811	0858	-	GCF Priority 2: Adding UE pre-conditions for UE to be configured for EPS attach in 9.2.3.1.x TAU test cases	9.0.0	9.1.0
2010-06	RAN#48	R5-103814	0859	-	GCF Priority 2: Adding UE pre-conditions for UE to be configured for EPS attach in 9.2.2.x detach test cases	9.0.0	9.1.0
2010-06	RAN#48	R5-103815	0860	-	GCF Priority 2: Adding UE pre-conditions for UE to be configured for combined EPS/IMSI attach in 9.2.1.2.x combined attach test cases	9.0.0	9.1.0
2010-06	RAN#48	R5-103816	0895	-	Correction to MAC and RLC handover test cases to set IE "statusReportRequired" to FALSE	9.0.0	9.1.0
2010-06	RAN#48	R5-103817	0882	1	GCF Priority 2: Correction to EMM test case 9.2.3.1.2	9.0.0	9.1.0
2010-06	RAN#48	R5-103818	0861	-	GCF Priority 2 - Correction to EPS test case 9.4.1	9.0.0	9.1.0
2010-06	RAN#48	R5-103819	0883	-	GCF Priority 2 - Update of General tests part	9.0.0	9.1.0

Date	TSG #	TSG Doc.	CR	Rev	Subject/Comment	Version Old	Version New
					TC 11.1.4		
2010-06	RAN#48	R5-103820	0862	-	GCF Priority 2 - Correction to 'SMS over SGs' test case 11.1.1	9.0.0	9.1.0
2010-06	RAN#48	R5-103821	0863	-	GCF Priority 2 - Correction to 'SMS over SGs' test case 11.1.2	9.0.0	9.1.0
2010-06	RAN#48	R5-103822	0864	-	GCF Priority 2 - Correction to 'SMS over SGs' test case 11.1.3	9.0.0	9.1.0
2010-06	RAN#48	R5-103823	0894	-	GCF priority 3 - New test case 6.2.1.2 Inter-RAT PLMN Selection /Selection of correct RAT for UPLMN/Automatic mode	9.0.0	9.1.0
2010-06	RAN#48	R5-103824	0884	1	GCF priority 3 - Inter-RAT PLMN Selection/ Selection of correct PLMN and RAT in shared network environment, Automatic mode	9.0.0	9.1.0
2010-06	RAN#48	R5-103825	0885	1	GCF priority 4 - New test case 6.2.1.4 Inter-RAT PLMN Selection/ Selection of correct RAT from the OPLMN list/ Manual mode	9.0.0	9.1.0
2010-06	RAN#48	R5-103826	0886	-	GCF priority 3 - New test case 6.2.1.1 Inter-RAT PLMN Selection /Selection of correct RAT for OPLMN/Automatic mode	9.0.0	9.1.0
2010-06	RAN#48	R5-103827	0887	-	GCF Priority 3 - Update test case 8.2.4.8, 8.5.1.2 and 8.5.1.4	9.0.0	9.1.0
2010-06	RAN#48	R5-103828	0865	-	GCF Priority 3 - Update test case 8.3.3.3	9.0.0	9.1.0
2010-06	RAN#48	R5-103829	0888	-	GCF Priority 3 - Update RRC test case 8.3.1.4	9.0.0	9.1.0
2010-06	RAN#48	R5-103830	0866	-	GCF Priority 3: New EMM test case, 9.2.1.1.23: Attach / Abnormal case / Repeated rejects for network failures	9.0.0	9.1.0
2010-06	RAN#48	R5-103831	0867	-	GCF Priority 3: New TC 9.3.1.6 Service request / Rejected / EPS services not allowed	9.0.0	9.1.0
2010-06	RAN#48	R5-103832	0868	-	Priority 3 - update of test case 9.2.1.1.24	9.0.0	9.1.0
2010-06	RAN#48	R5-103833	0889	1	GCF Priority 2 - Correction of EMM test case 9.1.2.3	9.0.0	9.1.0
2010-06	RAN#48	R5-103836	0869	-	GCF Priority 3 - Addition of new test case 13.1.5	9.0.0	9.1.0
2010-06	RAN#48	R5-103837	0889	-	GCF Priority 3 - Update of Multilayer Procedures part TC 13.3.1.2	9.0.0	9.1.0
2010-06	RAN#48	R5-103838	0870	-	GCF Priority 3 - Update of Multilayer Procedures part TC 13.1.3	9.0.0	9.1.0
2010-06	RAN#48	R5-103839	0891	-	GCF Priority 4 - Update of RRC part TC 8.1.1.3 RRC / Paging for connection in idle mode /Multiple paging records	9.0.0	9.1.0
2010-06	RAN#48	R5-103840	0871	-	GCF Priority 4 - Addition of new test case 8.2.1.5	9.0.0	9.1.0
2010-06	RAN#48	R5-103841	0872	-	GCF Priority 4 - Addition of new test case 8.2.1.6	9.0.0	9.1.0
2010-06	RAN#48	R5-103842	0873	-	GCF Priority 4 - New TC 9.2.1.1.4 Attach Procedure Success Request for obtaining the IPv4 address of the home agent	9.0.0	9.1.0
2010-06	RAN#48	R5-103843	0874	-	Priority 4 - Addition of new test case 9.2.3.2.16	9.0.0	9.1.0
2010-06	RAN#48	R5-103844	0892	1	GCF Priority 4 - New TC 13.1.8 Connected CSFB to GSM with Redirection MO call	9.0.0	9.1.0
2010-06	RAN#48	R5-103848	0875	-	GCF Priority 2 - Update RRC test case 8.2.4.6	9.0.0	9.1.0
2010-06	RAN#48	R5-103849	0876	-	Addition of UE end state for 15 EMM test cases and termination of ongoing signalling procedure for 3 EMM test cases	9.0.0	9.1.0
2010-06	RAN#48	R5-103872	0877	-	GCF Priority 1 - Correction to MAC test case 7.1.4.5	9.0.0	9.1.0
2010-06	RAN#48	R5-103873	0878	-	GCF Priority 4 - Addition of Multi-layer Procedures part test case 13.1.7	9.0.0	9.1.0
2010-06	RAN#48	R5-103876	0879	-	GCF Priority 4 - Addition of new test case 9.2.3.2.2 for combined tracking area update / successful for EPS services only / IMSI unknown in HSS	9.0.0	9.1.0
2010-06	-	-	-	-	Typo correction of clause title 9.2.1.1.3.3	9.1.0	9.1.1
2010-09	RAN#49	GP-101502	0898	-	CR 36.523-1-0898 New test case 6.2.3.14 Inter-RAT Cell Reselection / from GSM_Idle/GPRS Packet Idle to E-UTRA (priority of E-UTRA cells are higher than the serving cell)	9.1.1	9.2.0
2010-09	RAN#49	GP-101503	0899	-	CR 36.523-1-0899 New test case 6.2.3.15 Inter-RAT Cell Reselection / from GSM_Idle/GPRS Packet Idle to E-UTRA (priority of E-UTRA cells are lower than the serving cell)	9.1.1	9.2.0

Date	TSG #	TSG Doc.	CR	Rev	Subject/Comment	Version Old	Version New
2010-09	RAN#49	GP-101510	0896	-	CR 36.523-1-0896 6.2.3.19 : Redirection to E-UTRA upon the release of the CS connection	9.1.1	9.2.0
2010-09	RAN#49	GP-101521	0897	-	CR 36.523-1-0897 6.2.3.20: Redirection to E-UTRA upon the release of the CS connection and no suitable cell available	9.1.1	9.2.0
2010-09	RAN#49	GP-101562	0902	-	CR 36.523-1-0902 New Test case 6.2.3.27-Inter-RAT Cell selection from GPRS Packet transfer to E-UTRA Cell (NC2 mode).	9.1.1	9.2.0
2010-09	RAN#49	GP-101603	1016	-	CR 36.523-1-1016 New Test Case 6.2.3.23 - Inter-RAT Cell Reselection from GPRS Packet transfer to E-UTRA in CCN mode (PACKET CELL CHANGE CONTINUE)	9.1.1	9.2.0
2010-09	RAN#49	R5-104073	0903	-	GCF Priority 2 - Corrections to EUTRA idle mode test cases	9.1.1	9.2.0
2010-09	RAN#49	R5-104083	0904	-	GCF Priority 2 - Review of detach at switch/power off procedure in EMM test cases	9.1.1	9.2.0
2010-09	RAN#49	R5-104084	0905	-	GCF Priority 2 - Review of switch/power off procedure	9.1.1	9.2.0
2010-09	RAN#49	R5-104107	0906	-	GCF Priority 1 - Correction to remove special configurations for UM Bearer test cases	9.1.1	9.2.0
2010-09	RAN#49	R5-104130	0907	-	GCF Priority 2 - Correction to EUTRA RRC test case 8.1.2.7	9.1.1	9.2.0
2010-09	RAN#49	R5-104136	0908	-	GCF Priority 2 - Correction to Generic E-UTRA radio bearer test procedure 12.1.1 and 12.1.2	9.1.1	9.2.0
2010-09	RAN#49	R5-104142	0909	-	GCF Priority 2 - Correction to EMM test case 9.2.3.1.2	9.1.1	9.2.0
2010-09	RAN#49	R5-104144	0910	-	GCF Priority 1 - Correction to MAC test case 7.1.2.8	9.1.1	9.2.0
2010-09	RAN#49	R5-104145	0911	-	GCF Priority 2 - Correction to EUTRA RRC test case 8.1.2.5	9.1.1	9.2.0
2010-09	RAN#49	R5-104147	0912	-	GCF Priority 2 - Correction to EUTRA MAC test case 7.1.4.3	9.1.1	9.2.0
2010-09	RAN#49	R5-104148	0913	-	GCF Priority 1 - Correction to EUTRA RLC test case 7.2.3.1	9.1.1	9.2.0
2010-09	RAN#49	R5-104149	0914	-	GCF Priority 1 - Correction to EUTRA MAC test case 7.1.2.6	9.1.1	9.2.0
2010-09	RAN#49	R5-104150	0915	-	GCF Priority 1 - Correction to EUTRA MAC test case 7.1.3.1	9.1.1	9.2.0
2010-09	RAN#49	R5-104157	0917	-	GCF Priority 1 - Correction to EUTRA MAC test case 7.1.3.6	9.1.1	9.2.0
2010-09	RAN#49	R5-104162	0918	-	GCF Priority 1 - Correction to EUTRA MAC test case 7.1.4.11	9.1.1	9.2.0
2010-09	RAN#49	R5-104168	0919	-	GCF Priority 2 - Correction of ESM test case 10.8.1	9.1.1	9.2.0
2010-09	RAN#49	R5-104173	0920	-	GCF Priority 4 - Addition of new test case 6.1.2.14	9.1.1	9.2.0
2010-09	RAN#49	R5-104178	0921	-	GCF Priority 4 - Addition of new test case 9.2.3.2.5	9.1.1	9.2.0
2010-09	RAN#49	R5-104182	0922	-	GCF Priority 3 - Update to test case 13.1.5	9.1.1	9.2.0
2010-09	RAN#49	R5-104238	0923	-	GCF Priority 2 - Correction of EMM test case 9.2.1.1.17	9.1.1	9.2.0
2010-09	RAN#49	R5-104265	0924	-	GCF Priority 2 - Update of TC 8.1.2.5	9.1.1	9.2.0
2010-09	RAN#49	R5-104283	0925	-	GCF Priority 4 Update test case 8.3.2.5	9.1.1	9.2.0
2010-09	RAN#49	R5-104286	0926	-	GCF Priority 4 - Correction of test cases 14.1 & 14.2	9.1.1	9.2.0
2010-09	RAN#49	R5-104287	0927	-	GCF Priority 4 - Addition of new test case 14.3	9.1.1	9.2.0
2010-09	RAN#49	R5-104389	0928	-	Update of DSMIPv6 test cases	9.1.1	9.2.0
2010-09	RAN#49	R5-104390	0929	-	Removal of DSMIPv6 test case 15.3	9.1.1	9.2.0
2010-09	RAN#49	R5-104399	0930	-	GCF Priority 1 - update of test case 7.2.3.4	9.1.1	9.2.0
2010-09	RAN#49	R5-104512	0931	-	GCF Priority 2 - Update to EMM test case 9.2.2.1.1	9.1.1	9.2.0
2010-09	RAN#49	R5-104535	0932	-	GCF Priority 2 - Update of TC 7.1.4.16	9.1.1	9.2.0
2010-09	RAN#49	R5-104632	0933	-	GCF Priority 1 - Correction of RRC test case 8.5.4.1	9.1.1	9.2.0
2010-09	RAN#49	R5-104637	0934	-	GCF priority 4 - Addition of new test case 8.2.4.12	9.1.1	9.2.0
2010-09	RAN#49	R5-104708	0935	-	GCF Priority 1 - Correction to EUTRA MAC test cases 7.1.7.1.1, 7.1.7.1.2, 7.1.7.1.3, 7.1.7.1.4	9.1.1	9.2.0
2010-09	RAN#49	R5-104709	0936	-	GCF Priority 1 - Correction to EUTRA MAC test case 7.1.7.2.1	9.1.1	9.2.0
2010-09	RAN#49	R5-104710	0937	-	GCF Priority 1 - Correction to EUTRA MAC test case 7.1.3.4	9.1.1	9.2.0
2010-09	RAN#49	R5-104711	0938	-	GCF Priority 1 - Correction to EUTRA MAC test	9.1.1	9.2.0

Date	TSG #	TSG Doc.	CR	Rev	Subject/Comment	Version Old	Version New
					case 7.1.3.9		
2010-09	RAN#49	R5-104712	0939	-	GCF Priority 1 - Correction to GCF WI-081 LTE Testcases 7.1.4.11, 7.1.4.14	9.1.1	9.2.0
2010-09	RAN#49	R5-104713	0940	-	GCF Priority 2 - Correction to ETURA RRC test case 8.2.4.1	9.1.1	9.2.0
2010-09	RAN#49	R5-104714	0941	-	Correction to GCF WI-082 EMM Testcase 9.1.2.1	9.1.1	9.2.0
2010-09	RAN#49	R5-104715	0942	-	GCF Priority 2 - Corrections to EUTRA GERAN idle mode test cases	9.1.1	9.2.0
2010-09	RAN#49	R5-104716	0943	-	GCF Priority 2 - Corrections to idle mode test case 6.2.2.1	9.1.1	9.2.0
2010-09	RAN#49	R5-104717	0944	-	GCF Priority 2 - Review of detach at switch/power off procedure in Idle Mode test cases	9.1.1	9.2.0
2010-09	RAN#49	R5-104718	0945	-	GCF Priority 2 - Correction to Inter RAT HRPD test case 6.2.2.3	9.1.1	9.2.0
2010-09	RAN#49	R5-104719	0946	-	GCF Priority 2 - Correction to Inter RAT HRPD test case 6.2.3.7	9.1.1	9.2.0
2010-09	RAN#49	R5-104720	0947	-	GCF Priority 2 - Correction to Inter RAT HRPD test case 6.2.3.8	9.1.1	9.2.0
2010-09	RAN#49	R5-104721	0948	-	GCF Priority 2 - Addition of new test case 6.2.3.4	9.1.1	9.2.0
2010-09	RAN#49	R5-104722	0949	-	Addition of modified value tag after System Information modification	9.1.1	9.2.0
2010-09	RAN#49	R5-104723	0950	-	GCF Priority 2 - Correction to EUTRA RLC test case 7.2.3.21	9.1.1	9.2.0
2010-09	RAN#49	R5-104724	0951	-	GCF Priority 2 - Correction to GCF Priority 2 Inter RAT HRPD test case 8.1.3.9	9.1.1	9.2.0
2010-09	RAN#49	R5-104725	0952	-	GCF Priority 2 - Correction to TC 8.1.3.5	9.1.1	9.2.0
2010-09	RAN#49	R5-104728	0953	-	GCF Priority 2 - Correction of EMM test case 9.2.1.1.9 and 9.2.1.1.10	9.1.1	9.2.0
2010-09	RAN#49	R5-104729	0954	-	GCF Priority 2 - Correction of EMM test case 9.2.1.1.20	9.1.1	9.2.0
2010-09	RAN#49	R5-104730	0955	-	GCF Priority 2 - update of test case 9.2.3.1.8	9.1.1	9.2.0
2010-09	RAN#49	R5-104731	0956	-	GCF Priority 2 - Correction of EMM test case 9.2.1.2.1	9.1.1	9.2.0
2010-09	RAN#49	R5-104732	0957	-	GCF priority 2 - Correction of test case 9.2.1.1.1a about reference cell information	9.1.1	9.2.0
2010-09	RAN#49	R5-104733	0958	-	GCF Priority 2 - Correction of ESM test case 10.6.1	9.1.1	9.2.0
2010-09	RAN#49	R5-104734	0959	-	GCF Priority 2 - Correction to ESM test case 10.5.1	9.1.1	9.2.0
2010-09	RAN#49	R5-104735	0960	-	GCF Priority 2 - Correction to ESM test case 10.4.1	9.1.1	9.2.0
2010-09	RAN#49	R5-104736	0961	-	Add test case for RRC connection establishment of emergency call	9.1.1	9.2.0
2010-09	RAN#49	R5-104742	0962	-	GCF Priority 3: Correction to test case 7.1.5.2	9.1.1	9.2.0
2010-09	RAN#49	R5-104743	0963	-	GCF Priority 3 - Correction to test case 7.1.5.4	9.1.1	9.2.0
2010-09	RAN#49	R5-104744	0964	-	GCF priority 3: Correction to MAC TBS (MIMO configured) test case 7.1.7.1.5	9.1.1	9.2.0
2010-09	RAN#49	R5-104745	0965	-	GCF priority 3: Correction to MAC TBS (MIMO configured) test case 7.1.7.1.6	9.1.1	9.2.0
2010-09	RAN#49	R5-104746	0966	-	GCF Priority 3 - Addition of new EPS mobility management procedure test case 9.3.2.2a Paging for CS fallback / Connected mode	9.1.1	9.2.0
2010-09	RAN#49	R5-104747	0967	-	GCF Priority 3 - update of test case 9.2.1.1.12	9.1.1	9.2.0
2010-09	RAN#49	R5-104748	0968	-	GCF Priority 3 - update of test case 9.3.1.15	9.1.1	9.2.0
2010-09	RAN#49	R5-104749	0969	-	GCF Priority 3 - update of test case 9.2.3.1.23	9.1.1	9.2.0
2010-09	RAN#49	R5-104750	0970	-	GCF Priority 3 - Correction of ESM test case 10.5.3	9.1.1	9.2.0
2010-09	RAN#49	R5-104751	0971	-	GFC Priority 3 and 4: Correction of generic test procedure used in MIMO DRB test cases	9.1.1	9.2.0
2010-09	RAN#49	R5-104752	0972	-	GCF Priority 3 - Addition of new Multilayer Procedures test case 13.1.4 Call setup from E-UTRAN RRC_IDLE / CS fallback to UTRAN with Handover / MT call	9.1.1	9.2.0
2010-09	RAN#49	R5-104753	0973	-	Addition of new LTE test case 13.1.2 CS fallback UTRAN with redirection / MO call	9.1.1	9.2.0
2010-09	RAN#49	R5-104754	0974	-	GCF Priority 3 - Addition of New TC for cell reselection when 1xRTT is higher priority	9.1.1	9.2.0
2010-09	RAN#49	R5-104755	0975	-	GCF Priority 3 - Addition of New TC for cell reselection when 1xRTT is lower priority	9.1.1	9.2.0
2010-09	RAN#49	R5-104756	0976	-	GCF Priority 4 - Addition of new test case	9.1.1	9.2.0

Date	TSG #	TSG Doc.	CR	Rev	Subject/Comment	Version Old	Version New
					6.1.1.6		
2010-09	RAN#49	R5-104757	0977	-	GCF Priority 4: Correction to test case 7.1.5.1	9.1.1	9.2.0
2010-09	RAN#49	R5-104758	0978	-	GCF Priority 4: Correction to test case 7.1.5.3	9.1.1	9.2.0
2010-09	RAN#49	R5-104759	0979	-	GCF Priority 4 - Correction to test case 7.1.5.5	9.1.1	9.2.0
2010-09	RAN#49	R5-104760	0980	-	GCF Priority 4 - Addition of new test case 8.1.2.6	9.1.1	9.2.0
2010-09	RAN#49	R5-104761	0981	-	GCF Priority 4 - Update of TC 8.2.1.5	9.1.1	9.2.0
2010-09	RAN#49	R5-104762	0982	-	GCF Priority 4 - Update of TC 8.2.1.6	9.1.1	9.2.0
2010-09	RAN#49	R5-104763	0983	-	GCF Priority 4 - Correction to TC 8.2.4.8	9.1.1	9.2.0
2010-09	RAN#49	R5-104764	0984	-	GCF Priority 4 - Update of TC 8.3.1.6	9.1.1	9.2.0
2010-09	RAN#49	R5-104765	0985	-	GCF Priority 2 - Correction to EUTRA RRC Test Case 8.2.4.7	9.1.1	9.2.0
2010-09	RAN#49	R5-104768	0986	-	GCF Priority 4 - Addition of new EMM test case 9.2.1.1.3	9.1.1	9.2.0
2010-09	RAN#49	R5-104769	0987	-	GCF Priority 4 - Addition of new test case 9.2.3.2.11	9.1.1	9.2.0
2010-09	RAN#49	R5-104770	0988	-	GCF Priority 4 - Update to test case 9.2.3.2.15	9.1.1	9.2.0
2010-09	RAN#49	R5-104771	0989	-	GCF Priority 4 - Addition of new test case 9.3.1.12a	9.1.1	9.2.0
2010-09	RAN#49	R5-104773	0990	-	GCF Priority X: Addition of New TC for Inter-RAT Cell reselection from E-UTRA idle non-CSG cell to a UTRA CSG cell	9.1.1	9.2.0
2010-09	RAN#49	R5-104774	0991	-	GCF Priority X: Addition of New TC for Inter-RAT CSG Cell Reselection from E-UTRA CSG cell to UTRA CSG cell	9.1.1	9.2.0
2010-09	RAN#49	R5-104776	0992	-	GCF Priority X: Introduction of new ESM test case 10.9.1 for UE routing of uplinks packets	9.1.1	9.2.0
2010-09	RAN#49	R5-104777	0993	-	GCF priority 2 - Cell detection timing related correction to test case 6.1.2.3	9.1.1	9.2.0
2010-09	RAN#49	R5-104778	0994	-	GCF priority 1 - Cell detection timing related correction to test case 6.1.2.4	9.1.1	9.2.0
2010-09	RAN#49	R5-104779	0995	-	GCF priority 2 - Cell detection timing related correction to test case 6.1.2.5	9.1.1	9.2.0
2010-09	RAN#49	R5-104780	0996	-	GCF priority 2 - Cell detection timing related correction to test case 6.1.2.11	9.1.1	9.2.0
2010-09	RAN#49	R5-104781	0997	-	GCF priority 1 - Cell detection timing related correction to test case 6.1.2.15	9.1.1	9.2.0
2010-09	RAN#49	R5-104782	0998	-	GCF priority 2 - Cell detection timing related correction to test case 6.2.2.1	9.1.1	9.2.0
2010-09	RAN#49	R5-104783	0999	-	GCF priority 2 - Cell detection timing related correction to test case 6.2.2.2	9.1.1	9.2.0
2010-09	RAN#49	R5-104784	1000	-	GCF priority 2 - Cell detection timing related correction to test case 6.2.3.1	9.1.1	9.2.0
2010-09	RAN#49	R5-104785	1001	-	GCF priority 2 - Cell detection timing related correction to test case 6.2.3.2	9.1.1	9.2.0
2010-09	RAN#49	R5-104786	1002	-	GCF priority 2 - Cell detection timing related correction to test case 6.2.3.3	9.1.1	9.2.0
2010-09	RAN#49	R5-104787	1003	-	GCF priority 2 - Cell detection timing related correction to test case 6.2.3.5	9.1.1	9.2.0
2010-09	RAN#49	R5-104788	1004	-	GCF priority 2 - Cell detection timing related correction to test case 8.1.2.5	9.1.1	9.2.0
2010-09	RAN#49	R5-104789	1005	-	GCF priority 2 - Cell detection timing related correction to test case 8.4.2.2	9.1.1	9.2.0
2010-09	RAN#49	R5-104790	1006	-	GCF priority 2 - Cell detection timing related correction to test case 8.4.2.4	9.1.1	9.2.0
2010-09	RAN#49	R5-104791	1007	-	GCF Priority 1 - Correction to test case 6.1.2.2	9.1.1	9.2.0
2010-09	RAN#49	R5-104792	1008	-	GCF Priority 2 - Correction to EUTRA Idle mode test case 6.1.2.6	9.1.1	9.2.0
2010-09	RAN#49	R5-104793	1009	-	GCF Priority 3 - Correction to EUTRA RRC test case 8.1.2.2	9.1.1	9.2.0
2010-09	RAN#49	R5-104794	1010	-	GCF Priority 2 - Correction to EUTRA PDCP test cases 7.3.5.2, 7.3.5.3, 7.3.5.4, 7.3.5.5	9.1.1	9.2.0
2010-09	RAN#49	R5-104795	1011	-	Correction to Generic E-UTRA radio bearer test procedure	9.1.1	9.2.0
2010-09	RAN#49	R5-104797	1012	-	GCF Priority 2 - Update test cases in clause 8.5.1	9.1.1	9.2.0
2010-09	RAN#49	R5-104798	1013	-	GCF Priority 2 - Update of MAC test case 7.1.4.3	9.1.1	9.2.0
2010-09	RAN#49	R5-105000	1014	-	GCF Priority 3 - New TC 6.3.3 Inter-RAT cell reselection / From UTRA_Idle to E-UTRA RRC_IDLE CSG cell	9.1.1	9.2.0
2010-09	RAN#49	R5-105001	1015	-	GCF Priority 1 - Correction to GCF Priority 1 MAC test cases for AP#47.05	9.1.1	9.2.0

Date	TSG #	TSG Doc.	CR	Rev	Subject/Comment	Version Old	Version New
2010-09	RAN#49	R5-105002	1017	-	GCF Priority 1 - Correction of new test cases in 8.3.3	9.1.1	9.2.0
2010-09	RAN#49	R5-105004	1018	-	GCF Priority 4 - Update to test case 8.1.2.9	9.1.1	9.2.0
2010-09	RAN#49	R5-105005	1019	-	36523-1: Update of attach procedure specification	9.1.1	9.2.0
2010-09	RAN#49	R5-105006	1020	-	GCF Priority 4 - Update of TC 8.1.2.8	9.1.1	9.2.0
2010-09	RAN#49	R5-105007	1021	-	GCF Priority 1 - Correction of EUTRA MAC test case 7.1.4.5	9.1.1	9.2.0
2010-09	RAN#49	R5-105009	1022	-	GCF Priority 2 - Correction of EUTRA test case 8.5.1.3	9.1.1	9.2.0
2010-09	RAN#49	R5-105010	1023	-	GCF Priority 2 - Correction to EUTRA RRC test case 8.5.1.1	9.1.1	9.2.0
2010-09	RAN#49	R5-105011	1024	-	GCF Priority 2 - Correction of EUTRA test case 8.3.1.3	9.1.1	9.2.0
2010-09	RAN#49	R5-105012	1025	-	GCF Priority 2 - Correction to ESM test case 10.7.2	9.1.1	9.2.0
2010-09	RAN#49	R5-105014	1027	-	GCF Priority 3 - update of test case 9.2.3.2.9	9.1.1	9.2.0
2010-09	RAN#49	R5-105015	1028	-	GCF Priority 2 - update of test case 9.2.3.1.2	9.1.1	9.2.0
2010-09	RAN#49	R5-105016	1029	-	GCF Priority 1+2: Correction to RLC test cases for AP#47.05	9.1.1	9.2.0
2010-09	RAN#49	R5-105054	1031	-	GCF Priority 1 - Correction to EUTRA RLC test case 7.2.3.18	9.1.1	9.2.0
2010-09	RAN#49	R5-105070	1026	-	Harmonising EMM test case pre-test conditions specification	9.1.1	9.2.0
2010-09	RAN#49	R5-105071	1030	-	GCF Priority x - Correction to 36.523-1 Test Case 8.3.1.5	9.1.1	9.2.0
2010-12	RAN#50	R5-106062	1133	-	GCF Priority 2 - Correction of ESM test case 10.3.1	9.2.0	9.3.0
2010-12	RAN#50	R5-106094	1134	-	GCF Priority 1 - Update of RRC test case 8.2.2.2	9.2.0	9.3.0
2010-12	RAN#50	R5-106107	1135	-	GCF Priority 1 - Correction to EMM test case 9.2.3.1.1	9.2.0	9.3.0
2010-12	RAN#50	R5-106108	1136	-	GCF Priority 2 - Correction to ESM test case 10.4.1	9.2.0	9.3.0
2010-12	RAN#50	R5-106109	1137	-	GCF Priority 2 - Correction to EMM test case 9.2.3.1.2	9.2.0	9.3.0
2010-12	RAN#50	R5-106111	1138	-	GCF Priority 2 - Correction to ESM test case 10.7.2	9.2.0	9.3.0
2010-12	RAN#50	R5-106114	1032	-	GCF Priority 3 - Correction to EMM test case 9.2.3.1.13	9.2.0	9.3.0
2010-12	RAN#50	R5-106156	1033	-	GCF Priority 1 - Correction to TC 7.2.3.2	9.2.0	9.3.0
2010-12	RAN#50	R5-106160	1034	-	GCF Priority 1 - Correction to TC 9.2.3.1.5	9.2.0	9.3.0
2010-12	RAN#50	R5-106164	1035	-	GCF Priority 2 - Correction to TC 7.3.5.4	9.2.0	9.3.0
2010-12	RAN#50	R5-106177	1036	-	GCF Priority 2 - Correction of test cases in 6.2.3.4	9.2.0	9.3.0
2010-12	RAN#50	R5-106182	1037	-	GCF Priority 2 - Correction of test cases in 8.3.2.1, 8.3.2.3, 8.3.2.5 and 8.3.2.6	9.2.0	9.3.0
2010-12	RAN#50	R5-106183	1038	-	GCF Priority 3 - Correction of test cases in 8.3.3	9.2.0	9.3.0
2010-12	RAN#50	R5-106186	1039	-	GCF Priority 3 - Corrections to test case 9.2.1.2.2	9.2.0	9.3.0
2010-12	RAN#50	R5-106187	1040	-	GCF Priority 3 - Corrections to test case 9.2.2.1.7	9.2.0	9.3.0
2010-12	RAN#50	R5-106188	1041	-	GCF Priority 1 - Corrections to test case 9.2.2.2.1	9.2.0	9.3.0
2010-12	RAN#50	R5-106189	1042	-	GCF Priority 4 - Corrections to test case 9.2.3.2.2.	9.2.0	9.3.0
2010-12	RAN#50	R5-106190	1043	-	GCF Priority 4 - Corrections to test case 9.3.1.17	9.2.0	9.3.0
2010-12	RAN#50	R5-106204	1044	-	GCF Priority 1 - Corrections to test case 7.1.4.1	9.2.0	9.3.0
2010-12	RAN#50	R5-106214	1045	-	GCF Priority 2 - Correction to EMM test cases 9.2.1.1.13, 9.2.1.1.15 and 9.2.1.1.17	9.2.0	9.3.0
2010-12	RAN#50	R5-106216	1046	-	GCF Priority 2 - Correction to EMM test case 9.2.1.1.7	9.2.0	9.3.0
2010-12	RAN#50	R5-106226	1047	-	GCF Priority 2 - Correction to EMM test case 9.2.1.2.1	9.2.0	9.3.0
2010-12	RAN#50	R5-106227	1048	-	GCF Priority 2 - Correction to EMM test case 9.2.1.2.4	9.2.0	9.3.0
2010-12	RAN#50	R5-106229	1049	-	GCF Priority 2 - Correction to EMM test case 9.2.3.1.4	9.2.0	9.3.0
2010-12	RAN#50	R5-106268	1050	-	GCF Priority 4 - Editorial correction to test case 6.1.1.6	9.2.0	9.3.0
2010-12	RAN#50	R5-106269	1051	-	GCF Priority 3 - Update to test case 6.2.2.5	9.2.0	9.3.0

Date	TSG #	TSG Doc.	CR	Rev	Subject/Comment	Version Old	Version New
2010-12	RAN#50	R5-106274	1052	-	GCF Priority 4 - Update to test case 8.1.2.6	9.2.0	9.3.0
2010-12	RAN#50	R5-106275	1053	-	GCF Priority 4 - Update to test case 8.1.2.8	9.2.0	9.3.0
2010-12	RAN#50	R5-106276	1054	-	GCF Priority 4 - Update to test case 8.1.2.9	9.2.0	9.3.0
2010-12	RAN#50	R5-106277	1055	-	GCF Priority 2 - Update to test case 8.1.3.5	9.2.0	9.3.0
2010-12	RAN#50	R5-106280	1056	-	GCF Priority 3 - Update to test case 9.2.1.2.15 and 9.3.1.12a	9.2.0	9.3.0
2010-12	RAN#50	R5-106284	1057	-	GCF Priority 3 - Update to test cases 10.8.2, 10.8.4 and 10.8.6	9.2.0	9.3.0
2010-12	RAN#50	R5-106294	1058	-	CR to 36.523-1: Correction to UTRA cell minimum power level	9.2.0	9.3.0
2010-12	RAN#50	R5-106326	1059	-	GCF Priority 3 - Corrections to ESM test case 10.6.2	9.2.0	9.3.0
2010-12	RAN#50	R5-106333	1060	-	GCF Priority 2 - Corrections to RRC test case 8.2.4.6	9.2.0	9.3.0
2010-12	RAN#50	R5-106335	1061	-	GCF Priority 1-4 - Editorial corrections to EUTRA RRC test cases	9.2.0	9.3.0
2010-12	RAN#50	R5-106336	1062	-	GCF Priority 1-4 - Editorial corrections to EMM test cases	9.2.0	9.3.0
2010-12	RAN#50	R5-106524	1063	-	Update test case 8.1.2.11 with IMS emergency session setup	9.2.0	9.3.0
2010-12	RAN#50	R5-106525	1064	-	Update references with IMS	9.2.0	9.3.0
2010-12	RAN#50	R5-106555	1065	-	GCF Priority 1 - Correction of test cases in 6.1.2	9.2.0	9.3.0
2010-12	RAN#50	R5-106556	1066	-	GCF Priority 1 - Correction to EUTRA MAC test case 7.1.2.8	9.2.0	9.3.0
2010-12	RAN#50	R5-106557	1067	-	GCF Priority 1 - Correction to EUTRA MAC test case 7.1.4.12	9.2.0	9.3.0
2010-12	RAN#50	R5-106558	1068	-	GCF Priority 1 - Correction to EUTRA MAC test case 7.1.4.13	9.2.0	9.3.0
2010-12	RAN#50	R5-106559	1069	-	GCF Priority 2 - Making compressed mode configuration optional for FDD and removal of compressed mode requirement for TDD for InterRAT HO test cases 8.4.2.2	9.2.0	9.3.0
2010-12	RAN#50	R5-106560	1070	-	GCF Priority 2 - Making compressed mode configuration optional for FDD and removal of compressed mode requirement for TDD for InterRAT HO test cases 8.4.2.4	9.2.0	9.3.0
2010-12	RAN#50	R5-106563	1071	-	GCF Priority 1 - Update of MAC test case 7.1.4.13	9.2.0	9.3.0
2010-12	RAN#50	R5-106564	1072	-	Resolve timing issue in P1 RLC TCs	9.2.0	9.3.0
2010-12	RAN#50	R5-106565	1073	-	GCF Priority 1 - Correction to TC 7.2.3.9	9.2.0	9.3.0
2010-12	RAN#50	R5-106566	1074	-	GCF Priority 1 - Update of Radio Bearer test procedure used by TC 12.2.1	9.2.0	9.3.0
2010-12	RAN#50	R5-106567	1075	-	GCF Priority 2 - Correction to Idle mode test case 6.1.2.7	9.2.0	9.3.0
2010-12	RAN#50	R5-106568	1076	-	GCF Priority 2 - Correction of test cases in 6.1.2.8 and 6.1.2.9	9.2.0	9.3.0
2010-12	RAN#50	R5-106569	1077	-	GCF Priority 2 - Correction of test cases in 6.2.2.1 and 6.2.2.2	9.2.0	9.3.0
2010-12	RAN#50	R5-106570	1078	-	GCF Priority 2 - Correction to EUTRA RRC test case 8.1.3.5	9.2.0	9.3.0
2010-12	RAN#50	R5-106572	1079	-	GCF Priority 2 - Correction of test cases in 8.3.1.8 ~ 8.3.1.11	9.2.0	9.3.0
2010-12	RAN#50	R5-106573	1080	-	GCF Priority 2 - Update to test case 8.4.2.2 and 8.4.2.4	9.2.0	9.3.0
2010-12	RAN#50	R5-106574	1081	-	GCF Priority 2 - Correction to contents for message Extended Service Request	9.2.0	9.3.0
2010-12	RAN#50	R5-106575	1082	-	GCF Priority 2 - Correction to EMM test case 9.1.2.3	9.2.0	9.3.0
2010-12	RAN#50	R5-106595	1083	-	Add test case for RRC connection establishment of emergency call / Limited Service	9.2.0	9.3.0
2010-12	RAN#50	R5-106598	1084	-	GCF Priority 1 - Correction to EUTRA RRC test case 8.2.4.1	9.2.0	9.3.0
2010-12	RAN#50	R5-106600	1085	-	GCF Priority 2 - Correction to EMM test case 9.2.2.2.2	9.2.0	9.3.0
2010-12	RAN#50	R5-106601	1086	-	GCF Priority 2 - Correction to EMM test case 9.2.3.2.1	9.2.0	9.3.0
2010-12	RAN#50	R5-106602	1087	-	GCF Priority 3 - Corrections to test case 7.1.5.1 and 7.1.5.2	9.2.0	9.3.0
2010-12	RAN#50	R5-106603	1088	-	GCF Priority 3 - Addition new test case 6.1.2.13	9.2.0	9.3.0
2010-12	RAN#50	R5-106604	1089	-	GCF Priority 2 - Correction to EMM test case 9.2.1.1.1a	9.2.0	9.3.0

Date	TSG #	TSG Doc.	CR	Rev	Subject/Comment	Version Old	Version New
2010-12	RAN#50	R5-106605	1090	-	GCF Priority 3 - Various corrections to EMM section 9 of 36.523-1	9.2.0	9.3.0
2010-12	RAN#50	R5-106607	1092	-	GCF Priority 3: Correction to multi-layer test cases 13.1.4 and 13.1.5	9.2.0	9.3.0
2010-12	RAN#50	R5-106608	1093	-	GCF Priority 4 - Update to test case 8.1.1.3	9.2.0	9.3.0
2010-12	RAN#50	R5-106619	1094	-	GCF Priority 1 - Correction to TC 7.3.3.1, 7.3.3.2, 7.3.3.3 and 7.3.3.4	9.2.0	9.3.0
2010-12	RAN#50	R5-106621	1095	-	GCF Priority 4 - Update to test case 8.1.1.4	9.2.0	9.3.0
2010-12	RAN#50	R5-106622	1096	-	GCF Priority 4 - Correction of test cases in 8.3.1.6	9.2.0	9.3.0
2010-12	RAN#50	R5-106623	1097	-	GCF Priority 4 - Update to test case 9.2.3.2.5, 9.2.3.2.11, and 9.3.1.12a	9.2.0	9.3.0
2010-12	RAN#50	R5-106624	1098	-	9.2.1.3.3 Attach GCF Priority 4 - Addition of new test case 9.2.3.2.13	9.2.0	9.3.0
2010-12	RAN#50	R5-106625	1099	-	GCF Priority 4: Addition of a new test case 9.2.3.2.1b	9.2.0	9.3.0
2010-12	RAN#50	R5-106626	1100	-	Addition of system information combination in Idle Mode test cases	9.2.0	9.3.0
2010-12	RAN#50	R5-106627	1101	-	Addition of system information combination in EMM test cases	9.2.0	9.3.0
2010-12	RAN#50	R5-106628	1102	-	Addition of system information combination in RRC test cases	9.2.0	9.3.0
2010-12	RAN#50	R5-106629	1103	-	Addition of system information combination in Multilayer test cases	9.2.0	9.3.0
2010-12	RAN#50	R5-106630	1104	-	Clarification of measurements requirements for Inter-RAT	9.2.0	9.3.0
2010-12	RAN#50	R5-106631	1105	-	GCF Priority X - Addition new test case 6.2.3.31	9.2.0	9.3.0
2010-12	RAN#50	R5-106632	1106	-	GCF Priority 1 – Correction to EUTRA MAC test case 7.1.4.8	9.2.0	9.3.0
2010-12	RAN#50	R5-106635	1107	-	GCF Priority TBD - Addition of new idle mode test case for inter-freq cell reselection based on CSG autonomous search	9.2.0	9.3.0
2010-12	RAN#50	R5-106636	1108	-	GCF Priority TBD - Correction to TC 16.1.1.1 Inter-RAT Cell reselection from E-UTRA idle non-CSG cell to a UTRA CSG cell	9.2.0	9.3.0
2010-12	RAN#50	R5-106637	1109	-	GCF Priority TBD - Movement of TC 16.1.1.2 to section 6.3.8	9.2.0	9.3.0
2010-12	RAN#50	R5-106638	1110	-	GCF Priority 4 - Addition of new TC 6.3.4 Inter-RAT cell reselection / From UTRA CELL_PCH state to E-UTRA RRC_IDLE CSG cell	9.2.0	9.3.0
2010-12	RAN#50	R5-106641	1112	-	GCF Priority 4 -Making measurement and reporting optional for FDD and removal compressed mode requirement for TDD for Redirection test cases 8.1.3.7	9.2.0	9.3.0
2010-12	RAN#50	R5-106642	1113	-	Periodic RI Reporting using PUCCH / Category 1 UE / Transmission mode 3/4	9.2.0	9.3.0
2010-12	RAN#50	R5-106647	1116	-	GCF Priority X - Addition of new test case 13.1.X	9.2.0	9.3.0
2010-12	RAN#50	R5-106655	1117	-	GCF Priority 4 - New test case 6.1.1.2 PLMN selection of 'Other PLMN/access technology combinations' / Automatic mode	9.2.0	9.3.0
2010-12	RAN#50	R5-106657	1119	-	GCF Priority 1 - Correction to TC 7.2.3.10	9.2.0	9.3.0
2010-12	RAN#50	R5-106659	1120	-	GCF Priority 1 - Corrections and enhancements to EUTRA PDCP test cases 7.3.3.1, 7.3.3.3, 7.3.4.1 and 7.3.4.2	9.2.0	9.3.0
2010-12	RAN#50	R5-106660	1121	-	GCF Priority 3 - Correction to test case 8.1.2.2	9.2.0	9.3.0
2010-12	RAN#50	R5-106661	1122	-	GCF Priority 2 - Corrections to E-UTRA RRC test case 8.1.2.7	9.2.0	9.3.0
2010-12	RAN#50	R5-106662	1123	-	GCF Priority 4: Addition of a new test case 9.2.1.2.1b	9.2.0	9.3.0
2010-12	RAN#50	R5-106666	1124	-	GCF Priority 2 - Correction to EUTRA MAC test case 7.1.4.16	9.2.0	9.3.0
2010-12	RAN#50	R5-106676	1125	-	GCF Priority 1-4 - Editorial corrections to various ESM test cases	9.2.0	9.3.0
2010-12	RAN#50	R5-106678	1126	-	GCF Priority 1-4 - Editorial corrections to EUTRA Idle Mode test cases	9.2.0	9.3.0
2010-12	RAN#50	R5-106679	1127	-	GCF Priority 2 - Corrections to E-UTRA PDCP test case 7.3.5.5	9.2.0	9.3.0
2010-12	RAN#50	R5-106680	1128	-	GCF Priority 2 – Correction to EUTRA RLC test case 7.2.3.16	9.2.0	9.3.0
2010-12	RAN#50	R5-106681	1129	-	GCF Priority 2 - Update to test case 9.2.3.3.1	9.2.0	9.3.0

Date	TSG #	TSG Doc.	CR	Rev	Subject/Comment	Version Old	Version New
					and 9.2.3.3.4		
2010-12	RAN#50	R5-106707	1131	-	GCF priority X: New test case 9.2.3.2.1c Combined tracking area update / Success / CS Fallback not preferred	9.2.0	9.3.0
2010-12	RAN#50	R5-106875	1114	-	GCF Priority X - Addition of new test case 8.1.2.10	9.2.0	9.3.0
2010-12	RAN#50	R5-106876	1118	-	Cell detection timing related correction to test case 6.2.2.3, 6.2.2.4, 6.2.3.7 and 6.2.3.8	9.2.0	9.3.0
2010-12	RAN#50	R5-106877	1115	-	GCF priority X: New test case 9.2.1.2.1c Combined attach procedure / Success / EPS and CS Fallback not preferred	9.2.0	9.3.0
2010-12	RAN#50	RP-101255	1132	-	GCF Priority 2 - Correction to EUTRA RLC test case 7.2.3.21	9.2.0	9.3.0
2011-03	GERAN# 49	GP-110046	1142	-	CR 36.523-1-1142 New test case 6.2.3.16 Inter-RAT Cell Reselection / from GSM_Idle to E-UTRAN /based on H_PRIO criteria	9.3.0	9.4.0
2011-03	GERAN# 49	GP-110047	1143	-	CR 36.523-1-1143 Modifications to test case 6.2.2.6 and 6.2.2.7	9.3.0	9.4.0
2011-03	GERAN# 49	GP-110048	1144	-	CR 36.523-1-1144 New Test Case 6.2.1.6 - Inter-RAT Background HPLMN Search/Search for correct RAT for HPLMN/Automatic Mode.	9.3.0	9.4.0
2011-03	GERAN# 49	GP-110049	1145	-	CR 36.523-1-1145 New Test Case 6.2.3.24 - Inter-RAT Cell Reselection from GPRS Packet transfer to E-UTRA in CCN mode (PACKET CELL CHANGE ORDER)	9.3.0	9.4.0
2011-03	GERAN# 49	GP-110050	1146	-	CR 36.523-1-1146 New Test Case 6.2.3.26 - Inter-RAT Autonomous Cell Reselection GPRS Packet_transfer to E-UTRA (NC1 mode)	9.3.0	9.4.0
2011-03	GERAN# 49	GP-110051	1147	-	CR 36.523-1-1147 Correction to GERAN- EUTRAN Inter-RAT testcases 6.2.3.19,6.2.3.21 and 6.2.3.22	9.3.0	9.4.0
2011-03	GERAN# 49	GP-110107	1149	1	CR 36.523-1-1149 Addition of new Test case 8.4.4.1 Inter-RAT PS Handover / from GPRS Packet_transfer to E-UTRA cell	9.3.0	9.4.0
2011-03	GERAN# 49	GP-110108	1150	1	CR 36.523-1-1150 Addition of new Test case 8.4.4.2 Inter-RAT PS Handover failure from GPRS Packet_transfer to E-UTRA cell	9.3.0	9.4.0
2011-03	GERAN# 49	GP-110405	1148	1	CR 36.523-1-1148 Allow test cases 6.2.3.21 and 6.2.3.22 to be implemented in the TTCN	9.3.0	9.4.0
2011-03	GERAN# 49	GP-110417	1139	1	CR 36.523-1-1139 New test case 6.2.3.17 Inter-RAT Cell Reselection / from GSM_Idle/GPRS Packet_Idle to E-UTRA (priority E-UTRA cells)	9.3.0	9.4.0
2011-03	GERAN# 49	GP-110418	1140	1	CR 36.523-1-1140 New test case 6.2.3.18 Inter-RAT Cell Reselection / from GSM_Idle/GPRS Packet_Idle to E-UTRA (blacklisted E-UTRA cells)	9.3.0	9.4.0
2011-03	GERAN# 49	GP-110419	1141	1	CR 36.523-1-1141 New Test Case 6.2.3.29 - Inter-RAT cell Reselection from GPRS packet_transfer to E-UTRA in CCN mode (PACKET MEASUREMENT ORDER)	9.3.0	9.4.0
2011-03	GERAN# 49	GP-110420	1151	1	CR 36.523-1-1151 Correction to GERAN- EUTRAN Inter-RAT cell reselection testcases 6.2.3.28 and 6.2.3.30.	9.3.0	9.4.0
2011-03	RAN#51	R5-110137	1152	-	GCF Priority 2 - Correction to system information in 6.1.2.7 and 6.1.2.11	9.3.0	9.4.0
2011-03	RAN#51	R5-110156	1153	-	GCF priority 3: Correction of UTRA cell in Idle and EMM test cases	9.3.0	9.4.0
2011-03	RAN#51	R5-110192	1154	-	GCF Priority 2 - Correction to EUTRA test case 8.3.2.3	9.3.0	9.4.0
2011-03	RAN#51	R5-110194	1155	-	GCF Priority 3 - Correction to EMM test case 9.2.1.1.12	9.3.0	9.4.0
2011-03	RAN#51	R5-110205	1156	-	GCF Priority 2 Correction of test case in 6.2.3.4 and 6.3.4	9.3.0	9.4.0
2011-03	RAN#51	R5-110207	1157	-	GCF Priority 3 Correction of test case in 8.1.1.6	9.3.0	9.4.0
2011-03	RAN#51	R5-110208	1158	-	GCF Priority 3 Correction of test case in 8.1.2.2 and 8.1.2.8	9.3.0	9.4.0
2011-03	RAN#51	R5-110209	1159	-	GCF Priority 2 Correction of test case in 8.1.3.4, 8.1.3.6 and 8.1.3.8	9.3.0	9.4.0
2011-03	RAN#51	R5-110211	1160	-	GCF Priority 3 Correction of test case in 8.3.1.11	9.3.0	9.4.0
2011-03	RAN#51	R5-110220	1161	-	GCF Priority 1 - Enhancement to EUTRA MAC test case 7.1.4.6	9.3.0	9.4.0

Date	TSG #	TSG Doc.	CR	Rev	Subject/Comment	Version Old	Version New
2011-03	RAN#51	R5-110223	1162	-	GCF Priority 1 - Correction to EUTRA PDCP test cases 7.3.4.1 and 7.3.4.2	9.3.0	9.4.0
2011-03	RAN#51	R5-110230	1163	-	GCF Priority 4 - Update to test cases 8.1.2.6 and 8.1.2.9	9.3.0	9.4.0
2011-03	RAN#51	R5-110231	1164	-	GCF Priority 4 - Correction on TC numbering and update to test case 8.1.2.10	9.3.0	9.4.0
2011-03	RAN#51	R5-110232	1165	-	GCF Priority 2 - Update to test cases 8.4.2.2 and 8.4.2.4	9.3.0	9.4.0
2011-03	RAN#51	R5-110234	1166	-	GCF Priority 3 - Update to test case 9.2.1.2.11	9.3.0	9.4.0
2011-03	RAN#51	R5-110273	1167	-	Correction to TC 6.2.1.1	9.3.0	9.4.0
2011-03	RAN#51	R5-110274	1168	-	Correction to TC 6.2.1.2	9.3.0	9.4.0
2011-03	RAN#51	R5-110277	1169	-	Correction to TC 8.1.3.6	9.3.0	9.4.0
2011-03	RAN#51	R5-110280	1170	-	Correction to TC 9.2.3.3.1	9.3.0	9.4.0
2011-03	RAN#51	R5-110305	1171	-	GCF Priority 3 - Correction to TC 9.2.1.1.26	9.3.0	9.4.0
2011-03	RAN#51	R5-110329	1172	-	GCF Priority 2 - Update of EMM test case 9.3.1.7a	9.3.0	9.4.0
2011-03	RAN#51	R5-110341	1173	-	Addition of new test case on Service request for mobile originating 1xCS fallback emergency call	9.3.0	9.4.0
2011-03	RAN#51	R5-110342	1174	-	Addition of new test case on emergency call in non-allowed CSG cell	9.3.0	9.4.0
2011-03	RAN#51	R5-110386	1175	-	GCF Priority 3 - Correction to EUTR-1XRTT test case 6.2.2.4	9.3.0	9.4.0
2011-03	RAN#51	R5-110387	1176	-	GCF Priority 3 - Correction to EUTR-1XRTT test case 6.2.3.9	9.3.0	9.4.0
2011-03	RAN#51	R5-110388	1177	-	GCF Priority 3 - Correction to EUTR-1XRTT test case 6.2.3.10	9.3.0	9.4.0
2011-03	RAN#51	R5-110389	1178	-	GCF Priority 3 - Correction to EUTR-1XRTT test cases 8.4.7.3	9.3.0	9.4.0
2011-03	RAN#51	R5-110390	1179	-	GCF Priority 3: Correction to EUTR-1XRTT test cases 8.4.7.4	9.3.0	9.4.0
2011-03	RAN#51	R5-110392	1180	-	GCF priority 3: Correction to MAC TBS (MIMO configured) test case 7.1.7.1.5	9.3.0	9.4.0
2011-03	RAN#51	R5-110393	1181	-	GCF priority 3: Correction to MAC TBS (MIMO configured) test case 7.1.7.1.6	9.3.0	9.4.0
2011-03	RAN#51	R5-110400	1182	-	GCF Priority 1 - Correction to EMM test case 9.2.1.1.2	9.3.0	9.4.0
2011-03	RAN#51	R5-110440	1183	-	Addition of new test case 11.2.5	9.3.0	9.4.0
2011-03	RAN#51	R5-110442	1184	-	Addition of new test case 11.2.4	9.3.0	9.4.0
2011-03	RAN#51	R5-110450	1185	-	GCF Priority 4 - Addition of new Multilayer Procedures test case 13.4.1.3	9.3.0	9.4.0
2011-03	RAN#51	R5-110477	1186	-	New TC 11.2.6 Normal tracking area update for emergency bearer services Local emergency list sent	9.3.0	9.4.0
2011-03	RAN#51	R5-110486	1187	-	GCF Priority 1..4 - Editorial corrections to EMM test cases	9.3.0	9.4.0
2011-03	RAN#51	R5-110504	1188	-	GCF P3 : Corrections to DL and UL SPS grant test cases	9.3.0	9.4.0
2011-03	RAN#51	R5-110514	1189	-	Correction to GCF WI-081 MAC test case 7.1.4.4	9.3.0	9.4.0
2011-03	RAN#51	R5-110602	1190	-	GCF Priority 2 - Correction of Idle testcase 6.2.3.5	9.3.0	9.4.0
2011-03	RAN#51	R5-110603	1191	-	GCF Priority 3 - Correction of Idle testcase 6.2.3.13	9.3.0	9.4.0
2011-03	RAN#51	R5-110604	1192	-	GCF Priority 9 - Correction of Idle testcase 6.2.3.31	9.3.0	9.4.0
2011-03	RAN#51	R5-110677	1193	-	GCF Priority 2 - Correction to GCF WI-081 UTRAN - LTE Testcase 6.2.3.3	9.3.0	9.4.0
2011-03	RAN#51	R5-110711	1194	-	GCF Priority 1 - Correction to EUTRA MAC test case 7.1.4.1	9.3.0	9.4.0
2011-03	RAN#51	R5-110712	1195	-	GCF Priority 1 - Correction to EUTRA MAC test case 7.1.4.5	9.3.0	9.4.0
2011-03	RAN#51	R5-110713	1196	-	GCF Priority 1 - Correction to E-UTRA MAC test case 7.1.3.3	9.3.0	9.4.0
2011-03	RAN#51	R5-110717	1197	-	GCF Priority 1 - Correction to EUTRA RRC test case 8.3.3.1	9.3.0	9.4.0
2011-03	RAN#51	R5-110718	1198	-	GCF Priority 1 - Correction to EUTRA RLC test case 7.2.3.10	9.3.0	9.4.0
2011-03	RAN#51	R5-110719	1199	-	GCF Priority 1 Correction of test cases in 8.3.3	9.3.0	9.4.0
2011-03	RAN#51	R5-110721	1200	-	GCF Priority 2 - Correction to EUTRA Idle Mode test case 6.2.3.5	9.3.0	9.4.0
2011-03	RAN#51	R5-110722	1201	-	GCF Priority 2 - Correction to Idle mode test cases	9.3.0	9.4.0

Date	TSG #	TSG Doc.	CR	Rev	Subject/Comment	Version Old	Version New
2011-03	RAN#51	R5-110723	1202	-	GCF Priority 2 - Update of idle mode TC 6.1.2.7	9.3.0	9.4.0
2011-03	RAN#51	R5-110724	1203	-	GCF Priority 2 - Correction to EUTRA PDCP test cases 7.3.5.2 and 7.3.5.4	9.3.0	9.4.0
2011-03	RAN#51	R5-110725	1204	-	GCF Priority 2 - Correction to EUTRA RRC test case 8.1.2.7	9.3.0	9.4.0
2011-03	RAN#51	R5-110726	1205	-	GCF priority 2: Correction of sysinfo combination in EMM and ESM test cases	9.3.0	9.4.0
2011-03	RAN#51	R5-110728	1206	-	GCF Priority 2-Correction to TC-9.2.1.1.1a	9.3.0	9.4.0
2011-03	RAN#51	R5-110730	1207	-	GCF Priority 3 - Addition of new TC 6.3.2 Inter-RAT cell reselection / From GSM_Idle/GPRS Packet_Idle to E-UTRA idle CSG cell	9.3.0	9.4.0
2011-03	RAN#51	R5-110731	1208	-	GCF Priority 3 - Update to test case 6.3.3 and 6.3.4	9.3.0	9.4.0
2011-03	RAN#51	R5-110732	1209	-	GCF Priority 3 - Addition of new test case 6.2.2.x for Inter-RAT Cell Selection	9.3.0	9.4.0
2011-03	RAN#51	R5-110733	1210	-	GCF Priority 3 - Correction to EUTRA RRC test case 8.1.1.6	9.3.0	9.4.0
2011-03	RAN#51	R5-110734	1211	-	GCF Priority 3 - Correction to EUTRA RRC test case 8.3.2.7	9.3.0	9.4.0
2011-03	RAN#51	R5-110735	1212	-	GCF Priority 3 - Correction to EUTRA RRC test case 8.3.1.7	9.3.0	9.4.0
2011-03	RAN#51	R5-110737	1213	-	GCF Priority 3 - Correction to EUTRA RRC test case 8.3.1.4	9.3.0	9.4.0
2011-03	RAN#51	R5-110738	1214	-	GCF Priority 3 - Correction to EMM test case 9.2.3.1.23	9.3.0	9.4.0
2011-03	RAN#51	R5-110739	1215	-	GCF Priority 3 - Correction to EMM test case 9.2.1.2.9	9.3.0	9.4.0
2011-03	RAN#51	R5-110740	1216	-	GCF Priority 3 - Correction to EMM test case 9.2.3.1.25	9.3.0	9.4.0
2011-03	RAN#51	R5-110741	1217	-	GCF Priority 3 - Correction to EMM test case 9.2.1.1.16	9.3.0	9.4.0
2011-03	RAN#51	R5-110742	1218	-	GCF Priority 3 - Correction to EMM test cases 9.3.2.2 and 9.3.2.2a	9.3.0	9.4.0
2011-03	RAN#51	R5-110751	1219	-	GCF Priority 3 - Correction to EMM test case 9.3.1.15	9.3.0	9.4.0
2011-03	RAN#51	R5-110752	1220	-	GCF Priority 3 - Correction to EMM test case 9.3.1.3	9.3.0	9.4.0
2011-03	RAN#51	R5-110753	1221	-	Correction to TC 9.2.1.1.25	9.3.0	9.4.0
2011-03	RAN#51	R5-110754	1222	-	GCF Priority 3 - Correction to test case 9.3.1.6	9.3.0	9.4.0
2011-03	RAN#51	R5-110755	1223	-	GCF Priority 3- TC 9.2.3.2.1a	9.3.0	9.4.0
2011-03	RAN#51	R5-110756	1224	-	GCF Priority 3-Correction to TC 13.1.4	9.3.0	9.4.0
2011-03	RAN#51	R5-110758	1225	-	GCF Priority 3 - Correction to MultiLayer test case 13.3.1.1	9.3.0	9.4.0
2011-03	RAN#51	R5-110760	1226	-	GCF Priority 3 - Correction to Multilayer test case 13.1.3	9.3.0	9.4.0
2011-03	RAN#51	R5-110764	1227	-	GCF Priority 4 - Addition of E-UTRAN test case 6.1.1.3 for Cell reselection of ePLMN in manual mode	9.3.0	9.4.0
2011-03	RAN#51	R5-110765	1228	-	GCF Priority 4 - Addition of E-UTRAN test case 6.1.2.1 for Cell selection in forbidden Tracking Area	9.3.0	9.4.0
2011-03	RAN#51	R5-110767	1229	-	GCF Priority 4 - Correction to test case 6.2.1.3	9.3.0	9.4.0
2011-03	RAN#51	R5-110768	1230	-	GCF Priority 4 - Update to test case 6.3.7 and 6.3.8	9.3.0	9.4.0
2011-03	RAN#51	R5-110769	1231	-	GCF Priority 4 Correction of test case in 8.1.3.7	9.3.0	9.4.0
2011-03	RAN#51	R5-110770	1232	-	GCF Priority 4 - Correction to EUTRA RRC test case 8.1.2.6	9.3.0	9.4.0
2011-03	RAN#51	R5-110771	1233	-	Correction to TC 9.2.3.2.1c	9.3.0	9.4.0
2011-03	RAN#51	R5-110772	1234	-	GCF Priority 4 - Correction to EMM test case 9.2.3.2.10	9.3.0	9.4.0
2011-03	RAN#51	R5-110773	1235	-	GCF Priority 4 - Correction to EMM test case 9.2.3.2.9	9.3.0	9.4.0
2011-03	RAN#51	R5-110774	1236	-	GCF Priority 2 - Correction to EMM test case 9.3.1.7a	9.3.0	9.4.0
2011-03	RAN#51	R5-110775	1237	-	GCF Priority 2 - Correction to EMM test case 9.3.1.7	9.3.0	9.4.0
2011-03	RAN#51	R5-110776	1238	-	GCF Priority 3 - Correction to EMM test case 9.2.3.1.14	9.3.0	9.4.0
2011-03	RAN#51	R5-110777	1239	-	GCF Priority 3 - Correction to EMM test case 9.2.3.1.13	9.3.0	9.4.0
2011-03	RAN#51	R5-110778	1240	-	GCF Priority 4: Correction test case 9.2.1.2.1b, 9.2.1.2.1c and 9.2.3.2.1b to check the signalled MS Radio Access capability	9.3.0	9.4.0

Date	TSG #	TSG Doc.	CR	Rev	Subject/Comment	Version Old	Version New
2011-03	RAN#51	R5-110779	1241	-	GCF Priority 4: Correction to ESM test case 10.9.1	9.3.0	9.4.0
2011-03	RAN#51	R5-110781	1242	-	GCF Priority 4: New TC 13.1.9 Call setup from E-UTRA RRC_IDLE - CS fallback to GSM with CCO without NACC - MO call	9.3.0	9.4.0
2011-03	RAN#51	R5-110783	1243	-	GCF Priority 2 - Correction to TCs 9.2.1.2.1 and 13.1.7	9.3.0	9.4.0
2011-03	RAN#51	R5-110790	1244	-	Priority X Addition new test case 6.2.3.32	9.3.0	9.4.0
2011-03	RAN#51	R5-110791	1245	-	Correction to TC 6.3.7	9.3.0	9.4.0
2011-03	RAN#51	R5-110792	1246	-	GCF Priority 1 - Update to EUTRA RLC test cases 7.2.3.6, 7.2.3.7, 7.2.3.8 and 7.2.3.17	9.3.0	9.4.0
2011-03	RAN#51	R5-110793	1247	-	GCF Priority 2 - Correction to EMM test case 9.2.2.2.2	9.3.0	9.4.0
2011-03	RAN#51	R5-110794	1248	-	GCF Priority 2 - Update of EMM test case 9.2.3.3.6	9.3.0	9.4.0
2011-03	RAN#51	R5-110796	1249	-	GCF Priority X: Adding test case 9.2.1.2.1d Combined attach procedure / Success / EPS and CS Fallback not preferred/data centric UE	9.3.0	9.4.0
2011-03	RAN#51	R5-110797	1250	-	GCF Priority X - Update to test case 13.1.15	9.3.0	9.4.0
2011-03	RAN#51	R5-110798	1251	-	Update to chapter '4.3 Repetition of tests' to clarify re-testing in test cases, where HARQ retransmissions are not tolerated	9.3.0	9.4.0
2011-03	RAN#51	R5-110813	1252	-	Introduction of new test case 11.2.1 for CT1 aspects of emergency calls	9.3.0	9.4.0
2011-03	RAN#51	R5-110830	1254	-	GCF Priority 2 - Correction to SMS test cases 11.1.1, 11.1.2, 11.1.3, 11.1.4	9.3.0	9.4.0
2011-03	RAN#51	R5-110876	1255	-	GCF Priority 2 - Correction to E-UTRA RLC test case 7.2.3.16	9.3.0	9.4.0
2011-03	RAN#51	R5-110877	1253	-	Priority 2 -4: Adjusting the power levels of multiple cell, multiple RAT EMM test cases	9.3.0	9.4.0
2011-03	RAN#51	R5-110062	1256	-	GCF Priority 2 - Correction to EUTRA IDLE MODE test case 6.1.2.9	9.3.0	9.4.0
2011-03	RAN#51	R5-110072	1257	-	GCF Priority 3 - Correction to MultiLayer test case 13.4.1.2	9.3.0	9.4.0
2011-03	RAN#51	R5-110077	1258	-	GCF Priority 3 - Correction to EMM test case 9.1.2.6	9.3.0	9.4.0
2011-03	RAN#51	R5-110078	1259	-	GCF Priority 3 - Correction to ESM test case 10.8.2	9.3.0	9.4.0
2011-03	RAN#51	R5-110081	1260	-	GCF Priority 3 - Correction to EUTRA RRC test case 8.1.2.3	9.3.0	9.4.0
2011-03	RAN#51	R5-110083	1261	-	GCF Priority 1 - Correction to EUTRA MAC test case 7.1.3.9	9.3.0	9.4.0
2011-03	RAN#51	R5-110085	1262	-	GCF Priority 3 - Correction to EMM test case 9.2.2.1.9	9.3.0	9.4.0
2011-03	RAN#51	R5-110086	1263	-	GCF Priority 3 - Correction to EMM test case 9.2.1.1.24	9.3.0	9.4.0
2011-03	RAN#51	R5-110087	1264	-	GCF Priority 3 - Correction to EUTRA RRC test case 8.3.1.11	9.3.0	9.4.0
2011-03	RAN#51	R5-110091	1265	-	GCF Priority 3 - Correction to MultiLayer test case 13.3.1.2	9.3.0	9.4.0
2011-03	RAN#51	R5-110097	1266	-	CGF Priority 4 - Correction to EUTRA DRB test case 12.3.2	9.3.0	9.4.0
2011-03	RAN#51	R5-110122	1267	-	GCF Priority 4 - Correction of cell number description for test case 6.1.1.6	9.3.0	9.4.0
2011-03	RAN#51	R5-110133	1268	-	GCF priority 2-4: correction of EMM, RRC, Idle mode TC postamble in connected mode	9.3.0	9.4.0
2011-03	RAN#51	R5-110814	1269	-	Addition of new idle mode test case for manual CSG ID selection across PLMNs	9.3.0	9.4.0
2011-03	RAN#51	R5-110815	1270	-	Addition of new idle mode test case for inter-freq cell reselection to hybrid cell based on CSG autonomous search	9.3.0	9.4.0
2011-06	RAN#52	R5-112079	1277	-	GCF Priority 3 - Correction to EUTRA RRC test case 8.2.4.7	9.4.0	9.5.0
2011-06	RAN#52	R5-112080	1278	-	GCF Priority 3 - Correction to EUTRA RRC test case 8.1.1.2	9.4.0	9.5.0
2011-06	RAN#52	R5-112082	1279	-	GCF Priority 2 - Correction to EUTRA Idle mode test case 6.1.1.1	9.4.0	9.5.0
2011-06	RAN#52	R5-112083	1280	-	GCF Priority 1 - Correction to EUTRA PDCP test cases 7.3.4.1 and 7.3.4.2	9.4.0	9.5.0
2011-06	RAN#52	R5-112085	1281	-	GCF Priority 4 - Correction to EUTRA RRC test case 8.5.1.4	9.4.0	9.5.0
2011-06	RAN#52	R5-112088	1283	-	GCF Priority 2 - Correction to EUTRA Idle mode test case 6.1.2.6	9.4.0	9.5.0

Date	TSG #	TSG Doc.	CR	Rev	Subject/Comment	Version Old	Version New
2011-06	RAN#52	R5-112089	1284	-	GCF Priority 2 - Correction to EMM test case 9.2.1.1.1a	9.4.0	9.5.0
2011-06	RAN#52	R5-112090	1285	-	GCF Priority 3 - Correction to EMM test case 9.2.1.2.3	9.4.0	9.5.0
2011-06	RAN#52	R5-112093	1286	-	GCF Priority 3 - Correction to EMM test case 9.2.1.2.15	9.4.0	9.5.0
2011-06	RAN#52	R5-112094	1287	-	GCF Priority 1 - Correction to EMM test case 9.2.3.1.5	9.4.0	9.5.0
2011-06	RAN#52	R5-112095	1288	-	GCF Priority 2 - Correction to EMM test case 9.2.1.1.12	9.4.0	9.5.0
2011-06	RAN#52	R5-112096	1289	-	GCF Priority 3 - Correction to EMM test case 9.2.1.2.2	9.4.0	9.5.0
2011-06	RAN#52	R5-112097	1290	-	GCF Priority 3 - Correction to EMM test case 9.2.1.2.13	9.4.0	9.5.0
2011-06	RAN#52	R5-112098	1291	-	GCF Priority 3 - Correction to EMM test case 9.2.3.1.4	9.4.0	9.5.0
2011-06	RAN#52	R5-112105	1292	-	GCF Priority 2 - Correction to EMM test cases 9.2.1.2.1, 9.2.2.2.2	9.4.0	9.5.0
2011-06	RAN#52	R5-112106	1293	-	GCF Priority 2 - Correction to ESM test case 10.3.1	9.4.0	9.5.0
2011-06	RAN#52	R5-112107	1294	-	Removal of ESM test case 10.6.2	9.4.0	9.5.0
2011-06	RAN#52	R5-112109	1295	-	GCF Priority 2 - Correction to EMM test case 9.3.1.7 and 9.3.1.7a	9.4.0	9.5.0
2011-06	RAN#52	R5-112118	1296	-	GCF Priority 2 - Correction to update reference to 36.508 table 6.4.2.7A-1 and 6.4.2.7A-2	9.4.0	9.5.0
2011-06	RAN#52	R5-112121	1297	-	GCF Priority 4 - Correction to EMM test cases 9.2.3.2.5, 9.2.3.2.6 and 9.2.3.2.7	9.4.0	9.5.0
2011-06	RAN#52	R5-112122	1298	-	GCF Priority 2 - Correction to specific message content for RRC Connection Reconfiguration message (Handover test cases)	9.4.0	9.5.0
2011-06	RAN#52	R5-112145	1299	-	GCF Priority 1 - Correction to GCF WI-081 MAC Testcase 7.1.2.9	9.4.0	9.5.0
2011-06	RAN#52	R5-112162	1300	-	GCF Priority 4 - remove the message contents from 14.1, 14.2 and 14.3	9.4.0	9.5.0
2011-06	RAN#52	R5-112205	1301	-	GCF Priority 2 - Correction to EUTRA RLC test case 7.2.2.10	9.4.0	9.5.0
2011-06	RAN#52	R5-112208	1302	-	GCF priority 4: Correction of UTRA cell in EMM test case 9.2.3.2.8	9.4.0	9.5.0
2011-06	RAN#52	R5-112257	1303	-	GCF Priority 2 - Correcting usage of generic test procedure 36.508 cl. 6.4.2.8	9.4.0	9.5.0
2011-06	RAN#52	R5-112262	1304	-	GCF Priority 4 - Correction to Multilayer test cases 13.2.1, 13.4.1.2, 13.4.1.3	9.4.0	9.5.0
2011-06	RAN#52	R5-112266	1305	-	GCF priority 1 - Correction to EUTRA MAC test case 7.1.4.13	9.4.0	9.5.0
2011-06	RAN#52	R5-112276	1306	-	GCF Priority 4 - Update of EMM test case 9.2.1.1.4	9.4.0	9.5.0
2011-06	RAN#52	R5-112287	1307	-	GCF Priority 3 - Editorial correction to EMM test case 9.2.1.1.26	9.4.0	9.5.0
2011-06	RAN#52	R5-112304	1308	-	GCF Priority 4 - Correction to TC 8.1.3.7	9.4.0	9.5.0
2011-06	RAN#52	R5-112351	1309	-	GCF Priority 3 - Update of EMM TC 9.2.1.2.13	9.4.0	9.5.0
2011-06	RAN#52	R5-112390	1310	-	Update of HeNB enhancements test case 6.3.9	9.4.0	9.5.0
2011-06	RAN#52	R5-112391	1311	-	Update of HeNB enhancements test case 6.4.2	9.4.0	9.5.0
2011-06	RAN#52	R5-112392	1312	-	Update of idle mode section Table 6.0.1-2	9.4.0	9.5.0
2011-06	RAN#52	R5-112434	1313	-	GCF Priority 1 - Correction to EUTRA MAC test case 7.1.2.5	9.4.0	9.5.0
2011-06	RAN#52	R5-112483	1314	-	GCF Priority 1 - Correction to EUTRA MAC test case 7.1.2.1	9.4.0	9.5.0
2011-06	RAN#52	R5-112534	1315	-	GCF Priority 3: Update of TC 8.3.1.4	9.4.0	9.5.0
2011-06	RAN#52	R5-112569	1316	-	GCF Priority 3 - Correction to test case 9.2.3.1.25	9.4.0	9.5.0
2011-06	RAN#52	R5-112594	1318	-	New TC 6.4.6 Inter-RAT cell reselection / From UTRA CELL_PCH to E-UTRA RRC_IDLE member hybrid cell	9.4.0	9.5.0
2011-06	RAN#52	R5-112595	1319	-	New TC 6.4.7 Inter-RAT cell reselection / From GERAN to E-UTRA RRC_IDLE member hybrid cell	9.4.0	9.5.0
2011-06	RAN#52	R5-112602	1320	-	GCF priority 4 - Addition of Multi-layer Procedures test case 13.1.13	9.4.0	9.5.0
2011-06	RAN#52	R5-112603	1321	-	GCF Priority 1 - Correction to EUTRA RLC test case 7.2.3.6	9.4.0	9.5.0
2011-06	RAN#52	R5-112604	1322	-	GCF Priority 1 - Correction to EUTRA RLC test case 7.2.3.6	9.4.0	9.5.0
2011-06	RAN#52	R5-112605	1323	-	GCF priority 1 - Modification to EUTRA RLC	9.4.0	9.5.0

Date	TSG #	TSG Doc.	CR	Rev	Subject/Comment	Version Old	Version New
					test case 7.2.3.9		
2011-06	RAN#52	R5-112606	1324	-	GCF Priority 1 - Correction to EUTRA RLC test case 7.2.3.18	9.4.0	9.5.0
2011-06	RAN#52	R5-112607	1325	-	GCF Priority 2 Correction of CSG test cases	9.4.0	9.5.0
2011-06	RAN#52	R5-112608	1326	-	GCF Priority 2 - Correction to EUTRA PDCP test cases 7.3.5.2	9.4.0	9.5.0
2011-06	RAN#52	R5-112610	1327	-	GCF Priority 2 - Review of detach at switch/power off procedure in EMM test cases and Emergency calls over IMS test case 11.2.3	9.4.0	9.5.0
2011-06	RAN#52	R5-112611	1328	-	GCF Priority 2 - Correction to EMM test case 9.2.3.1.2	9.4.0	9.5.0
2011-06	RAN#52	R5-112614	1329	-	GCF Priority 3 Correction of Measurement configuration test cases	9.4.0	9.5.0
2011-06	RAN#52	R5-112615	1330	-	GCF Priority 3 - Correction to EMM test cases 9.2.1.2.5, 9.2.1.2.6 and 9.2.1.2.7	9.4.0	9.5.0
2011-06	RAN#52	R5-112616	1331	-	GCF Priority 3 - Correction to EMM test cases 9.3.1.4 & 9.3.1.5	9.4.0	9.5.0
2011-06	RAN#52	R5-112617	1332	-	GCF Priority 3 - Correction to EMM test case 9.2.3.1.14	9.4.0	9.5.0
2011-06	RAN#52	R5-112618	1333	-	GCF Priority 3 - Correction to EMM test case 9.2.3.1.15	9.4.0	9.5.0
2011-06	RAN#52	R5-112619	1334	-	GCF Priority 3 - Correction to EMM test case 9.2.3.2.3	9.4.0	9.5.0
2011-06	RAN#52	R5-112620	1335	-	GCF Priority 3 - Correction to EMM test case 9.2.3.2.9	9.4.0	9.5.0
2011-06	RAN#52	R5-112622	1337	-	GCF Priority 3 - Correction to EMM test case 9.2.1.2.8	9.4.0	9.5.0
2011-06	RAN#52	R5-112623	1338	-	GCF Priority 3 - Correction to EMM test case 9.2.1.2.9	9.4.0	9.5.0
2011-06	RAN#52	R5-112624	1339	-	GCF Priority 3 - Correction to EMM test case 9.2.3.2.12	9.4.0	9.5.0
2011-06	RAN#52	R5-112625	1340	-	GCF Priority 3 - Correction to time requirements at cell reselection in EMM test cases	9.4.0	9.5.0
2011-06	RAN#52	R5-112626	1341	-	GCF Priority 3 - Addition of new test case 9.2.3.1.22	9.4.0	9.5.0
2011-06	RAN#52	R5-112628	1342	-	Addition of GCF Priority 3 EMM test case 9.2.2.1.4	9.4.0	9.5.0
2011-06	RAN#52	R5-112629	1343	-	GCF Priority 3 - Correction to Multilayer test case 13.1.3 and 13.1.15	9.4.0	9.5.0
2011-06	RAN#52	R5-112630	1344	-	GCF Priority 3 - New Multi Layer TC 13.4.2.4 Inter-system mobility / Service based redirection from UTRA to E-UTRA	9.4.0	9.5.0
2011-06	RAN#52	R5-112631	1345	-	GCF Priority 3 - Addition of new test case 13.4.2.2	9.4.0	9.5.0
2011-06	RAN#52	R5-112632	1346	-	GCF Priority 3 - Correction to test case 13.1.4	9.4.0	9.5.0
2011-06	RAN#52	R5-112634	1347	-	GCF Priority 3 - Addition of new test case 8.4.3.1 Inter-RAT handover / From E-UTRA to GPRS / PS HO	9.4.0	9.5.0
2011-06	RAN#52	R5-112636	1348	-	GCF Priority 3 - Addition of new test case 13.3.2.1	9.4.0	9.5.0
2011-06	RAN#52	R5-112638	1349	-	Correction to EMM test case to allow execution of all RAT specific branches using a single MRAT device	9.4.0	9.5.0
2011-06	RAN#52	R5-112639	1350	-	GCF Priority 4 Addition new test case 9.2.3.1.9	9.4.0	9.5.0
2011-06	RAN#52	R5-112640	1351	-	GCF Priority 4 - Corrections to Extended Service Request message in 9.2.3.2.1b and 13.1.8	9.4.0	9.5.0
2011-06	RAN#52	R5-112641	1352	-	GCF priority 4 - Addition of EMM test case 9.2.3.1.20	9.4.0	9.5.0
2011-06	RAN#52	R5-112642	1353	-	GCF Priority 4 - Add new test case 13.4.3.1	9.4.0	9.5.0
2011-06	RAN#52	R5-112643	1354	-	GCF Priority 1 - Correction to EMM test case 9.2.1.1.1	9.4.0	9.5.0
2011-06	RAN#52	R5-112654	1355	-	Add new test case 11.2.2	9.4.0	9.5.0
2011-06	RAN#52	R5-112657	1356	-	Addition of new test case on Attach for emergency bearer services / Rejected / No suitable cells in tracking area / Emergency call using the CS domain	9.4.0	9.5.0
2011-06	RAN#52	R5-112658	1357	-	Update of IMS Emergency TC 11.2.6	9.4.0	9.5.0
2011-06	RAN#52	R5-112659	1358	-	New TC for IMS Emergency 11.2.7	9.4.0	9.5.0
2011-06	RAN#52	R5-112660	1359	-	GCF Priority 4 - Update of TC 13.1.9 MO call CS fallback to GSM with CCO without NACC	9.4.0	9.5.0
2011-06	RAN#52	R5-112661	1360	-	GCF Priority 4 - New TC 13.1.10 MT call CS	9.4.0	9.5.0

Date	TSG #	TSG Doc.	CR	Rev	Subject/Comment	Version Old	Version New
					fallback to GSM with CCO without NACC PS service suspension		
2011-06	RAN#52	R5-112666	1361	-	GCF Priority X Correction of test case in 6.2.2.8	9.4.0	9.5.0
2011-06	RAN#52	R5-112667	1362	-	GCF Priority X - Addition of new test case 13.1.2a	9.4.0	9.5.0
2011-06	RAN#52	R5-112668	1363	-	GCF Priority X - Addition of new test case 13.1.16	9.4.0	9.5.0
2011-06	RAN#52	R5-112671	1364	-	Update test case 8.1.2.11	9.4.0	9.5.0
2011-06	RAN#52	R5-112672	1365	-	Update test case 8.1.2.12	9.4.0	9.5.0
2011-06	RAN#52	R5-112678	1366	-	GCF Priority X Addition new test case 6.4.3	9.4.0	9.5.0
2011-06	RAN#52	R5-112679	1367	-	GCF Priority X Addition new test case 6.4.4	9.4.0	9.5.0
2011-06	RAN#52	R5-112680	1368	-	GCF Priority X Addition new test case 6.4.5	9.4.0	9.5.0
2011-06	RAN#52	R5-112682	1369	-	Addition of new HeNB test case for intra-frequency SI acquisition	9.4.0	9.5.0
2011-06	RAN#52	R5-112687	1372	-	GCF priority 4 - Update Multi-layer Procedures test case 13.1.7	9.4.0	9.5.0
2011-06	RAN#52	R5-112688	1373	-	GCF priority 4 - Addition of Multi-layer Procedures test case 13.1.11	9.4.0	9.5.0
2011-06	RAN#52	R5-112689	1374	-	GCF priority 4 - Addition of Multi-layer Procedures test case 13.1.12	9.4.0	9.5.0
2011-06	RAN#52	R5-112690	1375	-	GCF Priority 2 - Correction to EUTRA Idle mode test case 6.3.6	9.4.0	9.5.0
2011-06	RAN#52	R5-112693	1376	-	Addition of a new TC for MCCH information acquisition/UE is switched on	9.4.0	9.5.0
2011-06	RAN#52	R5-112695	1378	-	Addition of a new TC for MCCH information acquisition/ UE handover to a cell in a new MBMS area	9.4.0	9.5.0
2011-06	RAN#52	R5-112701	1379	-	GCF Priority 3 - Correction to test case 13.1.2	9.4.0	9.5.0
2011-06	RAN#52	R5-112703	1381	-	GCF priority 4 - Update Multi-layer Procedures test case 13.3.1.2	9.4.0	9.5.0
2011-06	RAN#52	R5-112705	1382	-	GCF Priority 2 - Corrections to EUTRA RRC test case 8.4.1.2	9.4.0	9.5.0
2011-06	RAN#52	R5-112720	1385	-	GCF Priority 2: Update of test case 9.2.3.4.1	9.4.0	9.5.0
2011-06	RAN#52	R5-112749	1377	-	Addition of a new TC for MCCH information acquisition/ when cell reselection to a cell in a new MBMS area	9.4.0	9.5.0
2011-06	RAN#52	R5-112750	1370	-	GCF Priority X - Addition of new test case 6.4.1	9.4.0	9.5.0
2011-06	RAN#52	R5-112753	1317	-	GCF priority 1 – Correction to EUTRA MAC test case 7.1.4.10	9.4.0	9.5.0
2011-06	RAN#52	R5-112754	1336	-	GCF Priority 2 - Correction to EUTRA MAC test case 7.1.4.3	9.4.0	9.5.0
2011-06	RAN#52	R5-112755	1383	-	GCF Priority 1 - Correction to EUTRA RLC test case 7.2.3.17	9.4.0	9.5.0
2011-06	RAN#52	R5-112756	1380	-	GCF priority 4 - Addition of EMM test case 9.2.3.3.3	9.4.0	9.5.0
2011-06	RAN#52	R5-112757	1371	-	GCF Priority X - Add new test case 9.2.2.1.10	9.4.0	9.5.0
2011-06	GERAN#50	GP-110571	1274	-	CR 36.523-1-1274 Removal of LTE TC 6.2.3.2 specification due to duplication	9.4.0	9.5.0
2011-06	GERAN#50	GP-110575	1275	-	CR 36.523-1-1275 Removal of Test Case 8.4.4.2	9.4.0	9.5.0
2011-06	GERAN#50	GP-110831	1386	-	CR 36.523-1-1386 Addition of new Test case 8.4.4.2 Inter-RAT PS Handover / from GPRS Packet_transfer to E-UTRA cell (CCN mode)	9.4.0	9.5.0
2011-06	GERAN#50	GP-110832	1387	-	CR 36.523-1-1387 Addition of new Test case 8.4.4.3 Inter-RAT PS Handover / from GPRS Packet_transfer to E-UTRA cell (NC2 mode)	9.4.0	9.5.0
2011-06	GERAN#50	GP-110839	1273	1	CR 36.523-1-1273 Modification of tc 6.2.3.19	9.4.0	9.5.0
2011-09	GERAN#51	GP-111104	1386	1	CR 36.523-1-1386 Corrections to GERAN – LTE Tests	9.5.0	9.6.0
2011-09	RAN#53	R5-113031	1389	-	GCF Priority 3: Correction of EMM TC 9.2.3.2.1a	9.5.0	9.6.0
2011-09	RAN#53	R5-113101	1390	-	GCF Priority 4 - Correction to Idle mode test case 6.2.2.7	9.5.0	9.6.0
2011-09	RAN#53	R5-113102	1391	-	GCF Priority 2 -Correction to EUTRA RRC test case 8.1.3.6	9.5.0	9.6.0
2011-09	RAN#53	R5-113104	1392	-	GCF Priority 1 - Correction to EUTRA RRC test cases 8.2.4.1, 8.2.4.4 and 8.2.4.7	9.5.0	9.6.0
2011-09	RAN#53	R5-113105	1393	-	GCF Priority 4 - Correction to EUTRA RRC test case 8.3.1.6	9.5.0	9.6.0
2011-09	RAN#53	R5-113106	1394	-	GCF Priority 3 - Correction to EUTRA RRC test case 8.3.1.7	9.5.0	9.6.0
2011-09	RAN#53	R5-113107	1395	-	GCF Priority 1 - Correction to EUTRA RRC test	9.5.0	9.6.0

Date	TSG #	TSG Doc.	CR	Rev	Subject/Comment	Version Old	Version New
					case 8.3.3.1		
2011-09	RAN#53	R5-113108	1396	-	GCF Priority 3 - Correction to EUTRA RRC test case 8.2.4.7	9.5.0	9.6.0
2011-09	RAN#53	R5-113110	1397	-	GCF Priority 1 - Correction to ESM test cases 10.2.1 and 10.4.1	9.5.0	9.6.0
2011-09	RAN#53	R5-113111	1398	-	GCF Priority 4 - Correction to ESM test cases 10.8.5 and 10.8.6	9.5.0	9.6.0
2011-09	RAN#53	R5-113113	1399	-	GCF Priority 3 - Correction to EMM test case 9.2.1.1.11	9.5.0	9.6.0
2011-09	RAN#53	R5-113114	1400	-	GCF Priority 3 - Correction to EMM test case 9.2.3.1.16	9.5.0	9.6.0
2011-09	RAN#53	R5-113115	1401	-	GCF Priority 3 - Correction to EMM test cases 9.2.3.1.9a and 9.2.3.1.23	9.5.0	9.6.0
2011-09	RAN#53	R5-113116	1402	-	GCF Priority 4 - Correction to EMM test case 9.2.3.2.2	9.5.0	9.6.0
2011-09	RAN#53	R5-113117	1403	-	GCF Priority 4 - Correction to EMM test case 9.2.3.2.4	9.5.0	9.6.0
2011-09	RAN#53	R5-113118	1404	-	GCF Priority 4 - Correction to EMM test case 9.2.3.2.11	9.5.0	9.6.0
2011-09	RAN#53	R5-113121	1405	-	GCF Priority 3 - Correction to EMM test case 9.2.1.1.25	9.5.0	9.6.0
2011-09	RAN#53	R5-113124	1406	-	GCF Priority 3 - Correction to EMM test case 9.2.1.2.12	9.5.0	9.6.0
2011-09	RAN#53	R5-113129	1407	-	GCF Priority 1 - Correction to several EUTRA RLC test cases	9.5.0	9.6.0
2011-09	RAN#53	R5-113131	1408	-	GCF Priority 1 - Correction to EUTRA RLC test case 7.2.3.9	9.5.0	9.6.0
2011-09	RAN#53	R5-113170	1409	-	GCF Priority TBD - Update of test case 6.3.1 Inter-frequency cell reselection / From E-UTRA RRC_IDLE non-CSG cell to E-UTRA RRC_IDLE CSG cell	9.5.0	9.6.0
2011-09	RAN#53	R5-113188	1410	-	GCF Priority 2 - Correction to ESM test case 10.4.1	9.5.0	9.6.0
2011-09	RAN#53	R5-113189	1411	-	GCF Priority 1 - Correction to EUTRA RLC test case 7.2.3.7	9.5.0	9.6.0
2011-09	RAN#53	R5-113190	1412	-	GCF Priority 3 - Correction to Multilayer test case 13.3.1.2	9.5.0	9.6.0
2011-09	RAN#53	R5-113240	1413	-	GCF Priority 3 - Update of EMM test case 9.2.2.1.9	9.5.0	9.6.0
2011-09	RAN#53	R5-113270	1414	-	Update of IMS emergency test case 11.2.3	9.5.0	9.6.0
2011-09	RAN#53	R5-113293	1415	-	Update of the case 11.2.4	9.5.0	9.6.0
2011-09	RAN#53	R5-113294	1416	-	Update of test case 11.2.5	9.5.0	9.6.0
2011-09	RAN#53	R5-113300	1417	-	GCF Priority 2 - Update test case 9.1.2.3, 9.2.1.1.9, 9.2.1.1.11, 9.2.1.1.25, 9.2.1.2.12, 9.2.2.1.2, 9.2.2.1.3, 9.2.2.1.8, 9.2.2.1.9, 9.2.3.2.4, 9.3.1.6 and 9.3.1.16	9.5.0	9.6.0
2011-09	RAN#53	R5-113325	1418	-	GCF Priority 3 - Correction to testcase 13.3.2.1	9.5.0	9.6.0
2011-09	RAN#53	R5-113331	1420	-	GCF Priority 3 - Corrections to TC 6.3.2 Inter-RAT reselection from GERAN to E-UTRA CSG cell	9.5.0	9.6.0
2011-09	RAN#53	R5-113332	1421	-	Corrections to TC 6.4.7 Inter-RAT reselection from GERAN to E-UTRA Hybrid cell	9.5.0	9.6.0
2011-09	RAN#53	R5-113333	1422	-	Corrections to HeNB Section 6.3 TCs	9.5.0	9.6.0
2011-09	RAN#53	R5-113360	1423	-	Priority 4: Correction to TC 13.1.9 MO call CS fallback to GSM with CCO without NACC	9.5.0	9.6.0
2011-09	RAN#53	R5-113364	1424	-	GCF Priority 3 - Correction to test case 9.3.1.17	9.5.0	9.6.0
2011-09	RAN#53	R5-113374	1425	-	GCF priority 3 - Update to Multi Layer Procedure test case 13.3.1.1	9.5.0	9.6.0
2011-09	RAN#53	R5-113482	1426	-	GCF Priority 3 - Correction to test case 9.2.1.2.5	9.5.0	9.6.0
2011-09	RAN#53	R5-113539	1427	-	GCF Priority 3 - Correction to EMM test case 9.2.1.2.15	9.5.0	9.6.0
2011-09	RAN#53	R5-113573	1428	-	GCF Priority 4 - Editorial correction to EUTRA RRC test case 8.3.2.4	9.5.0	9.6.0
2011-09	RAN#53	R5-113575	1429	-	GCF Priority 3 / 4 - Editorial corrections to EUTRA MAC test cases 7.1.5.x	9.5.0	9.6.0
2011-09	RAN#53	R5-113672	1430	-	GCF Priority 1 - Correction to GCF WI-091 MAC Testcase 7.1.4.15	9.5.0	9.6.0
2011-09	RAN#53	R5-113673	1431	-	GCF Priority 1: Correction to RLC AM test case 7.2.3.6	9.5.0	9.6.0
2011-09	RAN#53	R5-113674	1432	-	GCF Priority 1 - Correction to EUTRA RRC test case 8.5.4.1	9.5.0	9.6.0
2011-09	RAN#53	R5-113675	1433	-	GCF Priority 1 & 3 :Corrections to test cases	9.5.0	9.6.0

Date	TSG #	TSG Doc.	CR	Rev	Subject/Comment	Version Old	Version New
					9.2.3.1.1, 9.2.3.1.9a & 9.2.3.1.27, to make suitable for single frequency operation		
2011-09	RAN#53	R5-113676	1434	-	GCF Priority 2 - Correction to Idle mode test case 6.1.2.6	9.5.0	9.6.0
2011-09	RAN#53	R5-113677	1435	-	GCF Priority 2 Complete SIBs Reading for TC 6.2.2.1_2_3_4	9.5.0	9.6.0
2011-09	RAN#53	R5-113678	1436	-	GCF Priority 2 Complete SIBs Reading for TC 6.2.3	9.5.0	9.6.0
2011-09	RAN#53	R5-113679	1437	-	GCF Priority 2: Correction to DRX test cases 7.1.6.1 and 7.1.6.2	9.5.0	9.6.0
2011-09	RAN#53	R5-113680	1438	-	GCF Priority 2 Complete SIBs Reading for TC 8.4.2.2.4	9.5.0	9.6.0
2011-09	RAN#53	R5-113681	1439	-	GCF Priority 2 & 3: Update of EMM test cases to cater for bands with single frequency operation	9.5.0	9.6.0
2011-09	RAN#53	R5-113682	1440	-	GCF Priority 2 - Update of EMM test cases 9.2.1.2.1	9.5.0	9.6.0
2011-09	RAN#53	R5-113685	1441	-	GCF Priority 2 - Correction to GCF WI-082 EMM LTE MRAT Testcase 9.2.3.1.18/	9.5.0	9.6.0
2011-09	RAN#53	R5-113687	1442	-	GCF Priority 3 Complete SIBs Reading for TC 6.3.2.3.7.8	9.5.0	9.6.0
2011-09	RAN#53	R5-113688	1443	-	GCF Priority 3 - Update of test case 6.2.1.1	9.5.0	9.6.0
2011-09	RAN#53	R5-113689	1444	-	GCF Priority 3 - Update of test case 6.2.3.32	9.5.0	9.6.0
2011-09	RAN#53	R5-113690	1445	-	GCF Priority 3 - Correction to EUTRA MAC test case 7.1.4.14	9.5.0	9.6.0
2011-09	RAN#53	R5-113691	1446	-	GCF Priority 3 - Correction to EUTRA RRC test case 8.2.4.12	9.5.0	9.6.0
2011-09	RAN#53	R5-113692	1447	-	GCF Priority 3 - Correction to EMM test case 9.1.5.1	9.5.0	9.6.0
2011-09	RAN#53	R5-113693	1448	-	GCF Priority 3 - Correction to EMM test cases 9.3.1.4 and 9.3.1.5	9.5.0	9.6.0
2011-09	RAN#53	R5-113694	1449	-	GCF Priority 3 - Correction of test case 9.2.3.1.9a	9.5.0	9.6.0
2011-09	RAN#53	R5-113695	1450	-	GCF Priority 3 - Correction to location update message contents	9.5.0	9.6.0
2011-09	RAN#53	R5-113696	1451	-	GCF Priority 3 - Update of EMM test cases to cater for bands with single frequency and LTE only operation	9.5.0	9.6.0
2011-09	RAN#53	R5-113699	1452	-	GCF Priority 3 - Correction to the value of timer T3402 in EMM test case 9.2.3.1.26	9.5.0	9.6.0
2011-09	RAN#53	R5-113701	1453	-	GCF Priority 3 - Correction to ESM test cases 10.7.3 and 10.8.3	9.5.0	9.6.0
2011-09	RAN#53	R5-113702	1454	-	GCF Priority 4 - Correction to GCF WI-081 Idle Mode Testcase 6.1.1.2	9.5.0	9.6.0
2011-09	RAN#53	R5-113703	1455	-	GCF Priority 4: Correction to Rank Indication test case 7.1.8.1	9.5.0	9.6.0
2011-09	RAN#53	R5-113704	1456	-	GCF Priority 4 - Correction to EUTRA RRC test case 8.1.2.8	9.5.0	9.6.0
2011-09	RAN#53	R5-113705	1457	-	GCF Priority 4 - Correction to 8.1.2.13	9.5.0	9.6.0
2011-09	RAN#53	R5-113706	1458	-	GCF Priority 4 - Update to test cases 8.2.1.5 and 8.2.1.6	9.5.0	9.6.0
2011-09	RAN#53	R5-113707	1459	-	GCF Priority 4 - Correction to EUTRA RRC Test Case 8.4.3.3	9.5.0	9.6.0
2011-09	RAN#53	R5-113708	1460	-	GCF Priority 4 - Addition of EUTRA RRC Test Case 8.4.1.5	9.5.0	9.6.0
2011-09	RAN#53	R5-113709	1461	-	GCF Priority 4 - Correction to EMM test case 9.2.3.2.17	9.5.0	9.6.0
2011-09	RAN#53	R5-113710	1462	-	GCF Priority 4: Correction test case 9.2.1.2.1b to check the signalled MS Radio Access capability	9.5.0	9.6.0
2011-09	RAN#53	R5-113711	1463	-	GCF Priority 4 - Correction to GCF WI-082 ESM Testcase 10.8.7	9.5.0	9.6.0
2011-09	RAN#53	R5-113713	1465	-	GCF Priority 4 - Correction to ESM test case 10.9.1	9.5.0	9.6.0
2011-09	RAN#53	R5-113714	1466	-	GCF Priority 4 - Correction to ESM test case 10.3.1	9.5.0	9.6.0
2011-09	RAN#53	R5-113715	1467	-	GCF Priority 4 - Update to test case 13.1.15	9.5.0	9.6.0
2011-09	RAN#53	R5-113716	1468	-	GCF Priority 4 - Update of test case 13.1.11	9.5.0	9.6.0
2011-09	RAN#53	R5-113717	1469	-	GCF Priority 4 - Update of test case 13.1.12	9.5.0	9.6.0
2011-09	RAN#53	R5-113718	1470	-	GCF Priority 4 - Update of test case 13.1.13	9.5.0	9.6.0
2011-09	RAN#53	R5-113719	1471	-	GCF Priority 4 - Update of test case 13.1.7	9.5.0	9.6.0
2011-09	RAN#53	R5-113720	1472	-	GCF Priority 4 - Update of test case 13.1.8	9.5.0	9.6.0
2011-09	RAN#53	R5-113721	1473	-	GCF Priority 4 - Add new test case 13.4.3.2	9.5.0	9.6.0

Date	TSG #	TSG Doc.	CR	Rev	Subject/Comment	Version Old	Version New
2011-09	RAN#53	R5-113722	1474	-	GCF Priority 4 - Update test case 13.4.3.1	9.5.0	9.6.0
2011-09	RAN#53	R5-113723	1475	-	GCF Priority 4 - Add new test case 13.4.3.4	9.5.0	9.6.0
2011-09	RAN#53	R5-113728	1477	-	Update test case 8.1.2.12	9.5.0	9.6.0
2011-09	RAN#53	R5-113729	1478	-	Addition of new test case for e1xCsFB / MT call	9.5.0	9.6.0
2011-09	RAN#53	R5-113730	1479	-	Addition of new test case for e1xCsFB / MO call	9.5.0	9.6.0
2011-09	RAN#53	R5-113754	1480	-	GCF Priority X - Update to test case 6.4.1	9.5.0	9.6.0
2011-09	RAN#53	R5-113755	1481	-	Various updates to Rel-9 HeNB enhancements test cases	9.5.0	9.6.0
2011-09	RAN#53	R5-113756	1482	-	GCF Priority X Correction of TC 6.4.3.4.5.6.7	9.5.0	9.6.0
2011-09	RAN#53	R5-113757	1483	-	GCF Priority X Addition new test case 8.3.4.2	9.5.0	9.6.0
2011-09	RAN#53	R5-113758	1484	-	GCF Priority X Addition new test case 8.3.4.4	9.5.0	9.6.0
2011-09	RAN#53	R5-113759	1485	-	Addition of new HeNB test case for Inter-frequency SI acquisition member Hybrid Cell	9.5.0	9.6.0
2011-09	RAN#53	R5-113762	1486	-	Addition of a new eMBMS test case 17.2.1: UE Acquire the MBMS data based on the SIB13 and MCCH message /MCCH and MTCH are on the same MCH	9.5.0	9.6.0
2011-09	RAN#53	R5-113763	1487	-	Addition of a new eMBMS test case 17.2.2: UE Acquire the MBMS data based on the SIB13 and MCCH message /MCCH and MTCH are on different MCHs	9.5.0	9.6.0
2011-09	RAN#53	R5-113764	1488	-	Addition of a new eMBMS test case 17.2.3: UE Acquire the MBMS data based on the SIB13 and MCCH message /MCCH and MTCH are on different MCHs	9.5.0	9.6.0
2011-09	RAN#53	R5-113765	1489	-	Addition of a new eMBMS test case 17.2.4: Reception of PDCCH DCI format 0 and PHICH in MBSFN subframes	9.5.0	9.6.0
2011-09	RAN#53	R5-113766	1490	-	Addition of a new TC for MCCH information acquisition/ UE is receiving an MBMS service	9.5.0	9.6.0
2011-09	RAN#53	R5-113767	1491	-	Addition of a new TC for MCCH information acquisition/ /UE is not receiving MBMS data	9.5.0	9.6.0
2011-09	RAN#53	R5-113783	1492	-	GCF Priority X - Addition of new test case 8.2.1.8	9.5.0	9.6.0
2011-09	RAN#53	R5-113792	1493	-	GCF Priority 2 - Correction to GCF WI-081 Idle Mode Interband Testcase 6.1.2.5	9.5.0	9.6.0
2011-09	RAN#53	R5-113793	1494	-	GCF Priority 2 - Correction to GCF WI-091 MAC Testcase 7.1.4.16	9.5.0	9.6.0
2011-09	RAN#53	R5-113805	1496	-	Clarification of LTE only branch in EMM TCs	9.5.0	9.6.0
2011-09	RAN#53	R5-113806	1497	-	GCF Priority 3 - Correction to EMM test case 9.2.1.2.3	9.5.0	9.6.0
2011-09	RAN#53	R5-113807	1498	-	GCF Priority 2 & 3 - Update of EMM test cases 9.2.2.1.6, 9.2.2.1.7, 9.2.2.1.8 and 9.2.2.1.9	9.5.0	9.6.0
2011-09	RAN#53	R5-113808	1499	-	GCF Priority 3 - Correction to EMM test case 9.3.1.6	9.5.0	9.6.0
2011-09	RAN#53	R5-113809	1500	-	GCF Priority 2 - Correction to GCF WI-082 EMM Testcase 9.2.3.3.5	9.5.0	9.6.0
2011-09	RAN#53	R5-113810	1501	-	GCF Priority 3 - Correction to EMM test case 9.2.3.1.4	9.5.0	9.6.0
2011-09	RAN#53	R5-113811	1502	-	GCF Priority 2, 3 & 4 - Update of EMM test cases 9.2.2.2.2, 9.3.1.3, 9.3.1.12a, 9.3.2.2 and 9.3.2.2a	9.5.0	9.6.0
2011-09	RAN#53	R5-113812	1503	-	GCF Priority 3 - Addition of new test case 13.3.2.2	9.5.0	9.6.0
2011-09	RAN#53	R5-113813	1504	-	GCF Priority 1 & 2 - Update of LTE-C2k test cases 8.4.5.4, 8.4.7.3 and 8.4.7.4	9.5.0	9.6.0
2011-09	RAN#53	R5-113836	1505	-	GCF Priority 3 - Correction to WI-082 EUTRA EMM Testcase 9.2.3.1.22	9.5.0	9.6.0
2011-09	RAN#53	R5-113848	1476	-	New E-UTRA MAC test case for padding BSR	9.5.0	9.6.0
2011-09	RAN#53	R5-113849	1464	-	GCF Priority 3 - Correction to EUTRA MAC test cases 7.1.7.1.5 and 7.1.7.1.6	9.5.0	9.6.0
2011-09	RAN#53	R5-113850	1495	-	GCF Priority 2 - Correction to EMM test cases	9.5.0	9.6.0
2011-12	GERAN#52	GP-111502	1506	-	CR 36523-1-1506 Correction to 6.2.3.22	9.6.0	9.7.0
2011-12	GERAN#52	GP-111525	1507	-	CR 36523-1-1507 Addition of new Test case 13.4.2.5 Inter-system mobility / Service based redirection from GSM/GPRS to E-UTRA	9.6.0	9.7.0
2011-12	GERAN#52	GP-111539	1509	-	CR 36523-1-1509 Moving the TCs under section 8.4.4 to void	9.6.0	9.7.0
2011-12	GERAN#52	GP-111540	1510	-	CR 36523-1-1510 Addition of new Test case 13.4.2.6 to 13.4.2.8	9.6.0	9.7.0
2011-12	RAN#54	R5-115138	1511	-	GCF Priority U2 - Correction to EUTRA RRC	9.6.0	9.7.0

Date	TSG #	TSG Doc.	CR	Rev	Subject/Comment	Version Old	Version New
					test case 8.3.3.2		
2011-12	RAN#54	R5-115164	1512	-	GCF Priority 3 - Correction to test case 6.1.2.13	9.6.0	9.7.0
2011-12	RAN#54	R5-115167	1513	-	GCF Priority g1 - Correction to GERAN CSFB test cases	9.6.0	9.7.0
2011-12	RAN#54	R5-115176	1514	-	GCF Priority 4 - Removal of test case 14.3	9.6.0	9.7.0
2011-12	RAN#54	R5-115228	1515	-	GCF Priority 4 - Correction to Idle Mode Testcase 6.1.1.4	9.6.0	9.7.0
2011-12	RAN#54	R5-115230	1516	-	GCF Priority 3: Correction to EMM test cases 9.2.2.2.2, 9.3.1.3, 9.3.2.2, 9.3.2.2a	9.6.0	9.7.0
2011-12	RAN#54	R5-115239	1517	-	GCF Priority 3 - Correction to EUTRA RRC test case 8.3.1.7	9.6.0	9.7.0
2011-12	RAN#54	R5-115244	1518	-	Correction to parameter 'sf-AllocEnd-r9' in MBMS test cases	9.6.0	9.7.0
2011-12	RAN#54	R5-115245	1519	-	Editorial correction to test case 8.1.3.10	9.6.0	9.7.0
2011-12	RAN#54	R5-115272	1520	-	Update of test cases 8.4.7.3, 8.4.7.4, 8.4.7.5 and 8.4.7.6	9.6.0	9.7.0
2011-12	RAN#54	R5-115305	1521	-	GCF Priority X Addition new test case 6.1.2.2a	9.6.0	9.7.0
2011-12	RAN#54	R5-115311	1522	-	GCF Priority X Correction for test cases 8.3.4.1_2_3_4	9.6.0	9.7.0
2011-12	RAN#54	R5-115314	1523	-	Update of TC 11.2.6 IMS Emergency CT1 aspects	9.6.0	9.7.0
2011-12	RAN#54	R5-115355	1524	-	GCF Priority 3 - Correction to EMM test case 9.2.1.1.25	9.6.0	9.7.0
2011-12	RAN#54	R5-115361	1525	-	GCF Priority 2 - Correction to EMM test case 9.2.3.3.5	9.6.0	9.7.0
2011-12	RAN#54	R5-115370	1526	-	Correction to GCF P3 EMM test case 9.3.1.17	9.6.0	9.7.0
2011-12	RAN#54	R5-115448	1527	-	GCF Priority 4 - Correction to EUTRA Idle Mode test case 6.1.1.3	9.6.0	9.7.0
2011-12	RAN#54	R5-115455	1528	-	GCF Priority 4 - Removal of test case 6.1.2.1	9.6.0	9.7.0
2011-12	RAN#54	R5-115511	1529	-	GCF Priority X: Addition of new test case 8.3.1.9a	9.6.0	9.7.0
2011-12	RAN#54	R5-115532	1530	-	Update of TC 11.2.4 IMS Emergency CT1 aspects	9.6.0	9.7.0
2011-12	RAN#54	R5-115539	1531	-	GCF Priority 1 - Correction to EUTRA MAC test case 7.1.4.10	9.6.0	9.7.0
2011-12	RAN#54	R5-115547	1532	-	GCF Priority 1 - Correction to EUTRA MAC test case 7.1.3.3	9.6.0	9.7.0
2011-12	RAN#54	R5-115560	1533	-	GCF Priority 2 (and lower) - Corrections to various EMM test cases	9.6.0	9.7.0
2011-12	RAN#54	R5-115561	1534	-	GCF Priority 2 (and lower) - Corrections to ESM test cases 10.3.1 and 10.9.1	9.6.0	9.7.0
2011-12	RAN#54	R5-115564	1535	-	GCF Priority 1 - Correction to EUTRA MAC test case 7.1.3.9	9.6.0	9.7.0
2011-12	RAN#54	R5-115576	1536	-	GCF Priority 2 - Editorial Correction to EUTRA RLC test case 7.2.3.13	9.6.0	9.7.0
2011-12	RAN#54	R5-115620	1537	-	CGF Priority 1 - Correction to EUTRA MAC test case 7.1.7.2.1	9.6.0	9.7.0
2011-12	RAN#54	R5-115622	1538	-	GCF Priority 1 - Correction to RRC test case 8.5.4.1	9.6.0	9.7.0
2011-12	RAN#54	R5-115624	1539	-	GCF Priority 2 Correction for test cases 6.1.2.13 and 6.1.2.15	9.6.0	9.7.0
2011-12	RAN#54	R5-115625	1540	-	GCF Priority 2 - Correction to Idle Mode test case 6.1.1.1	9.6.0	9.7.0
2011-12	RAN#54	R5-115626	1541	-	GCF Priority 2 - Correction to EMM test case 9.2.3.3.5	9.6.0	9.7.0
2011-12	RAN#54	R5-115627	1542	-	GCF Priority 2: Corrections to equivalent PLMN test case 9.2.3.1.4	9.6.0	9.7.0
2011-12	RAN#54	R5-115628	1543	-	GCF Priority 2: Corrections to test case 9.2.3.1.16	9.6.0	9.7.0
2011-12	RAN#54	R5-115629	1544	-	GCF Priority 3 - Corrections to Idle mode Shared network test cases	9.6.0	9.7.0
2011-12	RAN#54	R5-115630	1545	-	GCF Priority 3: Addition of new idle mode test case for Manual support for CSG ID selection	9.6.0	9.7.0
2011-12	RAN#54	R5-115631	1546	-	GCF Priority 3 - Correction to test case 6.2.3.13	9.6.0	9.7.0
2011-12	RAN#54	R5-115634	1547	-	GCF Priority 3 - Correction to EMM test case 9.2.3.2.1a	9.6.0	9.7.0
2011-12	RAN#54	R5-115635	1548	-	GCF Priority 3 - Correction to EMM test case 9.1.5.1	9.6.0	9.7.0
2011-12	RAN#54	R5-115636	1549	-	GCF Priority 3 - Update of EMM test case 9.3.1.15	9.6.0	9.7.0
2011-12	RAN#54	R5-115637	1550	-	GCF Priority 3 - Update to test case 9.2.3.1.23	9.6.0	9.7.0
2011-12	RAN#54	R5-115638	1551	-	GCF Priority 3 - Correction to ESM test cases 10.8.5	9.6.0	9.7.0

Date	TSG #	TSG Doc.	CR	Rev	Subject/Comment	Version Old	Version New
2011-12	RAN#54	R5-115639	1552	-	GCF Priority 4 - Update to test case 6.1.2.14	9.6.0	9.7.0
2011-12	RAN#54	R5-115640	1553	-	GCF Priority 4 - Correction to GCF WI-081 Idle Mode Testcase 6.1.1.3	9.6.0	9.7.0
2011-12	RAN#54	R5-115642	1554	-	Removal of TC 11.2.9	9.6.0	9.7.0
2011-12	RAN#54	R5-115644	1555	-	GCF Prio 3: Corrections to TC 8.4.3.1	9.6.0	9.7.0
2011-12	RAN#54	R5-115645	1556	-	GCF Priority 4 Correction for test cases 6.2.3.13 and 6.2.3.31	9.6.0	9.7.0
2011-12	RAN#54	R5-115646	1557	-	GCF Priority 4 - Update to EUTRA RRC test case 8.3.1.6	9.6.0	9.7.0
2011-12	RAN#54	R5-115647	1558	-	GCF Priority 4 - Correction to EMM test case 9.2.3.1.17	9.6.0	9.7.0
2011-12	RAN#54	R5-115648	1559	-	GCF Priority 4 - Correction to EMM test cases 9.3.1.12a	9.6.0	9.7.0
2011-12	RAN#54	R5-115649	1560	-	GCF Priority 4: Correction to test case 9.2.1.2.1d	9.6.0	9.7.0
2011-12	RAN#54	R5-115650	1561	-	GCF priority 4: Minor correction to test case 9.2.1.2.1c	9.6.0	9.7.0
2011-12	RAN#54	R5-115651	1562	-	GCF Priority 4 - Add new test case 13.4.3.3	9.6.0	9.7.0
2011-12	RAN#54	R5-115652	1563	-	GCF Priority 4 - Add new test case 13.4.3.5	9.6.0	9.7.0
2011-12	RAN#54	R5-115653	1564	-	GCF Priority 4 - Update test case 13.4.3.2	9.6.0	9.7.0
2011-12	RAN#54	R5-115654	1565	-	GCF Priority 4 - Update test case 13.4.3.1	9.6.0	9.7.0
2011-12	RAN#54	R5-115655	1566	-	GCF Priority 4 - Update test case 13.4.3.4	9.6.0	9.7.0
2011-12	RAN#54	R5-115656	1567	-	GCF Priority 4 - Correction to EMM test case 9.2.3.3.5a	9.6.0	9.7.0
2011-12	RAN#54	R5-115792	1568	-	GCF priority X - new test case 6.1.1.3a for Cell reselection of ePLMN in manual mode / between FDD and TDD	9.6.0	9.7.0
2011-12	RAN#54	R5-115662	1569	-	GCF Priority 4 - Correction to EUTRA RRC test case 8.2.4.8	9.6.0	9.7.0
2011-12	RAN#54	R5-115672	1570	-	Update of TC 11.2.7 IMS Emergency CT1 aspects	9.6.0	9.7.0
2011-12	RAN#54	R5-115673	1571	-	Update of test case 11.2.1	9.6.0	9.7.0
2011-12	RAN#54	R5-115675	1572	-	Update of test case 11.2.3	9.6.0	9.7.0
2011-12	RAN#54	R5-115676	1573	-	Update of test case 11.2.4	9.6.0	9.7.0
2011-12	RAN#54	R5-115677	1574	-	GCF Priority U1: Correction to TC 6.3.7 Inter-RAT Cell reselection from E-UTRA idle non-CSG cell to a UTRA CSG cell	9.6.0	9.7.0
2011-12	RAN#54	R5-115678	1575	-	GCF Priority U1 - Correction to EUTRA RRC testcase 8.4.1.4	9.6.0	9.7.0
2011-12	RAN#54	R5-115680	1576	-	Addition of new Rel-9 test case 6.2.3.7a	9.6.0	9.7.0
2011-12	RAN#54	R5-115681	1577	-	Addition of new Rel-9 test case 6.2.3.8a	9.6.0	9.7.0
2011-12	RAN#54	R5-115682	1578	-	Addition of new Rel-9 test case 6.2.3.9a	9.6.0	9.7.0
2011-12	RAN#54	R5-115683	1579	-	Addition of new Rel-9 test case 6.2.3.10a	9.6.0	9.7.0
2011-12	RAN#54	R5-115684	1580	-	GCF Priority X Addition new test case 6.1.2.3a	9.6.0	9.7.0
2011-12	RAN#54	R5-115685	1581	-	GCF Priority X Addition new test case 6.1.2.17	9.6.0	9.7.0
2011-12	RAN#54	R5-115686	1582	-	GCF Priority X Addition new test case 6.1.2.18	9.6.0	9.7.0
2011-12	RAN#54	R5-115687	1583	-	GCF Priority U2: Correction to TC 6.3.3 Inter-RAT cell reselection / From UTRA_Idle to E-UTRA RRC_IDLE CSG cell	9.6.0	9.7.0
2011-12	RAN#54	R5-115794	1584	-	GCF priority x - Add new test case 6.1.1.1a	9.6.0	9.7.0
2011-12	RAN#54	R5-115691	1585	-	GCF Priority X - Addition of new test case 8.5.1.x	9.6.0	9.7.0
2011-12	RAN#54	R5-115692	1586	-	GCF Priority X - Addition of new test case 8.1.2.x	9.6.0	9.7.0
2011-12	RAN#54	R5-115693	1587	-	GCF Priority X: Addition of new test case 8.3.1.11a	9.6.0	9.7.0
2011-12	RAN#54	R5-115709	1588	-	GCF Priority 4 - Update of test cases 13.1.11	9.6.0	9.7.0
2011-12	RAN#54	R5-115710	1589	-	GCF Priority 4 - Update of test cases 13.1.12	9.6.0	9.7.0
2011-12	RAN#54	R5-115711	1590	-	GCF Priority 4 - Update of test cases 13.1.13	9.6.0	9.7.0
2011-12	RAN#54	R5-115712	1591	-	Addition of new test case for e1xCsFB emergency call	9.6.0	9.7.0
2011-12	RAN#54	R5-115713	1592	-	Addition of new test case for 1xCsFB emergency call	9.6.0	9.7.0
2011-12	RAN#54	R5-115720	1593	-	GCF Priority 3 - Correction to EMM test case 9.2.3.1.26	9.6.0	9.7.0
2011-12	RAN#54	R5-115722	1594	-	Maximum bandwidth config for MAC TBS test cases in band 25	9.6.0	9.7.0
2011-12	RAN#54	R5-115726	1595	-	GCF Priority 1 - Correction to EUTRA MAC test case 7.1.4.5	9.6.0	9.7.0
2011-12	RAN#54	R5-115793	1596	-	Addition of a new TC for Cell reselection / interband operation / Between FDD and TDD	9.6.0	9.7.0
2011-12	RAN#54	R5-115753	1597	-	Update of test case 6.2.3.8 and 6.2.3.10	9.6.0	9.7.0

Date	TSG #	TSG Doc.	CR	Rev	Subject/Comment	Version Old	Version New
2011-12	RAN#54	R5-115795	1598	-	PLMN selection in shared network environment / Automatic mode / between FDD and TDD	9.6.0	9.7.0
2011-12	RAN#54	R5-115796	1599	-	Inter-frequency cell reselection according to cell reselection priority provided by SIBs / Between FDD and TDD	9.6.0	9.7.0
2011-12	RAN#54	R5-115797	1600	-	Addition of new test case 6.2.3.1a	9.6.0	9.7.0
2011-12	RAN#54	R5-115763	1602	-	GCF Priority 4: Modification on the Event A3 timeToTrigger value in TC 8.3.1.6	9.6.0	9.7.0
2011-12	RAN#54	R5-115798	1603	-	GCF Priority 2 - Update of EMM test case 9.2.2.1.7	9.6.0	9.7.0
2011-12	RAN#54	R5-115766	1604	-	GCF Priority 3 - Correction to EMM test cases 9.2.3.1.22	9.6.0	9.7.0
2011-12	RAN#54	R5-115767	1605	-	GCF Priority 3 - Update of EMM test cases 9.2.3.1.26 Preamble	9.6.0	9.7.0
2011-12	RAN#54	R5-115768	1606	-	GCF Priority 2 - Update of EMM test cases 9.2.3.2.3	9.6.0	9.7.0
2011-12	RAN#54	R5-115769	1607	-	GCF Priority 2 - Update test case 9.2.3.1.6	9.6.0	9.7.0
2011-12	RAN#54	R5-115771	1608	-	Update test case 11.2.2	9.6.0	9.7.0
2011-12	RAN#54	R5-115774	1609	-	GCF Priority 2 - Correction to Idle mode test case 6.2.2.5	9.6.0	9.7.0
2012-03	RAN#55	R5-120125	1610	-	GCF Priority 1 - Correction of test case 7.1.2.6	9.7.0	9.8.0
2012-03	RAN#55	R5-120156	1611	-	GCF Priority X Correction of test case 6.1.2.2a	9.7.0	9.8.0
2012-03	RAN#55	R5-120158	1612	-	GCF Priority X Correction of test case 6.1.2.18	9.7.0	9.8.0
2012-03	RAN#55	R5-120174	1613	-	GCF Priority 2: Modification on TC 8.1.3.4 RRC connection release / Redirection to another E-UTRAN frequency	9.7.0	9.8.0
2012-03	RAN#55	R5-120236	1614	-	GCF priority c1: Correction of measurement gap offset	9.7.0	9.8.0
2012-03	RAN#55	R5-120265	1615	-	GCF Priority 2 - Correction to EMM test case 9.2.3.1.4	9.7.0	9.8.0
2012-03	RAN#55	R5-120267	1616	-	GCF Priority 2 - Correction to EUTRA Idle mode testcase 6.1.2.13	9.7.0	9.8.0
2012-03	RAN#55	R5-120268	1617	-	GCF Priority 3 - Correction to EUTRA MAC testcase 7.1.3.2	9.7.0	9.8.0
2012-03	RAN#55	R5-120269	1618	-	GCF Priority 4 - Correction to EUTRA MAC testcase 7.1.4.7a	9.7.0	9.8.0
2012-03	RAN#55	R5-120270	1619	-	GCF Priority 1 - Correction to EUTRA RLC testcase 7.2.3.8	9.7.0	9.8.0
2012-03	RAN#55	R5-120271	1620	-	GCF Priority 3 - Correction to EUTRA testcase 8.3.1.11	9.7.0	9.8.0
2012-03	RAN#55	R5-120272	1621	-	GCF Priority u1 - Correction to EUTRA RRC test case 8.3.3.2 and 8.3.3.3	9.7.0	9.8.0
2012-03	RAN#55	R5-120273	1622	-	GCF Priority u1 - Correction to EMM test case 9.2.3.1.6	9.7.0	9.8.0
2012-03	RAN#55	R5-120356	1623	-	GCF Priority 3 - Correction to EUTRA RRC test case 8.3.1.4	9.7.0	9.8.0
2012-03	RAN#55	R5-120357	1624	-	GCF Priority 3 - Correction to EMM test case 9.2.1.1.23	9.7.0	9.8.0
2012-03	RAN#55	R5-120398	1625	-	GCF Priority 3 - Correction to EMM test case 9.2.3.1.16	9.7.0	9.8.0
2012-03	RAN#55	R5-120400	1626	-	GCF Priority 3 - Correction to EMM test case 9.2.3.1.23	9.7.0	9.8.0
2012-03	RAN#55	R5-120403	1627	-	Update of IMS emergency call test case 11.2.1	9.7.0	9.8.0
2012-03	RAN#55	R5-120440	1628	-	GCF Priority X - Update to test case 8.2.1.8	9.7.0	9.8.0
2012-03	RAN#55	R5-120441	1629	-	GCF Priority X - Addition of new test case 8.3.1.3a	9.7.0	9.8.0
2012-03	RAN#55	R5-120482	1630	-	Clarification on specifying parameter values without taking into account uncertainties	9.7.0	9.8.0
2012-03	RAN#55	R5-120490	1631	-	GCF Priority 4 - Correction to EMM test case 9.2.3.2.13	9.7.0	9.8.0
2012-03	RAN#55	R5-120494	1632	-	GCF Priority X Correction of test case 6.1.2.17	9.7.0	9.8.0
2012-03	RAN#55	R5-120528	1633	-	GCF Priority 2 - Correction to EUTRA RRC test case 8.3.2.3	9.7.0	9.8.0
2012-03	RAN#55	R5-120541	1634	-	GCF Priority 4: Correction to ESM test case 10.3.1	9.7.0	9.8.0
2012-03	RAN#55	R5-120542	1635	-	GCF Priority 4: Correction to ESM test case 10.9.1	9.7.0	9.8.0
2012-03	RAN#55	R5-120584	1636	-	GCF Priority U1 - Correction to EUTRA Idle Mode test case 6.2.1.3	9.7.0	9.8.0
2012-03	RAN#55	R5-120622	1637	-	GCF Priority 2 : Update of inter band cell reselection test case 6.1.2.5 to cater for bands with single frequency operation	9.7.0	9.8.0
2012-03	RAN#55	R5-120623	1638	-	GCF Priority 2 - Correction to EMM test case	9.7.0	9.8.0

Date	TSG #	TSG Doc.	CR	Rev	Subject/Comment	Version Old	Version New
					9.2.3.1.6		
2012-03	RAN#55	R5-120624	1639	-	GCF Priority 2 - Correction to EMM test case 9.2.3.2.1a	9.7.0	9.8.0
2012-03	RAN#55	R5-120625	1640	-	GCF Priority 2 (and lower) - Correction of TAI list fields in EMM test cases	9.7.0	9.8.0
2012-03	RAN#55	R5-120627	1641	-	GCF Priority 3 : Update of EMM test cases 9.2.3.1.17 and 9.2.3.1.19	9.7.0	9.8.0
2012-03	RAN#55	R5-120628	1642	-	GCF Priority 3 : Update of EMM authentication test case 9.1.2.6 to cater for bands with single frequency operation	9.7.0	9.8.0
2012-03	RAN#55	R5-120629	1643	-	GCF Priority 3 - Correction to EMM test case 9.2.3.1.26	9.7.0	9.8.0
2012-03	RAN#55	R5-120630	1644	-	GCF Priority 3 - Correction to EMM test case 9.2.3.3.4	9.7.0	9.8.0
2012-03	RAN#55	R5-120633	1646	-	GCF Priority 4 - Correction to EMM test case 9.2.1.1.18	9.7.0	9.8.0
2012-03	RAN#55	R5-120635	1647	-	GCF Priority 4 - Update to test case 13.4.3.3	9.7.0	9.8.0
2012-03	RAN#55	R5-120636	1648	-	GCF Priority 4 - Update to test case 13.4.3.5	9.7.0	9.8.0
2012-03	RAN#55	R5-120637	1649	-	GCF Priority 4 - Update test case 13.4.3.2	9.7.0	9.8.0
2012-03	RAN#55	R5-120638	1650	-	GCF Priority 4 - Update to test case 14.1 and 14.2	9.7.0	9.8.0
2012-03	RAN#55	R5-120639	1651	-	GCF Priority u1 Correction of test case 6.2.3.3	9.7.0	9.8.0
2012-03	RAN#55	R5-120640	1652	-	GCF Priority U1 - update of E-UTRA Idle mode test case 6.2.2.5	9.7.0	9.8.0
2012-03	RAN#55	R5-120641	1653	-	GCF Priority U1 - update of E-UTRA RRC test case 8.1.3.7	9.7.0	9.8.0
2012-03	RAN#55	R5-120642	1654	-	GCF Priority U1 - update of E-UTRA RRC test case 8.3.2.4	9.7.0	9.8.0
2012-03	RAN#55	R5-120643	1655	-	GCF Priority u1 - Correction to EMM test case 9.2.3.3.1	9.7.0	9.8.0
2012-03	RAN#55	R5-120644	1656	-	GCF Priority u1 - Correction to EMM test case 9.2.1.2.1b	9.7.0	9.8.0
2012-03	RAN#55	R5-120645	1657	-	GCF Priority U1 - update of E-UTRA Multi-Layer test case 13.4.2.1	9.7.0	9.8.0
2012-03	RAN#55	R5-120646	1658	-	GCF Priority U1 - update of E-UTRA Multi-Layer test case 13.4.2.4	9.7.0	9.8.0
2012-03	RAN#55	R5-120647	1659	-	GCF Priority u1 - Correction to Multilayer test case 13.1.2	9.7.0	9.8.0
2012-03	RAN#55	R5-120649	1660	-	GCF Priority U2 - update of E-UTRA RRC test case 8.3.2.3	9.7.0	9.8.0
2012-03	RAN#55	R5-120650	1661	-	8.1.3.12a RRC connection release / Success / With priority information / Inter-band / Between FDD and TDD	9.7.0	9.8.0
2012-03	RAN#55	R5-120651	1662	-	8.1.3.11a RRC connection release / Redirection to another E-UTRAN band / Between FDD and TDD	9.7.0	9.8.0
2012-03	RAN#55	R5-120652	1663	-	8.2.4.13a RRC connection reconfiguration / Handover / Success (with measurement) / Inter-band / Between FDD and TDD	9.7.0	9.8.0
2012-03	RAN#55	R5-120653	1664	-	8.2.4.14a RRC connection reconfiguration / Handover / Failure / Re-establishment successful / Inter-band / Between FDD and TDD	9.7.0	9.8.0
2012-03	RAN#55	R5-120654	1665	-	8.2.4.15a RRC connection reconfiguration / Handover / Failure / Re-establishment failure / Inter-band / Between FDD and TDD	9.7.0	9.8.0
2012-03	RAN#55	R5-120657	1666	-	8.3.1.14a Measurement configuration control and reporting / Intra E-UTRAN measurements / Two simultaneous events A2 and A3 (inter-band measurements) / Between FDD and TDD	9.7.0	9.8.0
2012-03	RAN#55	R5-120658	1667	-	8.3.1.15a Measurement configuration control and reporting / Intra E-UTRAN measurements / Inter-band handover / IE measurement configuration not present / Between FDD and TDD	9.7.0	9.8.0
2012-03	RAN#55	R5-120659	1668	-	8.3.1.16a Measurement configuration control and reporting / Intra E-UTRAN measurements / Continuation of the measurements after RRC connection re-establishment / Inter-band / Between FDD and TDD	9.7.0	9.8.0
2012-03	RAN#55	R5-120660	1669	-	GCF Priority u2 - Correction to EUTRA RRC test case 8.3.3.3	9.7.0	9.8.0
2012-03	RAN#55	R5-120661	1670	-	GCF Priority U2 - update of E-UTRA RRC test	9.7.0	9.8.0

Date	TSG #	TSG Doc.	CR	Rev	Subject/Comment	Version Old	Version New
					case 8.4.2.2		
2012-03	RAN#55	R5-120662	1671	-	GCF Priority U2 - update of E-UTRA RRC test case 8.4.2.4	9.7.0	9.8.0
2012-03	RAN#55	R5-120663	1672	-	GCF Priority U2 - update of E-UTRA Multi-Layer test case 13.1.2	9.7.0	9.8.0
2012-03	RAN#55	R5-120664	1673	-	GCF Priority U2 - update of E-UTRA Multi-Layer test case 13.1.3	9.7.0	9.8.0
2012-03	RAN#55	R5-120665	1674	-	GCF Priority U2 - update of E-UTRA Multi-Layer test case 13.1.15	9.7.0	9.8.0
2012-03	RAN#55	R5-120666	1675	-	GCF Priority U2 - update of E-UTRA Multi-Layer test case 13.4.3.1	9.7.0	9.8.0
2012-03	RAN#55	R5-120667	1676	-	GCF Priority U2 - update of E-UTRA Multi-Layer test case 13.4.3.2	9.7.0	9.8.0
2012-03	RAN#55	R5-120668	1677	-	GCF Priority U2 - update of E-UTRA Multi-Layer test case 13.4.3.4	9.7.0	9.8.0
2012-03	RAN#55	R5-120669	1678	-	GCF Priority M1 - update of E-UTRA RRC test case 8.3.2.5	9.7.0	9.8.0
2012-03	RAN#55	R5-120670	1679	-	GCF Priority M1 - update of E-UTRA RRC test case 8.3.2.6	9.7.0	9.8.0
2012-03	RAN#55	R5-120671	1680	-	GCF Priority g1 - Correction to EUTRA Idle mode test case 6.2.3.1	9.7.0	9.8.0
2012-03	RAN#55	R5-120673	1681	-	GCF Priority X Correction of test case 6.1.2.3a	9.7.0	9.8.0
2012-03	RAN#55	R5-120674	1682	-	GCF Priority X Addition of new test case 6.2.3.3a	9.7.0	9.8.0
2012-03	RAN#55	R5-120675	1683	-	GCF Priority X Addition of new test case 6.2.3.5a	9.7.0	9.8.0
2012-03	RAN#55	R5-120676	1684	-	GCF Priority X - Addition of new test case 6.2.3.x	9.7.0	9.8.0
2012-03	RAN#55	R5-120695	1685	-	Update of test case 11.2.4	9.7.0	9.8.0
2012-03	RAN#55	R5-120696	1686	-	Update of test case 11.2.5	9.7.0	9.8.0
2012-03	RAN#55	R5-120697	1687	-	GCF Priority X - Update of TC 11.2.8 to include IMS procedures	9.7.0	9.8.0
2012-03	RAN#55	R5-120698	1688	-	Update test case 11.2.2	9.7.0	9.8.0
2012-03	RAN#55	R5-120699	1689	-	GCF Priority x - Update test case 8.1.2.11	9.7.0	9.8.0
2012-03	RAN#55	R5-120700	1690	-	GCF Priority x - Update test case 8.1.2.12	9.7.0	9.8.0
2012-03	RAN#55	R5-120701	1691	-	GCF Priority x : Update of titles of test cases 8.3.1.9a and 8.3.1.11a	9.7.0	9.8.0
2012-03	RAN#55	R5-120703	1693	-	Addition of new test 11.2.10	9.7.0	9.8.0
2012-03	RAN#55	R5-120705	1694	-	GCF Priority X - Addition of new test case 8.3.2.3a	9.7.0	9.8.0
2012-03	RAN#55	R5-120707	1695	-	GCF Priority 4 (and higher) - Editorial corrections to various EMM test cases	9.7.0	9.8.0
2012-03	RAN#55	R5-120708	1696	-	Addition of new Rel-9 test case 13.4.4.1	9.7.0	9.8.0
2012-03	RAN#55	R5-120709	1697	-	Addition of new Rel-9 test case 13.4.4.2	9.7.0	9.8.0
2012-03	RAN#55	R5-120710	1698	-	GCF Priority X - update of E-UTRA Multi-Layer test case 13.1.2a	9.7.0	9.8.0
2012-03	RAN#55	R5-120711	1699	-	Modification of TC 8.4.7.1: Inter-RAT handover / SRVCC from E-UTRA to 1xRTT(CS) / Speech	9.7.0	9.8.0
2012-03	RAN#55	R5-120712	1700	-	Addition for new 13.4.4.3 LTE-CDMA2000-HRPD interworking test case	9.7.0	9.8.0
2012-03	RAN#55	R5-120713	1701	-	Addition for new 13.4.4.4 LTE-CDMA2000-HRPD interworking test case	9.7.0	9.8.0
2012-03	RAN#55	R5-120714	1702	-	8.3.1.12a Measurement configuration control and reporting / Intra E-UTRAN measurements / Two simultaneous events A3 (inter-band measurements) / Between FDD and TDD	9.7.0	9.8.0
2012-03	RAN#55	R5-120715	1703	-	8.3.1.13a Measurement configuration control and reporting / Intra E-UTRAN measurements / Periodic reporting (intra-frequency and inter-band measurements) / Between FDD and TDD	9.7.0	9.8.0
2012-03	RAN#55	R5-120741	1716	-	GCF Priority X - Addition of new test case 8.6.4.y	9.7.0	9.8.0
2012-03	RAN#55	R5-120742	1717	-	GCF Priority X - Addition of new test case 8.6.4.z	9.7.0	9.8.0
2012-03	RAN#55	R5-120743	1718	-	GCF Priority X - Addition of new test case 8.6.x.y	9.7.0	9.8.0
2012-03	RAN#55	R5-120744	1719	-	GCF Priority X - Addition of new test case 8.6.x.z	9.7.0	9.8.0
2012-03	RAN#55	R5-120751	1720	-	Addition of new Rel-9 test case 18.1.1	9.7.0	9.8.0
2012-03	RAN#55	R5-120757	1721	-	GCF Priority 2 : Introduction of new equivalent , 6.1.2.x test cases to cater for bands with single frequency operation	9.7.0	9.8.0
2012-03	RAN#55	R5-120758	1722	-	GCF Priority 2 : Introduction of new equivalent	9.7.0	9.8.0

Date	TSG #	TSG Doc.	CR	Rev	Subject/Comment	Version Old	Version New
					6.1.1.x test cases to cater for bands with single frequency operation		
2012-03	RAN#55	R5-120760	1723	-	GCF Priority U1 - Correction to EUTRA RRC test case 8.1.3.7	9.7.0	9.8.0
2012-03	RAN#55	R5-120764	1724	-	GCF Priority U1 - Correction to EUTRA RRC test cases 8.4.1.2 and 8.4.1.4	9.7.0	9.8.0
2012-03	RAN#55	R5-120765	1725	-	GCF Priority 2 - Correction to EMM test case 9.2.3.2.1	9.7.0	9.8.0
2012-03	RAN#55	R5-120766	1726	-	GCF Priority u1 - Update to test case 9.2.3.3.2	9.7.0	9.8.0
2012-03	RAN#55	R5-120767	1727	-	GCF Priority u1 - Update to test case 9.2.3.3.3	9.7.0	9.8.0
2012-03	RAN#55	R5-120768	1728	-	GCF Priority u1 - Update to test case 9.2.3.3.5	9.7.0	9.8.0
2012-03	RAN#55	R5-120769	1729	-	GCF Priority X - Update of test cases 6.2.2.3, 6.2.3.7, 6.2.3.7a, 6.2.3.8, 6.2.3.8a, 6.2.3.9, 6.2.3.9a, 6.2.3.10, 6.2.3.10a	9.7.0	9.8.0
2012-03	RAN#55	R5-120771	1731	-	GCF Priority 3 - Correction to Idle Mode test case 6.1.2.13	9.7.0	9.8.0
2012-03	RAN#55	R5-120776	1732	-	GCF Priority UX – Correction to EUTRA to UTRA Handover testcases	9.7.0	9.8.0
2012-03	RAN#55	R5-120631	1645	-	Addition of new MDT test case for 'Logged MDT / Intra-frequency measurement, logging and reporting / E-UTRA handover'	9.8.0	10.0.0
2012-03	RAN#55	R5-120724	1704	-	Addition of a new TC 17.3.1 for MBMS Counting / UE not receiving MBMS service	9.8.0	10.0.0
2012-03	RAN#55	R5-120727	1705	-	CA / RRC connection reconfiguration / Carrier Aggregation / SCell addition/ modification/release / Success	9.8.0	10.0.0
2012-03	RAN#55	R5-120728	1706	-	CA / RRC connection reconfiguration / Carrier Aggregation / SCell SI change / Success	9.8.0	10.0.0
2012-03	RAN#55	R5-120729	1707	-	CA / RRC connection reconfiguration / SCell addition without UL	9.8.0	10.0.0
2012-03	RAN#55	R5-120730	1708	-	CA / RRC connection reconfiguration / Handover / Success / SCell addition	9.8.0	10.0.0
2012-03	RAN#55	R5-120731	1709	-	CA / RRC connection reconfiguration / Handover / Success / SCell becomes PCell	9.8.0	10.0.0
2012-03	RAN#55	R5-120732	1710	-	CA / Measurement configuration control and reporting / Intra E-UTRAN measurements / Event A6	9.8.0	10.0.0
2012-03	RAN#55	R5-120733	1711	-	CA / Measurement configuration control and reporting / Intra E-UTRAN measurements / Additional measurement reporting	9.8.0	10.0.0
2012-03	RAN#55	R5-120734	1712	-	Addition of new Rel-10 test case 7.1.3.11 CA / Correct HARQ process handling / DCCH and DTCH / Pcell and Scell	9.8.0	10.0.0
2012-03	RAN#55	R5-120738	1713	-	Addition of new MDT test case for 'Logged MDT / Intra-frequency measurement, logging and reporting / Limiting area scope'	9.8.0	10.0.0
2012-03	RAN#55	R5-120739	1714	-	New Logged MDT test case 8.6.2.1 (Intra-frequency measurement, logging and reporting)	9.8.0	10.0.0
2012-03	RAN#55	R5-120740	1715	-	New Logged MDT test case 8.6.2.2 (Inter-frequency measurement, logging and reporting)	9.8.0	10.0.0
2012-03	RAN#55	R5-120770	1730	-	Addition of a new Rel-10 test case 17.3.2	9.8.0	10.0.0
2012-06	RAN#55	R5-120638	1650	-	GCF Priority 4 - Update to test case 14.1 and 14.2 (addition in Table 14.2.3.2-1 of forgotten Step 5 alert check and Note)	10.0.0	10.1.0
2012-06	RAN#56	R5-121080	1738	-	GCF Priority m1: Optimisation of frequency allocation	10.0.0	10.1.0
2012-06	RAN#56	R5-121081	1739	-	GCF Priority P2: Optimisation of frequency allocation	10.0.0	10.1.0
2012-06	RAN#56	R5-121087	1740	-	GCF Priority U1 - Correction to EUTRA RRC test case 8.1.3.7	10.0.0	10.1.0
2012-06	RAN#56	R5-121099	1741	-	GCF Priority U1 - Correction to EMM test case 9.2.3.3.6	10.0.0	10.1.0
2012-06	RAN#56	R5-121106	1742	-	GCF Priority U1 - Correction to test EUTRA-UTRA test case 13.3.2.1	10.0.0	10.1.0
2012-06	RAN#56	R5-121108	1743	-	GCF Priority C1 - Correction to test cases 6.2.3.8 and 6.2.3.8a	10.0.0	10.1.0
2012-06	RAN#56	R5-121142	1744	-	GCF priority 3 - Correction to idle mode test case 6.1.2.13	10.0.0	10.1.0
2012-06	RAN#56	R5-121158	1745	-	GCF Priority X - corrections to TC 13.4.4.3	10.0.0	10.1.0
2012-06	RAN#56	R5-121159	1746	-	GCF Priority X - corrections to TC 13.4.4.4	10.0.0	10.1.0
2012-06	RAN#56	R5-121202	1747	-	GCF priority x - Update of test case 6.1.1.1a	10.0.0	10.1.0
2012-06	RAN#56	R5-121275	1748	-	GCF Priority 2 - Update of test cases 9.3.1.4	10.0.0	10.1.0
2012-06	RAN#56	R5-121278	1749	-	GCF Priority X - Update of Inter-system session	10.0.0	10.1.0

Date	TSG #	TSG Doc.	CR	Rev	Subject/Comment	Version Old	Version New
					management test case 13.4.4.1 and 13.4.4.2		
2012-06	RAN#56	R5-121289	1750	-	GCF Priority X - Update to test case 8.6.6.1	10.0.0	10.1.0
2012-06	RAN#56	R5-121293	1751	-	GCF Priority X - Addition of new test case 8.2.4.13	10.0.0	10.1.0
2012-06	RAN#56	R5-121295	1752	-	GCF Priority X - Addition of new test case 8.2.4.15	10.0.0	10.1.0
2012-06	RAN#56	R5-121296	1753	-	GCF Priority X - Addition of new test case 8.3.1.15	10.0.0	10.1.0
2012-06	RAN#56	R5-121297	1754	-	GCF Priority X - Addition of new test case 8.3.1.16	10.0.0	10.1.0
2012-06	RAN#56	R5-121394	1755	-	GCF Priority 4 Correction of test case 8.2.4.10	10.0.0	10.1.0
2012-06	RAN#56	R5-121411	1756	-	GCF Priority 4 - Update test case 8.1.2.6	10.0.0	10.1.0
2012-06	RAN#56	R5-121412	1757	-	GCF Priority 4 - Update test case 8.1.2.9	10.0.0	10.1.0
2012-06	RAN#56	R5-121419	1758	-	GCF Priority 2 and 3 - Removal of 'Active' flag test cases	10.0.0	10.1.0
2012-06	RAN#56	R5-121426	1759	-	Changing to Void of GERAN to E-UTRAN section 8.4.4	10.0.0	10.1.0
2012-06	RAN#56	R5-121437	1760	-	GCF Priority g1 - Correction to EUTRA test case 8.1.3.8	10.0.0	10.1.0
2012-06	RAN#56	R5-121450	1761	-	GCF Priority 3 - Correction to EUTRA MAC testcase 7.1.4.2	10.0.0	10.1.0
2012-06	RAN#56	R5-121465	1762	-	GCF Priority 1 and 3 - Correction to EMM test cases 9.2.1.1.2 and 9.2.2.1.8	10.0.0	10.1.0
2012-06	RAN#56	R5-121466	1763	-	GCF Priority U1 - Correction to multi-layer test case 13.1.5	10.0.0	10.1.0
2012-06	RAN#56	R5-121504	1764	-	GCF priority 2: Correction to test case 9.2.1.17	10.0.0	10.1.0
2012-06	RAN#56	R5-121505	1765	-	GCF priority G1: Correction to test case 13.4.2.2	10.0.0	10.1.0
2012-06	RAN#56	R5-121511	1766	-	Introduction of new PWS test case 18.1.4	10.0.0	10.1.0
2012-06	RAN#56	R5-121517	1767	-	Introduction of new Rel10 CA test case 7.1.4.21	10.0.0	10.1.0
2012-06	RAN#56	R5-121541	1768	-	GCF Priority 1, 2, 3, 4 and U1 - Correction to EMM test cases to use new PICS	10.0.0	10.1.0
2012-06	RAN#56	R5-121548	1769	-	GCF Priority 1 - Correction to EUTRA RRC test case 8.5.4.1	10.0.0	10.1.0
2012-06	RAN#56	R5-121550	1770	-	GCF Priority 4 - Correction to ESM test case 10.8.7	10.0.0	10.1.0
2012-06	RAN#56	R5-121623	1771	-	Radio Link Failure logging / Reporting at GERAN Inter-RAT handover	10.0.0	10.1.0
2012-06	RAN#56	R5-121632	1772	-	GCF Priority 4 - Update test case 13.4.3.4	10.0.0	10.1.0
2012-06	RAN#56	R5-121666	1773	-	GCF Priority 3 - Correction to EMM test case 9.2.3.1.17	10.0.0	10.1.0
2012-06	RAN#56	R5-121703	1774	-	GCF Priority u1 - Correction to Multilayer test case 13.4.2.4	10.0.0	10.1.0
2012-06	RAN#56	R5-121738	1775	-	GCF Priority 1 and 3 - Correction to EUTRA MAC test cases 7.1.7.1.1, 7.1.7.1.2, 7.1.7.1.3, 7.1.7.1.4, 7.1.7.1.5, 7.1.7.1.6 and 7.1.7.2.1	10.0.0	10.1.0
2012-06	RAN#56	R5-121739	1776	-	GCF Priority 1 - Correction to EMM test case 9.2.3.1.5	10.0.0	10.1.0
2012-06	RAN#56	R5-121740	1777	-	GCF Priority 2: Addition of equivalent EMM test cases for single frequency operation	10.0.0	10.1.0
2012-06	RAN#56	R5-121742	1778	-	GCF Priority 2: Corrections to EMM test cases to enable single frequency operation	10.0.0	10.1.0
2012-06	RAN#56	R5-121743	1779	-	GCF Priority 2 - Update to test case 10.4.1	10.0.0	10.1.0
2012-06	RAN#56	R5-121744	1780	-	GCF Priority 3 - Correction to EUTRA MAC testcase 7.1.3.2	10.0.0	10.1.0
2012-06	RAN#56	R5-121746	1781	-	GCF Priority 4 - Correction to EMM CSG test case 9.3.1.18	10.0.0	10.1.0
2012-06	RAN#56	R5-121747	1782	-	GCF Priority 3 Update of TC 9.2.3.1.23	10.0.0	10.1.0
2012-06	RAN#56	R5-121748	1783	-	GCF Priority 3 - Correction to EMM test case 9.2.1.1.23, 9.2.3.2.4, 9.2.3.2.14, 9.2.3.2.2, 9.2.3.2.17	10.0.0	10.1.0
2012-06	RAN#56	R5-121749	1784	-	GCF Priority 3 - Correction to EMM test case 9.2.3.1.4	10.0.0	10.1.0
2012-06	RAN#56	R5-121750	1785	-	GCF Priority 3 - Correction to EMM test case 9.2.2.1.7	10.0.0	10.1.0
2012-06	RAN#56	R5-121753	1786	-	GCF Priority 4 - Correction to EUTRA Idle Mode test cases 6.1.1.6 and 6.1.1.6a	10.0.0	10.1.0
2012-06	RAN#56	R5-121754	1787	-	GCF priority 4 - Correction to Idle Mode test case 6.1.2.12	10.0.0	10.1.0
2012-06	RAN#56	R5-121755	1788	-	GCF Priority 4 - Correction to Idle mode test case 6.1.1.6a	10.0.0	10.1.0
2012-06	RAN#56	R5-121756	1789	-	GCF Priority 4 - Editorial corrections to some EMM test cases	10.0.0	10.1.0

Date	TSG #	TSG Doc.	CR	Rev	Subject/Comment	Version Old	Version New
2012-06	RAN#56	R5-121757	1790	-	GCF Priority 4 - Update test case 13.4.3.1	10.0.0	10.1.0
2012-06	RAN#56	R5-121758	1791	-	GCF Priority 4 - Update test case 13.4.3.2	10.0.0	10.1.0
2012-06	RAN#56	R5-121759	1792	-	GCF Priority 4 - Update to test case 14.2	10.0.0	10.1.0
2012-06	RAN#56	R5-121760	1793	-	GCF Priority u1 - Update to EUTRA Idle Mode test case 6.2.1.2	10.0.0	10.1.0
2012-06	RAN#56	R5-121761	1794	-	GCF Priority u1 - Correction to EUTRA Idle Mode test case 6.2.1.3	10.0.0	10.1.0
2012-06	RAN#56	R5-121762	1795	-	GCF Priority u1 - Correction to EMM test case 9.2.1.2.11	10.0.0	10.1.0
2012-06	RAN#56	R5-121763	1796	-	GCF Priority u1 - Correction to EMM test case 9.2.1.2.15	10.0.0	10.1.0
2012-06	RAN#56	R5-121764	1797	-	GCF Priority u1 - Correction to EMM test case 9.2.3.3.5	10.0.0	10.1.0
2012-06	RAN#56	R5-121765	1798	-	GCF Priority u1 - Correction to EMM test case 9.2.1.2.1d	10.0.0	10.1.0
2012-06	RAN#56	R5-121766	1799	-	GCF Priority u1 - Correction to EMM test case 9.2.3.2.1c	10.0.0	10.1.0
2012-06	RAN#56	R5-121767	1800	-	GCF Priority U1 - Correction to EUTRA Multi-Layer test case 13.1.4	10.0.0	10.1.0
2012-06	RAN#56	R5-121768	1801	-	GCF Priority U1 - Correction to multi-layer test case 13.4.2.1	10.0.0	10.1.0
2012-06	RAN#56	R5-121771	1802	-	GCF Priority g1 - Correction to EUTRA test case 6.2.2.2	10.0.0	10.1.0
2012-06	RAN#56	R5-121772	1803	-	GCF Priority g1 - Correction to EUTRA test case 6.2.3.1	10.0.0	10.1.0
2012-06	RAN#56	R5-121773	1804	-	GCF Priority g1 - Correction to EUTRA test case 8.3.2.2	10.0.0	10.1.0
2012-06	RAN#56	R5-121774	1805	-	GCF Priority g1 - Update to test case 9.2.3.3.5a	10.0.0	10.1.0
2012-06	RAN#56	R5-121775	1806	-	GCF Priority g1 - Correction to EMM test case 9.2.3.4.1	10.0.0	10.1.0
2012-06	RAN#56	R5-121776	1807	-	GCF Priority g2 Correction of test case 8.4.3.1	10.0.0	10.1.0
2012-06	RAN#56	R5-121780	1808	-	GCF Priority X - Update to test case 6.2.3.33	10.0.0	10.1.0
2012-06	RAN#56	R5-121781	1809	-	GCF Priority X - Addition of new test case 8.1.3.12	10.0.0	10.1.0
2012-06	RAN#56	R5-121782	1810	-	GCF Priority X - Addition of new test case 8.1.3.11	10.0.0	10.1.0
2012-06	RAN#56	R5-121783	1811	-	GCF Priority X - Addition of new Rel-9 EUTRA RRC test case 8.1.3.6a	10.0.0	10.1.0
2012-06	RAN#56	R5-121784	1812	-	GCF Priority X - Addition of new test case 8.2.4.14	10.0.0	10.1.0
2012-06	RAN#56	R5-121785	1813	-	GCF Priority X - Addition of new test case 8.3.1.12	10.0.0	10.1.0
2012-06	RAN#56	R5-121786	1814	-	GCF Priority X - Addition of new test case 8.3.1.13	10.0.0	10.1.0
2012-06	RAN#56	R5-121787	1815	-	GCF Priority X - Addition of new test case 8.3.1.14	10.0.0	10.1.0
2012-06	RAN#56	R5-121788	1816	-	GCF Priority C2 - Correction to test case 8.4.5.4	10.0.0	10.1.0
2012-06	RAN#56	R5-121789	1817	-	Addition of new e1xCsFB Rel-9 test case 8.4.7.7	10.0.0	10.1.0
2012-06	RAN#56	R5-121790	1818	-	Addition of new e1xCsFB Rel-9 test case 8.4.7.8	10.0.0	10.1.0
2012-06	RAN#56	R5-121791	1819	-	Addition of new e1xCsFB Rel-9 test case 8.4.7.9	10.0.0	10.1.0
2012-06	RAN#56	R5-121792	1820	-	Addition of new Rel-9 SRVCC test case 13.4.3.6	10.0.0	10.1.0
2012-06	RAN#56	R5-121793	1821	-	GCF Priority X - Addition of new test case 13.4.1.4	10.0.0	10.1.0
2012-06	RAN#56	R5-121794	1822	-	GCF Priority X Addition of new test case 13.3.1.3	10.0.0	10.1.0
2012-06	RAN#56	R5-121807	1823	-	GCF Priority X - Update of IMS test case 11.2.8	10.0.0	10.1.0
2012-06	RAN#56	R5-121808	1824	-	Add new test case 11.2.11	10.0.0	10.1.0
2012-06	RAN#56	R5-121826	1825	-	New UTRAN ANR/E-UTRAN test case 8.7.1	10.0.0	10.1.0
2012-06	RAN#56	R5-121828	1826	-	Update of MDT test case 8.6.2.3	10.0.0	10.1.0
2012-06	RAN#56	R5-121829	1827	-	Update of MDT test case 8.6.2.4	10.0.0	10.1.0
2012-06	RAN#56	R5-121830	1828	-	Addition of new MDT test case 8.6.2.5	10.0.0	10.1.0
2012-06	RAN#56	R5-121831	1829	-	Addition of new MDT test case 8.6.2.6	10.0.0	10.1.0
2012-06	RAN#56	R5-121832	1830	-	Addition of new MDT test case 8.6.2.7	10.0.0	10.1.0
2012-06	RAN#56	R5-121833	1831	-	Addition of new MDT test case 8.2.6.8	10.0.0	10.1.0
2012-06	RAN#56	R5-121834	1832	-	GCF Priority X - Addition of new test case 8.6.4.5	10.0.0	10.1.0
2012-06	RAN#56	R5-121836	1833	-	GCF Priority X - Addition of new test case	10.0.0	10.1.0

Date	TSG #	TSG Doc.	CR	Rev	Subject/Comment	Version Old	Version New
					8.6.4.6		
2012-06	RAN#56	R5-121837	1834	-	GCF Priority X - Addition of new test case 8.6.5.1	10.0.0	10.1.0
2012-06	RAN#56	R5-121839	1835	-	GCF Priority X - Addition of new test case 8.6.6.3	10.0.0	10.1.0
2012-06	RAN#56	R5-121840	1836	-	GCF Priority X - Addition of new test case 8.6.7.1	10.0.0	10.1.0
2012-06	RAN#56	R5-121841	1837	-	New Logged MDT test case 8.6.3.1	10.0.0	10.1.0
2012-06	RAN#56	R5-121843	1838	-	Radio Link Failure logging / Reporting at RRC connection establishment and reestablishment	10.0.0	10.1.0
2012-06	RAN#56	R5-121844	1839	-	Radio Link Failure logging / Reporting at E-UTRA handover	10.0.0	10.1.0
2012-06	RAN#56	R5-121848	1840	-	Correction to UE Pre-test condition for TS 36.523-1 Test Case 6.4.7 (Inter-RAT cell reselection / From GSM_Idle/GPRS Packet_Idle to E-UTRA RRC_IDLE member hybrid cell)	10.0.0	10.1.0
2012-06	RAN#56	R5-121849	1841	-	Correction of E-UTRAN<->GERAN test cases for Classmark Change	10.0.0	10.1.0
2012-06	RAN#56	R5-121855	1842	-	Addition of new PWS Rel-9 test case 18.1.7	10.0.0	10.1.0
2012-06	RAN#56	R5-121857	1843	-	Correction of CA TC 8.2.2.3	10.0.0	10.1.0
2012-06	RAN#56	R5-121858	1844	-	Correction of CA TC 8.2.2.4	10.0.0	10.1.0
2012-06	RAN#56	R5-121859	1845	-	Correction of CA TC 8.2.2.5	10.0.0	10.1.0
2012-06	RAN#56	R5-121860	1846	-	Correction of CA TC 8.2.4.17	10.0.0	10.1.0
2012-06	RAN#56	R5-121861	1847	-	Removal of CA TC 8.2.4.16	10.0.0	10.1.0
2012-06	RAN#56	R5-121862	1848	-	Correction of CA TC 8.3.1.17	10.0.0	10.1.0
2012-06	RAN#56	R5-121863	1849	-	Correction of CA TC 8.3.1.18	10.0.0	10.1.0
2012-06	RAN#56	R5-121865	1850	-	GCF Priority X - Addition of new CA test case	10.0.0	10.1.0
2012-06	RAN#56	R5-121869	1851	-	GCF Priority 1 - Correction to EUTRA RLC test case 7.2.3.10	10.0.0	10.1.0
2012-06	RAN#56	R5-121870	1852	-	GCF Priority 1 - Correction to EUTRA RLC test case 7.2.3.13	10.0.0	10.1.0
2012-06	RAN#56	R5-121889	1853	-	Update to TC 6.1.1.3a	10.0.0	10.1.0
2012-06	RAN#56	R5-121890	1854	-	Update to TC 6.1.1.4a	10.0.0	10.1.0
2012-06	RAN#56	R5-121891	1855	-	Update to TC 6.1.2.15a	10.0.0	10.1.0
2012-06	RAN#56	R5-121892	1856	-	Update to TC 6.1.2.16	10.0.0	10.1.0
2012-06	RAN#56	R5-121893	1857	-	GCF Priority X Correction of test cases 6.2.3.3a and 6.2.3.5a	10.0.0	10.1.0
2012-06	RAN#56	R5-121894	1858	-	GCF Priority 4: Modification on TC 8.1.2.9	10.0.0	10.1.0
2012-06	RAN#56	R5-121895	1859	-	Update to TC 8.1.3.11a	10.0.0	10.1.0
2012-06	RAN#56	R5-121896	1860	-	Update to TC 8.1.3.12a	10.0.0	10.1.0
2012-06	RAN#56	R5-121897	1861	-	Update to TC 8.2.4.13a	10.0.0	10.1.0
2012-06	RAN#56	R5-121898	1862	-	Update to TC 8.2.4.14a	10.0.0	10.1.0
2012-06	RAN#56	R5-121899	1863	-	Update to TC 8.2.4.15a	10.0.0	10.1.0
2012-06	RAN#56	R5-122008	1864	-	Introduction of new Rel10 CA test case 7.1.9.1	10.0.0	10.1.0
2012-06	RAN#56	R5-122009	1865	-	Radio Link Failure logging / Reporting at CDMA2000 Inter-RAT handover	10.0.0	10.1.0
2012-06	RAN#56	R5-122010	1866	-	Immediate MDT / Reporting / Location information	10.0.0	10.1.0
2012-06	RAN#56	R5-122011	1867	-	GCF Priority U1 - Correction to EMM test case 9.2.3.3.2	10.0.0	10.1.0
2012-06	RAN#56	R5-122012	1868	-	GCF Priority X - Update of EMM test case 9.2.1.2.1b	10.0.0	10.1.0
2012-06	RAN#56	R5-122013	1869	-	GCF Priority X - Update of EMM test case 9.2.1.2.1c	10.0.0	10.1.0
2012-06	RAN#56	R5-122016	1870	-	Addition of new e1xCSFB Rel-9 test case 13.4.4.5	10.0.0	10.1.0
2012-06	RAN#56	R5-122100	1871	-	Update to TC 8.3.1.12a	10.0.0	10.1.0
2012-06	RAN#56	R5-122101	1872	-	Updates to TC 8.3.1.13a	10.0.0	10.1.0
2012-06	RAN#56	R5-122102	1873	-	Update to TC 8.3.1.14a	10.0.0	10.1.0
2012-06	RAN#56	R5-122103	1874	-	Update to TC 8.3.1.15a	10.0.0	10.1.0
2012-06	RAN#56	R5-122104	1875	-	Update to TC 8.3.1.16a	10.0.0	10.1.0
2012-06	RAN#56	R5-122105	1876	-	GCF Priority U1 - Correction to EUTRA RRC test case 8.4.2.2	10.0.0	10.1.0
2012-06	RAN#56	R5-122107	1877	-	GCF Priority U1 - Correction to EMM test case 9.2.1.2.13	10.0.0	10.1.0
2012-06	RAN#56	R5-122108	1878	-	GCF Priority U1 - Correction to EMM test case 9.2.3.2.9	10.0.0	10.1.0
2012-06	RAN#56	R5-122113	1879	-	GCF Priority 4 - Correction to EMM test case 9.2.3.2.4	10.0.0	10.1.0
2012-06	RAN#56	R5-122114	1880	-	GCF Priority u1 - Correction to EMM test case 9.2.3.3.3	10.0.0	10.1.0

Date	TSG #	TSG Doc.	CR	Rev	Subject/Comment	Version Old	Version New
2012-06	RAN#56	R5-122115	1881	-	GCF Priority U1: Modification on TC 9.2.3.2.13	10.0.0	10.1.0
2012-06	RAN#56	R5-122119	1882	-	GCF priority 3: Correction to EMM TC 9.2.3.1.17	10.0.0	10.1.0
2012-09	RAN#57	R5-123079	1887	-	GCF Priority u1: Optimisation of test frequency allocation of UTRA cell	10.1.0	10.2.0
2012-09	RAN#57	R5-123099	1888	-	GCF Priority 2 - Correction to test case 9.2.3.2.1	10.1.0	10.2.0
2012-09	RAN#57	R5-123102	1889	-	GCF Priority X - Corrections of test case 8.1.3.12	10.1.0	10.2.0
2012-09	RAN#57	R5-123119	1890	-	GCF Priority u1 - Correction to EUTRA RRC test case 8.3.2.5	10.1.0	10.2.0
2012-09	RAN#57	R5-123120	1891	-	GCF Priority u1 - Correction to EMM test case 9.2.1.2.13	10.1.0	10.2.0
2012-09	RAN#57	R5-123124	1892	-	GCF Priority u1 - Correction to EMM test case 9.2.3.3.5a	10.1.0	10.2.0
2012-09	RAN#57	R5-123126	1893	-	GCF Priority g1 - Correction to multilayer test case 13.1.7	10.1.0	10.2.0
2012-09	RAN#57	R5-123131	1894	-	GCF Priority g1 - Correction to EMM test case 9.2.3.4.1	10.1.0	10.2.0
2012-09	RAN#57	R5-123132	1895	-	GCF Priority 3 - Correction to EUTRA MAC testcase 7.1.3.2	10.1.0	10.2.0
2012-09	RAN#57	R5-123202	1896	-	GCF Priority X - Update to test case 6.2.3.33	10.1.0	10.2.0
2012-09	RAN#57	R5-123203	1897	-	GCF Priority U1 - Correction to EMM test case 9.2.3.3.2	10.1.0	10.2.0
2012-09	RAN#57	R5-123247	1898	-	GCF Priority C1 - Correction to Rel9 EUTRA-1xRTT test case 6.2.3.10a	10.1.0	10.2.0
2012-09	RAN#57	R5-123248	1899	-	GCF Priority C1 - Correction to Rel9 EUTRA-HRPD test case 6.2.3.7a	10.1.0	10.2.0
2012-09	RAN#57	R5-123251	1900	-	GCF Priority C1 - Correction to Rel9 EUTRA-1xRTT test case 6.2.3.9a	10.1.0	10.2.0
2012-09	RAN#57	R5-123254	1901	-	GCF Priority U1 - Correction to EMM test case 9.2.1.2.13	10.1.0	10.2.0
2012-09	RAN#57	R5-123325	1902	-	GCF Priority 1 - Correction to EUTRA RRC test case 8.5.4.1	10.1.0	10.2.0
2012-09	RAN#57	R5-123415	1903	-	GCF Priority 4: Correction to test case 6.1.2.8a	10.1.0	10.2.0
2012-09	RAN#57	R5-123423	1904	-	Enhancements to LTE CA test case 7.1.9.1	10.1.0	10.2.0
2012-09	RAN#57	R5-123424	1905	-	Update PWS Rel-9 test case 18.1.4	10.1.0	10.2.0
2012-09	RAN#57	R5-123432	1906	-	GCF Priority 1- Correction to RRC test case 8.1.3.12a	10.1.0	10.2.0
2012-09	RAN#57	R5-123433	1907	-	GCF Priority 4 - Correction to Idle Mode test case 6.1.1.3b	10.1.0	10.2.0
2012-09	RAN#57	R5-123474	1909	-	GCF Priority g1: Correction to EMM TC 9.2.3.4.1	10.1.0	10.2.0
2012-09	RAN#57	R5-123475	1910	-	Corrections of measGapConfig IE definitions in CDMA2000 related test cases	10.1.0	10.2.0
2012-09	RAN#57	R5-123476	1911	-	GCF Priority 2: Update MAC TC 7.1.4.16	10.1.0	10.2.0
2012-09	RAN#57	R5-123496	1912	-	Update MDT TC 8.6.5.3 title	10.1.0	10.2.0
2012-09	RAN#57	R5-123536	1913	-	Update of References to specs and Releases in 36.523-1 v990 (pointer)	10.1.0	10.2.0
2012-09	RAN#57	R5-123539	1914	-	Update of References to specs and Releases in 36.523-1	10.1.0	10.2.0
2012-09	RAN#57	R5-123541	1915	-	Add missing PLMN and TAC	10.1.0	10.2.0
2012-09	RAN#57	R5-123550	1916	-	GCF Priority 3 - Correction to test cases 9.3.1.4, 9.3.1.5 and 9.3.1.6	10.1.0	10.2.0
2012-09	RAN#57	R5-123554	1917	-	Correction to UTRAN ANR E-UTRAN Inter-RAT test case 8.7.1	10.1.0	10.2.0
2012-09	RAN#57	R5-123565	1918	-	GCF priority b1: Correction to test case 6.1.2.5	10.1.0	10.2.0
2012-09	RAN#57	R5-123586	1919	-	GCF Priority U1 - Update of EMM TC 9.2.3.2.3	10.1.0	10.2.0
2012-09	RAN#57	R5-123637	1920	-	GCF priority 1 - Correction of test case 8.5.4.1	10.1.0	10.2.0
2012-09	RAN#57	R5-123638	1921	-	GCF Priority 1..4 - Editorial Corrections to EMM test cases	10.1.0	10.2.0
2012-09	RAN#57	R5-123640	1922	-	GCF Priority 3 - Update of EMM test case 9.2.2.1.2	10.1.0	10.2.0
2012-09	RAN#57	R5-123641	1923	-	GCF Priority 3 - Correction to EUTRA Idle Mode test case 6.1.1.4	10.1.0	10.2.0
2012-09	RAN#57	R5-123642	1924	-	GCF Priority u1 - Correction to Idle mode test case 6.2.1.1	10.1.0	10.2.0
2012-09	RAN#57	R5-123643	1925	-	GCF Priority u1 - Correction to Idle mode test case 6.2.3.13	10.1.0	10.2.0
2012-09	RAN#57	R5-123644	1926	-	GCF Priority u1 - Correction to EMM test case 9.2.3.2.9	10.1.0	10.2.0
2012-09	RAN#57	R5-123645	1927	-	GCF Priority u1 - Correction to EMM test case 9.2.3.2.14	10.1.0	10.2.0

Date	TSG #	TSG Doc.	CR	Rev	Subject/Comment	Version Old	Version New
2012-09	RAN#57	R5-123646	1928	-	GCF Priority u1 - Correction to EMM test case 9.2.3.3.2	10.1.0	10.2.0
2012-09	RAN#57	R5-123647	1929	-	GCF Priority u1 - Correction to EMM test case 9.3.1.6	10.1.0	10.2.0
2012-09	RAN#57	R5-123648	1930	-	GCF Priority u1 - Correction to EMM test cases 9.2.1.2.1b and 9.2.1.2.1.c	10.1.0	10.2.0
2012-09	RAN#57	R5-123649	1931	-	GCF Priority u1 Update of TC 9.2.3.3.1	10.1.0	10.2.0
2012-09	RAN#57	R5-123650	1932	-	GCF Priority U1 - Correction to EMM test case 9.2.1.2.9	10.1.0	10.2.0
2012-09	RAN#57	R5-123651	1933	-	GCF Priority U1 - Update of EMM test case 9.2.3.2.1b	10.1.0	10.2.0
2012-09	RAN#57	R5-123655	1934	-	GCF Priority U2 - Correction to UTRA-EUTRA test case 8.4.2.4	10.1.0	10.2.0
2012-09	RAN#57	R5-123656	1935	-	GCF Priority C1 - Correction to test cases 8.3.2.8 and 8.3.2.10	10.1.0	10.2.0
2012-09	RAN#57	R5-123657	1936	-	GCF Priority C1 - Correction to test case 6.2.3.9	10.1.0	10.2.0
2012-09	RAN#57	R5-123659	1937	-	GCF Priority g1 - Correction to multilayer test case 13.1.10	10.1.0	10.2.0
2012-09	RAN#57	R5-123660	1938	-	GCF Priority g1 - Correction to multilayer test case 13.1.8	10.1.0	10.2.0
2012-09	RAN#57	R5-123661	1939	-	GCF Priority g1 - Correction to multilayer test case 13.1.9	10.1.0	10.2.0
2012-09	RAN#57	R5-123665	1940	-	GCF Priority 3 - Correction to EUTRA MAC test cases 7.1.3.2, 7.1.4.2	10.1.0	10.2.0
2012-09	RAN#57	R5-123666	1941	-	Correction to Rel-9 EUTRA-HRPD Idle Mode test case 6.2.3.8a	10.1.0	10.2.0
2012-09	RAN#57	R5-123667	1942	-	GCF Priority X: Addition of New Inter band test case 6.1.2.15b	10.1.0	10.2.0
2012-09	RAN#57	R5-123668	1943	-	Correction to EUTRA Idle Mode test case 6.1.1.4a	10.1.0	10.2.0
2012-09	RAN#57	R5-123669	1944	-	GCF Priority X - Update of test case 6.1.2.2a	10.1.0	10.2.0
2012-09	RAN#57	R5-123671	1945	-	GCF Priority X - Addition of new test case 8.4.7.11	10.1.0	10.2.0
2012-09	RAN#57	R5-123672	1946	-	GCF Priority X: Correction to test case 13.4.4.1	10.1.0	10.2.0
2012-09	RAN#57	R5-123673	1947	-	GCF Priority X - Update of 13.4.4.5	10.1.0	10.2.0
2012-09	RAN#57	R5-123674	1948	-	GCF Priority X - Update of 8.4.7.x test cases	10.1.0	10.2.0
2012-09	RAN#57	R5-123680	1949	-	GCF Priority x - Addition of new test case 6.2.3.4a : Inter-RAT cell reselection / From UTRA_CELL_PCH state to E-UTRA RRC_IDLE based on RSRQ+RSRP evaluation	10.1.0	10.2.0
2012-09	RAN#57	R5-123685	1950	-	Update PWS Rel-9 test case 18.1.7	10.1.0	10.2.0
2012-09	RAN#57	R5-123708	1951	-	GCF Priority X - Addition of New Rel-10 eICIC test case	10.1.0	10.2.0
2012-09	RAN#57	R5-123709	1952	-	Addition of new Rel-10 eICIC test case 8.3.1.19	10.1.0	10.2.0
2012-09	RAN#57	R5-123732	1957	-	GCF Priority g1 - Correction to EUTRA test cases 8.4.3.2 and 8.4.3.3	10.1.0	10.2.0
2012-09	RAN#57	R5-123735	1958	-	Correction to EUTRAN-GERAN test cases for classmark change	10.1.0	10.2.0
2012-09	RAN#57	R5-123736	1959	-	GCF Priority U1 - Correction to EMM test case 9.2.3.3.4	10.1.0	10.2.0
2012-09	RAN#57	R5-123790	1960	-	GCF Priority 3 - Correction to EMM test case 9.2.2.1.3	10.1.0	10.2.0
2012-09	RAN#57	R5-123738	1961	-	GCF Priority X Addition of new test case 13.4.1.5	10.1.0	10.2.0
2012-09	RAN#57	R5-123739	1962	-	GCF Priority u1 - Correction to SRVCC test cases 13.4.3.1, 13.4.3.2, 13.4.3.4 and 13.4.3.6	10.1.0	10.2.0
2012-09	RAN#57	R5-123749	1963	-	Update test case 11.2.11	10.1.0	10.2.0
2012-09	RAN#57	R5-123753	1964	-	Update of CA TC 7.1.3.11	10.1.0	10.2.0
2012-09	RAN#57	R5-123754	1965	-	GCF Priority X - Addition of New Carrier Aggregation test case	10.1.0	10.2.0
2012-09	RAN#57	R5-123755	1966	-	Correction of CA test case 8.2.2.3	10.1.0	10.2.0
2012-09	RAN#57	R5-123756	1967	-	Addition of new TC 7.1.4.19 CA / UE power headroom reporting / SCell activation and DL pathloss change reporting / Extended PHR	10.1.0	10.2.0
2012-09	RAN#57	R5-123794	1968	-	Addition of new TC 7.1.4.23 CA / Correct handling of MAC control information / Buffer status	10.1.0	10.2.0
2012-09	RAN#57	R5-123758	1969	-	Correction of CA test case 8.2.2.4	10.1.0	10.2.0
2012-09	RAN#57	R5-123759	1970	-	Correction of CA test case 8.2.2.5	10.1.0	10.2.0
2012-09	RAN#57	R5-123760	1971	-	Correction of CA test case 8.2.4.17	10.1.0	10.2.0
2012-09	RAN#57	R5-123761	1972	-	Correction of CA test case 8.2.4.18	10.1.0	10.2.0
2012-09	RAN#57	R5-123762	1973	-	Correction of CA test case 8.3.1.17	10.1.0	10.2.0

Date	TSG #	TSG Doc.	CR	Rev	Subject/Comment	Version Old	Version New
2012-09	RAN#57	R5-123763	1974	-	Correction of CA test case 8.3.1.18	10.1.0	10.2.0
2012-09	GERAN#56	GP-120868	1886	-	CR 36.523-1-1886 GCF Priority g1 - Correction to Idle mode test case 6.2.3.19	10.1.0	10.2.0
2012-09	GERAN#56	GP-121042	1884	1	CR 36.523-1-1884 GCF priority g1 - Correction to Idle Mode test case 6.2.3.24	10.1.0	10.2.0
2012-09	GERAN#56	GP-121043	1975	-	CR 36.523-1-1975 GCF Priority g1 - Deletion of Idle mode test case 6.2.3.20	10.1.0	10.2.0
2012-09	RAN#57	R5-123436	1908	-	Addition of new TC9.4.5 Integrity protection / Correct functionality of EPS NAS integrity algorithm / ZUC	10.2.0	11.0.0
2012-09	RAN#57	R5-123721	1953	-	Addition of Test Case 7.3.4.3 Integrity protection Correct functionality of EPS AS integrity algorithms ZUC	10.2.0	11.0.0
2012-09	RAN#57	R5-123722	1954	-	Addition of new ZUC test case 7.3.3.6 correct functionality of EPS UP encryption algorithms	10.2.0	11.0.0
2012-09	RAN#57	R5-123723	1955	-	Addition of new TC7.3.3.5 Ciphering and deciphering / Correct functionality of EPS AS encryption algorithms / ZUC	10.2.0	11.0.0
2012-09	RAN#57	R5-123724	1956	-	Addition of new TC 9.4.6 Ciphering and deciphering / Correct functionality of EPS NAS encryption algorithm / ZUC	10.2.0	11.0.0
2012-12	RAN#58	R5-125074	1978	-	GCF P3: Update of TC 9.2.1.1.19 to apply to all types of attach	11.0.0	11.1.0
2012-12	RAN#58	R5-125080	1980	-	GCF WI-151 - Correction to LTE FDD-TDD Inter-mode test case 6.1.1.1a	11.0.0	11.1.0
2012-12	RAN#58	R5-125087	1981	-	GCF Priority 3: Correction to EMM test case 9.2.3.1.16	11.0.0	11.1.0
2012-12	RAN#58	R5-125126	1982	-	GCF Priority 4 - Correction to EUTRA Idle Mode test case 6.1.1.6a	11.0.0	11.1.0
2012-12	RAN#58	R5-125130	1983	-	Split of CA TC 7.1.3.11 to Intra-band contiguous CA and Inter-band CA	11.0.0	11.1.0
2012-12	RAN#58	R5-125132	1984	-	GCF Priority 3 - Update to Multilayer procedure test cases 13.1.3, 13.3.2.1 and 13.3.2.2	11.0.0	11.1.0
2012-12	RAN#58	R5-125154	1985	-	GCF Priority X - Corrections_TCs_8.4.7.x	11.0.0	11.1.0
2012-12	RAN#58	R5-125155	1986	-	GCF Priority X - Renumbering test case 8.4.7.11 to 8.4.7.10	11.0.0	11.1.0
2012-12	RAN#58	R5-125172	1987	-	Correction of RSRQ EUTRA 6.1.2.18	11.0.0	11.1.0
2012-12	RAN#58	R5-125173	1988	-	Correction of RSRQ EUTRA-GERAN 6.2.3.1a	11.0.0	11.1.0
2012-12	RAN#58	R5-125200	1989	-	GCF Priority 3 - Editorial correction for test case 9.2.1.1.25	11.0.0	11.1.0
2012-12	RAN#58	R5-125204	1990	-	GCF Priority 3 - Update test case 9.2.1.1.26	11.0.0	11.1.0
2012-12	RAN#58	R5-125207	1991	-	Correction to ANR for UTRAN IRAT (E-UTRAN) test case 8.7.1	11.0.0	11.1.0
2012-12	RAN#58	R5-125232	1992	-	GCF Priority 1 - Correction to Idle Mode test case 6.2.3.6	11.0.0	11.1.0
2012-12	RAN#58	R5-125233	1993	-	GCF Priority u1: Correction to RRC test case 8.1.3.7	11.0.0	11.1.0
2012-12	RAN#58	R5-125234	1994	-	GCF Priority u1: Correction to RRC test case 8.4.2.2	11.0.0	11.1.0
2012-12	RAN#58	R5-125235	1995	-	GCF Priority u2: Correction to RRC test case 8.4.2.4	11.0.0	11.1.0
2012-12	RAN#58	R5-125272	1996	-	Correction to CA test case 8.2.2.4.1	11.0.0	11.1.0
2012-12	RAN#58	R5-125274	1997	-	GCF Priority U1 - Update test case 6.2.3.3	11.0.0	11.1.0

Date	TSG #	TSG Doc.	CR	Rev	Subject/Comment	Version Old	Version New
2012-12	RAN#58	R5-125276	1998	-	Clarification to Local Emergency list provided by the NWK and more	11.0.0	11.1.0
2012-12	RAN#58	R5-125317	1999	-	GCF Priority 1 - Correction to PDCP test cases 7.3.4.1 and 7.3.4.2	11.0.0	11.1.0
2012-12	RAN#58	R5-125333	2000	-	GCF Priority 3 - Update of TC 9.2.3.1.27	11.0.0	11.1.0
2012-12	RAN#58	R5-125525	2001	-	Addition of new MDT test case 8.6.7.2	11.0.0	11.1.0
2012-12	RAN#58	R5-125526	2002	-	Addition of new MDT test case 8.6.7.3	11.0.0	11.1.0
2012-12	RAN#58	R5-125532	2003	-	Update to GCF P3 TCs 9.2.2.1.3 and 9.2.2.1.4	11.0.0	11.1.0
2012-12	RAN#58	R5-125584	2004	-	GCF Priority G1 - Update test case 13.4.3.5	11.0.0	11.1.0
2012-12	RAN#58	R5-125633	2005	-	GCF Priority U2 - Correction to UTRA-EUTRA test case 8.4.2.4	11.0.0	11.1.0
2012-12	RAN#58	R5-125634	2006	-	GCF Priority U2 - Correction to EMM test case 9.2.3.2.3	11.0.0	11.1.0
2012-12	RAN#58	R5-125640	2007	-	GCF WI-151 - Correction to LTE FDD-TDD Inter-mode test case 6.1.1.4a	11.0.0	11.1.0
2012-12	RAN#58	R5-125657	2008	-	Editorial corrections to some EMM test cases	11.0.0	11.1.0
2012-12	RAN#58	R5-125662	2009	-	GCF Priority X - Correction to Rel-10 eICIC test case 8.3.1.20	11.0.0	11.1.0
2012-12	RAN#58	R5-125663	2010	-	Removal of technical content in 36.523-1 v10.2.0 and substitution with pointer to the next Release	11.0.0	11.1.0
2012-12	RAN#58	R5-125683	2011	-	GCF Priority 4 - Correction to EMM test case 9.2.3.2.13	11.0.0	11.1.0
2012-12	RAN#58	R5-125685	2012	-	Split of CA TC 7.1.9.1 to Intra-band contiguous CA and Inter-band CA	11.0.0	11.1.0
2012-12	RAN#58	R5-125697	2013	-	GCF Priority 4: Update of EMM test cases 9.2.1.1.1b, 9.2.1.1.15a, 9.2.1.1.16a, 9.2.3.1.15a and 9.2.3.1.18a	11.0.0	11.1.0
2012-12	RAN#58	R5-125702	2014	-	GCF Priority 1 - Correction to PDCP test case 7.3.3.1, 7.3.3.2, 7.3.3.3 and 7.3.3.4	11.0.0	11.1.0
2012-12	RAN#58	R5-125703	2015	-	GCF Priority 1 - Correction to EUTRA RRC test case 8.5.4.1	11.0.0	11.1.0
2012-12	RAN#58	R5-125704	2016	-	GCF Priority 1 - Correction to EMM test case 9.2.3.3.5a	11.0.0	11.1.0
2012-12	RAN#58	R5-125705	2017	-	GCF Priority 2 - Correction to Idle Mode testcases referring to 36.508 6.4.2.7A-2	11.0.0	11.1.0
2012-12	RAN#58	R5-125707	2018	-	GCF Priority 2 - Update test case 9.2.2.2.2	11.0.0	11.1.0
2012-12	RAN#58	R5-125708	2019	-	GCF Priority 3 - Correction to EMM test case 9.3.1.6	11.0.0	11.1.0
2012-12	RAN#58	R5-125710	2020	-	GCF Priority 3 - Correction to EMM test case 9.2.2.1.3	11.0.0	11.1.0
2012-12	RAN#58	R5-125711	2021	-	GCF Priority 3 - Update test case 9.2.1.1.24	11.0.0	11.1.0
2012-12	RAN#58	R5-125712	2022	-	GCF Priority 3 - update of TC 9.2.1.1.24	11.0.0	11.1.0
2012-12	RAN#58	R5-125713	2023	-	GCF Priority 3: Modification of TC 6.1.2.13	11.0.0	11.1.0
2012-12	RAN#58	R5-125714	2024	-	GCF priority 3: Modification of TC 8.3.1.4	11.0.0	11.1.0
2012-12	RAN#58	R5-125715	2025	-	GCF priority 3: Modification of TC 8.3.2.6	11.0.0	11.1.0

Date	TSG #	TSG Doc.	CR	Rev	Subject/Comment	Version Old	Version New
2012-12	RAN#58	R5-125716	2026	-	GCF Priority 2: Modification of EMM TC 9.2.2.1.6	11.0.0	11.1.0
2012-12	RAN#58	R5-125717	2027	-	GCF priority 2: Modification of TC 8.3.1.1	11.0.0	11.1.0
2012-12	RAN#58	R5-125718	2028	-	GCF priority 2: Modification of TC 8.3.1.2	11.0.0	11.1.0
2012-12	RAN#58	R5-125720	2029	-	GCF Priority 4 - Corrections to Single Frequency EUTRA Idle Mode test cases	11.0.0	11.1.0
2012-12	RAN#58	R5-125721	2030	-	GCF Priority 4 - Correction to EUTRA Idle Mode test case 6.1.2.9a	11.0.0	11.1.0
2012-12	RAN#58	R5-125722	2031	-	Correction of Rel-9 inter-band test case 8.3.1.16	11.0.0	11.1.0
2012-12	RAN#58	R5-125723	2032	-	Correction to Rel-9 EUTRA FDD-TDD test case 8.2.4.14a	11.0.0	11.1.0
2012-12	RAN#58	R5-125724	2033	-	Correction to Rel-9 EUTRA FDD-TDD test case 8.2.4.15a	11.0.0	11.1.0
2012-12	RAN#58	R5-125725	2034	-	GCF Priority 4: Update of EMM test case 9.2.3.2.4	11.0.0	11.1.0
2012-12	RAN#58	R5-125726	2035	-	GCF Priority 4: Corrections to user PLMN reselection test cases	11.0.0	11.1.0
2012-12	RAN#58	R5-125728	2036	-	GCF Priority 4 - Correction to test case 6.3.5	11.0.0	11.1.0
2012-12	RAN#58	R5-125729	2037	-	GCF Priority U1 - Update test case 6.2.3.6	11.0.0	11.1.0
2012-12	RAN#58	R5-125730	2038	-	GCF Priority u1 - Correction to preamble in 6.2.2.8/6.2.3.3/6.2.3.3a/6.4.5 test cases	11.0.0	11.1.0
2012-12	RAN#58	R5-125731	2039	-	GCF Priority u1: Modification of TC 6.2.3.13	11.0.0	11.1.0
2012-12	RAN#58	R5-125732	2040	-	GCF Priority u1: Modification of TC 6.2.3.32	11.0.0	11.1.0
2012-12	RAN#58	R5-125733	2041	-	GCF Priority u1 - Update to RRC test case 8.3.2.3	11.0.0	11.1.0
2012-12	RAN#58	R5-125734	2042	-	GCF Priority u1 - Update to RRC test case 8.3.2.4	11.0.0	11.1.0
2012-12	RAN#58	R5-125735	2043	-	GCF priority u1: Modification of TC 8.3.2.3	11.0.0	11.1.0
2012-12	RAN#58	R5-125736	2044	-	GCF priority u1: Modification of TC 8.3.2.4	11.0.0	11.1.0
2012-12	RAN#58	R5-125738	2046	-	GCF Priority u1: Modification of EMM TC 9.2.3.2.1a	11.0.0	11.1.0
2012-12	RAN#58	R5-125740	2047	-	GCF Priority u1 - Update to SRVCC test cases 13.4.3.1, 13.4.3.2, 13.4.3.4 and 13.4.3.6	11.0.0	11.1.0
2012-12	RAN#58	R5-125741	2048	-	GCF Priority U1 - Update test case 13.4.3.1	11.0.0	11.1.0
2012-12	RAN#58	R5-125742	2049	-	GCF Priority U1 - Update test case 13.4.3.2	11.0.0	11.1.0
2012-12	RAN#58	R5-125743	2050	-	GCF Priority U1 - Update test case 13.4.3.4	11.0.0	11.1.0
2012-12	RAN#58	R5-125744	2051	-	GCF Priority u2 - Update to RRC test case 8.3.3.2	11.0.0	11.1.0
2012-12	RAN#58	R5-125747	2052	-	GCF P4: Update of TC 9.2.1.1.3 to clarify applicability of all types of attach and more	11.0.0	11.1.0
2012-12	RAN#58	R5-125748	2053	-	GCF P4: Update of TC 9.2.1.1.4 to clarify applicability of all types of attach and more	11.0.0	11.1.0
2012-12	RAN#58	R5-125749	2054	-	GCF priority g1: Modification of TC 8.3.2.2	11.0.0	11.1.0
2012-12	RAN#58	R5-125750	2055	-	GCF priority g2: Modification of TC 8.3.2.1	11.0.0	11.1.0

Date	TSG #	TSG Doc.	CR	Rev	Subject/Comment	Version Old	Version New
2012-12	RAN#58	R5-125753	2058	-	GCF Priority m1 - Update of RRC test cases 8.3.2.5 and 8.3.2.6	11.0.0	11.1.0
2012-12	RAN#58	R5-125754	2059	-	GCF Priority i1 - Correction to LTE FDD-TDD Inter-mode test case 13.4.1.3	11.0.0	11.1.0
2012-12	RAN#58	R5-125756	2060	-	Correction to test cases 6.1.2.15, 6.1.2.15a and 6.1.2.15b	11.0.0	11.1.0
2012-12	RAN#58	R5-125757	2061	-	Correction to EUTRANFeatureGroupIndicators in EMM test cases	11.0.0	11.1.0
2012-12	RAN#58	R5-125758	2062	-	Correction to TS 36.523-1 TC 9.2.3.1.5 "Periodic tracking area update / Accepted"	11.0.0	11.1.0
2012-12	RAN#58	R5-125759	2063	-	Correction to Multi-layer test cases 13.1.7,13.1.8,13.1.9,13.1.10	11.0.0	11.1.0
2012-12	RAN#58	R5-125761	2064	-	Correction of RSRQ EUTRA-UTRAN 6.2.3.33	11.0.0	11.1.0
2012-12	RAN#58	R5-125762	2065	-	Correction of RSRQ EUTRA-UTRAN 8.3.2.3a	11.0.0	11.1.0
2012-12	RAN#58	R5-125763	2066	-	Update of test case 11.2.11	11.0.0	11.1.0
2012-12	RAN#58	R5-125764	2067	-	GCF WI-154 - Correction to IMS Emergency Call test case 11.2.2	11.0.0	11.1.0
2012-12	RAN#58	R5-125765	2068	-	GCF WI-151 - Correction to LTE FDD-TDD Inter-mode test case 8.3.1.13a	11.0.0	11.1.0
2012-12	RAN#58	R5-125766	2069	-	GCF Priority X - Updates of e1xCsFB TC_13.1.17	11.0.0	11.1.0
2012-12	RAN#58	R5-125767	2070	-	Correction of RSRQ EUTRA-UTRAN 6.2.3.3a	11.0.0	11.1.0
2012-12	RAN#58	R5-125768	2071	-	Correction of RSRQ EUTRA-UTRAN 6.2.3.4a	11.0.0	11.1.0
2012-12	RAN#58	R5-125769	2072	-	Correction of RSRQ EUTRA-UTRAN 6.2.3.5a	11.0.0	11.1.0
2012-12	RAN#58	R5-125770	2073	-	GCF Priority 1 - Update of test case 8.5.4.1 to Clarify FGI 33 - 36	11.0.0	11.1.0
2012-12	RAN#58	R5-125775	2074	-	Update PWS Rel-9 test case 18.1.1	11.0.0	11.1.0
2012-12	RAN#58	R5-125776	2075	-	Correction to PWS Rel-9 test case 18.1.3	11.0.0	11.1.0
2012-12	RAN#58	R5-125781	2076	-	GCF Priority X - Addition of New Rel-10 H(e)NB test case 6.3.10	11.0.0	11.1.0
2012-12	RAN#58	R5-125782	2077	-	GCF Priority X - Addition of new Rel-10 H(e)NB test case 6.3.12	11.0.0	11.1.0
2012-12	RAN#58	R5-125783	2078	-	GCF Priority X - Addition of New Rel-10 H(e)NB test case 6.3.11	11.0.0	11.1.0
2012-12	RAN#58	R5-125785	2079	-	Location stimulus clarification for MDT test cases	11.0.0	11.1.0
2012-12	RAN#58	R5-125786	2080	-	New E-UTRAN MDT test case 8.6.2.9	11.0.0	11.1.0
2012-12	RAN#58	R5-125787	2081	-	New E-UTRAN MDT test case 8.6.4.7	11.0.0	11.1.0
2012-12	RAN#58	R5-125788	2082	-	New E-UTRAN MDT test case 8.6.6.4	11.0.0	11.1.0
2012-12	RAN#58	R5-125789	2083	-	Update of MDT test cases 8.6.5.1 and 8.6.7.1	11.0.0	11.1.0
2012-12	RAN#58	R5-125790	2084	-	Addition of new TC 7.1.4.22: Correct HARQ process handling / UL MIMO	11.0.0	11.1.0
2012-12	RAN#58	R5-125793	2085	-	GCF Priority X - Addition of new test case 13.4.3.7	11.0.0	11.1.0
2012-12	RAN#58	R5-125794	2086	-	GCF Priority X - Addition of new test case	11.0.0	11.1.0

Date	TSG #	TSG Doc.	CR	Rev	Subject/Comment	Version Old	Version New
					13.4.3.8		

Date	TSG #	TSG Doc.	CR	Rev	Subject/Comment	Version Old	Version New
2012-12	RAN#58	R5-125795	2087	-	GCF Priority X - Addition of new test case 13.4.3.9	11.0.0	11.1.0
2012-12	RAN#58	R5-125796	2088	-	GCF Priority X - Addition of new test case 13.4.3.10	11.0.0	11.1.0
2012-12	RAN#58	R5-125797	2089	-	GCF Priority X - Addition of new test case 13.4.3.11	11.0.0	11.1.0
2012-12	RAN#58	R5-125798	2090	-	GCF Priority X - Addition of new test case 13.4.3.12	11.0.0	11.1.0
2012-12	RAN#58	R5-125799	2091	-	GCF Priority X - Addition of new test case 13.4.3.13	11.0.0	11.1.0
2012-12	RAN#58	R5-126000	2092	-	Add aSRVCC test case 13.4.3.14	11.0.0	11.1.0
2012-12	RAN#58	R5-126001	2093	-	Add aSRVCC test case 13.4.3.16	11.0.0	11.1.0
2012-12	RAN#58	R5-126006	2094	-	Splitting of CA test case 7.1.4.19 to Intra-band Contiguous CA and Inter-band CA	11.0.0	11.1.0
2012-12	RAN#58	R5-126007	2095	-	Renumbering TC 7.1.4.23 and Splitting it to intra-band contiguous CA and inter-band CA	11.0.0	11.1.0
2012-12	RAN#58	R5-126008	2096	-	GCF Priority X - Update of Carrier Aggregation test case 8.4.2.7	11.0.0	11.1.0
2012-12	RAN#58	R5-126019	2097	-	GCF Priority U1 - Update test case 6.2.1.3	11.0.0	11.1.0
2012-12	RAN#58	R5-126021	2098	-	GCF Priority 1 - Correction to EUTRA MAC test cases 7.1.7.1.1, 7.1.7.1.2, 7.1.7.1.3, 7.1.7.1.4, 7.1.7.1.5, 7.1.7.1.6 and 7.1.7.2.1	11.0.0	11.1.0
2012-12	RAN#58	R5-126022	2099	-	GCF Priority g1: Correction to EUTRA to GERAN HO test case 8.4.3.3	11.0.0	11.1.0
2012-12	RAN#58	R5-126023	2100	-	GCF Priority U1 - Correction to EMM test case 9.2.3.3.2	11.0.0	11.1.0
2012-12	RAN#58	R5-126024	2101	-	GCF Priority 3 - Correction to EMM test case 9.3.1.6	11.0.0	11.1.0
2012-12	RAN#58	R5-126026	2102	-	Correction of RSRQ EUTRA 8.3.1.3a	11.0.0	11.1.0
2012-12	RAN#58	R5-126028	2103	-	Correction of RSRQ EUTRA 6.1.2.3a	11.0.0	11.1.0
2012-12	RAN#58	R5-126029	2104	-	Correction of RSRQ EUTRA 6.1.2.17	11.0.0	11.1.0
2012-12	RAN#58	R5-126030	2105	-	Addition of new CA related test case: CA / Correct handling of MAC control information / Buffer Status / UL data arrive in the UE Tx buffer / Extended buffer size	11.0.0	11.1.0
2012-12	RAN#58	R5-126067	1979	-	GCF Priority U1 - Correction to EMM test case 9.2.3.3.2	11.0.0	11.1.0
2012-12	RAN#58	R5-126068	2045	-	GCF Priority u1 - Correction to EMM test case 9.2.3.3.5	11.0.0	11.1.0
2012-12	RAN#58	R5-126070	2106	-	GCF Priority 1 - Update of test case 8.5.4.1 to add Carrier Aggregation IEs	11.0.0	11.1.0
2012-12	RAN#58	R5-126071	2107	-	Addition of New Carrier Aggregation test case for A5	11.0.0	11.1.0
2012-12	RAN#58	R5-126073	2108	-	Addition of New Carrier Aggregation test case for PCell Change SCell no Change	11.0.0	11.1.0
2012-12	RAN#58	R5-126074	2109	-	Addition of New Carrier Aggregation test case for Event A6	11.0.0	11.1.0
2012-12	RAN#58	R5-126075	2110	-	Addition of New Carrier Aggregation test case	11.0.0	11.1.0

Date	TSG #	TSG Doc.	CR	Rev	Subject/Comment	Version Old	Version New
					for Event A1 and Event A2		

Date	TSG #	TSG Doc.	CR	Rev	Subject/Comment	Version Old	Version New
2012-12	RAN#58	R5-126076	2111	-	Addition of New Carrier Aggregation test case for RLF	11.0.0	11.1.0
2012-12	GERAN#56	GP-121233	1976	-	Addition of New Carrier Aggregation test case for RLF	11.0.0	11.1.0
2012-12	GERAN#56	GP-121234	1977	-	Addition of New Carrier Aggregation test case for RLF	11.1.0	11.1.1
2013-03	RAN#59	R5-130079	2115	-	GCF Priority 4 - Correction to EMM tc 9.2.3.2.1c	11.1.1	11.2.0
2013-03	RAN#59	R5-130081	2116	-	GCF Priority 3 - Correction to Multi-Layer test case 13.1.3	11.1.1	11.2.0
2013-03	RAN#59	R5-130088	2117	-	Update to test case 8.3.1.3a	11.1.1	11.2.0
2013-03	RAN#59	R5-130159	2118	-	GCF Priority 3 - Correction to EMM test case 9.2.1.1.24	11.1.1	11.2.0
2013-03	RAN#59	R5-130178	2119	-	GCF Priority u1 - Correction to EMM test case 9.2.3.2.1c	11.1.1	11.2.0
2013-03	RAN#59	R5-130207	2120	-	GCF Priority 4 - Correction to RRC test case 8.1.2.6	11.1.1	11.2.0
2013-03	RAN#59	R5-130208	2121	-	GCF Priority X - Correction to RRC test case 8.2.4.14	11.1.1	11.2.0
2013-03	RAN#59	R5-130209	2122	-	GCF Priority U1 - Correction to EMM test case 9.2.1.2.13	11.1.1	11.2.0
2013-03	RAN#59	R5-130212	2123	-	GCF Priority U1 - Correction to EMM test case 9.2.3.3.5	11.1.1	11.2.0
2013-03	RAN#59	R5-130312	2124	-	GCF Priority u1 - Update test case 13.4.3.2	11.1.1	11.2.0
2013-03	RAN#59	R5-130313	2125	-	Update test case 13.4.3.14	11.1.1	11.2.0
2013-03	RAN#59	R5-130314	2126	-	Update test case 13.4.3.16	11.1.1	11.2.0
2013-03	RAN#59	R5-130316	2127	-	GCF Priority 3 - Update test case 9.2.3.1.27	11.1.1	11.2.0
2013-03	RAN#59	R5-130317	2128	-	GCF Priority 3 - Update test case 9.2.3.1.28	11.1.1	11.2.0
2013-03	RAN#59	R5-130340	2129	-	Correction of MDT test case 8.6.7.1	11.1.1	11.2.0
2013-03	RAN#59	R5-130341	2130	-	Addition of new MO SMS test cases 11.1.5 and 11.1.6	11.1.1	11.2.0
2013-03	RAN#59	R5-130355	2131	-	GCF Priority g1 - Update to EUTRA Idle Mode test case 6.2.3.1	11.1.1	11.2.0
2013-03	RAN#59	R5-130356	2132	-	GCF Priority 2 - Correction to EMM test case TC9.4.4	11.1.1	11.2.0
2013-03	RAN#59	R5-130357	2133	-	GCF Priority 4 - Correction to Idle Mode test case TC6.2.3.19	11.1.1	11.2.0
2013-03	RAN#59	R5-130369	2134	-	Update to test cases 13.4.3.8, 13.4.3.9, 13.4.3.11 and 13.4.3.13	11.1.1	11.2.0
2013-03	RAN#59	R5-130454	2135	-	GCF Priority g1 - Update to Inter-RAT measurements test case 8.3.2.5	11.1.1	11.2.0
2013-03	RAN#59	R5-130455	2136	-	GCF Priority g2 - Update to Inter-RAT measurements test case 8.3.3.3	11.1.1	11.2.0
2013-03	RAN#59	R5-130527	2137	-	Correction to test case 11.1.1 & 11.1.4	11.1.1	11.2.0
2013-03	RAN#59	R5-130539	2138	-	Updating of EMM cause of test case 11.2.6 and 11.2.7	11.1.1	11.2.0

Date	TSG #	TSG Doc.	CR	Rev	Subject/Comment	Version Old	Version New
2013-03	RAN#59	R5-130558	2139	-	GCF Priority 1 - Corrections to MAC TC 7.1.4.10	11.1.1	11.2.0
2013-03	RAN#59	R5-130560	2140	-	Corrections to TC 13.4.3.3 "Inter-system mobility / E-UTRA voice to GSM CS voice / SRVCC"	11.1.1	11.2.0
2013-03	RAN#59	R5-130562	2141	-	Correction to Table 13.4.3.2.3.3-6: HANDOVER TO UTRAN COMMAND (step 32, Table 13.4.3.2.3.3-5) to include new handover condition defined in TS 36.508	11.1.1	11.2.0
2013-03	RAN#59	R5-130586	2142	-	Correction to MDT test case 8.6.3.1	11.1.1	11.2.0
2013-03	RAN#59	R5-130624	2143	-	Correction to preamble for TC 6.2.3.4a	11.1.1	11.2.0
2013-03	RAN#59	R5-130625	2144	-	GCF Priority X - Correction to RSRQ test case 6.1.2.17	11.1.1	11.2.0
2013-03	RAN#59	R5-130626	2145	-	Correction to RSRQ test case 6.1.2.18	11.1.1	11.2.0
2013-03	RAN#59	R5-130627	2146	-	Correction to RSQR test case 6.2.3.3a	11.1.1	11.2.0
2013-03	RAN#59	R5-130628	2147	-	GCF Priority u1 - Correction to EUTRA RRC Test Case 8.4.2.2	11.1.1	11.2.0
2013-03	RAN#59	R5-130629	2148	-	GCF Priority u2 - Correction to EUTRA RRC Test Case 8.4.2.4	11.1.1	11.2.0
2013-03	RAN#59	R5-130630	2149	-	Update of 8.4.5.4 - Addition of C2K checking parameters	11.1.1	11.2.0
2013-03	RAN#59	R5-130631	2150	-	Update of 8.4.7.3 - Addition of C2K checking parameters	11.1.1	11.2.0
2013-03	RAN#59	R5-130632	2151	-	Update of 8.4.7.4 - Addition of C2K checking parameters	11.1.1	11.2.0
2013-03	RAN#59	R5-130633	2152	-	Update of 8.4.7.5 - Addition of C2K checking parameters	11.1.1	11.2.0
2013-03	RAN#59	R5-130634	2153	-	Update of 8.4.7.6 - Addition of C2K checking parameters	11.1.1	11.2.0
2013-03	RAN#59	R5-130635	2154	-	Update of 8.4.7.7 - Addition of C2K checking parameters	11.1.1	11.2.0
2013-03	RAN#59	R5-130636	2155	-	Update of 8.4.7.8 - Addition of C2K checking parameters	11.1.1	11.2.0
2013-03	RAN#59	R5-130637	2156	-	Update of 8.4.7.9 - Addition of C2K checking parameters	11.1.1	11.2.0
2013-03	RAN#59	R5-130639	2158	-	GCF Priority c1 - Correction to title of EUTRA-1xRTT test cases 8.4.7.3 and 8.4.7.4	11.1.1	11.2.0
2013-03	RAN#59	R5-130641	2159	-	GCF Priority g1 - Correction to EUTRA RRC Test Cases 8.4.3.2 and 8.4.3.3	11.1.1	11.2.0
2013-03	RAN#59	R5-130642	2160	-	GCF Priority 4 - Correction to EMM tc 9.2.3.1.17	11.1.1	11.2.0
2013-03	RAN#59	R5-130644	2162	-	GCF Priority 2 - Correction to EMM test case 9.2.3.1.4	11.1.1	11.2.0
2013-03	RAN#59	R5-130645	2163	-	GCF Priority U1 - Correction to EMM test case 9.2.3.2.13	11.1.1	11.2.0
2013-03	RAN#59	R5-130646	2164	-	GCF Priority U1 - Correction to EMM test case 9.2.1.2.5	11.1.1	11.2.0
2013-03	RAN#59	R5-130647	2165	-	GCF Priority 4 - Correction to EMM tc 9.2.3.3.5a	11.1.1	11.2.0

Date	TSG #	TSG Doc.	CR	Rev	Subject/Comment	Version Old	Version New
2013-03	RAN#59	R5-130649	2166	-	New LTE Rel-9 TC for UE rejection of NAS security mode command with EIA0	11.1.1	11.2.0
2013-03	RAN#59	R5-130650	2167	-	GCF Priority 1 - Update test case 9.1.3.1 to test not null and null ciphering algorithms	11.1.1	11.2.0
2013-03	RAN#59	R5-130651	2168	-	Correction to GCF P3 EMM test case 9.2.2.1.8	11.1.1	11.2.0
2013-03	RAN#59	R5-130652	2169	-	Update of 11.2.8 - Addition of C2K checking parameters	11.1.1	11.2.0
2013-03	RAN#59	R5-130653	2170	-	GCF Priority 3 - Correction to Multi-layer test cases 13.1.x	11.1.1	11.2.0
2013-03	RAN#59	R5-130654	2171	-	GCF Priority u1 - Update test case 13.1.2	11.1.1	11.2.0
2013-03	RAN#59	R5-130655	2172	-	GCF Priority u1 - Update test case 13.1.2a	11.1.1	11.2.0
2013-03	RAN#59	R5-130656	2173	-	GCF Priority u1 - Update test case 13.1.5	11.1.1	11.2.0
2013-03	RAN#59	R5-130657	2174	-	GCF Priority g1 - Update test case 13.1.9	11.1.1	11.2.0
2013-03	RAN#59	R5-130658	2175	-	Update of 13.1.17 - Addition of C2K checking parameters	11.1.1	11.2.0
2013-03	RAN#59	R5-130659	2176	-	Update of 13.1.18 - Addition of C2K checking parameters	11.1.1	11.2.0
2013-03	RAN#59	R5-130660	2177	-	Update of 13.4.4.1 - Addition of C2K checking parameters	11.1.1	11.2.0
2013-03	RAN#59	R5-130661	2178	-	Update of 13.4.4.2 - Addition of C2K checking parameters	11.1.1	11.2.0
2013-03	RAN#59	R5-130662	2179	-	Update of 13.4.4.4 - Addition of C2K checking parameters	11.1.1	11.2.0
2013-03	RAN#59	R5-130663	2180	-	Update of 13.4.4.5 - Addition of C2K checking parameters	11.1.1	11.2.0
2013-03	RAN#59	R5-130664	2181	-	Update of 13.4.4.3 - C2K messages contents for checking parameters	11.1.1	11.2.0
2013-03	RAN#59	R5-130665	2182	-	GCF Priority 3 - Correction to EMM test case 9.1.5.1	11.1.1	11.2.0
2013-03	RAN#59	R5-130669	2183	-	Addition of new Inter-RAT measurement test case for event B1	11.1.1	11.2.0
2013-03	RAN#59	R5-130697	2184	-	New aSRVCC TC 13_4_3_15 MO call voice-data SRVCC HO cancelled	11.1.1	11.2.0
2013-03	RAN#59	R5-130698	2185	-	New aSRVCC TC 13_4_3_17 MT call voice-data SRVCC HO cancelled	11.1.1	11.2.0
2013-03	RAN#59	R5-130699	2186	-	Update of eICIC test case 8.3.1.20	11.1.1	11.2.0
2013-03	RAN#59	R5-130701	2187	-	Update of Carrier Aggregation test case 8.2.4.19.1	11.1.1	11.2.0
2013-03	RAN#59	R5-130703	2188	-	Editorial Corrections to Carrier Aggregation Radio Resource Reconfiguration test cases	11.1.1	11.2.0
2013-03	RAN#59	R5-130704	2189	-	Modification on CA radio resource reconfiguration related test cases	11.1.1	11.2.0
2013-03	RAN#59	R5-130705	2190	-	Editorial Corrections to Carrier Aggregation Handover Test cases	11.1.1	11.2.0
2013-03	RAN#59	R5-130707	2191	-	Modification of CA TC 8.2.4.17 and 8.2.4.18	11.1.1	11.2.0
2013-03	RAN#59	R5-130720	2192	-	New NIMTC test case 6.1.1.7 PLMN selection / Periodic reselection /	11.1.1	11.2.0

Date	TSG #	TSG Doc.	CR	Rev	Subject/Comment	Version Old	Version New
					MinimumPeriodicSearchTimer		

Date	TSG #	TSG Doc.	CR	Rev	Subject/Comment	Version Old	Version New
2013-03	RAN#59	R5-130722	2193	-	New NIMTC test case 9.2.1.1.27 Attach / Abnormal case / Network reject with Extended Wait Timer	11.1.1	11.2.0
2013-03	RAN#59	R5-130723	2194	-	New NIMTC test case 10.5.4 UE requested PDN connectivity not accepted / Network reject with Extended Wait Timer	11.1.1	11.2.0
2013-03	RAN#59	R5-130729	2195	-	Addition of new MDT test case 8.6.3.2	11.1.1	11.2.0
2013-03	RAN#59	R5-130730	2196	-	Addition of New MDT test case for Logged MDT	11.1.1	11.2.0
2013-03	RAN#59	R5-130733	2198	-	Addition of new test case 8.3.1.bb	11.1.1	11.2.0
2013-03	RAN#59	R5-130734	2199	-	Addition of new test case 8.3.1.cc	11.1.1	11.2.0
2013-03	RAN#59	R5-130735	2200	-	Addition of new test case 8.3.1.dd	11.1.1	11.2.0
2013-03	RAN#59	R5-130739	2202	-	GCF Priority 3 - Corrections to EMM TC 9.2.1.1.12, 9.2.3.1.12, 9.2.3.1.18	11.1.1	11.2.0
2013-03	RAN#59	R5-130740	2203	-	GCF Priority U1 - Correction to EMM test case 9.2.1.2.8	11.1.1	11.2.0
2013-03	RAN#59	R5-130741	2204	-	GCF Priority g1 - Update test case 13.1.8	11.1.1	11.2.0
2013-03	RAN#59	R5-130742	2205	-	GCF Priority g1 - Update test case 13.1.12	11.1.1	11.2.0
2013-03	RAN#59	R5-130746	2206	-	GCF Priority i1 - Correction to LTE FDD-TDD Inter-mode test case 8.3.1.15a	11.1.1	11.2.0
2013-03	RAN#59	R5-130747	2207	-	GCF Priority i1 - Correction to LTE FDD-TDD Inter-mode test case 8.3.1.16a	11.1.1	11.2.0
2013-03	RAN#59	R5-130748	2208	-	GCF Priority 1 - Correction to EUTRA RRC test case 8.5.4.1	11.1.1	11.2.0
2013-03	RAN#59	R5-130752	2209	-	Modification of CA TC 8.2.4.19	11.1.1	11.2.0
2013-03	RAN#59	R5-130753	2210	-	Modification of CA TC 8.2.4.20	11.1.1	11.2.0
2013-03	RAN#59	R5-130754	2211	-	Modification of CA TC 8.2.4.21	11.1.1	11.2.0
2013-03	RAN#59	R5-130755	2212	-	Modification of CA TCs 8.3.1.17 and 8.3.1.18	11.1.1	11.2.0
2013-03	RAN#59	R5-130756	2213	-	Modification of CA TC 8.3.1.22	11.1.1	11.2.0
2013-03	RAN#59	R5-130757	2214	-	Modification of CA TC 8.4.2.7	11.1.1	11.2.0
2013-03	RAN#59	R5-130758	2215	-	Update of Carrier Aggregation test case 8.2.4.20.1	11.1.1	11.2.0
2013-03	RAN#59	R5-130762	2216	-	GCF Priority 3 – Corrections to EMM tcs 9.2.3.2.1a and 9.2.3.3.4	11.1.1	11.2.0
2013-03	RAN#59	R5-130778	2161	-	GCF Priority 3 - Update test case 9.3.1.3	11.1.1	11.2.0
2013-03	RAN#59	R5-130784	2217	-	GCF Priority ee1 - Corrections to Emergency Call over IMS test cases	11.1.1	11.2.0
2013-03	RAN#59	R5-130785	2218	-	GCF Priority c1 - Correction to EUTRA-HRPD test case 8.3.2.8	11.1.1	11.2.0
2013-03	RAN#59	R5-130786	2219	-	GCF Priority c1 - Correction to EUTRA-1xRTT test case 8.3.2.10	11.1.1	11.2.0
2013-03	GERAN3 #57	GP-130307	2112	-	GCF Priority g1 - Correction to EUTRA Idle Mode test case 6.2.3.23	11.1.1	11.2.0
2013-06	RAN#60	GP-130357	2220	-	CR 36.523-1-2220 GCF Priority 1 - Correction to EUTRA Idle Mode Test Case 6.2.3.15	11.2.0	11.3.0

Date	TSG #	TSG Doc.	CR	Rev	Subject/Comment	Version Old	Version New
2013-06	RAN#60	GP-130358	2221	-	CR 36.523-1-2221 GCF priority g1 - Correction to Idle Mode test case 6.2.1.6	11.2.0	11.3.0
2013-06	RAN#60	GP-130371	2222	-	CR 36.523-1-2222 Removal of TC 6.2.3.22	11.2.0	11.3.0
2013-06	RAN#60	R5-131066	2224	-	Update of CDMA2000 specification references: Clause 2 of TS 36.523-1	11.2.0	11.3.0
2013-06	RAN#60	R5-131071	2225	-	Update of CDMA2000 specification references for UE Capability Transfer	11.2.0	11.3.0
2013-06	RAN#60	R5-131072	2226	-	Update of CDMA2000 specification references for Inter-RAT Handover	11.2.0	11.3.0
2013-06	RAN#60	R5-131073	2227	-	Update of CDMA2000 specification references of Inter-system session management	11.2.0	11.3.0
2013-06	RAN#60	R5-131077	2228	-	Update of of LTE MDT test case 8.6.3.3	11.2.0	11.3.0
2013-06	RAN#60	R5-131087	2229	-	Editorial Remove square bracket in TC 8.3.2.1	11.2.0	11.3.0
2013-06	RAN#60	R5-131088	2230	-	Editorial Remove square bracket and FFS in TCs 13.4.2.2, 13.4.3.3, 13.4.3.5	11.2.0	11.3.0
2013-06	RAN#60	R5-131091	2231	-	Editorial TC 12.1.1	11.2.0	11.3.0
2013-06	RAN#60	R5-131128	2232	-	Correction of description on 36523-3	11.2.0	11.3.0
2013-06	RAN#60	R5-131142	2233	-	GCF Priority X - Correction to Idle Mode test case 6.3.11	11.2.0	11.3.0
2013-06	RAN#60	R5-131143	2234	-	GCF Priority X - Correction to Idle Mode test case 6.3.10	11.2.0	11.3.0
2013-06	RAN#60	R5-131169	2235	-	Update to test function Update UE Location Information	11.2.0	11.3.0
2013-06	RAN#60	R5-131215	2236	-	GCF Priority u1 - Update to EMM test case 9.2.3.2.9	11.2.0	11.3.0
2013-06	RAN#60	R5-131255	2237	-	GCF Priority 3 - Correction to EUTRA MAC test case 7.1.4.2	11.2.0	11.3.0
2013-06	RAN#60	R5-131294	2238	-	Update test case 13.1.3	11.2.0	11.3.0
2013-06	RAN#60	R5-131295	2239	-	Update test case 13.1.7	11.2.0	11.3.0
2013-06	RAN#60	R5-131296	2240	-	Update test case 13.1.10	11.2.0	11.3.0
2013-06	RAN#60	R5-131298	2241	-	Update test case 13.1.15	11.2.0	11.3.0
2013-06	RAN#60	R5-131299	2242	-	Update test case 13.1.11	11.2.0	11.3.0
2013-06	RAN#60	R5-131300	2243	-	Update test case 13.1.13	11.2.0	11.3.0
2013-06	RAN#60	R5-131301	2244	-	Update test case 13.1.4	11.2.0	11.3.0
2013-06	RAN#60	R5-131302	2245	-	Update test case 13.1.16	11.2.0	11.3.0
2013-06	RAN#60	R5-131314	2246	-	Correction to RSRQ test case 8.3.2.3a	11.2.0	11.3.0
2013-06	RAN#60	R5-131316	2247	-	Correction to EUTRA-HRPD test case 8.3.3.4	11.2.0	11.3.0
2013-06	RAN#60	R5-131317	2248	-	Correction to EMM test case 9.2.1.2.8	11.2.0	11.3.0
2013-06	RAN#60	R5-131318	2249	-	Correction to EMM test case 9.2.2.1.8	11.2.0	11.3.0
2013-06	RAN#60	R5-131324	2250	-	Correction to CA test cases 8.3.1.18.1 and 8.3.1.18.2	11.2.0	11.3.0
2013-06	RAN#60	R5-131366	2251	-	Update test case 13.4.2.1	11.2.0	11.3.0
2013-06	RAN#60	R5-131367	2252	-	Update test case 13.4.3.1	11.2.0	11.3.0

Date	TSG #	TSG Doc.	CR	Rev	Subject/Comment	Version Old	Version New
2013-06	RAN#60	R5-131368	2253	-	Update test case 13.4.3.2	11.2.0	11.3.0
2013-06	RAN#60	R5-131369	2254	-	Update test case 13.4.3.7	11.2.0	11.3.0
2013-06	RAN#60	R5-131370	2255	-	Update test case 13.4.3.8	11.2.0	11.3.0
2013-06	RAN#60	R5-131371	2256	-	Update test case 13.4.3.9	11.2.0	11.3.0
2013-06	RAN#60	R5-131372	2257	-	Update test case 13.4.3.10	11.2.0	11.3.0
2013-06	RAN#60	R5-131373	2258	-	Update test case 13.4.3.11	11.2.0	11.3.0
2013-06	RAN#60	R5-131375	2259	-	Update test case 13.4.3.12	11.2.0	11.3.0
2013-06	RAN#60	R5-131376	2260	-	Update test case 13.4.3.13	11.2.0	11.3.0
2013-06	RAN#60	R5-131377	2261	-	Update test case 13.4.3.14	11.2.0	11.3.0
2013-06	RAN#60	R5-131378	2262	-	Update test case 13.4.3.16	11.2.0	11.3.0
2013-06	RAN#60	R5-131441	2263	-	Correction to test case 8.3.1.26	11.2.0	11.3.0
2013-06	RAN#60	R5-131470	2264	-	Update IMS emergency call pre-test condition	11.2.0	11.3.0
2013-06	RAN#60	R5-131480	2265	-	Adding a new TC 9.2.3.1.5a for NIMTC conformance testing	11.2.0	11.3.0
2013-06	RAN#60	R5-131485	2266	-	Splitting TC 11.2.8 in two TCs one for UTRA/GERAN and one for 1xRTT	11.2.0	11.3.0
2013-06	RAN#60	R5-131496	2367	-	Correction to generic MO CSFB procedures	11.2.0	11.3.0
2013-06	RAN#60	R5-131504	2267	-	Editorial update of test case 13.1.5	11.2.0	11.3.0
2013-06	RAN#60	R5-131557	2268	-	Update of 8.4.7.10 - Addition of C2K checking parameters	11.2.0	11.3.0
2013-06	RAN#60	R5-131626	2269	-	Addition of new test case for PLMN change in eMDT	11.2.0	11.3.0
2013-06	RAN#60	R5-131633	2270	-	Addition of new test case for EventB2 reporting in eMDT	11.2.0	11.3.0
2013-06	RAN#60	R5-131635	2271	-	Addition of new test case for RACH reporting in eMDT	11.2.0	11.3.0
2013-06	RAN#60	R5-131675	2272	-	Correction to EMM Test Case 9.2.3.1.19	11.2.0	11.3.0
2013-06	RAN#60	R5-131693	2273	-	GCF Priority 2 / 3 - Editorial corrections to EMM test cases 9.2.1.1.1a and 9.2.3.1.17	11.2.0	11.3.0
2013-06	RAN#60	R5-131708	2274	-	GCF Priority 2 - Corrections to SMS over SGs test cases	11.2.0	11.3.0
2013-06	RAN#60	R5-131713	2275	-	Editorial correction to TC 9.2.1.1.1	11.2.0	11.3.0
2013-06	RAN#60	R5-131733	2276	-	Correction to LTE-A test case 8.2.2.5.1/8.2.2.5.2	11.2.0	11.3.0
2013-06	RAN#60	R5-131810	2277	-	CSG reselection requirements correction in TC 6.3.1	11.2.0	11.3.0
2013-06	RAN#60	R5-131811	2278	-	CSG reselection requirements correction in TC 6.3.3	11.2.0	11.3.0
2013-06	RAN#60	R5-131812	2279	-	CSG reselection requirements correction in TC 6.3.4	11.2.0	11.3.0
2013-06	RAN#60	R5-131813	2280	-	CSG reselection requirements correction in TC 6.3.7	11.2.0	11.3.0
2013-06	RAN#60	R5-131814	2281	-	CSG reselection requirements correction in TC 6.3.8	11.2.0	11.3.0

Date	TSG #	TSG Doc.	CR	Rev	Subject/Comment	Version Old	Version New
2013-06	RAN#60	R5-131815	2282	-	Correction to EUTRA Idle mode Test case 6.1.2.13	11.2.0	11.3.0
2013-06	RAN#60	R5-131816	2283	-	Correction to EUTRA Idle mode test case 6.2.3.1a	11.2.0	11.3.0
2013-06	RAN#60	R5-131817	2284	-	Correction to MAC test case 7.1.1.2	11.2.0	11.3.0
2013-06	RAN#60	R5-131818	2285	-	Update of test case 8.5.4.1	11.2.0	11.3.0
2013-06	RAN#60	R5-131819	2286	-	Correction to EUTRA-1xRTT test case 8.3.2.10	11.2.0	11.3.0
2013-06	RAN#60	R5-131820	2287	-	Correction to EUTRA-HRPD test case 8.3.2.8	11.2.0	11.3.0
2013-06	RAN#60	R5-131821	2288	-	New TC 8.3.4.5 Inter-frequency E-UTRAN FDD - FDD / CSG Proximity Indication	11.2.0	11.3.0
2013-06	RAN#60	R5-131822	2289	-	Addition of new test case 8.3.1.23	11.2.0	11.3.0
2013-06	RAN#60	R5-131823	2290	-	Addition of new test case 8.3.1.27	11.2.0	11.3.0
2013-06	RAN#60	R5-131824	2291	-	GCF Priority 1 - Correction to EUTRA RRC Test Case 8.3.2.2.	11.2.0	11.3.0
2013-06	RAN#60	R5-131825	2292	-	GCF Priority x - Correction to EUTRA test case 8.3.1.13	11.2.0	11.3.0
2013-06	RAN#60	R5-131826	2293	-	Editorial Remove square bracket in TC 8.4.3.2	11.2.0	11.3.0
2013-06	RAN#60	R5-131827	2294	-	Update to test case 9.2.1.2.3 and 9.2.3.2.3	11.2.0	11.3.0
2013-06	RAN#60	R5-131828	2295	-	GCF Priority 3 - Corrections to EMM TC 9.2.1.1.12, 9.2.3.1.12, 9.2.3.1.18	11.2.0	11.3.0
2013-06	RAN#60	R5-131829	2296	-	Correction to EMM test case 9.2.3.2.1a	11.2.0	11.3.0
2013-06	RAN#60	R5-131830	2297	-	Correction to EMM test case 9.2.3.3.2	11.2.0	11.3.0
2013-06	RAN#60	R5-131831	2298	-	GCF Priority 2 - Correction to EUTRA EMM Test Case 9.2.3.2.3	11.2.0	11.3.0
2013-06	RAN#60	R5-131832	2299	-	GCF Priority 2: Extending the scope of TC 9.1.4.2 to verify IMEISV	11.2.0	11.3.0
2013-06	RAN#60	R5-131833	2300	-	GCF G2: Corrections to EMM test case 9.2.3.4.1	11.2.0	11.3.0
2013-06	RAN#60	R5-131834	2301	-	GCF Priority U1: Correction to EMM test case 9.2.3.3.4	11.2.0	11.3.0
2013-06	RAN#60	R5-131835	2302	-	9.2.3.1.8 'Load Balancing TAU' does not test the main requirement	11.2.0	11.3.0
2013-06	RAN#60	R5-131836	2303	-	Correction to EMM test case 9.1.3.3	11.2.0	11.3.0
2013-06	RAN#60	R5-131837	2304	-	Update to test case 11.2.6	11.2.0	11.3.0
2013-06	RAN#60	R5-131838	2305	-	Update test case 11.2.11	11.2.0	11.3.0
2013-06	RAN#60	R5-131839	2306	-	Update of test case 8.3.3.5	11.2.0	11.3.0
2013-06	RAN#60	R5-131840	2307	-	Correction to EUTRA Multi-layer Test Case 13.3.1.3	11.2.0	11.3.0
2013-06	RAN#60	R5-131841	2308	-	Corrections to eMBMS test case 17.1.1	11.2.0	11.3.0
2013-06	RAN#60	R5-131842	2309	-	Corrections to eMBMS test case 17.1.2	11.2.0	11.3.0
2013-06	RAN#60	R5-131843	2310	-	Corrections to eMBMS test case 17.1.3	11.2.0	11.3.0
2013-06	RAN#60	R5-131844	2311	-	Corrections to eMBMS test case 17.1.4	11.2.0	11.3.0
2013-06	RAN#60	R5-131845	2312	-	Corrections to eMBMS test case 17.1.5	11.2.0	11.3.0

Date	TSG #	TSG Doc.	CR	Rev	Subject/Comment	Version Old	Version New
2013-06	RAN#60	R5-131846	2313	-	Corrections to eMBMS test case 17.2.1	11.2.0	11.3.0
2013-06	RAN#60	R5-131847	2314	-	Corrections to eMBMS test case 17.2.2	11.2.0	11.3.0
2013-06	RAN#60	R5-131848	2315	-	Corrections to eMBMS test case 17.2.3	11.2.0	11.3.0
2013-06	RAN#60	R5-131849	2316	-	Corrections to eMBMS test case 17.2.4	11.2.0	11.3.0
2013-06	RAN#60	R5-131850	2317	-	Correction to PWS(CMAS) test case 18.1.3	11.2.0	11.3.0
2013-06	RAN#60	R5-131851	2318	-	Corrections to eMBMS test case 17.3.1	11.2.0	11.3.0
2013-06	RAN#60	R5-131852	2319	-	Corrections to eMBMS test case 17.3.2	11.2.0	11.3.0
2013-06	RAN#60	R5-131853	2320	-	Correction to E-UTRA MDT test case 8.6.2.1	11.2.0	11.3.0
2013-06	RAN#60	R5-131854	2321	-	Correction to E-UTRA MDT test case 8.6.2.2	11.2.0	11.3.0
2013-06	RAN#60	R5-131855	2322	-	Correction to E-UTRA MDT test case 8.6.2.3	11.2.0	11.3.0
2013-06	RAN#60	R5-131856	2323	-	Correction to E-UTRA MDT test case 8.6.2.4	11.2.0	11.3.0
2013-06	RAN#60	R5-131857	2324	-	Correction to E-UTRA MDT test case 8.6.2.5	11.2.0	11.3.0
2013-06	RAN#60	R5-131858	2325	-	Correction to E-UTRA MDT test case 8.6.2.8	11.2.0	11.3.0
2013-06	RAN#60	R5-131859	2326	-	Correction to E-UTRA MDT test case 8.6.3.1	11.2.0	11.3.0
2013-06	RAN#60	R5-131860	2327	-	Correction to E-UTRA MDT test case 8.6.3.2	11.2.0	11.3.0
2013-06	RAN#60	R5-131861	2328	-	Correction to E-UTRA MDT test case 8.6.3.3	11.2.0	11.3.0
2013-06	RAN#60	R5-131879	2330	-	Correction to MAC LTE CA test case 7.1.3.11	11.2.0	11.3.0
2013-06	RAN#60	R5-131880	2331	-	Correction to MAC LTE CA test case 7.1.4.18	11.2.0	11.3.0
2013-06	RAN#60	R5-131881	2332	-	Correction to MAC LTE CA test case 7.1.9.1	11.2.0	11.3.0
2013-06	RAN#60	R5-131882	2333	-	Correction to MAC LTE CA test case 7.1.4.20.1	11.2.0	11.3.0
2013-06	RAN#60	R5-131883	2334	-	Correction to MAC LTE CA test case 7.1.4.19.1	11.2.0	11.3.0
2013-06	RAN#60	R5-131886	2335	-	Update of eICIC test case 8.3.1.20	11.2.0	11.3.0
2013-06	RAN#60	R5-131892	2336	-	Adding a new TC 9.2.1.1.2a for NIMTC conformance testing	11.2.0	11.3.0
2013-06	RAN#60	R5-131894	2337	-	Addition of new test case for TDD additional special subframe configuration with CRS based transmission scheme	11.2.0	11.3.0
2013-06	RAN#60	R5-131895	2338	-	Addition of new test case for TDD additional special subframe configuration with UE-specific reference signals based transmission scheme	11.2.0	11.3.0
2013-06	RAN#60	R5-131898	2339	-	Correction to EUTRA EMM Test Case 9.2.3.2.1b	11.2.0	11.3.0
2013-06	RAN#60	R5-131899	2340	-	Correction to EUTRA EMM Test Case 9.2.1.2.1b	11.2.0	11.3.0
2013-06	RAN#60	R5-132003	2341	-	Update to test case 8.2.4.17.2	11.2.0	11.3.0
2013-06	RAN#60	R5-132005	2342	-	Correction to RRC test case 8.2.4.14	11.2.0	11.3.0
2013-06	RAN#60	R5-132018	2343	-	New Carrier Aggregation test case on MIMO	11.2.0	11.3.0
2013-06	RAN#60	R5-132019	2344	-	Correction to usage of cells in Inter-band LTE CA test case 8.2.4.19.2	11.2.0	11.3.0
2013-06	RAN#60	R5-132020	2345	-	Correction to usage of cells in Inter-band LTE CA test case 8.2.4.20.2	11.2.0	11.3.0

Date	TSG #	TSG Doc.	CR	Rev	Subject/Comment	Version Old	Version New
2013-06	RAN#60	R5-132021	2346	-	Correction to usage of cells in Inter-band LTE CA test case 8.2.4.21.2	11.2.0	11.3.0
2013-06	RAN#60	R5-132022	2347	-	Addition of SCell configuration type to CA test cases	11.2.0	11.3.0
2013-06	RAN#60	R5-132024	2348	-	Correction to eICIC test case 8.3.1.19	11.2.0	11.3.0
2013-06	RAN#60	R5-132032	2349	-	Correction to idle mode test case 6.1.2.17	11.2.0	11.3.0
2013-06	RAN#60	R5-132033	2350	-	Correction to LTE FDD-TDD Inter-mode test case 8.1.3.12a	11.2.0	11.3.0
2013-06	RAN#60	R5-132034	2351	-	GCF Priority 1 - Update of EUTRA RRC test case 8.5.4.1 to handle Rel-11 IEs	11.2.0	11.3.0
2013-06	RAN#60	R5-132035	2352	-	Correction to EMM test case 9.2.3.3.4	11.2.0	11.3.0
2013-06	RAN#60	R5-132042	2353	-	GCF Priority 2 - Corrections to ESM test case 10.3.1	11.2.0	11.3.0
2013-06	RAN#60	R5-132043	2354	-	GCF Priority 2 - Corrections to ESM test case 10.9.1	11.2.0	11.3.0
2013-06	RAN#60	R5-132044	2355	-	Addition of new test case for T300 expiry in eMDT	11.2.0	11.3.0
2013-06	RAN#60	R5-132045	2356	-	Addition of new test case about TAC and PLMN id in eMDT	11.2.0	11.3.0
2013-06	RAN#60	R5-132046	2357	-	Addition of new test case about PLMN list in eMDT	11.2.0	11.3.0
2013-06	RAN#60	R5-132047	2358	-	Addition of new test case about Location information for eMDT	11.2.0	11.3.0
2013-06	RAN#60	R5-132048	2359	-	Addition of new test case for inter-frequency measurements report in eMDT	11.2.0	11.3.0
2013-06	RAN#60	R5-132049	2360	-	Addition of new test case for inter-RAT measurements report in eMDT	11.2.0	11.3.0
2013-06	RAN#60	R5-132054	2361	-	Addition of new test case for reporting reestablishment in eMDT	11.2.0	11.3.0
2013-06	RAN#60	R5-132056	2362	-	Addition of new test case for EventA2 reporting in eMDT	11.2.0	11.3.0
2013-06	RAN#60	R5-132058	2363	-	GCF Priority X - Correction to Idle Mode test case 6.3.12	11.2.0	11.3.0
2013-06	RAN#60	R5-132067	2364	-	GCF Priority ee1 - Update of Emergency Call over IMS test cases	11.2.0	11.3.0
2013-06	RAN#60	R5-132069	2365	-	GCF Priority i1 - Correction to LTE FDD-TDD Inter-mode test case 6.1.1.4a	11.2.0	11.3.0
2013-06	RAN#60	R5-132084	2366	-	Update of TC 11.2.7 to consider document C1-131732	11.2.0	11.3.0
2013-09	RAN#61	R5-133081	2368	-	Correction to CA test case 8.2.4.21.2	11.3.0	11.4.0
2013-09	RAN#61	R5-133082	2369	-	GCF Priority 3 - Correction to EMM test case 9.2.1.1.11	11.3.0	11.4.0
2013-09	RAN#61	R5-133093	2370	-	Correction to EMM test case 9.2.3.4.1	11.3.0	11.4.0
2013-09	RAN#61	R5-133114	2371	-	Clarification for handling of differences between conformance requirements in different releases of core specifications	11.3.0	11.4.0
2013-09	RAN#61	R5-133128	2372	-	Correction to CA Test Case 8.2.2.5.1 and 8.2.2.5.2	11.3.0	11.4.0

Date	TSG #	TSG Doc.	CR	Rev	Subject/Comment	Version Old	Version New
2013-09	RAN#61	R5-133145	2373	-	Correction to EMM test case 9.2.1.1.1b	11.3.0	11.4.0
2013-09	RAN#61	R5-133167	2374	-	Editorial update of TC 9.2.3.3.2	11.3.0	11.4.0
2013-09	RAN#61	R5-133184	2375	-	Update of text for Update UE Location Information	11.3.0	11.4.0
2013-09	RAN#61	R5-133322	2376	-	Addition of new eMDT test case 8.6.7.4	11.3.0	11.4.0
2013-09	RAN#61	R5-133323	2377	-	Addition of new eMDT test case 8.6.4.8	11.3.0	11.4.0
2013-09	RAN#61	R5-133324	2378	-	Addition of new eMDT test case 8.6.4.9	11.3.0	11.4.0
2013-09	RAN#61	R5-133325	2379	-	Addition of new eMDT test case 8.6.4.10	11.3.0	11.4.0
2013-09	RAN#61	R5-133326	2380	-	Addition of new eMDT test case 8.6.8.2	11.3.0	11.4.0
2013-09	RAN#61	R5-133327	2381	-	Addition of new eMDT test case 8.6.8.5	11.3.0	11.4.0
2013-09	RAN#61	R5-133328	2382	-	Addition of new eMDT test case 8.6.9.1	11.3.0	11.4.0
2013-09	RAN#61	R5-133342	2383	-	Correction to test case 8.4.3.2	11.3.0	11.4.0
2013-09	RAN#61	R5-133362	2384	-	Correction of ESM test cases 10.3.1 and 10.9.1	11.3.0	11.4.0
2013-09	RAN#61	R5-133483	2385	-	GCF Priority 4: Modification to TC 6.1.2.12	11.3.0	11.4.0
2013-09	RAN#61	R5-133486	2386	-	Modification to TC 8.3.1.13a	11.3.0	11.4.0
2013-09	RAN#61	R5-133510	2387	-	Update to test case 9.2.1.1.18	11.3.0	11.4.0
2013-09	RAN#61	R5-133585	2388	-	GCF Priority 3 - Correction to 6.1.2.9a test cases	11.3.0	11.4.0
2013-09	RAN#61	R5-133586	2389	-	Define new TC 6.1.2.19 for Intra-frequency cell reselection with MFBI support	11.3.0	11.4.0
2013-09	RAN#61	R5-133587	2390	-	Define new TC 6.1.2.21 for Inter-band cell reselection with MFBI support	11.3.0	11.4.0
2013-09	RAN#61	R5-133589	2391	-	GCF priority 4 - Correction to EUTRA RRC test cases 8.2.1.5 and 8.2.1.6	11.3.0	11.4.0
2013-09	RAN#61	R5-133590	2392	-	Correction to FDD-TDD test case 8.3.1.15a	11.3.0	11.4.0
2013-09	RAN#61	R5-133591	2393	-	GCF Priority 4 - Corrections to EUTRA-GERAN Test Case 8.4.3.3	11.3.0	11.4.0
2013-09	RAN#61	R5-133592	2394	-	GCF Priority 3 - Correction to test case 9.2.3.1.18a	11.3.0	11.4.0
2013-09	RAN#61	R5-133593	2395	-	GCF Priority 2 - Correction to test case 9.2.3.3.6	11.3.0	11.4.0
2013-09	RAN#61	R5-133594	2396	-	Correction to EMM TC 9.2.2.1.3	11.3.0	11.4.0
2013-09	RAN#61	R5-133595	2397	-	GCF Priority 2 - Correction to test case 9.2.1.2.4 and 9.2.3.2.4	11.3.0	11.4.0
2013-09	RAN#61	R5-133596	2398	-	Correction to EUTRA test case 9.2.1.2.1b	11.3.0	11.4.0
2013-09	RAN#61	R5-133597	2399	-	Correction to EMM Test Case 9.2.3.1.6	11.3.0	11.4.0
2013-09	RAN#61	R5-133598	2400	-	Clarification of EMM Test case 9.2.2.2.2	11.3.0	11.4.0
2013-09	RAN#61	R5-133599	2401	-	Add test case Attach / Success / IMS	11.3.0	11.4.0
2013-09	RAN#61	R5-133600	2402	-	GCF Priority U1 – Correction to EMM test case 9.2.1.2.13	11.3.0	11.4.0
2013-09	RAN#61	R5-133602	2403	-	Add test case EPS bearer context deactivation / Re-establishment	11.3.0	11.4.0

Date	TSG #	TSG Doc.	CR	Rev	Subject/Comment	Version Old	Version New
2013-09	RAN#61	R5-133603	2404	-	Corrections to allow both ISIM or USIM to be used in test cases using IMS	11.3.0	11.4.0
2013-09	RAN#61	R5-133604	2405	-	Correction to SRVCC test case 13.4.3.1	11.3.0	11.4.0
2013-09	RAN#61	R5-133605	2406	-	Correction to eMBMS test case 17.3.1	11.3.0	11.4.0
2013-09	RAN#61	R5-133606	2407	-	Correction to eMBMS test case 17.3.2	11.3.0	11.4.0
2013-09	RAN#61	R5-133610	2408	-	GCF Priority 4: Modification to TC 6.1.2.14	11.3.0	11.4.0
2013-09	RAN#61	R5-133611	2409	-	Modification to TC 8.3.1.13	11.3.0	11.4.0
2013-09	RAN#61	R5-133613	2410	-	Update of test case 8.3.3.2	11.3.0	11.4.0
2013-09	RAN#61	R5-133617	2412	-	Correction to CA Test Case 8.3.1.22.1 and 8.3.1.22.2	11.3.0	11.4.0
2013-09	RAN#61	R5-133618	2413	-	Correction to CA Test Case 8.3.1.17.2	11.3.0	11.4.0
2013-09	RAN#61	R5-133619	2414	-	Correction to CA Test Case 8.2.2.3.2	11.3.0	11.4.0
2013-09	RAN#61	R5-133620	2415	-	Correction to CA Test Case 8.2.4.21.1 and 8.2.4.21.2	11.3.0	11.4.0
2013-09	RAN#61	R5-133621	2416	-	Update of CA Test Case 8.2.2.3.1	11.3.0	11.4.0
2013-09	RAN#61	R5-133622	2417	-	Correction to CA test case 8.5.1.7	11.3.0	11.4.0
2013-09	RAN#61	R5-133623	2418	-	Correction to EUTRA CA RRC test cases 8.2.4.17.1 and 8.2.4.17.2	11.3.0	11.4.0
2013-09	RAN#61	R5-133624	2419	-	Correction to EUTRA CA RRC test cases 8.2.4.19.1 and 8.2.4.19.2	11.3.0	11.4.0
2013-09	RAN#61	R5-133646	2420	-	Update of Test Case 8.3.1.20	11.3.0	11.4.0
2013-09	RAN#61	R5-133648	2422	-	Correction of eICIC TC 8.3.1.19 & 8.3.1.20	11.3.0	11.4.0
2013-09	RAN#61	R5-133660	2423	-	Addition of new eMDT test case 8.6.9.3	11.3.0	11.4.0
2013-09	RAN#61	R5-133663	2424	-	New eMBMS service continuity test case 17.4.1	11.3.0	11.4.0
2013-09	RAN#61	R5-133664	2425	-	New eMBMS service continuity test case 17.4.2	11.3.0	11.4.0
2013-09	RAN#61	R5-133665	2426	-	New TC 17.4.7 MBMS Interest Indication after Radio Link Failure	11.3.0	11.4.0
2013-09	RAN#61	R5-133666	2427	-	Introduction of New eMBMS Service Continuity Improvements test case 17.4.4	11.3.0	11.4.0
2013-09	RAN#61	R5-133667	2428	-	Addition of new TC 8.6.2.11 Logged MDT / Logging and reporting / Reporting at intra LTE handover / PLMN list	11.3.0	11.4.0
2013-09	RAN#61	R5-133668	2429	-	Addition of new TC 8.6.2.12 Logged MDT / Logging and reporting / Reporting at RRC connection re-establishment / PLMN list	11.3.0	11.4.0
2013-09	RAN#61	R5-133669	2430	-	Addition of new TC 8.6.3.4 Logged MDT / Logging and reporting / Reporting at UTRAN Inter-RAT handover / PLMN list	11.3.0	11.4.0
2013-09	RAN#61	R5-133670	2431	-	Addition of new TC 8.6.6.5 Handover Failure logging / Logging and reporting / Reporting at RRC connection establishment / PLMN list	11.3.0	11.4.0
2013-09	RAN#61	R5-133671	2432	-	Addition of new TC 8.6.6.6 Handover Failure logging / Logging and reporting / Reporting at intra LTE handover / PLMN list	11.3.0	11.4.0
2013-09	RAN#61	R5-133672	2433	-	Addition of new TC 8.6.6.7 Handover Failure logging / Logging and reporting / Reporting at	11.3.0	11.4.0

Date	TSG #	TSG Doc.	CR	Rev	Subject/Comment	Version Old	Version New
					RRC connection re-establishment / PLMN list		
2013-09	RAN#61	R5-133673	2434	-	Addition of new TC 8.6.9.4 Connection Establishment Failure logging / Logging and reporting / Reporting of CDMA2000 Inter-RAT measurements	11.3.0	11.4.0
2013-09	RAN#61	R5-133675	2435	-	Introduction of New LTE RAN Enhancements for Diverse Data Applications test case 8.2.2.6.2	11.3.0	11.4.0
2013-09	RAN#61	R5-133676	2436	-	New test case 8.2.2.6.1 RRC connection reconfiguration/ UE Assistance Information/power preference indication setup and release	11.3.0	11.4.0
2013-09	RAN#61	R5-133677	2437	-	New test case 8.2.2.6.3 RRC connection reconfiguration/ UE Assistance Information/T340 running	11.3.0	11.4.0
2013-09	RAN#61	R5-133679	2438	-	Addition of new TC 7.1.3.X Correct handling of DL assignment / Dynamic case / EPDCCH	11.3.0	11.4.0
2013-09	RAN#61	R5-133680	2439	-	Addition of new TC 7.1.3.Y Correct handling of DL assignment / Semi-persistent case / EPDCCH	11.3.0	11.4.0
2013-09	RAN#61	R5-133692	2441	-	Define new TC 6.1.2.20 for Inter-frequency cell reselection with MFBI support.	11.3.0	11.4.0
2013-09	RAN#61	R5-133695	2443	-	Addition of new MFBI test case: 8.2.4.22 RRC connection reconfiguration / Handover / MFBI / target cell broadcasting information disregarded by the UE	11.3.0	11.4.0
2013-09	RAN#61	R5-133696	2444	-	Update of Emergency Call over IMS test case 11.2.7	11.3.0	11.4.0
2013-09	RAN#61	R5-133699	2445	-	New eMBMS service continuity test case 17.4.6	11.3.0	11.4.0
2013-09	RAN#61	R5-133700	2446	-	New eMBMS service continuity test case 17.4.8	11.3.0	11.4.0
2013-09	RAN#61	R5-133707	2447	-	Addition of new Rel-10 eICIC test case 8.3.1.21	11.3.0	11.4.0
2013-09	RAN#61	R5-133723	2440	-	Update of TC 6.2.1.1 Inter-RAT PLMN Selection for OPLMN Automatic mode	11.3.0	11.4.0
2013-09	RAN#61	R5-133725	2448	-	Correction of EUTRA RRC test case 8.5.4.1	11.3.0	11.4.0
2013-09	RAN#61	R5-133730	2421	-	Addition of new eICIC Test Case 8.3.1.27	11.3.0	11.4.0
2013-09	RAN#61	R5-133732	2442	-	Update of Test Case 8.2.4.13a	11.3.0	11.4.0
2013-09	RAN#61	R5-133733	2411	-	Correction to CA Test Case 8.3.1.18.1 and 8.3.1.18.2	11.3.0	11.4.0

History

Document history		
V11.0.0	October 2012	Publication
V11.1.1	February 2013	Publication
V11.2.0	May 2013	Publication
V11.3.0	August 2013	Publication
V11.4.0	October 2013	Publication